

Automation PC 820

User's manual

Version: **1.35 (April 2015)**
Model no.: **MAAPC820-ENG**

All information contained in this manual is current as of its creation/publication. B&R reserves the right to change the contents of this manual without notice. The information contained herein is believed to be accurate as of the date of publication; however, Bernecker + Rainer Industrie-Elektronik Ges.m.b.H. makes no warranty, expressed or implied, with regard to the products or documentation contained within this manual. In addition, Bernecker + Rainer Industrie-Elektronik Ges.m.b.H. shall not be liable for any incidental or consequential damages in connection with or arising from the furnishing, performance or use of the product(s) in this documentation. Software names, hardware names and trademarks are registered by their respective companies.

Chapter 1: General information

Chapter 2: Technical data

Chapter 3: Installation

Chapter 4: Software

Chapter 5: Standards and certifications

Chapter 6: Accessories

Chapter 7: Maintenance and service

Appendix A

Chapter 1 General information.....	9
1 Manual history.....	9
2 Safety guidelines.....	11
2.1 Intended use.....	11
2.2 Protection against electrostatic discharge.....	11
2.2.1 Packaging.....	11
2.2.2 Guidelines for proper ESD handling.....	11
2.3 Policies and procedures.....	11
2.4 Transport and storage.....	12
2.5 Installation.....	12
2.6 Operation.....	12
2.6.1 Protection against touching electrical parts.....	12
2.6.2 Environmental conditions - Dust, moisture, corrosive gases.....	12
2.6.3 Viruses and dangerous programs.....	12
2.7 Environmentally friendly disposal.....	13
2.7.1 Separation of materials.....	13
3 Organization of safety notices.....	14
4 Guidelines.....	14
5 Overview.....	15
Chapter 2 Technical data.....	18
1 Introduction.....	18
1.1 Features.....	18
1.2 System components.....	19
1.2.1 Configuration - Base system.....	19
1.2.2 Configuration - Optional components.....	20
2 Complete system.....	21
2.1 Temperature specifications.....	21
2.1.1 Maximum ambient temperature with a fan kit.....	21
2.1.2 Temperature monitoring.....	22
2.1.3 Temperature sensor locations.....	22
2.2 Humidity specifications.....	23
2.3 Power management.....	24
2.3.1 Voltage supply block diagramVoltage supply.....	24
2.3.2 Power calculation.....	24
2.4 Block diagram.....	26
2.5 Device interfaces and slots.....	27
2.5.1 +24 VDC power supply.....	27
2.5.2 Grounding.....	27
2.5.3 Monitor / Panel connection.....	27
2.5.4 USB interfaces.....	29
2.5.5 CompactFlash slot 1.....	30
2.5.6 CompactFlash slot 2.....	30
2.5.7 COM1 serial interface.....	31
2.5.8 COM2 serial interface.....	32
2.5.9 CAN.....	35
2.5.10 POWERLINK.....	36
2.5.11 Ethernet 1 (ETH1).....	39
2.5.12 Ethernet 2 (ETH2).....	39
2.5.13 Battery.....	40
2.5.14 Hardware security key (dongle).....	41
2.5.15 LED status indicators.....	42
2.5.16 CMOS Profile switch.....	42
2.5.17 Power button.....	43
2.5.18 Reset button.....	43
3 Individual components.....	44
3.1 System units.....	44

3.1.1 Interfaces.....	44
3.1.2 5PC820.SX01-00.....	49
3.1.3 5PC820.SX01-01.....	53
3.2 CPU boards 945GME.....	57
3.2.1 General information.....	57
3.2.2 Order data.....	57
3.2.3 Technical data - 5PC800.B945-0x.....	58
3.2.4 Technical data - 5PC800.B945-1x.....	58
3.3 Main memory.....	60
3.3.1 General information.....	60
3.3.2 Order data.....	60
3.3.3 Technical data.....	60
3.4 Heat sink with power supply.....	61
3.4.1 General information.....	61
3.4.2 Order data.....	61
3.4.3 Technical data.....	61
3.5 Replacement fan 8BXF001.0000-00.....	62
3.5.1 Order data.....	62
3.5.2 Technical data.....	62
3.6 PCIec plug-in cards.....	63
3.6.1 General information.....	63
3.6.2 Dimensions.....	63
3.6.3 5ACPCC.ETH0-00.....	64
3.6.4 5ACPCC.MPL0-00.....	66
Chapter 3 Installation.....	70
1 Installation.....	70
1.1 Important installation information.....	70
1.2 Mounting plates.....	71
1.2.1 Feed-through mounting.....	71
1.2.2 Cold-plate mounting.....	71
1.2.3 Wall mounting.....	71
1.3 Mounting orientation.....	72
1.4 Spacing for air circulation.....	73
1.5 Swivel range of the front cover.....	74
1.6 Installation guidelines.....	75
2 Cable connections.....	76
3 Connection examples.....	77
3.1 Selecting display units.....	77
3.2 One Automation Panel 900 via DVI.....	78
3.2.1 Basic system requirements.....	78
3.2.2 Link modules.....	78
3.2.3 Cables.....	78
3.2.4 Possible Automation Panel devices, resolutions and segment lengths.....	79
3.2.5 BIOS settings.....	79
3.3 One Automation Panel 900 via SDL.....	80
3.3.1 Basic system requirements.....	80
3.3.2 Link modules.....	80
3.3.3 Cables.....	80
3.3.4 Settings in BIOS.....	81
3.4 One Automation Panel 800 via SDL.....	82
3.4.1 Basic system requirements.....	82
3.4.2 Cables.....	82
3.4.3 Settings in BIOS.....	83
3.5 One AP900 and one AP800 via SDL.....	84
3.5.1 Basic system requirements.....	84
3.5.2 Link modules.....	84

3.5.3 Cables.....	84
3.5.4 Settings in BIOS.....	84
3.6 Four Automation Panel 900 units via SDL.....	86
3.6.1 Basic system requirements.....	86
3.6.2 Link modules.....	86
3.6.3 Cables.....	86
3.6.4 Settings in BIOS.....	87
4 Connecting peripheral USB devices.....	88
4.1 Locally on the APC820.....	88
4.2 Remote connection to Automation Panel 900 via DVI.....	89
4.3 Remote connection to Automation Panel 800 / 900 via SDL.....	89
5 Known problems / issues.....	90
Chapter 4 Software.....	91
1 BIOS options.....	91
1.1 General information.....	91
1.2 BIOS setup and boot procedure.....	91
1.3 BIOS Setup keys.....	93
1.4 Main.....	94
1.5 Advanced.....	95
1.5.1 ACPI Configuration.....	96
1.5.2 PCI Configuration.....	97
1.5.3 PCI Express Configuration.....	100
1.5.4 Graphics Configuration.....	102
1.5.5 CPU Configuration.....	104
1.5.6 Chipset Configuration.....	105
1.5.7 I/O Interface Configuration.....	106
1.5.8 Clock Configuration.....	107
1.5.9 IDE Configuration.....	107
1.5.10 USB Configuration.....	112
1.5.11 Keyboard/Mouse Configuration.....	114
1.5.12 Remote access configuration.....	114
1.5.13 CPU Board Monitor.....	116
1.5.14 Baseboard/Panel Features.....	117
1.6 Boot.....	121
1.7 Security.....	122
1.7.1 Hard Disk Security User Password.....	123
1.7.2 Hard Disk Security Master Password.....	124
1.8 Power.....	124
1.9 Exit.....	126
1.10 BIOS default settings.....	127
1.10.1 Main.....	127
1.10.2 Advanced.....	127
1.10.3 Boot.....	131
1.10.4 Security.....	131
1.10.5 Power.....	131
1.11 BIOS error signals (beep codes).....	133
1.12 Allocation of resources.....	134
1.12.1 RAM address assignment.....	134
1.12.2 I/O address assignments.....	134
1.12.3 Interrupt assignments in PIC mode.....	134
1.12.4 Interrupt assignments in APIC mode.....	135
1.12.5 Interrupt routing for BIOS up to V1.12.....	136
1.12.6 Interrupt routing for BIOS starting with V1.14.....	136
2 Upgrade information.....	137
2.1 BIOS upgrade.....	137
2.1.1 Important information.....	137

2.1.2 Procedure with MS-DOS.....	138
2.1.3 Using the Control Center.....	139
2.2 Firmware upgrade.....	140
2.2.1 Procedure.....	140
2.2.2 Possible upgrade problems and software dependencies (for V1.04).....	141
2.3 Creating an MS-DOS boot diskette in Windows XP.....	142
2.4 Creating a bootable USB flash drive for B&R upgrade files.....	144
2.4.1 Requirements.....	144
2.4.2 Procedure.....	144
2.4.3 How to access MS-DOS.....	144
2.5 Creating a bootable CompactFlash card for B&R upgrade files.....	145
2.5.1 Requirements.....	145
2.5.2 Procedure.....	145
2.5.3 How to access MS-DOS.....	145
3 Microsoft DOS.....	146
3.1 Order data.....	146
3.2 Known problems.....	146
3.3 Resolutions and color depths.....	146
4 Windows XP Professional.....	147
4.1 General information.....	147
4.2 Order data.....	147
4.3 Overview.....	148
4.4 Installation.....	148
4.5 Drivers.....	148
4.6 Supported display resolutions.....	148
5 Windows XP Embedded.....	149
5.1 General information.....	149
5.2 Order data.....	149
5.3 Overview.....	149
5.4 Features with FP2007 (Feature Pack 2007).....	149
5.5 Installation.....	150
5.6 Drivers.....	150
5.6.1 Touch screen driver.....	150
6 Windows Embedded Standard 2009.....	151
6.1 General information.....	151
6.2 Order data.....	151
6.3 Overview.....	151
6.4 Features with WES2009 (Windows Embedded Standard 2009).....	151
6.5 Installation.....	152
6.6 Drivers.....	152
6.6.1 Touch screen driver.....	152
6.7 Supported display resolutions.....	152
7 Windows Embedded Standard 7.....	153
7.1 General information.....	153
7.2 Order data.....	153
7.3 Overview.....	154
7.4 Features with WES7 (Windows Embedded Standard 7).....	154
7.5 Installation.....	154
7.6 Drivers.....	155
7.6.1 Touch screen driver.....	155
7.7 Supported display resolutions.....	155
8 Automation Runtime.....	156
8.1 General information.....	156
8.2 Order data.....	156
8.3 Automation Runtime Windows (ARwin).....	156
8.4 Automation Runtime Embedded (ARemb).....	156
8.5 Technology Guarding.....	157

9 B&R Automation Device Interface (ADI) - Control Center.....	158
9.1 Functions.....	158
9.2 Installation.....	159
10 B&R Automation Device Interface (ADI) Development Kit.....	160
11 B&R Automation Device Interface (ADI) .NET SDK.....	162
12 B&R Key Editor.....	164
Chapter 5 Standards and certifications.....	166
1 Standards and guidelines.....	166
1.1 CE mark.....	166
1.2 EMC directive.....	166
1.3 Low voltage directive.....	166
2 Certifications.....	167
2.1 UL certification.....	167
2.2 GOST-R.....	167
Chapter 6 Accessories.....	168
1 Male CAN connector (4-pin).....	168
1.1 General information.....	168
1.2 Order data.....	168
1.3 Technical data.....	168
2 Replacement CMOS batteries.....	169
2.1 0AC201.91 / 4A0006.00-000.....	169
2.1.1 General information.....	169
2.1.2 Order data.....	169
2.1.3 Technical data.....	169
3 DVI/Monitor adapter.....	170
3.1 5AC900.1000-00.....	170
3.2 General information.....	170
3.3 Order data.....	170
4 CompactFlash cards.....	171
4.1 General information.....	171
4.2 General information.....	171
4.2.1 Flash technology.....	171
4.2.2 Wear leveling.....	171
4.2.3 ECC error correction.....	171
4.2.4 S.M.A.R.T. support.....	171
4.2.5 Maximum reliability.....	172
4.3 5CFCRD.xxxx-06.....	173
4.3.1 General information.....	173
4.3.2 Order data.....	173
4.3.3 Technical data.....	174
4.3.4 Temperature/Humidity diagram.....	177
4.3.5 Dimensions.....	177
4.3.6 Benchmark.....	178
4.4 5CFCRD.xxxx-04.....	179
4.4.1 General information.....	179
4.4.2 Order data.....	179
4.4.3 Technical data.....	179
4.4.4 Temperature/Humidity diagram.....	181
4.4.5 Dimensions.....	181
4.4.6 Benchmark.....	182
4.5 5CFCRD.xxxx-03.....	183
4.5.1 General information.....	183
4.5.2 Order data.....	183
4.5.3 Technical data.....	183
4.5.4 Temperature/Humidity diagram.....	185

4.5.5 Dimensions.....	185
4.6 Known problems/issues.....	186
5 USB flash drives.....	187
5.1 5MMUSB.2048-00.....	187
5.1.1 General information.....	187
5.1.2 Order data.....	187
5.1.3 Technical data.....	187
5.1.4 Temperature/Humidity diagram.....	188
5.2 5MMUSB.xxxx-01.....	189
5.2.1 General information.....	189
5.2.2 Order data.....	189
5.2.3 Technical data.....	189
5.2.4 Temperature/Humidity diagram.....	190
6 Cables.....	191
6.1 DVI cables.....	191
6.1.1 5CADVI.0xxx-00.....	191
6.2 SDL cables.....	194
6.2.1 5CASDL.0xxx-00.....	194
6.3 SDL flex cables.....	197
6.3.1 5CASDL.0xxx-03.....	197
6.4 SDL flex cables with extender.....	200
6.4.1 5CASDL.0xx0-13.....	200
6.5 SDL cables with 45° male connector.....	204
6.5.1 5CASDL.0xxx-01.....	204
6.6 USB cables.....	207
6.6.1 5CAUSB.00xx-00.....	207
6.7 RS232 cables.....	208
6.7.1 9A0014.xx.....	208
7 HMI Drivers & Utilities DVD.....	210
7.1 5SWHMI.0000-00.....	210
7.1.1 General information.....	210
7.1.2 Order data.....	210
7.1.3 Contents (V2.20).....	210
Chapter 7 Maintenance and service.....	213
1 Replacing the battery.....	213
1.1 Evaluating the battery status.....	213
1.2 Procedure.....	213
2 Replacing a CompactFlash card.....	215
3 Changing the fan.....	216
3.1 Procedure.....	216
Appendix A	217
1 Maintenance Controller Extended (MTCX).....	217
1.1 Temperature monitoring Fan control.....	218
2 Abbreviations.....	219
3 Glossary.....	220

Chapter 1 • General information

1 Manual history

Version	Date	Change
0.10 Preliminary	11-Dec-08	<ul style="list-style-type: none"> • First version
0.20 Preliminary	23-Jan-09	<ul style="list-style-type: none"> • "Software" and "Maintenance and service" added. • Additional information about humidity specifications added. • Section see "Installation" on page 70 revised. • Section see "Glossary" on page 220 added. • Description of the temperature sensor positions moved to "Technical data". • Section "Environmentally friendly disposal" added to "General information".
1.00	08-Sep-09	<ul style="list-style-type: none"> • Section "Power calculation" added to "Technical data". • Section 1 "Male CAN connector (4-pin)" on page 168 added to "Accessories". • Photos of the power and reset button added. • B&R CompactFlash card added. • Technical data for Silicon Systems CFs revised. • Section see "Temperature monitoring Fan control" on page 218 added. • Information added based on small changes made to interfaces and component positions for the APC820. • L2 cache of CPU board 5PC800.B945-00 corrected to 2 MB. • Section see "PCIec plug-in cards" on page 63 added to "Technical data". • Image "Block diagram - Automation PC 820" on page 26 updated. • Interface descriptions added for revision A1 and later. • PCIec plug-in cards 5ACPCC.ETH0-00 and 5ACPCC.MPL0-00 added. • Added RUN LED to "LED status indicators". • CPU board 5PC800.B945-04 added. • Power supply with heat sink 5AC802.HS00-01 added. • "Standards and certifications" added. • ETH1 and ETH2 interfaces swapped. • Technical data for the system unit 5PC820.SX1-00 completed. • Data in section 2.1.3 "Temperature sensor locations" on page 22 added. • Figure 20 "Swivel range of the front cover" on page 74 changed. • Section 2.2 "Humidity specifications" on page 23 revised. • Modified Figure 4 "Supply voltage block diagram" on page 24. • Updated section 12 "B&R Key Editor" on page 164. • Section 2 "Upgrade information" on page 137 added. • Section 3 "Microsoft DOS" on page 146 added. • Section 1.12 "Allocation of resources" on page 134 added.
1.10	13-Nov-09	<ul style="list-style-type: none"> • System unit 5PC820.SX01-01 added. • Section 4.4 "5CFCRD.xxxx-04" on page 179 and section 4.5 "5CFCRD.xxxx-03" on page 183 updated. • Updated section 5 "Known problems / issues" on page 90 in chapter 3 "Installation". • Section 3 "Connection examples" on page 77 added in 3 "Installation". • Section 4 "Connecting peripheral USB devices" on page 88 added in 3 "Installation". • Section 1.2.3 "Wall mounting" on page 71 added in 3 "Installation". • Added information about LED status indicators to page 42 (power LED blinking). • The section "Creating a bootable USB flash drive" removed. • Updated section 2.2 "Firmware upgrade" on page 140 in chapter 4 "Software". • Updated 10 "B&R Automation Device Interface (ADI) Development Kit" on page 160 in Appendix A. • Corrected technical data for 8BXF001.0000-00 replacement fan on page 62. • Section 6 "Cables" on page 191 added in 6 "Accessories". • Images for the CAN plugs 0TB704.9 and 0TB704.91 corrected.
1.15	23-Nov-09	<ul style="list-style-type: none"> • System unit weight for 5PC820.SX01-00 corrected. • Section 1.3 "Mounting orientation" on page 72 added. • Figure 1 "Configuration - Base system" on page 19 corrected. • Vibration and shock specifications for the system units changed. • Information about the lifespan with and without the use of SRAM changed. • Technical data for some SDL cables corrected and updated. • SDL cable 5CASDL.0400-13 updated. • Added additional item to section 5 "Known problems / issues" on page 90. • Shock specifications removed.

Table 1: Manual history

Version	Date	Change
1.20	07-Jul-10	<ul style="list-style-type: none"> 5 "Standards and certifications" on page 166 revised. Section 6 "Windows Embedded Standard 2009" on page 151 added. B&R ID codes for system units added. B&R USB flash drive added to 6 "Accessories" on page 5MMUSB.2048-01. CPU boards 5PC800.B945-10, 5PC800.B945-11, 5PC800.B945-12, 5PC800.B945-13, 5PC800.B945-14 added. Technical data "Remanent variables for AR (Automation Runtime) in Power Fail Mode" added for the APC820 system units. Section 6 "Cables" on page 191 updated.
1.21	25-May-11	<ul style="list-style-type: none"> BIOS version updated (1.14 -> 1.17). SRAM information for "5ACPC.MPL0-00" on page 66 updated. Updated "Windows Embedded Standard 7" on page 153, "Automation Runtime" on page 156, "B&R Automation Device Interface (ADI) .NET SDK" on page 162, "HMI Drivers & Utilities DVD" on page 210 and "B&R Automation Runtime dongle". Revised sections "B&R Automation Device Interface (ADI) - Control Center" on page 158, "B&R Key Editor" on page 164 and "B&R Automation Device Interface (ADI) Development Kit" on page 160. Information about battery lifespan corrected. Chipset information for "CPU boards 945GME" on page 57 corrected. Revised "Configuration - Optional components" on page 20.
1.30	10-Dec-12	<ul style="list-style-type: none"> Section "Organization of safety notices" on page 14 revised - description text for "Caution" and "Warning" rewritten. Revised section "CompactFlash cards". Moved section 10 "B&R Automation Device Interface (ADI) Development Kit" on page 160 to 4 "Software". Section "Replacing a CompactFlash card" on page 215 added to "Maintenance and service". New CompactFlash cards 5CFCRD.xxxx-06 updated in 6 "Accessories". CompactFlash cards 5CFCRD.xxxx-04 discontinued. Updated section "Cable lengths and resolutions for SDL transmission" on page 28. Windows Embedded Standard 7 Service Pack 1 updated (see "Windows Embedded Standard 7" on page 153). "B&R Automation Device Interface (ADI) - Control Center" on page 158 updated. Updated "B&R Automation Device Interface (ADI) Development Kit" on page 160 to version 3.40. Updated "B&R Automation Device Interface (ADI) .NET SDK" on page 162 to version 1.80. Updated "B&R Key Editor" on page 164 to version 3.30. CompactFlash card 5CFCRD.032G-06 added, see "5CFCRD.xxxx-06" on page 173. BIOS version updated (1.17 -> 1.18). Entire manual revised according to current formatting standards.
1.35	2015-04-02	<ul style="list-style-type: none"> Updated B&R USB flash drive 5MMUSB.4096-01, see "USB flash drives" on page 187. Updated GOST-R certification information in the technical data. Revised pinout of "Monitor / Panel connection" on page 27. Updated chapter 5 "Standards and certifications" on page 166. Updated "B&R Automation Device Interface (ADI) - Control Center" on page 158. Updated "B&R Automation Device Interface (ADI) Development Kit" on page 160 to version 3.70. Updated "B&R Automation Device Interface (ADI) .NET SDK" on page 162 to version 2.10. Updated "B&R Key Editor" on page 164 to version 3.50. The new revisions of the CompactFlash cards 5CFCRD.xxxx-06 were updated, see "5CFCRD.xxxx-06" on page 173. Updated section "Automation Runtime" on page 156.

Table 1: Manual history

2 Safety guidelines

2.1 Intended use

Programmable logic controllers (PLCs), operating/monitoring devices (industrial PCs, Power Panels, Mobile Panels, etc.) and B&R uninterruptible power supplies have been designed, developed and manufactured for conventional use in industrial environments. They were not designed, developed and manufactured for any use involving serious risks or hazards that could lead to death, injury, serious physical damage or loss of any kind without the implementation of exceptionally stringent safety precautions. In particular, such risks and hazards include the use of these devices to monitor nuclear reactions in nuclear power plants, their use in flight control or flight safety systems as well as in the control of mass transportation systems, medical life support systems or weapons systems.

2.2 Protection against electrostatic discharge

Electrical components that can be damaged by electrostatic discharge (ESD) must be handled accordingly.

2.2.1 Packaging

- **Electrical components with a housing**
...do not require special ESD packaging but must be handled properly (see "Electrical components with a housing").
- **Electrical components without a housing**
...are protected by ESD-suitable packaging.

2.2.2 Guidelines for proper ESD handling

Electrical components with a housing

- Do not touch the connector contacts on connected cables.
- Do not touch the contact tips on circuit boards.

Electrical components without a housing

The following applies in addition to the points listed under "Electrical components with a housing":

- Any persons handling electrical components or devices with installed electrical components must be grounded.
- Components are only permitted to be touched on their narrow sides or front plate.
- Components should always be stored in a suitable medium (ESD packaging, conductive foam, etc.). Metallic surfaces are not suitable storage surfaces!
- Components should not be subjected to electrostatic discharge (e.g. through the use of charged plastics).
- Ensure a minimum distance of 10 cm from monitors and TV sets.
- Measuring instruments and equipment must be grounded.
- Probes on potential-free measuring instruments must be discharged on sufficiently grounded surfaces before taking measurements.

Individual components

- ESD protective measures for individual components are thoroughly integrated at B&R (conductive floors, footwear, arm bands, etc.).
- These increased ESD protective measures for individual components are not necessary for customers handling B&R products.

2.3 Policies and procedures

Electronic devices are never completely failsafe. If the programmable control system, operating/monitoring device or uninterruptible power supply fails, the user is responsible for ensuring that other connected devices, e.g. motors, are brought to a secure state.

When using programmable logic controllers or operating/monitoring devices as control systems together with a soft PLC (e.g. B&R Automation Runtime or comparable product) or slot PLC (e.g. B&R LS251 or comparable product), safety precautions relevant to industrial control systems (e.g. the provision of safety devices such as emergency stop circuits, etc.) must be observed in accordance with applicable national and international regulations. The same applies for all other devices connected to the system, such as drives.

All tasks such as the installation, commissioning and servicing of devices are only permitted to be carried out by qualified personnel. Qualified personnel are those familiar with the transport, mounting, installation, commissioning and operation of devices who also have the appropriate qualifications (e.g. IEC 60364). National accident prevention regulations must be observed.

The safety notices, connection descriptions (type plate and documentation) and limit values listed in the technical data are to be read carefully before installation and commissioning and must be observed.

2.4 Transport and storage

During transport and storage, devices must be protected against undue stress (mechanical loads, temperature, moisture, corrosive atmospheres, etc.).

2.5 Installation

- These devices are not ready for use upon delivery and must be installed and wired according to the specifications in this documentation in order for the EMC limit values to apply.
- Installation must be performed according to this documentation using suitable equipment and tools.
- Devices are only permitted to be installed by qualified personnel without voltage applied. Before installation, voltage to the control cabinet must be switched off and prevented from being switched on again.
- General safety guidelines and national accident prevention regulations must be observed.
- Electrical installation must be carried out in accordance with applicable guidelines (e.g. line cross sections, fuses, protective ground connections).

2.6 Operation

2.6.1 Protection against touching electrical parts

To operate programmable logic controllers, operating and monitoring devices, and uninterruptible power supplies, certain components must carry dangerous voltage levels. Touching one of these parts can result in a life-threatening electric shock. This could lead to death, severe injury or damage to equipment.

Before turning on the programmable logic controller, operating/monitoring devices or uninterruptible power supply, the housing must be properly grounded (PE rail). Ground connections must be established even when testing or operating operating/monitoring devices or the uninterruptible power supply for a short time!

Before turning the device on, all parts that carry voltage must be securely covered. During operation, all covers must remain closed.

2.6.2 Environmental conditions - Dust, moisture, corrosive gases

The use of operating/monitoring devices (e.g. industrial PCs, Power Panels, Mobile Panels, etc.) and uninterruptible power supplies in very dusty environments should be avoided. Dust collection on the devices can affect functionality and may prevent sufficient cooling, especially in systems with active cooling systems (fans).

The presence of corrosive gases can also lead to malfunctions. When combined with high temperature and humidity, corrosive gases – e.g. with sulfur, nitrogen and chlorine components – can induce chemical reactions that can damage electronic components very quickly. Signs of the presence of corrosive gases are blackened copper surfaces and cable ends on existing equipment.

For operation in dusty or moist conditions, correctly installed (e.g. cutout installations) operating/monitoring devices like the Automation Panel or Power Panel are protected on the front. The back of all devices must be protected from dust and moisture and cleaned at suitable intervals.

2.6.3 Viruses and dangerous programs

This system is subject to potential risk each time data is exchanged or software is installed from a data medium (e.g. diskette, CD-ROM, USB flash drive, etc.), a network connection or the Internet. The user is responsible for assessing these dangers, implementing preventive measures such as virus protection programs, firewalls, etc. and making sure that software is only obtained from trusted sources.

2.7 Environmentally friendly disposal

All B&R programmable controllers, operating/monitoring devices and uninterruptible power supplies are designed to inflict as little harm as possible on the environment.

2.7.1 Separation of materials

It is necessary to separate different materials so the device can undergo an environmentally friendly recycling process.

Component	Disposal
Programmable logic controllers Operating/Monitoring devices Uninterruptible power supply Batteries and rechargeable batteries Cables	Electronics recycling
Cardboard box / Paper packaging	Cardboard box / Paper recycling
Plastic packaging	Plastic recycling

Table 2: Environmentally friendly separation of materials

Disposal must comply with applicable legal regulations.

3 Organization of safety notices

Safety notices in this manual are organized as follows:

Safety notice	Description
Danger!	Disregarding these safety guidelines and notices can be life-threatening.
Warning!	Disregarding these safety guidelines and notices can result in severe injury or substantial damage to equipment.
Caution!	Disregarding these safety guidelines and notices can result in injury or damage to equipment.
Information:	This information is important for preventing errors.

Table 3: Description of the safety notices used in this documentation

4 Guidelines

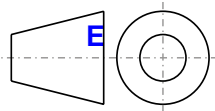

European dimension standards apply to all dimension diagrams in this document.

All dimensions are specified in mm.

Range of nominal sizes	General tolerance according to DIN ISO 2768 (medium)
Up to 6 mm	±0.1 mm
For 6 to 30 mm	±0.2 mm
For 30 to 120 mm	±0.3 mm
For 120 to 400 mm	±0.5 mm
For 400 to 1000 mm	±0.8 mm

Table 4: Range of nominal sizes

5 Overview

Product ID	Short description	on page
Automation Runtime		
0TG1000.01	Technology Guard	156
1TG4600.10-5	Automation Runtime Windows, TG license	156
1TG4601.06-5	Automation Runtime Embedded, TG license	156
Batteries		
0AC201.91	Lithium batteries 4 pcs., 3 V / 950 mAh button cell We hereby state that the lithium cells contained in this shipment qualify as "partly regulated". Handle with care. If the package is damaged, inspect the cells, repack intact cells and protect the cells against short circuit. For emergency information, call RENATA SA at +41 61 319 28 27.	169
4A0006.00-000	Lithium battery, 3 V / 950 mAh, button cell	169
CPU boards		
5PC800.B945-00	Intel Core Duo L2400 CPU board, 1.66 GHz, dual core, 667 MHz FSB, 2 MB L2 cache; 945GME chipset; 2 slots for SO-DIMM DDR2 modules (max. total of 3 GB), Realtek RTL8111B Ethernet controller	57
5PC800.B945-01	Intel Core2 Duo L7400 CPU board, 1.5 GHz, dual core, 667 MHz FSB, 4 MB L2 cache; 945GME chipset; 2 slots for SO-DIMM DDR2 modules (max. total of 3 GB), Realtek RTL8111B Ethernet controller	57
5PC800.B945-02	Intel Core2 Duo U7500 CPU board, 1.06 GHz, dual core, 533 MHz FSB, 2 MB L2 cache; 945GME chipset; 2 slots for SO-DIMM DDR2 modules (max. total of 3 GB), Realtek RTL8111B Ethernet controller	57
5PC800.B945-03	Intel Celeron M 423 CPU board, 1.06 GHz, single core, 533 MHz FSB, 1 MB L2 cache; 945GME chipset; 2 slots for SO-DIMM DDR2 modules (max. total of 3 GB), Realtek RTL8111B Ethernet controller	57
5PC800.B945-04	Intel Core2 Duo T7400 CPU board, 2.16 GHz, dual core, 667 MHz FSB, 4 MB L2 cache; 945GME chipset; 2 slots for SO-DIMM DDR2 modules (max. total of 3 GB), Realtek RTL8111B Ethernet controller	57
5PC800.B945-10	Intel Core Duo L2400 CPU board, 1.66 GHz, dual core, 667 MHz FSB, 2 MB L2 cache; 945GME chipset; 2 slots for SO-DIMM DDR2 modules (max. total of 3 GB), Realtek RTL8111C Ethernet controller	57
5PC800.B945-11	Intel Core2 Duo L7400 CPU board, 1.5 GHz, dual core, 667 MHz FSB, 4 MB L2 cache; 945GME chipset; 2 slots for SO-DIMM DDR2 modules (max. total of 3 GB), Realtek RTL8111C Ethernet controller	57
5PC800.B945-12	Intel Core2 Duo U7500 CPU board, 1.06 GHz, dual core, 533 MHz FSB, 2 MB L2 cache; 945GME chipset; 2 slots for SO-DIMM DDR2 modules (max. total of 3 GB), Realtek RTL8111C Ethernet controller	57
5PC800.B945-13	Intel Celeron M 423 CPU board, 1.06 GHz, single core, 533 MHz FSB, 1 MB L2 cache; 945GME chipset; 2 slots for SO-DIMM DDR2 modules (max. total of 3 GB), Realtek RTL8111C Ethernet controller	57
5PC800.B945-14	Intel Core2 Duo T7400 CPU board, 2.16 GHz, dual core, 667 MHz FSB, 4 MB L2 cache; 945GME chipset; 2 slots for SO-DIMM DDR2 modules (max. total of 3 GB), Realtek RTL8111C Ethernet controller	57
CompactFlash		
5CFCRD.016G-06	CompactFlash 16 GB B&R (SLC) ≤ Rev. D0	173
5CFCRD.032G-06	CompactFlash 32 GB B&R (SLC) ≤ Rev. C0	173
5CFCRD.0512-06	CompactFlash 512 MB B&R (SLC) ≤ Rev. E0	173
5CFCRD.1024-06	CompactFlash 1 GB B&R (SLC) ≤ Rev. E0	173
5CFCRD.2048-06	CompactFlash 2 GB B&R (SLC) ≤ Rev. E0	173
5CFCRD.4096-06	CompactFlash 4 GB B&R (SLC) ≤ Rev. E0	173
5CFCRD.8192-06	CompactFlash 8 GB B&R (SLC) ≤ Rev. E0	173
CompactFlash cards		
5CFCRD.0064-03	CompactFlash 64 MB Western Digital (SLC)	183
5CFCRD.0128-03	CompactFlash 128 MB Western Digital (SLC)	183
5CFCRD.016G-04	CompactFlash 16 GB B&R (SLC)	179
5CFCRD.0256-03	CompactFlash 256 MB Western Digital (SLC)	183
5CFCRD.0512-03	CompactFlash 512 MB Western Digital (SLC)	183
5CFCRD.0512-04	CompactFlash 512 MB B&R (SLC)	179
5CFCRD.1024-03	CompactFlash 1 GB Western Digital (SLC)	183
5CFCRD.1024-04	CompactFlash 1 GB B&R (SLC)	179
5CFCRD.2048-03	CompactFlash 2 GB Western Digital (SLC)	183
5CFCRD.2048-04	CompactFlash 2 GB B&R (SLC)	179
5CFCRD.4096-03	CompactFlash 4 GB Western Digital (SLC)	183
5CFCRD.4096-04	CompactFlash 4 GB B&R (SLC)	179
5CFCRD.8192-03	CompactFlash 8 GB Western Digital (SLC)	183
5CFCRD.8192-04	CompactFlash 8 GB B&R (SLC)	179
DVI cables		
5CADVI.0018-00	DVI-D cable - 1.8 m	191
5CADVI.0050-00	DVI-D cable - 5 m	191
5CADVI.0100-00	DVI-D cable - 10 m	191
Fan modules		
8BXF001.0000-00	ACOPOSmulti fan module, replacement fan for ACOPOSmulti modules (8BVP / 8B0C / 8BVI / 8BVE / 8B0K)	62
Heat sinks		
5AC802.HS00-00	APC820 power supply and heat sink for CPU boards with Dual Core processors L2400, L7400, U7500 and Celeron M 423.	61
5AC802.HS00-01	APC820 power supply with heat sink for CPU boards with dual-core processor T7400.	61
Interface cards		
5ACPC.C.ETH0-00	PCleC Ethernet card 1x 10/100/1000 For APC820 and PPC800.	64
5ACPC.C.MPL0-00	PCleC POWERLINK card, 2 POWERLINK interfaces, 512 kB SRAM; for APC820 and PPC800.	66
MS-DOS		
9S0000.01-010	OEM Microsoft MS-DOS 6.22, German floppy disks, only supplied together with a new PC	146
9S0000.01-020	OEM Microsoft MS-DOS 6.22, English floppy disks, only supplied together with a new PC	146
Main memory		
5MMDDR.0512-01	SO-DIMM DDR2 RAM 512 MB PC2-5300	60
5MMDDR.1024-01	SO-DIMM DDR2 RAM 1024 MB PC2-5300	60
5MMDDR.2048-01	SO-DIMM DDR2 RAM 2048 MB PC2-5300	60

Product ID	Short description	on page
Miscellaneous		
5AC900.1000-00	DVI (male connector) to CRT (female connector) adapter. For connecting a standard monitor to a DVI-I interface.	170
Other		
5SWHMI.0000-00	HMI Drivers & Utilities DVD	210
RS232 cables		
9A0014.02	RS232 extension cable for remote operation of a display unit with touch screen, 1.8 m	208
9A0014.05	RS232 extension cable for remote operation of a display unit with touch screen, 5 m	208
9A0014.10	RS232 extension cable for remote operation of a display unit with touch screen, 10 m	208
SDL cables		
5CASDL.0018-00	SDL cable - 1.8 m	194
5CASDL.0050-00	SDL cable - 5 m	194
5CASDL.0100-00	SDL cable, 10 m	194
5CASDL.0150-00	SDL cable, 15 m	194
5CASDL.0200-00	SDL cable, 20 m	194
5CASDL.0250-00	SDL cable, 25 m	194
5CASDL.0300-00	SDL cable, 30 m	194
SDL cables with 45° connectors		
5CASDL.0018-01	SDL cable - 45° connector - 1.8 m	204
5CASDL.0050-01	SDL cable with 45° male connector, 5 m	204
5CASDL.0100-01	SDL cable with 45° male connector, 10 m	204
5CASDL.0150-01	SDL cable with 45° male connector, 15 m	204
SDL flex cables		
5CASDL.0018-03	SDL flex cable - 1.8 m	197
5CASDL.0050-03	SDL flex cable, 5 m	197
5CASDL.0100-03	SDL flex cable, 10 m	197
5CASDL.0150-03	SDL flex cable, 15 m	197
5CASDL.0200-03	SDL flex cable, 20 m	197
5CASDL.0250-03	SDL flex cable, 25 m	197
5CASDL.0300-03	SDL flex cable, 30 m	197
5CASDL.0300-13	SDL flex cable with extender, 30 m	200
5CASDL.0400-13	SDL flex cable with extender, 40 m	200
5CASDL.0430-13	SDL flex cable with extender, 43 m	200
System units		
5PC820.SX01-00	APC820 system unit, cold plate mounting, 1 PCIe card slot; 2x CompactFlash slot, 1x RS232, 1x RS232/422/485, 1x POWERLINK, 1x CAN, Smart Display Link/DVI/Monitor, 5x USB 2.0, 2x ETH 10/100/1000, 24 VDC over the ACOPOSmulti busbar.	49
5PC820.SX01-01	APC820 system unit, wall mounting, 1 PCIe card slot; 2x CompactFlash slot, 1x RS232, 1x RS232/422/485, 1x POWERLINK, 1x CAN, Smart Display Link/DVI/Monitor, 5x USB 2.0, 2x ETH 10/100/1000, 24 VDC over the ACOPOSmulti busbar.	53
Terminal blocks		
0TB704.9	Accessory terminal block, 4-pin, screw clamps 2.5 mm ²	168
0TB704.91	Accessory terminal block, 4-pin, cage clamps 2.5 mm ²	168
USB accessories		
5MMUSB.2048-00	USB 2.0 flash drive, 2048 MB	187
5MMUSB.2048-01	USB 2.0 flash drive, 2048 MB, B&R	189
5MMUSB.4096-01	USB 2.0 flash drive, 4096 MB, B&R	189
USB cables		
5CAUSB.0018-00	USB 2.0 connection cable type A - type B, 1.8 m	207
5CAUSB.0050-00	USB 2.0 connection cable type A - type B, 5 m	207
Windows Embedded Standard 2009		
5SWWXP.0728-ENG	Microsoft OEM Windows Embedded Standard 2009, English; for APC820 with 945GME chipset; please order CompactFlash separately (minimum 1 GB).	151
Windows Embedded Standard 7		
5SWWI7.0528-ENG	Microsoft OEM Windows Embedded Standard 7 32-bit, English; for APC820 with 945GME chipset; please order CompactFlash separately (minimum 8 GB).	153
5SWWI7.0628-ENG	Microsoft OEM Windows Embedded Standard 7 64-bit, English; for APC820 with 945GME chipset; please order CompactFlash separately (minimum 16 GB).	153
5SWWI7.0728-MUL	Microsoft OEM Windows Embedded Standard 7 Premium 32-bit, multilanguage; for APC820 with 945GME chipset; please order CompactFlash separately (minimum 8 GB).	153
5SWWI7.0828-MUL	Microsoft OEM Windows Embedded Standard 7 Premium 64-bit, multilanguage; for APC820 with 945GME chipset; please order CompactFlash separately (minimum 16 GB).	153
5SWWI7.1528-ENG	Microsoft OEM Windows Embedded Standard 7 32-bit, Service Pack 1, English; for APC820 with 945GME chipset; please order CompactFlash separately (minimum 16 GB).	153
5SWWI7.1628-ENG	Microsoft OEM Windows Embedded Standard 7 64-bit, Service Pack 1, English; for APC820 with 945GME chipset; please order CompactFlash separately (minimum 16 GB).	153
5SWWI7.1728-MUL	Microsoft OEM Windows Embedded Standard 7 Premium 32-bit, Service Pack 1, multilanguage; for APC820 with 945GME chipset; please order CompactFlash separately (minimum 16 GB).	153
5SWWI7.1828-MUL	Microsoft OEM Windows Embedded Standard 7 Premium 64-bit, Service Pack 1, multilanguage; for APC820 with 945GME chipset; please order CompactFlash separately (minimum 16 GB).	153
Windows XP Embedded		
5SWWXP.0428-ENG	Microsoft OEM Windows XP Embedded Feature Pack 2007, English; for APC820 with 945GME chipset; please order CompactFlash separately (minimum 512 MB).	149
Windows XP Professional		
5SWWXP.0500-ENG	Microsoft OEM Windows XP Professional Service Pack 2c, CD, English. Only available with a new device.	147
5SWWXP.0500-GER	Microsoft OEM Windows XP Professional Service Pack 2c, CD, German. Only available with a new device.	147
5SWWXP.0500-MUL	Microsoft OEM Windows XP Professional Service Pack 2c, CD, multilingual. Only available with a new device.	147

Product ID	Short description	on page
5SWWXP.0600-ENG	Windows XP Professional SP3 - English - CD	147
5SWWXP.0600-GER	Windows XP Professional SP3 - German - CD	147
5SWWXP.0600-MUL	Windows XP Professional SP3 - Multilingual - CD	147

Chapter 2 • Technical data

1 Introduction

The ultra-compact, integrated ACOPOSMulti offers the most cost-effective solution possible for machines with multiple axes. What makes the ACOPOSMulti so easy to use? Maybe it's the modular cooling concept that can be flexibly adapted to any installation, the user-friendly cabling or its scalable performance.

The Automation PC 820 was developed for the ACOPOSMulti system and is equipped on the machine for rough environmental conditions. Because the APC820 can be completely integrated into the ACOPOSMulti system, the space otherwise needed for the PC is no longer occupied in the control cabinet. The APC820 was designed for the toughest environments. Not a single internal cable connection was used during construction. This has made it possible to achieve maximum vibration resistance and operational safety. Free of any rotating parts, CompactFlash cards are the optimum storage media for use in the machine.



1.1 Features

- Latest processor technologies - Core Duo, Core 2 Duo and Celeron M
- Up to 3 GB main memory (dual-channel memory support)
- 2 CompactFlash slots (type I)
- 1 PCI Express compact Slot (for PCIe cards)
- 5x USB 2.0
- 2x Ethernet 10/100/1000 Mbit interfaces
- 1x POWERLINK (with node switch)
- 1x CAN interface (with node switch)
- 1x RS232 interface
- 1x RS232/422/485 interface
- SRAM 1MB (battery backed)
- Connection of various display devices to the "Monitor/Panel" video output (supports SDL, DVI, and monitor signals)
- Fan
- BIOS (AMI)

- 24 VDC supply voltage (via ACOPOSmulti supply busbar)
- Installation as with ACOPOSmulti system units
- Dongle
- Battery





1.2 System components

The APC820 system can be assembled to meet individual requirements and operating conditions.

The following components are absolutely essential for operation:

- Mounting plate (cold-plate or feed-through mounting, see ACOPOSmulti manual)
- System unit
- CPU board
- Power supply with heat sink (already part of the system unit, heat sink depends on the CPU board being used)
- Fan (already part of the system unit)
- Main memory
- CompactFlash card for the operating system
- Operating system

1.2.1 Configuration - Base system

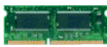
Configuration - Base system	
Mounting plate ¹⁾	Select one
	8B0MnnnnHC00.000-1 - Cold-plate mounting 8B0MnnnnHF00.000-1 ²⁾ - Feed-through mount. 8B0MnnnnHW00.000-1 - Wall mounting
System unit	Select one
A system unit consists of a housing and main board.	<div style="display: flex; justify-content: space-around; align-items: center;"> <div style="text-align: center;">  5PC820.SX01-00 </div> <div style="text-align: center;">  5PC820.SX01-01 </div> </div>
CPU board - Power supply with heat sink - Main memory	
CPU board	Select one
	5PC800.B945-00 / -10 5PC800.B945-01 / -11 5PC800.B945-02 / -12 5PC800.B945-03 / -12 5PC800.B945-04 / -14
Power supply + heat sink	Select one
	<div style="display: flex; justify-content: space-around;"> <div style="text-align: center;"> 5AC802.HS00-00 </div> <div style="text-align: center;"> 5AC802.HS00-01 </div> </div>
Main memory	Select 1 or 2 (max. 3 GB can be used)
	5MMDDR.0512-01 - 512 MB 5MMDDR.1024-01 - 1 GB 5MMDDR.2048-01 - 2 GB

1) The desired number of slots must be specified in the model number by nnnn (e.g. 0160 equals 16 slots). Additional information can be found in the ACOPOSmulti user's manual, which can be downloaded from the B&R homepage free of charge.

2) The number of slots must be a multiple of 4.

Figure 1: Configuration - Base system

1.2.2 Configuration - Optional components





Configuration - Software and accessories																																		
System unit																																		
A system unit consists of a housing and a main board.	 <p style="text-align: center;">5PC820.SX01-00 5PC820.SX01-01</p>																																	
PCIec plug-in cards	Select 1																																	
	<p style="text-align: center;">5ACPCC.ETH0-00 (PCIec Ethernet card 10/100/1000) 5ACPCC.MPL0-00 (PCIec POWERLINK MN 2-port)</p>																																	
Replacement fan	Select 1																																	
	8BXF001.0000-00																																	
CompactFlash	Select 1 or 2																																	
	<p>5CFCRD.0512-06, 5CFCRD.1024-06, 5CFCRD.0064-03, 5CFCRD.0128-03, 5CFCRD.2048-06, 5CFCRD.4096-06, 5CFCRD.0256-03, 5CFCRD.0512-03, 5CFCRD.8192-06, 5CFCRD.016G-06 5CFCRD.1024-03, 5CFCRD.2048-03, 5CFCRD.4096-03, 5CFCRD.8192-03</p>																																	
Software	Select 1																																	
	<table border="0"> <tr> <td>Windows XP</td> <td>Windows Embedded Standard 2009</td> <td>Automation Runtime</td> </tr> <tr> <td>5SWWXP.0500-ENG</td> <td>5SWWXP.0728-ENG</td> <td>1TG4600.10-5</td> </tr> <tr> <td>5SWWXP.0500-GER</td> <td></td> <td>1TG4601.06-5</td> </tr> <tr> <td>5SWWXP.0500-MUL</td> <td>Windows XP Embedded</td> <td>0TG1000.01</td> </tr> <tr> <td>5SWWXP.0600-ENG</td> <td>5SWWXP.0428-ENG</td> <td></td> </tr> <tr> <td>5SWWXP.0600-GER</td> <td>Windows Embedded Standard 7</td> <td></td> </tr> <tr> <td>5SWWXP.0600-MUL</td> <td>5SWWI7.1528-ENG</td> <td></td> </tr> <tr> <td></td> <td>5SWWI7.1628-ENG</td> <td></td> </tr> <tr> <td>Microsoft DOS</td> <td>5SWWI7.1728-MUL</td> <td></td> </tr> <tr> <td>9S0000.01-010</td> <td>5SWWI7.1828-MUL</td> <td></td> </tr> <tr> <td>9S0000.01-020</td> <td></td> <td></td> </tr> </table>	Windows XP	Windows Embedded Standard 2009	Automation Runtime	5SWWXP.0500-ENG	5SWWXP.0728-ENG	1TG4600.10-5	5SWWXP.0500-GER		1TG4601.06-5	5SWWXP.0500-MUL	Windows XP Embedded	0TG1000.01	5SWWXP.0600-ENG	5SWWXP.0428-ENG		5SWWXP.0600-GER	Windows Embedded Standard 7		5SWWXP.0600-MUL	5SWWI7.1528-ENG			5SWWI7.1628-ENG		Microsoft DOS	5SWWI7.1728-MUL		9S0000.01-010	5SWWI7.1828-MUL		9S0000.01-020		
Windows XP	Windows Embedded Standard 2009	Automation Runtime																																
5SWWXP.0500-ENG	5SWWXP.0728-ENG	1TG4600.10-5																																
5SWWXP.0500-GER		1TG4601.06-5																																
5SWWXP.0500-MUL	Windows XP Embedded	0TG1000.01																																
5SWWXP.0600-ENG	5SWWXP.0428-ENG																																	
5SWWXP.0600-GER	Windows Embedded Standard 7																																	
5SWWXP.0600-MUL	5SWWI7.1528-ENG																																	
	5SWWI7.1628-ENG																																	
Microsoft DOS	5SWWI7.1728-MUL																																	
9S0000.01-010	5SWWI7.1828-MUL																																	
9S0000.01-020																																		

Figure 2: Configuration - Optional components

2 Complete system

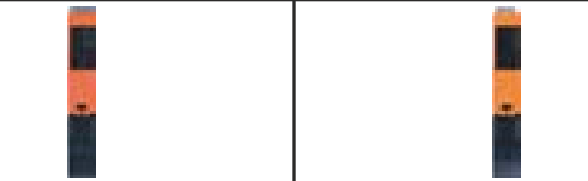
2.1 Temperature specifications

CPU boards can be combined with various other components, such as main memory, additional insert cards, etc. depending on the system unit. The various configurations result in varying maximum possible ambient temperatures, which can be seen in the following tables.

Information:

The maximum specified ambient temperatures for operation with a fan kit were determined under worst-case conditions. Experience has shown that higher ambient temperatures can be reached in typical applications, e.g. those in Microsoft Windows. Testing and evaluation must be performed on-site by the user (temperatures can be read in BIOS or with the B&R Control Center).

Information regarding worst-case conditions

- Thermal Analysis Tool (TAT V2.02) from Intel for simulating a 100% processor load
- BurnInTest tool (BurnInTest V4.0 Pro from Passmark Software) for simulating a 100% load on the interface via loop back adapters (serial interfaces, USB ports)
- Maximum system expansion and power consumption

2.1.1 Maximum ambient temperature with a fan kit

Caution!

The Automation PC820 must be attached to the first position of the mounting plate.

		All temperature values in degrees Celsius (°C) at 500 meters above sea level.				
		5PC800.B945-00 5PC800.B945-10	5PC800.B945-01 5PC800.B945-11	5PC800.B945-02 5PC800.B945-12	5PC800.B945-03 5PC800.B945-13	5PC800.B945-04 5PC800.B945-14
Maximum ambient temperature		55	55	55	55	55
What can also be operated at the max. ambient temperature, or are there limits?						
Main memory	5MMDDR.0512-01	✓	✓	✓	✓	✓
	5MMDDR.1024-01	✓	✓	✓	✓	✓
	5MMDDR.2048-01	✓	✓	✓	✓	✓
System unit	5PC820.SX01-00	✓	✓	✓	✓	✓
	5PC820.SX01-01	✓	✓	✓	✓	✓
Insert cards PClec card slot	5ACPCC.ETH0-00	✓	✓	✓	✓	✓
	5ACPCC.MPL0-00	✓	✓	✓	✓	✓

Table 5: Ambient temperature with a fan kit

2.1.1.1 How is the maximum ambient temperature determined?

1. CPU type selection
2. The "Maximum ambient temperature" row shows the maximum ambient temperature for the complete system, including the respective CPU board.

Information:

Maximum temperature data is for operation at 500 meters. The maximum ambient temperature is typically derated by 1°C per 1000 meters (starting at 500 meters above sea level).

If there is a "✓" next to the component, it can be used at the maximum ambient temperature of the complete system without problems.

If there is a specific temperature, for example "35", next to the component, then the ambient temperature of the complete APC820 system cannot exceed this temperature.

2.1.2 Temperature monitoring

Sensors monitor temperature values at various places in the APC820 (CPU, board, board I/O, baseboard out, baseboard center, baseboard in, power supply, IF slot). The location of these temperature sensors is illustrated in Figure 3 "Temperature sensor position" on page 22. The values listed in the table represent the defined maximum temperature¹⁾ for the respective measurement point. An alarm is not triggered if this temperature is exceeded. These temperatures can be read in BIOS ("Advanced" - Baseboard/Panel features - Baseboard monitor) or in approved Microsoft operating systems via the B&R Control Center.

2.1.3 Temperature sensor locations

Sensors indicate temperature values at many different locations in the APC820. The temperatures¹⁾ can be read in BIOS (Advanced - Baseboard/Panel features) or in Microsoft Windows operating systems via the B&R Control Center²⁾.

For applications that don't use Windows, temperatures can be evaluated using the B&R implementation guide. In addition to the implementation guide, there are also programs available in MS-DOS.

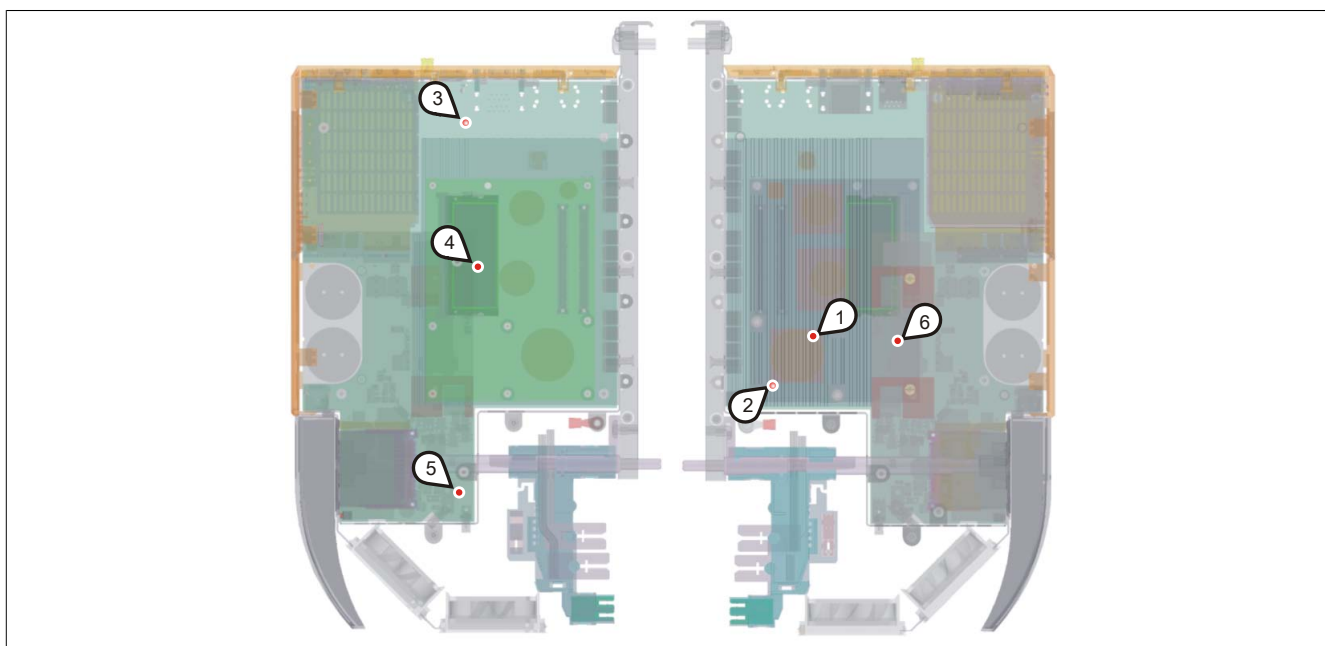

Figure 3: Temperature sensor position

Position	Measurement point for	Measurement	Max. specified
1	CPU	Ambient temperature of the processor (integrated in the processor)	95°C
2	CPU board	Temperature on the CPU board close to the processor.	85°C
3	Baseboard Out	Temperature of the board in the top area.	80°C
4	Baseboard Center	Temperature of the board in the middle area.	80°C
5	Baseboard In	Temperature of the board in the bottom area.	65°C
6	Power supply	Power supply temperature	85°C
	IF slot (PClec card slot)	Temperature of the PClec slot; the sensor is located directly on the plug-in card.	Depends on the plug-in card being used

Table 6: Temperature sensor locations

¹⁾ The temperature measured approximates the immediate ambient temperature but may also be influenced by neighboring components.

¹⁾ The temperature measured approximates the immediate ambient temperature but may also be influenced by neighboring components.

²⁾ The ADI driver that includes the B&R Control Center is available in the Downloads section of the B&R website (www.br-automation.com).

2.2 Humidity specifications

The following table lists the minimum and maximum relative humidity values for the individual components that are relevant for the humidity limitations of a complete system. The lowest and highest common values are always used when establishing these limits.

Component		Operation	Storage / Transport
CPU boards 945GME COM Express		10 to 90%	5 to 95%
System unit		5 to 85%	5 to 90%
Main memory for CPU boards		10 to 90%	5 to 90%
Accessories	5CFCRD.xxxx-06 CompactFlash cards	85%	85%
	5CFCRD.xxxx-04 CompactFlash cards	85%	85%
	5CFCRD.xxxx-03 CompactFlash cards	8 to 95%	8 to 95%
	Flash drive 5MMUSB.xxxx-xx	10 to 90%	5 to 90%

Table 7: Humidity specifications

The specifications listed correspond to the relative humidity at an ambient temperature of 30°C. More detailed information about specific temperature-dependent humidity values can be found in the technical data for the individual components.

2.3 Power management

2.3.1 Voltage supply block diagram

The following block diagram illustrates the simplified structure of the APC820 voltage supply.

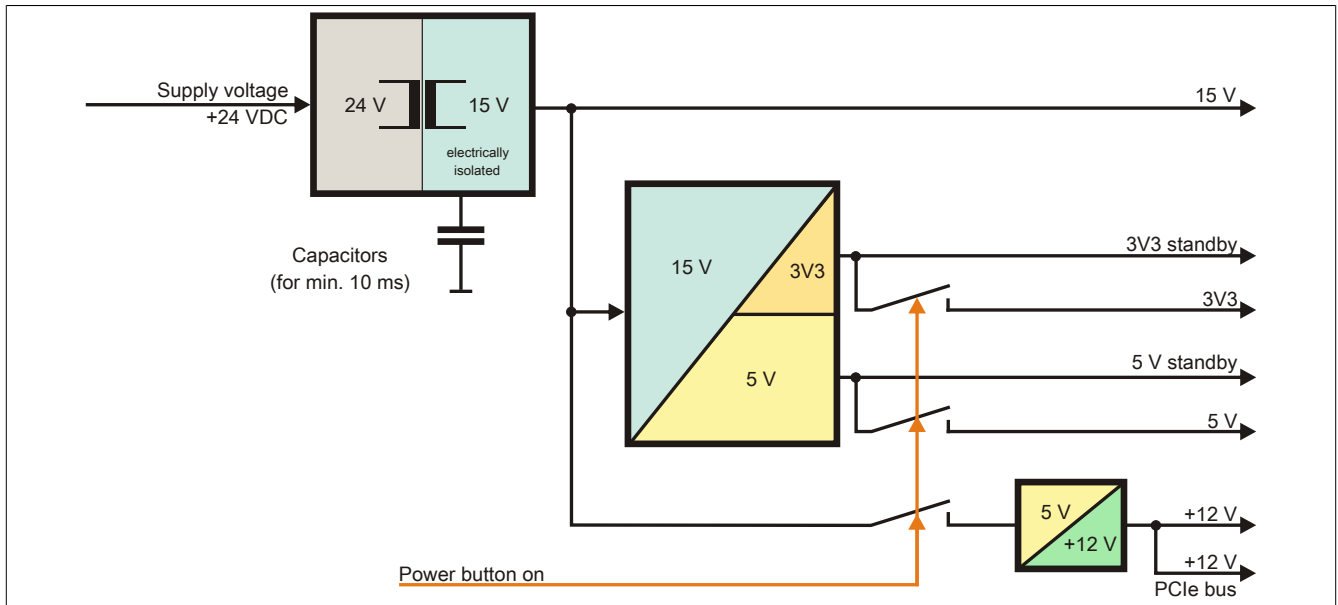

Figure 4: Supply voltage block diagram

Description

15 V is generated from the supply voltage using a DC-to-DC converter. This electrically isolated 15 V supplies additional DC-to-DC converters that generate the remaining voltage.

After the system is turned on (e.g. using the power button), the 3V3 and 5 V voltages are applied to the bus. An additional DC-to-DC converter generates +12 V.

2.3.2 Power calculation

Information:		CPU board					Current system
		5PC800.B945-00 5PC800.B945-10	5PC800.B945-01 5PC800.B945-11	5PC800.B945-02 5PC800.B945-12	5PC800.B945-03 5PC800.B945-13	5PC800.B945-04 5PC800.B945-14	Enter values in this column
All values in Watts The values for the suppliers are maximum values. The values for the consumers are average maximum values, but not peak values.							
		Total power supply power (maximum)					85
		Maximum possible at +12V					75
Total power supply	+12 V	CPU board, permanent consumers	26	30	18	14	43
		512 MB RAM, max. 2 with 1.5 W each					
		1024 MB RAM, max. 2 with 2.5 W each					
		2048 MB RAM, max. 2 with 3 W each					
		Fan kit (2 pcs.), permanent consumers	5	5	5	5	5
		PCle card power consumption – max. 4 W	4	4	4	4	4
		Consumers +12 V ∑					
		Maximum possible at +5V					40
+5 V	Baseboard, permanent consumers	4	4	4	4	4	
	USB peripherals USB2 and USB4 with 2.5 W each						
	USB peripherals USB1, USB3 and USB5 with 5 W each						
	PCle card power consumption – max. 4 W	4	4	4	4	4	
		Consumers +5 V ∑					
		Maximum possible at 3V3					30
3V3	Baseboard, permanent consumers	4	4	4	4	4	
	CompactFlash, 1 W each						
	PCle card power consumption – max. 4 W	4	4	4	4	4	
		Consumers 3V3 V ∑					
		Consumers ∑					

Table 8: Power calculation – APC810

Information:

The PCIe card must not consume more than a total of 4 W (12V/5V/3V3)!

2.4 Block diagram

The following block diagram shows the simplified system unit structure with a CPU board.

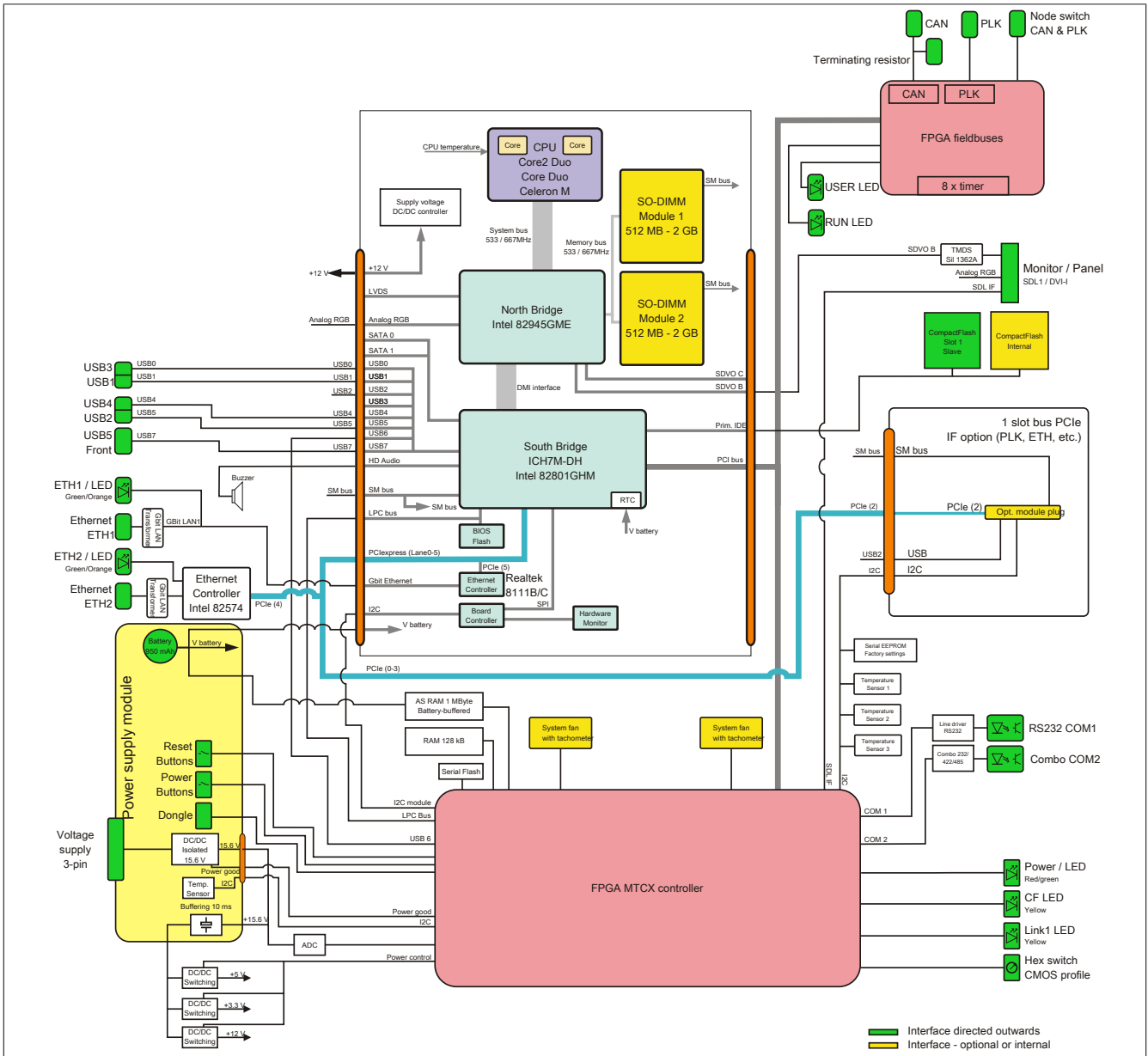

Figure 5: Block diagram - Automation PC 820

2.5 Device interfaces and slots

2.5.1 +24 VDC power supply

If the APC820 is secured, it is automatically connected to the ACOPOSmulti rail supply voltage. For information about installing the APC820, see chapter Installation, section see "Installation" on page 70. The supply voltage is protected internally by a soldered fuse (15 A, fast-acting) so that the device cannot be damaged if an overload occurs (fuse replacement necessary). The device must be returned to B&R for repairs if the fuse is blown in the event of an error.

2.5.2 Grounding

The APC820 is automatically grounded if mounted to a cold-plate, feed-through plate or wall mounting plate (ACOPOSmulti rail). More information can be found in the ACOPOSmulti user's manual.

2.5.3 Monitor / Panel connection

Monitor/Panel interface - RGB / SDL (Smart Display Link) / DVI ¹⁾	
The following is an overview of the video signals available on the monitor/panel output. For details, see the technical data for the CPU board being used.	
CPU board	Video signals
5PC800.B945-00 / -10	RGB, DVI, SDL
5PC800.B945-01 / -11	RGB, DVI, SDL
5PC800.B945-02 / -12	RGB, DVI, SDL
5PC800.B945-03 / -13	RGB, DVI, SDL
5PC800.B945-04 / -14	RGB, DVI, SDL



Table 9: Monitor / Panel connection - RGB, DVI, SDL

1) The interfaces, etc. available on the device or module have been numbered as such for easy identification. This numbering may differ from that used by the particular operating system.

Information:

The hardware and graphics drivers of approved operating systems support the hot plugging of display devices to the monitor/panel interface for service purposes. The male monitor/panel connector is specified for 100 connection cycles.

Information:

If a display device with touch screen is connected to the monitor/panel interface and then disconnected again during operation (hot plugging), it may be necessary to recalibrate the touch screen.

Information:

The RGB interface uses an analog signal; the line length depends on the resolution and prevailing environmental conditions. This interface is therefore only recommended for service purposes.

2.5.3.1 USB communication in SDL and DVI mode

Information:

The USB transfer rate is limited to USB 1.1 in SDL mode.

In DVI mode, the maximum USB transfer rate is determined by the USB interface and USB hub on the display device.

2.5.3.2 Pinout

Pin	Assignment	Description	Pin	Assignment	Description
1	TMDS data 2-	DVI lane 2 (negative)	16	HPD	Hot plug detect
2	TMDS data 2+	DVI lane 2 (positive)	17	TMDS data 0-	DVI lane 0 (negative)
3	TMDS data 2/4 SHIELD	Shield for data pair 2 and 4	18	TMDS data 0+	DVI lane 0 (positive)
4	SDL-	SDL lane (negative)	19	TMDS Data 0/ XUSB1 SHIELD	Shield for data pair 0 and USB1
5	SDL+	SDL lane (positive)	20	XUSB1-	USB lane 1 (negative)
6	DDC clock	DDC-based control signal (clock)	21	XUSB1+	USB lane 1 (positive)
7	DDC data	DDC-based control signal (data)	22	TMDS clock shield	Shield for clock pair
8	ANALOG VERT SYNC	Analog vertical synchronization	23	TMDS clock+	DVI clock (positive)
9	TMDS data 1-	DVI lane 1 (negative)	24	TMDS clock -	DVI clock (negative)
10	TMDS DATA 1+	DVI lane 1 (negative) HDMI clock (positive)	C1	ANALOG RED	Analog red
11	TMDS DATA 1/ XUSB0 SHIELD	Shield for data pair 1 and USB0	C2	ANALOG GREEN	Analog green
12	XUSB0-	USB lane 0 (negative)	C3	ANALOG BLUE	Analog blue
13	XUSB0+	USB lane 0 (positive)	C4	ANALOG HORZ SYNC	Analog horizontal synchronization
14	+5 V power ¹⁾	+5 V power supply	C5	ANALOG GND	Analog ground (return for R, G and B signals)
15	Ground (return for +5 V, HSync and VSync)	Ground			

24-pin female DVI connector

Table 10: DVI interface - Pinout

1) Protected internally by a multifuse.

2.5.3.3 Cable lengths and resolutions for SDL transmission

The following table lists the relationship between segment lengths and maximum resolution depending on the SDL cable being used:

SDL cable Segment length [m]	Resolution						
	VGA 640 x 480	SVGA 800 x 600	XGA 1024 x 768	HD 1366 x 768	SXGA 1280 x 1024	UXGA 1600 x 1200	FHD 1920 x 1080
1.8	5CASDL.0018-00 5CASDL.0018-01 5CASDL.0018-03	5CASDL.0018-00 5CASDL.0018-01 5CASDL.0018-03	5CASDL.0018-00 5CASDL.0018-01 5CASDL.0018-03	5CASDL.0018-00 5CASDL.0018-01 5CASDL.0018-03	5CASDL.0018-00 5CASDL.0018-01 5CASDL.0018-03	5CASDL.0018-00 5CASDL.0018-01 5CASDL.0018-03	5CASDL.0018-00 5CASDL.0018-01 5CASDL.0018-03
5	5CASDL.0050-00 5CASDL.0050-01 5CASDL.0050-03	5CASDL.0050-00 5CASDL.0050-01 5CASDL.0050-03	5CASDL.0050-00 5CASDL.0050-01 5CASDL.0050-03	5CASDL.0050-00 5CASDL.0050-01 5CASDL.0050-03	5CASDL.0050-00 5CASDL.0050-01 5CASDL.0050-03	5CASDL.0050-00 5CASDL.0050-01 5CASDL.0050-03	5CASDL.0050-00 5CASDL.0050-01 5CASDL.0050-03
10	5CASDL.0100-00 5CASDL.0100-01 5CASDL.0100-03	5CASDL.0100-00 5CASDL.0100-01 5CASDL.0100-03	5CASDL.0100-00 5CASDL.0100-01 5CASDL.0100-03	5CASDL.0100-00 5CASDL.0100-01 5CASDL.0100-03	5CASDL.0100-00 5CASDL.0100-01 5CASDL.0100-03	5CASDL.0100-00 5CASDL.0100-01 5CASDL.0100-03	5CASDL.0100-00 5CASDL.0100-01 5CASDL.0100-03
15	5CASDL.0150-00 5CASDL.0150-01 5CASDL.0150-03	5CASDL.0150-00 5CASDL.0150-01 5CASDL.0150-03	5CASDL.0150-00 5CASDL.0150-01 5CASDL.0150-03	5CASDL.0150-00 5CASDL.0150-01 5CASDL.0150-03	5CASDL.0150-00 5CASDL.0150-01 5CASDL.0150-03	- - -	- - 5CASDL.0150-03
20	5CASDL.0200-00 5CASDL.0200-03	5CASDL.0200-00 5CASDL.0200-03	5CASDL.0200-00 5CASDL.0200-03	5CASDL.0200-00 5CASDL.0200-03	5CASDL.0200-00 5CASDL.0200-03	- -	- 5CASDL.0200-03
25	5CASDL.0250-00 5CASDL.0250-03	5CASDL.0250-00 5CASDL.0250-03	5CASDL.0250-00 5CASDL.0250-03	5CASDL.0250-00 5CASDL.0250-03	- 5CASDL.0250-03	- -	- -
30	5CASDL.0300-00 5CASDL.0300-03	5CASDL.0300-00 5CASDL.0300-03	- 5CASDL.0300-13	- 5CASDL.0300-13	- 5CASDL.0300-13	- -	- 5CASDL.0300-13
40	5CASDL.0400-13	5CASDL.0400-13	5CASDL.0400-13	5CASDL.0400-13	5CASDL.0400-13	-	5CASDL.0400-13

Table 11: Cable lengths and resolutions for SDL transmission

2.5.3.4 Cable lengths and resolutions for DVI transmission

The following table lists the relationship between segment lengths and maximum resolution depending on the DVI cable being used:

DVI cable Segment length [m]	Resolution						
	VGA 640 x 480	SVGA 800 x 600	XGA 1024 x 768	HD 1366 x 768	SXGA 1280 x 1024	UXGA 1600 x 1200	FHD 1920 x 1080
1.8	5CADVI.0018-00	5CADVI.0018-00	5CADVI.0018-00	5CADVI.0018-00	5CADVI.0018-00	5CADVI.0018-00	5CADVI.0018-00
5	5CADVI.0050-00	5CADVI.0050-00	5CADVI.0050-00	5CADVI.0050-00	5CADVI.0050-00	5CADVI.0050-00	5CADVI.0050-00

Table 12: Cable lengths and resolutions for DVI transmission

The maximum cable length for DVI transfer is limited to 5 m due to the USB specification.

2.5.4 USB interfaces

The APC820 features a USB 2.0 (Universal Serial Bus) host controller with multiple USB ports, 5 of which are accessible externally for the user.

Warning!

Peripheral USB devices can be connected to the USB interfaces on this device. Due to the large number of USB devices available on the market, B&R cannot guarantee their performance. All USB devices provided by B&R are guaranteed to function properly.

Warning!

Because this interface is designed according to general PC specifications, extreme care should be exercised with regard to EMC, cable routing, etc.

USB1, USB2, USB3, USB4

Universal Serial Bus (USB1, USB2, USB3, USB4) ¹⁾	
Type	USB 2.0
Design	Type A
Transfer rate	Low speed (1.5 Mbit/s), full speed (12 Mbit/s), high speed (480 Mbit/s)
Current load ¹⁾ USB1, USB3 USB2, USB4	Max. 1 A Max. 500 mA
Cable length	Max. 5 m (without hub)

4x USB type A, female

Table 13: USB1, USB2, USB3 and USB4 connections

- 1) The interfaces, etc. available on the device or module have been numbered as such for easy identification. This numbering may differ from that used by the particular operating system.
- 2) Each USB interface is protected by a maintenance-free "USB current limiting circuit breaker" (max. 500 mA or 1 A).

USB5

The USB5- connection is located on the front side at the bottom of the APC820.

Universal Serial Bus (USB5) ¹⁾	
Type	USB 2.0
Design	Type A
Transfer rate	Low speed (1.5 Mbit/s), full speed (12 Mbit/s), high speed (480 Mbit/s)
Current load ¹⁾ USB5	Max. 1 A
Cable length	Max. 5 m (without hub)

1x USB type A, female

Table 14: USB5 interface

- 1) The interfaces, etc. available on the device or module have been numbered as such for easy identification. This numbering may differ from that used by the particular operating system.
- 2) Each USB interface is protected by a maintenance-free "USB current-limiting circuit breaker" (max. 1 A).

2.5.5 CompactFlash slot 1

This CompactFlash slot is a fixed part of an APC820 system and is internally connected with the chipset via IDE PATA. Type I CompactFlash cards are supported. The CompactFlash slots are located behind the cable cover.

CompactFlash slot (CF1)	
Connection	PATA Master
CompactFlash Type	Type I
Model number	Short description
CompactFlash	
5CFCRD.0512-06	B&R CompactFlash 512 MB
5CFCRD.1024-06	B&R CompactFlash 1024 MB
5CFCRD.2048-06	B&R CompactFlash 2048 MB
5CFCRD.4096-06	B&R CompactFlash 4096 MB
5CFCRD.8192-06	B&R CompactFlash 8192 MB
5CFCRD.016G-06	B&R CompactFlash 16 GB
5CFCRD.0064-03	CompactFlash 64 MB WD
5CFCRD.0128-03	CompactFlash 128 MB WD
5CFCRD.0256-03	CompactFlash 256 MB WD
5CFCRD.0512-03	CompactFlash 512 MB WD
5CFCRD.1024-03	CompactFlash 1024 MB WD
5CFCRD.2048-03	CompactFlash 2048 MB WD
5CFCRD.4096-03	CompactFlash 4096 MB WD
5CFCRD.8192-03	CompactFlash 8192 MB WD

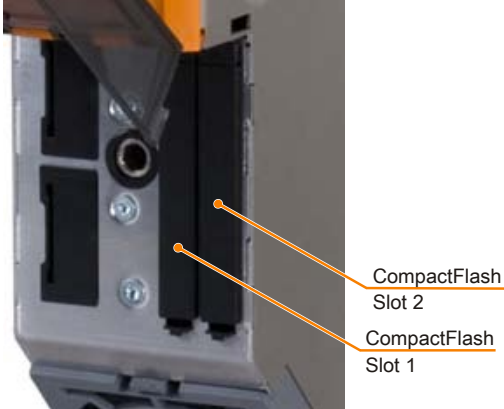

Table 15: CompactFlash slot (CF1)

Warning!

Power must be turned off before inserting or removing CompactFlash cards!

2.5.6 CompactFlash slot 2

This CompactFlash slot is a fixed part of an APC820 system and is internally connected with the chipset via IDE PATA. Type I CompactFlash cards are supported. The CompactFlash slots are located behind the cable cover.

CompactFlash slot (CF2)	
Connection	PATA slave
CompactFlash Type	Type I
Model number	Short description
CompactFlash	
5CFCRD.0512-06	B&R CompactFlash 512 MB
5CFCRD.1024-06	B&R CompactFlash 1024 MB
5CFCRD.2048-06	B&R CompactFlash 2048 MB
5CFCRD.4096-06	B&R CompactFlash 4096 MB
5CFCRD.8192-06	B&R CompactFlash 8192 MB
5CFCRD.016G-06	B&R CompactFlash 16 GB
5CFCRD.0064-03	CompactFlash 64 MB WD
5CFCRD.0128-03	CompactFlash 128 MB WD
5CFCRD.0256-03	CompactFlash 256 MB WD
5CFCRD.0512-03	CompactFlash 512 MB WD
5CFCRD.1024-03	CompactFlash 1024 MB WD
5CFCRD.2048-03	CompactFlash 2048 MB WD
5CFCRD.4096-03	CompactFlash 4096 MB WD
5CFCRD.8192-03	CompactFlash 8192 MB WD

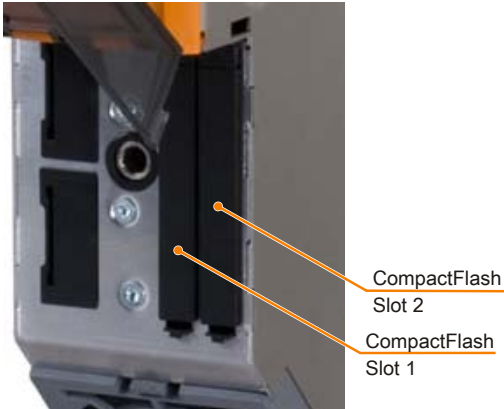

Table 16: CompactFlash slot (CF2)

Warning!

Power must be turned off before inserting or removing CompactFlash cards!

2.5.7 COM1 serial interface

COM1 serial interface ¹⁾	
RS232	
Type	RS232, modem-capable, not electrically isolated
UART	16550-compatible, 16-byte FIFO
Transfer rate	Max. 115 kbit/s
Bus length	Max. 15 m
Pin	Assignment
1	DCD
2	RXD
3	TXD
4	DTR
5	GND
6	DSR
7	RTS
8	CTS
9	RI

9-pin male DSUB connector

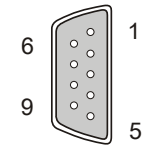

Table 17: COM1 - Pinout

1) The interfaces, etc. available on the device or module have been numbered as such for easy identification. This numbering may differ from that used by the particular operating system.

2.5.7.1 RS232 - Bus length and cable type

The maximum transfer rate of 115 kbit/s depends on the cable type being used.

Extension	Transfer rate
≤15 m	Typ. 64 kbit/s
≤10 m	Typ. 115 kbit/s
≤5 m	Typ. 115 kbit/s

Table 18: RS232 - Bus length and transfer rate

The material used for the cable should have all or most of the following properties in order to achieve an optimal transfer rate.

RS232 cables	Property
Signal lines	
Cable cross section	4x 0.16 mm ² (26 AWG), tinned copper stranded wire
Wire insulation	PE
Conductor resistance	≤82 Ω/ km
Stranding	Wires stranded in pairs
Shield	Paired shield with aluminum foil
Grounding line	
Cable cross section	1x 0.34 mm ² (22 AWG / 19), tinned copper stranded wire
Wire insulation	PE
Conductor resistance	≤59 Ω/km
Outer sheathing	
Material	PUR mixture
Features	Halogen-free
Complete shielding	From tinned copper wires

Table 19: RS232 - Cable requirements

2.5.8 COM2 serial interface

COM2 serial interface ¹⁾			
	RS232	RS422/485	
Type	RS232; not modem-capable; electrically isolated		
UART	16550-compatible, 16-byte FIFO		
Transfer rate	Max. 115 kbit/s		
Bus length	Max. 15 m	Max. 1200 m	
Pin	RS232 - Pinout	RS422 - Pinout	
1	N.C.	TXD	
2	RXD	N.C.	
3	TXD	N.C.	
4	N.C.	TXD	
5	GND	GND	
6	N.C.	RXD	
7	RTS	N.C.	
8	CTS	N.C.	
9	N.C.	RXD	

9-pin male DSUB connector

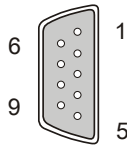

Table 20: COM2 - Pinout

1) The interfaces, etc. available on the device or module have been numbered as such for easy identification. This numbering may differ from that used by the particular operating system.

2.5.8.1 I/O address and IRQ

Resource	Default setting	Additional setting options
I/O address	2E8h	238, 2F8, 338, 3E8, 3F8
IRQ	IRQ10	IRQ 3, 4, 5, 7, 11, 12

Table 21: RS232/422/485 - I/O address and IRQ

The setting for the I/O address and IRQ can be changed in BIOS Setup (Advanced - Baseboard/Panel features - "Legacy Devices" on page 120 - COM B). It is possible for conflicts with other resources to occur when changing this setting.

2.5.8.2 RS232 - Bus length and cable type

The maximum transfer rate of 115 kbit/s depends on the cable type being used.

Extension	Transfer rate
≤15 m	Typ. 64 kbit/s
≤10 m	Typ. 115 kbit/s
≤5 m	Typ. 115 kbit/s

Table 22: RS232 - Bus length and transfer rate

The material used for the cable should have all or most of the following properties in order to achieve an optimal transfer rate.

RS232 cables	Property
Signal lines	
Cable cross section	4x 0.16 mm ² (26 AWG), tinned copper stranded wire
Wire insulation	PE
Conductor resistance	≤82 Ω/ km
Stranding	Wires stranded in pairs
Shield	Paired shield with aluminum foil
Grounding line	
Cable cross section	1x 0.34 mm ² (22 AWG / 19), tinned copper stranded wire
Wire insulation	PE
Conductor resistance	≤59 Ω/km
Outer sheathing	
Material	PUR mixture
Features	Halogen-free
Complete shielding	From tinned copper wires

Table 23: RS232 - Cable requirements

2.5.8.3 RS422 - Bus length and cable type

The RTS line must be switched on to switch the transmitter to active.

The maximum transfer rate of 115 kbit/s depends on the type of cable being used.

Extension	Transfer rate
1200 m	Typ. 115 kbit/s

Table 24: RS422 - Bus length and transfer rate

The material used for the cable should have all or most of the following properties in order to achieve an optimal transfer rate.

RS422 cable	Property
Signal lines	
Cable cross section	4x 0.25 mm ² (24 AWG / 19), tinned copper stranded wire
Wire insulation	PE
Conductor resistance	≤82 Ω/km
Stranding	Wires stranded in pairs
Shield	Paired shield with aluminum foil
Grounding line	
Cable cross section	1x 0.34 mm ² (22 AWG / 19), tinned copper stranded wire
Wire insulation	PE
Conductor resistance	≤59 Ω/km
Outer sheathing	
Material	PUR mixture
Features	Halogen-free
Complete shielding	From tinned copper wires

Table 25: RS422 - Cable requirements

2.5.8.4 When operated as an RS485 interface

When operated in this mode, the pins of the RS422 default interface (1, 4, 6 and 9) must be used. Pins should be connected as shown.

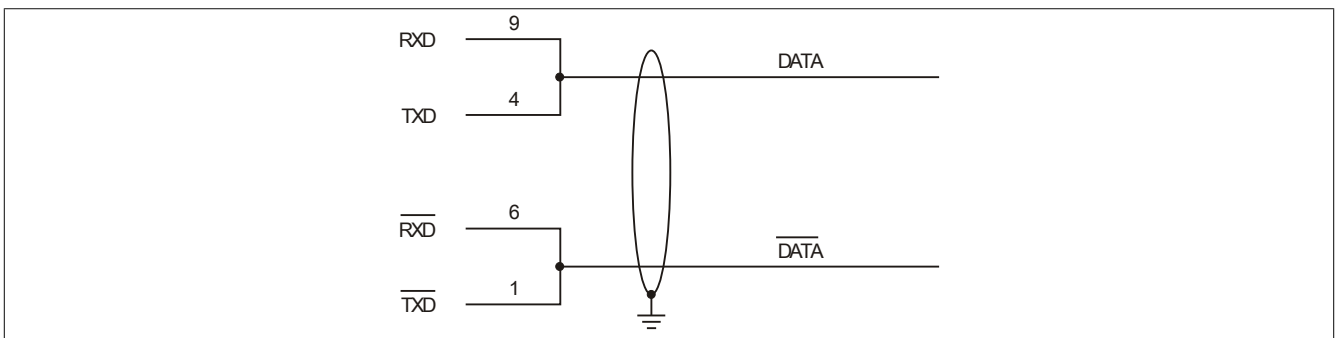

Figure 6: RS232/RS422/RS485 interface - Operation in RS485 mode

The RTS line must be switched by the driver for each transmission or reception; there is no automatic switch-back mechanism. This cannot be configured in Windows.

The voltage drop resulting from long cable lengths can lead to greater potential differences between bus stations, which can hinder communication. This can be improved by running ground wire with the others.

The line ends of the RS485 interface should (at least for longer line lengths or larger transfer rates) be closed. Normally, a passive terminator can be used on the bus ends by connecting each of the signal lines with a 120 Ω resistor.

2.5.8.5 RS485 - Bus length and cable type

The maximum transfer rate of 115 kbit/s depends on the type of cable being used.

Extension	Transfer rate
1200 m	Typ. 115 kbit/s

Table 26: RS485 - Bus length and transfer rate

The material used for the cable should have all or most of the following properties in order to achieve an optimal transfer rate.

RS485 cables	Property
Signal lines Cable cross section Wire insulation Conductor resistance Stranding Shield	4x 0.25 mm ² (24 AWG / 19), tinned copper stranded wire PE ≤82 Ω/km Wires stranded in pairs Paired shield with aluminum foil
Grounding line Cable cross section Wire insulation Conductor cross section	1x 0.34 mm ² (22 AWG / 19), tinned copper stranded wire PE ≤59 Ω/km
Outer sheathing Material Features Complete shielding	PUR mixture Halogen-free From tinned copper wires

Table 27: RS485 - Cable requirements

2.5.9 CAN

CAN ¹⁾	
The electrically isolated CAN bus interface is a 4-pin connector.	
Transfer rate	Max. 500 kbit/s
Bus length	Max. 1000 m
Pin	CAN bus
1	CAN bus
2	CAN _⊥ (CAN ground)
3	CAN_L (CAN Low)
4	SHLD (shield)

4-pin male connector



Table 28: CAN interface

1) The interfaces, etc. available on the device or module have been numbered as such for easy identification. This numbering may differ from that used by the particular operating system.

2.5.9.1 Driver support

The fieldbus interface CAN is only supported together with Automation Runtime.

2.5.9.2 CAN node switch

CAN node switch (x1, x16)		
Both of these hex switches (x1, x16) are used to configure the node number for the CAN interface. The node switch is located behind the front cover. The front cover must first be slid down to change the node switch.		
Switch position		
x1	x16	Description
0...F	0...F	Any



Table 29: CAN node switch (x1, x16)

2.5.9.3 CAN terminating switch / LED

CAN terminating switch / LED		
CAN networks are cabled using a bus structure where both ends of the bus are equipped with terminating resistors. The B&R industrial PC has an integrated terminating resistor (delivery state: disabled with the setting "Off").		
LED	On	Off
Yellow	Terminating resistor integrated in the bus controller switched on	Terminating resistor integrated in the bus controller switched off
CAN terminating switch	On position	Off position
Can be pressed using a pointed object.	Terminating resistor is turned on.	Terminating resistor is turned off.

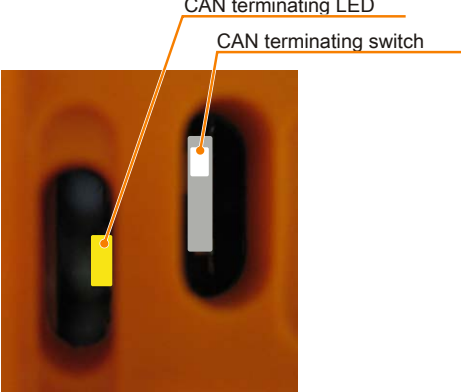

Table 30: CAN terminating switch / LED

2.5.9.4 CAN Status LED

Status LED CAN		
Yellow LED for	On	Off
CAN	Sending data	Receiving data



Table 31: Status LED CAN

2.5.10 POWERLINK

POWERLINK interface ¹⁾		
Cabling	S/STP (Cat 5e)	
Cable length	Max. 100 m (min. Cat 5e)	
Speed LED	On	Off
Green/Red	See Status/Error LED.	
Link LED	On	Blinking
Yellow	Link (POWERLINK network connection available)	Activity (blinking - data transfer in progress)

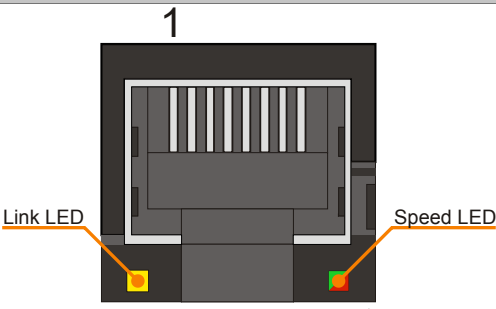

Table 32: POWERLINK interface

1) The interfaces, etc. available on the device or module have been numbered as such for easy identification. This numbering may differ from that used by the particular operating system.

2.5.10.1 Status/Error LED

The Status/Error LED is a green and red dual LED. The LED status can have different meanings depending on the operating mode.

2.5.10.1.1 Ethernet mode

In this mode, the interface is operated as an Ethernet interface.

Green - Status	Description
On	Interface being operated as an Ethernet interface

Table 33: Status/Error LED - Ethernet mode

2.5.10.1.2 POWERLINK V1

LED status indicators		Status of the POWERLINK station
Green	Red	
On	Off	The POWERLINK station is running with no errors.
Off	On	A fatal system error has occurred. The error type can be read using the PLC logbook. An irreparable problem has occurred. The system cannot properly carry out its tasks. This state can only be changed by resetting the module.
Blinking alternately		The POWERLINK managing node has failed. This error code can only occur when operated as a controlled node.
Off	Blinking	System failure. The red blinking LED signals a certain type of error using a blink code (see section "System stop error codes" on page 38).

Table 34: Status/Error LED - POWERLINK V1 operating mode

2.5.10.1.3 POWERLINK

Red - Error	Description
On	<p>The interface is in an error state (failed Ethernet frames, increased number of collisions on the network, etc.). If an error occurs in the following states, then the green LED blinks over the red LED:</p> <ul style="list-style-type: none"> BASIC_ETHERNET PRE_OPERATIONAL_1 PRE_OPERATIONAL_2 READY_TO_OPERATE 

Table 35: Status/Error LED - POWERLINK - Error

Green - Status	Description
Off NOT_ACTIVE	<p>Mode The interface is in NOT_ACTIVE mode or:</p> <ul style="list-style-type: none"> Switched off Starting up Not configured correctly in Automation Studio Defective <p>Managing node (MN) The bus is being monitored for POWERLINK frames. If a frame is not received within the configured time window (timeout), the interface switches immediately to PRE_OPERATIONAL_1 mode (single flash). If POWERLINK communication is detected before the time expires, however, then the MN will not be started.</p> <p>Controlled node (CN) The bus is being monitored for POWERLINK frames. If a corresponding frame is not received within the defined time frame (timeout), then the module switches immediately to BASIC_ETHERNET mode (flickering). If POWERLINK communication is detected before this time expires, however, the interface switches immediately to PRE_OPERATIONAL_1 mode (single flash).</p>
Green flickering (approx. 10 Hz) BASIC_ETHERNET	<p>Mode The interface is in BASIC_ETHERNET mode and being operated as an Ethernet TCP/IP interface.</p> <p>Managing node (MN) This state can only be exited by resetting the interface.</p> <p>Controlled node (CN) If POWERLINK communication is detected while in this state, the interface switches to the PRE_OPERATIONAL_1 state (single flash).</p>
Single flash (approx. 1 Hz) PRE_OPERATIONAL_1	<p>Mode The interface is in PRE_OPERATIONAL_1 mode.</p> <p>Managing node (MN) The MN starts "reduced cycle" operation. Cyclic communication is not yet taking place.</p> <p>Controlled node (CN) The module can be configured by the MN in this state. The CN waits until it receives an SoC frame and then switches to the PRE_OPERATIONAL_2 state (double flash). An LED lit red in this state indicates failure of the MN.</p>
Double flash (approx. 1 Hz) PRE_OPERATIONAL_2	<p>Mode The interface is in the PRE_OPERATIONAL_2 state.</p> <p>Managing node (MN) The MN begins cyclic communication (cyclic input data is not yet being evaluated). The CNs are configured in this state.</p> <p>Controlled node (CN) The interface can be configured by the MN in this state. A command then switches the state to READY_TO_OPERATE (triple flash). An LED lit red in this mode indicates failure of the MN.</p>
Triple flash (approx. 1 Hz) READY_TO_OPERATE	<p>Mode The interface is in the READY_TO_OPERATE state.</p> <p>Managing node (MN) Cyclic and asynchronous communication is taking place. Any received PDO data is ignored.</p> <p>Controlled node (CN) The configuration of the module is completed. Normal cyclic and asynchronous communication is taking place. The PDO data being sent corresponds to the PDO mapping. Cyclic data is not yet being evaluated, however. An LED lit red in this mode indicates failure of the MN.</p>
On OPERATIONAL	<p>Mode The interface is in OPERATIONAL mode. PDO mapping is active and cyclic data is being evaluated.</p>
Blinking (approx. 2.5 Hz) STOPPED	<p>Mode The interface is in STOPPED mode.</p> <p>Managing node (MN) This status is not possible for the MN.</p> <p>Controlled node (CN) No output data is being produced, and no input data is being received. It is only possible to enter or leave this mode after the MN has given the appropriate command.</p>

Table 36: Status/Error LED - POWERLINK - Status

2.5.10.1.4 System stop error codes

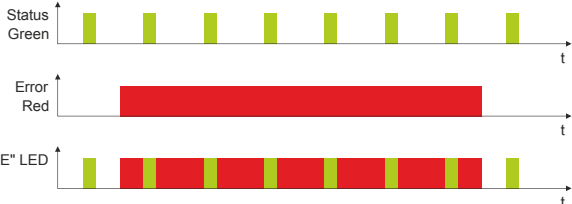
Incorrect configuration or defective hardware can cause a system stop error.

The error code is indicated by the red Error LED using four switch-on phases. Each switch-on phase has a duration of either 150 ms or 600 ms. The error code is repeated every 2 seconds.

Error description	Error code indicated by red Status LED									
RAM error: The interface is defective and must be replaced.	•	•	•	-	Pause	•	•	•	-	Pause
Hardware error: The interface or a system component is defective and must be replaced.	-	•	•	-	Pause	-	•	•	-	Pause

Table 37: System stop error codes

Key	•	...150 ms
	-	...600 ms
	Pause	2 second delay

2.5.10.2 POWERLINK node switch

POWERLINK node switch (x1, x16)		
<p>Both of these hex switches (x16, x1) are used to configure the station number for the POWERLINK. Station numbers are permitted between #00 and #FD. The node switch is located behind the front cover. The front cover must first be slid down to change the node switch.</p>		
Switch position		
x1	x16	Description
0	0	Operation as managing node
0...D	1...F	station number Operation as controlled node
E	F	Reserved
F	F	Reserved



Table 38: POWERLINK node switch (x1, x16)

2.5.11 Ethernet 1 (ETH1)

This Ethernet controller is integrated in the CPU board and connected to external devices via the system unit.

Ethernet 1 interface (ETH1 ¹⁾)		
Controller	Realtek RTL8111B/C ¹⁾	
Cabling	S/STP (Cat5e)	
Transfer rate	10/100/1000 Mbit/s ²⁾	
Cable length	Max. 100 m (min. Cat5e)	
Speed LED	On	Off
Green	100 Mbit/s	10 Mbit/s ³⁾
Orange	1000 Mbit/s	-
Link LED	On	Off
Orange	Link (Ethernet network connection available)	Activity (blinking - data transfer in progress)

Table 39: Ethernet connection (ETH1)

- 1) The interfaces, etc. available on the device or module have been numbered as such for easy identification. This numbering may differ from that used by the particular operating system.
- 2) The Realtek 8111B is integrated in the CPU boards 5PC800.B945-00, -01, -02, -03 and -04. The Realtek 8111C is integrated in the CPU boards 5PC800.B945-10, -11, -12, -13 and -14.
- 3) Switching takes place automatically.
- 4) The 10 Mbit/s transfer speed / connection is only present if the Link LED is also lit at the same time.

Driver support

A special driver is required in order to operate the Realtek RTL8111B/C Ethernet controller. Drivers for approved operating systems are available in the Downloads area of the B&R website (www.br-automation.com).

Information:

Required drivers can only be downloaded from the B&R website, not from manufacturer websites.

2.5.12 Ethernet 2 (ETH2)

This Ethernet controller is integrated in the mainboard and connected to external devices via the system unit.

Ethernet 2 interface (ETH2 ¹⁾)		
Controller	Intel 82574	
Cabling	S/STP (Cat 5e)	
Transfer rate	10/100/1000 Mbit/s ²⁾	
Cable length	Max. 100 m (min. Cat 5e)	
Speed LED	On	Off
Green	100 Mbit/s	10 Mbit/s ³⁾
Orange	1000 Mbit/s	-
Link LED	On	Off
Orange	Link (Ethernet network connection available)	Activity (blinking - data transfer in progress)

Table 40: Ethernet interface (ETH2)

- 1) The interfaces, etc. available on the device or module have been numbered as such for easy identification. This numbering may differ from that used by the particular operating system.
- 2) Switching takes place automatically.
- 3) The 10 Mbit/s transfer speed / connection only exists if the Link LED is also lit at the same time.

Driver support

A special driver is required in order to operate the Intel 82574 Ethernet controller. Drivers for approved operating systems are available in the Downloads section of the B&R website (www.br-automation.com).

Information:

Required drivers can only be downloaded from the B&R website, not from manufacturer websites.

2.5.13 Battery

The lithium battery (3 V, 950 mAh) buffers the internal real-time clock (RTC), individually stored BIOS settings and SRAM data. It is located behind the black cover on the front of the device. The battery's buffer lifespan is at least 2½ years (at 50°C, 8.5 µA for the components being supplied and a self-discharge of 40%). The battery has a limited service life and should be replaced regularly (after the specified service life at the latest).

The battery is located behind the cable cover.

Battery	
Battery Type	Renata 950 mAh
Removable	Yes, accessible from the outside
Service life	2½ years ¹⁾
Model number	Short description
	Batteries
0AC201.91	Lithium batteries, 4 pcs., 3 V / 950 mAh, button cell
4A0006.00-000	Lithium battery, 1 pc., 3 V / 950 mAh, button cell

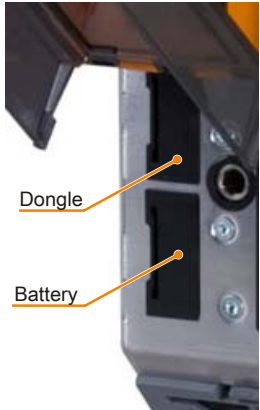

Table 41: Battery

1) At 50°C, 8.5 µA of the supplied components and a self-discharge of 40%.

Evaluating the battery status

The status of the battery is determined immediately after the device is started and subsequently checked by the system every 24 hours. During this measurement, the battery is subjected to a brief load (approximately 1 second) and then evaluated. Once determined, the battery status is displayed in BIOS (Advanced - OEM features - System board features - Voltage values) and in the B&R Control Center (ADI driver); it can also be read in a customer application using the ADI library.

Battery status	Function
N/A	The hardware or firmware being used is too old and does not support reading the battery status.
GOOD	Data buffering is intact.
BAD	From the point when battery capacity is recognized as insufficient (BAD), data buffering is intact for approximately another 500 hours.

Table 42: Battery status

From the point when battery capacity is recognized as insufficient, data buffering is intact for approximately another 500 hours. When replacing the battery, data is buffered for approximately 10 minutes by a gold leaf capacitor.

2.5.14 Hardware security key (dongle)

B&R recommends a hardware security key (dongle) based on the DS1425 from MAXIM (previously Dallas Semiconductors) for software copy protection.

The hardware security key is located behind the cable cover.

Hardware security key	
<p>A hardware security key (dongle) can be inserted behind the black cover.</p>	

Table 43: Hardware security key

Warning!

Turn off power before removing or adding the hardware security key.

2.5.15 LED status indicators

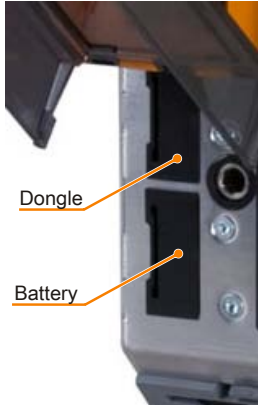
The status LEDs are used to indicate the following states on the APC820:

LED status indicators			
LED	Color	Status	Significance
Power	Green	On	Supply voltage OK
	Red	On	System in standby mode (S5: Soft-off mode or S4: Hibernation mode suspend-to-disk)
	Red / green	Blinking	Service function for MTCX upgrade: A red/green blinking power LED indicates a faulty or incomplete MTCX upgrade. The MTCX runs using the firmware version installed when delivered. This could be caused by a power failure during an MTCX upgrade. An MTCX upgrade must be performed again.
CF	Yellow	On	Indicates access to CompactFlash (read or write)
Link	Yellow	On	Indicates an active SDL connection on the monitor/panel interface
		Blinking	Indicates that an active SDL connection has been interrupted by a loss of power to the display unit
Run	Green	On	Application running
	Red	On	Service mode
		Blinking	Indicates a licensing violation
	Yellow	On	User LED



Table 44: LED status indicators - Data

The light for the Status LEDs is fed to the front cover via fiber optic lines.

2.5.16 CMOS Profile switch

The CMOS profile switch is located behind the front cover.

CMOS profile switch	
Different BIOS default value profiles can be specified using the 16-position CMOS profile switch.	
Switch position	Description
0	Profile 0: Reserved for default profile
1	Profile 1: Optimized for system units 5PC810.SX01-00, 5PC810.SX02-00 and 5PC810.SX03-00
2	Profile 2: Optimized for system unit 5PC810.SX05-00
3	Profile 3: Optimized for system units 5PC820.SX01-00 and 5PC820.SX01-01
4	Profile 4: Reserved
5	Profile 5: 5PC820.1505-00 and 5PC820.1906-00

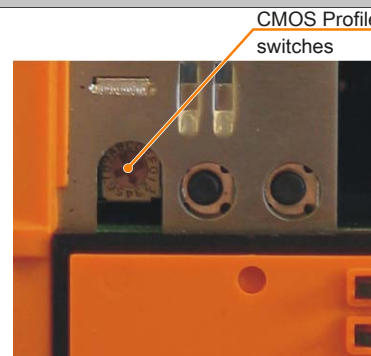

Table 45: CMOS profile switch

Information:

The factory default switch position represents the optimal BIOS default values for this system and should therefore not be changed.

The position of the CMOS profile switch is displayed in BIOS Setup and in the B&R ADI Control Center.

2.5.17 Power button

The power button provides a wide range of ATX power supply functions. The power button is located behind the front cover.

Power button	
<p>The power button can be pressed with a pointed object (e.g. paper clip or tip of a pen).</p> <p>The power button acts like the on/off switch on a normal desktop PC with an ATX power supply:</p> <p>Press and release ... Switches on the APC820 or shuts down the operating system and switches off the APC820</p> <p>Press and hold ... Switches off the ATX power supply without shutting down the APC820 (data could be lost!)</p> <p>Pressing the power button does not reset the MTCX processor.</p>	

Table 46: Power button

2.5.18 Reset button

The power button is located behind the front cover.

Reset button	
<p>The reset button can be pressed with a pointed object (i.e. paper clip or tip of a pen).</p> <p>Pushing the reset button triggers a hardware and PCI reset. The APC820 is restarted (cold restart).</p> <p>Pressing the reset button does not reset the MTCX processor.</p>	

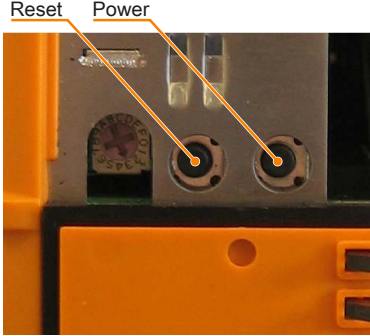
Table 47: Reset button

Warning!

A system reset can result in lost data!

3 Individual components

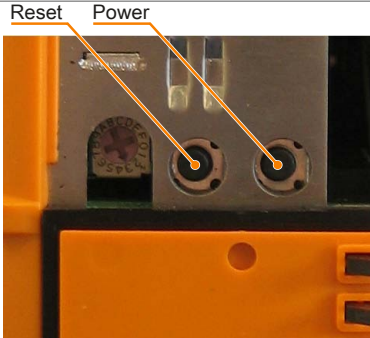
3.1 System units

3.1.1 Interfaces

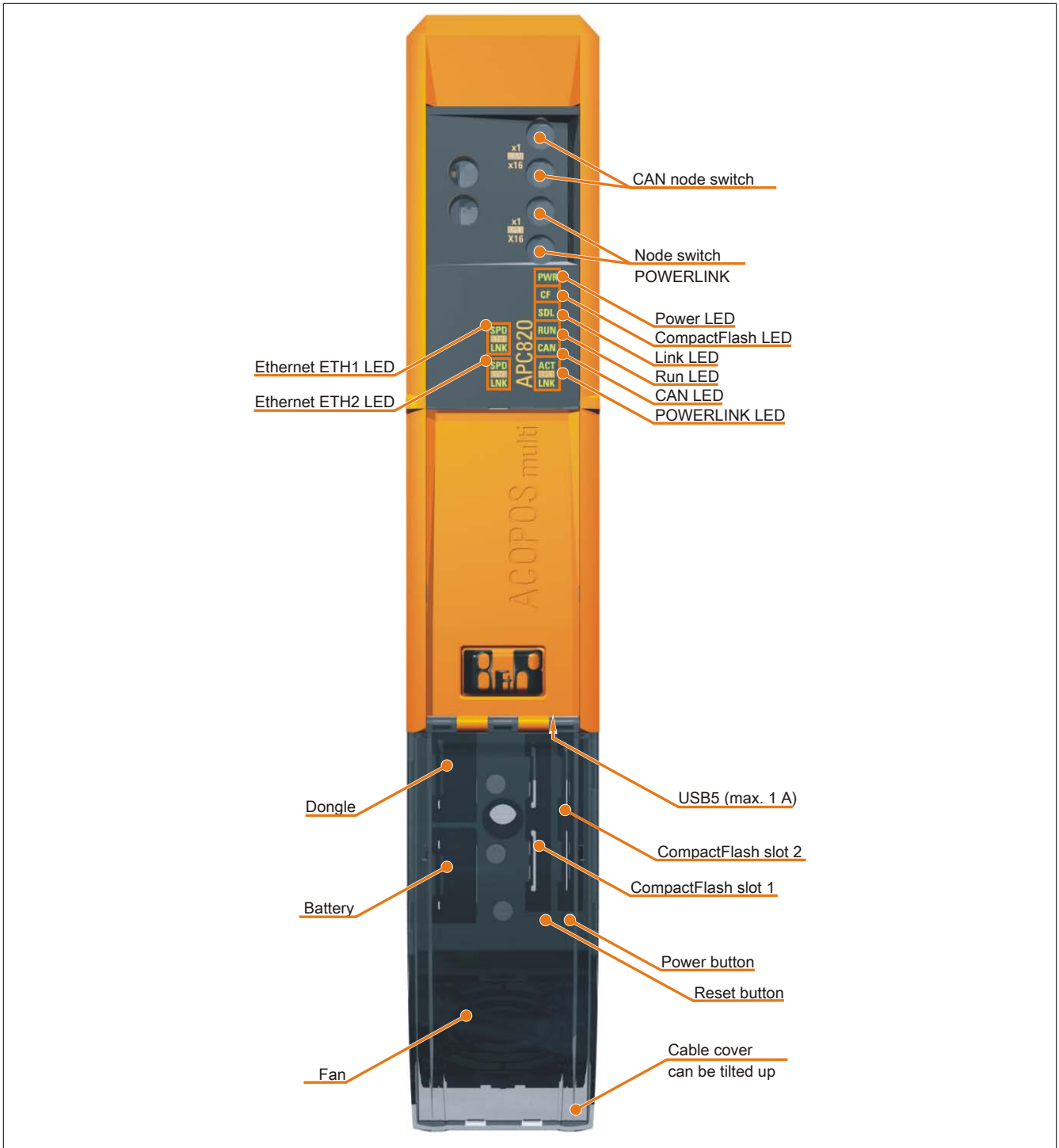

Figure 7: APC820 interface overview - Front side ≤ A0



Figure 8: APC820 interface overview - Front side \geq A1

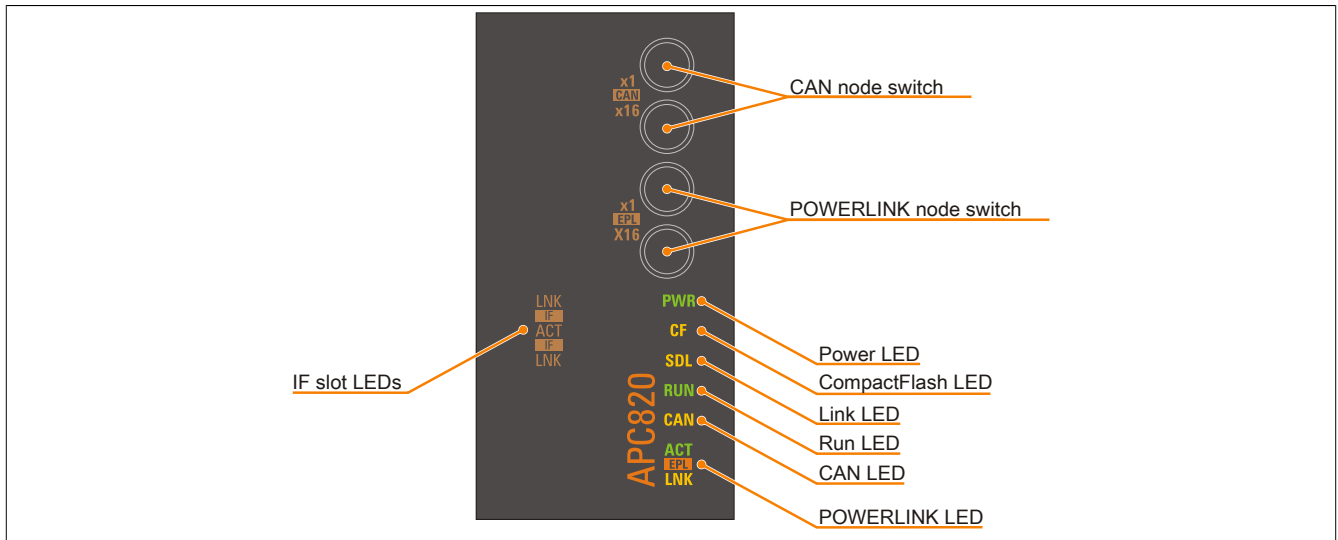

Figure 9: APC820 LED description - Front side ≥ A1

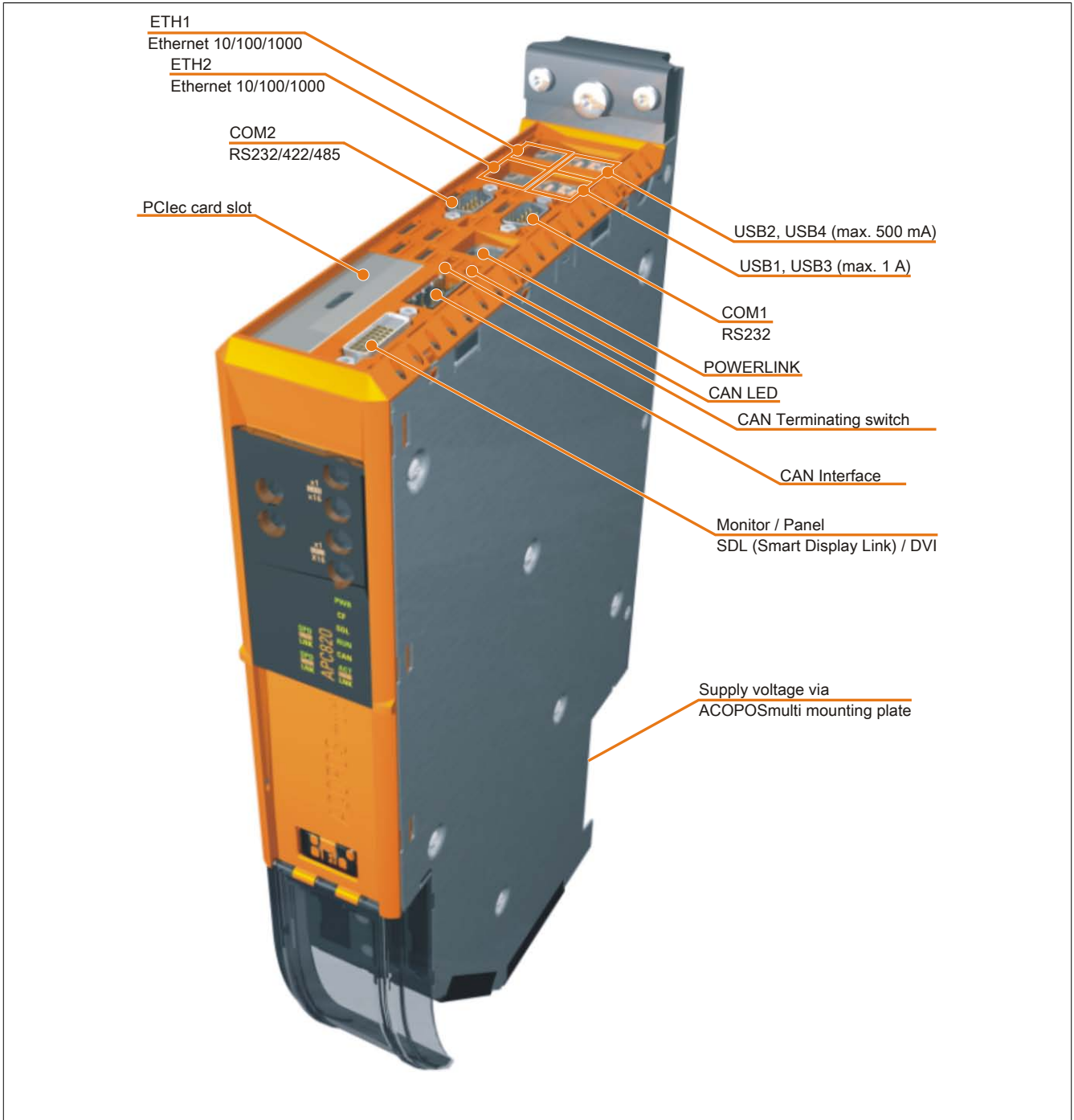

Figure 10: APC820 interface overview - Top side ≤ A0

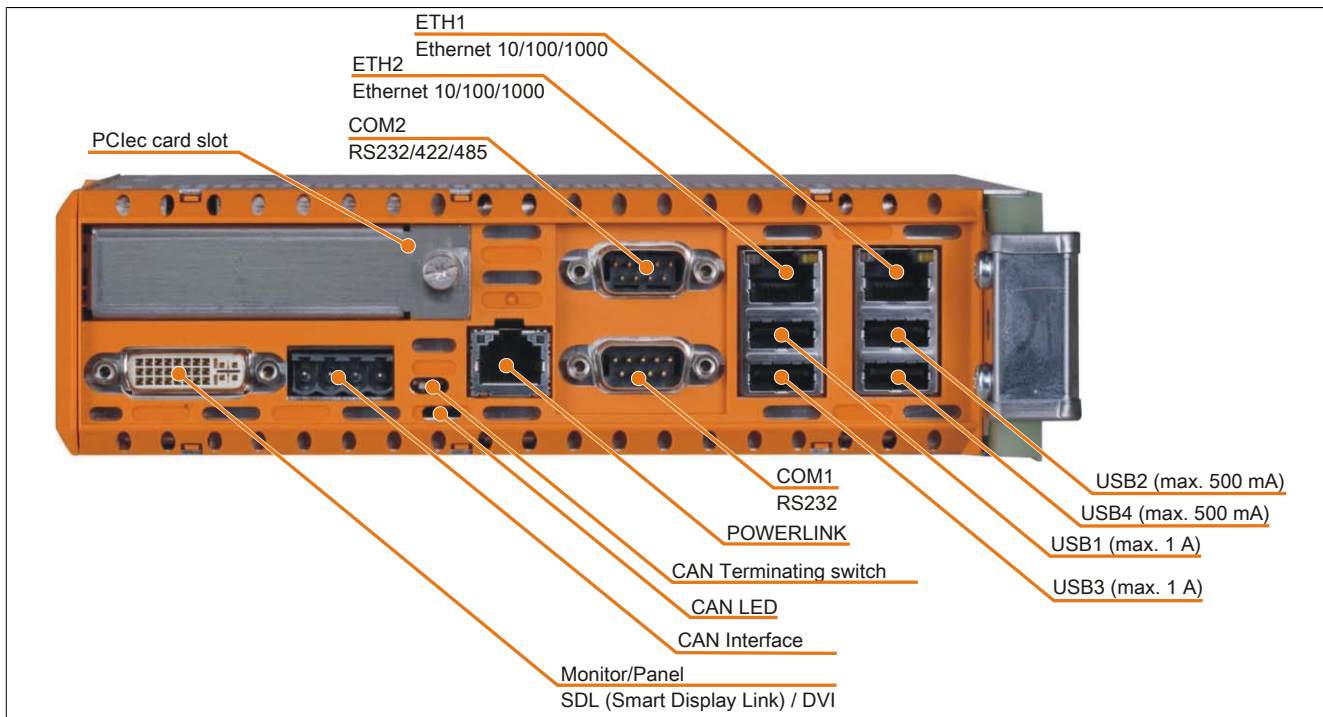

Figure 11: APC820 interface overview - Top side ≥ A1

3.1.2 5PC820.SX01-00

3.1.2.1 General information

- Specially developed to operate together with ACOPOSmulti
- Cold plate or feed-through mounting
- 1 PCI Express compact slot
- SRAM, 1 MB onboard
- Integrated POWERLINK and CAN fieldbus interfaces

3.1.2.2 Order data

Model number	Short description	Figure
System units		
5PC820.SX01-00	APC820 system unit, cold plate mounting, 1 PCIe card slot; 2x CompactFlash slot, 1x RS232, 1x RS232/422/485, 1x POWERLINK, 1x CAN, Smart Display Link/DVI/Monitor, 5x USB 2.0, 2x ETH 10/100/1000, 24 VDC over the ACOPOSmulti busbar.	
Required accessories		
CPU boards		
5PC800.B945-10	Intel Core Duo L2400 CPU board, 1.66 GHz, dual core, 667 MHz FSB, 2 MB L2 cache; 945GME chipset; 2 slots for SO-DIMM DDR2 modules (max. total of 3 GB), Realtek RTL8111C Ethernet controller	
5PC800.B945-11	Intel Core2 Duo L7400 CPU board, 1.5 GHz, dual core, 667 MHz FSB, 4 MB L2 cache; 945GME chipset; 2 slots for SO-DIMM DDR2 modules (max. total of 3 GB), Realtek RTL8111C Ethernet controller	
5PC800.B945-12	Intel Core2 Duo U7500 CPU board, 1.06 GHz, dual core, 533 MHz FSB, 2 MB L2 cache; 945GME chipset; 2 slots for SO-DIMM DDR2 modules (max. total of 3 GB), Realtek RTL8111C Ethernet controller	
5PC800.B945-13	Intel Celeron M 423 CPU board, 1.06 GHz, single core, 533 MHz FSB, 1 MB L2 cache; 945GME chipset; 2 slots for SO-DIMM DDR2 modules (max. total of 3 GB), Realtek RTL8111C Ethernet controller	
5PC800.B945-14	Intel Core2 Duo T7400 CPU board, 2.16 GHz, dual core, 667 MHz FSB, 4 MB L2 cache; 945GME chipset; 2 slots for SO-DIMM DDR2 modules (max. total of 3 GB), Realtek RTL8111C Ethernet controller	
Heat sinks		
5AC802.HS00-00	APC820 power supply and heat sink for CPU boards with Dual Core processors L2400, L7400, U7500 and Celeron M 423.	
5AC802.HS00-01	APC820 power supply with heat sink for CPU boards with dual-core processor T7400.	
Main memory		
5MMDDR.0512-01	SO-DIMM DDR2 RAM 512 MB PC2-5300	
5MMDDR.1024-01	SO-DIMM DDR2 RAM 1024 MB PC2-5300	
5MMDDR.2048-01	SO-DIMM DDR2 RAM 2048 MB PC2-5300	
Optional accessories		
Fan modules		
8BXF001.0000-00	ACOPOSmulti fan module, replacement fan for ACOPOSmulti modules (8BVP / 8B0C / 8BVI / 8BVE / 8B0K)	
Interface cards		
5ACPCC.ETH0-00	PCIe Ethernet card 1x 10/100/1000 For APC820 and PPC800.	
5ACPCC.MPL0-00	PCIe POWERLINK card, 2 POWERLINK interfaces, 512 kB SRAM; for APC820 and PPC800.	

Table 48: 5PC820.SX01-00 - Order data

3.1.2.3 Technical data

Product ID	5PC820.SX01-00
General information	
Dongle port	Yes
LEDs	Power, CF, Link, Run, CAN, POWERLINK, IF slot
B&R ID code	0xA7DE
Battery	
Type	Renata 950 mAh
Service life	2 years ¹⁾
Removable	Yes, accessible behind the cable cover
Execution	Lithium Ion
Power button	Yes
Reset button	Yes

Table 49: 5PC820.SX01-00 - Technical data

Technical data • Individual components

Product ID	5PC820.SX01-00
Buzzer	Yes
Cooling and mounting method	Cold plate or feed-through mounting
Certification	
CE	Yes
cULus	Yes
GOST-R	Yes
Controller	
Boot loader	BIOS
Cooling	Passive via heat sink and supported with an active fan kit
Real-time clock	
Precision	At 25°C: typ. 12 ppm (1 seconds) per day ²⁾
Battery backed	Yes
Power failure logic	
Controller	MTCX ³⁾
Buffer time	10 ms
Graphics	
Controller	Intel® Graphics Media Accelerator 950
SRAM	
Value	1 MB
Battery backed	Yes
Remanent variables in power failure mode	192 kB (e.g. for Automation Runtime, see AS help documentation)
Memory	
Type	DDR2 SDRAM
Memory size	Max. 3 GB
Interfaces	
COM1	
Type	RS232, modem-capable, not electrically isolated
Execution	9-pin male DSUB connector
UART	16550-compatible, 16-byte FIFO
Max. baud rate	115 kbit/s
COM2	
Type	RS232/422/485, electrically isolated
Execution	9-pin male DSUB connector
UART	16550-compatible, 16-byte FIFO
Max. baud rate	115 kbit/s
CompactFlash slot 1	
Type	Type I
CompactFlash slot 2	
Type	Type I
USB	
Quantity	5
Type	USB 2.0
Connection	To each USB type A interface
Transfer rate	Low speed (1.5 Mbit/s), full speed (12 Mbit/s), high speed (480 Mbit/s)
Current load	Max. 500 mA or 1 A per connection
Ethernet	
Quantity	2
Transfer rate	10/100/1000 Mbit/s
Max. baud rate	1000 Mbit/s
Monitor/Panel interface	
Execution	DVI-I socket
Type	SDL/DVI/Monitor
POWERLINK	
Quantity	1
Node switches	2
Status LED	Yes
CAN	
Quantity	1
Transfer rate	Max. 500 kbit/s
Node switches	Yes
Status LED	Yes
Terminating resistor	Yes, can be activated using a switch
Inserts	
PClec slots	
Quantity	1
Electrical characteristics	
Nominal voltage	24 VDC ±25%
Nominal current	5 A
Starting current	Typ. 7 A, max. 50 A for < 300 µs
Operating conditions	
Height of drop	0.25 m
EN 60529 protection	IP20

Table 49: 5PC820.SX01-00 - Technical data

Product ID	5PC820.SX01-00
Environmental conditions	
Temperature	
Operation	Component-dependent
Storage	-20 to 60°C
Transport	-20 to 60°C
Relative humidity	
Operation	Component-dependent
Storage	Component-dependent
Transport	Component-dependent
Vibration	
Operation	2 to 9 Hz: 0.3 mm amplitude / 9 to 200 Hz: 0.1 g
Storage	2 to 9 Hz: 3.5 mm amplitude / 9 to 200 Hz: 1 g / 200 to 500 Hz: 1.5 g
Transport	2 to 9 Hz: 3.5 mm amplitude / 9 to 200 Hz: 1 g / 200 to 500 Hz: 1.5 g
Altitude	
Operation	Max. 3000 m (component-dependent)
Mechanical characteristics	
Housing ⁴⁾	
Material	Galvanized plate, plastic
Front cover	Polycarbonate, black
Cable cover	Polycarbonate, transparent
Dimensions	
Width	53 mm
Height	344 mm
Depth	205 mm
Weight	Approx. 1850 g

Table 49: 5PC820.SX01-00 - Technical data

- 1) The service life of 1½ years is only valid if an SRAM module is being used. Without an SRAM module, a service life of 2 years can be expected. At 50°C, 8.5 A for the supplied components and a self discharge of 40%.
- 2) At max. specified ambient temperature: typically 58 ppm (5 seconds) - worst-case 220 ppm (19 seconds).
- 3) Maintenance Controller Extended
- 4) Depending on the process or batch, there may be visible deviations in the color and surface structure.

3.1.2.4 Dimensions

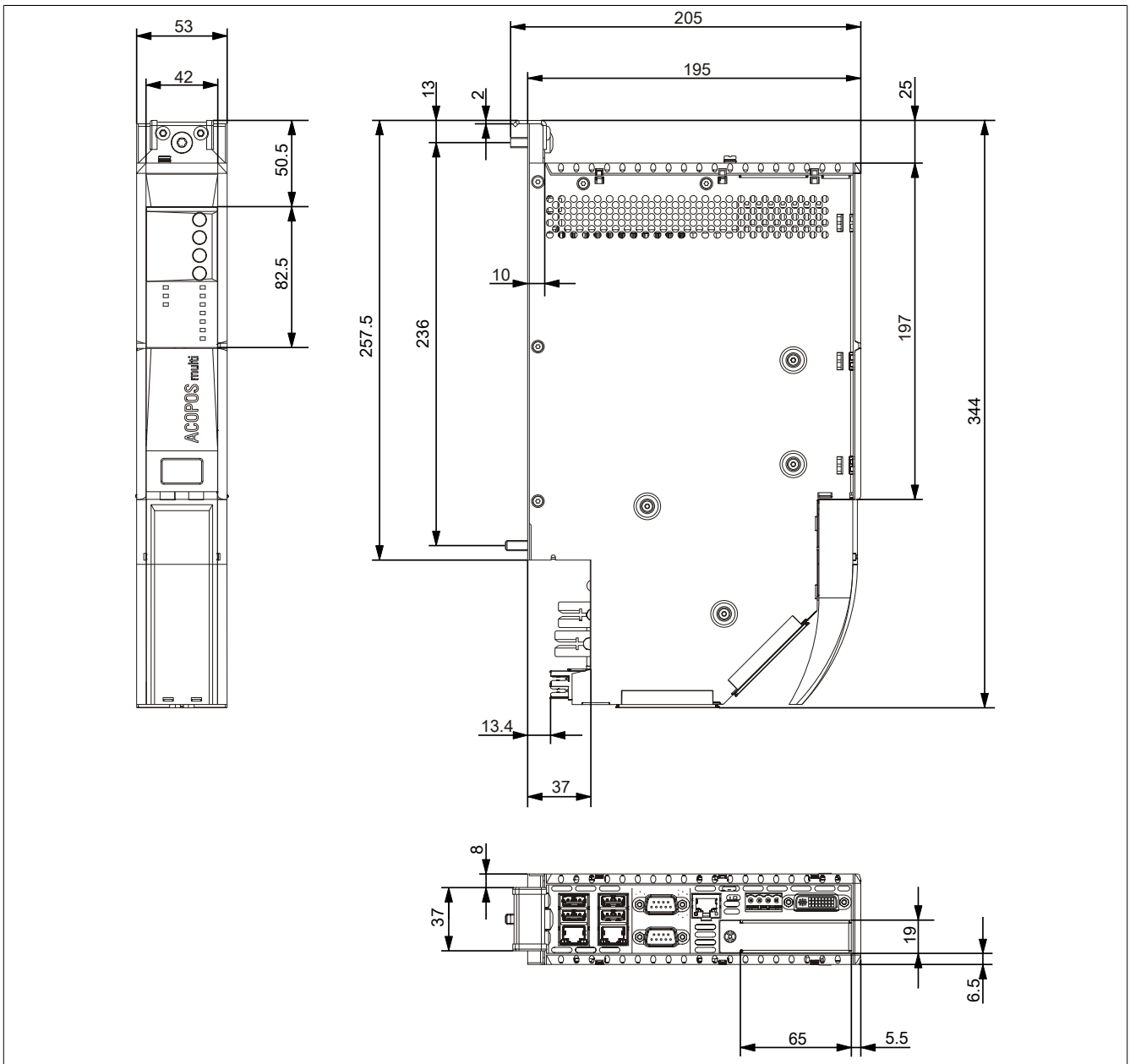

Figure 12: 5PC820.SX01-00 - Dimensions

3.1.3 5PC820.SX01-01

3.1.3.1 General information

- Specially developed to operate together with ACOPOSmulti
- Wall mounting
- 1 PCI Express compact slot
- SRAM, 1 MB onboard
- Integrated POWERLINK and CAN fieldbus interfaces

3.1.3.2 Order data

Model number	Short description	Figure
System units		
5PC820.SX01-01	APC820 system unit, wall mounting, 1 PCIe card slot; 2x CompactFlash slot, 1x RS232, 1x RS232/422/485, 1x POWERLINK, 1x CAN, Smart Display Link/DVI/Monitor, 5x USB 2.0, 2x ETH 10/100/1000, 24 VDC over the ACOPOSmulti busbar.	
Required accessories		
CPU boards		
5PC800.B945-10	Intel Core Duo L2400 CPU board, 1.66 GHz, dual core, 667 MHz FSB, 2 MB L2 cache; 945GME chipset; 2 slots for SO-DIMM DDR2 modules (max. total of 3 GB), Realtek RTL8111C Ethernet controller	
5PC800.B945-11	Intel Core2 Duo L7400 CPU board, 1.5 GHz, dual core, 667 MHz FSB, 4 MB L2 cache; 945GME chipset; 2 slots for SO-DIMM DDR2 modules (max. total of 3 GB), Realtek RTL8111C Ethernet controller	
5PC800.B945-12	Intel Core2 Duo U7500 CPU board, 1.06 GHz, dual core, 533 MHz FSB, 2 MB L2 cache; 945GME chipset; 2 slots for SO-DIMM DDR2 modules (max. total of 3 GB), Realtek RTL8111C Ethernet controller	
5PC800.B945-13	Intel Celeron M 423 CPU board, 1.06 GHz, single core, 533 MHz FSB, 1 MB L2 cache; 945GME chipset; 2 slots for SO-DIMM DDR2 modules (max. total of 3 GB), Realtek RTL8111C Ethernet controller	
5PC800.B945-14	Intel Core2 Duo T7400 CPU board, 2.16 GHz, dual core, 667 MHz FSB, 4 MB L2 cache; 945GME chipset; 2 slots for SO-DIMM DDR2 modules (max. total of 3 GB), Realtek RTL8111C Ethernet controller	
Heat sinks		
5AC802.HS00-00	APC820 power supply and heat sink for CPU boards with Dual Core processors L2400, L7400, U7500 and Celeron M 423.	
5AC802.HS00-01	APC820 power supply with heat sink for CPU boards with dual-core processor T7400.	
Main memory		
5MMDDR.0512-01	SO-DIMM DDR2 RAM 512 MB PC2-5300	
5MMDDR.1024-01	SO-DIMM DDR2 RAM 1024 MB PC2-5300	
5MMDDR.2048-01	SO-DIMM DDR2 RAM 2048 MB PC2-5300	
Optional accessories		
Fan modules		
8BXF001.0000-00	ACOPOSmulti fan module, replacement fan for ACOPOSmulti modules (8BVP / 8B0C / 8BVI / 8BVE / 8B0K)	
Interface cards		
5ACPCC.ETH0-00	PCIe Ethernet card 1x 10/100/1000 For APC820 and PPC800.	
5ACPCC.MPL0-00	PCIe POWERLINK card, 2 POWERLINK interfaces, 512 kB SRAM; for APC820 and PPC800.	

Table 50: 5PC820.SX01-01 - Order data

3.1.3.3 Technical data

Product ID	5PC820.SX01-01
General information	
Dongle port	Yes
LEDs	Power, CF, Link, Run, CAN, POWERLINK, IF slot
B&R ID code	0xAD8A
Battery	
Type	Renata 950 mAh
Service life	2 years ¹⁾
Removable	Yes, accessible behind the cable cover
Execution	Lithium Ion
Power button	Yes
Reset button	Yes

Table 51: 5PC820.SX01-01 - Technical data

Product ID	5PC820.SX01-01
Buzzer	Yes
Cooling and mounting method	Wall mounting
Certification	
CE	Yes
cULus	Yes
GOST-R	Yes
Controller	
Boot loader	BIOS
Cooling	Passive via heat sink and supported with an active fan kit
Real-time clock	
Precision	At 25°C: typ. 12 ppm (1 seconds) per day ²⁾
Battery backed	Yes
Power failure logic	
Controller	MTCX ³⁾
Buffer time	10 ms
Graphics	
Controller	Intel® Graphics Media Accelerator 950
SRAM	
Value	1 MB
Battery backed	Yes
Remanent variables in power failure mode	192 kB (e.g. for Automation Runtime, see AS help documentation)
Memory	
Type	DDR2 SDRAM
Memory size	Max. 3 GB
Interfaces	
COM1	
Type	RS232, modem-capable, not electrically isolated
Execution	9-pin male DSUB connector
UART	16550-compatible, 16-byte FIFO
Max. baud rate	115 kbit/s
COM2	
Type	RS232/422/485, electrically isolated
Execution	9-pin male DSUB connector
UART	16550-compatible, 16-byte FIFO
Max. baud rate	115 kbit/s
CompactFlash slot 1	
Type	Type I
CompactFlash slot 2	
Type	Type I
USB	
Quantity	5
Type	USB 2.0
Connection	To each USB type A interface
Transfer rate	Low speed (1.5 Mbit/s), full speed (12 Mbit/s), high speed (480 Mbit/s)
Current load	Max. 500 mA or 1 A per connection
Ethernet	
Quantity	2
Transfer rate	10/100/1000 Mbit/s
Max. baud rate	1000 Mbit/s
Monitor/Panel interface	
Execution	DVI-I socket
Type	SDL/DVI/Monitor
POWERLINK	
Quantity	1
Node switches	2
Status LED	Yes
CAN	
Quantity	1
Transfer rate	Max. 500 kbit/s
Node switches	Yes
Status LED	Yes
Terminating resistor	Yes, can be activated using a switch
Inserts	
PClec slots	
Quantity	1
Electrical characteristics	
Nominal voltage	24 VDC ±25%
Nominal current	5 A
Starting current	Typ. 7 A, max. 50 A for < 300 µs
Operating conditions	
Height of drop	0.25 m
EN 60529 protection	IP20

Table 51: 5PC820.SX01-01 - Technical data

Product ID	5PC820.SX01-01
Environmental conditions	
Temperature	
Operation	Component-dependent
Storage	-20 to 60°C
Transport	-20 to 60°C
Relative humidity	
Operation	Component-dependent
Storage	Component-dependent
Transport	Component-dependent
Vibration	
Operation	2 to 9 Hz: 0.3 mm amplitude / 9 to 200 Hz: 0.1 g
Storage	2 to 9 Hz: 3.5 mm amplitude / 9 to 200 Hz: 1 g / 200 to 500 Hz: 1.5 g
Transport	2 to 9 Hz: 3.5 mm amplitude / 9 to 200 Hz: 1 g / 200 to 500 Hz: 1.5 g
Altitude	
Operation	Max. 3000 m (component-dependent)
Mechanical characteristics	
Housing ⁴⁾	
Material	Galvanized plate, plastic
Front cover	Polycarbonate, black
Cable cover	Polycarbonate, transparent
Dimensions	
Width	53 mm
Height	344 mm
Depth	253 mm
Weight	Approx. 2550 g

Table 51: 5PC820.SX01-01 - Technical data

- 1) The service life of 1½ years is only valid if an SRAM module is being used. Without an SRAM module, a service life of 2 years can be expected. At 50°C, 8.5 A for the supplied components and a self discharge of 40%.
- 2) At max. specified ambient temperature: typically 58 ppm (5 seconds) - worst-case 220 ppm (19 seconds).
- 3) Maintenance Controller Extended
- 4) Depending on the process or batch, there may be visible deviations in the color and surface structure.

3.1.3.4 Dimensions

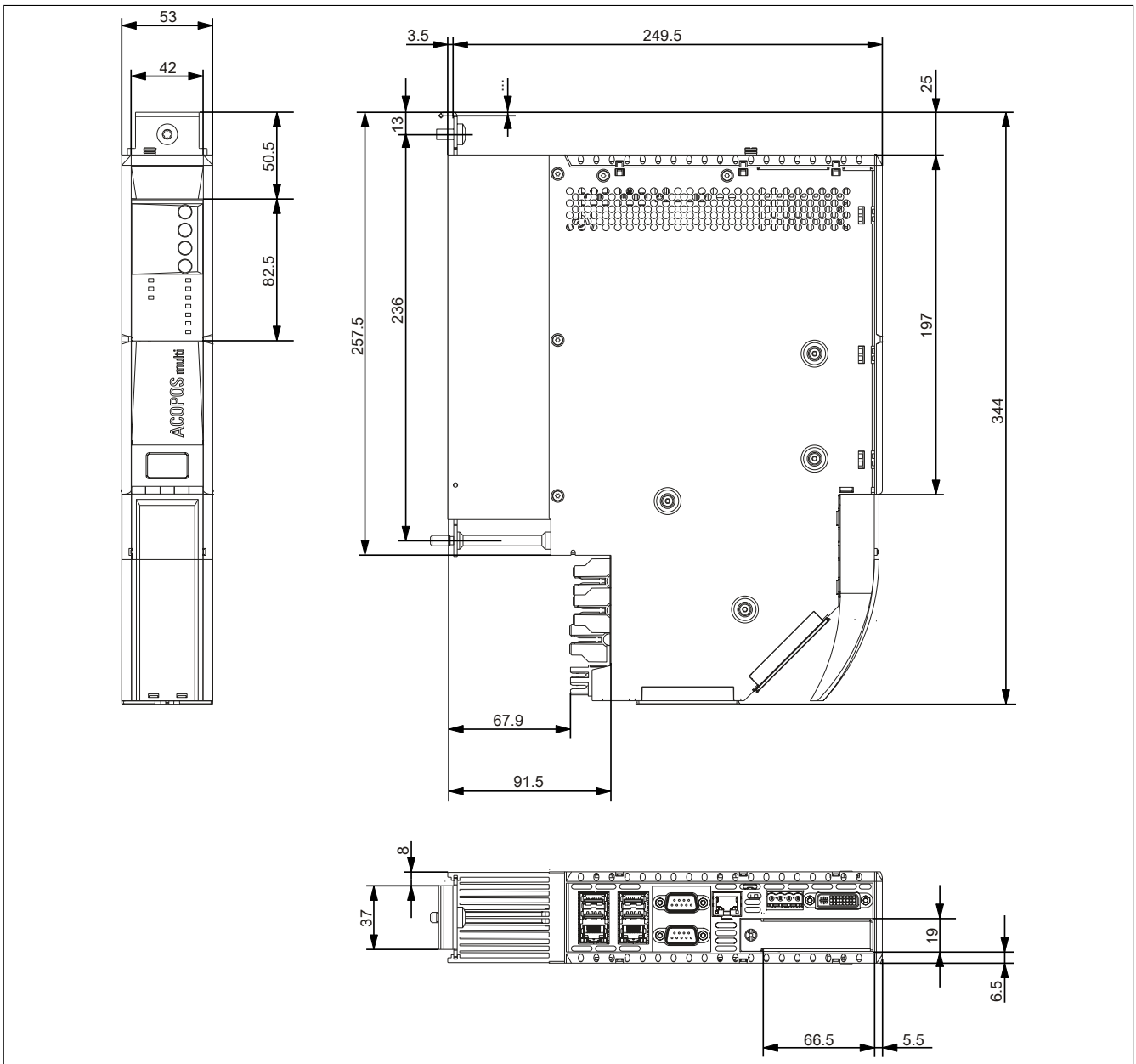

Figure 13: 5PC820.SX01-01 - Dimensions

3.2 CPU boards 945GME

3.2.1 General information

- AMI BIOS
- Intel® 945GME chipset
- 2x DDR2 memory slot
- Dual-channel memory
- Intel® GMA 950
- Gigabit Ethernet

3.2.2 Order data

Model number	Short description	Figure
CPU boards		
5PC800.B945-00	Intel Core Duo L2400 CPU board, 1.66 GHz, dual core, 667 MHz FSB, 2 MB L2 cache; 945GME chipset; 2 slots for SO-DIMM DDR2 modules (max. total of 3 GB), Realtek RTL8111B Ethernet controller	
5PC800.B945-01	Intel Core2 Duo L7400 CPU board, 1.5 GHz, dual core, 667 MHz FSB, 4 MB L2 cache; 945GME chipset; 2 slots for SO-DIMM DDR2 modules (max. total of 3 GB), Realtek RTL8111B Ethernet controller	
5PC800.B945-02	Intel Core2 Duo U7500 CPU board, 1.06 GHz, dual core, 533 MHz FSB, 2 MB L2 cache; 945GME chipset; 2 slots for SO-DIMM DDR2 modules (max. total of 3 GB), Realtek RTL8111B Ethernet controller	
5PC800.B945-03	Intel Celeron M 423 CPU board, 1.06 GHz, single core, 533 MHz FSB, 1 MB L2 cache; 945GME chipset; 2 slots for SO-DIMM DDR2 modules (max. total of 3 GB), Realtek RTL8111B Ethernet controller	
5PC800.B945-04	Intel Core2 Duo T7400 CPU board, 2.16 GHz, dual core, 667 MHz FSB, 4 MB L2 cache; 945GME chipset; 2 slots for SO-DIMM DDR2 modules (max. total of 3 GB), Realtek RTL8111B Ethernet controller	
Required accessories		
Main memory		
5MMDDR.0512-01	SO-DIMM DDR2 RAM 512 MB PC2-5300	
5MMDDR.1024-01	SO-DIMM DDR2 RAM 1024 MB PC2-5300	
5MMDDR.2048-01	SO-DIMM DDR2 RAM 2048 MB PC2-5300	

Table 52: 5PC800.B945-00, 5PC800.B945-01, 5PC800.B945-02, 5PC800.B945-03, 5PC800.B945-04 - Order data

Model number	Short description	Figure
CPU boards		
5PC800.B945-10	Intel Core Duo L2400 CPU board, 1.66 GHz, dual core, 667 MHz FSB, 2 MB L2 cache; 945GME chipset; 2 slots for SO-DIMM DDR2 modules (max. total of 3 GB), Realtek RTL8111C Ethernet controller	
5PC800.B945-11	Intel Core2 Duo L7400 CPU board, 1.5 GHz, dual core, 667 MHz FSB, 4 MB L2 cache; 945GME chipset; 2 slots for SO-DIMM DDR2 modules (max. total of 3 GB), Realtek RTL8111C Ethernet controller	
5PC800.B945-12	Intel Core2 Duo U7500 CPU board, 1.06 GHz, dual core, 533 MHz FSB, 2 MB L2 cache; 945GME chipset; 2 slots for SO-DIMM DDR2 modules (max. total of 3 GB), Realtek RTL8111C Ethernet controller	
5PC800.B945-13	Intel Celeron M 423 CPU board, 1.06 GHz, single core, 533 MHz FSB, 1 MB L2 cache; 945GME chipset; 2 slots for SO-DIMM DDR2 modules (max. total of 3 GB), Realtek RTL8111C Ethernet controller	
5PC800.B945-14	Intel Core2 Duo T7400 CPU board, 2.16 GHz, dual core, 667 MHz FSB, 4 MB L2 cache; 945GME chipset; 2 slots for SO-DIMM DDR2 modules (max. total of 3 GB), Realtek RTL8111C Ethernet controller	
Required accessories		
Main memory		
5MMDDR.0512-01	SO-DIMM DDR2 RAM 512 MB PC2-5300	
5MMDDR.1024-01	SO-DIMM DDR2 RAM 1024 MB PC2-5300	
5MMDDR.2048-01	SO-DIMM DDR2 RAM 2048 MB PC2-5300	

Table 53: 5PC800.B945-10, 5PC800.B945-11, 5PC800.B945-12, 5PC800.B945-13, 5PC800.B945-14 - Order data

3.2.3 Technical data - 5PC800.B945-0x

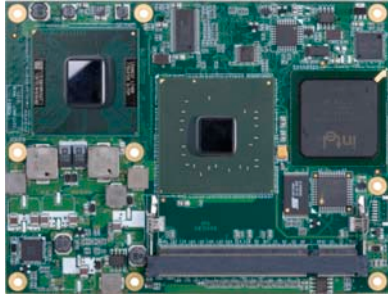
Product ID	5PC800.B945-00	5PC800.B945-01	5PC800.B945-02	5PC800.B945-03	5PC800.B945-04
General information					
Certification CE GOST-R			Yes	Yes	-
Controller					
Boot loader	Embedded AMI BIOS				
Processor					
Type	Intel® Core™ Duo L2400	Intel® Core™2 Duo L7400	Intel® Core™2 Duo U7500	Intel® Celeron® M 423,	Intel® Core™2 Duo T7400
Clock frequency	1660 MHz	1500 MHz	1060 MHz		2160 MHz
Number of cores	2		1		2
Architectures			65 nm		
L1 cache			32 kB		
L2 cache	2 MB	4 MB	2 MB	1 MB	4 MB
External bus	667 MHz		533 MHz		
Intel® 64 Architecture	No		Yes	No	Yes
Intel® Virtualization Technology (VT-x)			Yes	No	Yes
Enhanced Intel SpeedStep® Technology			Yes	No	Yes
Chipset	Intel® 945GME Intel® 82801 GHM (ICH7M-DH)				
Real-time clock					
Precision	At 25°C: typ. 12 ppm (1 seconds) per day				
Battery backed	Yes				
Memory slot					
Type	DDR2				
Memory size	Max. 3 GB				
Graphics					
Controller	Intel® Graphics Media Accelerator 950				
Memory	Up to 224 MB ¹⁾				
Color depth	Max. 32-bit				
Resolution					
DVI	2x Intel-compliant SDVO ports, 1920 x 1080				
RGB	400 MHz RAMDAC, resolutions up to 2048 x 1536 @ 75 Hz (QXGA) and 1920 x 1080 @ 85 Hz (HDTV)				
Mass memory management	2x SATA, 1x IDE				
Power management	ACPI 2.0, S3 Support (suspend to RAM)				

Table 54: 5PC800.B945-00, 5PC800.B945-01, 5PC800.B945-02, 5PC800.B945-03, 5PC800.B945-04 - Technical data

1) Allocated in main memory.

3.2.4 Technical data - 5PC800.B945-1x

Product ID	5PC800.B945-10	5PC800.B945-11	5PC800.B945-12	5PC800.B945-13	5PC800.B945-14
General information					
Certification CE cULus GOST-R			Yes Yes Yes		
Controller					
Boot loader	Embedded AMI BIOS				
Processor					
Type	Intel® Core™ Duo L2400	Intel® Core™2 Duo L7400	Intel® Core™2 Duo U7500	Intel® Celeron® M 423,	Intel® Core™2 Duo T7400
Clock frequency	1660 MHz	1500 MHz	1060 MHz		2160 MHz
Number of cores	2		1		2
Architectures			65 nm		
L1 cache			32 kB		
L2 cache	2 MB	4 MB	2 MB	1 MB	4 MB
External bus	667 MHz		533 MHz		
Intel® 64 Architecture	No		Yes	No	Yes
Intel® Virtualization Technology (VT-x)			Yes	No	Yes
Enhanced Intel SpeedStep® Technology			Yes	No	Yes
Chipset	Intel® 945GME Intel® 82801 GHM (ICH7M-DH)				
Real-time clock					
Precision	At 25°C: typ. 12 ppm (1 seconds) per day				
Battery backed	Yes				
Memory slot					
Type	DDR2				
Memory size	Max. 3 GB				

Table 55: 5PC800.B945-10, 5PC800.B945-11, 5PC800.B945-12, 5PC800.B945-13, 5PC800.B945-14 - Technical data

Product ID	5PC800.B945-10	5PC800.B945-11	5PC800.B945-12	5PC800.B945-13	5PC800.B945-14
Graphics	Intel® Graphics Media Accelerator 950 Up to 224 MB ¹⁾ Max. 32-bit 2x Intel-compliant SDVO ports, 1920 x 1080 400 MHz RAMDAC, resolutions up to 2048 x 1536 @ 75 Hz (QXGA) and 1920 x 1080 @ 85 Hz (HDTV)				
Controller					
Memory					
Color depth					
Resolution					
DVI					
RGB					
Mass memory management	2x SATA, 1x IDE				
Power management	ACPI 2.0, S3 Support (suspend to RAM)				

Table 55: 5PC800.B945-10, 5PC800.B945-11, 5PC800.B945-12, 5PC800.B945-13, 5PC800.B945-14 - Technical data

1) Allocated in main memory.

3.3 Main memory

3.3.1 General information

These 200-pin DDR2 main memory modules operate at 677 MHz and are available in sizes of 512 MB, 1 GB and 2 GB.

If two RAM modules with the same size (e.g. 1 GB) are inserted, then dual-channel memory technology is supported. This technology is not supported if two modules of different sizes (e.g. 1 GB and 2 GB) are inserted.

If two 2 GB modules are inserted, only 3 GB of main memory can be used.

3.3.2 Order data

Model number	Short description	Figure
	Main memory	
5MMDDR.0512-01	SO-DIMM DDR2 RAM 512 MB PC2-5300	
5MMDDR.1024-01	SO-DIMM DDR2 RAM 1024 MB PC2-5300	
5MMDDR.2048-01	SO-DIMM DDR2 RAM 2048 MB PC2-5300	

Table 56: 5MMDDR.0512-01, 5MMDDR.1024-01, 5MMDDR.2048-01 - Order data

3.3.3 Technical data

Product ID	5MMDDR.0512-01	5MMDDR.1024-01	5MMDDR.2048-01
General information			
Certification			
CE		Yes	
cULus		Yes	
GOST-R		Yes	
GL		Yes ¹⁾	
Controller			
Memory			
Type		SO-DIMM DDR2 SDRAM	
Memory size	512 MB	1 GB	2 GB
Construction		200-pin	
Organization	64M x 64-bit	128M x 64-bit	256M x 64-bit
Speed		DDR2-667 (PC2-5300)	

Table 57: 5MMDDR.0512-01, 5MMDDR.1024-01, 5MMDDR.2048-01 - Technical data

1) Yes, although applies only if all components installed within the complete system have this certification

Information:

A main memory module can only be replaced at B&R.

3.4 Heat sink with power supply

3.4.1 General information

Information:

The power supply with heat sink can only be replaced at the B&R plant.

3.4.2 Order data

Model number	Short description	Figure
	Heat sinks	
5AC802.HS00-00	APC820 power supply and heat sink for CPU boards with Dual Core processors L2400, L7400, U7500 and Celeron M 423.	
5AC802.HS00-01	APC820 power supply with heat sink for CPU boards with dual-core processor T7400.	
	Required accessories	
	CPU boards	
5PC800.B945-00	Intel Core Duo L2400 CPU board, 1.66 GHz, dual core, 667 MHz FSB, 2 MB L2 cache; 945GME chipset; 2 slots for SO-DIMM DDR2 modules (max. total of 3 GB), Realtek RTL8111B Ethernet controller	
5PC800.B945-01	Intel Core2 Duo L7400 CPU board, 1.5 GHz, dual core, 667 MHz FSB, 4 MB L2 cache; 945GME chipset; 2 slots for SO-DIMM DDR2 modules (max. total of 3 GB), Realtek RTL8111B Ethernet controller	
5PC800.B945-02	Intel Core2 Duo U7500 CPU board, 1.06 GHz, dual core, 533 MHz FSB, 2 MB L2 cache; 945GME chipset; 2 slots for SO-DIMM DDR2 modules (max. total of 3 GB), Realtek RTL8111B Ethernet controller	
5PC800.B945-03	Intel Celeron M 423 CPU board, 1.06 GHz, single core, 533 MHz FSB, 1 MB L2 cache; 945GME chipset; 2 slots for SO-DIMM DDR2 modules (max. total of 3 GB), Realtek RTL8111B Ethernet controller	
5PC800.B945-04	Intel Core2 Duo T7400 CPU board, 2.16 GHz, dual core, 667 MHz FSB, 4 MB L2 cache; 945GME chipset; 2 slots for SO-DIMM DDR2 modules (max. total of 3 GB), Realtek RTL8111B Ethernet controller	
5PC800.B945-10	Intel Core Duo L2400 CPU board, 1.66 GHz, dual core, 667 MHz FSB, 2 MB L2 cache; 945GME chipset; 2 slots for SO-DIMM DDR2 modules (max. total of 3 GB), Realtek RTL8111C Ethernet controller	
5PC800.B945-11	Intel Core2 Duo L7400 CPU board, 1.5 GHz, dual core, 667 MHz FSB, 4 MB L2 cache; 945GME chipset; 2 slots for SO-DIMM DDR2 modules (max. total of 3 GB), Realtek RTL8111C Ethernet controller	
5PC800.B945-12	Intel Core2 Duo U7500 CPU board, 1.06 GHz, dual core, 533 MHz FSB, 2 MB L2 cache; 945GME chipset; 2 slots for SO-DIMM DDR2 modules (max. total of 3 GB), Realtek RTL8111C Ethernet controller	
5PC800.B945-13	Intel Celeron M 423 CPU board, 1.06 GHz, single core, 533 MHz FSB, 1 MB L2 cache; 945GME chipset; 2 slots for SO-DIMM DDR2 modules (max. total of 3 GB), Realtek RTL8111C Ethernet controller	
5PC800.B945-14	Intel Core2 Duo T7400 CPU board, 2.16 GHz, dual core, 667 MHz FSB, 4 MB L2 cache; 945GME chipset; 2 slots for SO-DIMM DDR2 modules (max. total of 3 GB), Realtek RTL8111C Ethernet controller	

Table 58: 5AC802.HS00-00, 5AC802.HS00-01 - Order data

3.4.3 Technical data

Product ID	5AC802.HS00-00	5AC802.HS00-01
General information		
Suitable for CPU boards	5PC800.B945-00 / -10 5PC800.B945-01 / -11 5PC800.B945-02 / -12 5PC800.B945-03 / -13	5PC800.B945-04 / -14 5PC800.BM45-01
Suitable for the following system units	5PC820.SX01-00 5PC820.SX01-01	
Certification	Yes	
CE	Yes	
GOST-R	Yes	
Mechanical characteristics		
Material	Aluminum (heat sink)	
Weight	900 g	

Table 59: 5AC802.HS00-00, 5AC802.HS00-01 - Technical data

3.5 Replacement fan 8BXF001.0000-00

Information:

The fan is subject to wear and must be checked with appropriate frequency and cleaned or replaced when not functioning properly (e.g. due to dirt and grime).

3.5.1 Order data

Model number	Short description	Figure
	Fan modules	
8BXF001.0000-00	ACOPOSmulti fan module, replacement fan for ACOPOSmulti modules (8BVP / 8B0C / 8BVI / 8BVE / 8B0K)	

Table 60: 8BXF001.0000-00 - Order data

3.5.2 Technical data

Product ID	8BXF001.0000-00
General information	
Short description	ACOPOSmulti fan module, replacement fan for ACOPOS-multi modules (8BVP / 8B0C / 8BVI / 8BVE / 8B0K)
Certification	
CE	Yes
cULus	Yes

Table 61: 8BXF001.0000-00 - Technical data

3.6 PClec plug-in cards

3.6.1 General information

PClec plug-in cards are equipped with a sensor that monitors the card's temperature. This is read out in BIOS and in the ADI.

3.6.2 Dimensions

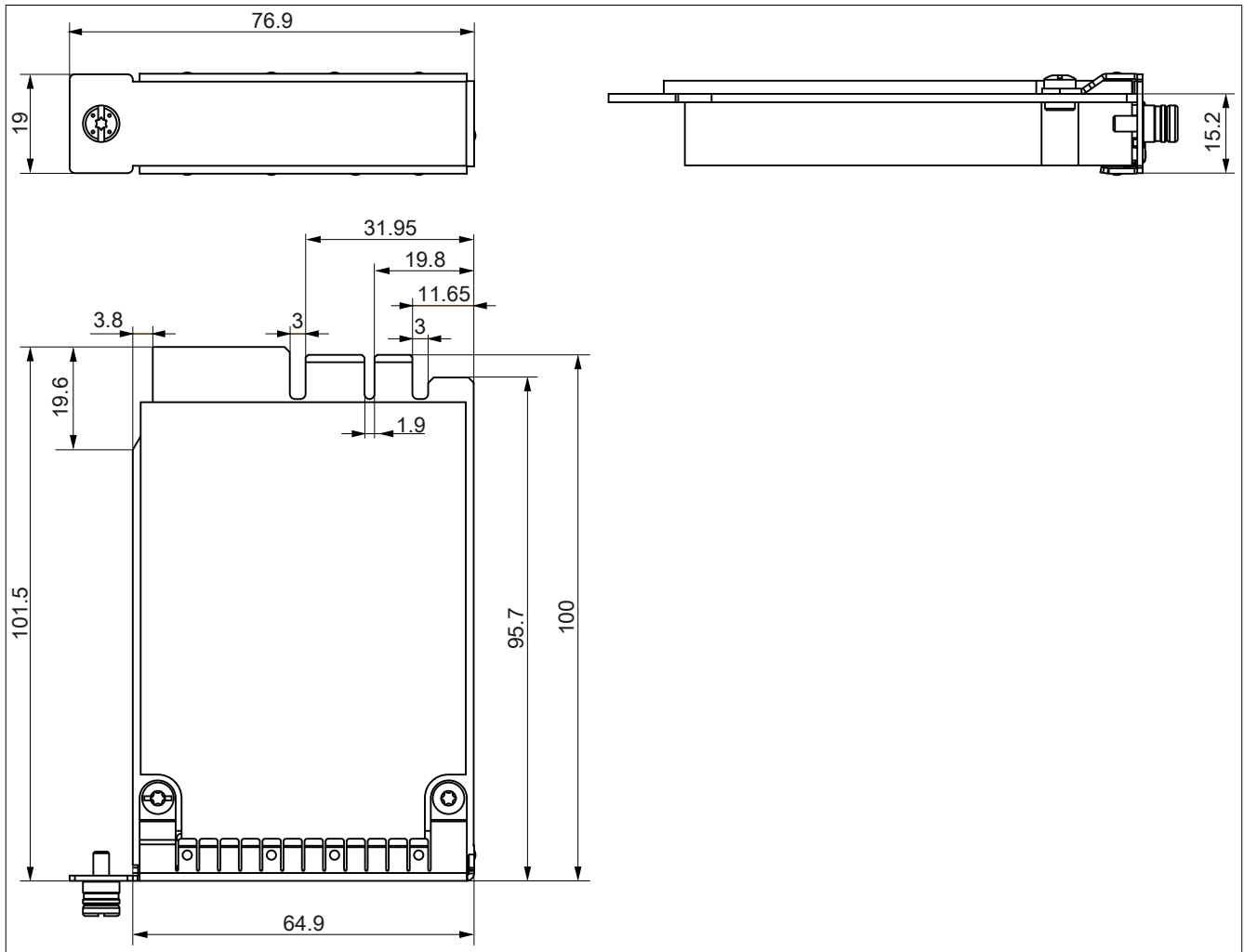

Figure 14: PCI Express compact plug-in cards - Dimensions

Information:

Only B&R PClec cards that have been specially designed for the Automation PC 820 and Panel PC 800 can be used.

3.6.3 5ACPCC.ETH0-00

3.6.3.1 General information

This PCI Express compact Ethernet card has a 10/100/1000 Mbit/s network connection and can be used as an additional network interface in a PCI Express compact slot.

- PCIe Ethernet card
- 1 network connection (10/100/1000 Mbit/s)

3.6.3.2 Order data

Model number	Short description	Figure
	Interface cards	
5ACPCC.ETH0-00	PCIe Ethernet card 1x 10/100/1000 For APC820 and PPC800.	

Table 62: 5ACPCC.ETH0-00 - Order data

3.6.3.3 Technical data

Product ID	5ACPCC.ETH0-00
General information	
B&R ID code	0xAB25
Diagnostics Data transfer	Yes, using status LED
Certification CE GOST-R	Yes Yes
Interfaces	
Ethernet Quantity Controller Design Transfer rate Cable length	1 Intel 82574 Shielded RJ45 port 10/100/1000 Mbit/s Max. 100 m between two stations (segment length)
Mechanical characteristics	
Slot	PCIe module

Table 63: 5ACPCC.ETH0-00 - Technical data

3.6.3.3.1 Ethernet interface

Information:

The following characteristics, features and limit values only apply to this individual component and can deviate from those specified for the complete system. For the complete system in which this individual component is used, refer to the data given specifically for that device.

Ethernet interface (ETH ¹⁾)		
Controller	Intel 82574	
Cabling	S/STP (Cat 5e)	
Transfer rate	10/100/1000 Mbit/s ²⁾	
Cable length	Max. 100 m (min. Cat 5e)	
Speed LED	On	Off
Green	100 Mbit/s	10 Mbit/s ³⁾
Orange	1000 Mbit/s	-
Link LED	On	Off
Orange	Link (Ethernet network connection available)	Activity (blinking - data transfer in progress)

Female RJ45 connector

1

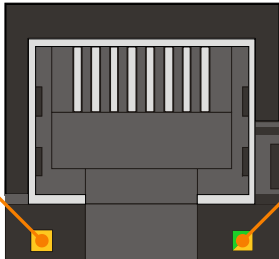

Table 64: 5ACPCC.ETH0-00 - Ethernet interface

- 1) The interfaces, etc. available on the device or module have been numbered as such for easy identification. This numbering may differ from that used by the particular operating system.
- 2) Switching takes place automatically.
- 3) The 10 Mbit/s transfer speed / connection is only present if the IF slot Link LED is also lit at the same time.

Driver support

A special driver is required in order to operate the Intel 82574 Ethernet controller. Drivers for approved operating systems are available in the Downloads section of the B&R website (www.br-automation.com).

Information:

Required drivers can only be downloaded from the B&R website, not from manufacturer websites.

3.6.4 5ACPCC.MPL0-00

3.6.4.1 General information

This PCI Express compact POWERLINK card is equipped with two POWERLINK interfaces, two station number switches and a card number switch for differentiating between modules. This PCI Express compact POWERLINK card can be used as an additional POWERLINK interface in a PCI Express compact slot.

- PCIe POWERLINK card
- 2 POWERLINK interfaces
- 2 station number switches
- Card number switch

3.6.4.2 Order data

Model number	Short description	Figure
	Interface cards	
5ACPCC.MPL0-00	PCIe POWERLINK card, 2 POWERLINK interfaces, 512 kB SRAM; for APC820 and PPC800.	

Table 65: 5ACPCC.MPL0-00 - Order data

3.6.4.3 Technical data

Product ID	5ACPCC.MPL0-00
General information	
B&R ID code	0xAB27
Diagnostics	
Data transfer	Yes, using status LED
Certification	
CE	Yes
GOST-R	Yes
Controller	
SRAM	
Size	512 kB
Remanent variables in power failure mode	128 kB (e.g. for Automation Runtime, see AS help documentation)
Interfaces	
POWERLINK	
Quantity	2
Transmission	100 Base-T (ANSI/IEEE 802.3)
Design	Internal 2x hub, 2x shielded RJ45 port
Transfer rate	100 Mbit/s
Node switches	2
Cable length	Max. 100 m between two stations (segment length)
Mechanical characteristics	
Slot	PCIe module

Table 66: 5ACPCC.MPL0-00 - Technical data

3.6.4.3.1 POWERLINK interface

Information:

The following characteristics, features and limit values only apply to this individual component and can deviate from those specified for the complete system. For the complete system in which this individual component is used, refer to the data given specifically for that device.

POWERLINK card 2 connections		
Cabling	S/STP (Cat 5e)	
Cable length	Max. 100 m (min. Cat 5e)	
Speed LED	On	Off
Green/Red	See Status/Error LED.	
Link LED	On	Off
Yellow	Link (POWERLINK network connection available)	Activity (blinking - data transfer in progress)

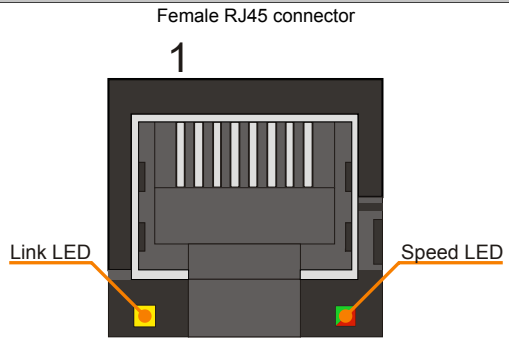

Table 67: 5ACPCC.MPL0-00 - POWERLINK interface

3.6.4.3.2 Status/Error LED

The Status/Error LED is a green and red dual LED. The LED status can have different meanings depending on the operating mode.

Ethernet mode

In this mode, the interface is operated as an Ethernet interface.

Green - Status	Description
On	Interface being operated as an Ethernet interface

Table 68: Status/Error LED - Ethernet mode

POWERLINK V1

LED status indicators		Status of the POWERLINK station
Green	Red	
On	Off	The POWERLINK station is running with no errors.
Off	On	A fatal system error has occurred. The error type can be read using the PLC logbook. An irreparable problem has occurred. The system cannot properly carry out its tasks. This state can only be changed by resetting the module.
Blinking alternately		The POWERLINK managing node has failed. This error code can only occur when operated as a controlled node.
Off	Blinking	System failure. The red blinking LED signals a certain type of error using a blink code (see section "System stop error codes" on page 38).

Table 69: Status/Error LED - POWERLINK V1 operating mode

POWERLINK

Red - Error	Description
On	<p>The interface is in an error state (failed Ethernet frames, increased number of collisions on the network, etc.). If an error occurs in the following states, then the green LED blinks over the red LED:</p> <ul style="list-style-type: none"> BASIC_ETHERNET PRE_OPERATIONAL_1 PRE_OPERATIONAL_2 READY_TO_OPERATE 

Table 70: Status/Error LED - POWERLINK - Error

Green - Status	Description
Off NOT_ACTIVE	<p>Mode The interface is in NOT_ACTIVE mode or:</p> <ul style="list-style-type: none"> • Switched off • Starting up • Not configured correctly in Automation Studio • Defective <p>Managing node (MN) The bus is being monitored for POWERLINK frames. If a frame is not received within the configured time window (timeout), the interface switches immediately to PRE_OPERATIONAL_1 mode (single flash). If POWERLINK communication is detected before the time expires, however, then the MN will not be started.</p> <p>Controlled node (CN) The bus is being monitored for POWERLINK frames. If a corresponding frame is not received within the defined time frame (timeout), then the module switches immediately to BASIC_ETHERNET mode (flickering). If POWERLINK communication is detected before this time expires, however, the interface switches immediately to PRE_OPERATIONAL_1 mode (single flash).</p>
Green flickering (approx. 10 Hz) BASIC_ETHERNET	<p>Mode The interface is in BASIC_ETHERNET mode and being operated as an Ethernet TCP/IP interface.</p> <p>Managing node (MN) This state can only be exited by resetting the interface.</p> <p>Controlled node (CN) If POWERLINK communication is detected while in this state, the interface switches to the PRE_OPERATIONAL_1 state (single flash).</p>
Single flash (approx. 1 Hz) PRE_OPERATIONAL_1	<p>Mode The interface is in PRE_OPERATIONAL_1 mode.</p> <p>Managing node (MN) The MN starts "reduced cycle" operation. Cyclic communication is not yet taking place.</p> <p>Controlled node (CN) The module can be configured by the MN in this state. The CN waits until it receives an SoC frame and then switches to the PRE_OPERATIONAL_2 state (double flash). An LED lit red in this state indicates failure of the MN.</p>
Double flash (approx. 1 Hz) PRE_OPERATIONAL_2	<p>Mode The interface is in the PRE_OPERATIONAL_2 state.</p> <p>Managing node (MN) The MN begins cyclic communication (cyclic input data is not yet being evaluated). The CNs are configured in this state.</p> <p>Controlled node (CN) The interface can be configured by the MN in this state. A command then switches the state to READY_TO_OPERATE (triple flash). An LED lit red in this mode indicates failure of the MN.</p>
Triple flash (approx. 1 Hz) READY_TO_OPERATE	<p>Mode The interface is in the READY_TO_OPERATE state.</p> <p>Managing node (MN) Cyclic and asynchronous communication is taking place. Any received PDO data is ignored.</p> <p>Controlled node (CN) The configuration of the module is completed. Normal cyclic and asynchronous communication is taking place. The PDO data being sent corresponds to the PDO mapping. Cyclic data is not yet being evaluated, however. An LED lit red in this mode indicates failure of the MN.</p>
On OPERATIONAL	<p>Mode The interface is in OPERATIONAL mode. PDO mapping is active and cyclic data is being evaluated.</p>
Blinking (approx. 2.5 Hz) STOPPED	<p>Mode The interface is in STOPPED mode.</p> <p>Managing node (MN) This status is not possible for the MN.</p> <p>Controlled node (CN) No output data is being produced, and no input data is being received. It is only possible to enter or leave this mode after the MN has given the appropriate command.</p>

Table 71: Status/Error LED - POWERLINK - Status

System stop error codes

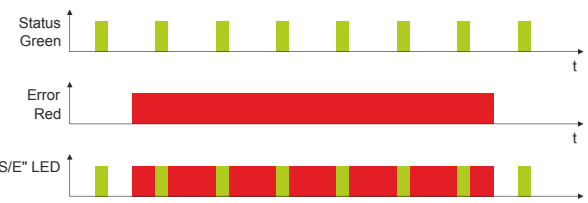
Incorrect configuration or defective hardware can cause a system stop error.

The error code is indicated by the red Error LED using four switch-on phases. Each switch-on phase has a duration of either 150 ms or 600 ms. The error code is repeated every 2 seconds.

Error description	Error code indicated by red Status LED
RAM error: The interface is defective and must be replaced.	• • • - Pause • • • - Pause
Hardware error: The interface or a system component is defective and must be replaced.	- • • - Pause - • • - Pause

Table 72: System stop error codes

Key	•	...150 ms
	-	...600 ms
	Pause	2 second delay

3.6.4.3.3 POWERLINK station number

POWERLINK station number (x1, x16)		
Both of these hex switches (x16, x1) are used to configure the POWERLINK station number. Station numbers between #00 and #FD are permitted.		
Switch position		
x1	x16	Description
0	0	Operation as managing node
1 ... D	0 ... F	station number Operation as controlled node
E	F	Reserved
F	F	Reserved

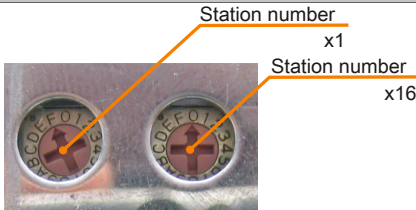

Table 73: POWERLINK station number (x1, x16)

3.6.4.3.4 Card number switch

The one-digit card number (\$ – \$F) is configured using the card number switch. This number is used to identify the module.

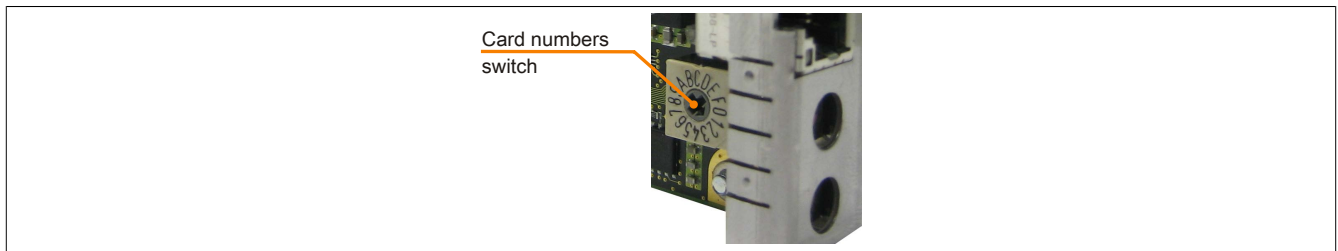

Figure 15: POWERLINK card - 2-port node number switch

If the card is operated with Automation Runtime, then the card number switch must match the slot number in Automation Studio.



Figure 16: Integrating the POWERLINK plug-in card in Automation Studio

3.6.4.3.5 SRAM

The 2-port 5ACPCC.MPL0-00 POWERLINK card has 512 kB SRAM.

Chapter 3 • Installation

1 Installation

Generally, the APC820 must be mounted to the first position regardless of mounting method. It is important to make sure that it is correctly fastened to the guide rail.

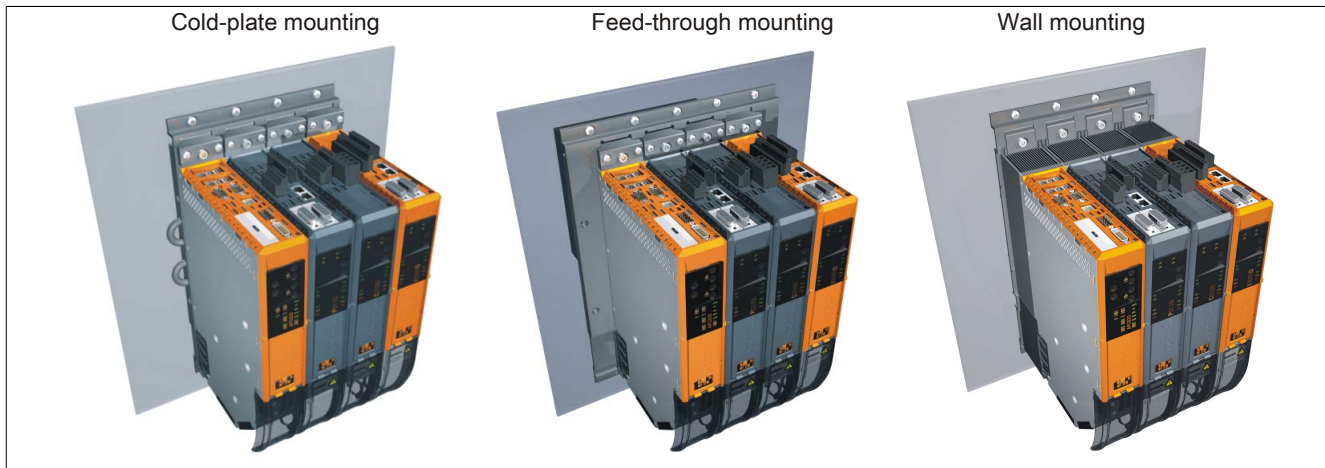

Figure 17: Installation

1.1 Important installation information

- The APC820 must be secured to the first position of the ACOPOSmulti mounting plate.
- Environmental conditions must be taken into consideration.
- The APC820 is only certified for operation in closed rooms.
- The APC820 cannot be situated in direct sunlight.
- Ventilation holes must not be covered.
- The flex radius of connected cables (DVI, SDL, USB, etc.) must not be exceeded (see "Cable connections" on page 76).
- Make sure that sufficient space is provided for air circulation.

1.2 Mounting plates

The model numbers, the exact description as well as the dimension diagrams and installation dimensions for the mounting plates can be found in the ACOPOSmulti manual in chapter 3, "Installation". This can be downloaded from the B&R website (www.br-automation.com).

Caution!

Only feed-through and cold-plate mounting are allowed for the system unit 5PC820.SX01-00!

Only wall mounting is allowed for the system unit 5PC820.SX01-01!

1.2.1 Feed-through mounting

With feed-through installation, excessive heat is output directly to the ambient air outside of the control cabinet. Suitable for a large number of axes with any range of power rating.

The mounting surface for feed-through installation must provide sufficient stability for the mounting plate and also be non-flammable, level and free of contaminants.

Caution!

The area of the mounting surface where the seal for the mounting plate sits must be free of scratches and residue because otherwise it cannot be guaranteed that protection guidelines in accordance with EN 60529 are being met!

The cutout for the feed-through heat sink and the mounting holes (type and amount) are to be prepared according to the dimension diagrams and installation dimensions in the ACOPOSmulti user's manual, which can be downloaded for free from the B&R website (www.br-automation.com).

The distances that must be used for mounting and ventilation of the Automation PC 820 and ACOPOSmulti modules can be found in the dimension diagrams for the individual modules.

1.2.2 Cold-plate mounting

The excessive heat that is generated by the devices is output directly to the cooling medium via a plate cooled with oil or water. Suitable for a large number of axes with any range of power rating and a machine's own cooling circulation system.

The mounting surface for the mounting plate must provide sufficient stability for the mounting plate and also be non-flammable, level and free of contaminants.

Connection of supply and return lines

The position of the connections for supply and return lines can be found in the installation diagram. This can be found in the ACOPOSmulti manual, which can be downloaded for free from the B&R website (www.br-automation.com).

Caution!

The feed must be connected to the bottom connector of the mounting plate.

The return line must be connected to the top connector of the mounting plate.

1.2.3 Wall mounting

The mounting surface for the mounting plate 8B0MxxxxHW00.000-1 must provide sufficient stability for the mounting plate and also be non-flammable, level and free of contaminants.

The distances that must be used for mounting and ventilation of the Automation PC 820 and ACOPOSmulti modules can be found in the dimension diagrams for the individual modules.

1.3 Mounting orientation

The following diagrams illustrate the mounting orientations permitted by B&R. These are valid for cold-plate, feed-through and wall mounting.

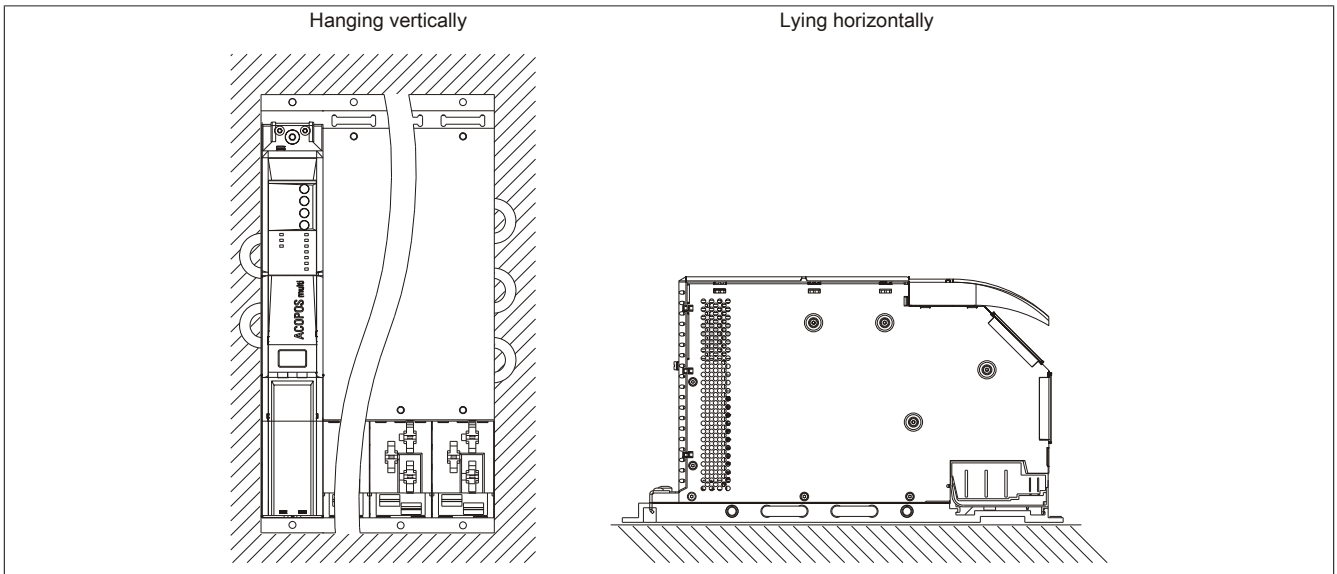

Figure 18: Permitted mounting orientations

1.4 Spacing for air circulation

In order to guarantee sufficient air circulation, allow the specified amount of space above, below, to the side and behind the . The minimum specified spacing is indicated in the following diagram. This applies to all variants.

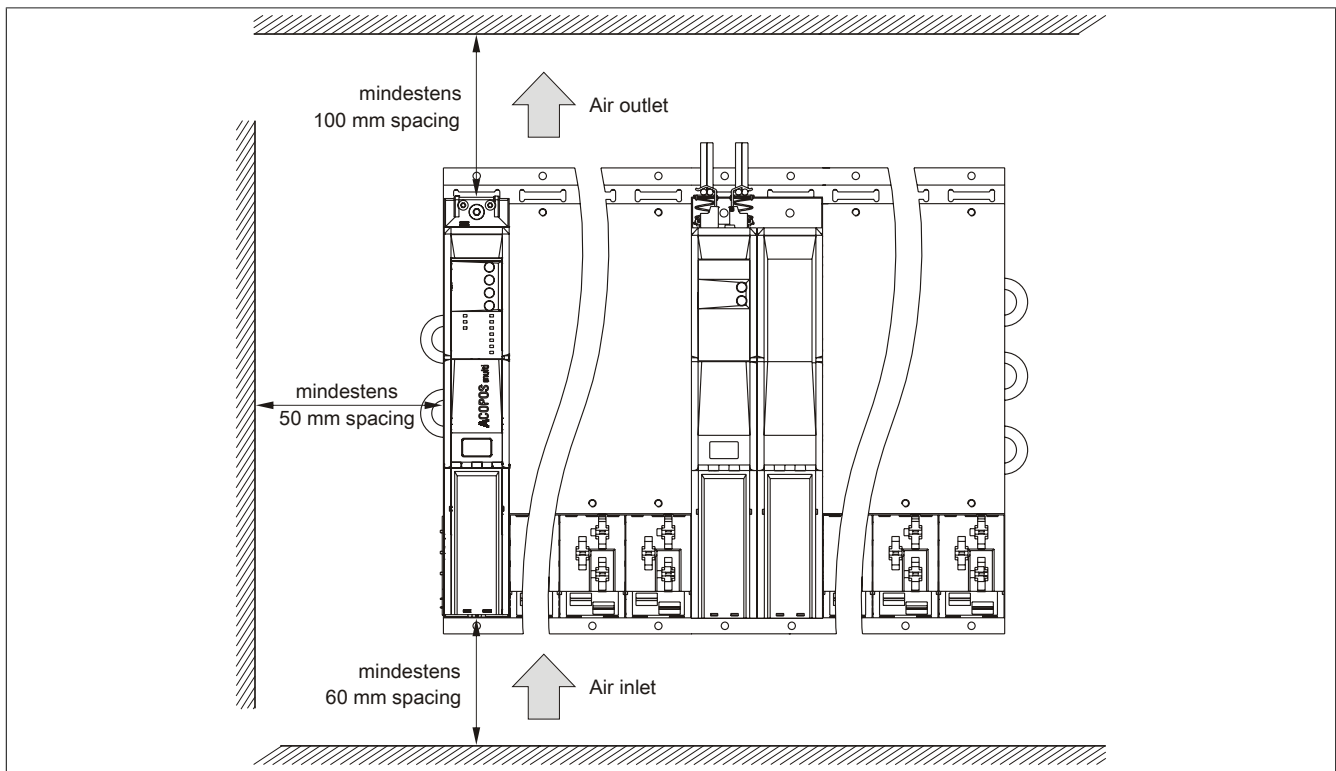

Figure 19: Spacing for air circulation

Information:

The minimal spacing intervals indicated above must be adhered to in order to ensure sufficient air circulation.

To ensure that the fan modules in the mounting plate can be replaced easily, at least 250 mm clearance must be available below the module.

Information:

The spacing specifications for air circulation are based on the worst-case scenario for operation at the maximum specified ambient temperature (see "Temperature specifications" in the chapter "Technical data").

If the spacing specifications for air circulation cannot be adhered to, then the maximum specified temperatures for the temperature sensors (see "Temperature sensor locations" in the chapter "Technical data") must be monitored by the user and appropriate measures taken if they are exceeded.

1.5 Swivel range of the front cover

Keep the swivel range of the front cover on the front side of the APC820 free when installed to prevent problems connecting peripheral devices to the APC820.

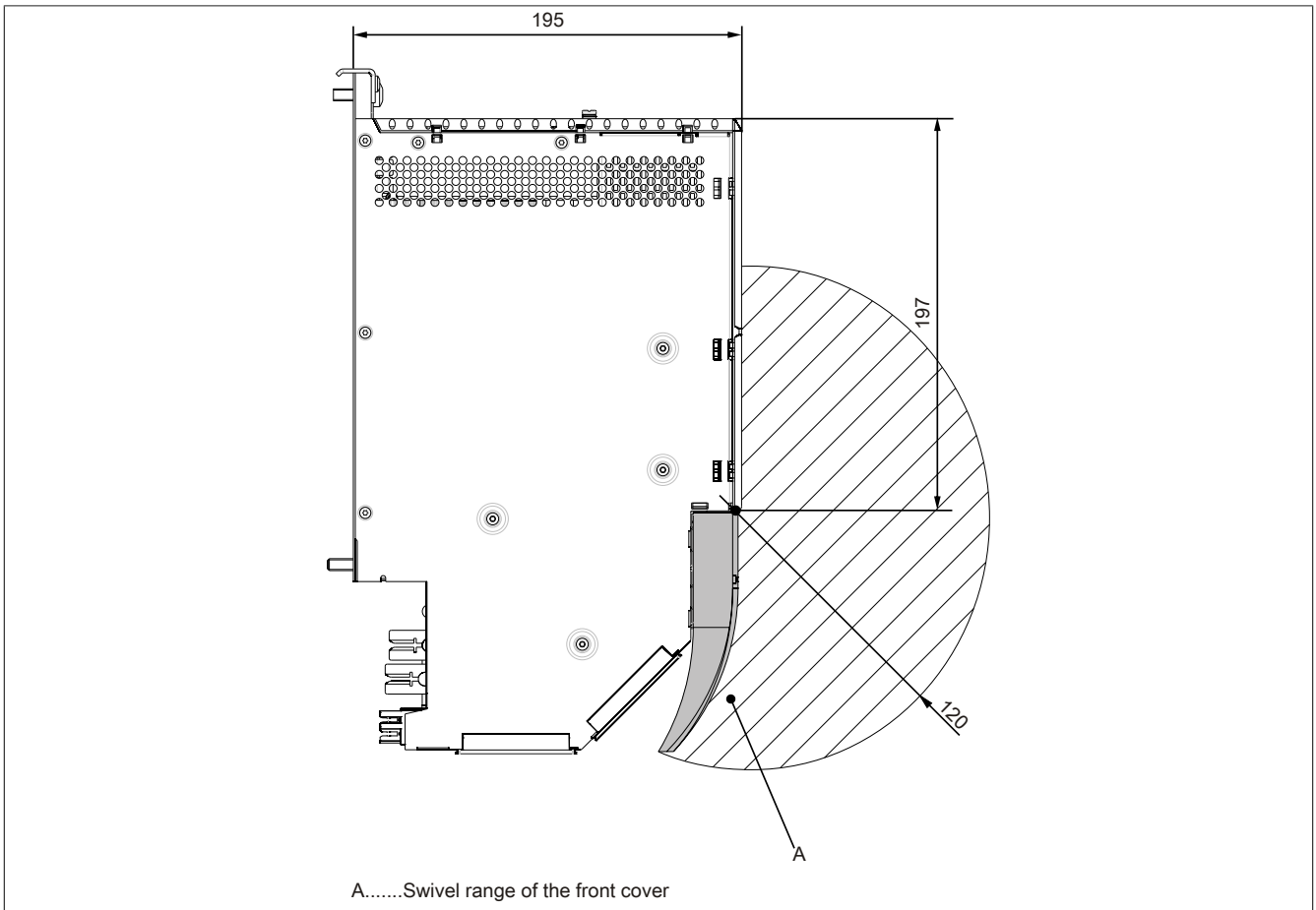

Figure 20: Swivel range of the front cover

1.6 Installation guidelines

The following must be taken into consideration when attaching to mounting plates:

- Attach the APC820 to the mounting plate using the mounting clip(s) on the top.

Information:

The Automation PC820 must always be secured to the first position of the mounting plate.

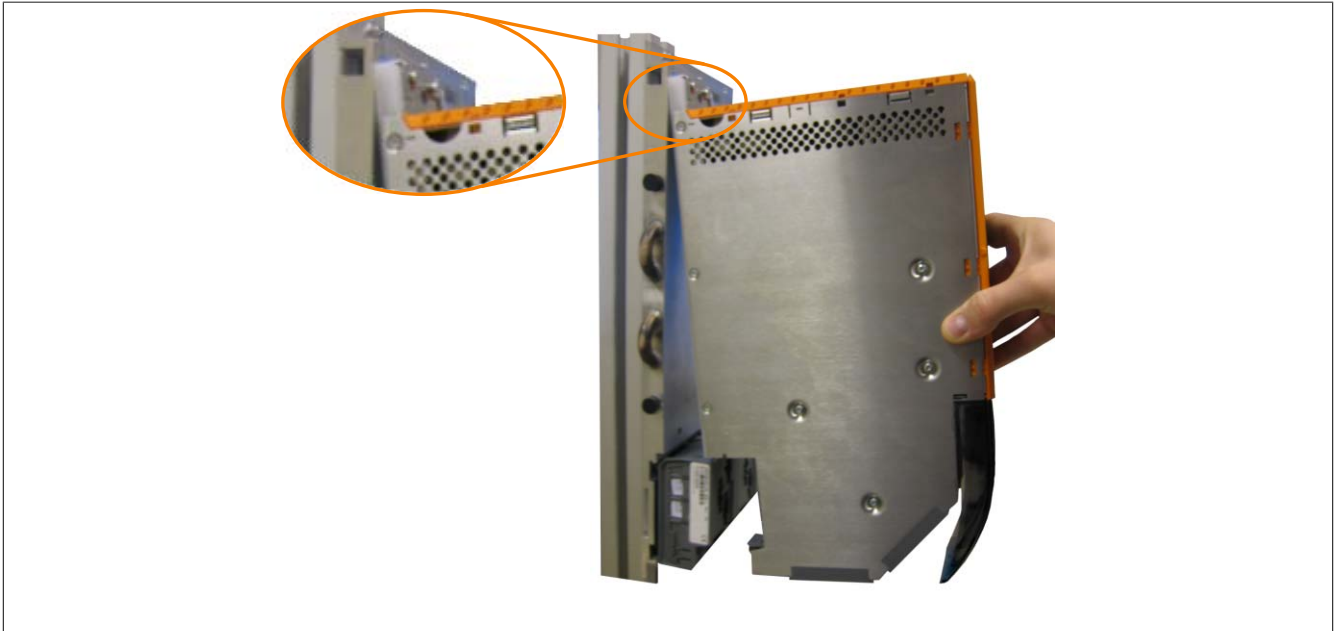

Figure 21: Attaching modules

- Clip the APC820 into the backplane module. The APC820 must be thoroughly attached, so that it rests straight in the backplane module in order for the module contacts to function properly.
- Tighten all M6 mounting screws (2 screws per module width) on the APC820 to a **torque of max. 5 Nm**.

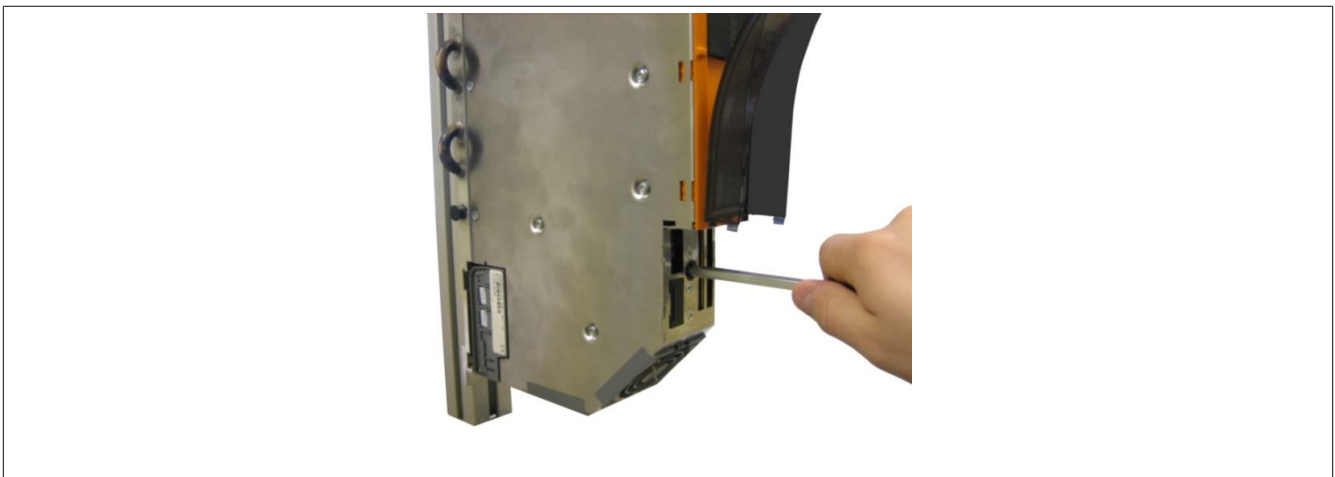

Figure 22: Tightening the fastening screws

2 Cable connections

Flex radius specifications must be taken into account when installing or connecting cables.

Information:

The maximum torque for the locating screws is 0.5 Nm.

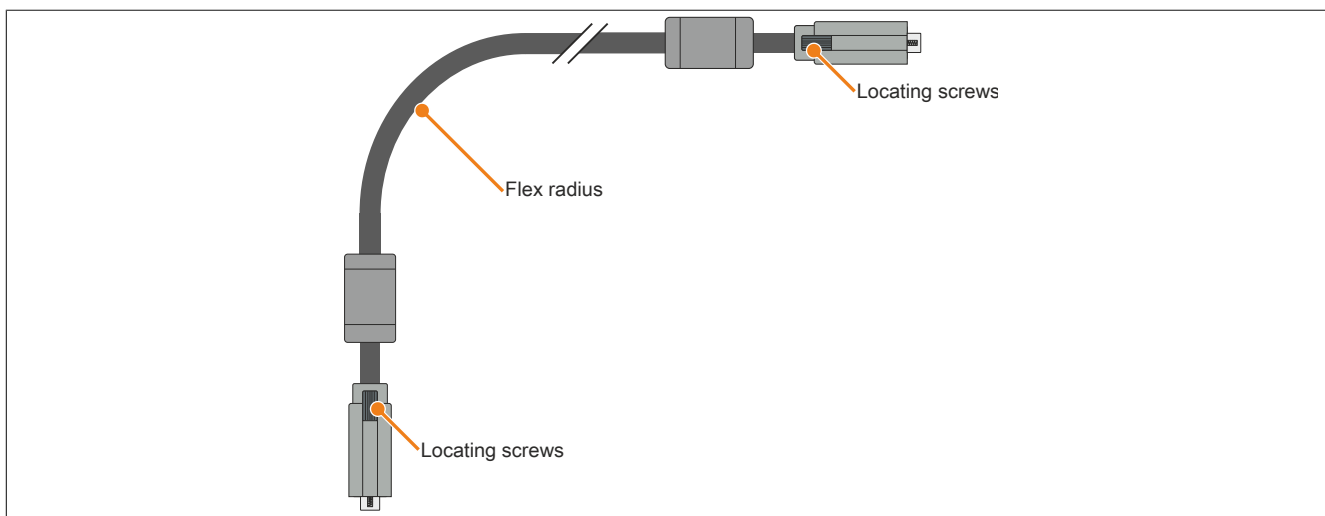

Figure 23: Flex radius - Cable connection

Information:

The specified flex radius is listed in the technical data for the respective cable.

3 Connection examples

The following examples provide an overview of the configuration options for connecting Automation Panel 800 and Automation Panel 900 and/or Automation Panel 800 devices with the APC820. The following questions will be answered:

- How are Automation Panel 900 devices connected to the monitor / panel output of the APC820, and what needs to be considered?
- How are Automation Panel 800 devices connected to the monitor / panel output of the APC820, and what needs to be considered?
- What are "Display Clone" and "Extended Desktop" modes?
- How many Automation Panel 900 devices can be connected per line?
- How many Automation Panel 900 devices can be connected to an Automation Panel 800 device per line?
- How are the connected devices internally numbered?
- Are there limitations to the segment length and if so, what are they?
- What cables and link modules are needed?
- Do BIOS settings have to be changed for a specific configuration?

3.1 Selecting display units

In order to connect an Automation Panel 800 and an Automation Panel 900 on the same line, the devices must have the same display type. The following table lists the AP900 devices that can be connected on the same line with an AP800 device.

Automation Panel 800	Automation Panel 900
5AP820.1505-00	5AP920.1505-01 5AP951.1505-01 5AP980.1505-01 5AP981.1505-01
5AP880.1505-00	5AP920.1505-01 5AP951.1505-01 5AP980.1505-01 5AP981.1505-01

Table 74: Selecting display units

3.2 One Automation Panel 900 via DVI

An Automation Panel 900 with max. SXGA resolution is connected to the integrated DVI interface (onboard). As an alternative, an office TFT with a DVI interface or analog monitor (using adapter 5AC900.1000-00) can also be used. A separate cable is used for both the touch screen and USB data. If USB devices are to be operated on the Automation Panel 900, the maximum distance is 5 meters. USB devices can only be connected directly to the Automation Panel (i.e. without a hub).

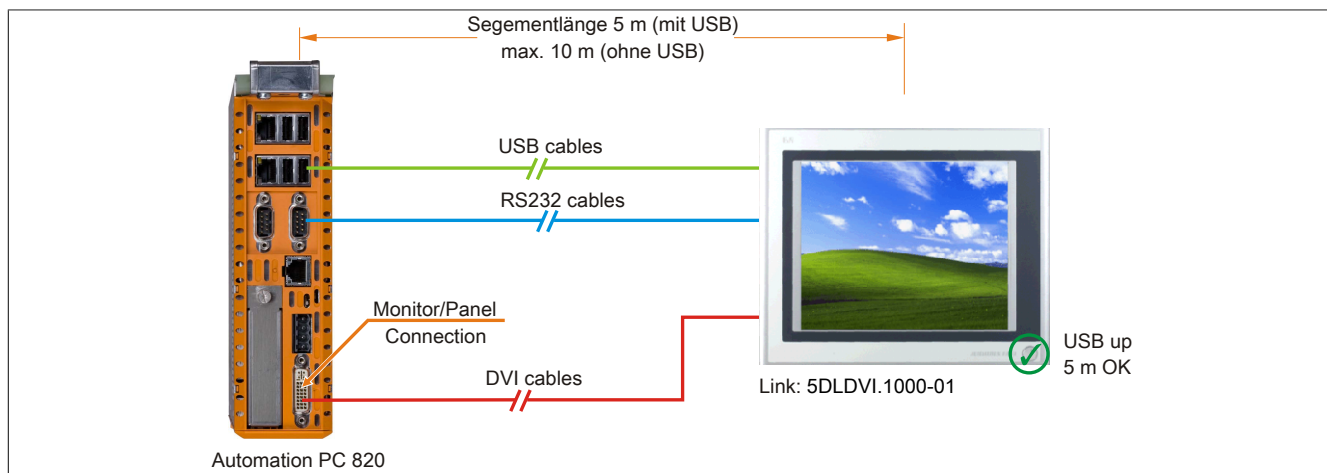

Figure 24: One Automation Panel 900 via DVI

3.2.1 Basic system requirements

The following table shows the possible combinations of APC820 system unit and CPU board to implement the configuration shown in the figure above. If a combination results in a limitation of the maximum resolution, this is also indicated (e.g. when connecting a non-B&R Automation Panel 900 device).

CPU board	with system unit		Limitation Resolution
	5PC820.SX01-00	5PC820.SX01-01	
5PC800.B945-00 5PC800.B945-10	✓	✓	Max. SXGA
5PC800.B945-01 5PC800.B945-11	✓	✓	Max. SXGA
5PC800.B945-02 5PC800.B945-12	✓	✓	Max. SXGA
5PC800.B945-03 5PC800.B945-13	✓	✓	Max. SXGA
5PC800.B945-04 5PC800.B945-14	✓	✓	Max. SXGA

Table 75: Possible combinations of system unit and CPU board

3.2.2 Link modules

Information:

A corresponding Link module must be selected for each device used.

Model number	Description	Note
5DLDVI.1000-01	Automation Panel Link DVI receiver Connections for DVI-D, RS232 and USB 2.0 (Type B); 24 VDC (order screw clamp 0TB103.9 or cage clamp 0TB103.91 separately)	For Automation Panel 900

Table 76: Link modules

3.2.3 Cables

Select one Automation Panel 900 cable each from the 3 required types.

Model number	Description	Length
5CADVI.0018-00	DVI-D cable, 1.8 m	1.8 m ±50 mm
5CADVI.0050-00	DVI-D cable, 5 m	5 m ±80 mm
5CADVI.0100-00	DVI-D cable, 10 m	10 m ±100 mm
9A0014.02	RS232 extension cable for remote operation of a display unit with touch screen, 1.8 m	1.8 m ±50 mm

Table 77: Cables for DVI configurations

Model number	Description	Length
9A0014.05	RS232 extension cable for remote operation of a display unit with touch screen, 5 m	5 m ±80 mm
9A0014.10	RS232 extension cable for remote operation of a display unit with touch screen, 10 m	10 m ±100 mm
5CAUSB.0018-00	USB 2.0 connection cable Type A - Type B, 1.8 m	1.8 m ±30 mm
5CAUSB.0050-00	USB 2.0 connection cable Type A - Type B, 5 m	5 m ±50 mm

Table 77: Cables for DVI configurations

Information:

Detailed technical data about cables can be found in the Automation Panel 900 user's manual. This can be downloaded as a PDF file from the B&R website at www.br-automation.com.

3.2.4 Possible Automation Panel devices, resolutions and segment lengths

The following Automation Panel 900 devices can be used. In rare cases, segment length is limited by the resolution.

Model number	Display size	Resolution	Touch screen	Keys	Max. segment length
5AP920.1043-01	10.4"	VGA	✓	-	5 m / 10 m ¹⁾
5AP920.1214-01	12.1"	SVGA	✓	-	5 m / 10 m ¹⁾
5AP920.1505-01	15.0"	XGA	✓	-	5 m / 10 m ¹⁾
5AP920.1706-01	17.0"	SXGA	✓	-	5 m / 10 m ¹⁾
5AP920.1906-01	19.0"	SXGA	✓	-	5 m / 10 m ¹⁾

Table 78: Possible Automation Panel devices, resolutions and segment lengths

- 1) USB support is not possible on the Automation Panel 900 in these cases since USB is limited to 5 m.

Information:

When transferring data via DVI, it is not possible to read statistical values from Automation Panel 900 devices.

3.2.5 BIOS settings

No special BIOS settings are necessary for operation.

3.3 One Automation Panel 900 via SDL

An Automation Panel 900 is connected to the integrated SDL interface (onboard) via an SDL cable. USB devices can only be connected directly to the Automation Panel (i.e. without a hub).

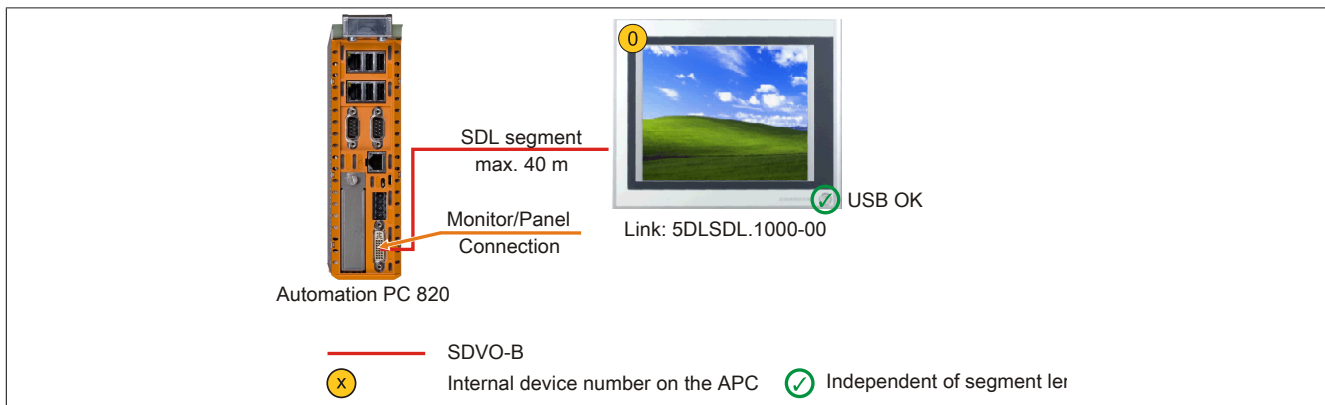

Figure 25: One Automation Panel 900 via SDL

3.3.1 Basic system requirements

The following table shows the possible combinations of APC820 system unit and CPU board to implement the configuration shown in the figure above. If a combination results in a limitation of the maximum resolution, this is also indicated (e.g. when connecting a non-B&R Automation Panel 900 device).

CPU board	with system unit		Limitation Resolution
	5PC820.SX01-00	5PC820.SX01-01	
5PC800.B945-00 5PC800.B945-10	✓	✓	Max. UXGA
5PC800.B945-01 5PC800.B945-11	✓	✓	Max. UXGA
5PC800.B945-02 5PC800.B945-12	✓	✓	Max. UXGA
5PC800.B945-03 5PC800.B945-13	✓	✓	Max. UXGA
5PC800.B945-04 5PC800.B945-14	✓	✓	Max. UXGA

Table 79: Possible combinations of system unit and CPU board

3.3.2 Link modules

Information:

A corresponding Link module must be selected for each device used.

Model number	Description	Note
5DLSDDL.1000-00	Automation Panel Link SDL receiver Connection for SDL In; transmission of display, touch screen, USB 1.1, matrix key and service data; 24 VDC (order screw clamp 0TB103.9 or cage clamp 0TB103.91 separately)	For Automation Panel 900

Table 80: Link modules

3.3.3 Cables

Select an Automation Panel 900 cable from the following table.

Model number	Description	Length
5CASDL.0018-00	SDL cable, 1.8 m	1.8 m ±30 mm
5CASDL.0050-00	SDL cable, 5 m	5 m ±30 mm
5CASDL.0100-00	SDL cable, 10 m	10 m ±50 mm
5CASDL.0150-00	SDL cable, 15 m	15 m ±100 mm
5CASDL.0200-00	SDL cable, 20 m	20 m ±100 mm
5CASDL.0250-00	SDL cable, 25 m	25 m ±100 mm
5CASDL.0300-00	SDL cable, 30 m	30 m ±100 mm
5CASDL.0018-03	SDL flex cable, 1.8 m	1.8 m ±20 mm
5CASDL.0050-03	SDL flex cable, 5 m	5 m ±45 mm
5CASDL.0100-03	SDL flex cable, 10 m	10 m ±90 mm
5CASDL.0150-03	SDL flex cable, 15 m	15 m ±135 mm
5CASDL.0200-03	SDL flex cable, 20 m	20 m ±180 mm

Table 81: Cables for SDL configurations

Model number	Description	Length
5CASDL.0250-03	SDL flex cable, 25 m	25 m ±225 mm
5CASDL.0300-03	SDL flex cable, 30 m	30 m ±270 mm
5CASDL.0300-13	SDL flex cable with extender, 30 m	30 m ±280 mm
5CASDL.0400-13	SDL flex cable with extender, 40 m	40 m ±380 mm
5CASDL.0430-13	SDL flex cable with extender, 43 m	43 m ±410 mm
5CASDL.0018-01	SDL cable with 45° male connector, 1.8 m	1.8 m ±30 mm
5CASDL.0050-01	SDL cable with 45° male connector, 5 m	5 m ±50 mm
5CASDL.0100-01	SDL cable with 45° male connector, 10 m	10 m ±100 mm
5CASDL.0150-01	SDL cable with 45° male connector, 15 m	15 m ±100 mm

Table 81: Cables for SDL configurations

Information:

Detailed technical data about cables can be found in the Automation Panel 900 user's manual. This can be downloaded as a PDF file from the B&R website at www.br-automation.com.

3.3.3.1 Cable lengths and resolutions for SDL transmission

The following table lists the relationship between segment lengths and maximum resolution depending on the SDL cable being used:

SDL cable Segment length [m]	Resolution						
	VGA 640 x 480	SVGA 800 x 600	XGA 1024 x 768	HD 1366 x 768	SXGA 1280 x 1024	UXGA 1600 x 1200	FHD 1920 x 1080
1.8	5CASDL.0018-00	5CASDL.0018-00	5CASDL.0018-00	5CASDL.0018-00	5CASDL.0018-00	5CASDL.0018-00	5CASDL.0018-00
	5CASDL.0018-01	5CASDL.0018-01	5CASDL.0018-01	5CASDL.0018-01	5CASDL.0018-01	5CASDL.0018-01	5CASDL.0018-01
	5CASDL.0018-03	5CASDL.0018-03	5CASDL.0018-03	5CASDL.0018-03	5CASDL.0018-03	5CASDL.0018-03	5CASDL.0018-03
5	5CASDL.0050-00	5CASDL.0050-00	5CASDL.0050-00	5CASDL.0050-00	5CASDL.0050-00	5CASDL.0050-00	5CASDL.0050-00
	5CASDL.0050-01	5CASDL.0050-01	5CASDL.0050-01	5CASDL.0050-01	5CASDL.0050-01	5CASDL.0050-01	5CASDL.0050-01
	5CASDL.0050-03	5CASDL.0050-03	5CASDL.0050-03	5CASDL.0050-03	5CASDL.0050-03	5CASDL.0050-03	5CASDL.0050-03
10	5CASDL.0100-00	5CASDL.0100-00	5CASDL.0100-00	5CASDL.0100-00	5CASDL.0100-00	5CASDL.0100-00	5CASDL.0100-00
	5CASDL.0100-01	5CASDL.0100-01	5CASDL.0100-01	5CASDL.0100-01	5CASDL.0100-01	5CASDL.0100-01	5CASDL.0100-01
	5CASDL.0100-03	5CASDL.0100-03	5CASDL.0100-03	5CASDL.0100-03	5CASDL.0100-03	5CASDL.0100-03	5CASDL.0100-03
15	5CASDL.0150-00	5CASDL.0150-00	5CASDL.0150-00	5CASDL.0150-00	5CASDL.0150-00	-	-
	5CASDL.0150-01	5CASDL.0150-01	5CASDL.0150-01	5CASDL.0150-01	5CASDL.0150-01	-	-
	5CASDL.0150-03	5CASDL.0150-03	5CASDL.0150-03	5CASDL.0150-03	5CASDL.0150-03	-	5CASDL.0150-03
20	5CASDL.0200-00	5CASDL.0200-00	5CASDL.0200-00	5CASDL.0200-00	5CASDL.0200-00	-	-
	5CASDL.0200-03	5CASDL.0200-03	5CASDL.0200-03	5CASDL.0200-03	5CASDL.0200-03	-	5CASDL.0200-03
25	5CASDL.0250-00	5CASDL.0250-00	5CASDL.0250-00	5CASDL.0250-00	-	-	-
	5CASDL.0250-03	5CASDL.0250-03	5CASDL.0250-03	5CASDL.0250-03	-	-	-
30	5CASDL.0300-00	5CASDL.0300-00	-	-	-	-	-
	5CASDL.0300-03	5CASDL.0300-03	5CASDL.0300-13	5CASDL.0300-13	5CASDL.0300-13	-	5CASDL.0300-13
40	5CASDL.0400-13	5CASDL.0400-13	5CASDL.0400-13	5CASDL.0400-13	5CASDL.0400-13	-	5CASDL.0400-13

Table 82: Cable lengths and resolutions for SDL transmission

3.3.4 Settings in BIOS

No special BIOS settings are necessary for operation.

For detailed information, see the user's manual for the B&R Industrial PC being used.

Touch screen functionality

COM C must be enabled in BIOS in order to operate the panel touch screen connected to the monitor/panel interface ("Advanced - Baseboard/Panel features - Legacy devices").

3.4 One Automation Panel 800 via SDL

An Automation Panel 800 is connected to the integrated SDL interface (onboard) via an SDL cable. USB devices can only be connected directly to the extension keyboard (without a hub).

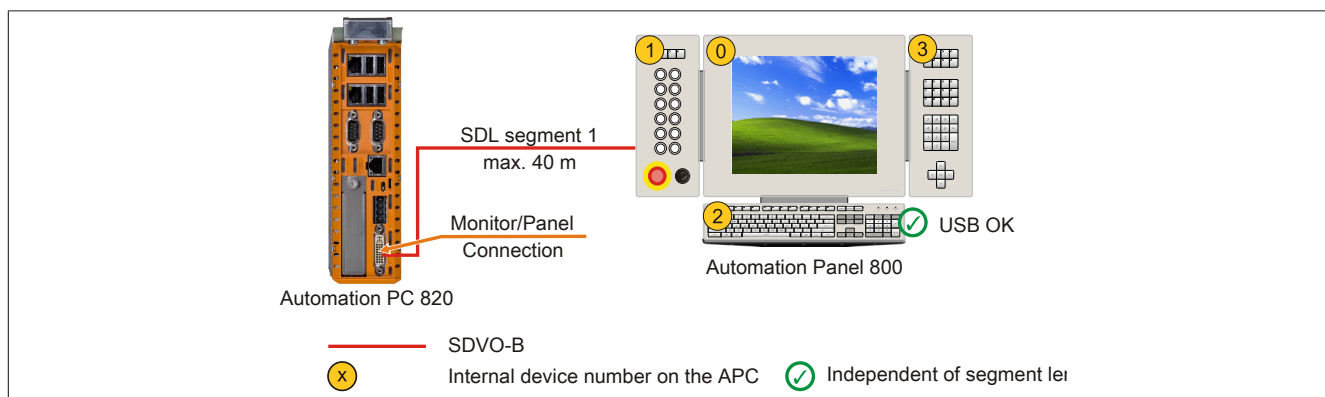

Figure 26: One Automation Panel 800 via SDL

3.4.1 Basic system requirements

The following table shows the possible combinations of APC820 system unit and CPU board to implement the configuration shown in the figure above. If a combination results in a limitation of the maximum resolution, this is also indicated (e.g. when connecting a non-B&R Automation Panel 900 device).

CPU board	with system unit		Limitation Resolution
	5PC820.SX01-00	5PC820.SX01-01	
5PC800.B945-00 5PC800.B945-10	✓	✓	Max. UXGA
5PC800.B945-01 5PC800.B945-11	✓	✓	Max. UXGA
5PC800.B945-02 5PC800.B945-12	✓	✓	Max. UXGA
5PC800.B945-03 5PC800.B945-13	✓	✓	Max. UXGA
5PC800.B945-04 5PC800.B945-14	✓	✓	Max. UXGA

Table 83: Possible combinations of system unit and CPU board

3.4.2 Cables

Select an Automation Panel 800 SDL cable from the following table.

Model number	Description	Length
5CASDL.0018-20	SDL flex cable for the Automation Panel 800, 1.8 m	1.8 m ±20 mm
5CASDL.0050-20	SDL flex cable for the Automation Panel 800, 5 m	5 m ±45 mm
5CASDL.0100-20	SDL flex cable for the Automation Panel 800, 10 m	10 m ±90 mm
5CASDL.0150-20	SDL flex cable for the Automation Panel 800, 15 m	15 m ±135 mm
5CASDL.0200-20	SDL flex cable for the Automation Panel 800, 20 m	20 m ±180 mm
5CASDL.0250-20	SDL flex cable for the Automation Panel 800, 25 m	25 m ±230 mm
5CASDL.0300-30	SDL flex cable with extender for the Automation Panel 800, 30 m	30 m ±280 mm
5CASDL.0400-30	SDL flex cable with extender for the Automation Panel 800, 40 m	40 m ±380 mm

Table 84: Cables for SDL configurations

Information:

Detailed technical data about cables can be found in the Automation Panel 800 user's manual. This can be downloaded as a PDF file from the B&R website at www.br-automation.com.

3.4.2.1 Cable lengths and resolutions for SDL transmission

The following table lists the relationship between segment lengths and maximum resolution depending on the SDL cable being used:

Cables Segment length [m]	Resolution
	XGA 1024 x 768
1.8	5CASDL.0018-20
5	5CASDL.0050-20
10	5CASDL.0100-20
15	5CASDL.0150-20
20	5CASDL.0200-20
25	5CASDL.0250-20
30	5CASDL.0300-30
40	5CASDL.0400-30

Table 85: Cable lengths and resolutions for SDL transmission

3.4.3 Settings in BIOS

No special BIOS settings are necessary for operation.

For detailed information, see the user's manual for the B&R Industrial PC being used.

Touch screen functionality

COM C must be enabled in BIOS in order to operate the panel touch screen connected to the monitor/panel interface ("Advanced - Baseboard/Panel features - Legacy devices").

3.5 One AP900 and one AP800 via SDL

An Automation Panel 900 and an Automation Panel 800 are connected to the integrated SDL interface (onboard) via SDL.

USB is supported up to a maximum distance (segment 1 + segment 2) of 30 m on the two displays. Past a distance of 30 m, USB is only available on the first display (front and back) up to 40 m. USB devices can only be connected directly to the Automation Panel 900 or extension keyboard (without a hub).

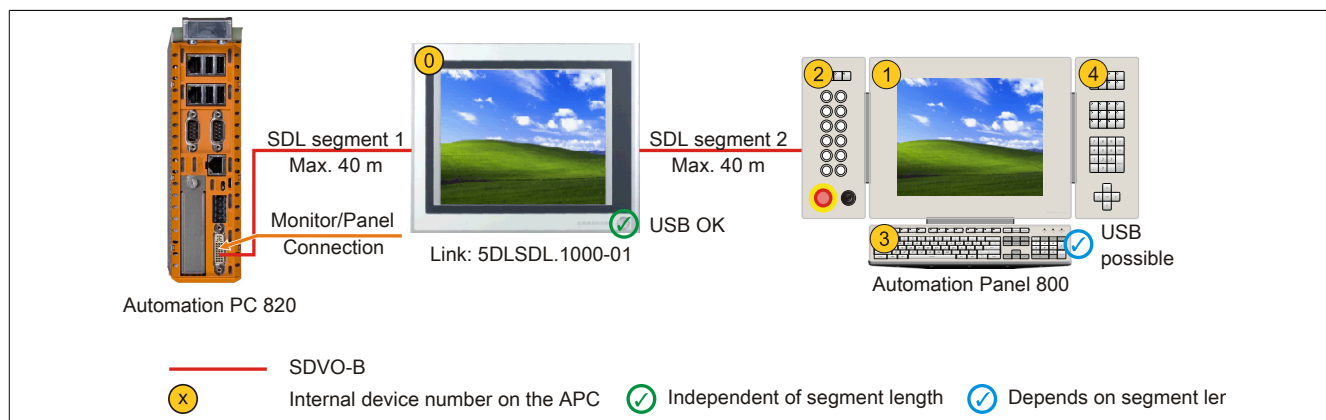

Figure 27: One AP900 and one AP800 via SDL

3.5.1 Basic system requirements

The following table shows the possible combinations of APC820 system unit and CPU board to implement the configuration shown in the figure above. If a combination results in a limitation of the maximum resolution, this is also indicated (e.g. when connecting a non-B&R Automation Panel 900 device).

CPU board	with system unit		Limitation Resolution
	5PC820.SX01-00	5PC820.SX01-01	
5PC800.B945-00 5PC800.B945-10	✓	✓	Max. UXGA
5PC800.B945-01 5PC800.B945-11	✓	✓	Max. UXGA
5PC800.B945-02 5PC800.B945-12	✓	✓	Max. UXGA
5PC800.B945-03 5PC800.B945-13	✓	✓	Max. UXGA
5PC800.B945-04 5PC800.B945-14	✓	✓	Max. UXGA

Table 86: Possible combinations of system unit and CPU board

3.5.2 Link modules

Information:

A corresponding Link module must be selected for each device used.

Model number	Description	Note
5DLSL.1000-01	Automation Panel Link SDL transceiver Connections for SDL In and SDL Out; transmission of display, touch screen, USB 1.1, matrix key and service data; 24 VDC (order screw clamp 0TB103.9 or cage clamp 0TB103.91 separately)	For Automation Panel 900

Table 87: Link modules

3.5.3 Cables

For a selection of SDL cables for connecting the AP900 display to an AP900 display, see "Cables" on page 80.

For a selection of SDL cables for connecting the AP800 display to an AP900 display, see "Cables" on page 82.

Information:

For detailed information regarding cables, see the chapter "Accessories".

3.5.4 Settings in BIOS

No special BIOS settings are necessary for operation.

For detailed information, see the user's manual for the B&R Industrial PC being used.

Touch screen functionality

COM C must be enabled in BIOS in order to operate the panel touch screen connected to the monitor/panel interface ("Advanced - Baseboard/Panel features - Legacy devices").

3.6 Four Automation Panel 900 units via SDL

An Automation Panel 900 is connected to the integrated SDL interface (onboard) via an SDL cable. Up to three other Automation Panels of the same type are connected to this Automation Panel and operated via SDL. All four of the panels show the same content (display clone).

USB is supported up to a maximum distance (SDL segment 1 + SDL segment 2) of 30 m on the first two panels (front and back). Past a distance of 30 m, USB is only available for the first panel (front and back). USB devices can only be connected directly to the Automation Panel (i.e. without a hub).

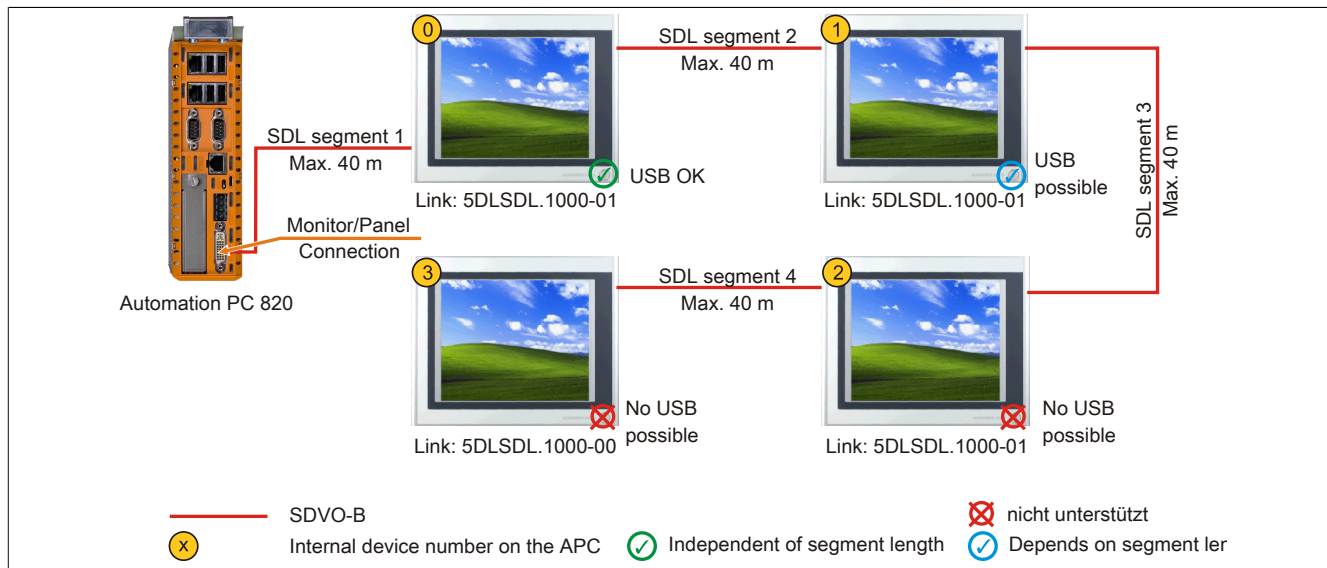

Figure 28: Four Automation Panel 900 units via SDL

3.6.1 Basic system requirements

The following table shows the possible combinations of APC820 system unit and CPU board to implement the configuration shown in the figure above. If a combination results in a limitation of the maximum resolution, this is also indicated (e.g. when connecting a non-B&R Automation Panel 900 device).

CPU board	with system unit		Limitation Resolution
	5PC820.SX01-00	5PC820.SX01-01	
5PC800.B945-00 5PC800.B945-10	✓	✓	Max. UXGA
5PC800.B945-01 5PC800.B945-11	✓	✓	Max. UXGA
5PC800.B945-02 5PC800.B945-12	✓	✓	Max. UXGA
5PC800.B945-03 5PC800.B945-13	✓	✓	Max. UXGA
5PC800.B945-04 5PC800.B945-14	✓	✓	Max. UXGA

Table 88: Possible combinations of system unit and CPU board

3.6.2 Link modules

Information:

A corresponding Link module must be selected for each device used.

Model number	Description	Note
5DLSDL.1000-00	Automation Panel Link SDL receiver Connection for SDL In; transmission of display, touch screen, USB 1.1, matrix key and service data; 24 VDC (order screw clamp 0TB103.9 or cage clamp 0TB103.91 separately)	For Automation Panel 900
5DLSDL.1000-01	Automation Panel Link SDL transceiver Connections for SDL In and SDL Out; transmission of display, touch screen, USB 1.1, matrix key and service data; 24 VDC (order screw clamp 0TB103.9 or cage clamp 0TB103.91 separately)	For Automation Panel 900

Table 89: Link modules

3.6.3 Cables

Select an Automation Panel 900 cable from the following table.

Model number	Description	Length
5CASDL.0018-00	SDL cable, 1.8 m	1.8 m ±30 mm
5CASDL.0050-00	SDL cable, 5 m	5 m ±30 mm
5CASDL.0100-00	SDL cable, 10 m	10 m ±50 mm
5CASDL.0150-00	SDL cable, 15 m	15 m ±100 mm
5CASDL.0200-00	SDL cable, 20 m	20 m ±100 mm
5CASDL.0250-00	SDL cable, 25 m	25 m ±100 mm
5CASDL.0300-00	SDL cable, 30 m	30 m ±100 mm
5CASDL.0018-03	SDL flex cable, 1.8 m	1.8 m ±20 mm
5CASDL.0050-03	SDL flex cable, 5 m	5 m ±45 mm
5CASDL.0100-03	SDL flex cable, 10 m	10 m ±90 mm
5CASDL.0150-03	SDL flex cable, 15 m	15 m ±135 mm
5CASDL.0200-03	SDL flex cable, 20 m	20 m ±180 mm
5CASDL.0250-03	SDL flex cable, 25 m	25 m ±225 mm
5CASDL.0300-03	SDL flex cable, 30 m	30 m ±270 mm
5CASDL.0300-13	SDL flex cable with extender, 30 m	30 m ±280 mm
5CASDL.0400-13	SDL flex cable with extender, 40 m	40 m ±380 mm
5CASDL.0430-13	SDL flex cable with extender, 43 m	43 m ±410 mm
5CASDL.0018-01	SDL cable with 45° male connector, 1.8 m	1.8 m ±30 mm
5CASDL.0050-01	SDL cable with 45° male connector, 5 m	5 m ±50 mm
5CASDL.0100-01	SDL cable with 45° male connector, 10 m	10 m ±100 mm
5CASDL.0150-01	SDL cable with 45° male connector, 15 m	15 m ±100 mm

Table 90: Cables for SDL configurations

Information:

Detailed technical data about cables can be found in the Automation Panel 900 user's manual. This can be downloaded as a PDF file from the B&R website at www.br-automation.com.

3.6.3.1 Cable lengths and resolutions for SDL transmission

The following table lists the relationship between segment lengths and maximum resolution depending on the SDL cable being used:

SDL cable Segment length [m]	Resolution						
	VGA 640 x 480	SVGA 800 x 600	XGA 1024 x 768	HD 1366 x 768	SXGA 1280 x 1024	UXGA 1600 x 1200	FHD 1920 x 1080
1.8	5CASDL.0018-00	5CASDL.0018-00	5CASDL.0018-00	5CASDL.0018-00	5CASDL.0018-00	5CASDL.0018-00	5CASDL.0018-00
	5CASDL.0018-01	5CASDL.0018-01	5CASDL.0018-01	5CASDL.0018-01	5CASDL.0018-01	5CASDL.0018-01	5CASDL.0018-01
	5CASDL.0018-03	5CASDL.0018-03	5CASDL.0018-03	5CASDL.0018-03	5CASDL.0018-03	5CASDL.0018-03	5CASDL.0018-03
5	5CASDL.0050-00	5CASDL.0050-00	5CASDL.0050-00	5CASDL.0050-00	5CASDL.0050-00	5CASDL.0050-00	5CASDL.0050-00
	5CASDL.0050-01	5CASDL.0050-01	5CASDL.0050-01	5CASDL.0050-01	5CASDL.0050-01	5CASDL.0050-01	5CASDL.0050-01
	5CASDL.0050-03	5CASDL.0050-03	5CASDL.0050-03	5CASDL.0050-03	5CASDL.0050-03	5CASDL.0050-03	5CASDL.0050-03
10	5CASDL.0100-00	5CASDL.0100-00	5CASDL.0100-00	5CASDL.0100-00	5CASDL.0100-00	5CASDL.0100-00	5CASDL.0100-00
	5CASDL.0100-01	5CASDL.0100-01	5CASDL.0100-01	5CASDL.0100-01	5CASDL.0100-01	5CASDL.0100-01	5CASDL.0100-01
	5CASDL.0100-03	5CASDL.0100-03	5CASDL.0100-03	5CASDL.0100-03	5CASDL.0100-03	5CASDL.0100-03	5CASDL.0100-03
15	5CASDL.0150-00	5CASDL.0150-00	5CASDL.0150-00	5CASDL.0150-00	5CASDL.0150-00	-	-
	5CASDL.0150-01	5CASDL.0150-01	5CASDL.0150-01	5CASDL.0150-01	5CASDL.0150-01	-	-
	5CASDL.0150-03	5CASDL.0150-03	5CASDL.0150-03	5CASDL.0150-03	5CASDL.0150-03	-	5CASDL.0150-03
20	5CASDL.0200-00	5CASDL.0200-00	5CASDL.0200-00	5CASDL.0200-00	5CASDL.0200-00	-	-
	5CASDL.0200-03	5CASDL.0200-03	5CASDL.0200-03	5CASDL.0200-03	5CASDL.0200-03	-	5CASDL.0200-03
25	5CASDL.0250-00	5CASDL.0250-00	5CASDL.0250-00	5CASDL.0250-00	-	-	-
	5CASDL.0250-03	5CASDL.0250-03	5CASDL.0250-03	5CASDL.0250-03	-	-	-
30	5CASDL.0300-00	5CASDL.0300-00	-	-	-	-	-
	5CASDL.0300-03	5CASDL.0300-03	5CASDL.0300-13	5CASDL.0300-13	5CASDL.0300-13	-	5CASDL.0300-13
40	5CASDL.0400-13	5CASDL.0400-13	5CASDL.0400-13	5CASDL.0400-13	5CASDL.0400-13	-	5CASDL.0400-13

Table 91: Cable lengths and resolutions for SDL transmission

3.6.4 Settings in BIOS

No special BIOS settings are necessary for operation.

For detailed information, see the user's manual for the B&R Industrial PC being used.

Touch screen functionality

COM C must be enabled in BIOS in order to operate the panel touch screen connected to the monitor/panel interface ("Advanced - Baseboard/Panel features - Legacy devices").

4 Connecting peripheral USB devices

Warning!

Peripheral USB devices can be connected to the USB interfaces on this device. Due to the vast number of USB devices available on the market, B&R cannot guarantee their performance. USB devices from B&R are guaranteed to function properly, however.

4.1 Locally on the APC820

Many different peripheral USB devices can be connected to the 5 USB interfaces on this device. USB ports USB1, USB3 and USB5 can each handle a load of 1 A, and USB ports USB2 and USB4 can each handle a load of 500 mA. The maximum transfer rate is USB 2.0.



Figure 29: Local connection of USB peripheral devices on the APC820

4.2 Remote connection to Automation Panel 900 via DVI

Many different peripheral USB devices can be connected to the 2 or 3 USB interfaces on the Automation Panel 900. These can each handle a load of 500 mA. The maximum transfer rate is USB 2.0.

Information:

Only end devices (not hubs) can be connected to the Automation Panel 900.



Figure 30: Remote connection of USB peripheral devices on the APC900 via DVI

4.3 Remote connection to Automation Panel 800 / 900 via SDL

Many different peripheral USB devices can be connected to the 2 or 3 USB interfaces on Automation Panel 900 or the USB interfaces on Automation Panel 800 devices. These can each handle a load of 500 mA. The maximum transfer rate is USB 1.1.

Information:

Only end devices (no hubs) can be connected to the Automation Panel 800 / 900.

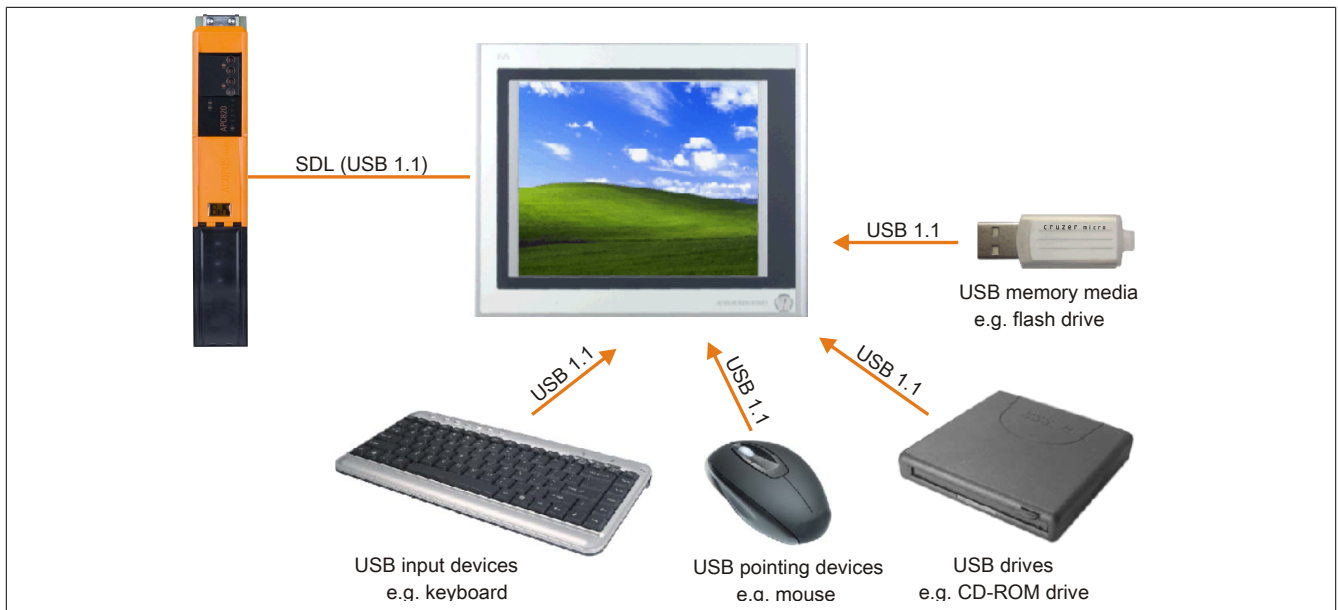

Figure 31: Remote connection of USB peripheral devices on the APC800/900 via SDL

5 Known problems / issues

The following issues for the APC820 devices are known:

- Using two different types of CompactFlash cards can cause problems in Automation PCs and Panel PCs. This can result in one of the two cards not being detected during system startup. This is caused by varying startup speeds. CompactFlash cards with older technology require significantly more time during system startup than CompactFlash cards with newer technology. This behavior occurs near the limits of the time frame provided for startup. This can occur because the startup time for the CompactFlash cards fluctuates due to the variance of the components being used. Depending on the CompactFlash cards being used, this error may occur never, sometimes or always.
- During daisy chain operation of multiple AP800/AP900 devices via SDL, it's possible that the touch controller status shows a red "X" in the Control Center applet for the touch screen driver when the touch controller is detected. The functionality of the touch system is not affected by this. This can be avoided by setting a panel locking time of 50 ms. The panel locking time can be configured with the B&R Key Editor.
- HD resolution (1366x768) is not completely supported by VBIOS, which causes display errors after POST. The image flickers and is shifted down a line. BIOS POST and BIOS Setup are still displayed correctly, however. This effect occurs when using operating systems for which no driver is available (e.g. MS-DOS) or before the operating system's graphics driver is started (e.g. Windows XP boot logo). HD resolution is displayed corrected again when Windows XP or Windows 7 is booted properly with an installed graphics driver.

Chapter 4 • Software

1 BIOS options

Information:

The following diagrams, BIOS menu items and their descriptions refer to BIOS version 1.18. It is therefore possible that these diagrams and BIOS descriptions do not correspond with the installed BIOS version.

1.1 General information

BIOS is an acronym for "Basic Input/Output System". It is the most basic standardized interface between the user and the system (hardware). The BIOS system used in this B&R Industrial PC was developed by American Megatrends, Inc.

The BIOS Setup utility can be used to modify basic system configuration settings. These settings are stored in CMOS and EEPROM memory (as a backup).

CMOS data is buffered by a battery (if present) and remains stored on the B&R Industrial PC even when the power is turned off (no 24 VDC supply).

1.2 BIOS setup and boot procedure

BIOS is activated immediately when switching on the power supply or pressing the power button on the B&R Industrial PC. The system checks if the setup data from EEPROM memory is "OK". If the data is "OK", then it is transferred to CMOS. If the data is "Not OK", then the CMOS data is checked to see whether it is valid. An error message is output if the CMOS data contains errors, and the boot procedure can be continued by pressing <F1>. To prevent an error message from appearing on each restart, launch the BIOS Setup utility by pressing <F2> and resave the settings.

BIOS reads the system configuration information, checks and configures the system with the Power-On Self-Test (POST).

When these "preliminaries" are finished, BIOS looks for an operating system on the available data storage devices (hard drive, floppy drive, etc.). BIOS then launches the operating system and hands over to it the control of system operations.

To enter BIOS Setup, press the key after the USB controller has been initialized as soon as the following message appears on the screen (during POST): "Press DEL to run SETUP".

```
AMIBIOS(C)2005 American Megatrends, Inc.  
[APC2R118] Bernecker + Rainer Industrie-Elektronik H1.18  
Serial Number : 133453  
CPU : Intel(R) Core(TM)2 CPU L7400 @ 1.50GHz  
Speed : 1.50 Ghz  
Press DEL to run Setup  
Press F11 for BIOS POPUP  
The MCH is operating with DDR2-677/CL5 in Dual-Channel Interleaved Mode  
Initializing USB Controllers .. Done  
3064 MB OK  
USB Device(s): 1 Keyboard, 1 Hub  
Sec Master: SILICONSYSTEMS INC 4GB 240-0230  
Auto-Detecting USB Mass Storage Devices ..  
00 USB mass storage devices found an configured.
```

Figure 32: Boot Screen

1.3 BIOS Setup keys

The following keys are enabled during POST:

Information:

Key signals from USB keyboards will only be registered after the USB controller has been initialized.

Keys	Function
Del	Opens the main BIOS Setup screen
F12	Network boot
F11	Opens the boot menu. This lists all bootable devices that are connected to the system. Selecting a device with cursor ↑, cursor ↓ and the pressing <ENTER> will boot from that device.
	
<Pause>	Pauses POST. Pressing any other key resumes POST.

Table 92: BIOS-relevant keys for POST

The following keys can be used once inside BIOS Setup:

Key	Function
F1	Opens general help information
Cursor ↑	Moves to the previous item
Cursor ↓	Moves to the next item
Cursor ←	Moves to the previous item
Cursor →	Moves to the next item
+/-	Changes the setting for the selected function
Enter	Changes to the selected screen
Page ↑	Changes to the previous page
Page ↓	Changes to the next page
Pos 1	Jumps to the first BIOS menu item or object
End	Jumps to the last BIOS menu item or object
F2 / F3	Changes the colors of BIOS Setup
F7	Resets any changes
F9	Loads and configures CMOS default values for all BIOS settings
F10	Saves and exits
ESC	Exits a submenu

Table 93: BIOS-relevant keys

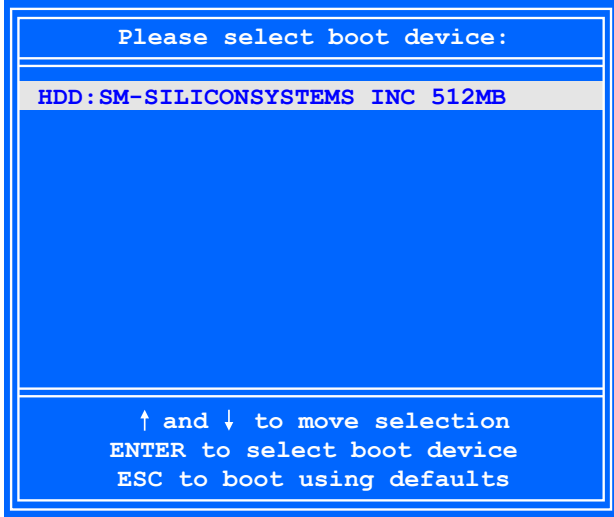
1.4 Main

Immediately after the DEL button is pressed during startup, the main BIOS setup menu appears.

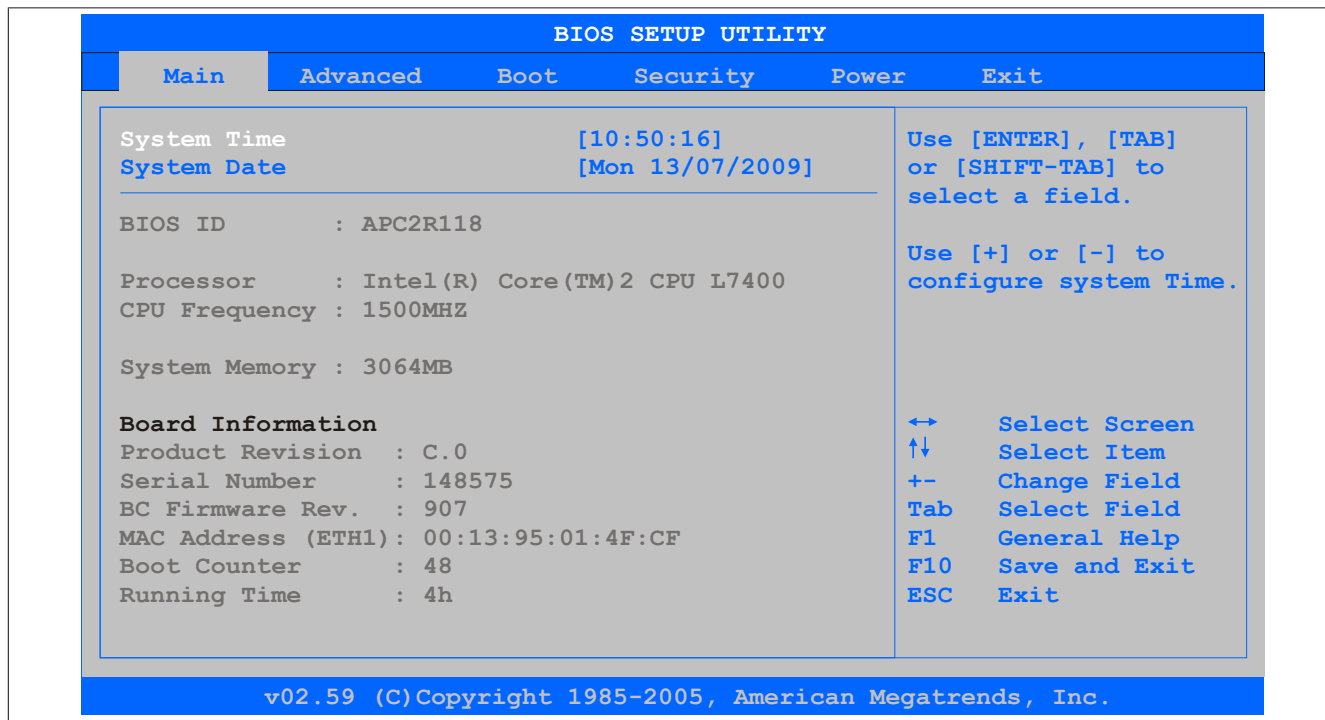

Figure 33: BIOS Main Menü

BIOS setting	Meaning	Setting options	Effect
System Time	This is the current system time setting. Buffered by a battery (CMOS battery) after the system has been switched off.	Adjustment of the system time	Sets the system time in the format Hour:Minute:Second (hh:mm:ss).
System Date	This is the current system date setting. Buffered by a battery (CMOS battery) after the system has been switched off.	Changes to the system date	Sets the system date in the format Month:Day:Year (mm:dd:yyyy).
BIOS ID	Displays the BIOS recognition.	None	-
Processor	Displays the processor type.	None	-
CPU Frequency	Displays the processor frequency.	None	-
System Memory	Displays the system memory size.	None	-
Product Revision	Displays the CPU board HW revision.	None	-
Serial Number	Displays the CPU board serial number.	None	-
BC Firmware Rev.	Displays the CPU board controller firmware revision.	None	-
MAC Address (ETH1)	Displays the MAC addresses assigned for the ETH1 interface.	None	-
Boot Counter	Displays the boot counter - each restart increments the counter by one (max. 1677215).	None	-
Running Time	Displays the runtime in whole hours. (max. 65535).	None	-

Table 94: 945GME - Main Menu - Setting options

1.5 Advanced

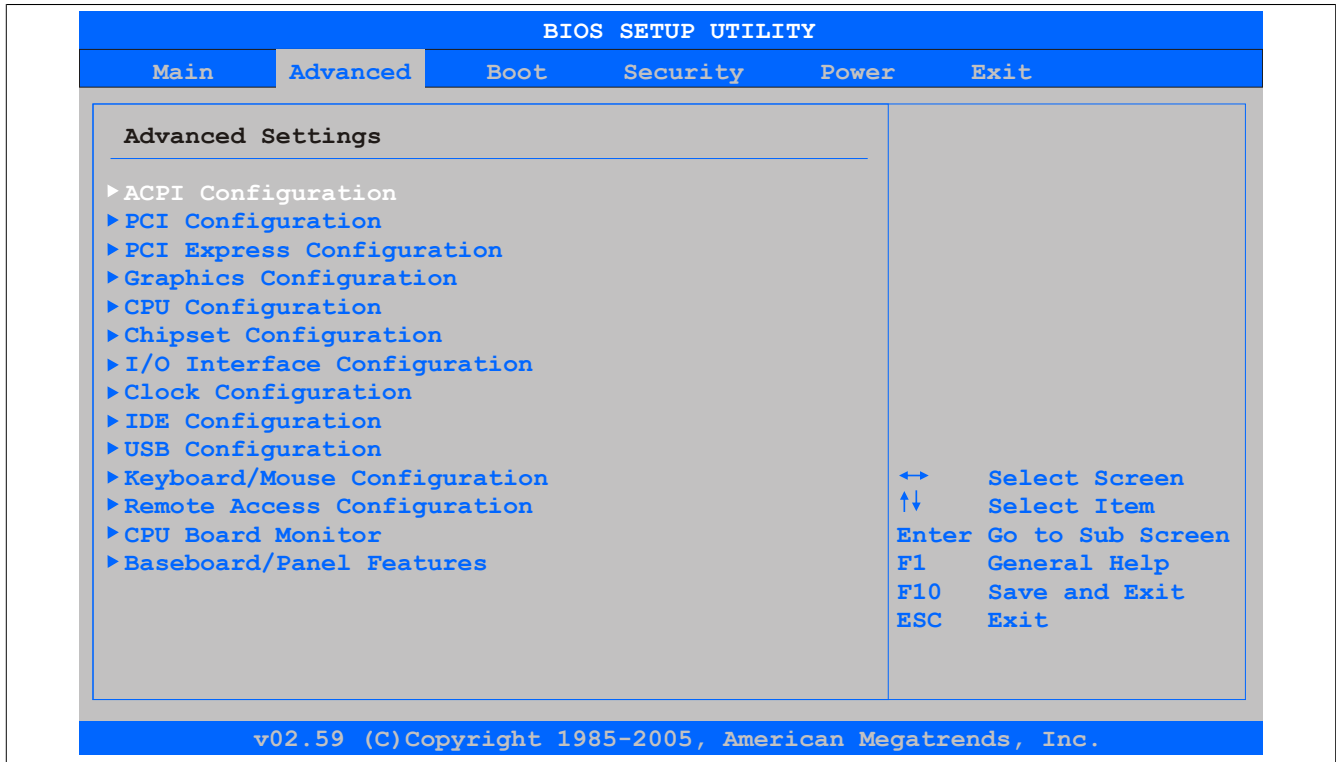

Figure 34: 945GME Advanced Menü

BIOS setting	Meaning	Setting options	Effect
ACPI configuration	Configures the ACPI devices.	Enter	Opens the submenu see "ACPI Configuration" on page 96
PCI Configuration	Configures PCI devices.	Enter	Opens the submenu see "PCI Configuration" on page 97
PCI express configuration	Configures the PCI Express.	Enter	Opens the submenu see "PCI Express Configuration" on page 100
Graphics configuration	Configures graphics settings	Enter	Opens the submenu see "Graphics Configuration" on page 102
CPU configuration	Configures the CPU settings.	Enter	Opens the submenu see "CPU Configuration" on page 104
Chipset configuration	Configures the chipset functions.	Enter	Opens the submenu see "Chipset Configuration" on page 105
I/O interface configuration	Configures the I/O devices.	Enter	Opens the submenu see "I/O Interface Configuration" on page 106
Clock configuration	Configures the clock settings.	Enter	Opens the submenu see "Clock Configuration" on page 107
IDE Configuration	Configures IDE functions	Enter	Opens the submenu see "IDE Configuration" on page 107
USB Configuration	Configures USB settings	Enter	Opens the submenu see "USB Configuration" on page 112
Keyboard/mouse configuration	Configures the keyboard/mouse options.	Enter	Opens the submenu see "Keyboard/Mouse Configuration" on page 114
Remote access configuration	Configures the remote access settings.	Enter	Opens the submenu see "Remote access configuration" on page 114
CPU Board Monitor	Displays the current voltages and temperature of the processor in use.	Enter	Opens the submenu see "CPU Board Monitor" on page 116
Main Board/Panel Features	Displays device specific information and setup of device specific values.	Enter	Opens the submenu see "Baseboard/Panel Features" on page 117

Table 95: 945GME Advanced Menu (Setting options)

1.5.1 ACPI Configuration

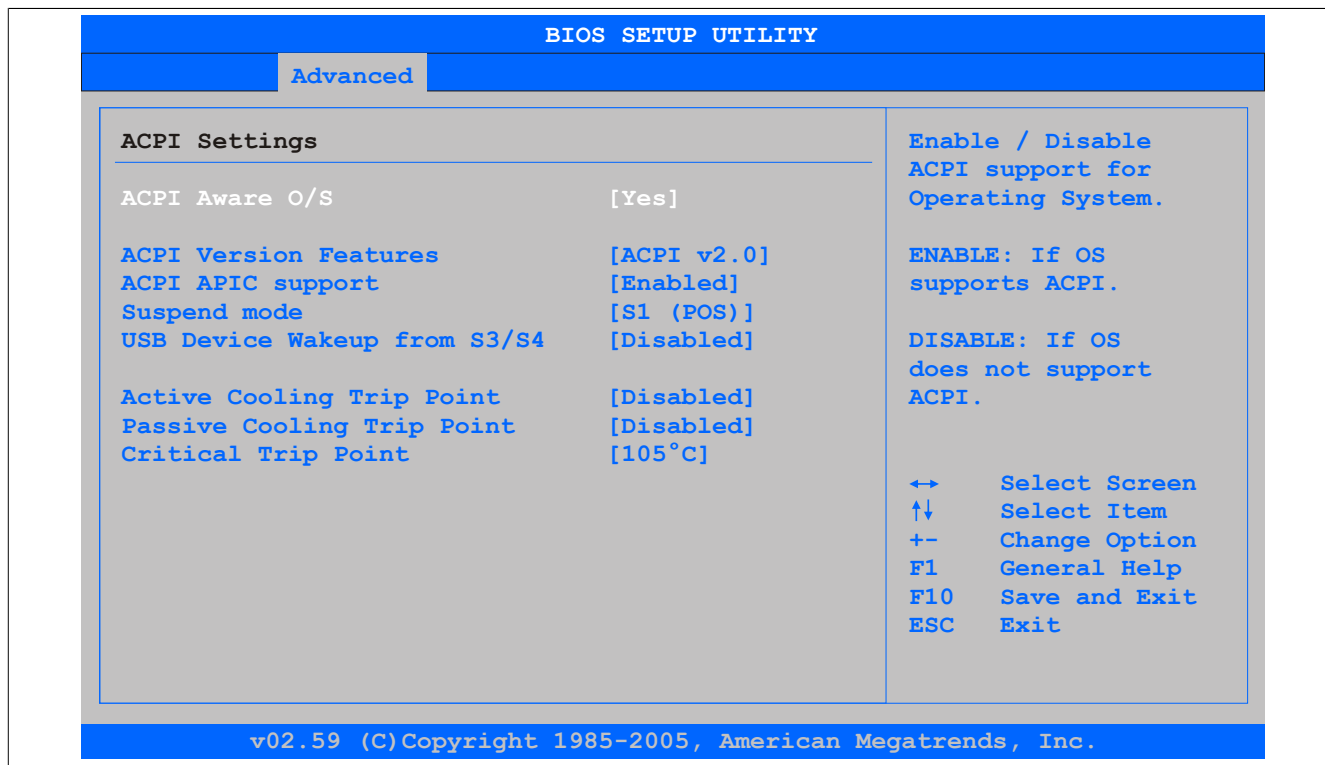

Figure 35: 945GME Advanced ACPI Configuration

BIOS setting	Meaning	Setting options	Effect
ACPI Aware O/S	This function determines if the operating system supports the ACPI function (Advanced Configuration and Power Interface).	Yes	The operating system supports ACPI.
		No	The operating system does not support ACPI.
ACPI Version Features	Option for setting the power option specifications to be supported. The ACPI functions must be supported by the drivers and operating systems being used.	ACPI v1.0	ACPI functions in accordance with v1.0.
		ACPI v2.0	ACPI functions in accordance with v2.0.
		ACPI v3.0	ACPI functions in accordance with v3.0.
ACPI APIC support	This option controls the support of the advanced programmable interrupt controller in the processor.	Enabled	Enables this function.
		Disabled	Disables this function.
Suspend mode	Selects the ACPI status to be used when Suspend Mode is enabled.	S1 (POS)	Sets S1 as Suspend mode. Only a few functions are disabled and are available again at the touch of a button
		S3 (STR)	Sets S3 as Suspend Mode. The current state of the operating system is written to the RAM, which is then supplied solely with power.
USB Device Wakeup from S3/S4	This options makes it possible for activity on a connected USB device to wake the system up from the S3/S4 standby mode.	Enabled	Enables this function.
		Disabled	Disables this function.
Active Cooling Trip Point	With this function, an optional CPU fan above the operating system can be set to turn on when the CPU reaches the set temperature.	Disabled	Disables this function.
		50°C, 60°C, 70°C, 80°C, 90°C	Temperature setting for the active cooling trip point. Can be set in 10 degree increments.
Passive Cooling Trip Point	With this function, a temperature can be set at which the CPU automatically reduces its speed.	Disabled	Disables this function.
		50°C, 60°C, 70°C, 80°C, 90°C	Temperature setting for the passive cooling trip point. Can be set in 10 degree increments.
Critical Trip Point	With this function, a temperature can be set at which the operating system automatically shuts itself down.	80°C, 85°C, 90°C, 95°C, 100°C, 105°C, 110°C	Temperature setting for the critical trip point. Can be set in 5 degree increments.

Table 96: 945GME - Advanced ACPI configuration - Setting options

1.5.2 PCI Configuration

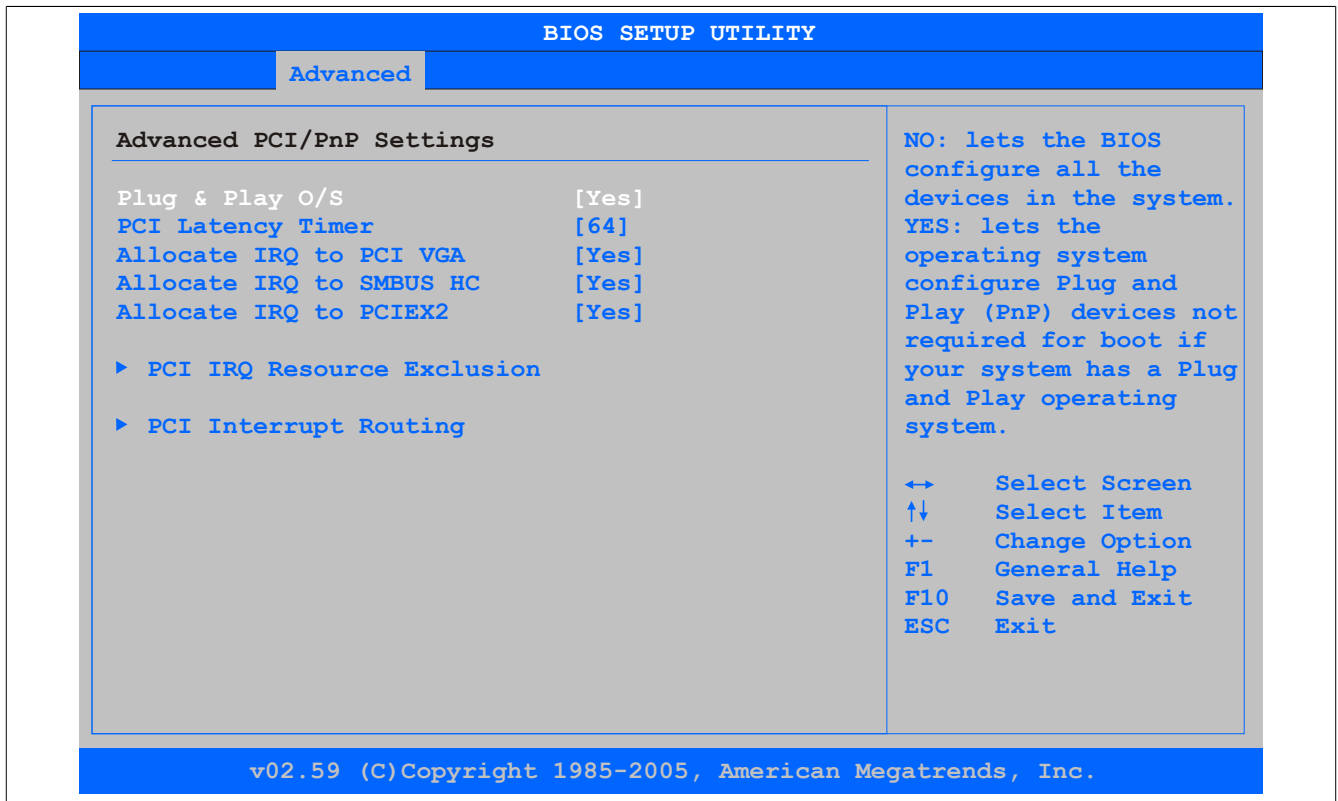

Figure 36: 945GME Advanced PCI Configuration

BIOS setting	Meaning	Setting options	Effect
Plug & Play O/S	BIOS is informed if Plug & Play is capable on the operating system.	Yes	The operating system handles the distribution of resources.
		No	BIOS handles the distribution of resources.
PCI Latency Timer	This option controls how long (in PCI ticks) one PCI bus card can continue to use the master after another PCI card has requested access.	32, 64, 96, 128, 160, 192, 224, 248	Manually sets the value in PCI ticks.
Allocate IRQ to PCI VGA	This function is used to determine if an interrupt is assigned to the PCI VGA.	Yes	Automatic assignment of an interrupt.
		No	No assignment of an interrupt.
Allocate IRQ to SMBUS HC	Use this function to set whether or not the SM (System Management) bus controller is assigned a PCI interrupt.	Yes	Automatic assignment of a PCI interrupt.
		No	No assignment of an interrupt.
Allocate IRQ to PCIEX2	Use this function to set whether or not the PCIEX2 is assigned a PCI interrupt.	Yes	Automatic assignment of a PCI interrupt.
		No	No assignment of an interrupt.
PCI IRQ Resource Exclusion	Configures the PCI IRQ resource settings for ISA Legacy devices.	Enter	Opens the submenu see "PCI IRQ Resource Exclusion" on page 98
PCI Interrupt Routing	Configures PCI interrupt routing	Enter	Opens the submenu see "PCI Configuration" on page 99

Table 97: 945GME - Advanced PCI configuration - Setting options

1.5.2.1 PCI IRQ Resource Exclusion

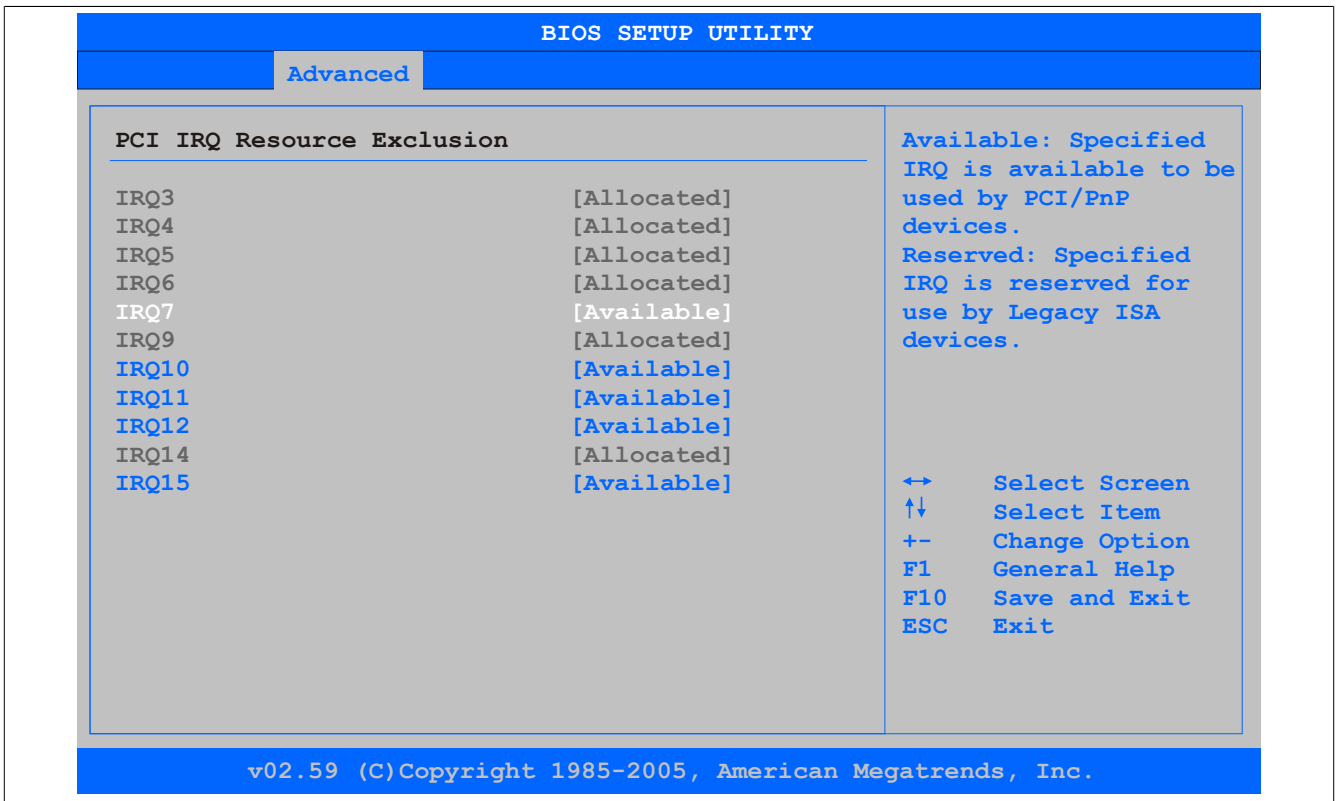

Figure 37: 945GME Advanced PCI IRQ Resource Exclusion

BIOS setting	Meaning	Setting options	Effect
IRQx	IRQ interrupt routing for Legacy ISA devices.	Allocated	Allocated by the system - cannot be used.
		Available	Available - can be used.
		Reserved	Reserved - cannot be used.

Table 98: 945GME - Advanced PCI IRQ Resource Exclusion - Setting options

1.5.2.2 PCI Configuration

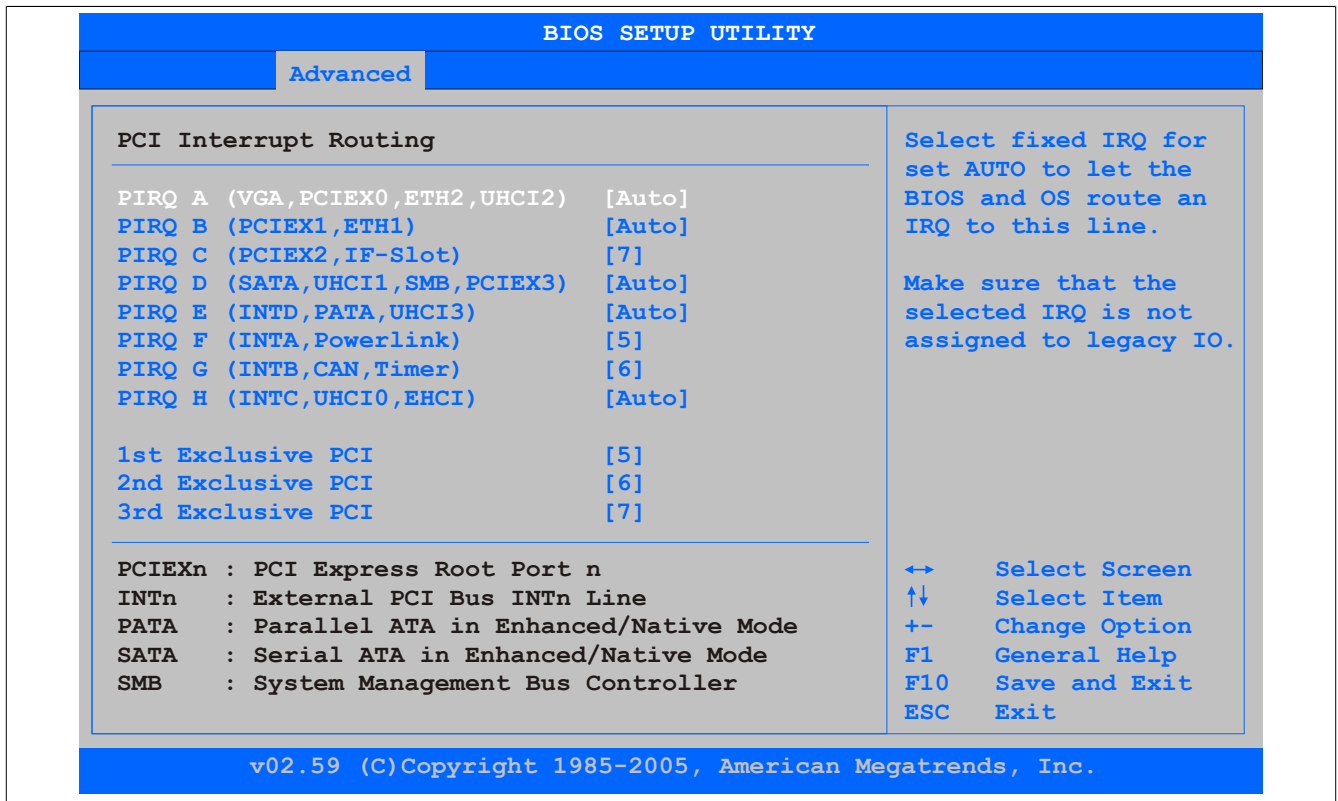

Figure 38: 945GME Advanced PCI Interrupt Routing

BIOS setting	Meaning	Setting options	Effect
PIRQ A (VGA, PCIEX0, ETH2, UHCI2)	Option for setting the PIRQ A.	Auto	Automatic assignment by the BIOS and operating system.
		5,6,7,9,10,12	Manual assignment
PIRQ B (PCIEX1, ETH1)	Option for setting the PIRQ B.	Auto	Automatic assignment by the BIOS and operating system.
		5,6,7,9,10,12	Manual assignment
PIRQ C (PCIEX2, IF slot)	Option for setting the PIRQ C.	Auto	Automatic assignment by the BIOS and operating system.
		5,6,7,9,10,12	Manual assignment
PIRQ D (SATA, UHCI1, SMB, PCIEX3)	Option for setting the PIRQ D.	Auto	Automatic assignment by the BIOS and operating system.
		5,6,7,9,10,12	Manual assignment
PIRQ E (INTD, PATA, UHCI3)	Option for setting the PIRQ E.	Auto	Automatic assignment by the BIOS and operating system.
		5,6,7,9,10,12	Manual assignment
PIRQ F (INTA, POWERLINK)	Option for setting the PIRQ F.	Auto	Automatic assignment by the BIOS and operating system.
		5,6,7,9,10,12	Manual assignment
PIRQ G (INTB, CAN, Timer)	Option for setting the PIRQ G.	Auto	Automatic assignment by the BIOS and operating system.
		5,6,7,9,10,12	Manual assignment
PIRQ H (INTC, UHCI0, EHCI)	Option for setting the PIRQ H.	Auto	Automatic assignment by the BIOS and operating system.
		5,6,7,9,10,12	Manual assignment
1st Exclusive PCI	With this option you can determine if the IRQ assigned to the PIRQ x is handled exclusively (no IRQ sharing). Information: Is only displayed if a PIRQ is manually set (e.g. 5).	None	No interrupt is assigned.
		x	Assigns the PIRQ as 1st exclusive PCI IRQ.

Table 99: 945GME - Advanced PCI Interrupt Routing - Setting options

BIOS setting	Meaning	Setting options	Effect
2nd Exclusive PCI	With this option you can determine if the IRQ assigned to the PIRQ x is handled exclusively (no IRQ sharing). Information: Only displayed when two PIRQs are set manually.	None	No interrupt is assigned.
		x	Assigns the PIRQ as 2nd exclusive PCI IRQ.
3rd Exclusive PCI	With this option you can determine if the IRQ assigned to the PIRQ x is handled exclusively (no IRQ sharing). Information: Only displayed when three PIRQs are set manually.	None	No interrupt is assigned.
		x	Assigns the PIRQ as 3rd exclusive PCI IRQ.

Table 99: 945GME - Advanced PCI Interrupt Routing - Setting options

1.5.3 PCI Express Configuration

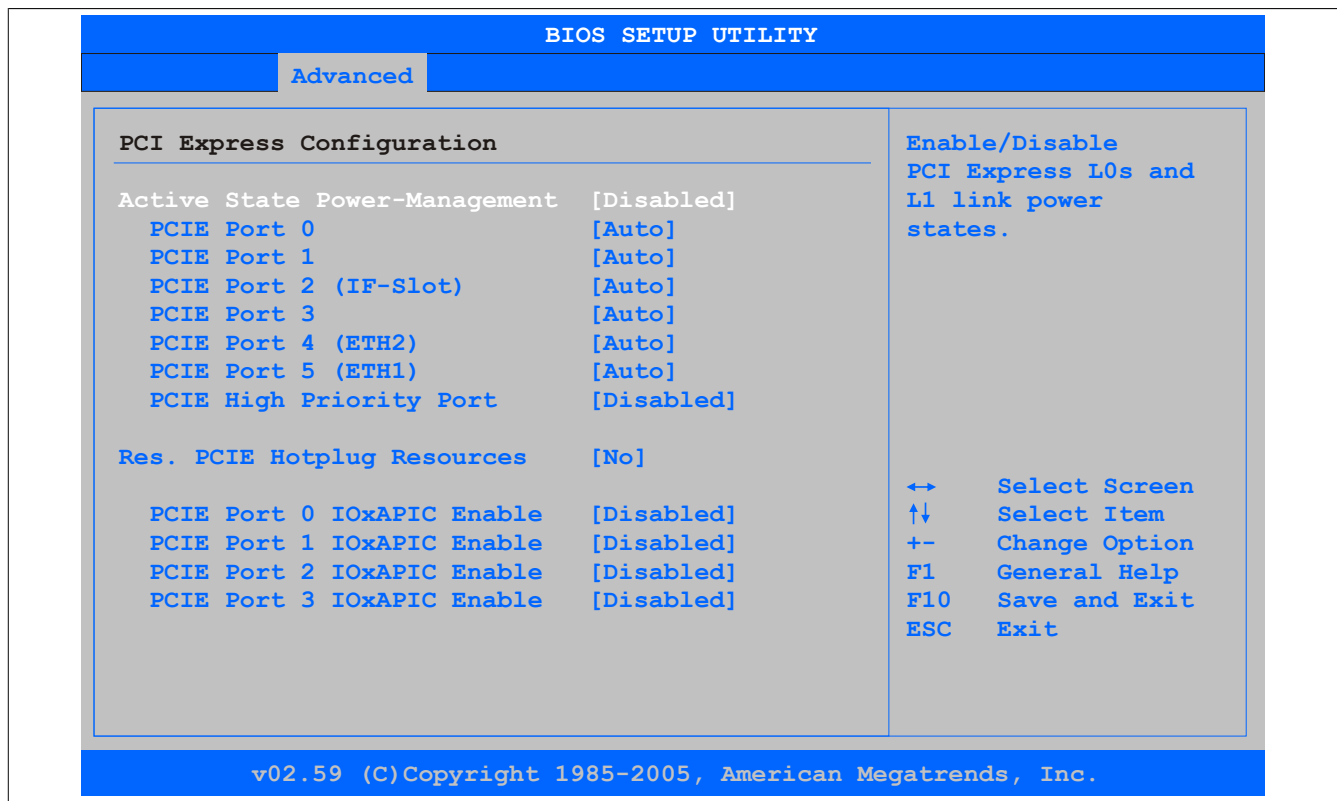

Figure 39: 945GME Advanced PCI Express Configuration

BIOS setting	Meaning	Setting options	Effect
Active State Power Management	Option for setting a power saving function (L0s/L1) for PCIE slots if they do not require full power.	Disabled	Disables this function.
		Enabled	Enables this function.
PCIE Port 0	This option activates or deactivates the PCI Express connection function. Information: If you are not using any PCI Express devices, this option should be deactivated.	Auto	Automatic assignment by the BIOS and operating system.
		Enabled	Enables this function.
		Disabled	Disables this function.
PCIE Port 1	This option activates or deactivates the PCI Express connection function. Information: If you are not using any PCI Express devices, this option should be deactivated.	Auto	Automatic assignment by the BIOS and operating system.
		Enabled	Enables this function.
		Disabled	Disables this function.
PCIE Port 2 (IF slot)	This option activates or deactivates the PCI Express connection function.	Auto	Automatic assignment by the BIOS and operating system.

Table 100: 945GME Advanced PCI Express Configuration (Setting options)

BIOS setting	Meaning	Setting options	Effect
	Information: If you are not using any PCI Express devices, this option should be deactivated.	Enabled	Enables this function.
		Disabled	Disables this function.
PCIE Port 3	This option activates or deactivates the PCI Express connection function. Information: If you are not using any PCI Express devices, this option should be deactivated.	Auto	Automatic assignment by the BIOS and operating system.
		Enabled	Enables this function.
		Disabled	Disables this function.
PCIE Port 4 (ETH2)	This option activates or deactivates the PCI Express connection function. Information: If you are not using any PCI Express devices, this option should be deactivated.	Auto	Automatic assignment by the BIOS and operating system.
		Enabled	Enables this function.
		Disabled	Enables this function.
PCIE Port 5 (ETH1)	This option activates or deactivates the PCI Express connection function. Information: If you are not using any PCI Express devices, this option should be deactivated.	Auto	Automatic assignment by the BIOS and operating system.
		Enabled	Enables this function.
		Disabled	Disables this function.
PCIE High Priority Port	This option activates or deactivates the priority port for PCIE.	Disabled	Disables this function.
		Port 0	Activates Port 0 as priority port.
		Port 1	Activates Port 1 as priority port.
		Port 2	Activates Port 2 as priority port.
		Port 3	Activates Port 3 as priority port.
		ETH2	Activates ETH2 as priority port.
Res. PCIE Hot Plugging Resource	This option can be used to reserve an I/O and memory resource for a free PCIE port. A PCIE port must be set to enabled and resources must be reserved to support ExpressCard hot-plugging on a port.	No	Resource is not reserved.
		Yes	Resource is reserved.
PCIE Port 0 IOxAPIC Enable	This option is used to enable or disable the APIC (Advanced Programmable Interrupt Controller) on the PCIE port 0. The IRQ resources available to the system are expanded when the APIC mode is enabled.	Disabled	Disables this function.
		Enabled	Disables this function.
PCIE Port 1 IOxAPIC enable	This option is used to enable or disable the APIC (Advanced Programmable Interrupt Controller) on the PCIE port 1. The IRQ resources available to the system are expanded when the APIC mode is enabled.	Disabled	Disables this function.
		Enabled	Disables this function.
PCIE Port 2 IOxAPIC enable	This option is used to enable or disable the APIC (Advanced Programmable Interrupt Controller) on the PCIE port 2. The IRQ resources available to the system are expanded when the APIC mode is enabled.	Disabled	Disables this function.
		Enabled	Disables this function.
PCIE Port 3 IOxAPIC enable	This option is used to enable or disable the APIC (Advanced Programmable Interrupt Controller) on the PCIE port 3. The IRQ resources available to the system are expanded when the APIC mode is enabled.	Disabled	Disables this function.
		Enabled	Disables this function.

Table 100: 945GME Advanced PCI Express Configuration (Setting options)

1.5.4 Graphics Configuration

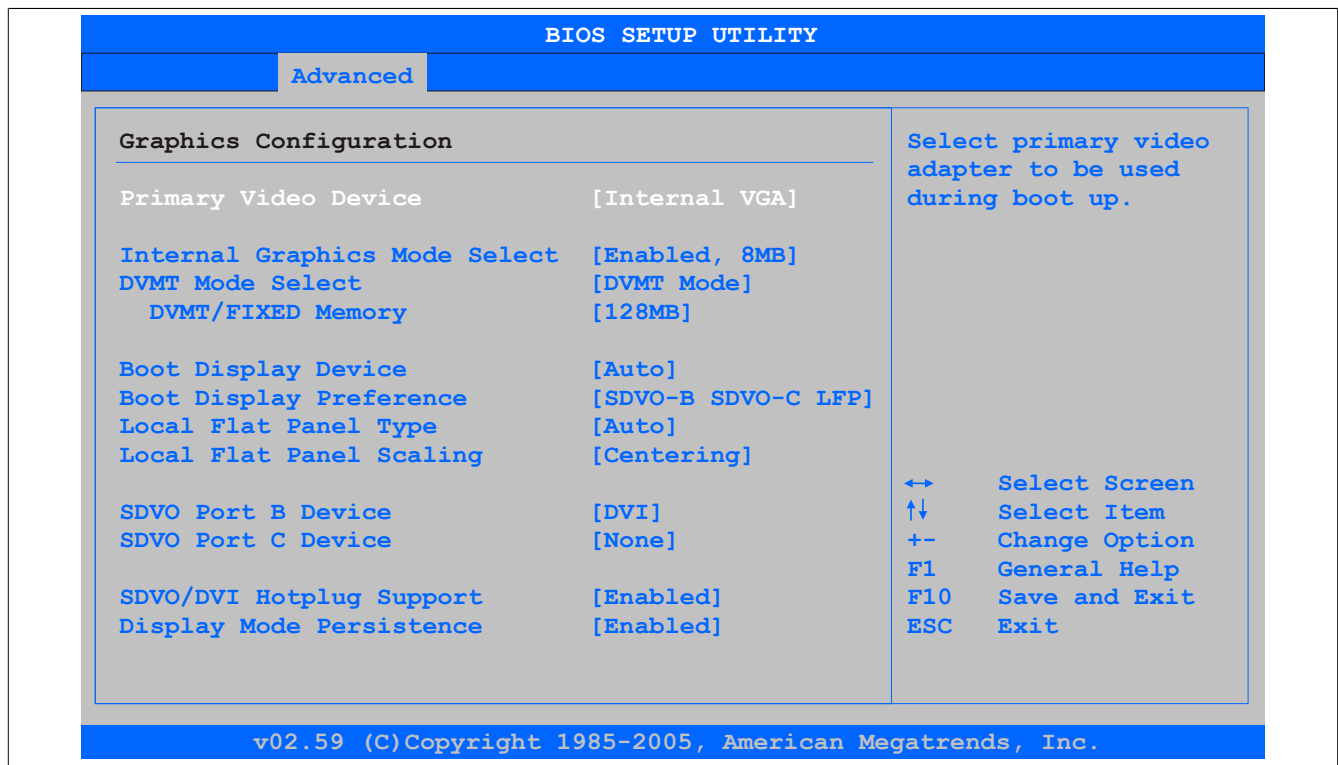

Figure 40: 945GME Advanced Graphics Configuration

BIOS setting	Meaning	Setting options	Effect
Primary Video Device	Option for selecting the primary video device.	Internal VGA	The internal graphics chip on the CPU board is used as video device (monitor / panel connection).
		PCI / Int. VGA	The graphics chip of a connected graphics card is used as video device.
Internal Graphics Mode Select	Option for setting the memory size that can be used for the internal graphics controller.	Disabled	No reservation - Disables the graphics controller.
		Enabled, 1MB	1MB main memory provided.
		Enabled, 8MB	8MB main memory provided.
DVMT Mode Select	Option for determining the DVMT mode (Dynamic Video Memory Technology) of the DVMT graphics driver.	Fixed Mode	A fixed amount of memory is allocated to the graphics chip, which is no longer available to the PC.
		DVMT Mode	Memory consumption is controlled dynamically by the DVMT graphics driver. Only the amount of memory that is required is used.
		Combo Mode	The DVMT graphics driver reserves at least 64MB, but can use up to 224MB if necessary.
DVMT/FIXED Memory	Option for setting the amount of memory used for the DVMT mode.	64 MB	64MB of main memory can be used.
		128 MB	128MB of main memory can be used.
		Maximum DVMT	The remaining available main memory can be used.
Boot Display Device	Determines which video channel should be enabled for a video device during the boot procedure.	Auto	Automatic selection.
		CRT only	Only use the CRT (Cathode Ray Tube) channel.
		SDVO only	Only use the SDVO (Serial Digital Video Out) channel.
		CRT + SDVO	Use CRT and SDVO channel.
		LFP only	Only use the LFP (Local Flat Panel) channel.
		CRT + LFP	Use CRT + LFP channel.
Boot Display Preference	This option determines the order in which the devices on the connected channels LFP and SDVO should be checked and booted. Information: The setting is only needed when the Boot Display Device option is set to "Auto".	LFP SDVO-B SDVO-C	Local Flat Panel - Serial Digital Video B output - Serial Video C output.
		LFP SDVO-C SDVO-B	Local Flat Panel - Serial Digital Video C output - Serial Video B output.
		SDVO-B SDVO-C LFP	Serial Digital Video B output - Serial Digital Video C output - Local Flat Panel.
		SDVO-C SDVO-B LFP	Serial Digital Video C output - Serial Digital Video B output - Local Flat Panel.
Local Flat Panel Type	This option can be used to set a pre-defined profile for the LVDS channel.	Auto	Automatic detection and setting using the EDID data.
		VGA 1x18 (002h)	640x480
		VGA 1x18 (013h)	640x480

Table 101: 945GME Advanced Graphics Configuration (Setting options)

BIOS setting	Meaning	Setting options	Effect
		SVGA 1x18 (004h)	800x600
		XGA 1x18 (006h)	1024x768
		XGA 2x18 (007h)	1024x768
		XGA 1x24 (008h)	1024x768
		XGA 2x24 (012h)	1024x768
		SXGA 2x24 (00Ah)	1280x1024
		SXGA 2x24 (018h)	1280x1024
		UXGA 2x24 (00Ch)	1600x1200
		Customized EDID 1	User-defined profile
		Customized EDID 2	User-defined profile
		Customized EDID 3	User-defined profile
Local flat panel scaling	Determines the screen content should be output according to the defined Local Flat Panel Type.	Centering	The screen content is output centered on the display.
		Expand Text	The text is stretched across the entire surface of the display.
		Expand Graphics	The graphics are stretched across the entire surface of the display.
		Expand Text & Graphics	Text and graphics are stretched across the entire surface of the display.
SDVO Port B Device	Option for selecting the video device that is connected to the SDVO Port B.	None	No video device connected.
		DVI	Video signal output is optimized for a DVI-compatible video device.
		TV	Video signal output is optimized for a TV-compatible video device.
		CRT	Video signal output is optimized for a CRT-compatible video device.
		LVDS	Video signal output is optimized for a LVDS-compatible video device.
		DVI-Analog	Video signal output is optimized for an analog DVI-compatible video device.
SDVO Port C Device	Option for selecting the video device that is connected to the SDVO Port A.	None	No video device connected.
		DVI	Video signal output is optimized for a DVI-compatible video device.
		TV	Video signal output is optimized for a TV-compatible video device.
		CRT	Video signal output is optimized for a CRT-compatible video device.
		LVDS	Video signal output is optimized for a LVDS-compatible video device.
		DVI-Analog	Video signal output is optimized for an analog DVI-compatible video device.
SDVO/DVI Hot Plugging Support	If this option is set to enabled, the Windows XP graphics driver supports "hot plugging" and "configuration mode persistence" for DVI monitors connected to a DVI SDVO transmitter. "Hot plugging" support means that when a DVI monitor is connected while the operating system is running, it is detected automatically and activated. "Configuration mode persistence" means that, for example, a dual DVI configuration is automatically restored when both DVI monitors are reconnected, even if only one of them was connected and activated during a previous boot.	Enabled	"Hot plugging" and "Configuration mode persistence" mode enabled.
		Disabled	"Hot plugging" and "Configuration mode persistence" mode disabled.
Display Mode Persistence	"Display mode persistence" means that the operating system can remember and restore the previous display configuration. For example, a dual DVI configuration is automatically restored when both DVI monitors are reconnected, even if only one of them was connected and activated during a previous boot.	Enabled	Enables this function.
		Disabled	Disables this function.

Table 101: 945GME Advanced Graphics Configuration (Setting options)

1.5.5 CPU Configuration

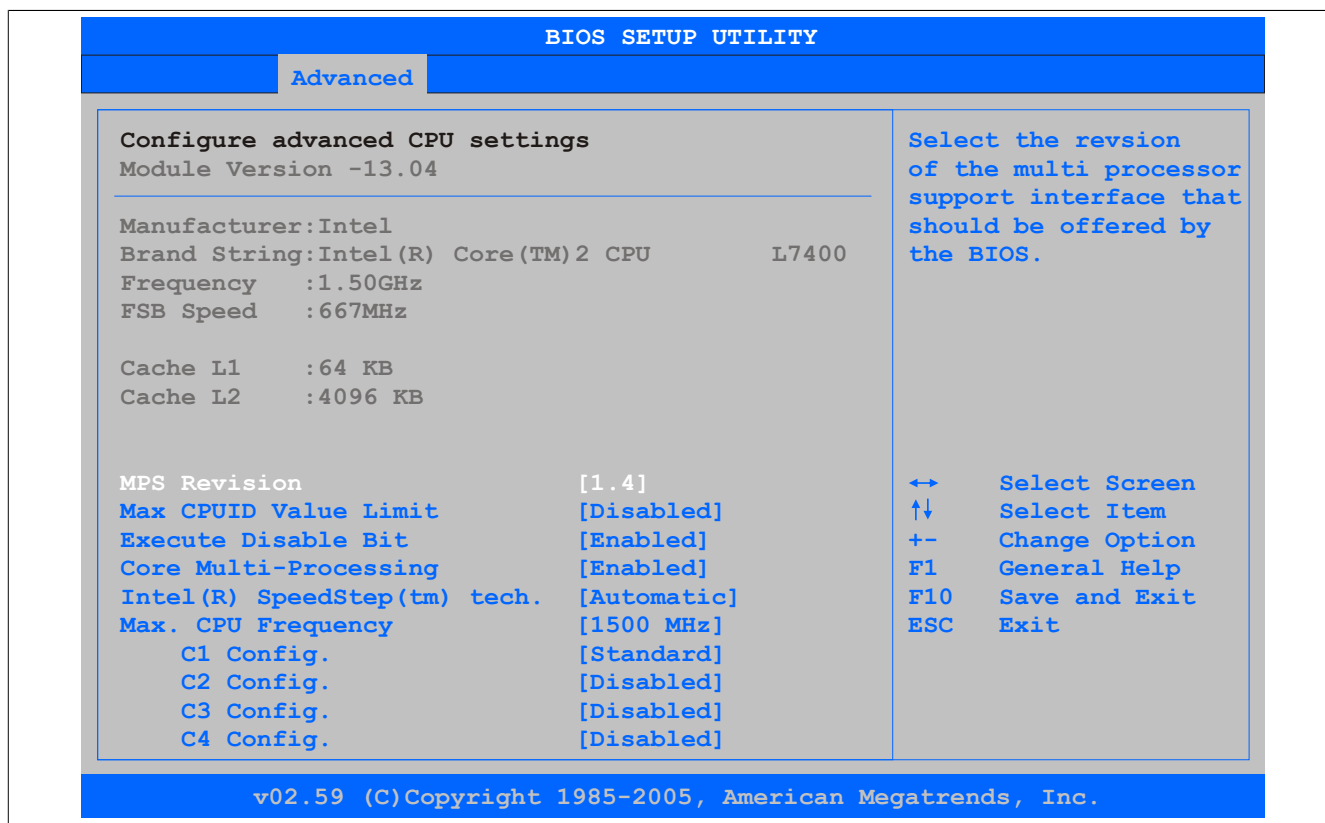

Figure 41: 945GME Advanced CPU Configuration

BIOS setting	Meaning	Setting options	Effect
MPS Revision	This option supports the use of multiple CPUs (MPS=multi-processor system).	1.1	Sets MPS support Revision 1.1
		1.4	Sets MPS support Revision 1.4
Max CPUID value limit	Option for limiting the CPUID input value. This could be necessary for older operating systems.	Enabled	The processor limits the maximum CPUID input value to 03h if necessary when the the processor supports a higher value.
		Disabled	The processor returns the current maximum value upon request of the CPUID input value.
Execute Disable Bit	Option for enabling or disabling hardware support for prevention of data execution.	Enabled	Enables this function.
		Disabled	Disables this function.
Core Multi-Processing	When using a Dual Core processor, this option can be used to disable a core.	Enabled	Both cores are used in a Dual Core processor.
		Disabled	Only one core is used in a Dual Core processor.
Intel(R) Speedster(TM) tech.	Option for controlling the Intel(R) SpeedStep(TM) technology. The processor clock speed is increased or decreased according to the amount of calculations that must be made. As a result, the power consumption depends largely on the processor load.	Automatic	The processor speed is regulated by the operating system.
		Maximum speed	The processor speed is set to a maximum.
		Minimum speed	The processor speed is set to a minimum.
		Disabled	Disables SpeedStep technology.
Max. CPU frequency	Option for setting the maximum processor speed if the value "Automatic" or "Maximum Speed" is set for the option "Intel(R) SpeedStep(TM) tech.".	xxxx MHz	The processor speed is limited to the set value.
		<p>Information:</p> <p>This option is not available for Celeron M processors.</p>	
C1 Config	Power Management in the Intel Core Duo processors.	Standard	Standard C1 support.
		Enhanced	Enhanced C1 support.
C2 Config	Power Management in the Intel Core Duo processors.	Standard	Standard C2 support.
		Enhanced	Enhanced C2 support.
		Disabled	Disabled C2 support.
C3 Config	Power Management in the Intel Core Duo processors.	Standard	Standard C3 support.
		Enhanced	Enhanced C3 support.

Table 102: 945GME Advanced CPU Configuration (Setting options)

BIOS setting	Meaning	Setting options	Effect
C4 Config	Power Management in the Intel Core Duo processors.	Disabled	Disabled C3 support.
		Standard	Standard C4 support.
		Enhanced	Enhanced C4 support.
		Disabled	Disabled C4 support.

Table 102: 945GME Advanced CPU Configuration (Setting options)

1.5.6 Chipset Configuration

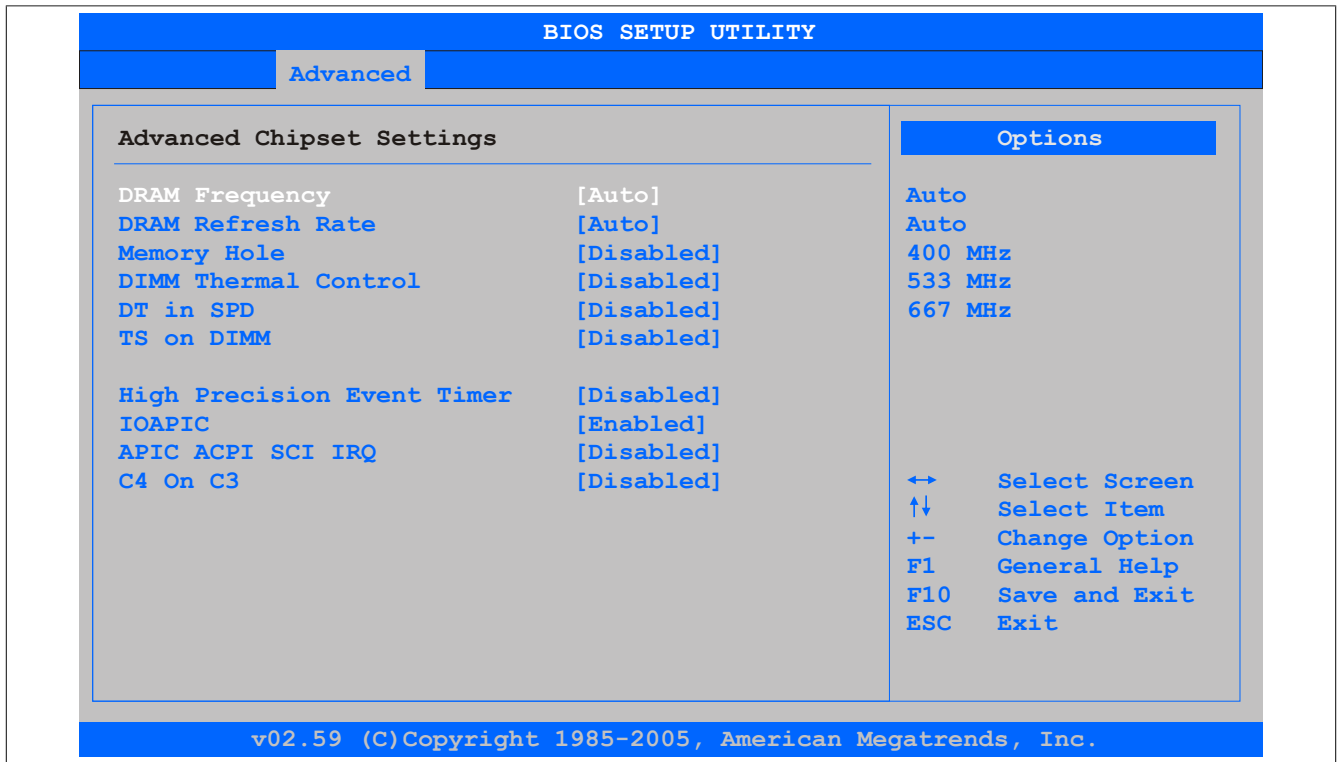

Figure 42: 945GME Advanced Chipset Configuration

BIOS setting	Meaning	Setting options	Effect
DRAM Frequency	Option for setting the RAM frequency.	Auto	Frequency set automatically by the BIOS.
DRAM Refresh Rate	Option for setting the DRAM refresh rate.	400, 533, 667 MHz	Desired clock frequency set manually.
		7.8 μ s	Manual setting for the DRAM refresh rate.
		3.9 μ s	Manual setting for the DRAM refresh rate.
Memory Hole	Option for ISA cards with frame buffer. Not important for an APC820.	Disabled	Disables this function.
		15MB-16MB	This address area is reserved.
DIMM Thermal Control	Option for setting the maximum surface temperature of the DIMM module. The module is cooled by limiting the memory bandwidth if the defined surface temperature is reached.	Disabled	Surface temperature not limited.
		40°C, 50°C, 60°C, 70°C, 80°C, 85°C, 90°C	Temperature limit value for the limitation.
DT in SPD	Option to determine whether the GMCH (Graphics and Memory Controller Hub) supports DT (Delta Temperature) in the SPD (Serial Presence Detect) Management Algorithm of the DIMM module.	Disabled	Disables this function.
		Enabled	Enables this function.
TS on DIMM	Option to determine whether the GMCH (Graphics and Memory Controller Hub) supports TS (Thermal Sensor) in the Thermal Management Algorithm of the DIMM module.	Disabled	Disables this function.
		Enabled	Enables this function.
High Precision Event Timer	The HPET is a timer inside the PC. It is able to trigger an interrupt with a high degree of accuracy, which allows other programs to better synchronize a variety of applications.	Disabled	Disables this function.
		Enabled	Enables this function.

Table 103: 945GME Advanced Chipset (Setting options)

BIOS setting	Meaning	Setting options	Effect
IOAPIC	This option is used to activate or deactivate the APIC (Advanced Programmable Interrupt Controller). Information: The IRQ resources available to the system are expanded when the APIC mode is enabled.	Disabled	Disables this function.
		Enabled	The IRQ resources available to the system are expanded when the APIC mode is enabled.
APIC ACPI SCI IRQ	This option is used to modify the SCI IRQ when in APIC (Advanced Programmable Interrupt Controller) mode.	Disabled	IRQ9 is used for SCI.
		Enabled	IRQ20 is used for SCI.
C4 On C3	Fine-tunes the power saving function on an ACPI operating system.	Disabled	Disables this function.
		Enabled	Processor is needed in C4 if the operating system is initiated in a C3 state.

Table 103: 945GME Advanced Chipset (Setting options)

1.5.7 I/O Interface Configuration

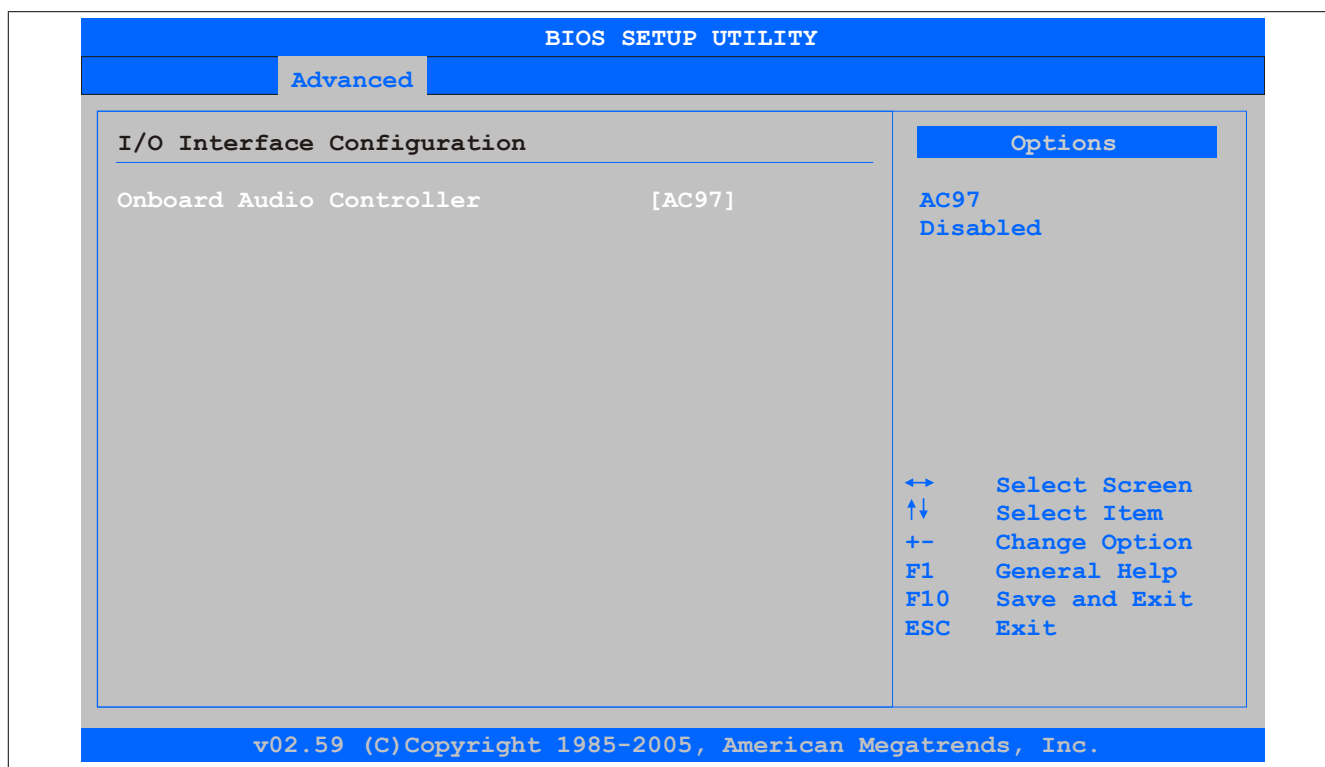

Figure 43: 945GME Advanced I/O Interface Configuration

BIOS setting	Meaning	Setting options	Effect
Onboard Audio Controller	For turning the Onboard AC'97 audio controller on and off.	AC97	Enables AC'97 sound.
		Disabled	Disables AC'97 sound.

Table 104: 945GME Advanced I/O Interface Configuration

1.5.8 Clock Configuration

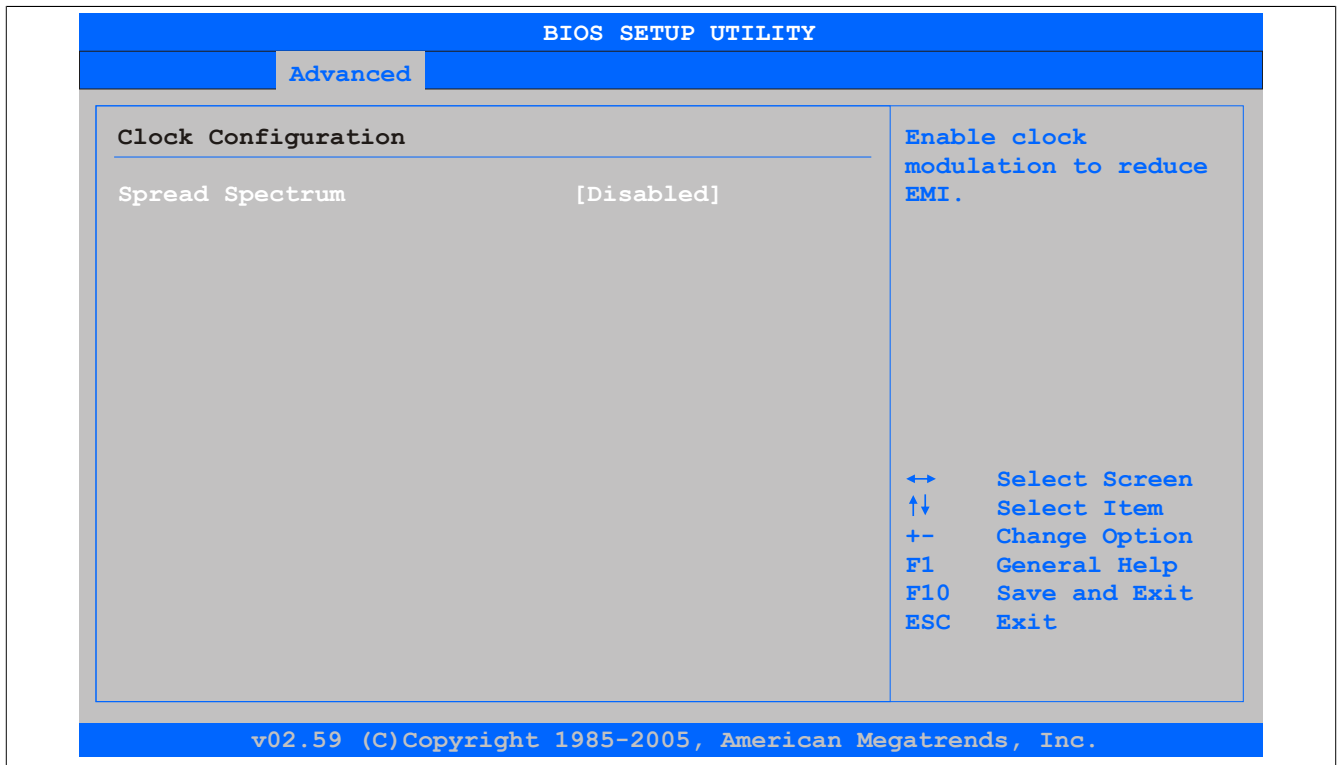

Figure 44: 945GME Advanced Clock Configuration

BIOS setting	Meaning	Setting options	Effect
Spread spectrum	With this option, the cycle frequency can be modulated by reducing electromagnetic disturbances.	Enabled	Enables this function.
		Disabled	Disables this function.

Table 105: 945GME Advanced Clock Configuration (Setting options)

1.5.9 IDE Configuration

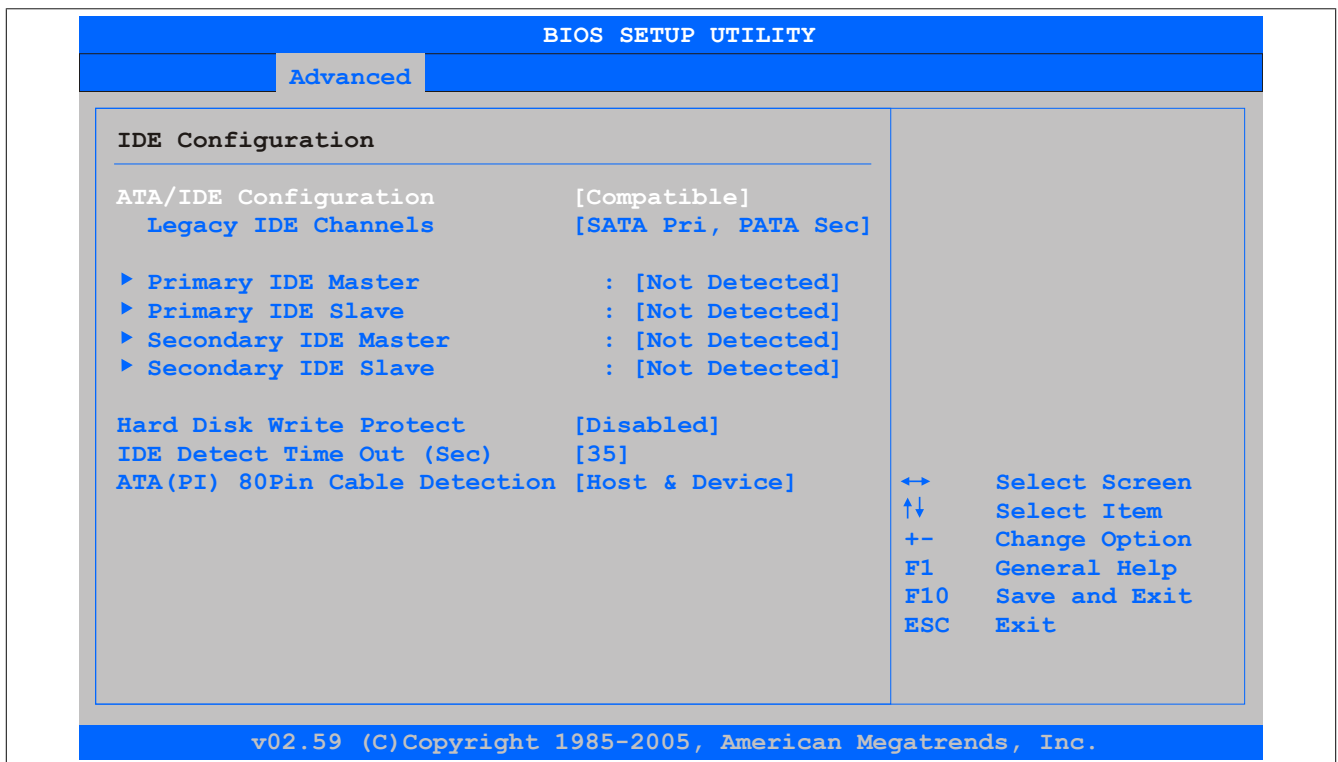

Figure 45: 945GME Advanced IDE Configuration

BIOS setting	Meaning	Setting options	Effect
ATA/IDE Configuration	Option for configuring the integrated PATA and SATA controller.	Compatible	Both controllers run in Legacy or Compatible mode
		Disabled	Both controllers disabled.
		Enhanced	Both controllers run in Enhanced or Native Mode.
Legacy IDE Channels	Option for configuring the Legacy IDE channels in Compatible mode.	SATA Pri, PATA Sec	SATA drives are address primarily and PATA drive secondarily.
		SATA only	Only use SATA drives.
		PATA only	Only use PATA drives.
Primary IDE Master	The drive in the system that is connected to the IDE primary master port is configured here.	Enter	Opens the submenu see "Primary IDE Master" on page 108
Primary IDE slave	The drive in the system that is connected to the IDE primary slave port is configured here.	Enter	Opens the submenu see "Primary IDE slave" on page 109
Secondary IDE Master	The drive in the system that is connected to the IDE secondary master port is configured here.	Enter	Opens the submenu see "Secondary IDE Master" on page 110
Secondary IDE slave	The drive in the system that is connected to the IDE secondary slave port is configured here.	Enter	Opens the submenu see "Secondary IDE slave" on page 111
Hard disk write protect	Write protection for the hard drive can be enabled/disabled here.	Disabled	Disables this function.
		Enabled	Enables this function.
IDE Detect Time Out (Sec)	Configuring the time overrun limit value for the ATA/ATAPI device identification.	0, 5, 10, 15, 20, 25, 30, 35	Time setting in seconds.
ATA(PI) 80-Pin Cable Detection	Detects whether an 80 pin cable is connected to the drive, the controller or to both.	Host & device	Using both IDE controllers (motherboard, disk drive).
		Host	IDE controller motherboard used.
		Device	IDE disk drive controller used.

Table 106: 945GME Advanced IDE Configuration (Setting options)

1.5.9.1 Primary IDE Master

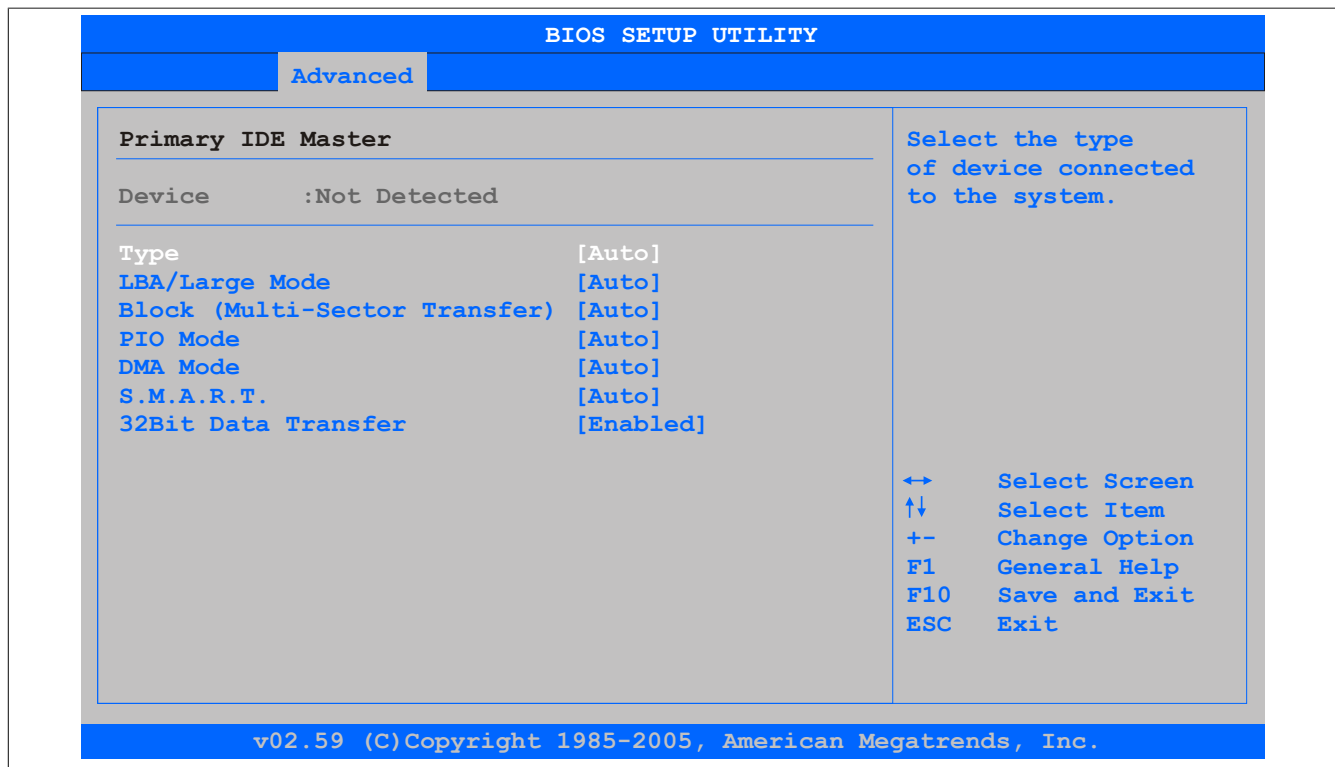

Figure 46: 945GME Primary IDE Master

BIOS setting	Meaning	Setting options	Effect
Type	The type of drive connected to the primary master is configured here.	Not installed	No drive installed.
		Auto	Automatic recognition of the drive and setup of appropriate values.
		CD/DVD	CD -/ DVD drive.
		ARMD	ARMD - drive (zip drive)
LBA/Large Mode	This option activates the logical block addressing / large mode for IDE.	Disabled	Disables this function.
		Auto	Automatic enabling of this function when supported by the system.

Table 107: 945GME - Primary IDE Master - Setting options

BIOS setting	Meaning	Setting options	Effect
Block (Multi-Sector Transfer)	This option enables the block mode for IDE hard drives. When this option is enabled, the number of blocks per request from the configuration sector of the hard drive is read.	Disabled	Disables this function.
		Auto	Automatic enabling of this function when supported by the system.
PIO Mode	The PIO mode determines the data rate of the hard drive. Information: This option is not available on the APC820. Therefore this setting is not relevant.	Auto	Automatic configuration of PIO mode.
		0, 1, 2, 3, 4	Manual configuration of PIO mode.
DMA Mode	The data transfer rate to and from the primary master drive is defined here. The DMA mode must be activated in the Windows device manager in order to guarantee maximum performance. Only possible when manually setting up the drive.	Auto	Automatic definition of the transfer rate.
		Disabled	Manual definition of the transfer rate.
S.M.A.R.T.	Monitoring function of modern hard drives (self-monitoring, analysis and reporting technology).	Auto	Automatic detection and enabling.
		Disabled	Disables this function.
		Enabled	Enables this function.
32 Bit Data Transfer	This function enables 32-bit data transfer.	Disabled	Disables this function.
		Enabled	Enables this function.

Table 107: 945GME - Primary IDE Master - Setting options

1.5.9.2 Primary IDE slave

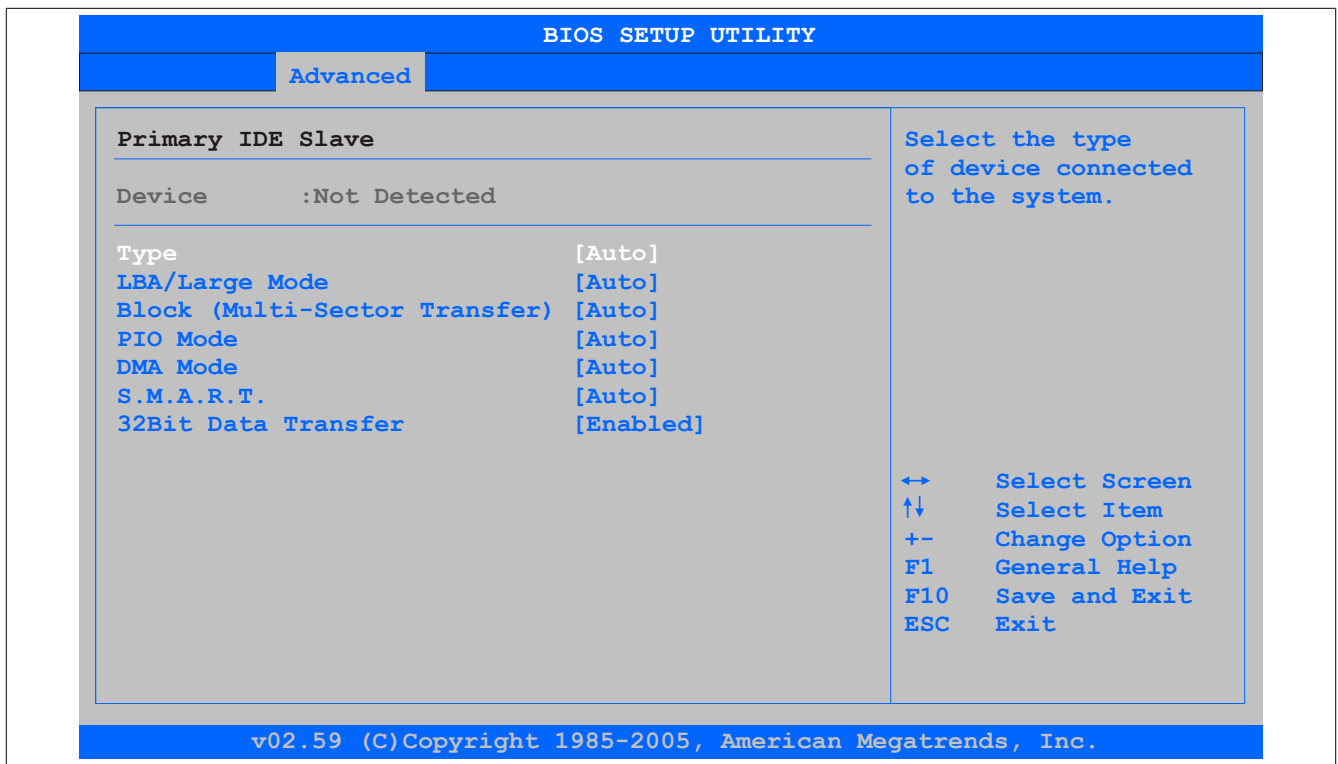

Figure 47: 945GME Primary IDE Slave

BIOS setting	Meaning	Setting options	Effect
Type	The type of drive connected to the primary slave is configured here.	Not installed	No drive installed.
		Auto	Automatic recognition of the drive and setup of appropriate values.
		CD/DVD	CD -/ DVD drive.
		ARMD	ARMD - drive (zip drive)
LBA/Large Mode	This option activates the logical block addressing / large mode for IDE.	Disabled	Disables this function.
		Auto	Automatic enabling of this function when supported by the system.
Block (Multi-Sector Transfer)	This option enables the block mode for IDE hard drives. When this option is enabled, the number of blocks per request from the configuration sector of the hard drive is read.	Disabled	Disables this function.
		Auto	Automatic enabling of this function when supported by the system.

Table 108: 945GME - Primary IDE Slave - Setting options

BIOS setting	Meaning	Setting options	Effect
PIO Mode	The PIO mode determines the data rate of the hard drive. Information: This option is not available on the APC820. Therefore this setting is not relevant.	Auto	Automatic configuration of PIO mode.
		0, 1, 2, 3, 4	Manual configuration of PIO mode.
DMA Mode	The data transfer rate to and from the primary slave drive is defined here. The DMA mode must be activated in the Windows device manager in order to guarantee maximum performance. Only possible when manually setting up the drive.	Auto	Automatic definition of the transfer rate.
		Disabled	Manual definition of the transfer rate.
S.M.A.R.T.	Monitoring function of modern hard drives (self-monitoring, analysis and reporting technology).	Auto	Automatic detection and enabling.
		Disabled	Disables this function.
		Enabled	Enables this function.
32 Bit Data Transfer	This function enables 32-bit data transfer.	Disabled	Disables this function.
		Enabled	Enables this function.

Table 108: 945GME - Primary IDE Slave - Setting options

1.5.9.3 Secondary IDE Master

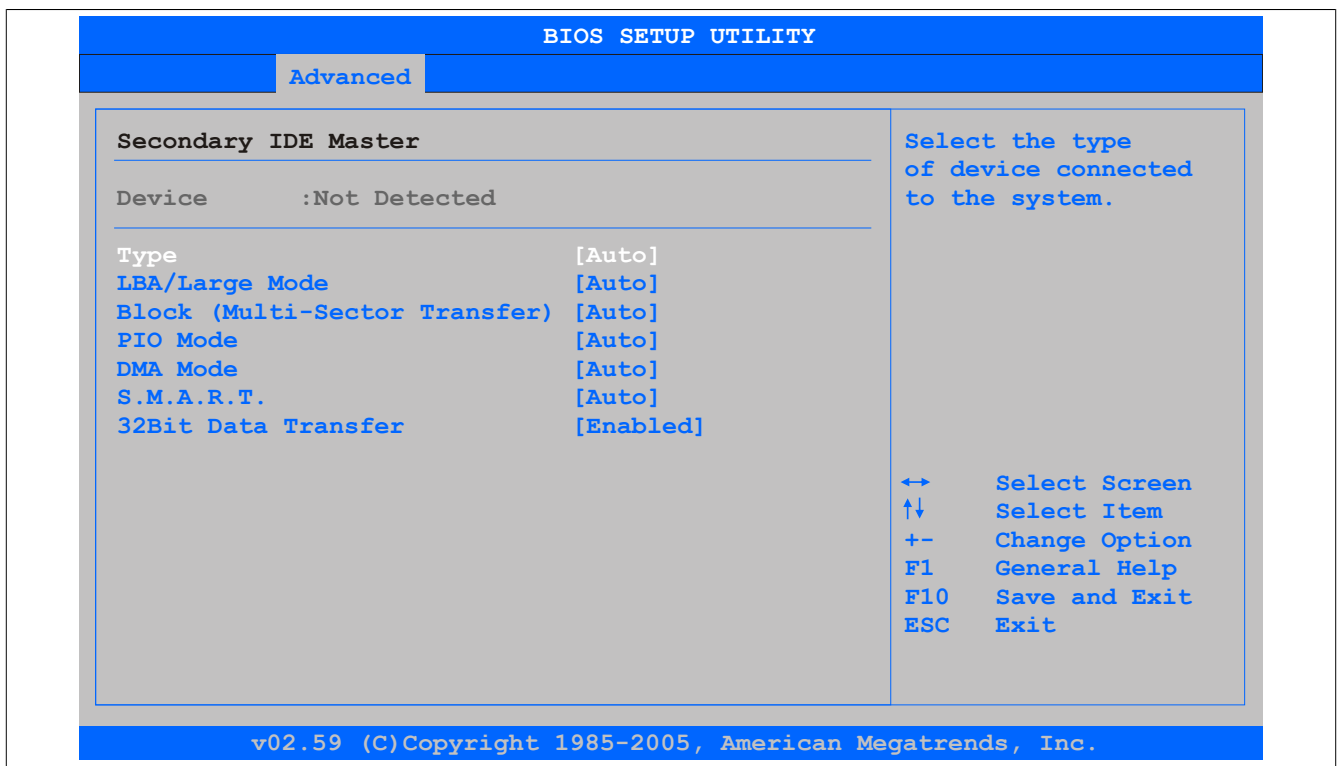

Figure 48: 945GME Secondary IDE Master

BIOS setting	Meaning	Setting options	Effect
Type	The type of drive connected to the secondary master is configured here.	Not installed	No drive installed.
		Auto	Automatic recognition of the drive and setup of appropriate values.
		CD/DVD	CD -/ DVD drive.
		ARMD	ARMD - drive (zip drive)
LBA/Large Mode	This option activates the logical block addressing / large mode for IDE.	Disabled	Disables this function.
		Auto	Automatic enabling of this function when supported by the system.
Block (Multi-Sector Transfer)	This option enables the block mode for IDE hard drives. When this option is enabled, the number of blocks per request from the configuration sector of the hard drive is read.	Disabled	Disables this function.
		Auto	Automatic enabling of this function when supported by the system.

Table 109: 945GME - Secondary IDE Master - Setting options

BIOS setting	Meaning	Setting options	Effect
PIO Mode	The PIO mode determines the data rate of the hard drive. Information: This option is not available on the APC820. Therefore this setting is not relevant.	Auto	Automatic configuration of PIO mode.
		0, 1, 2, 3, 4	Manual configuration of PIO mode.
DMA Mode	The data transfer rate to and from the secondary master drive is defined here. The DMA mode must be activated in the Windows device manager in order to guarantee maximum performance. Only possible when manually setting up the drive.	Auto	Automatic definition of the transfer rate.
		Disabled	Manual definition of the transfer rate.
S.M.A.R.T.	Monitoring function of modern hard drives (self-monitoring, analysis and reporting technology).	Auto	Automatic detection and enabling.
		Disabled	Disables this function.
		Enabled	Enables this function.
32 Bit Data Transfer	This function enables 32-bit data transfer.	Disabled	Disables this function.
		Enabled	Enables this function.

Table 109: 945GME - Secondary IDE Master - Setting options

1.5.9.4 Secondary IDE slave

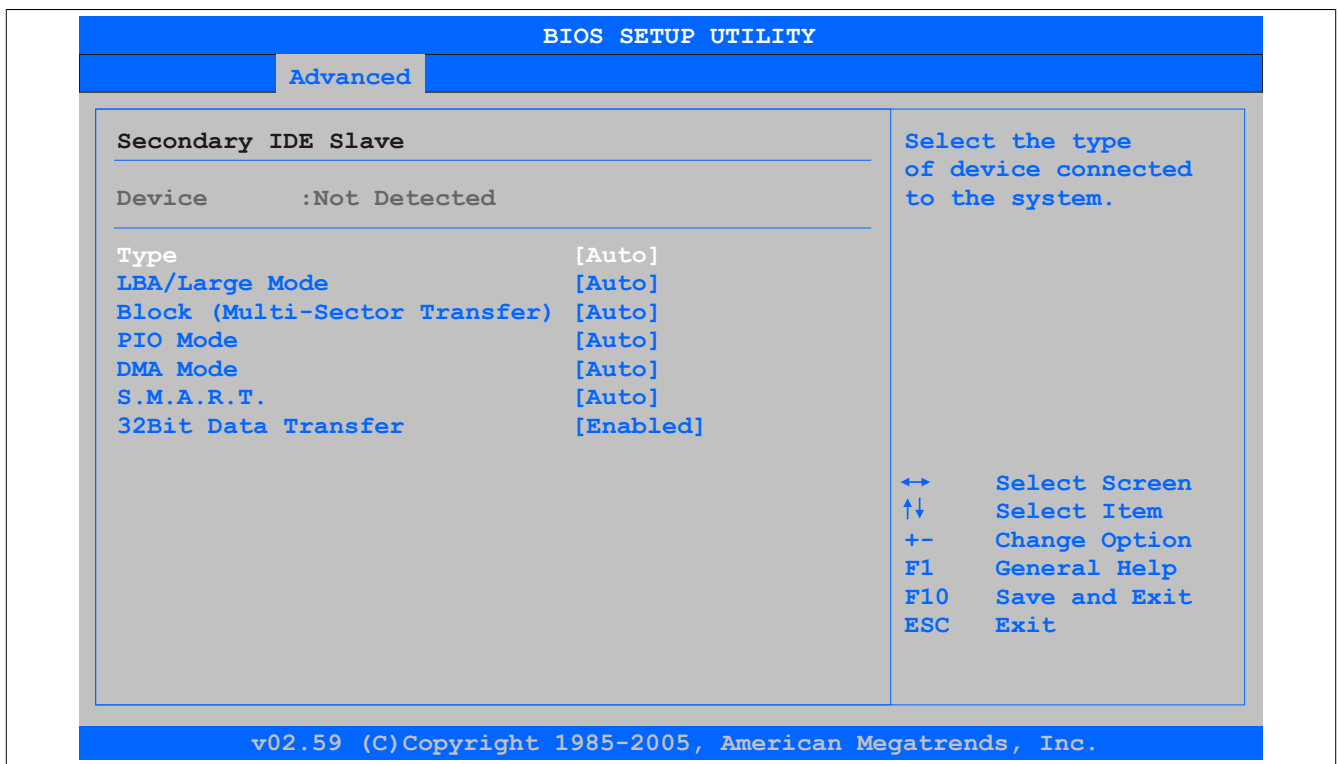

Chapter 4
Software

Figure 49: 945GME Secondary IDE Slave

BIOS setting	Meaning	Setting options	Effect
Type	The type of drive connected to the secondary slave is configured here.	Not installed	No drive installed.
		Auto	Automatic recognition of the drive and setup of appropriate values.
		CD/DVD	CD -/ DVD drive.
		ARMD	ARMD - drive (zip drive)
LBA/Large Mode	This option activates the logical block addressing / large mode for IDE.	Disabled	Disables this function.
		Auto	Automatic enabling of this function when supported by the system.
Block (Multi-Sector Transfer)	This option enables the block mode for IDE hard drives. When this option is enabled, the number of blocks per request from the configuration sector of the hard drive is read.	Disabled	Disables this function.
		Auto	Automatic enabling of this function when supported by the system.

Table 110: 945GME - Secondary IDE Slave - Setting options

BIOS setting	Meaning	Setting options	Effect
PIO Mode	The PIO mode determines the data rate of the hard drive. Information: This option is not available on the APC820. Therefore this setting is not relevant.	Auto	Automatic configuration of PIO mode.
		0, 1, 2, 3, 4	Manual configuration of PIO mode.
DMA Mode	The data transfer rate to and from the secondary slave is defined here. The DMA mode must be activated in the Windows device manager in order to guarantee maximum performance. Only possible when manually setting up the drive.	Auto	Automatic definition of the transfer rate.
		Disabled	Manual definition of the transfer rate.
S.M.A.R.T.	Monitoring function of modern hard drives (self-monitoring, analysis and reporting technology).	Auto	Automatic detection and enabling.
		Disabled	Disables this function.
		Enabled	Enables this function.
32 Bit Data Transfer	This function enables 32-bit data transfer.	Disabled	Disables this function.
		Enabled	Enables this function.

Table 110: 945GME - Secondary IDE Slave - Setting options

1.5.10 USB Configuration

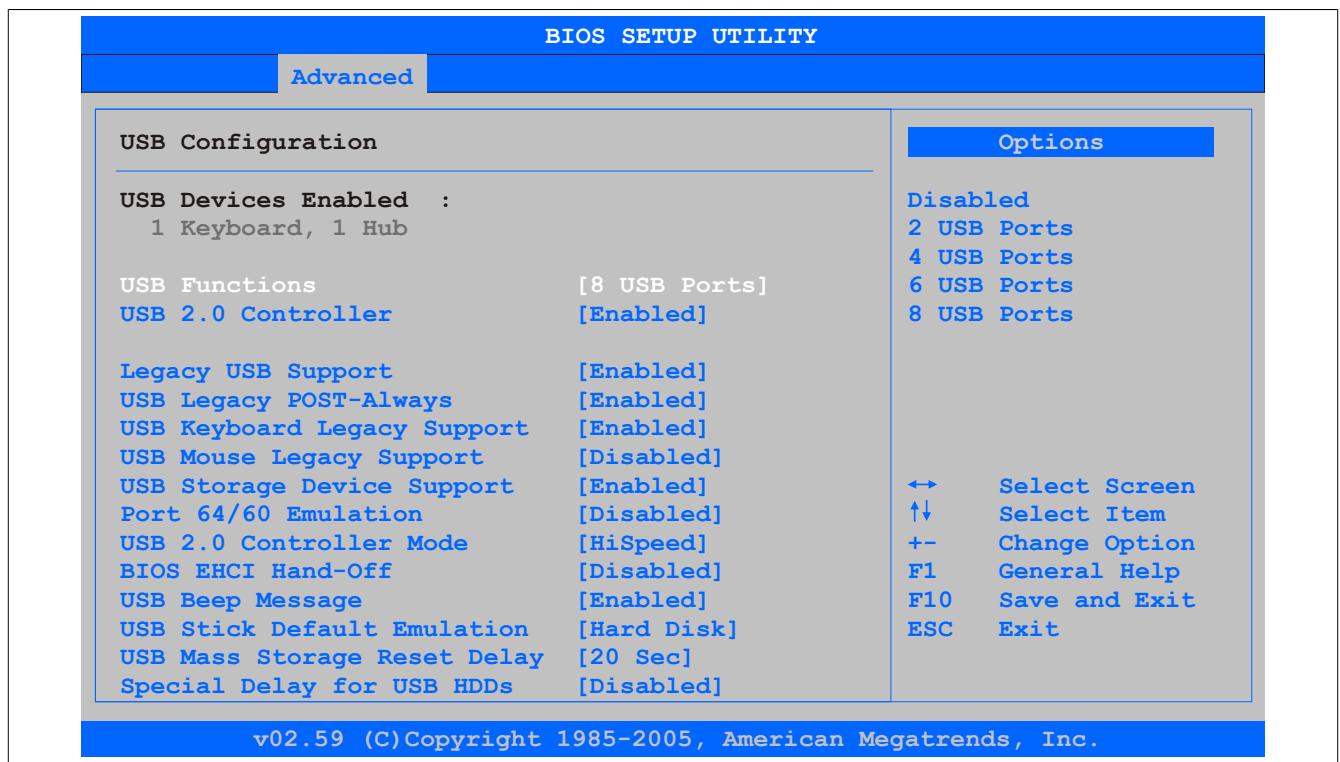

Figure 50: 945GME Advanced USB Configuration

BIOS setting	Meaning	Setting options	Effect
USB Functions	USB ports can be enabled/disabled here.	Disabled	Disables the USB port.
		2 USB Ports	USB1, USB3 are enabled.
		4 USB Ports	USB1, USB2, USB3, USB4 are enabled.
		6 USB Ports	USB1, USB2, USB3, USB4, USB5 are enabled.
		8 USB Ports	USB1, USB2, USB3, USB4, USB5, USB are enabled on an AP via SDL.
USB 2.0 Controller	Option for enabling or disabling USB 2.0 mode.	Enabled	All USB ports run in USB 2.0 mode.
		Disabled	All USB ports run in USB 1.1 mode.
		Auto	Automatic enabling.
Legacy USB Support	Legacy USB support can be enabled/disabled here. USB ports do not function during startup. USB is supported again after the operating system has started. A USB keyboard is still recognized during the POST.	Disabled	Disables this function.
		Enabled	Enables this function.
		Auto	Automatic enabling.
USB Legacy POST-Always	Option to enable Legacy USB Support during the POST (Power On Self Test).	Enabled	The BIOS Setup can be called up during the POST using a USB keyboard.

Table 111: 945GME - Advanced USB Configuration - Setting options

BIOS setting	Meaning	Setting options	Effect
	<p>Information:</p> <p>Only one setting can be made if the option "Legacy USB Support" is enabled.</p>	Disabled	Disables this function.
USB Keyboard Legacy Support	USB keyboard support can be enabled/disabled here.	Disabled	Disables this function.
		Enabled	Enables this function.
USB Mouse Legacy Support	USB mouse support can be enabled/disabled here.	Disabled	Disables this function.
		Enabled	Enables this function.
USB Storage Device Support	USB memory device support can be enabled/disabled here.	Disabled	Disables this function.
		Enabled	Enables this function.
Port 64/60 Emulation	Port 64/60 emulation can be enabled/disabled here.	Disabled	USB keyboard functions in all systems excluding Windows NT.
		Enabled	USB keyboard functions in Windows NT.
USB 2.0 Controller Mode	Settings can be made for the USB controller here.	Full Speed	12 MBps
		Hi Speed	480 MBps
BIOS EHCI Hand-Off	The support for the operating system can be set up without the fully automatic EHCI function.	Disabled	Disables this function.
		Enabled	Enables this function.
USB Beep Message	Option for outputting a tone each time a USB device is detected by the BIOS during the POST.	Disabled	Disables this function.
		Enabled	Enables this function.
USB Stick Default Emulation	You can set how the USB device is to be used.	Auto	USB devices with fewer than 530MB of memory are simulated as floppy disk drives and devices with larger capacities are simulated as hard drives.
		Hard disk drive	An HDD-formatted drive can be used as an FDD (e.g. zip drive) for starting the system.
USB Mass Storage Reset Delay	The waiting time that the USB device POST requires after the device start command can be set.	10 Sec, 20 Sec, 30 Sec, 40 Sec	Value set manually.
	<p>Information:</p> <p>The message "No USB mass storage device detected" is displayed if no USB memory device has been installed.</p>		
Special Delay for USB HDDs	Option for setting a boot delay prior to counting USB 2.0 devices, which allows slow-booting USB devices (e.g. USB hard disks) to boot.	Disabled	Disables this function. No boot delay is added.
	<p>Information:</p> <p>This option should only be used when required, since it would otherwise unnecessarily extend the boot process by the configured time.</p>	1 Sec, 2 Sec, 3 Sec, 4 Sec, 5 Sec, 7 Sec, 10 Sec	A boot delay of 1, 2, 3, 4, 5, 7 or 10 seconds is added.

Table 111: 945GME - Advanced USB Configuration - Setting options

1.5.11 Keyboard/Mouse Configuration

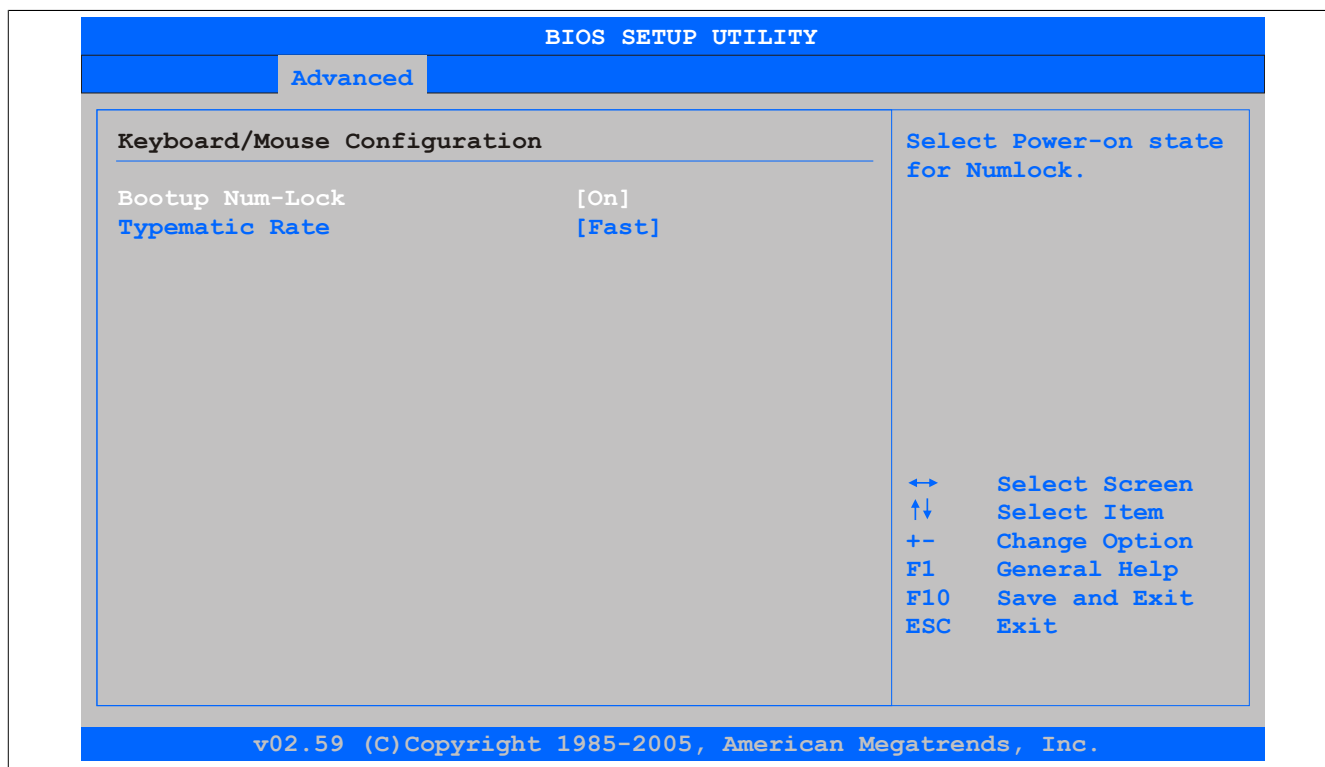

Figure 51: 945GME Advanced Keyboard/Mouse Configuration

BIOS setting	Meaning	Setting options	Effect
Boot-up Num-lock	With this field you can define the state of the Num-Lock key when booting.	Off	Only the cursor functions of the numerical keypad are activated.
		On	Numeric keypad is enabled.
Typematic rate	The key repeat function is set here.	Slow	Slow key repeat.
		Fast	Fast key repeat.

Table 112: 945GME Advanced Keyboard/Mouse Configuration (Setting options)

1.5.12 Remote access configuration

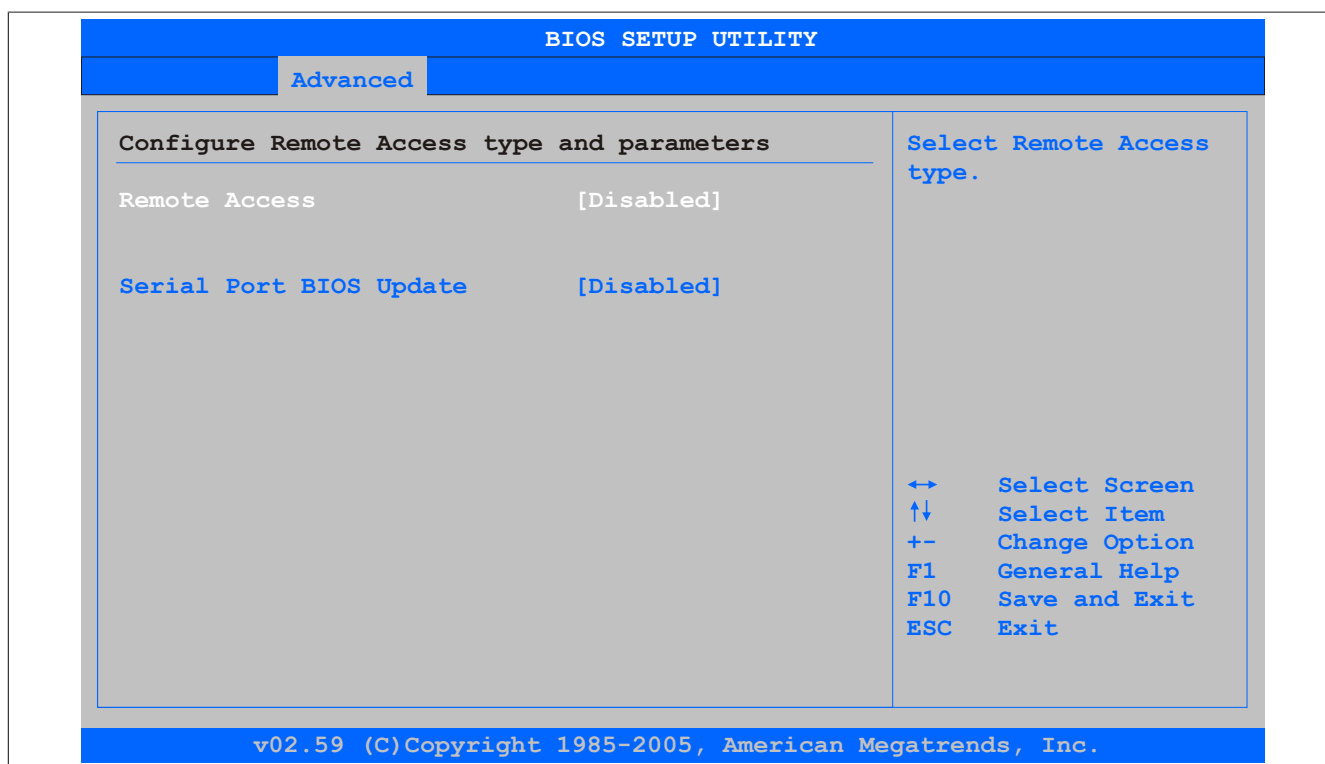

Figure 52: 945GME Advanced Remote Access Configuration

BIOS setting	Meaning	Setting options	Effect
Remote access	The remote access function can be enabled/disabled here.	Disabled	Disables this function.
		Enabled	Enables this function.
Serial port number	The serial interface can be set using this option as long as disabled is not entered in the <i>Remote access</i> field.	COM1	Enables the COM1 interface as remote access interface.
		COM2	Enables the COM2 interface as remote access interface.
		COM3	Enables the COM3 interface as remote access interface.
Base address, IRQ	Displays the logical address and interrupt for the serial port as long as disabled is not entered in the <i>Remote access</i> field.	None	-
Serial port mode	The serial port transfer rate is defined here as long as disabled is not entered in the <i>Remote access</i> field.	115200 8,n,1 57600 8,n,1 38400 8,n,1 19200 8,n,1 09600 8,n,1	Value set manually.
Flow control	This setting determines how the transfer is controlled via the interface. Information: The setting must be the same on the terminal and the server.	None	The interface is operated without transfer control.
		Hardware	The interface transfer control is carried out through hardware. This mode must be supported by a cable.
		Software	The interface transfer control is carried out through software.
Redirection after BIOS POST	The redirection after start up can be set here as long as disabled is not entered in the <i>Remote access</i> field.	Disabled	The redirection is switched off after start up.
		Boot loader	Redirection is enabled during system start up and charging.
		Always	Redirection is always enabled.
Terminal type	The type of connection can be chosen here, as long as disabled is not entered in the <i>Remote access</i> field.	ANSI, VT100, VT-UTF8	Manual configuration of the connection type.
VT-UTF8 Combo Key Support	With this option, the VT-UTF8 Combo Key Support for the ANSI and VT100 connections can be enabled as long as disabled is not entered in the <i>Remote access</i> field.	Disabled	Disables this function.
		Enabled	Enables this function.
Sredir Memory Display Delay	The memory output delay can be set using this option as long as disabled is not entered in the <i>Remote access</i> field (Sredir -> serial redirection).	No delay	No delay.
		Delay 1 sec, Delay 2 sec, Delay 4 sec	Value set manually.
Serial port BIOS update	During system start up, the update is loaded via the serial interface in the processor. Information: If this option is disabled, the boot time is reduced.	Disabled	Disables this function.
		Enabled	Enables this function.

Table 113: 945GME Advanced Remote Access Configuration (Setting options)

1.5.13 CPU Board Monitor

Information:

The displayed voltage values (e.g. core voltage, battery voltage) on this BIOS Setup page represent uncalibrated information values. These cannot be used to draw any conclusions about any hardware alarms or error conditions. The hardware components used have automatic diagnostics functions that can be applied in the event of error.

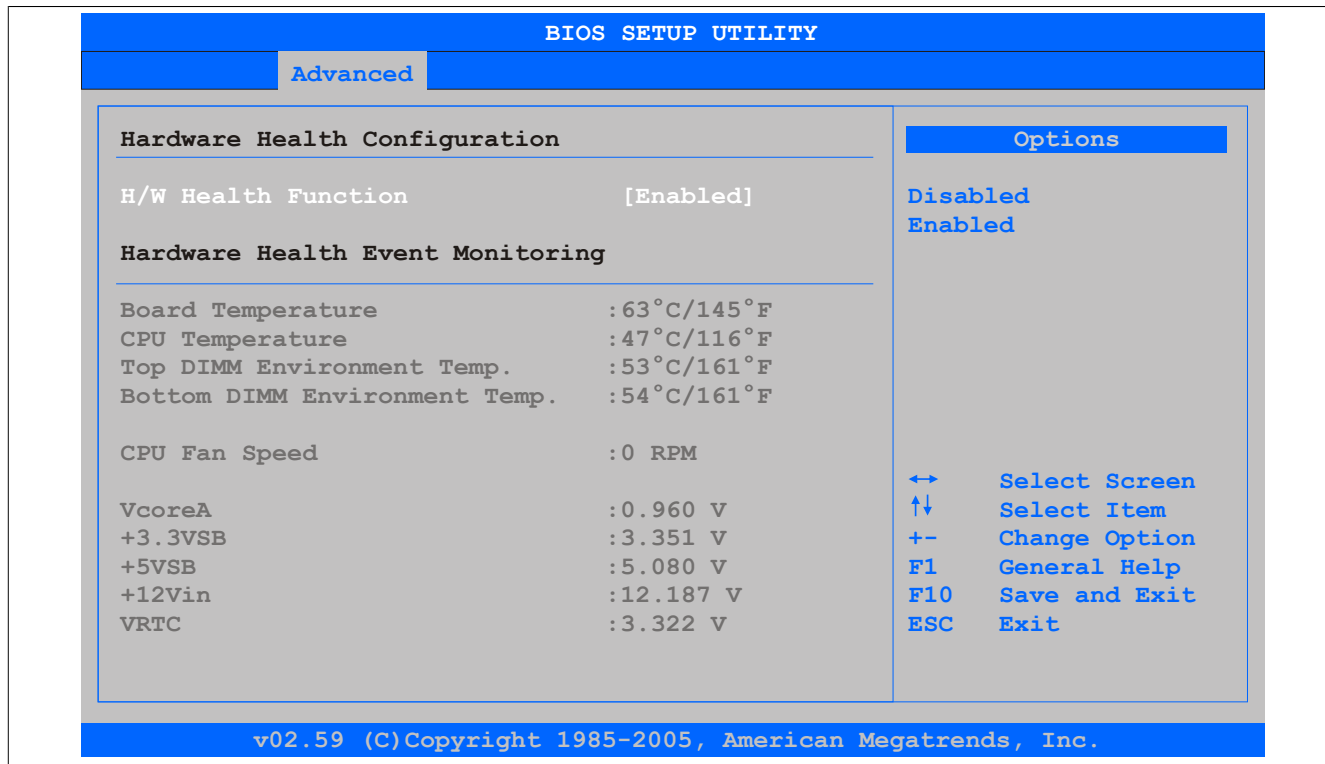

Figure 53: 945GME Advanced CPU Board Monitor

BIOS setting	Meaning	Setting options	Effect
H/W Health Function	Option for displaying all values on this page.	Enabled	Displays all values.
		Disabled	No values are shown on this page.
Board temperature	Displays the board temperature in degrees Celsius and Fahrenheit.	None	-
CPU temperature	Displays the processor's temperature (in degrees Celsius and Fahrenheit).	None	-
Top DIMM Environment Temp.	Displays the temperature of the first DRAM module in degrees Celsius and Fahrenheit.	None	-
Bottom DIMM Environment Temp.	Displays the temperature of the second DRAM module in degrees Celsius and Fahrenheit.	None	-
CPU Fan Speed	Displays the rotating speed of the processor fan.	None	-
VcoreA	Displays the processor's core voltage A in volts.	None	-
+3.3VSB	Displays the current voltage of the 3.3 volt supply.	None	-
+5VSB	Displays the current voltage of the 5 volt supply.	None	-
+12Vin	Displays the current voltage of the 12 volt supply.	None	-
VRTC	Displays the battery voltage (in volts).	None	-

Table 114: 945GME Advanced Remote Access Configuration (Setting options)

1.5.14 Baseboard/Panel Features

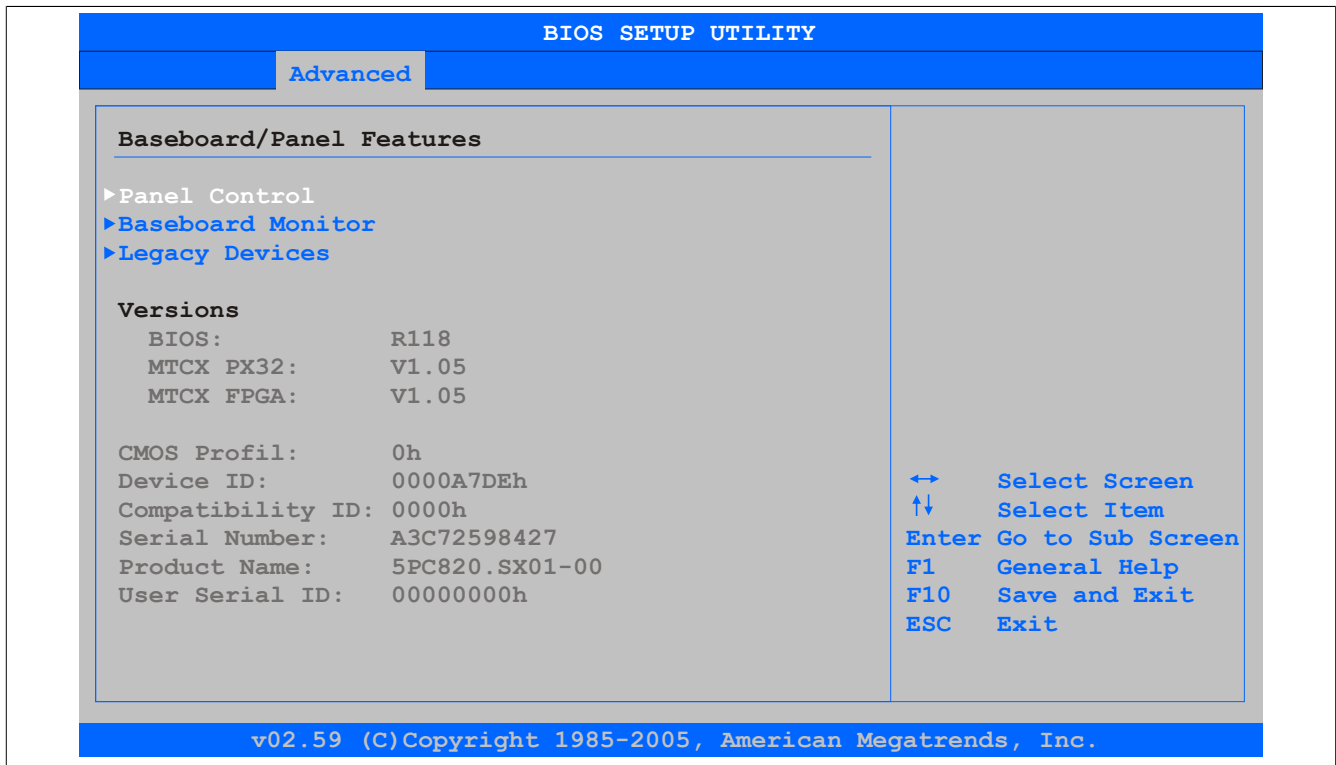

Figure 54: 945GME Advanced Baseboard/Panel Features

BIOS setting	Meaning	Setting options	Effect
Panel control	For special setup of connected panels (display units).	Enter	Opens the submenu see "Panel control" on page 118
Baseboard monitor	Display of various temperatures and fan speeds.	Enter	Opens the submenu see "Baseboard Monitor" on page 119
Legacy Devices	Special settings for the interface can be changed here.	Enter	Opens the submenu see "Legacy Devices" on page 120
BIOS	Displays the BIOS version.	None	-
MTCX PX32	Displays the MTCX PX32 firmware version.	None	-
MTCX FPGA	Displays the MTCX FPGA firmware version.	None	-
CMOS profile	Shows the CMOS profile number.	None	-
Device ID	Displays the hexadecimal value of the hardware device ID.	None	-
Compatibility ID	Displays the version of the device within the same B&R device code. This ID is needed for Automation Runtime.	None	-
Serial Number	Displays the B&R serial number	None	-
Product Name	Displays the B&R model number	None	-
User Serial ID	Displays the user serial ID. This 8-digit hex value can be freely assigned by the user (e.g. to give the device a unique ID) and can only be changed with using the "B&R Control Center" via the ADI driver.	None	-

Table 115: 945GME - Advanced Baseboard/Panel Features - Setting options

1.5.14.1 Panel control

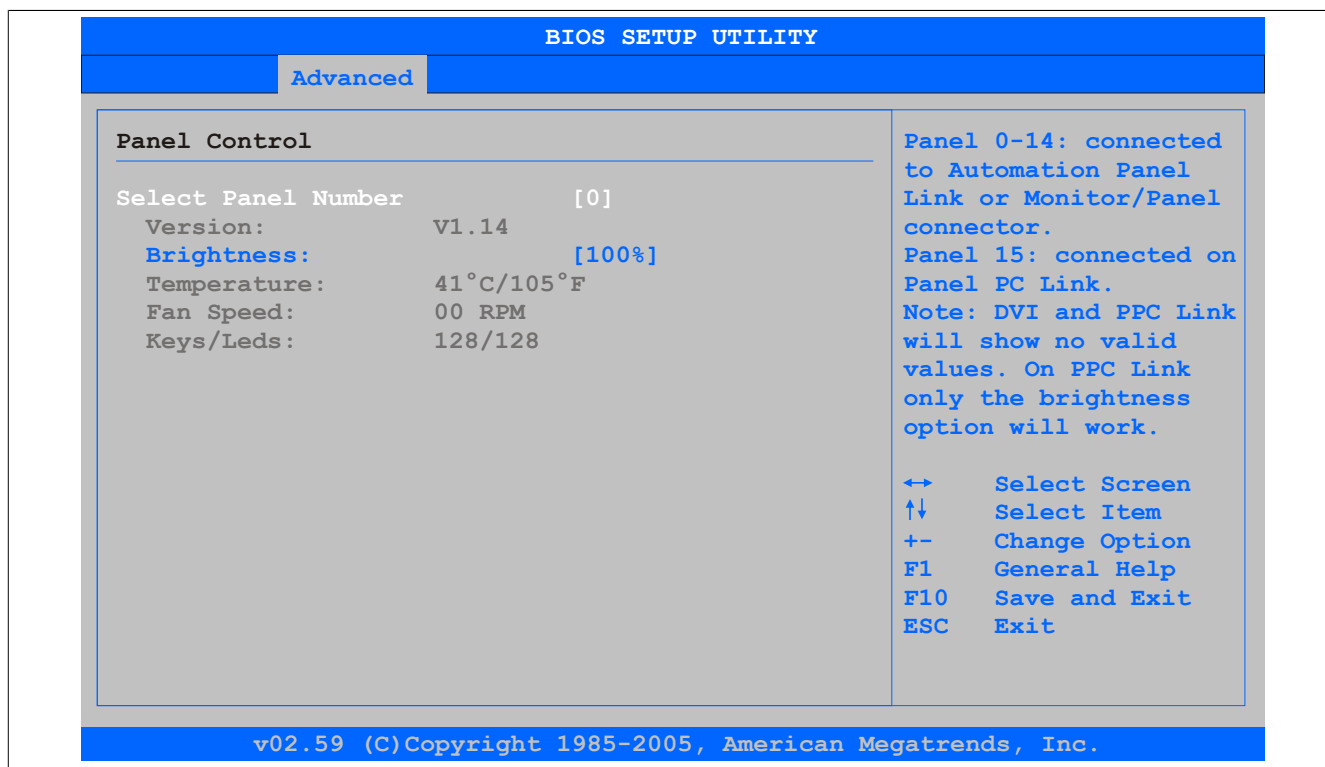

Figure 55: 945GME Panel Control

BIOS setting	Meaning	Setting options	Effect
Select panel number	Selection of the panel number for which the values should be read out and/or changed.	0 - 15	Selection of panel 0 - 15. Panel 15 is specifically intended for panel PC 800 systems.
Version	Displays the firmware version of the SDLR controller.	None	-
Brightness	For setting the brightness of the selected panel.	0%, 10%, 20%, 30%, 40%, 50%, 60%, 70%, 80%, 90%, 100%	For setting the brightness (in %) of the selected panel. Changes take effect after saving and restarting the system (e.g. by pressing <F10>).
Temperature	Displays the selected panel's temperature (in degrees Celsius and Fahrenheit).	None	-
Fan speed	Displays fan speed for the selected panel.	None	-
Keys/LEDs	Displays the available keys and LEDs on the selected panel.	None	-

Table 116: 945GME Panel Control (Setting options)

1.5.14.2 Baseboard Monitor

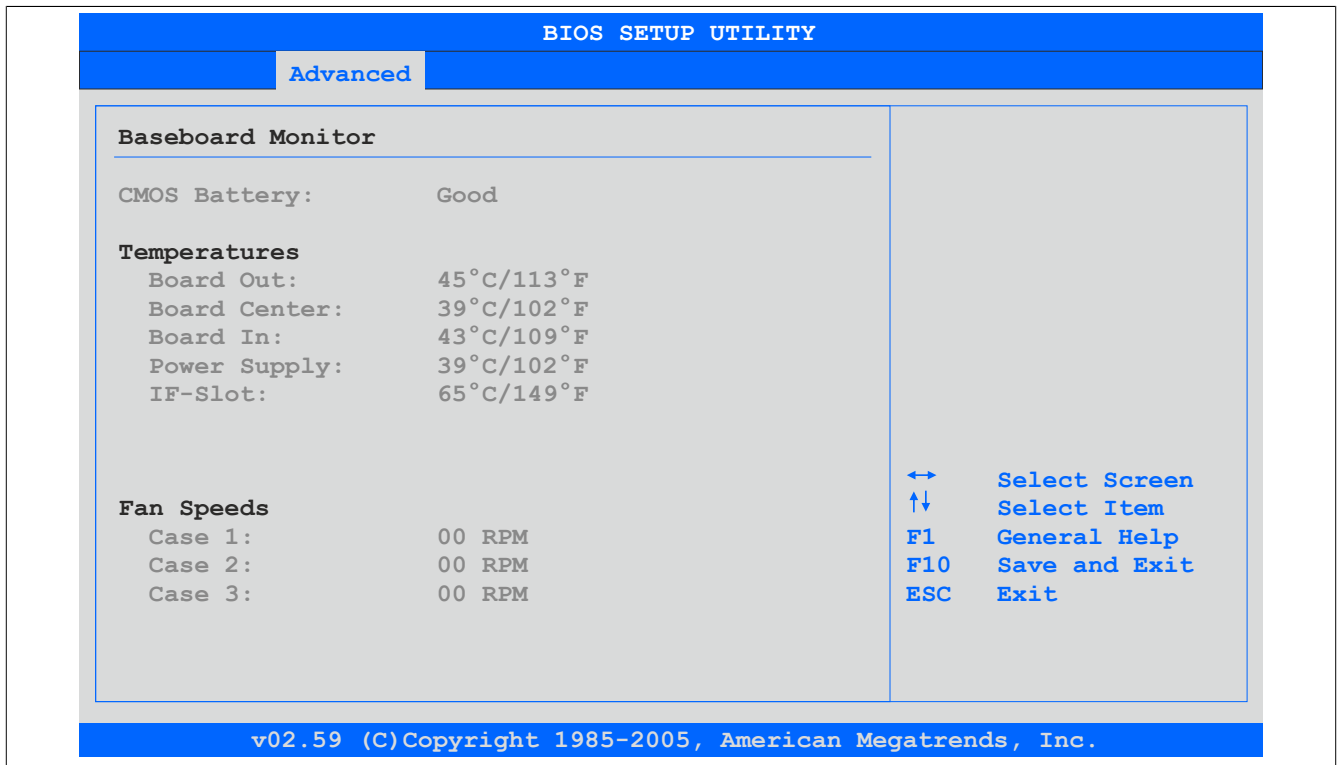

Figure 56: 945GME Baseboard Monitor

BIOS setting	Meaning	Setting options	Effect
CMOS battery	Displays the battery status. n.a. - not available Good - Battery OK. Bad - Battery not OK.	None	-
Board Out	Displays the temperature in the upper part of the baseboard in degrees Celsius and Fahrenheit.	None	-
Board Center	Displays the temperature in the center of the baseboard in degrees Celsius and Fahrenheit.	None	-
Board In	Displays the temperature in the lower part of the baseboard in degrees Celsius and Fahrenheit.	None	-
Power supply	Displays the temperature in the power supply in degrees Celsius and Fahrenheit.	None	--
IF slot	Displays the temperature near the IF slot in degrees Celsius and Fahrenheit.	None	-
Case 1	Displays the fan speed of housing fan 1.	None	-
Case 2	Displays the fan speed of housing fan 2.	None	-
Case 3	Displays the fan speed of housing fan 3.	None	-
	<p>Information:</p> <p>The APC820 only has 2 housing fans, which means this value is not relevant.</p>		

Table 117: 945GME Baseboard Monitor (Setting options)

1.5.14.3 Legacy Devices

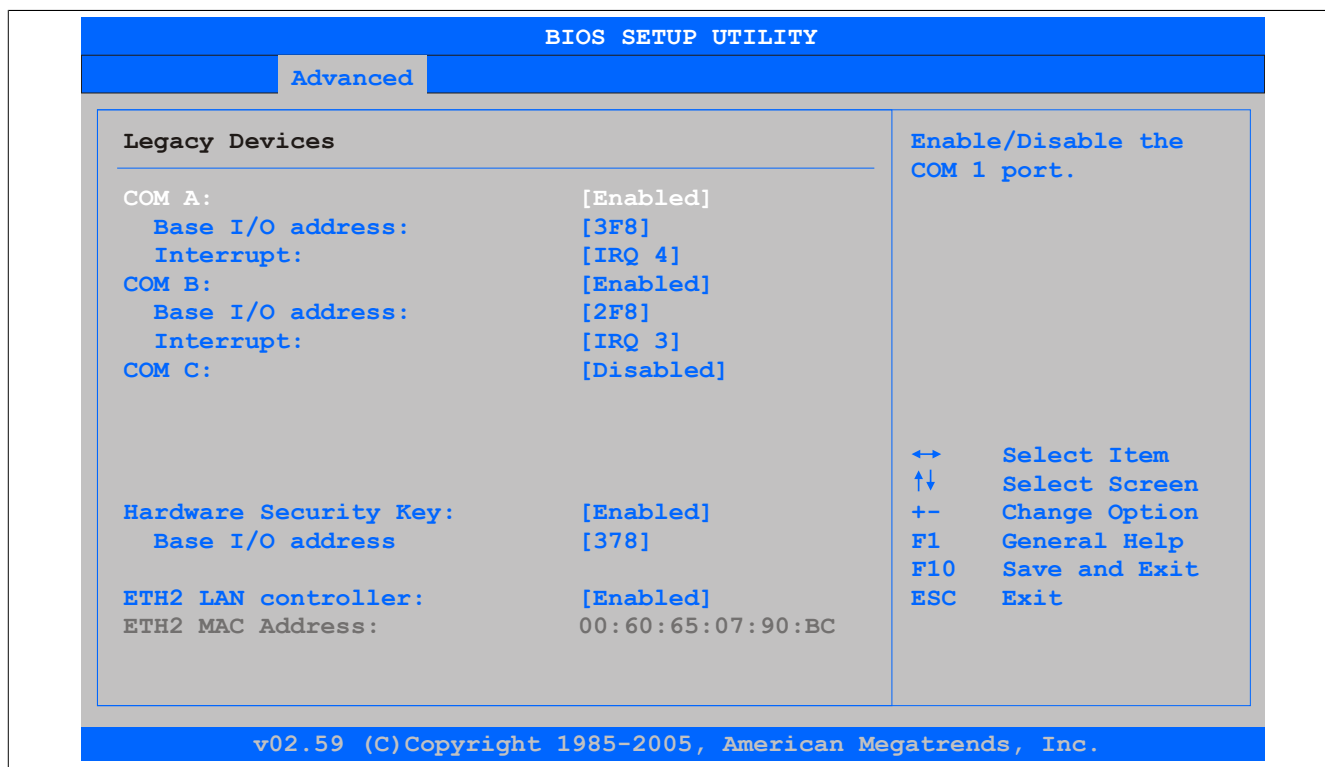

Figure 57: 945GME Legacy Devices

BIOS setting	Meaning	Setting options	Effect
COM A	Settings for the COM1 serial interface in the system.	Disabled	Disables the interface.
		Enabled	Enables the interface.
Base I/O address	Selects the base I/O address for the COM port	238, 2E8, 2F8, 328, 338, 3E8, 3F8	Selected base I/O address is assigned.
Interrupt	Selection of the interrupt for the COM port.	IRQ 3, IRQ 4, IRQ 5, IRQ 6, IRQ 7, IRQ 10, IRQ 11, IRQ 12	Selected interrupt is assigned.
COM B	Settings for the COM2 serial interface in the system.	Disabled	Disables the interface.
		Enabled	Enables the interface.
Base I/O address	Selects the base I/O address for the COM port	238, 2E8, 2F8, 328, 338, 3E8, 3F8	Selected base I/O address is assigned.
Interrupt	Selection of the interrupt for the COM 2 port.	IRQ 3, IRQ 4, IRQ 5, IRQ 6, IRQ 7, IRQ 10, IRQ 11, IRQ 12	Selected interrupt is assigned.
COM C	Setting the COM port for the touch screen on the monitor/panel connector.	Disabled	Disables the interface.
		Enabled	Enables the interface.
Base I/O address	Selects the base I/O address for the COM port	238, 2E8, 2F8, 328, 338, 3E8, 3F8	Selected base I/O address is assigned.
Interrupt	Selection of the interrupt for the COM port.	IRQ 3, IRQ 4, IRQ 5, IRQ 6, IRQ 7, IRQ 10, IRQ 11, IRQ 12	Selected interrupt is assigned.
Hardware security key	Settings for the hardware security key (Dongle) are made here.	Disabled	Disables the interface.
		Enabled	Enables the interface.
Base I/O address	Selection of the base I/O address for the hardware security interface.	278, 378, 3BC	Selection of the base I/O address for the parallel port.
ETH2 LAN controller	For turning the onboard LAN controller (ETH2) on and off.	Disabled	Disables the controller.
		Enabled	Enables the controller.
ETH2 MAC Address	Displays the Ethernet 2 controller MAC address.	None	-

Table 118: 945GME Legacy Devices (Setting options)

1.6 Boot

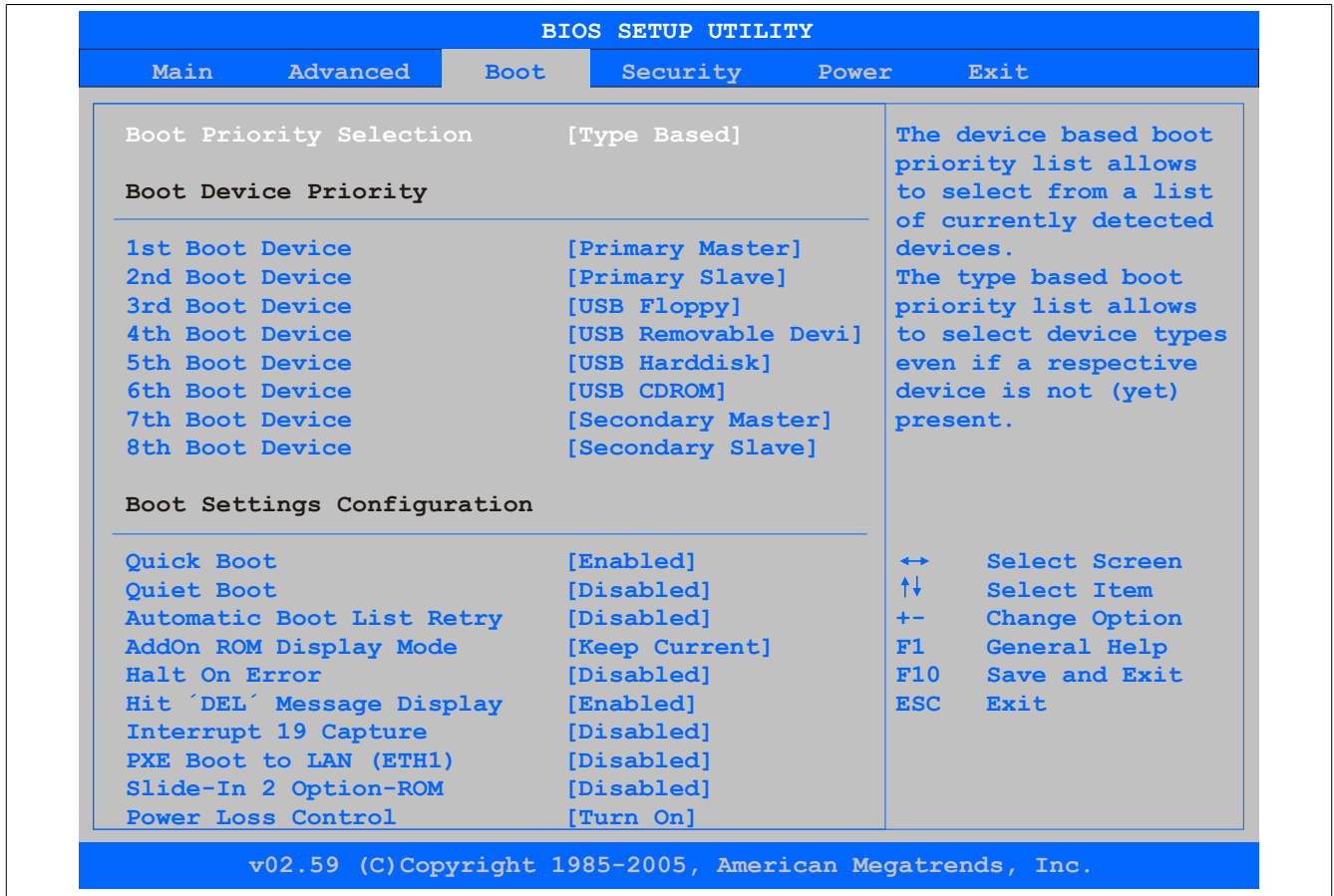

Figure 58: 945GME Boot Menü

BIOS setting	Meaning	Setting options	Effect
Boot Priority Selection	The method for when the drives should be booted can be set here.	Device Based	Only the devices that are recognized by the system are listed. The sequence of this list can be changed. Information: Either "device based" or "type based" must be used. Mixed operation is not permitted.
		Type Based	The boot sequence of a device type list can be changed. Device types that are not connected can also be entered to this list. Information: Either "device based" or "type based" must be used. Mixed operation is not permitted.
1st Boot Device	The boot drives can be set using this option.	Disabled, Primary Master, Primary Slave, Secondary Master, Secondary Slave, Legacy Floppy, USB Floppy, USB Hard Disk, USB CDROM, USB Removeable Device, Onboard LAN, External LAN, PCI Mass Storage PCI SCSI Card, Any PCI BEV Device, Third Master, Third Slave, PCI RAID, Local BEV ROM	Selects the desired sequence.
2nd Boot Device			
3rd Boot Device			
4th Boot Device			
5th Boot Device			
6th Boot Device			
7th Boot Device			
8th Boot Device			
Quick Boot	This function reduces the boot time by skipping some POST procedures.	Disabled	Disables this function.
Quiet Boot	Determines if POST message or OEM logo (default = black background) is displayed.	Enabled	Enables this function.
		Disabled	POST message display.
Automatic Boot List Retry	With this option, the operating system attempts to automatically restart following startup failure.	Enabled	OEM logo display instead of POST message.
		Disabled	Disables this function.
		Enabled	Enables this function.

Table 119: 945GME Boot Menu (Setting options)

BIOS setting	Meaning	Setting options	Effect
Add-On ROM Display Mode	Sets the display mode for the ROM (during the booting procedure).	Force BIOS	An additional BIOS part can be displayed.
		Keep Current	BIOS information is displayed.
Halt On Error	This option sets whether the system should pause the Power On Self Test (POST) when it encounters an error.	Disabled	The system does not pause. All errors are ignored.
		Enabled	The system pauses. The system pauses every time an error is encountered.
Hit 'DEL' Message Display	Settings can be made here for the "Hit 'DEL' Message" display. Information: When quiet boot is activated the message is not displayed.	Disabled	The message is not displayed.
		Enabled	The message is displayed.
Interrupt 19 Capture	This function can be used to incorporate the BIOS interrupt.	Disabled	Disables this function.
		Enabled	Enables this function.
PXE boot to LAN (ETH1)	Enables/disables the function to boot from LAN (ETH1).	Disabled	Disables this function.
		Enabled	Enables this function.
Slide-in 2 Optional ROM	Activation/deactivation of an optional ROM for a slide-in 2 drive.	Disabled	Disables this function.
		Enabled	Enables this function.
Power Loss Control	Determines if the system is on/off following power loss.	Remain Off	Remains off.
		Turn On	Powers on.
		Last State	Enables the previous state.

Table 119: 945GME Boot Menu (Setting options)

1.7 Security

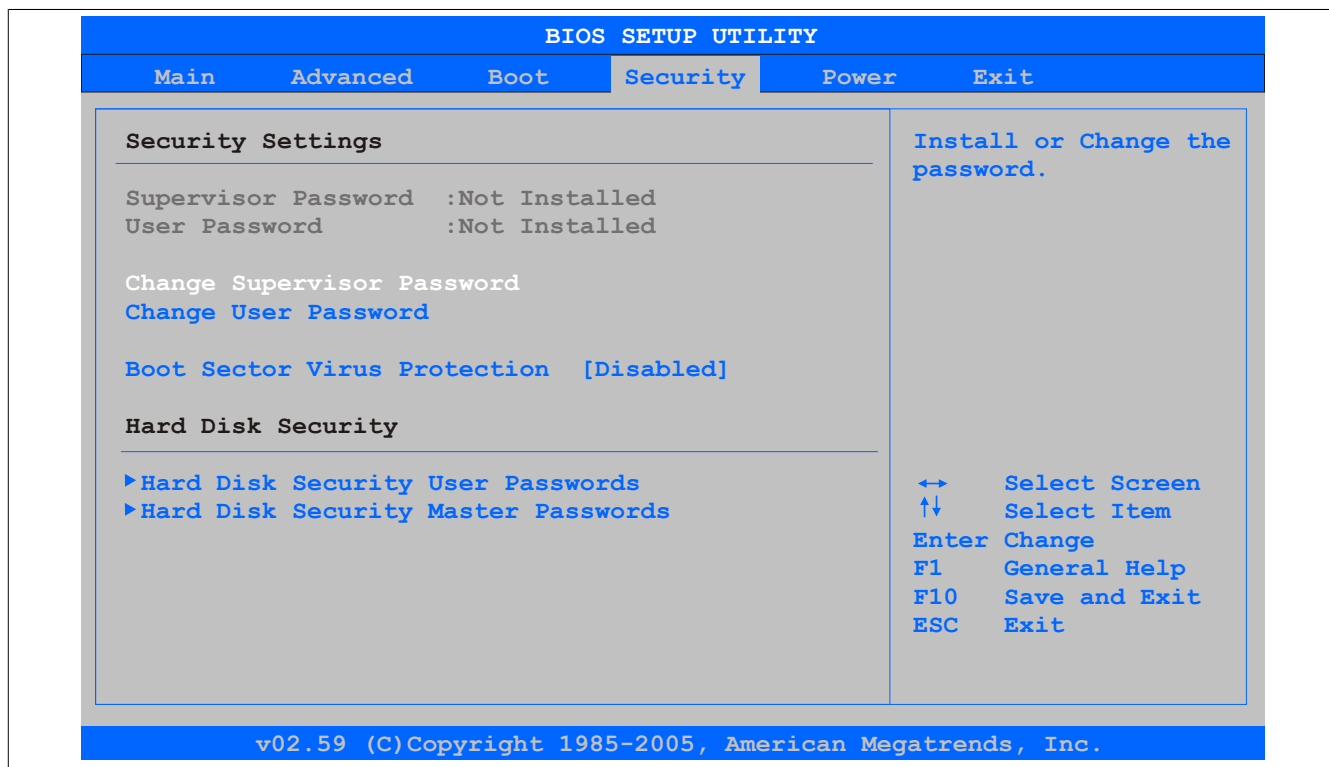

Figure 59: 945GME Security Menü

BIOS setting	Meaning	Setting options	Effect
Supervisor Password	Displays whether or not a supervisor password has been set.	None	-
User Password	Displays whether or not a user password has been set.	None	-
Change Supervisor Password	To enter/change a supervisor password. A supervisor password is necessary to edit all BIOS settings.	Enter	Enter password.
Change User Password	To enter/change a user password. A user password allows the user to edit only certain BIOS settings.	Enter	Enter password.

Table 120: 945GME - Advanced PCI configuration - Setting options

BIOS setting	Meaning	Setting options	Effect
Boot Sector Virus Protection	With this option, a warning is issued when the boot sector is accessed through a program or virus. Information: With this option, only the boot sector is protected, not the entire hard drive.	Disabled	Disables this function.
		Enabled	Enables this function.
Hard Disk Security User Passwords	The hard disk security user password can be created here.	Enter	Opens the submenu see "Hard Disk Security User Password" on page 123
Hard Disk Security Master Passwords	The hard disk security master password can be created here.	Enter	Opens the submenu see "Hard Disk Security Master Password" on page 124

Table 120: 945GME - Advanced PCI configuration - Setting options

1.7.1 Hard Disk Security User Password

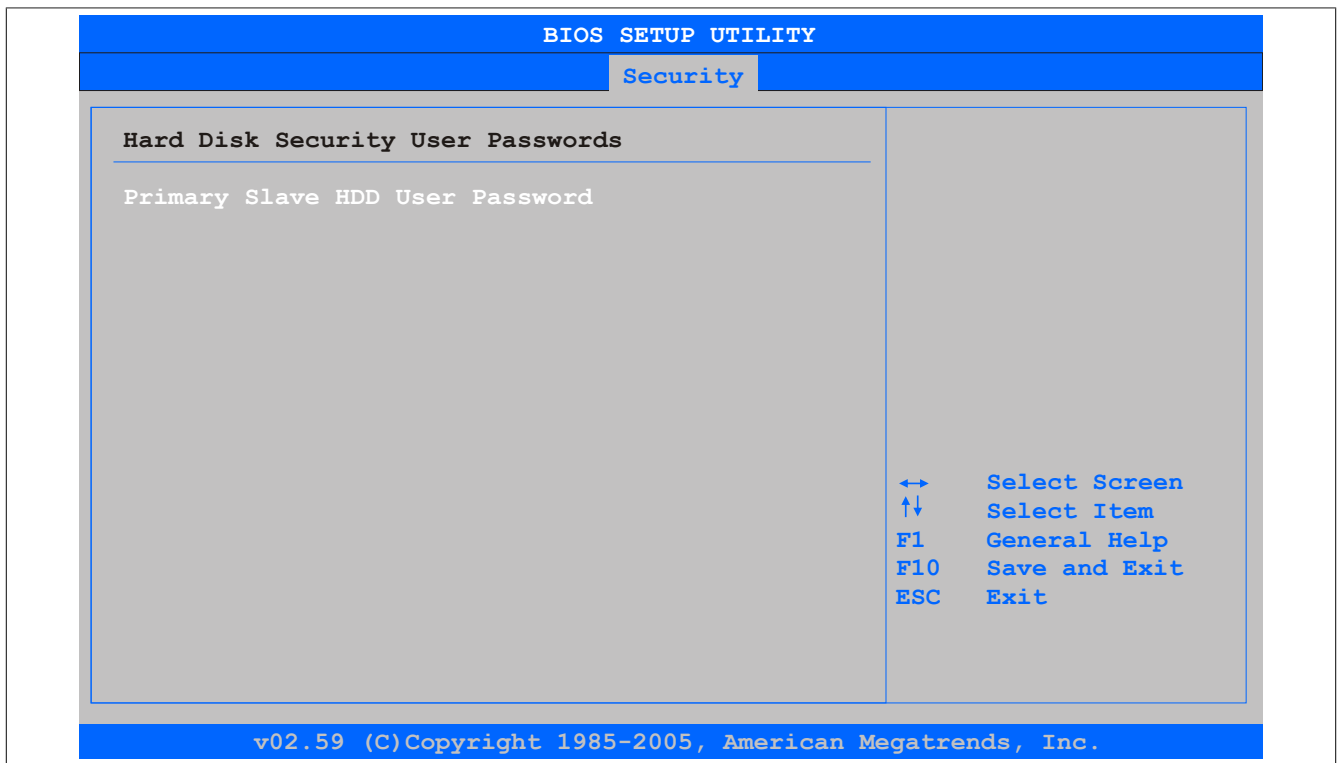

Figure 60: 945GME Hard Disk Security User Password

BIOS setting	Meaning	Setting options	Effect
Primary slave HDD user password	This function makes it possible to use the user password to change or configure each hard drive without having to reboot the device. A user password allows the user to edit only certain BIOS settings.	Enter	Enter password.

Table 121: 945GME Hard Disk Security User Password

1.7.2 Hard Disk Security Master Password

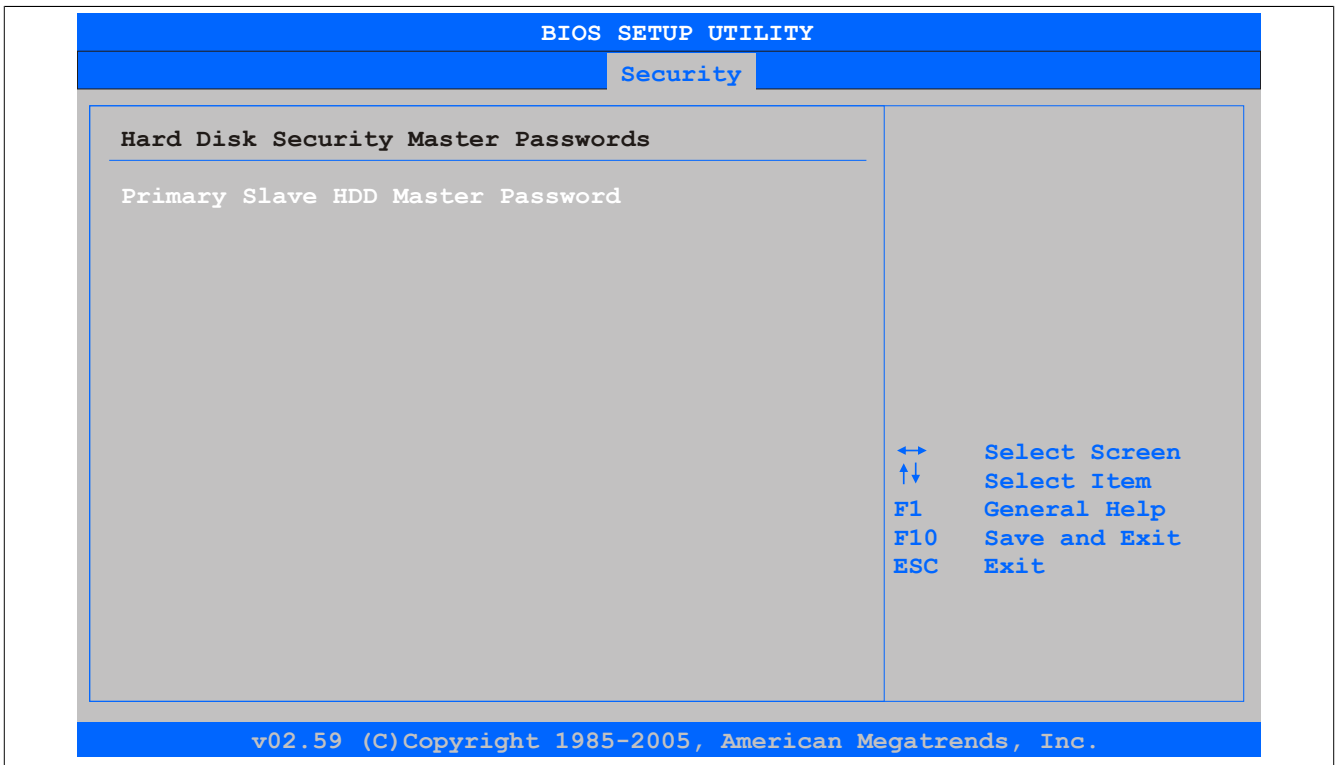

Figure 61: 945GME Hard Disk Security Master Password

BIOS setting	Meaning	Setting options	Effect
Primary Slave HDD Master Password	This function makes it possible to use the user password to change or configure each hard drive without having to reboot the device.	Enter	Enter password.

Table 122: 945GME Hard Disk Security Master Password

1.8 Power

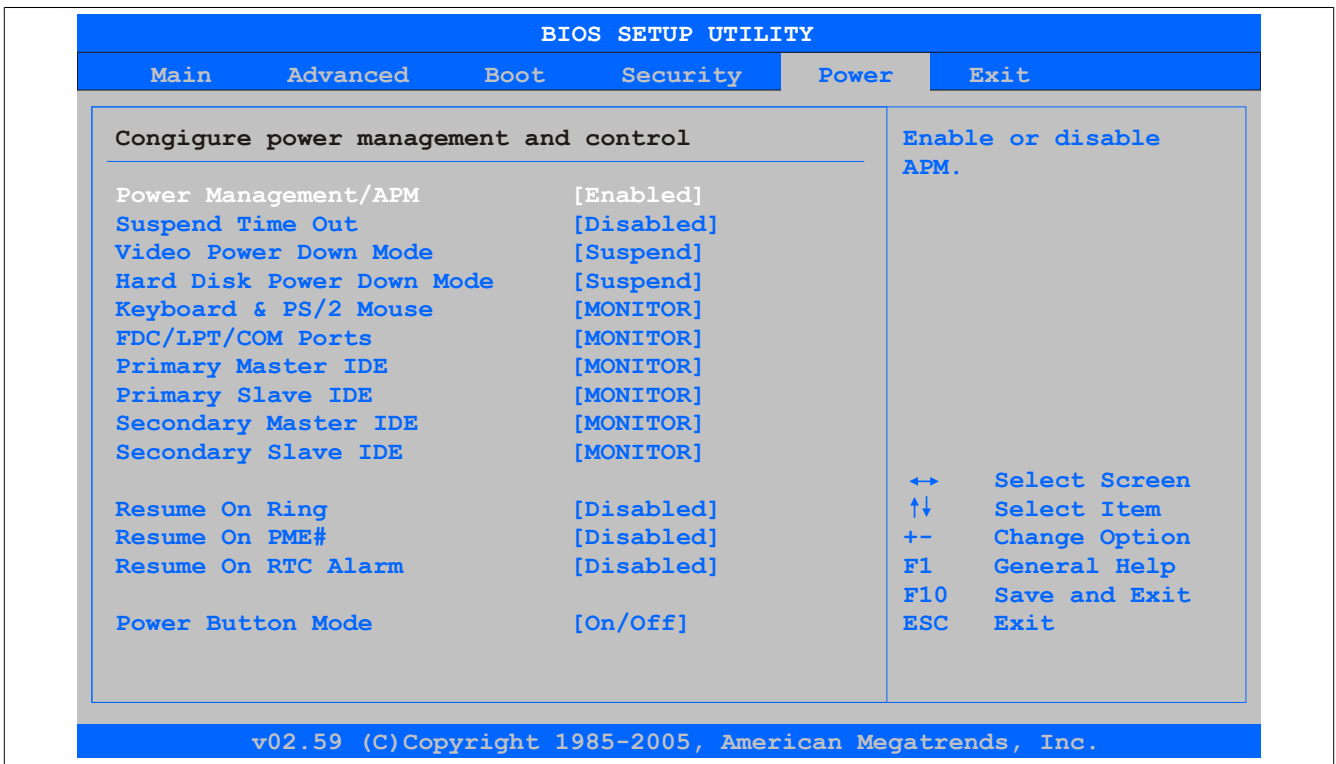

Figure 62: 945GME Power Menü

BIOS setting	Meaning	Setting options	Effect
Power Management / APM	This option switches the APM function on or off. This is an advanced plug & play and power management functionality.	Disabled	Disables this function.
		Enabled	Enables this function.
Suspend Time Out	Using this option, you can configure how long the system stays inactive (all components but the CPU are shut off, if possible) before entering suspend mode.	Disabled	
		1 min, 2 min, 4 min, 8 min, 10 min, 20 min 30 min, 40 min, 50 min, 60 min;	Value set manually.
Video Power Down Mode	This option allows you to set the energy saving mode for the monitor.	Disabled	Do not switch off the monitor.
		Standby	Monitor goes to standby mode.
		Suspend	Monitor goes to suspend mode.
Hard Disk Power Down Mode	This option allows you to set the energy saving mode for the hard drive.	Disabled	Do not switch off the hard drive.
		Standby	Monitor goes to standby mode.
		Suspend	Hard drive goes to suspend mode.
Keyboard & PS/2 Mouse	The monitoring of activities during power saving mode is determined here.	MONITOR	Keyboard or PS/2 mouse activities return the system to its normal state from a particular energy saving mode.
		IGNORE	Activities are ignored.
FDC/LPT/COM ports	The monitoring of activities during power saving mode is determined here.	MONITOR	Activity on the parallel port, the serial 1&2 port, or the floppy port returns the system to its normal state from an energy saving mode.
		IGNORE	Activities are ignored.
Primary Master IDE	The monitoring of activities during power saving mode is determined here.	MONITOR	Activities in the IRQ of specific connections or devices return the system to its normal state from power saving mode.
		IGNORE	Activities are ignored.
Primary Slave IDE	The monitoring of activities during power saving mode is determined here.	MONITOR	Activities in the IRQ of specific connections or devices return the system to its normal state from power saving mode.
		IGNORE	Activities are ignored.
Secondary Master IDE	The monitoring of activities during power saving mode is determined here.	MONITOR	Activities in the IRQ of specific connections or devices return the system to its normal state from power saving mode.
		IGNORE	Activities are ignored.
Secondary Slave IDE	The monitoring of activities during power saving mode is determined here.	MONITOR	Activities in the IRQ of specific connections or devices return the system to its normal state from power saving mode.
		IGNORE	Activities are ignored.
Resume On Ring	When the modem receives an incoming call, the PC is brought out of power saving mode.	Disabled	Disables this function.
		Enabled	Enables this function.
Resume on PME#	With this option, you can switch the PME wake-up function on or off.	Disabled	Disables this function.
		Enabled	Enables this function.
Resume On RTC Alarm	With this option, you can activate the alarm and enter the date and time for the system start.	Disabled	Disables this function.
		Enabled	Enables this function.
Power Button Mode	This function determines the function of the power button.	On/Off	Power button switches on/off.
		Suspend	Suppresses the function.

Table 123: 945GME Power Menu (Setting options)

1.9 Exit

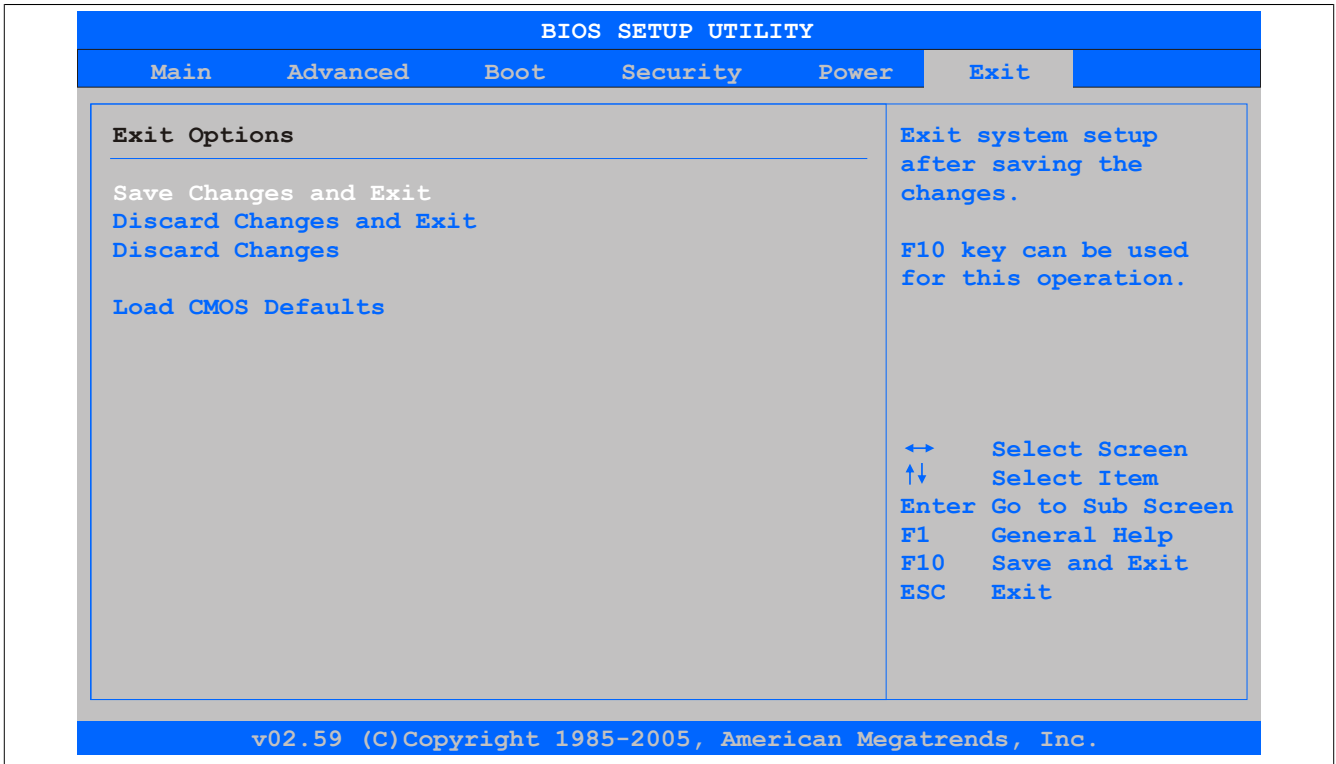

Figure 63: 945GME Exit Menü

BIOS setting	Meaning	Setting options	Effect
Save Changes and Exit	BIOS setup is closed with this item. Changes made are saved in CMOS after confirmation, and the system is rebooted.	OK / Cancel	
Discard Changes and Exit	With this item you can close BIOS setup without saving the changes made.	OK / Cancel	
Discard Changes	In the event that settings were made that the user can no longer remember, they can be reset as long as they haven't been saved.	OK / Cancel	
Load CMOS Defaults	This item loads the CMOS default values, which are defined by the DIP switch settings. These settings are loaded for all BIOS configurations.	OK / Cancel	

Table 124: 945GME - Advanced PCI configuration - Setting options

1.10 BIOS default settings

The various positions of the CMOS profile hex switch can be used to load predefined BIOS profile settings.

Information:

The factory default switch position represents the optimal BIOS default values for this system and should therefore not be changed.

If the "Load setup defaults" function is selected in the main BIOS Setup screen, or if "Exit" is selected (or <F9> is pressed) in the individual setup screens, the following BIOS settings are the optimized values that will be used.

Profile number	Optimized for	Switch position	Note
Profile 0	Reserved	0	
Profile 1	System unit 5PC810.SX01-00 / 5PC810.SX02-00 / 5PC810.SX03-00	1	The default settings for this profile can be found in the APC810 user's manual. This can be downloaded at no cost from the B&R website.
Profile 2	System unit 5PC810.SX05-00	2	
Profile 3	System unit 5PC820.SX01-00 / 5PC820.SX01-01	3	The default settings for this profile can be found in the APC820 user's manual. This can be downloaded at no cost from the B&R website.
Profile 4	Reserved	4	
Profile 5	System unit 5PC820.1505-00 / 5PC820.1906-00	5	The default settings for this profile can be found in the PPC800 user's manual. This can be downloaded at no cost from the B&R website.

Table 125: Profile overview

The following pages provide an overview of the BIOS default settings for the different CMOS profile switch positions. Settings highlighted in yellow are variations from the BIOS default profile (=profile 0).

1.10.1 Main

Setting / View	Profile 0	Profile 3	My setting
System Time	-	-	
System Date	-	-	
BIOS ID	-	-	
Processor	-	-	
CPU Frequency	-	-	
System Memory	-	-	
Product Revision	-	-	
Serial Number	-	-	
BC Firmware Rev.	-	-	
MAC Address (ETH1)	-	-	
Boot Counter	-	-	
Running Time	-	-	

Table 126: 945GME Main (Profile setting overview)

1.10.2 Advanced

1.10.2.1 ACPI configuration

Setting / View	Profile 0	Profile 3	My setting
ACPI Aware O/S	Yes	Yes	
ACPI Version Features	ACPI v2.0	ACPI v2.0	
ACPI APIC support	Enabled	Enabled	
Suspend mode	S1 (POS)	S1 (POS)	
USB Device Wakeup from S3/S4	Disabled	Disabled	
Active Cooling Trip Point	Disabled	Disabled	
Passive Cooling Trip Point	Disabled	Disabled	
Critical Trip Point	105°C	105°C	

Table 127: 945GME Advanced - ACPI configuration profile setting overview

1.10.2.2 PCI Configuration

Setting / View	Profile 0	Profile 3	My setting
Plug & Play O/S	No	Yes	
PCI Latency Timer	64	64	
Allocate IRQ to PCI VGA	Yes	Yes	
Allocate IRQ to SMBUS HC	Yes	Yes	
Allocate IRQ to PCIEX2	Yes	Yes	
PCI IRQ Resource Exclusion			

Table 128: 945GME Advanced - PCI configuration profile setting overview

Setting / View	Profile 0	Profile 3	My setting
IRQ3	Allocated	Allocated	
IRQ4	Allocated	Allocated	
IRQ5	Available	Allocated	
IRQ6	Available	Allocated	
IRQ7	Available	Available	
IRQ9	Allocated	Allocated	
IRQ10	Available	Available	
IRQ11	Allocated	Available	
IRQ12	Available	Available	
IRQ14	Allocated	Allocated	
IRQ15	Allocated	Available	
PCI Interrupt Routing			
PIRQ A (VGA, PCIEX0, ETH2, UHCI2)	Auto	Auto	
PIRQ B (PCIEX1, ETH1)	Auto	Auto	
PIRQ C (PCIEX2, IF slot)	Auto	Auto	
PIRQ D (SATA, UHCI1, SMB, PCIEX3)	Auto	Auto	
PIRQ E (INTD, PATA, UHCI3)	Auto	Auto	
PIRQ F (INTA, POWERLINK)	Auto	5	
PIRQ G (INTB, CAN, Timer)	Auto	6	
PIRQ H (INTC, UHCI0, EHCI)	Auto	Auto	
1st Exclusive PCI	-	5	
2nd Exclusive PCI	-	6	
3rd Exclusive PCI	-	-	

Table 128: 945GME Advanced - PCI configuration profile setting overview

1.10.2.3 PCI express configuration

Setting / View	Profile 0	Profile 3	My setting
Active State Power-Management	Disabled	Disabled	
PCIe Port 0	Auto	Auto	
PCIe Port 1	Auto	Auto	
PCIe Port 2 (IF slot)	Auto	Auto	
PCIe Port 3	Auto	Auto	
PCIe Port 4 (ETH2)	Auto	Auto	
PCIe Port 5 (ETH1)	Auto	Auto	
PCIe High Priority Port	Disabled	Disabled	
Res. PCIe Hot Plugging Resource	No	No	
PCIe Port 0 IOxAPIC Enable	Disabled	Disabled	
PCIe Port 1 IOxAPIC Enable	Disabled	Disabled	
PCIe Port 2 IOxAPIC Enable	Disabled	Disabled	
PCIe Port 3 IOxAPIC Enable	Disabled	Disabled	

Table 129: 945GME Advanced - PCI Express configuration profile setting overview

1.10.2.4 Graphics configuration

Setting / View	Profile 0	Profile 3	My setting
Primary Video Device	Internal VGA	Internal VGA	
Internal Graphics Mode Select	Enabled, 8MB	Enabled, 8MB	
DVMT Mode Select	DVMT Mode	DVMT Mode	
DVMT/FIXED Memory	128 MB	128 MB	
Boot Display Device	Auto	Auto	
Boot Display Preference	SDVO-B SDVO-C LFP	SDVO-B SDVO-C LFP	
Local Flat Panel Type	Auto	Auto	
Local flat panel scaling	Centering	Centering	
SDVO Port B Device	DVI	DVI	
SDVO Port C Device	DVI	None	
SDVO/DVI Hot Plugging Support	Enabled	Enabled	
Display Mode Persistence	Enabled	Enabled	

Table 130: 945GME Advanced - Graphics configuration profile setting overview

1.10.2.5 CPU configuration

Setting / View	Profile 0	Profile 3	My setting
MPS Revision	1.4	1.4	
Max CPUID value limit	Disabled	Disabled	
Execute Disable Bit	Enabled	Enabled	
Core Multi-Processing	Enabled	Enabled	
Intel(R) SpeedStep(tm) tech.	Automatic	Automatic	
Max. CPU frequency	xxxx MHz	xxxx MHz	
C1 Config.	Standard	Standard	
C2 Config.	Disabled	Disabled	
C3 Config.	Disabled	Disabled	
C4 Config.	Disabled	Disabled	

Table 131: 945GME Advanced - CPU configuration profile setting overview

1.10.2.6 Chipset configuration

Setting / View	Profile 0	Profile 3	My setting
DRAM Frequency	Auto	Auto	
DRAM Refresh Rate	Auto	Auto	
Memory Hole	Disabled	Disabled	
DIMM Thermal Control	Disabled	Disabled	
DT in SPD	Disabled	Disabled	
TS on DIMM	Disabled	Disabled	
High Precision Event Timer	Disabled	Disabled	
IOAPIC	Enabled	Enabled	
APIC ACPI SCI IRQ	Disabled	Disabled	
C4 On C3	Disabled	Disabled	

Table 132: 945GME Advanced - Chipset configuration profile setting overview

1.10.2.7 I/O interface configuration

Setting / View	Profile 0	Profile 3	My setting
Onboard Audio Controller	AC97	Disabled	

Table 133: 945GME Advanced - I/O Interface Configuration profile setting overview

1.10.2.8 Clock configuration

Setting / View	Profile 0	Profile 3	My setting
Spread spectrum	Disabled	Disabled	

Table 134: 945GME Advanced - Clock configuration profile setting overview

1.10.2.9 IDE Configuration

Setting / View	Profile 0	Profile 3	My setting
ATA/IDE Configuration	Compatible	Compatible	
Legacy IDE Channels	SATA Pri, PATA Sec	PATA only	
Configure SATA as	-	Disabled	
Hard disk write protect	Disabled	Disabled	
IDE Detect Time Out (Sec)	35	35	
ATA(PI) 80-Pin Cable Detection	Host & device	Host & device	
Primary IDE Master			
Type	Auto	Auto	
LBA/Large Mode	Auto	Auto	
Block (Multi-Sector Transfer)	Auto	Auto	
PIO Mode	Auto	Auto	
DMA Mode	Auto	Auto	
S.M.A.R.T.	Auto	Auto	
32Bit data transfer	Enabled	Enabled	
Primary IDE slave			
Type	Auto	Auto	
LBA/Large Mode	Auto	Auto	
Block (Multi-Sector Transfer)	Auto	Auto	
PIO Mode	Auto	Auto	
DMA Mode	Auto	Auto	
S.M.A.R.T.	Auto	Auto	
32Bit data transfer	Enabled	Enabled	
Secondary IDE Master			
Type	Auto	-	

Table 135: 945GME Advanced - IDE configuration profile setting overview

Setting / View	Profile 0	Profile 3	My setting
LBA/Large Mode	Auto	-	
Block (Multi-Sector Transfer)	Auto	-	
PIO Mode	Auto	-	
DMA Mode	Auto	-	
S.M.A.R.T.	Auto	-	
32Bit data transfer	Enabled	-	
Secondary IDE slave			
Type	Auto	-	
LBA/Large Mode	Auto	-	
Block (Multi-Sector Transfer)	Auto	-	
PIO Mode	Auto	-	
DMA Mode	Auto	-	
S.M.A.R.T.	Auto	-	
32Bit data transfer	Enabled	-	

Table 135: 945GME Advanced - IDE configuration profile setting overview

1.10.2.10 USB Configuration

Setting / View	Profile 0	Profile 3	My setting
USB Function	8 USB Ports	8 USB Ports	
USB 2.0 Controller	Enabled	Enabled	
Legacy USB Support	Enabled	Enabled	
USB Legacy POST-Always	Enabled	Enabled	
USB Keyboard Legacy Support	Enabled	Enabled	
USB Mouse Legacy Support	Disabled	Disabled	
USB Storage Device Support	Enabled	Enabled	
Port 64/60 Emulation	Disabled	Disabled	
USB 2.0 Controller Mode	HiSpeed	HiSpeed	
BIOS EHCI Hand-Off	Disabled	Disabled	
USB Beep Message	Enabled	Enabled	
USB Stick Default Emulation	Hard disk drive	Hard disk drive	
USB Mass Storage Reset Delay	20 Sec	20 Sec	

Table 136: 945GME Advanced - USB configuration profile setting overview

1.10.2.11 Keyboard/mouse configuration

Setting / View	Profile 0	Profile 3	My setting
Boot-up Num-lock	On	On	
Typematic rate	Fast	Fast	

Table 137: 945GME Advanced - Keyboard/Mouse Configuration profile setting overview

1.10.2.12 Remote access configuration

Setting / View	Profile 0	Profile 3	My setting
Remote access	Disabled	Disabled	
Serial port BIOS update	Disabled	Disabled	

Table 138: 945GME Advanced - Remote Access Configuration profile setting overview

1.10.2.13 CPU Board Monitor

Setting / View	Profile 0	Profile 3	My setting
H/W Health Function	Enabled	Enabled	

Table 139: 945GME Advanced - CPU board monitor profile setting overview

1.10.2.14 Main Board/Panel Features

Setting / View	Profile 0	Profile 3	My setting
Panel control			
Select panel number	-	-	
Version	-	-	
Brightness	100%	100%	
Temperature	-	-	
Fan speed	-	-	
Keys/LEDs	-	-	
Baseboard monitor			
CMOS battery	-	-	
Baseboard Out	-	-	

Table 140: 945GME Advanced - Baseboard/Panel Features profile setting overview

Setting / View	Profile 0	Profile 3	My setting
Baseboard Center	-	-	
Baseboard In	-	-	
Power supply	-	-	
IF slot	-	-	
Case 1	-	-	
Case 2	-	-	
Case 3	-	-	
Case 4	-	-	
Legacy Devices			
COM A	Enabled	Enabled	
Base I/O address	3F8	3F8	
Interrupt	IRQ4	IRQ4	
COM B	Enabled	Enabled	
Base I/O address	2F8	2F8	
Interrupt	IRQ3	IRQ3	
COM C	Enabled	Disabled	
Base I/O address	3E8	-	
Interrupt	IRQ11	-	
CAN	Disabled	Disabled	
Hardware security key	Enabled	Enabled	
Base I/O address	378	378	
ETH2 LAN Controller	Enabled	Enabled	
ETH2 MAC Address	-	-	

Table 140: 945GME Advanced - Baseboard/Panel Features profile setting overview

1.10.3 Boot

Setting / View	Profile 0	Profile 3	My setting
Boot Priority Selection	Type Based	Type Based	
1st Boot Device	Onboard LAN	Primary Master	
2nd Boot Device	Primary Master	Primary Slave	
3rd Boot Device	Primary Slave	USB Floppy	
4th Boot Device	USB Floppy	USB Removable Device	
5th Boot Device	USB Removable Device	USB Hard Disk	
6th Boot Device	USB CDROM	USB CDROM	
7th Boot Device	Secondary Master	Disabled	
8th Boot Device	Secondary Slave	Disabled	
Quick Boot	Enabled	Enabled	
Quiet Boot	Disabled	Disabled	
Automatic Boot List Retry	Disabled	Disabled	
Add-On ROM Display Mode	Keep Current	Keep Current	
Halt On Error	Disabled	Disabled	
Hit "DEL" Message Display	Enabled	Enabled	
Interrupt 19 Capture	Disabled	Disabled	
PXE boot to LAN (ETH1)	Enabled	Disabled	
Slide-in 2 optional ROM	Enabled	Disabled	
Power Loss Control	Turn On	Turn On	

Table 141: 945GME Main (Profile setting overview)

1.10.4 Security

Setting / View	Profile 0	Profile 3	My setting
Supervisor Password	-	-	
User Password	-	-	
Boot Sector Virus Protection	Disabled	Disabled	
Hard disk security user password	-	-	
Hard disk security master password	-	-	

Table 142: 945GME Security profile setting overview

1.10.5 Power

Setting / View	Profile 0	Profile 3	My setting
Power Management/APM	Enabled	Enabled	
Suspend Time Out	Disabled	Disabled	
Video Power Down Mode	Suspend	Suspend	
Hard Disk Power Down Mode	Suspend	Suspend	
Keyboard & PS/2 Mouse	MONITOR	MONITOR	
FDC/LPT/COM ports	MONITOR	MONITOR	
Primary Master IDE	MONITOR	MONITOR	

Table 143: 945GME Power profile setting overview

Setting / View	Profile 0	Profile 3	My setting
Primary Slave IDE	MONITOR	MONITOR	
Secondary Master IDE	MONITOR	MONITOR	
Secondary Slave IDE	MONITOR	MONITOR	
Resume On Ring	Disabled	Disabled	
Resume on PME#	Disabled	Disabled	
Resume On RTC Alarm	Disabled	Disabled	
Power Button Mode	On/Off	On/Off	

Table 143: 945GME Power profile setting overview

1.11 BIOS error signals (beep codes)

While the B&R Industrial PC is booting, the following messages and errors can occur with BIOS. These errors are signaled by different beep codes.

Beep code	Description	Necessary user action
1x short	Memory refresh failed	Load BIOS defaults. If the error persists, send the industrial PC to B&R for testing.
2x short	Parity error: POST error (error in one of the hardware testing procedures)	Check that the card has been inserted properly. If the error persists, send the industrial PC to B&R for testing.
3x short	Base 64 kB memory failure: Basic memory error, RAM error within the initial 64 kB	Send the industrial PC to B&R for testing.
4x short	Timer not operational: System timer	Send the industrial PC to B&R for testing.
5x short	Processor error: Defective processor	Send the industrial PC to B&R for testing.
6x short	8042 gate A20 failure: Defective keyboard controller (block 8042/gate A20). The processor cannot switch to protected mode.	Send the industrial PC to B&R for testing.
7x short	Processor exception interrupt error: Virtual mode exception error (CPU generated an interrupt error)	Send the industrial PC to B&R for testing.
8x short	Display memory read/write error: Video memory not accessible, defective graphics card or not installed (not a fatal error)	Check that the graphics card has been inserted correctly, replace if necessary. If the error persists, send the industrial PC to B&R for testing.
9x short	ROM checksum error: ROM BIOS checksum incorrect; defective EPROM, EEPROM or flash ROM component; defective BIOS or incorrectly updated	Send the industrial PC to B&R for testing.
10x short	CMOS shutdown register read/write error: Unable to read/write from/to CMOS	Send the industrial PC to B&R for testing.
11x short	Cache error / external cache bad: Defective L2 cache on the main-board	Send the industrial PC to B&R for testing.

Table 144: 945GME BIOS - POST messages

1.12 Allocation of resources

1.12.1 RAM address assignment

RAM address	Address in Hex	Resource
(TOM - 192 kB) – TOM ¹⁾	N.A.	ACPI reclaim, MPS and NVS area ²⁾
(TOM - 8 MB - 192 kB) – (TOM - 192 kB)	N.A.	VGA frame buffer ³⁾
1024 kB – (TOM - 8 MB - 192 kB)	100000h - N.A.	Extended memory
869kB – 1024 kB	0E0000h - 0FFFFFFh	Runtime BIOS
832kB – 869 kB	0D0000h - 0DFFFFh	Upper memory (available)
640kB – 832 kB	0A0000h - 0CFFFFh	Video memory and BIOS
639kB – 640 kB	09FC00h - 09FFFFh	Extended BIOS data
0 - 639 kB	000000h - 09FC00h	Conventional memory

Table 145: RAM address assignment

- 1) TOM - Top of memory: Max. installed DRAM
- 2) Only if ACPI Aware OS is set to "YES" in the setup.
- 3) The VGA frame buffer can be reduced to 1 MB in the setup.

1.12.2 I/O address assignments

I/O address	Resource
0000h - 00FFh	Motherboard resources
0170h - 0177h	Secondary IDE channel
01F0h - 01F7h	Primary IDE channel
0278h - 027Fh	Hardware Security Key (LPT2)
02F8h - 02FFh	COM2
0376h - 0376h	Secondary IDE channel command port
0377h - 0377h	Secondary IDE channel status port
0378h - 037Fh	Hardware Security Key (LPT1)
03B0h - 03DFh	Video system
03E8h - 03EFh	COM3
03F6h - 03F6h	Primary IDE channel command port
03F7h - 03F7h	Primary IDE channel status port
03F8h - 03FFh	COM1
0480h - 04BFh	Motherboard resources
04D0h - 04D1h	Motherboard resources
0800h - 087Fh	Motherboard resources
0CF8h - 0CFBh	PCI config address register
0CFCh - 0CFFh	PCI config data register
0D00h - FFFFh	PCI / PCI Express bus ¹⁾
4100h - 417Fh	MTCX
FF00h - FF07h	IDE bus master register

Table 146: I/O address assignment

- 1) The BIOS assigns the PCI and PCI Express Bus I/O resources from FFF0h downward. Devices that are not compatible with PnP/PCI/PCI Express cannot use the I/O resources in this area.

1.12.3 Interrupt assignments in PIC mode

IRQ	0	1	2	3	4	5	6	7	8	9	10	11	12	13	14	15	NMI	NONE
System timer	•																	
Keyboard		•																
IRQ cascade			•															
COM1 (serial port A)				○	•	○	○	○			○	○	○					
COM2 (serial port B)				•	○	○	○	○			○	○	○					
ACPI ¹⁾										•								
Real-time clock									•									
Coprocessor (FPU)														•				
Primary IDE channel															•			
Secondary IDE channel																○		
B&R				○	○	○	○	○			○	○	○					•

Table 147: IRQ interrupt assignments in PIC mode

- 1) Advanced Configuration and Power Interface.

- ... Default setting
- ... Optional setting

1.12.4 Interrupt assignments in APIC mode

A total of 23 IRQs are available in APIC (**A**dvanced **P**rogrammable **I**nterrupt **C**ontroller) mode. Enabling this option is only effective if done before the operating system (Windows XP) is installed.

IRQ	0	1	2	3	4	5	6	7	8	9	10	11	12	13	14	15	16	17	18	19	20	21	22	23	NMI	NONE
System timer	•																									
Keyboard		•																								
IRQ cascade			•																							
COM1 (Serial port A)				○	•	○	○	○			○	○	○													
COM2 (Serial port B)				•	○	○	○	○			○	○	○													
ACPI ¹⁾										•																
Real-time clock									•																	
Coprocessor (FPU)														•												
Primary IDE channel															•											
Secondary IDE channel																○										
B&R				○	○	○	○	○			○	○	○													•
COM3 (COM C)																										
PIRQ A ²⁾																•										
PIRQ B ³⁾																	•									
PIRQ C ⁴⁾																		•								
PIRQ D ⁵⁾																			•							
PIRQ E ⁶⁾																				•						
PIRQ F ⁷⁾																					•					
PIRQ G ⁸⁾																						•				
PIRQ H ⁹⁾																							•			

Table 148: IRQ interrupt assignments in APIC mode

- 1) Advanced Configuration and Power Interface.
- 2) PIRQ A: for PCIe; UHCI Host Controller 2, VGA controller, PCI Express root port 4
- 3) PIRQ B: for PCIe; PCI Express root port 5, onboard Gigabit LAN controller
- 4) PIRQ C: for PCIe; PCI express root port 2, IF slot
- 5) PIRQ D: for PCIe; UHCI Host Controller 1, SMBus controller, PCI Express root port 3
- 6) PIRQ E: PCI bus INTD, PATA in native mode, UHCI host controller 3
- 7) PIRQ F: PCI bus INTA, POWERLINK
- 8) PIRQ G: PCI bus INTB, CAN, timer
- 9) PIRQ H: PCI bus INTC, UHCI host controller 0, EHCI host controller

- ... Default setting
- ... Optional setting

Information:

IF slots cannot be used in system units with revision A0.

1.12.5 Interrupt routing for BIOS up to V1.12

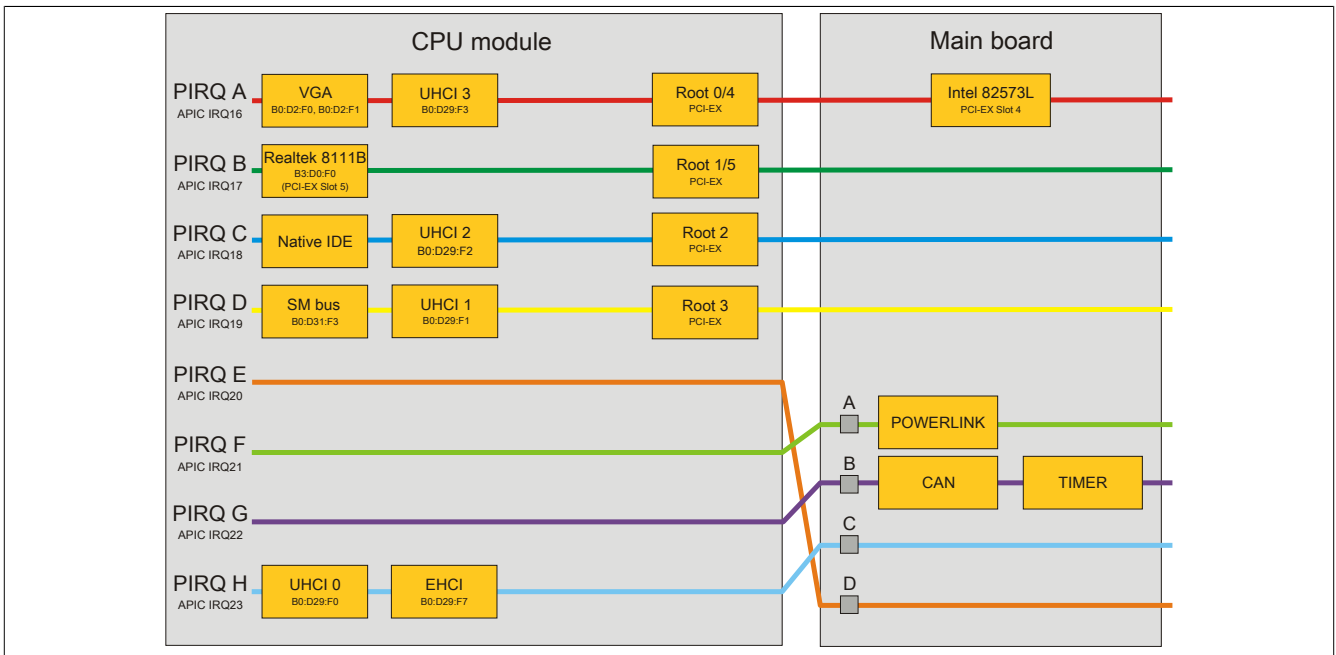

Figure 64: Interrupt routing for BIOS up to V1.12

Information:

The PIRQ C must be set to exclusive for an exclusive interrupt in the BIOS. In this case, devices cannot be connected to the USB ports (USB2 and USB4).

1.12.6 Interrupt routing for BIOS starting with V1.14

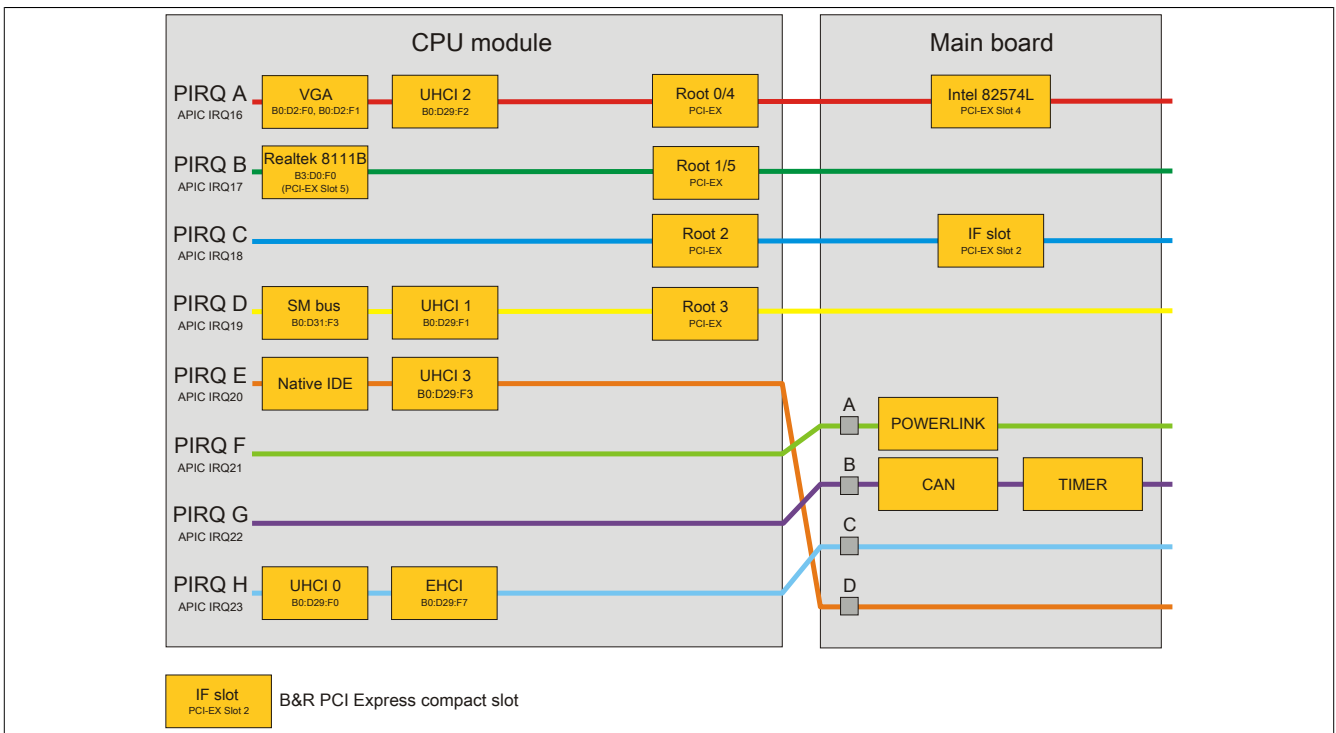

Figure 65: Interrupt routing for BIOS starting with V1.14

2 Upgrade information

Warning!

The BIOS and firmware on B&R devices must be kept current. New versions can be downloaded from the B&R website (www.br-automation.com).

2.1 BIOS upgrade

An upgrade may be necessary in order to accomplish the following:

- Updating implemented functions or adding newly implemented functions or components to BIOS Setup (information about changes can be found in the Readme file for the BIOS upgrade).

2.1.1 Important information

Information:

Customized BIOS settings are deleted when upgrading BIOS.

Before starting an upgrade, it helps to determine the various software versions.

2.1.1.1 Which BIOS version and firmware are already installed on the APC820?

This information can be found on the following BIOS Setup screen:

- After switching on the APC820, BIOS Setup can be accessed by pressing .
- From the BIOS main menu "Advanced", select "Baseboard/Panel features".

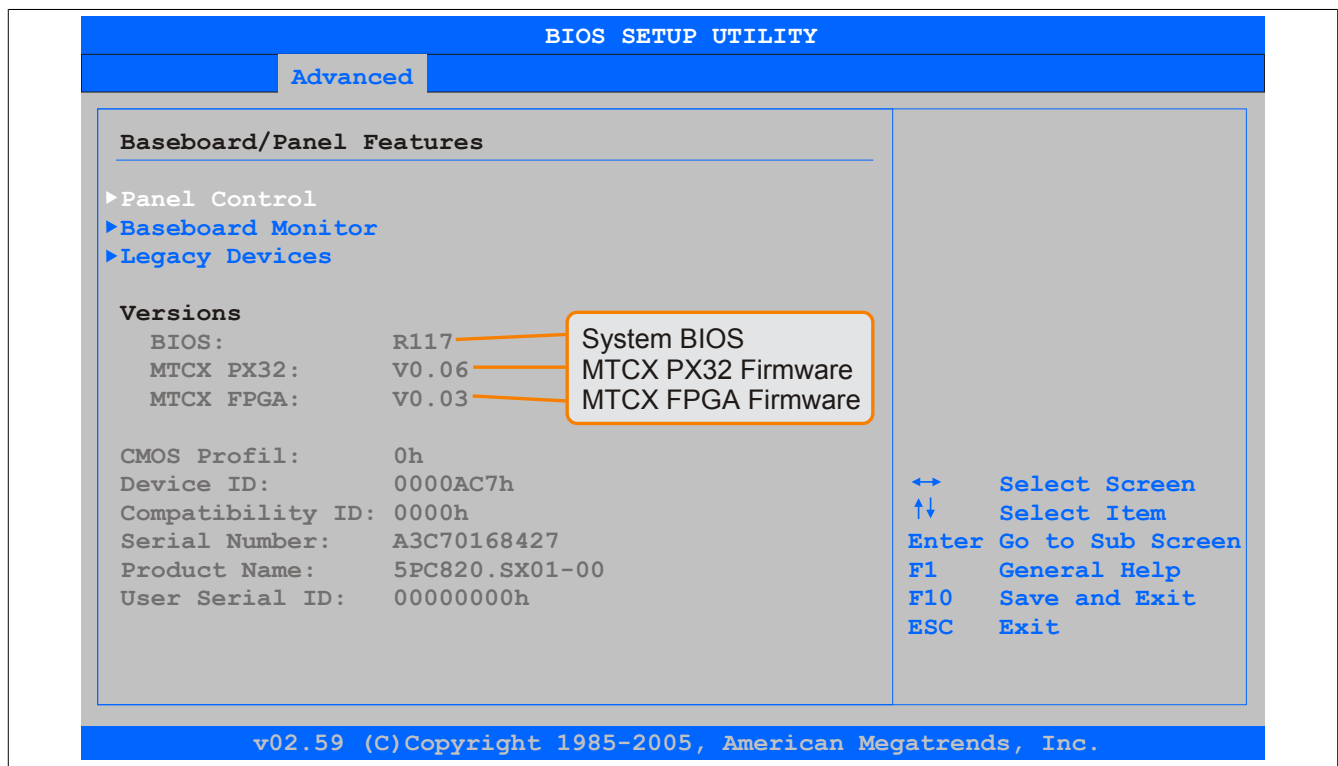

Figure 66: Softwareversion

2.1.1.2 Which firmware is installed on the Automation Panel Link transmitter?

This information can be found on the following BIOS setup page:

- After switching on the APC820, you can get to the BIOS Setup by pressing "Del".
- From the BIOS main menu "Advanced", select "Main board/panel features" and then "Panel control" on page 118.

Information:

The version can only be displayed when an Automation Panel is connected.

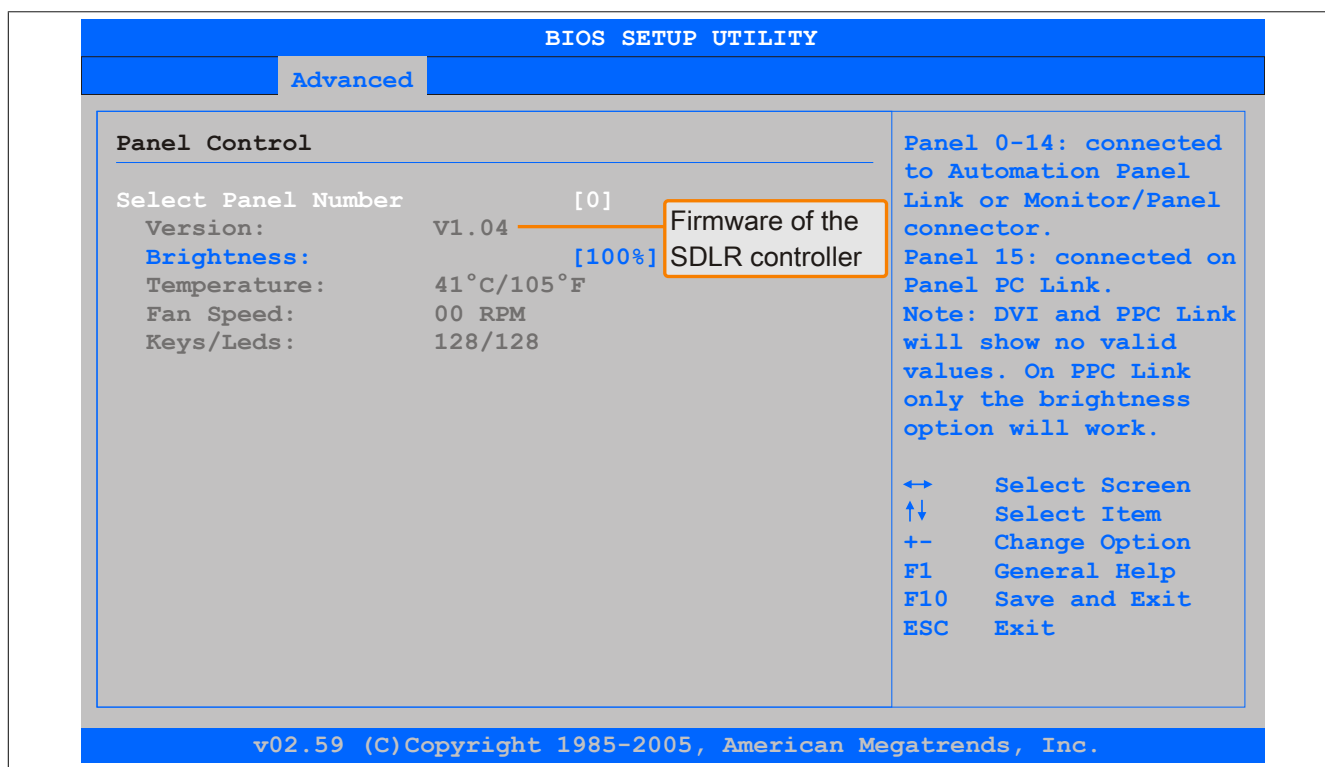

Figure 67: Firmware version of the AP Link SDL transmitter

2.1.2 Procedure with MS-DOS

1. Download the .zip file from the B&R website (www.br-automation.com).
2. Create bootable media.

Information:

In MS-DOS, Win95 and Win98, a blank HD disk can be made bootable by typing "sys a:" or "format a: /s" on the command line.

Information about creating a bootable diskette in Windows XP can be found on page 142.

Information on creating a USB flash drive for a B&R upgrade can be found on page 144.

Information on creating a CompactFlash card for a B&R upgrade can be found on page 145.

3. Copy the contents of the .zip file to the bootable media. If the B&R upgrade was already added when creating the bootable media with the B&R Embedded OS Installer, then this step is not necessary.
4. Connect the bootable media to the B&R device and reboot.
5. The following boot menu will be shown after startup:

```
1. Upgrade AMI BIOS for B945
2. Exit
```

Item 1:

BIOS is automatically upgraded (default after 5 seconds).

Item 2:

Returns to the shell (MS-DOS)

Information:

If a button is not pressed within 5 seconds, then item 1 "Upgrade AMI BIOS for B945" is automatically carried out to update the industrial PC.

6. The system must be rebooted after a successful upgrade.
7. Reboot and press to enter BIOS Setup and load the setup defaults, then select "Save changes and exit".

2.1.3 Using the Control Center

1. Download the .zip file from the B&R website (www.br-automation.com).
2. Open the **Control Center** in the Control Panel.
3. Select the **Versions** tab.
4. Under **CPU board**, click on **Update** for **BIOS**. This brings up the "Open" dialog box.
5. Enter the name of the BIOS file or select the file under **Filename**.
6. Click on **Open**. This brings up the "Open" dialog box.

The transfer can be canceled by clicking on **Cancel**. "Cancel" is disabled when writing to flash memory.

Deleting the data in flash memory can take several seconds depending on the memory block being used. The progress indicator is not updated during this time.

Information:

The system must be restarted for the BIOS settings to take effect and for the updated version to be displayed. The user is prompted to restart the system when closing the Control Center.

Information:

For more information about saving and updating BIOS, please refer to the help documentation for the Control Center.

2.2 Firmware upgrade

The "Firmware upgrade (MTCX, SDLR)" software makes it possible to update the firmware for multiple controllers (MTCX, SDLR) depending on the APC820 system variant.

Current "Firmware upgrade (MTCX, SDLR)" software can be downloaded directly from the Download section of the B&R website (www.br-automation.com).

2.2.1 Procedure

Proceed as follows to carry out a firmware upgrade:

1. Download the .zip file from the B&R website (www.br-automation.com).
2. Create bootable media.

Information:

In MS-DOS, Win95 and Win98, a blank HD disk can be made bootable by typing "sys a:" or "format a: /s" on the command line.

Information about creating a bootable diskette in Windows XP can be found on page 142.

Information on creating a USB flash drive for a B&R upgrade can be found on page 144.

Information on creating a CompactFlash card for a B&R upgrade can be found on page 145.

3. Copy the contents of the .zip file to the bootable media. If the B&R upgrade was already added when creating the bootable media with the B&R Embedded OS Installer, then this step is not necessary.
4. Connect the bootable media to the B&R device and reboot.
5. The following boot menu will be shown after startup:

Information:

The following boot menu options including descriptions are based on Version 1.04 of the APC820 upgrade (MTCX, SDLR) disk. In some cases, these descriptions might not match the version you are currently using.

```

1. Upgrade MTCX (APC820) PX32 and FPGA
2. Upgrade SDLR (AP800/AP900) on Monitor/Panel
2.1. Upgrade SDLR on AP 0 (AP800/AP900)
2.2. Upgrade SDLR on AP 1 (AP800/AP900)
2.3. Upgrade SDLR on AP 2 (AP800/AP900)
2.4. Upgrade SDLR on AP 3 (AP800/AP900)
2.5. Upgrade all SDLR (AP800/AP900)
2.6. Return to Main Menu
3. Exit

```

Item 1:

Automatically upgrades the PX32 and FPGA of the MTCX (default after 5 seconds)

Item 2:

Opens Submenu 1 for upgrading the SDLR controller on the monitor/panel interface

2.1 Upgrade SDLR on AP 0 (AP800/AP900)

Automatically updates the SDLR controller on the Automation Panel 0 interface

2.2 Upgrade SDLR on AP 1 (AP800/AP900)

Automatically updates the SDLR controller on the Automation Panel 1 interface

2.3 Upgrade SDLR on AP 2 (AP800/AP900)

Automatically updates the SDLR controller on the Automation Panel 2 interface

2.4 Upgrade SDLR on AP 3 (AP800/AP900)

Automatically updates the SDLR controller on the Automation Panel 3 interface

2.5 Upgrade all SDLR (AP800/AP900)

Automatically updates all SDLR controllers on all Automation Panels on the monitor/panel interface (default selection after 5 sec)

2.6 Return to main menu

Returns to the main menu

Item 3:

Returns to the shell (MS-DOS)

Information:

The system must be powered off and back on again after a successful upgrade.

2.2.2 Possible upgrade problems and software dependencies (for V1.04)

- The SDLR firmware can only be updated if an Automation Panel with Automation Panel Link transceiver (5DLSDL.1000-01) and Automation Panel Link receiver (5DLSDL.1000-00) is connected.
- Automation Panel Link transceivers (5DLSDL.1000-01) or Automation Panel Link receivers (5DLSDL.1000-00) with a firmware version less than or equal to V00.10 can no longer be combined with Automation Panel Link transceivers (5DLSDL.1000-01) or Automation Panel Link receivers (5DLSDL.1000-00) with a firmware version greater than or equal to V01.04. Daisy chain mode is not possible with this type of a combination.

2.3 Creating an MS-DOS boot diskette in Windows XP

1. Insert a blank 1.44 MB HD diskette into the disk drive.
2. Open Windows Explorer.
3. Right-click on the 3½ floppy diskette icon and select "Format".

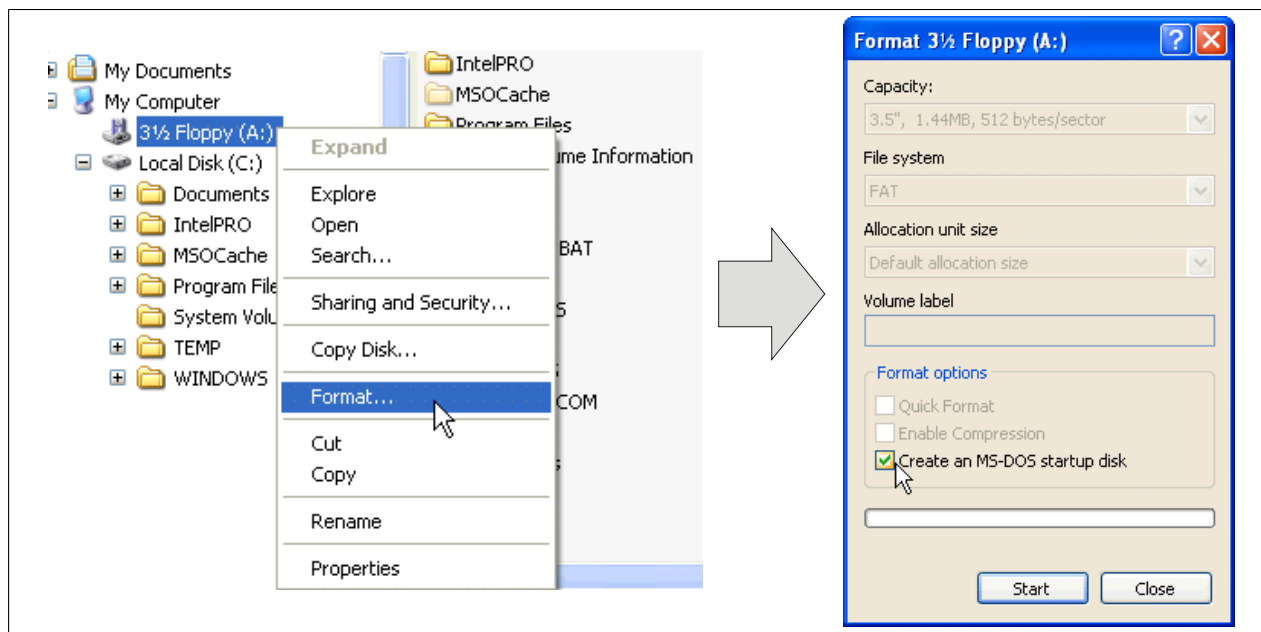

Figure 68: Creating a bootable diskette in Windows XP - Step 1

4. Select the **"Create an MS-DOS startup disk"** option, click on **"Start"** and acknowledge the warning message with "OK".

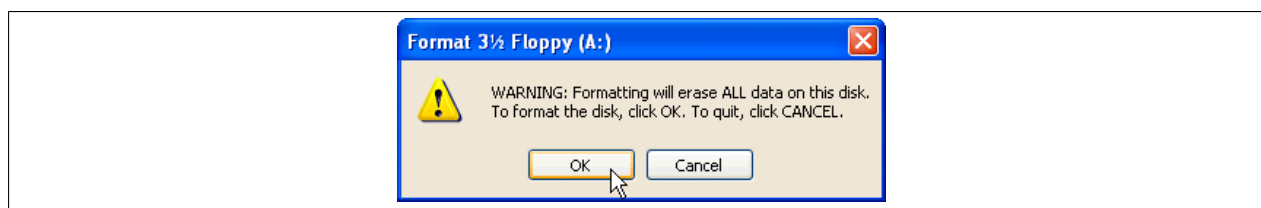

Figure 69: Creating a bootable diskette in Windows XP - Step 2

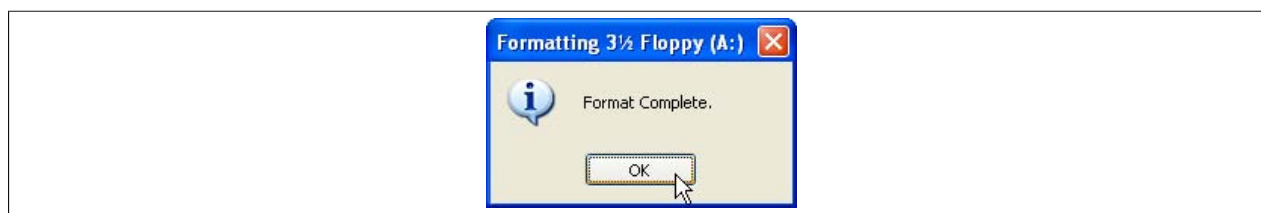

Figure 70: Creating a bootable diskette in Windows XP - Step 3

After creating the startup disk, some of the files must be deleted because of the size of the update.

To do this, all files (hidden system files, etc.) must be visible on the diskette.

In Windows Explorer, go to the "Tools" menu, select "Folder options" and open the "View" tab. Then deselect the option "Hide protected operating system files (Recommended)" (enabled by default) and enable the option "Show hidden files and folders".

before				after			
Name	Size	Type	Date Modified	Name	Size	Type	Date Modified
DISPLAY.SYS	17 KB	System file	6/8/2000 5:00 PM	AUTOEXEC.BAT	0 KB	MS-DOS Batch File	3/22/2006 10:08 AM
EGA2.CPI	58 KB	CPI File	6/8/2000 5:00 PM	COMMAND.COM	91 KB	MS-DOS Application	6/8/2000 5:00 PM
EGA3.CPI	58 KB	CPI File	6/8/2000 5:00 PM	CONFIG.SYS	0 KB	System file	3/22/2006 10:08 AM
EGA.CPI	58 KB	CPI File	6/8/2000 5:00 PM	DISPLAY.SYS	17 KB	System file	6/8/2000 5:00 PM
KEYB.COM	22 KB	MS-DOS Application	6/8/2000 5:00 PM	EGA2.CPI	58 KB	CPI File	6/8/2000 5:00 PM
KEYBOARD.SYS	34 KB	System file	6/8/2000 5:00 PM	EGA3.CPI	58 KB	CPI File	6/8/2000 5:00 PM
KEYBRD2.SYS	32 KB	System file	6/8/2000 5:00 PM	EGA.CPI	58 KB	CPI File	6/8/2000 5:00 PM
KEYBRD3.SYS	31 KB	System file	6/8/2000 5:00 PM	IO.SYS	114 KB	System file	5/15/2001 6:57 PM
KEYBRD4.SYS	13 KB	System file	6/8/2000 5:00 PM	KEYB.COM	22 KB	MS-DOS Application	6/8/2000 5:00 PM
MODE.COM	29 KB	MS-DOS Application	6/8/2000 5:00 PM	KEYBOARD.SYS	34 KB	System file	6/8/2000 5:00 PM
				KEYBRD2.SYS	32 KB	System file	6/8/2000 5:00 PM
				KEYBRD3.SYS	31 KB	System file	6/8/2000 5:00 PM
				KEYBRD4.SYS	13 KB	System file	6/8/2000 5:00 PM
				MODE.COM	29 KB	MS-DOS Application	6/8/2000 5:00 PM
				MSDOS.SYS	1 KB	System file	4/7/2001 1:40 PM

Figure 71: Creating a bootable diskette in Windows XP - Step 4

Name	Size	Type	Date Modified
AUTOEXEC.BAT	0 KB	MS-DOS Batch File	3/22/2006 10:08 AM
COMMAND.COM	91 KB	MS-DOS Application	6/8/2000 5:00 PM
CONFIG.SYS	0 KB	System file	3/22/2006 10:08 AM
DISPLAY.SYS	17 KB	System file	6/8/2000 5:00 PM
EGA2.CPI	58 KB	CPI File	6/8/2000 5:00 PM
EGA3.CPI	58 KB	CPI File	6/8/2000 5:00 PM
EGA.CPI	58 KB	CPI File	6/8/2000 5:00 PM
IO.SYS	114 KB	System file	5/15/2001 6:57 PM
KEYB.COM	22 KB	MS-DOS Application	6/8/2000 5:00 PM
KEYBOARD.SYS	34 KB	System file	6/8/2000 5:00 PM
KEYBRD2.SYS	32 KB	System file	6/8/2000 5:00 PM
KEYBRD3.SYS	31 KB	System file	6/8/2000 5:00 PM
KEYBRD4.SYS	13 KB	System file	6/8/2000 5:00 PM
MODE.COM	29 KB	MS-DOS Application	6/8/2000 5:00 PM
MSDOS.SYS	1 KB	System file	4/7/2001 1:40 PM

Figure 72: Creating a bootable diskette in Windows XP - Step 5

Now all files (selected) except Command.com, IO.sys and MSDOS.sys can be deleted.

2.4 Creating a bootable USB flash drive for B&R upgrade files

When used in connection with a B&R Industrial PC, it is possible to upgrade (e.g. BIOS) from one of the USB flash drives available from B&R. To do this, the USB flash drive must be prepared accordingly. This is done with the B&R Embedded OS Installer, which can be downloaded at no cost from the B&R website (www.br-automation.com).

2.4.1 Requirements

The following is required to create a bootable USB flash drive:

- B&R USB flash drive
- B&R Industrial PC
- USB media drive
- B&R Embedded OS Installer (V3.00 or higher)

2.4.2 Procedure

1. Connect the USB flash drive to the PC.
2. If the drive list is not refreshed automatically, update the list using the **Drives > Refresh** command.
3. Select the desired USB flash drive in the drive list.
4. Change to the **Action** tab and select **Install a B&R update to a USB flash drive** as the type of action.
5. Enter the path to the MS-DOS operating system files. If the files are part of a .zip archive, then click on the button **From .zip file**. If the files are stored in a directory on the hard drive, then click on the button **From folder**.
6. In the **B&R upgrade** text box, it is also possible to enter the path to the .zip file for the B&R upgrade disk and select the file.
7. Click on the **Start action** button in the toolbar.

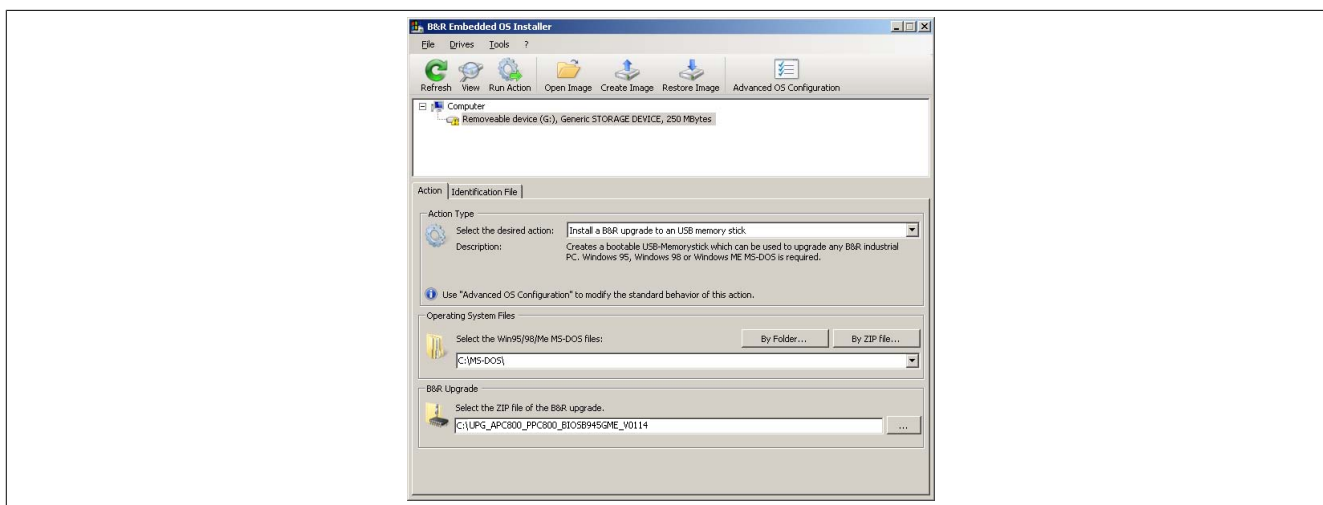

Figure 73: Creating a USB flash drive for B&R upgrade files

2.4.3 How to access MS-DOS

Information about creating an MS-DOS boot diskette can be found in section see "Creating an MS-DOS boot diskette in Windows XP" on page 142. The files from the diskette are then copied to the hard drive.

2.5 Creating a bootable CompactFlash card for B&R upgrade files

When used in connection with a B&R industrial PC, it is possible to upgrade (e.g. upgrade BIOS) from one of the CompactFlash cards available from B&R. To do this, the CompactFlash card must be prepared accordingly. This is done with the B&R Embedded OS Installer, which can be downloaded at no cost from the B&R website (www.br-automation.com).

2.5.1 Requirements

The following peripherals are required for creating a bootable CompactFlash card:

- CompactFlash card
- B&R Industrial PC
- USB media drive
- B&R Embedded OS Installer (at least V3.10)

2.5.2 Procedure

1. Insert the CompactFlash card in the CF slot on the industrial PC.
2. If the drive list is not refreshed automatically, the list can be updated using the command **Drives > Refresh**.
3. Select the desired CompactFlash card from the drive list.
4. Change to the **Action** tab and select **Install a B&R Update to a CompactFlash card** as the type of action.
5. Enter the path to the MS-DOS operating system files. If the files are part of a .zip archive, then click on the button **From .zip file**. If the files are stored in a directory on the hard drive, then click on the button **From folder**.
6. In the **B&R upgrade** text box, it is also possible to enter the path to the .zip file for the B&R upgrade disk and select the file.
7. Click on the **Start action** button in the toolbar.

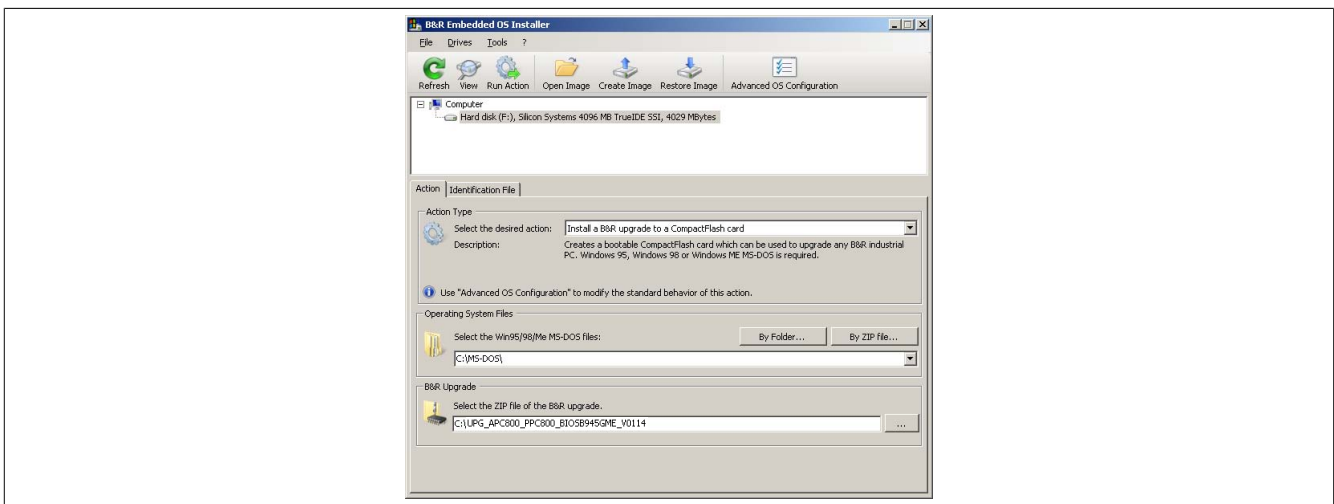

Figure 74: Creating a CompactFlash card for B&R upgrade files

2.5.3 How to access MS-DOS

Information about creating an MS-DOS boot diskette can be found in section see "Creating an MS-DOS boot diskette in Windows XP" on page 142. The files from the diskette are then copied to the hard drive.

3 Microsoft DOS

3.1 Order data

Model number	Short description	Figure
9S0000.01-010	OEM Microsoft MS-DOS 6.22, German floppy disks, only supplied together with a new PC	 <p>The figure shows a floppy disk label for 'DOS622 English Disk 1- Setup'. It features the B&R Automation logo (a stylized '8' and 'R' in orange and black) with the tagline 'Perfection in Automation'. Below the logo, it says 'DOS622 English' and 'Disk 1- Setup'. A grey bar contains the text 'Recovery Disk'. Below this, a warning states: 'Only allowed to be used for backup or archiving purposes for B&R automation devices!'. At the bottom, the website 'www.br-automation.com' is listed, along with the copyright notice '©1983-2000 Microsoft Corporation. All rights reserved.' and a vertical ID number '060000133' on the right edge.</p>
9S0000.01-020	OEM Microsoft MS-DOS 6.22, English floppy disks, only supplied together with a new PC	

Table 149: 9S0000.01-010, 9S0000.01-020 - Order data

3.2 Known problems

- AC97 sound is not supported.
- USB 2.0: only USB 1.1 rates can be achieved.
- Some "ACPI control" functions in BIOS cannot be used.

3.3 Resolutions and color depths

The following table shows the tested resolutions and color depths on the monitor/panel interface with 945GME CPU boards.

Resolutions for DVI	Color depth		
	8-bit	16-bit	24-bit
640 x 480	✓	✓	✓
800 x 600	✓	✓	✓
1024 x 768	✓	✓	✓
1280 x 1024	✓	✓	✓

Table 150: Tested resolutions and color depths for DVI signals

Resolutions for RGB	Color depth		
	8-bit	16-bit	24-bit
640 x 480	✓	✓	✓
800 x 600	✓	✓	✓
1024 x 768	✓	✓	✓
1280 x 1024	✓	✓	✓
1600 x 1200	✓	✓	✓
1920 x 1440	✓	✓	✓

Table 151: Tested resolutions and color depths for RGB signals

4 Windows XP Professional

4.1 General information

Information:

Discontinuation of support for Windows XP by Microsoft:

After April 8th, 2014, Microsoft will no longer be providing any security updates, hotfixes, support (free or paid) or technical resources for Windows XP.

4.2 Order data

Model number	Short description	Figure
	Windows XP Professional	
5SWWXP.0600-GER	Windows XP Professional SP3 - German - CD	
5SWWXP.0600-ENG	Windows XP Professional SP3 - English - CD	
5SWWXP.0600-MUL	Windows XP Professional SP3 - Multilingual - CD	
5SWWXP.0500-GER	Microsoft OEM Windows XP Professional Service Pack 2c, CD, German. Only available with a new device.	
5SWWXP.0500-ENG	Microsoft OEM Windows XP Professional Service Pack 2c, CD, English. Only available with a new device.	
5SWWXP.0500-MUL	Microsoft OEM Windows XP Professional Service Pack 2c, CD, multilingual. Only available with a new device.	

Table 152: 5SWWXP.0600-GER, 5SWWXP.0600-ENG, 5SWWXP.0600-MUL, 5SWWXP.0500-GER, 5SWWXP.0500-ENG, 5SWWXP.0500-MUL - Order data

4.3 Overview

Model number	Edition	Target system	Chipset	Service pack	Language	Minimum hard disk space required	Minimum RAM required
5SWWXP.0600-GER	Professional	APC510 APC511 APC620 APC810 APC820 APC910 PPC700 PPC725 PPC800 PPC900 PP500	945GME GM45 QM77/HM76 NM10 US15W	SP3	German	≤2.1 GB	128 MB
5SWWXP.0600-ENG	Professional	APC510 APC511 APC620 APC810 APC820 APC910 PPC700 PPC725 PPC800 PPC900 PP500	945GME GM45 QM77/HM76 NM10 US15W	SP3	English	≤2.1 GB	128 MB
5SWWXP.0600-MUL	Professional	APC510 APC511 APC620 APC810 APC820 APC910 PPC700 PPC725 PPC800 PPC900 PP500	945GME GM45 QM77/HM76 NM10 US15W	SP3	Multilingual	≤2.1 GB	128 MB
5SWWXP.0500-GER	Professional	APC620 APC810 APC820 PPC700 PPC725 PPC800	945GME GM45	SP2c	German	≤2.1 GB	128 MB
5SWWXP.0500-ENG	Professional	APC620 APC810 APC820 PPC700 PPC725 PPC800	945GME GM45	SP2c	English	≤2.1 GB	128 MB
5SWWXP.0500-MUL	Professional	APC620 APC810 APC820 PPC700 PPC725 PPC800	945GME GM45	SP2c	Multilingual	≤2.1 GB	128 MB

4.4 Installation

B&R preinstalls the required Windows XP Professional version on the desired storage device (e.g. CompactFlash card, etc.). All of the drivers required for operation (graphics, network, etc.) are also installed in this process.

4.5 Drivers

Current drivers for all approved operating systems are available in the Downloads section of the B&R website (www.br-automation.com).

Information:

Required drivers can only be downloaded from the B&R website, not from manufacturer websites.

4.6 Supported display resolutions

In accordance with Microsoft requirements, Windows XP Professional requires SVGA resolution (800 x 600) or higher in order to allow unimpeded operation of the Windows user interface (including system dialog boxes and apps, etc.). A lower resolution can be selected for applications.

5 Windows XP Embedded

5.1 General information

Windows XP Embedded is the modular version of the desktop operating system Windows XP Professional. Windows XP Embedded is based on the same binary files as Windows XP Professional and is optimally tailored to the hardware being used. In other words, only the functions and modules required by the respective device are included. Windows XP Embedded is also based on the same reliable code as Windows XP Professional. It provides industry with leading reliability, improvements in security and performance and the latest technology for Web browsing and extensive device support.

5.2 Order data

Model number	Short description	Figure
	Windows XP Embedded	
5SWWXP.0428-ENG	Microsoft OEM Windows XP Embedded Feature Pack 2007, English; for APC820 with 945GME chipset; please order CompactFlash separately (minimum 512 MB).	
	Required accessories	
	CompactFlash cards	
5CFCRD.016G-06	CompactFlash 16 GB B&R (SLC)	
5CFCRD.032G-06	CompactFlash 32 GB B&R (SLC)	
5CFCRD.0512-03	CompactFlash 512 MB Western Digital (SLC)	
5CFCRD.0512-06	CompactFlash 512 MB B&R (SLC)	
5CFCRD.1024-03	CompactFlash 1 GB Western Digital (SLC)	
5CFCRD.1024-06	CompactFlash 1 GB B&R (SLC)	
5CFCRD.2048-03	CompactFlash 2 GB Western Digital (SLC)	
5CFCRD.2048-06	CompactFlash 2 GB B&R (SLC)	
5CFCRD.4096-03	CompactFlash 4 GB Western Digital (SLC)	
5CFCRD.4096-06	CompactFlash 4 GB B&R (SLC)	
5CFCRD.8192-03	CompactFlash 8 GB Western Digital (SLC)	
5CFCRD.8192-06	CompactFlash 8 GB B&R (SLC)	

Table 153: 5SWWXP.0428-ENG - Order data

5.3 Overview

Product ID	5SWWXP.0428-ENG
Operating system	
Target systems	
Industrial PC ¹⁾	APC820
Chipset	945GME
Language	English
Minimum RAM required	128 MB
Minimum hard disk space required ²⁾	250 MB
Minimum disk size	512 MB

Table 154: 5SWWXP.0428-ENG - Technical data

- 1) Can only be ordered together with a suitable B&R device.
 2) Data medium sold separately. The minimum size of the system partition is 488 MB.

5.4 Features with FP2007 (Feature Pack 2007)

The feature list shows the most important device functions in Windows XP Embedded with Feature Pack 2007 (FP2007).

Function	Present
Enhanced Write Filter (EWF)	✓
File Based Write Filter	✓
Administrator accounts	✓
User accounts	Configurable
Explorer shell	✓
Registry filter	✓
Internet Explorer 6.0 + SP2	✓
Internet information service (IIS)	-
Terminal service	✓
Windows Firewall	✓
MSN Explorer	-
Outlook Express	-
Administrative Tools	✓

Table 155: Device functions in Windows XP Embedded with FP2007

Function	Present
Remote Desktop	✓
Remote Assistance	-
.NET Framework	-
ASP.NET	-
Codepages / User locales / Keyboards	✓
Disk Management Service	✓
Windows Installer Service	✓
Class Installer	✓
CoDevice Installer	✓
Media Player	-
DirectX	-
Accessories	✓
Number of fonts	89

Table 155: Device functions in Windows XP Embedded with FP2007

5.5 Installation

B&R preinstalls Windows XP Embedded on a suitable CompactFlash card (minimum 512 MB). The system is then automatically configured when it is switched on for the first time. This procedure takes approximately 30 minutes, with the device being rebooted a number of times.

5.6 Drivers

All drivers required for operation are preinstalled along with the operating system. If an older version of the driver is still being used, the latest version can be downloaded and installed from the B&R website (www.br-automation.com). It is important that Enhanced Write Filter (EWF) is disabled for this.

5.6.1 Touch screen driver

The touch screen driver must be manually installed in order to operate Automation Panel 800 or Automation Panel 900 touch screen devices. The driver is available in the Downloads section of the B&R website (www.br-automation.com). Be sure to check that the "Enhanced Write Filter (EWF)" is enabled.

Information:

Required drivers can only be downloaded from the B&R website, not from manufacturer websites.

6 Windows Embedded Standard 2009

6.1 General information

Windows® Embedded Standard 2009 is the modular version of Windows® XP Professional. It is used if XP applications should be executed with a minimal operating system size. Together with CompactFlash memory, Windows® Embedded Standard 2009 makes it possible to use the Microsoft desktop operating system in harsh environmental conditions. In addition to the familiar features included in Windows® XP Professional, Windows® Embedded Standard 2009 has been improved with regard to dependability by adding a write filter for individual memory partitions. By protecting individual partitions such as the boot partition, the PC system can be started without problems even after an unexpected power failure. B&R offers complete images for industrial PCs, Power Panel and Mobile Panel devices to make the transition to Windows® Embedded Standard 2009 as easy as possible. In addition to Windows® Embedded Standard 2009, the standard Windows® XP Professional operating system is also available in English, German and a multilingual version.

Windows® Embedded Standard 2009 is based on the same binary files as Windows® XP Professional with Service Pack 3 and is optimally tailored to the hardware being used. In other words, only the functions and modules required by the respective device are included. Windows® Embedded Standard 2009 is also based on the same reliable code as Windows® XP Professional with SP3. It provides industry with leading reliability, security and performance improvements as well as the latest technology for web browsing and extensive device support.

6.2 Order data

Model number	Short description	Figure
	Windows Embedded Standard 2009	
5SWWXP.0728-ENG	Microsoft OEM Windows Embedded Standard 2009, English; for APC820 with 945GME chipset; please order CompactFlash separately (minimum 1 GB).	
	Required accessories	
	CompactFlash cards	
5CFCRD.016G-06	CompactFlash 16 GB B&R (SLC)	
5CFCRD.032G-06	CompactFlash 32 GB B&R (SLC)	
5CFCRD.1024-06	CompactFlash 1 GB B&R (SLC)	
5CFCRD.2048-06	CompactFlash 2 GB B&R (SLC)	
5CFCRD.4096-06	CompactFlash 4 GB B&R (SLC)	
5CFCRD.8192-06	CompactFlash 8 GB B&R (SLC)	

Table 156: 5SWWXP.0728-ENG - Order data

6.3 Overview

Product ID	5SWWXP.0728-ENG
Operating system	
Target systems	
Industrial PC ¹⁾	APC820
Chipset	945GME
Language	English
Minimum RAM required	256 MB
Minimum disk size ²⁾	1 GB

Table 157: 5SWWXP.0728-ENG - Technical data

- 1) Can only be ordered together with a suitable B&R device.
- 2) Data medium sold separately.

6.4 Features with WES2009 (Windows Embedded Standard 2009)

The following list of features shows the most important device functions included in Windows Embedded Standard 2009.

Function	Present
Enhanced Write Filter (EWF)	✓
File-Based Write Filter (FBWF)	✓
Page file	Configurable
Administrator accounts	✓
User accounts	Configurable
Explorer shell	✓
Registry filter	✓
Internet Explorer 7.0	✓
Internet information service (IIS)	-

Table 158: Device functions in Windows Embedded Standard 2009

Function	Present
Terminal service	✓
Windows Firewall	✓
MSN Explorer	-
Outlook Express	-
Administrative Tools	✓
Remote Desktop	✓
Remote Assistance	-
.NET Framework	-
ASP.NET	-
Local network bridge	✓
Codepages / User locales / Keyboards	✓
Disk Management Service	✓
Windows Installer Service	✓
Class Installer	✓
CoDevice Installer	✓
Media Player 6.4	✓
DirectX 9.0c	✓
Accessories	✓
Number of fonts	89

Table 158: Device functions in Windows Embedded Standard 2009

6.5 Installation

Windows Embedded Standard 2009 is already preinstalled on a suitable CompactFlash card by B&R (minimum 1 GB). The system is then automatically configured when it is switched on for the first time. This procedure takes approximately 10 minutes, with the device being rebooted a number of times.

6.6 Drivers

All drivers required for operation are preinstalled along with the operating system. If an older version of a driver is still being used, its latest version can be downloaded and installed from the B&R website (www.br-automation.com). It is important that Enhanced Write Filter (EWF) is disabled for this.

6.6.1 Touch screen driver

In order to operate Automation Panel 800 or Automation Panel 900 touch screen devices, the touch screen driver must be installed manually or the touch screen interface updated in the device manager. The driver is available in the Downloads section of the B&R website (www.br-automation.com). It is important that Enhanced Write Filter (EWF) is enabled for this.

Information:

Required drivers can only be downloaded from the B&R website, not from manufacturer websites.

6.7 Supported display resolutions

In accordance with Microsoft requirements, Windows Embedded Standard 2009 requires SVGA resolution (800 x 600) or higher in order to allow unimpeded operation of the Windows user interface (including system dialog boxes, etc.). A lower resolution can be selected for applications.

7 Windows Embedded Standard 7

7.1 General information

The successor to Windows® XP Embedded is Windows® Embedded Standard 7. As with previous versions, this embedded operating system offers full system support for B&R Industrial PCs. In addition to brand new features that are also included in Windows® 7 Professional, Windows® Embedded Standard 7 includes embedded components such as Enhanced Write Filter, File-Based Write Filter, Registry Filter and USB Boot. Windows® Embedded Standard 7 is available in two different versions. The main difference between them has to do with multilingual support. Windows® Embedded Standard 7 is only available in a single language, whereas Windows® Embedded Standard 7 Premium supports the installation of several languages simultaneously.

With Windows® Embedded Standard 7, Microsoft has made substantial improvements in the area of security. The AppLocker program, available in the premium version, can prevent the execution of unknown or potentially undesired applications that are being installed over a network or from drives that are directly connected. A tiered approach allows the differentiation between scripts (.ps1, .bat, .cmd, .vbs and .js), installation files (.msi, .msp) and libraries (.dll, .ocx). AppLocker can also be configured to record undesired activity and display it in the Event Viewer. Windows® Embedded Standard 7 is available as both a 32-bit and 64-bit version²⁾, which ensures that even the most demanding applications have the level of support they need.

7.2 Order data

Model number	Short description	Figure
	Windows Embedded Standard 7	
5SWWI7.0528-ENG	Microsoft OEM Windows Embedded Standard 7 32-bit, English; for APC820 with 945GME chipset; please order CompactFlash separately (minimum 8 GB).	
5SWWI7.0628-ENG	Microsoft OEM Windows Embedded Standard 7 64-bit, English; for APC820 with 945GME chipset; please order CompactFlash separately (minimum 16 GB).	
5SWWI7.0728-MUL	Microsoft OEM Windows Embedded Standard 7 Premium 32-bit, multilanguage; for APC820 with 945GME chipset; please order CompactFlash separately (minimum 8 GB).	
5SWWI7.0828-MUL	Microsoft OEM Windows Embedded Standard 7 Premium 64-bit, multilanguage; for APC820 with 945GME chipset; please order CompactFlash separately (minimum 16 GB).	
5SWWI7.1528-ENG	Microsoft OEM Windows Embedded Standard 7 32-bit, Service Pack 1, English; for APC820 with 945GME chipset; please order CompactFlash separately (minimum 16 GB).	
5SWWI7.1628-ENG	Microsoft OEM Windows Embedded Standard 7 64-bit, Service Pack 1, English; for APC820 with 945GME chipset; please order CompactFlash separately (minimum 16 GB).	
5SWWI7.1728-MUL	Microsoft OEM Windows Embedded Standard 7 Premium 32-bit, Service Pack 1, multilanguage; for APC820 with 945GME chipset; please order CompactFlash separately (minimum 16 GB).	
5SWWI7.1828-MUL	Microsoft OEM Windows Embedded Standard 7 Premium 64-bit, Service Pack 1, multilanguage; for APC820 with 945GME chipset; please order CompactFlash separately (minimum 16 GB).	
	Required accessories	
	CompactFlash cards	
5CFCRD.016G-06	CompactFlash 16 GB B&R (SLC)	
5CFCRD.032G-06	CompactFlash 32 GB B&R (SLC)	
5CFCRD.8192-06	CompactFlash 8 GB B&R (SLC)	
	Optional accessories	
	Windows Embedded Standard 7	
5SWWI7.0900-MUL	Windows Embedded Standard 7 - 32-bit - Language Pack - DVD	
5SWWI7.1000-MUL	Windows Embedded Standard 7 - 64-bit - Language Pack - DVD	
5SWWI7.1900-MUL	Windows Embedded Standard 7 SP1 - 32-bit - Language Pack DVD	
5SWWI7.2000-MUL	Windows Embedded Standard 7 SP1 - 64-bit - Language Pack DVD	

Table 159: 5SWWI7.0528-ENG, 5SWWI7.0628-ENG, 5SWWI7.0728-MUL, 5SWWI7.0828-MUL, 5SWWI7.1528-ENG, 5SWWI7.1628-ENG, 5SWWI7.1728-MUL, 5SWWI7.1828-MUL - Order data

²⁾ 64-bit versions are not supported by all systems.

7.3 Overview

Product ID	5SWWI7.0528-ENG
Operating system	
Target systems	
Industrial PC	APC820
Chipset	945GME
Edition	Embedded
Architectures	32-bit
Language	English
Minimum RAM required	1 GB
Minimum disk size	8 GB

Table 160: 5SWWI7.0528-ENG - Technical data

7.4 Features with WES7 (Windows Embedded Standard 7)

The feature list displays the essential device functions and differences in Windows Embedded Standard 7 and Windows Embedded Standard 7 Premium.

Function	Windows Embedded Standard 7	Windows Embedded Standard 7 Premium
Enhanced Write Filter (EWF)	✓	✓
File-Based Write Filter (FBWF)	✓	✓
Administrator accounts	✓	✓
User accounts	Configurable	Configurable
Windows Explorer shell	✓	✓
Registry filter	✓	✓
Internet Explorer 8.0	✓	✓
Internet Information Service (IIS) 7.0	✓	✓
Anti-malware (Windows Defender)	-	✓
Add-ons (Snipping Tool, Sticky Notes)	-	✓
Windows Firewall	✓	✓
.NET Framework 3.5	✓	✓
Remote Desktop Protocol 7.0	✓	✓
File Compression Utility	✓	✓
Windows Installer Service	✓	✓
Windows XP mode	-	-
Media Player 12	✓	✓
DirectX	✓	✓
Multilingual user interface packs in the same image	-	✓
International components and language services	✓	✓
Language pack setup	✓	✓
Windows update	Configurable	Configurable
Windows PowerShell 2.0	✓	✓
BitLocker	-	✓
AppLocker	-	✓
Tablet PC support	-	✓
Multitouch Support	-	✓
Boot from USB flash drive	✓	✓
Accessories	✓	✓
Page file	Configurable	Configurable
Number of fonts	134	134

Table 161: Device functions in Windows Embedded Standard 7

7.5 Installation

Windows Embedded Standard 7 wird schon im Hause B&R auf einer geeigneten CompactFlash-Karte (mind. 8 GByte bzw. 16 GByte) vorinstalliert. The system is then automatically configured when it is switched on for the first time. Dieser Vorgang nimmt ca. 30 Minuten in Anspruch und das Gerät wird dabei einige Male automatisch rebootet.

Information:

If Enhanced Write Filter (EWF) should be used, all mass storage devices should be disconnected from the system during installation or SYSPREP (except for the boot drive). It is also possible to disable additional mass storage devices in BIOS.

7.6 Drivers

All drivers required for operation are preinstalled along with the operating system. If an older version of a driver is still being used, its latest version can be downloaded and installed from the B&R website (www.br-automation.com). It is important that Enhanced Write Filter (EWF) is disabled for this.

7.6.1 Touch screen driver

A touch screen driver will be installed automatically if a touch controller is detected during the Windows Embedded Standard 7 installation. If a touch controller is not detected during Windows Embedded Standard 7 installation or a B&R Automation Panel is connected at a later time, then the touch screen driver needs to be installed manually or the additional touch screen interface must be selected in the touch screen settings in the Windows Control Panel. The driver is available in the Downloads section of the B&R website (www.br-automation.com). It is important that both Enhanced Write Filter (EWF) and File Based Write Filter (FBWF) are disabled for this.

Information:

Required drivers can only be downloaded from the B&R website, not from manufacturer websites.

7.7 Supported display resolutions

In accordance with Microsoft requirements, Windows Embedded Standard 7 requires XGA resolution (1024 x 768) or higher in order to allow unimpeded operation of the Windows user interface (including system dialog boxes and apps, etc.). A lower resolution can be selected for applications.

8 Automation Runtime

8.1 General information

An integral component of Automation Studio is the Automation Runtime real-time operating system. This real-time operating system is the software kernel that allows applications to run on a target system.

- Guaranteed highest possible performance for the hardware being used
- Runs on all B&R target systems
- Makes the application hardware-independent
- Easy portability of applications between B&R target systems
- Deterministic behavior guaranteed by cyclic system
- Configurable jitter tolerance in all task classes
- Supports all major programming languages such as IEC 61131-3 and C
- Extensive function library conforming to IEC 61131-3 as well as the expanded B&R Automation library
- Integrated into Automation NET. Access to all networks and bus systems via function calls or the Automation Studio™ configuration

B&R Automation Runtime is fully embedded in the corresponding target system (the hardware where Automation Runtime is installed). It allows application programs to access I/O systems (e.g. via the fieldbus) and other devices (interfaces, networks, etc.).

8.2 Order data

Model number	Short description	Figure
	Automation Runtime	
0TG1000.01	Technology Guard	
1TG4600.10-5	Automation Runtime Windows, TG license	
1TG4601.06-5	Automation Runtime Embedded, TG license	

Table 162: 0TG1000.01, 1TG4600.10-5, 1TG4601.06-5 - Order data

8.3 Automation Runtime Windows (ARwin)

System requirements

In order to run Automation Runtime Windows on an Automation PC 820, the following software versions (or higher) are required:

- ARwin upgrade AR 2.95
- Automation Studio V3.0.00
- Technology Guard

8.4 Automation Runtime Embedded (ARemb)

System requirements

In order to run Automation Runtime Embedded on an Automation PC 820, the following software versions (or higher) are required:

- ARemb upgrade AR 4.00
- Automation Studio V3.0.90
- Visual Components Runtime (VC) V3.35.4
- Technology Guard

8.5 Technology Guarding

Technology Guarding is a licensing approach used to safeguard individual software components. Licenses are stored on a "Technology Guard" (also referred to simply as a dongle), which is connected to an available USB interface on the target system.

The B&R software components Automation Runtime Embedded (ARemb), Automation Runtime Windows (ARwin) and Automation Runtime Embedded Terminal require a license, so a Technology Guard must always be used.

Information:

Licensing with the Technology Guarding wizard is available in Automation Studio 4.1 and Automation Runtime 4.08 and higher. Earlier versions of Automation Runtime do not require a Technology Guard.

Additional information about Technology Guarding can be found in the Automation Studio help system.

9 B&R Automation Device Interface (ADI) - Control Center

The ADI (Automation Device Interface) enables access to specific functions on B&R devices. Settings for devices can be read and configured using the B&R Control Center applet in the Control Panel.

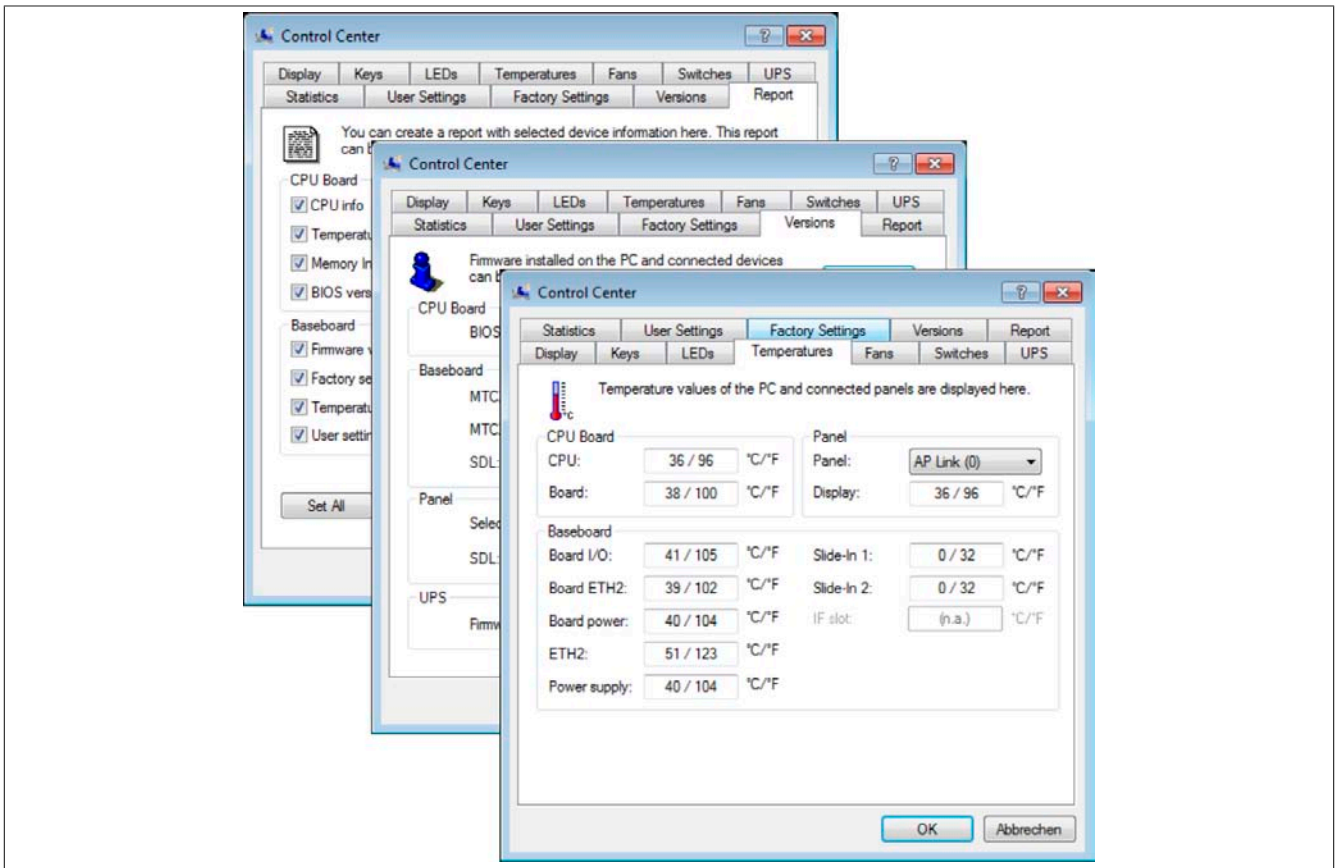

Figure 75: ADI Control Center screenshots - Examples

Information:

The temperature and voltage values (e.g. CPU temperature, core voltage, battery voltage) shown in the corresponding ADI window represent uncalibrated values for informational purposes. They cannot be used to draw any conclusions about hardware alarms or error conditions. The hardware components used have automatic diagnostic functions that can be applied in the event of error.

9.1 Functions

Information:

The functions provided by the Automation Device Interface (ADI) - Control Center vary according to the device series.

- Changing display-specific parameters
- Reading device-specific keys
- Updating the key configuration
- Enabling device-specific LEDs on a membrane keypad or keys
- Reading and calibrating control devices (e.g. key switches, handwheels, joysticks, potentiometers)
- Reading temperatures, fan speeds, statistical data and switch settings
- Reading operating hours (power-on hours)
- Reading user and factory settings
- Reading software versions
- Updating and backing up BIOS and firmware
- Creating reports about the current system (support assistance)
- Setting the SDL equalizer value when adjusting SDL cables
- Changing the user serial ID

Supports the following systems:

- Automation PC 510
- Automation PC 511
- Automation PC 620
- Automation PC 810
- Automation PC 820
- Automation PC 910
- Automation PC 2100
- Panel PC 300
- Panel PC 700
- Panel PC 725
- Panel PC 800
- Panel PC 900
- Panel PC 2100
- Power Panel 100/200
- Power Panel 300/400
- Power Panel 500
- Mobile Panel 40/50
- Mobile Panel 100/200
- Connected Automation Panel 800
- Connected Automation Panel 900

9.2 Installation

A detailed description of the Control Center can be found in the integrated help system. The B&R Automation Device Interface (ADI) driver (also includes the Control Center) is available at no charge in the Downloads section of the B&R website (www.br-automation.com).

1. Download and unzip the .zip archive.
2. Close all applications.
3. Run the Setup.exe file (e.g. double-click on it in Explorer).

Information:

The ADI driver is already included in B&R images of embedded operating systems.

If a more current ADI driver version exists (see the Downloads section of the B&R website), it can be installed later. It is important that Enhanced Write Filter (EWF) is disabled for this.

10 B&R Automation Device Interface (ADI) Development Kit

This software can be used to access B&R Automation Device Interface (ADI) functions directly from Windows applications created in one of the following development environments:

- Microsoft Visual C++ 6.0
- Microsoft Visual Basic 6.0
- Microsoft Embedded Visual C++ 4.0
- Microsoft Visual Studio 2008 (or newer)

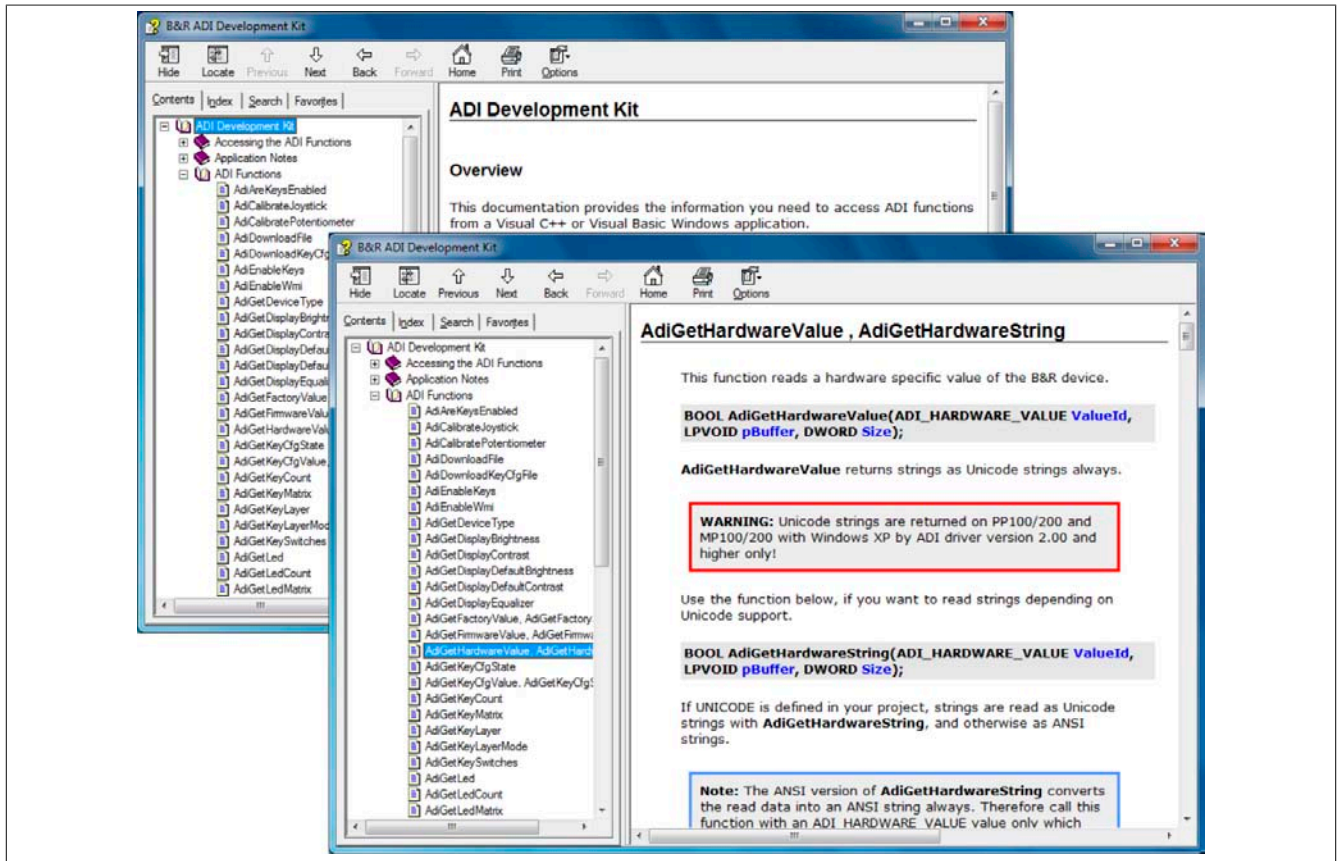

Figure 76: ADI Development Kit Screenshots (Version 3.70)

Features:

- One Microsoft Visual Basic module with ADI function declarations
- Header files and import libraries for Microsoft Visual C++
- Help files for Visual Basic and Visual C++
- Sample projects for Visual Basic and Visual C++
- ADI DLL (for application testing if no ADI driver is installed)

The following systems are supported (version 3.70 and higher):

- Automation PC 510
- Automation PC 511
- Automation PC 620
- Automation PC 810
- Automation PC 820
- Automation PC 910
- Automation PC 2100
- Panel PC 300
- Panel PC 700
- Panel PC 800
- Panel PC 900
- Panel PC 2100

- Power Panel 100/200
- Power Panel 300/400
- Power Panel 500
- Mobile Panel 40/50
- Mobile Panel 100/200

The ADI driver installed on the stated product series must be suitable for that device. The ADI driver is already included in B&R images of embedded operating systems.

A detailed description of how to use ADI functions can be found in the help system.

The B&R Automation Device Interface (ADI) development kit is available at no cost in the Downloads section of the B&R website (www.br-automation.com).

11 B&R Automation Device Interface (ADI) .NET SDK

This software can be used to access B&R Automation Device Interface (ADI) functions directly from .NET applications created using Microsoft Visual Studio 2005 or later.

Supported programming languages:

- Visual Basic
- Visual C++
- Visual C#

System requirements

- Development system: PC with Windows XP or Windows 7 and
 - Microsoft Visual Studio 2005 (or newer)
 - Microsoft .NET Framework 2.0 and/or Microsoft .NET Compact Framework 2.0 (or newer)

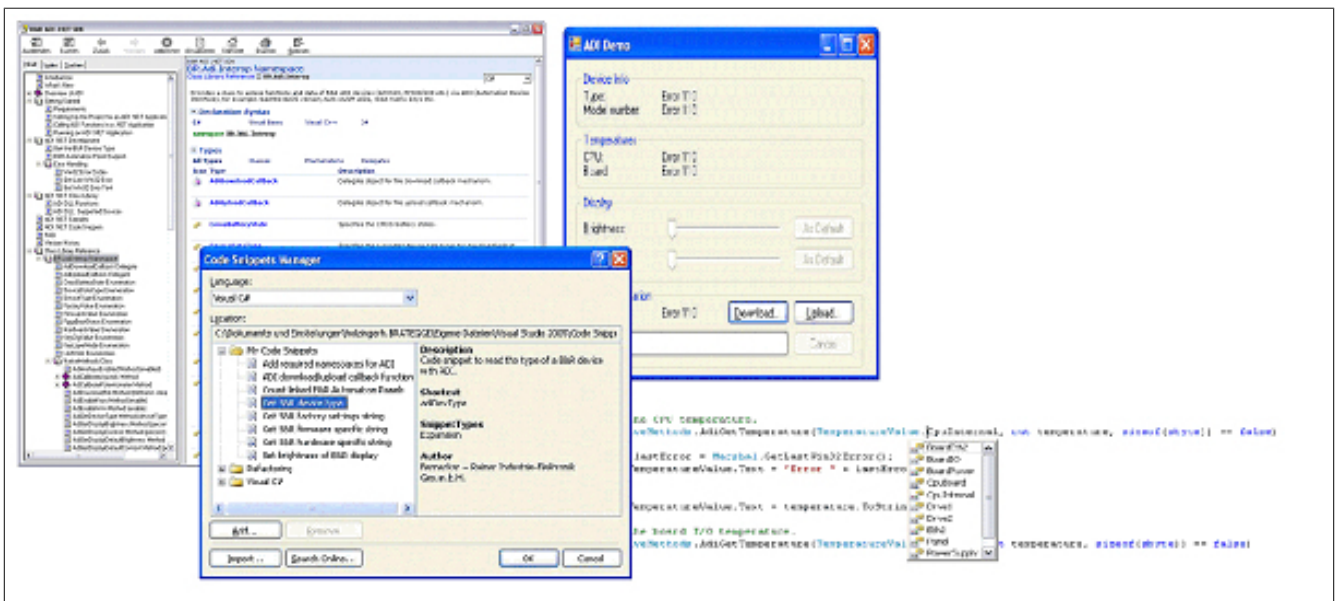

Figure 77: ADI .NET SDK screenshots (version 2.10)

Features (version 2.10 and higher)

- ADI .NET class library
- Help files in HTML Help 1.0 format (.chm), MS Help 2.0 format (.HxS) and MS Help Viewer format (.MSHC) (help documentation is in English only)
- Sample projects and code snippets for Visual Basic, Visual C++ and Visual C#
- ADI DLL (for application testing if no ADI driver is installed)

The following systems are supported (version 2.10 and higher):

- Automation PC 510
- Automation PC 511
- Automation PC 620
- Automation PC 810
- Automation PC 820
- Automation PC 910
- Automation PC 2100
- Panel PC 300
- Panel PC 700
- Panel PC 800
- Panel PC 900
- Panel PC 2100
- Power Panel 100/200
- Power Panel 300/400

- Power Panel 500
- Mobile Panel 40/50
- Mobile Panel 100/200

The ADI driver installed on the stated product series must be suitable for that device. The ADI driver is already included in B&R images of embedded operating systems.

A detailed description of how to use ADI functions can be found in the help system.

The ADI .NET SDK is available in the Downloads section of the B&R website (www.br-automation.com).

12 B&R Key Editor

On display devices, it is often necessary to adapt the function keys and LEDs directly to the application software being used. The B&R Key Editor makes it quick and easy to implement a unique configuration for the application.

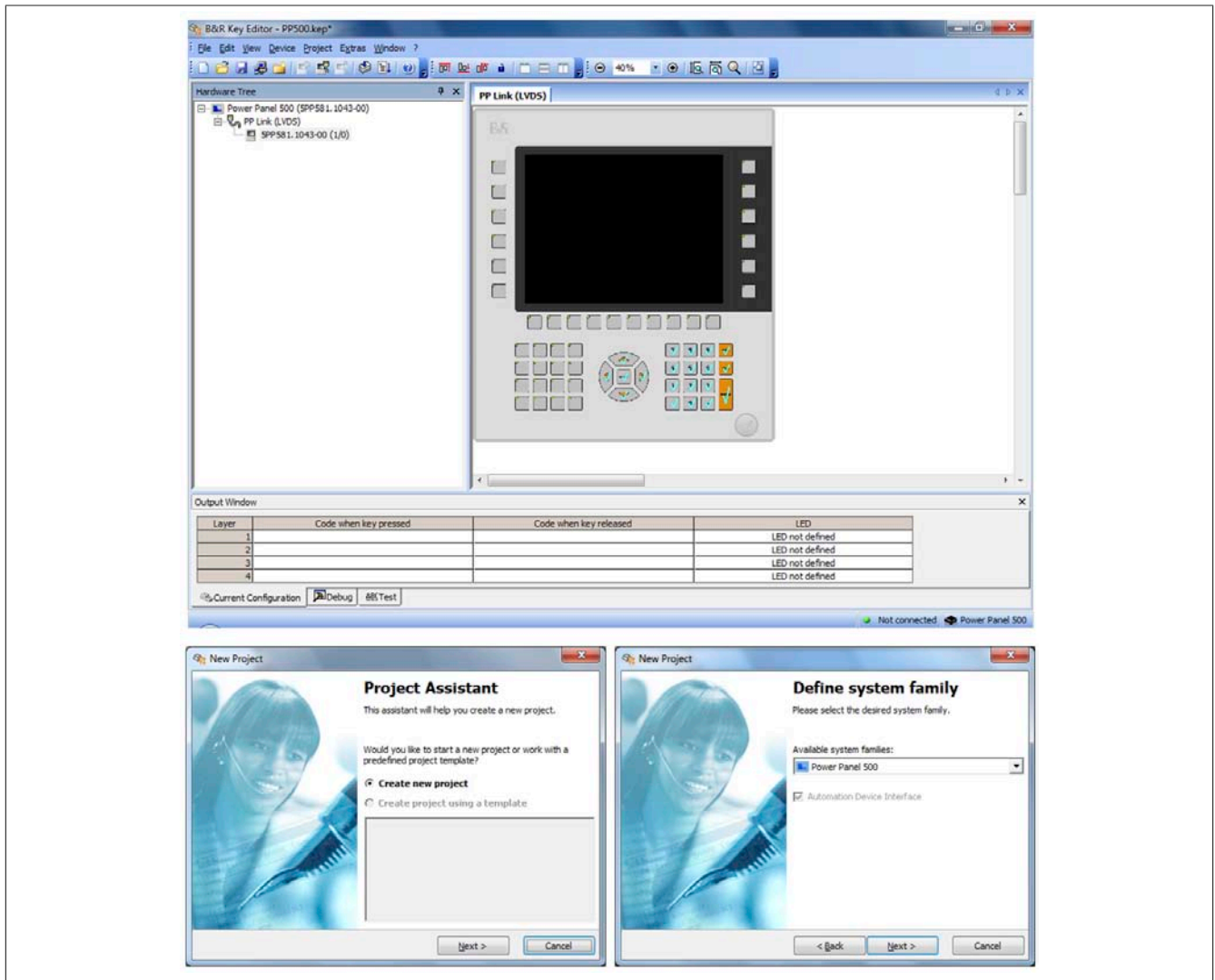

Figure 78: B&R Key Editor screenshots (version 3.50)

Features:

- Configuration of normal keyboard keys (A, B, C, etc.)
- Keyboard shortcuts (CTRL+C, SHIFT+DEL, etc.) using only one key
- Special key functions (change brightness, etc.)
- Assignment of functions to LEDs (HDD access, power, etc.)
- 4 assignments possible per key (using layers)
- Configuration of the panel locking time when multiple Automation Panel 900 devices are connected to Automation PC and Panel PC devices.

The following systems are supported (version 3.50):

- Automation PC 510
- Automation PC 511
- Automation PC 620
- Automation PC 810
- Automation PC 820
- Automation PC 910
- Automation PC 2100
- Automation Panel 800
- Automation Panel 830

- Automation Panel 900
- Automation Panel 9x3 / 9xD
- IPC2000, IPC2001, IPC2002
- IPC5000, IPC5600
- IPC5000C, IPC5600C
- Mobile Panel 40/50
- Mobile Panel 100/200
- Panel PC 300
- Panel PC 700
- Panel PC 800
- Panel PC 900
- Panel PC 2100
- Power Panel 100/200
- Power Panel 300/400
- Power Panel 500

A detailed guide for configuring keys and LEDs can be found in the B&R Key Editor's help system. The B&R Key Editor is available at no cost in the Downloads section of the B&R website (www.br-automation.com). It can also be found on the B&R HMI Drivers & Utilities DVD (model number 5SWHMI.0000-00).

Chapter 5 • Standards and certifications

1 Standards and guidelines

1.1 CE mark



Product complies with all applicable directives and their harmonized EN standards.

1.2 EMC directive

These devices meet the requirements of EC directive "2004/108/EC Electromagnetic compatibility" and are designed for the following areas:

EN 61131-2:2007	Programmable logic controllers - Part 2: Equipment requirements and tests
EN 61000-6 -2:2005	Electromagnetic compatibility (EMC) - Part 6-2: Generic standards - Immunity for industrial environments
EN 61000-6 -4:2007	Electromagnetic compatibility (EMC) - Part 6-4: Generic standards - Emission standard for industrial environments

1.3 Low voltage directive

These devices satisfy the requirements of EC directive "2006/95/EC Low voltage directive" and are designed for the following areas:

EN 61131-2:2007	Programmable logic controllers - Part 2: Equipment requirements and tests
EN 60204-1:2006 + A1:2009	Safety of machinery - Electrical equipment of machines - Part 1: General requirements

2 Certifications

Danger!

A complete system can only receive certification if ALL of the individual components it includes have the applicable certifications. If an individual component is being used that DOES NOT have an applicable certification, then the complete system WILL NOT receive certification.

B&R products and services comply with applicable standards. This includes international standards from organizations such as ISO, IEC and CENELEC, as well as national standards from organizations such as UL, CSA, FCC, VDE, ÖVE, etc. We are committed to ensuring the reliability of our products in an industrial environment.

Unless otherwise specified, the following certifications apply:

2.1 UL certification



Products with this mark have been tested by Underwriters Laboratories and are listed as "Industrial Control Equipment". This mark is valid for the USA and Canada and simplifies the certification of your machines and systems in these areas.

Underwriters Laboratories (UL) in accordance with the UL508 standard - 17th Edition
Canadian (CSA) standard in accordance with C22.2 No. 142-M1987

2.2 GOST-R



Products with this mark have been certified by an accredited testing laboratory and have been approved for import to the Russian Federation (based on CE compliance).

Chapter 6 • Accessories

The following accessories have successfully completed functional testing at B&R and are approved for use with this device. Nevertheless, it is important to observe any limitations that may apply to the complete system when operated with other individual components. When operating the complete system, the specifications for the individual components must be observed.

All components listed in this manual have been subjected to extensive system and compatibility testing and are approved for use. B&R can make no guarantee regarding the functionality of non-approved accessories.

1 Male CAN connector (4-pin)

1.1 General information

The single-row 4-pin terminal block TB704 is used as the supply voltage terminal block and the connection terminal for fieldbuses.

1.2 Order data

Model number	Short description	Figure
	Terminal blocks	
0TB704.9	Accessory terminal block, 4-pin, screw clamps 2.5 mm ²	
0TB704.91	Accessory terminal block, 4-pin, cage clamps 2.5 mm ²	

Table 163: 0TB704.9, 0TB704.91 - Order data

1.3 Technical data

Information:

The following characteristics, features and limit values only apply to this accessory and can deviate from those specified for the complete system. The data specifications for the complete system take precedence over those of individual components.

Product ID	0TB704.9	0TB704.91
Terminal block		
Note	Nominal values according to UL	
Number of pins	4	
Type of terminal clamp	Screw clamps	Cage clamps ¹⁾
Cable type	Only copper wires (no aluminum wires!)	
Distance between contacts	5.08 mm	
Connection cross section		
AWG wire	26 to 12 AWG	
Wire end sleeves with plastic covering	0.20 to 1.50 mm ²	
Solid wires	0.20 to 2.50 mm ²	
Fine strand wires	0.20 to 1.50 mm ²	0.20 to 2.50 mm ²
With wire end sleeves	0.20 to 1.50 mm ²	
Electrical characteristics		
Nominal voltage	300 V	
Nominal current ²⁾	10 A / contact	
Contact resistance	≤5 mΩ	

Table 164: 0TB704.9, 0TB704.91 - Technical data

- 1) Cage clamp terminal blocks cannot be used side-by-side.
- 2) The limit data for each I/O module must be taken into consideration.

2 Replacement CMOS batteries

2.1 0AC201.91 / 4A0006.00-000

2.1.1 General information

This lithium battery is needed to back BIOS CMOS data and the real-time clock (RTC).

The battery is subject to wear and must be replaced when the battery power is insufficient ("Bad" status).

2.1.2 Order data

Model number	Short description	Figure
0AC201.91	Batteries Lithium batteries 4 pcs., 3 V / 950 mAh button cell We hereby state that the lithium cells contained in this shipment qualify as "partly regulated". Handle with care. If the package is damaged, inspect the cells, repack intact cells and protect the cells against short circuit. For emergency information, call RENATA SA at +41 61 319 28 27.	
4A0006.00-000	Lithium battery, 3 V / 950 mAh, button cell	

Table 165: 0AC201.91, 4A0006.00-000 - Order data

2.1.3 Technical data

Warning!

The battery is only permitted to be replaced by a Renata CR2477N battery. The use of another battery may present a risk of fire or explosion.

The battery may explode if handled improperly. Do not recharge, disassemble or dispose of in fire.

Information:

The following characteristics, features and limit values only apply to this accessory and can deviate from those specified for the complete system. The data specifications for the complete system take precedence over those of individual components.

Product ID	0AC201.91	4A0006.00-000
General information		
Storage time	Max. 3 years at 30°C	
Certification		
CE	Yes	
cULus	Yes	
Electrical characteristics		
Capacity	950 mAh	
Self-discharging	<1% per year (at 23°C)	
Voltage range	3 V	
Environmental conditions		
Temperature		
Storage	-20 to 60°C	
Relative humidity		
Operation	0 to 95%	
Storage	0 to 95%	
Transport	0 to 95%	

Table 166: 0AC201.91, 4A0006.00-000 - Technical data

3 DVI/Monitor adapter

3.1 5AC900.1000-00

3.2 General information

This adapter enables a standard monitor to be connected to the DVI-I interface.

3.3 Order data

Model number	Short description	Figure
	Miscellaneous	
5AC900.1000-00	DVI (male connector) to CRT (female connector) adapter. For connecting a standard monitor to a DVI-I interface.	

Table 167: 5AC900.1000-00 - Order data

4 CompactFlash cards

4.1 General information

CompactFlash cards are storage media that are easy to replace. Due to their robustness against environmental influences (e.g. temperature, shock, vibration, etc.), CompactFlash cards are ideal for use as storage media in industrial environments.

4.2 General information

In order to be suited for use in industrial automation, CompactFlash cards must be highly reliable. The following items are very important to achieving the necessary level of reliability:

- The flash technology used
- An efficient algorithm for maximizing service life
- Good mechanisms for detecting and fixing errors in the flash memory

4.2.1 Flash technology

Currently, CompactFlash cards are available with MLC (multi-level cell) and SLC (single-level cell) flash blocks. SLC flash memory has a service life 10 times longer than MLC, which is why only CompactFlash cards with SLC flash blocks are suited for industrial applications.

4.2.2 Wear leveling

Wear leveling is an algorithm that can be used to maximize the service life of a CompactFlash card. There are three different algorithms:

- No wear leveling
- Dynamic wear leveling
- Static wear leveling

The basic idea behind wear leveling is to distribute data over a broad area of blocks or cells on the disk so that the same areas don't have to be cleared and reprogrammed over and over again.

4.2.2.1 No wear leveling

The earliest CompactFlash cards didn't have an algorithm for maximizing service life. The service life of a CompactFlash card was determined only by the guaranteed lifespan of the flash blocks.

4.2.2.2 Dynamic wear leveling

Dynamic wear leveling makes it possible to utilize unused flash blocks when writing to a file.

If the disk is 80% full with files, then only 20% can be used for wear leveling.

The service life of the CompactFlash card is therefore dependent on the amount of unused flash blocks.

4.2.2.3 Static wear leveling

Static wear leveling monitors which data is rarely modified. From time to time, the controller then moves this data to blocks that have already been used frequently in order to prevent further wear on those cells.

4.2.3 ECC error correction

Bit errors can be caused by inactivity or when a certain cell is being operated. Error correction coding (ECC) implemented via hardware or software can detect and correct many errors of this type.

4.2.4 S.M.A.R.T. support

Self-Monitoring, Analysis and Reporting Technology (S.M.A.R.T.) is an industry standard for mass storage devices that has been introduced to monitor important parameters and quickly detect imminent failures. Critical performance and calibration data is monitored and stored in order to help predict the probability of errors.

4.2.5 Maximum reliability

CompactFlash cards used by B&R use SLC flash blocks and static wear leveling together with a powerful ECC algorithm to provide maximum reliability.

4.3 5CFCRD.xxxx-06

4.3.1 General information

Information:

B&R CompactFlash cards 5CFCRD.xxxx-06 and CompactFlash cards from a different manufacturer cannot be used in the same system at the same time. Due to differences in technology (older vs. newer technologies), problems can occur during system startup that are caused by different boot times.

see "Known problems/issues" on page 186

Information:

5CFCRD.xxxx-06 CompactFlash cards are supported on B&R devices with WinCE version ≥ 6.0 .

4.3.2 Order data

Model number	Short description	Figure
	CompactFlash cards	
5CFCRD.0512-06	CompactFlash 512 MB B&R (SLC) \geq Rev. F0	
5CFCRD.1024-06	CompactFlash 1 GB B&R (SLC) \geq Rev. F0	
5CFCRD.2048-06	CompactFlash 2 GB B&R (SLC) \geq Rev. F0	
5CFCRD.4096-06	CompactFlash 4 GB B&R (SLC) \geq Rev. F0	
5CFCRD.8192-06	CompactFlash 8 GB B&R (SLC) \geq Rev. F0	
5CFCRD.016G-06	CompactFlash 16 GB B&R (SLC) \geq Rev. E0	
5CFCRD.032G-06	CompactFlash 32 GB B&R (SLC) \geq Rev. D0	

Table 168: 5CFCRD.0512-06, 5CFCRD.1024-06, 5CFCRD.2048-06, 5CFCRD.4096-06, 5CFCRD.8192-06, 5CFCRD.016G-06, 5CFCRD.032G-06 - Order data

Model number	Short description	Figure
	CompactFlash cards	
5CFCRD.0512-06	CompactFlash 512 MB B&R (SLC) \leq Rev. E0	
5CFCRD.1024-06	CompactFlash 1 GB B&R (SLC) \leq Rev. E0	
5CFCRD.2048-06	CompactFlash 2 GB B&R (SLC) \leq Rev. E0	
5CFCRD.4096-06	CompactFlash 4 GB B&R (SLC) \leq Rev. E0	
5CFCRD.8192-06	CompactFlash 8 GB B&R (SLC) \leq Rev. E0	
5CFCRD.016G-06	CompactFlash 16 GB B&R (SLC) \leq Rev. D0	
5CFCRD.032G-06	CompactFlash 32 GB B&R (SLC) \leq Rev. C0	

Table 169: 5CFCRD.0512-06, 5CFCRD.1024-06, 5CFCRD.2048-06, 5CFCRD.4096-06, 5CFCRD.8192-06, 5CFCRD.016G-06, 5CFCRD.032G-06 - Order data

4.3.3 Technical data

Caution!

A sudden loss of power may result in data loss! In very rare cases, the mass storage device may also become damaged.

To prevent damage and loss of data, the use of a UPS device is recommended.

Information:

The following characteristics, features and limit values only apply to this accessory and can deviate from those specified for the complete system. The data specifications for the complete system take precedence over those of individual components.

Product ID	5CFCRD. 0512-06 ≥ Rev. F0	5CFCRD. 1024-06 ≥ Rev. F0	5CFCRD. 2048-06 ≥ Rev. F0	5CFCRD. 4096-06 ≥ Rev. F0	5CFCRD. 8192-06 ≥ Rev. F0	5CFCRD. 016G-06 ≥ Rev. E0	5CFCRD. 032G-06 ≥ Rev. D0
General information							
Capacity	512 MB	1 GB	2 GB	4 GB	8 GB	16 GB	32 GB
Data retention	10 years						
Data reliability	<1 unrecoverable error in 10 ¹⁴ bit read accesses						
Lifetime monitoring	Yes						
MTBF	>3,000,000 hours (at 25°C)						
Maintenance	None						
Supported operating modes	PIO Mode 0-6, Multiword DMA Mode 0-4, Ultra DMA Mode 0-4						
Continuous reading							
Typical	50 MB/s	50 MB/s	59 MB/s	59 MB/s	59 MB/s	59 MB/s	58 MB/s
Maximum	53 MB/s	53 MB/s	65 MB/s	65 MB/s	65 MB/s	65 MB/s	65 MB/s
Continuous writing							
Typical	25 MB/s	25 MB/s	31 MB/s	31 MB/s	31 MB/s	31 MB/s	31 MB/s
Maximum	27 MB/s	27 MB/s	35 MB/s	35 MB/s	35 MB/s	35 MB/s	35 MB/s
Certification							
CE	Yes						
cULus	Yes						
cULus HazLoc Class 1 Division 2	-	-	-	-	-	Yes ¹⁾	-
ATEX Zone 22	-	-	-	-	-	Yes ¹⁾	-
GOST-R	Yes						
GL	Yes ¹⁾						
Endurance							
SLC flash	Yes						
Guaranteed data volume							
Guaranteed ²⁾	50 TB	100 TB	200 TB	400 TB	800 TB	1600 TB	3200 TB
Over 5 years, equates to ²⁾	27.40 GB/day	54.79 GB/day	109.9 GB/day	219.8 GB/day	438.6 GB/day	876.72 GB/day	1753.44 GB/day
Clear/Write cycles							
Guaranteed	100,000						
Wear leveling	Static						
Error correction coding (ECC)	Yes						
S.M.A.R.T. support	Yes						
Support							
Hardware	PP300/400, PP500, PPC300, PPC700, PPC725, PPC800, APC620, APC810, APC820						
Operating systems							
Windows 7 32-bit	No	No	No	No	No	Yes	Yes
Windows 7 64-bit	No	No	No	No	No	No	Yes
Windows Embedded Standard 7 32-bit	No	No	No	No	Yes	Yes	Yes
Windows Embedded Standard 7 64-bit	No	No	No	No	No	Yes	Yes
Windows XP Professional	No	No	No	Yes	Yes	Yes	Yes
Windows XP Embedded	Yes						
Windows Embedded Standard 2009	No	Yes	Yes	Yes	Yes	Yes	Yes
Windows CE 6.0	Yes	Yes	Yes	Yes	Yes	Yes ³⁾	Yes ³⁾
Windows CE 5.0	No						
Software							
PVI Transfer	≥ V3.2.3.8 (part of PVI Development Setup ≥ V2.06.00.3011)	≥ V3.2.3.8 (part of PVI Development Setup ≥ V2.06.00.3011)	≥ V3.2.3.8 (part of PVI Development Setup ≥ V2.06.00.3011)	≥ V3.2.3.8 (part of PVI Development Setup ≥ V2.06.00.3011)	≥ V3.2.3.8 (part of PVI Development Setup ≥ V2.06.00.3011)	≥ V3.6.8.40 (part of PVI Development Setup ≥ V3.0.0.3020)	≥ V4.0.0.8 (part of PVI Development Setup ≥ V3.0.2.3014)
B&R Embedded OS Installer	≥V3.10	≥V3.10	≥V3.10	≥V3.10	≥V3.10	≥V3.20	≥V3.21

Table 170: 5CFCRD.0512-06, 5CFCRD.1024-06, 5CFCRD.2048-06, 5CFCRD.4096-06, 5CFCRD.8192-06, 5CFCRD.016G-06, 5CFCRD.032G-06 - Technical data

Product ID	5CFCRD. 0512-06 ≥ Rev. F0	5CFCRD. 1024-06 ≥ Rev. F0	5CFCRD. 2048-06 ≥ Rev. F0	5CFCRD. 4096-06 ≥ Rev. F0	5CFCRD. 8192-06 ≥ Rev. F0	5CFCRD. 016G-06 ≥ Rev. E0	5CFCRD. 032G-06 ≥ Rev. D0
Environmental conditions							
Temperature							
Operation	0 to 70°C						
Storage	-50 to 100°C						
Transport	-50 to 100°C						
Relative humidity							
Operation	Max. 85% at 85°C						
Storage	Max. 85% at 85°C						
Transport	Max. 85% at 85°C						
Vibration							
Operation	20 g peak, 20 to 2000 Hz, 4 in each direction (JEDEC JESD22, method B103) 5.35 g RMS, 15 min per level (IEC 68-2-6)						
Storage	20 g peak, 20 to 2000 Hz, 4 in each direction (JEDEC JESD22, method B103) 5.35 g RMS, 15 min per level (IEC 68-2-6)						
Transport	20 g peak, 20 to 2000 Hz, 4 in each direction (JEDEC JESD22, method B103) 5.35 g RMS, 15 min per level (IEC 68-2-6)						
Shock							
Operation	1.5 kg peak, 0.5 ms 5 times (JEDEC JESD22, method B110) 30 g, 11 ms 1 times (IEC 68-2-27)						
Storage	1.5 kg peak, 0.5 ms 5 times (JEDEC JESD22, method B110) 30 g, 11 ms 1 times (IEC 68-2-27)						
Transport	1.5 kg peak, 0.5 ms 5 times (JEDEC JESD22, method B110) 30 g, 11 ms 1 times (IEC 68-2-27)						
Altitude							
Operation	Max. 4572 m						
Mechanical characteristics							
Dimensions							
Width	42.8 ±0.10 mm						
Length	36.4 ±0.15 mm						
Height	3.3 ±0.10 mm						
Weight	10 g						

Table 170: 5CFCRD.0512-06, 5CFCRD.1024-06, 5CFCRD.2048-06, 5CFCRD.4096-06, 5CFCRD.8192-06, 5CFCRD.016G-06, 5CFCRD.032G-06 - Technical data

- 1) Yes, although applies only if all components installed within the complete system have this certification
- 2) Endurance of B&R CFs (with linear written block size ≥128 kB).
- 3) Not supported by the B&R Embedded OS Installer.

Caution!

A sudden loss of power may result in data loss! In very rare cases, the mass storage device may also become damaged.

To prevent damage and loss of data, the use of a UPS device is recommended.

Information:

The following characteristics, features and limit values only apply to this accessory and can deviate from those specified for the complete system. The data specifications for the complete system take precedence over those of individual components.

Product ID	5CFCRD. 0512-06 ≤ Rev. E0	5CFCRD. 1024-06 ≤ Rev. E0	5CFCRD. 2048-06 ≤ Rev. E0	5CFCRD. 4096-06 ≤ Rev. E0	5CFCRD. 8192-06 ≤ Rev. E0	5CFCRD. 016G-06 ≤ Rev. D0	5CFCRD. 032G-06 ≤ Rev. C0
General information							
Capacity	512 MB	1 GB	2 GB	4 GB	8 GB	16 GB	32 GB
Data retention	10 years						
Data reliability	<1 unrecoverable error in 10 ¹⁴ bit read accesses						
Lifetime monitoring	Yes						
MTBF	>3,000,000 hours (at 25°C)						
Maintenance	None						
Supported operating modes	PIO Mode 0-6, Multiword DMA Mode 0-4, Ultra DMA Mode 0-4						
Continuous reading							
Typical	33 MB/s	33 MB/s	33 MB/s	33 MB/s	33 MB/s	36 MB/s	36 MB/s
Maximum	35 MB/s	35 MB/s	35 MB/s	34 MB/s	34 MB/s	37 MB/s	37 MB/s
Continuous writing							
Typical	15 MB/s	15 MB/s	15 MB/s	14 MB/s	14 MB/s	28 MB/s	28 MB/s
Maximum	18 MB/s	18 MB/s	18 MB/s	17 MB/s	17 MB/s	30 MB/s	30 MB/s

Table 171: 5CFCRD.0512-06, 5CFCRD.1024-06, 5CFCRD.2048-06, 5CFCRD.4096-06, 5CFCRD.8192-06, 5CFCRD.016G-06, 5CFCRD.032G-06 - Technical data

Accessories • CompactFlash cards

Product ID	5CFCRD.0512-06 ≤ Rev. E0	5CFCRD.1024-06 ≤ Rev. E0	5CFCRD.2048-06 ≤ Rev. E0	5CFCRD.4096-06 ≤ Rev. E0	5CFCRD.8192-06 ≤ Rev. E0	5CFCRD.016G-06 ≤ Rev. D0	5CFCRD.032G-06 ≤ Rev. C0	
Certification								
CE					Yes			
cULus					Yes			
cULus HazLoc Class 1 Division 2	-	-	-	-	-	Yes ¹⁾	-	
ATEX Zone 22	-	-	-	-	-	Yes ¹⁾	-	
GOST-R					Yes			
GL					Yes ¹⁾			
Endurance								
SLC flash	Yes							
Guaranteed data volume								
Guaranteed ²⁾	50 TB	100 TB	200 TB	400 TB	800 TB	1600 TB	3200 TB	
Over 5 years, equates to ²⁾	27.40 GB/day	54.79 GB/day	109.9 GB/day	219.8 GB/day	438.6 GB/day	876.72 GB/day	1753.44 GB/day	
Clear/Write cycles								
Guaranteed	100,000							
Wear leveling	Static							
Error correction coding (ECC)	Yes							
S.M.A.R.T. support	Yes							
Support								
Hardware	PP300/400, PP500, PPC300, PPC700, PPC725, PPC800, APC620, APC810, APC820							
Operating systems								
Windows 7 32-bit	No	No	No	No	No	Yes	Yes	
Windows 7 64-bit	No	No	No	No	No	No	Yes	
Windows Embedded Standard 7 32-bit	No	No	No	No	Yes	Yes	Yes	
Windows Embedded Standard 7 64-bit	No	No	No	No	No	Yes	Yes	
Windows XP Professional	No	No	No	Yes	Yes	Yes	Yes	
Windows XP Embedded				Yes				
Windows Embedded Standard 2009	No	Yes	Yes	Yes	Yes	Yes	Yes	
Windows CE 6.0	Yes	Yes	Yes	Yes	Yes	Yes ³⁾	Yes ³⁾	
Windows CE 5.0				No				
Software								
PVI Transfer	≥ V3.2.3.8 (part of PVI Development Setup ≥ V2.06.00.3011)	≥ V3.2.3.8 (part of PVI Development Setup ≥ V2.06.00.3011)	≥ V3.2.3.8 (part of PVI Development Setup ≥ V2.06.00.3011)	≥ V3.2.3.8 (part of PVI Development Setup ≥ V2.06.00.3011)	≥ V3.2.3.8 (part of PVI Development Setup ≥ V2.06.00.3011)	≥ V3.2.3.8 (part of PVI Development Setup ≥ V2.06.00.3011)	≥ V3.6.8.40 (part of PVI Development Setup ≥ V3.0.0.3020)	≥ V4.0.0.8 (part of PVI Development Setup ≥ V3.0.2.3014)
B&R Embedded OS Installer	≥V3.10	≥V3.10	≥V3.10	≥V3.10	≥V3.10	≥V3.10	≥V3.20	≥V3.21
Environmental conditions								
Temperature								
Operation	0 to 70°C							
Storage	-50 to 100°C							
Transport	-50 to 100°C							
Relative humidity								
Operation	Max. 85% at 85°C							
Storage	Max. 85% at 85°C							
Transport	Max. 85% at 85°C							
Vibration								
Operation	20 g peak, 20 to 2000 Hz, 4 in each direction (JEDEC JESD22, method B103) 5.35 g RMS, 15 min per level (IEC 68-2-6)							
Storage	20 g peak, 20 to 2000 Hz, 4 in each direction (JEDEC JESD22, method B103) 5.35 g RMS, 15 min per level (IEC 68-2-6)							
Transport	20 g peak, 20 to 2000 Hz, 4 in each direction (JEDEC JESD22, method B103) 5.35 g RMS, 15 min per level (IEC 68-2-6)							
Shock								
Operation	1.5 kg peak, 0.5 ms 5 times (JEDEC JESD22, method B110) 30 g, 11 ms 1 times (IEC 68-2-27)							
Storage	1.5 kg peak, 0.5 ms 5 times (JEDEC JESD22, method B110) 30 g, 11 ms 1 times (IEC 68-2-27)							
Transport	1.5 kg peak, 0.5 ms 5 times (JEDEC JESD22, method B110) 30 g, 11 ms 1 times (IEC 68-2-27)							
Altitude								
Operation	Max. 4572 m							
Mechanical characteristics								
Dimensions								
Width	42.8 ±0.10 mm							
Length	36.4 ±0.15 mm							
Height	3.3 ±0.10 mm							
Weight	10 g							

Table 171: 5CFCRD.0512-06, 5CFCRD.1024-06, 5CFCRD.2048-06, 5CFCRD.4096-06, 5CFCRD.8192-06, 5CFCRD.016G-06, 5CFCRD.032G-06 - Technical data

- 1) Yes, although applies only if all components installed within the complete system have this certification
- 2) Endurance of B&R CFs (with linear written block size ≥128 kB).
- 3) Not supported by the B&R Embedded OS Installer.

4.3.4 Temperature/Humidity diagram

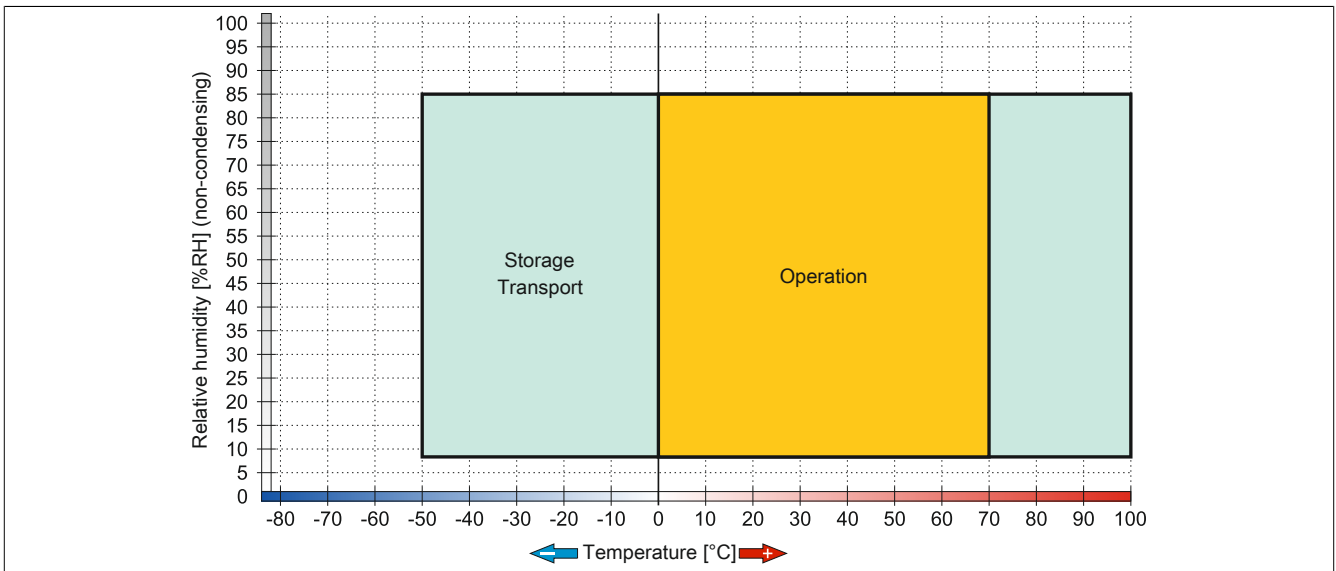

Figure 79: 5CFCRD.xxxx-06 - Temperature/Humidity diagram for CompactFlash cards

4.3.5 Dimensions

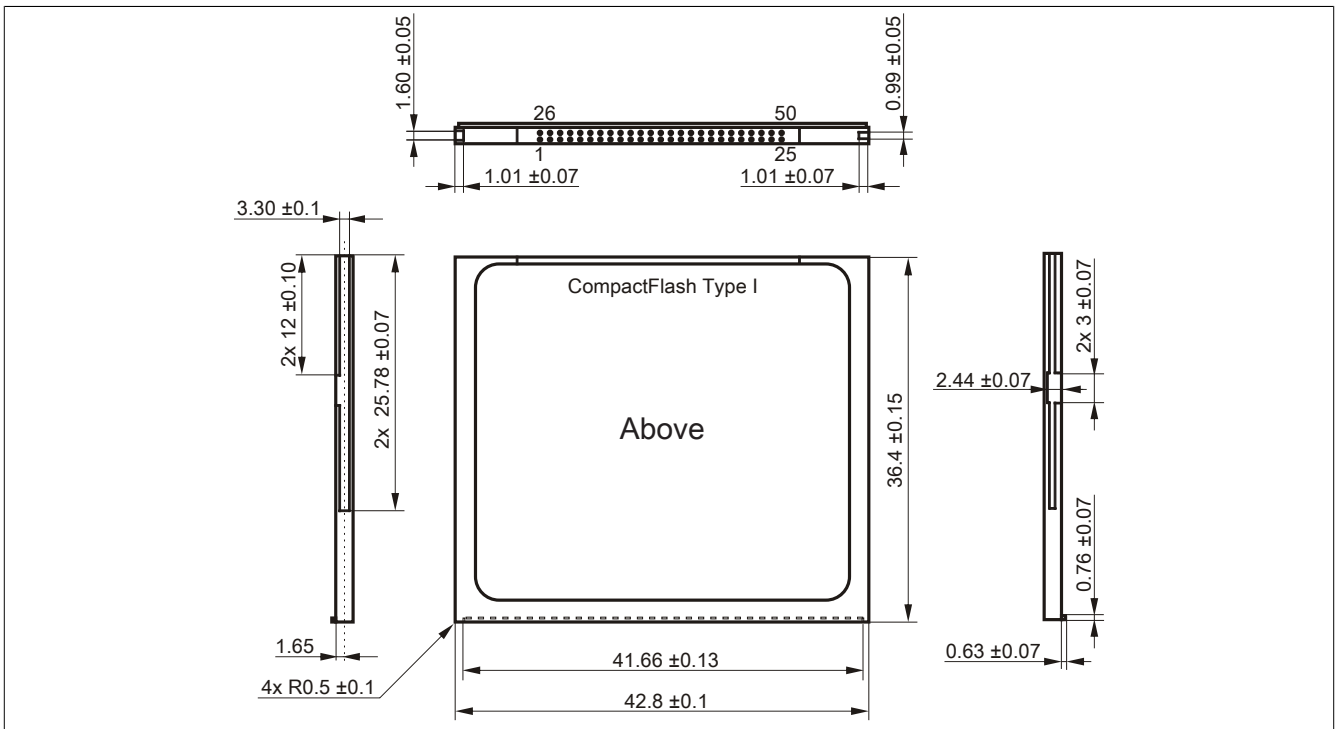

Figure 80: Type I CompactFlash card - Dimensions

4.3.6 Benchmark

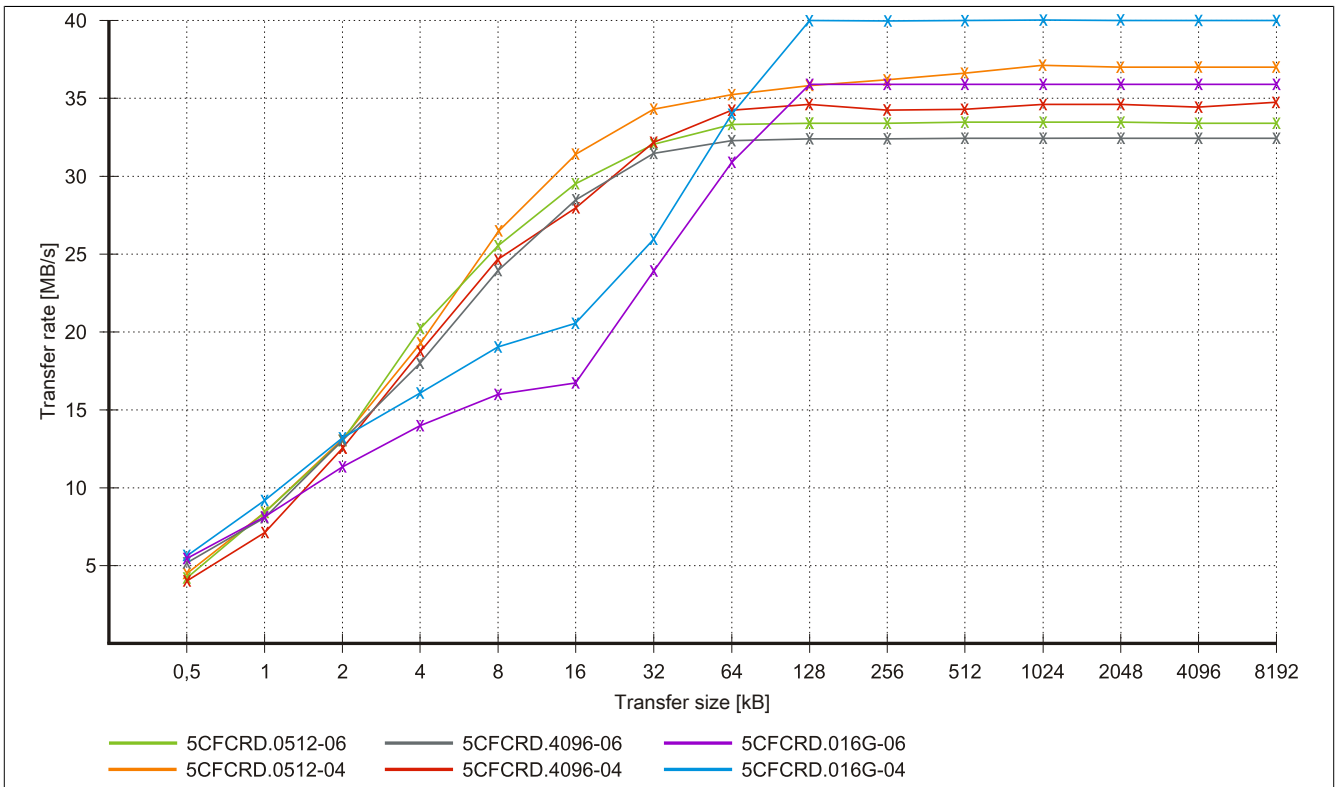

Figure 81: ATTO Disk Benchmark v2.34 read comparison - 5CFCRD.xxxx-04 and 5CFCRD.xxxx-06

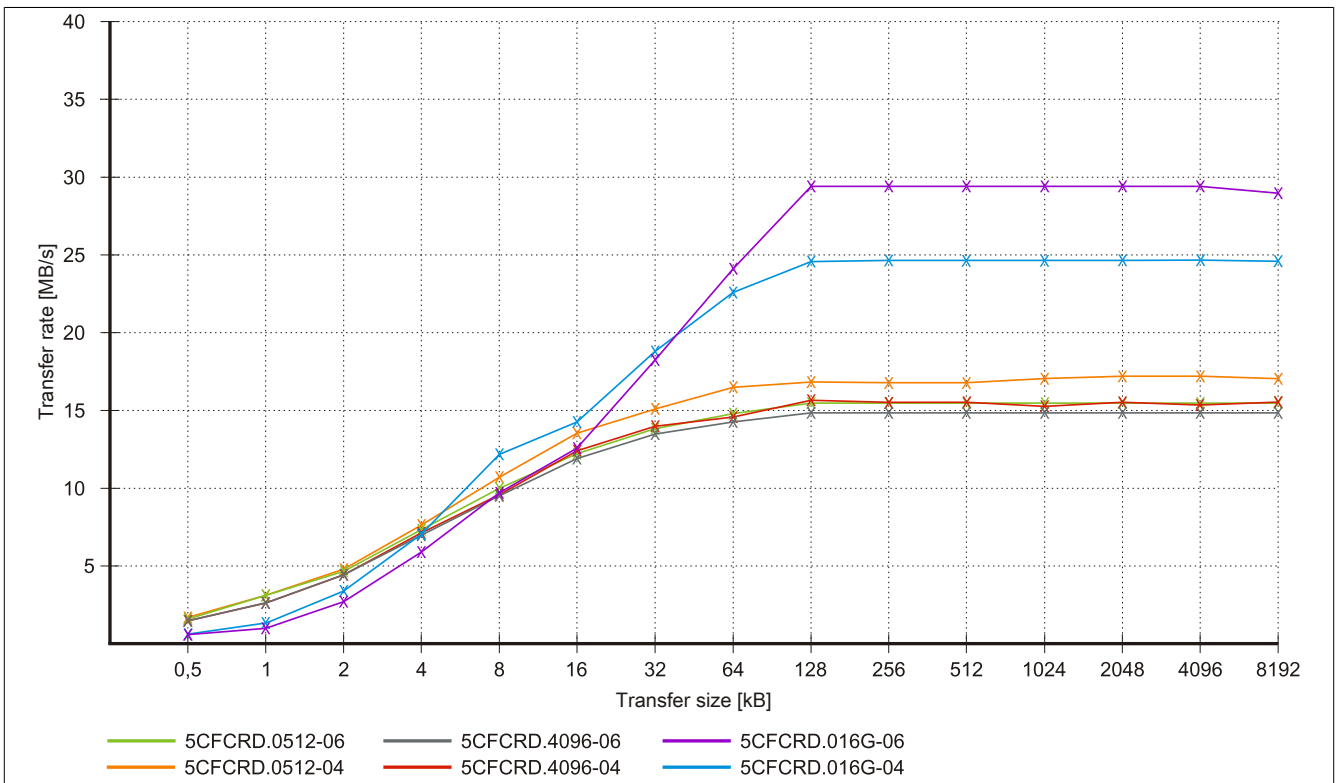

Figure 82: ATTO Disk Benchmark v2.34 write comparison - 5CFCRD.xxxx-04 and 5CFCRD.xxxx-06

4.4 5CFCRD.xxxx-04

4.4.1 General information

Information:

B&R CompactFlash cards 5CFCRD.xxxx-04 and CompactFlash cards from a different manufacturer cannot be used in the same system at the same time. Due to differences in technology (older vs. newer technologies), problems can occur during system startup that are caused by different boot times.

see "Known problems/issues" on page 186

Information:

5CFCRD.xxxx-04 CompactFlash cards are supported on B&R devices with WinCE version ≥ 6.0 .

4.4.2 Order data

Model number	Short description	Figure
	CompactFlash cards	
5CFCRD.0512-04	CompactFlash 512 MB B&R (SLC)	
5CFCRD.1024-04	CompactFlash 1 GB B&R (SLC)	
5CFCRD.2048-04	CompactFlash 2 GB B&R (SLC)	
5CFCRD.4096-04	CompactFlash 4 GB B&R (SLC)	
5CFCRD.8192-04	CompactFlash 8 GB B&R (SLC)	
5CFCRD.016G-04	CompactFlash 16 GB B&R (SLC)	

Table 172: 5CFCRD.0512-04, 5CFCRD.1024-04, 5CFCRD.2048-04, 5CFCRD.4096-04, 5CFCRD.8192-04, 5CFCRD.016G-04 - Order data

4.4.3 Technical data

Caution!

A sudden loss of power may result in data loss! In very rare cases, the mass storage device may also become damaged.

To prevent damage and loss of data, the use of a UPS device is recommended.

Information:

The following characteristics, features and limit values only apply to this accessory and can deviate from those specified for the complete system. The data specifications for the complete system take precedence over those of individual components.

Product ID	5CFCRD.0512-04	5CFCRD.1024-04	5CFCRD.2048-04	5CFCRD.4096-04	5CFCRD.8192-04	5CFCRD.016G-04
General information						
Capacity	512 MB	1 GB	2 GB	4 GB	8 GB	16 GB
Data retention	10 years					
Data reliability	<1 unrecoverable error in 10 ¹⁴ bit read accesses					
Lifetime monitoring	Yes					
MTBF	>3,000,000 hours (at 25°C)					
Maintenance	None					
Supported operating modes	PIO Mode 0-6, Multiword DMA Mode 0-4, Ultra DMA Mode 0-4					
Sequential read						
Typical	35 MB/s (240X) ¹⁾	35 MB/s (240X) ¹⁾	35 MB/s (240X) ¹⁾	33 MB/s (220X) ¹⁾	27 MB/s (180X) ¹⁾	36 MB/s (240X) ¹⁾
Maximum	37 MB/s (260X) ¹⁾	37 MB/s (260X) ¹⁾	37 MB/s (260X) ¹⁾	34 MB/s (226X) ¹⁾	28 MB/s (186X) ¹⁾	37 MB/s (247X) ¹⁾

Table 173: 5CFCRD.0512-04, 5CFCRD.1024-04, 5CFCRD.2048-04, 5CFCRD.4096-04, 5CFCRD.8192-04, 5CFCRD.016G-04 - Technical data

Accessories • CompactFlash cards

Product ID	5CFCRD.0512-04	5CFCRD.1024-04	5CFCRD.2048-04	5CFCRD.4096-04	5CFCRD.8192-04	5CFCRD.016G-04
Sequential write						
Typical	17 MB/s (110X)	17 MB/s (110X)	17 MB/s (110X)	16 MB/s (106X)	15 MB/s (100X)	18 MB/s (120X)
Maximum	20 MB/s (133X)	20 MB/s (133X)	20 MB/s (133X)	18 MB/s (120X)	17 MB/s (110X)	19 MB/s (126X)
Certification				Yes		
CE				Yes		
cULus				Yes		
GOST-R	-	Yes	Yes	Yes	Yes	Yes
GL				Yes ²⁾		
Endurance						
SLC flash	Yes					
Guaranteed data volume						
Guaranteed ³⁾	50 TB	100 TB	200 TB	400 TB	800 TB	1600 TB
Results for 5 years ³⁾	27.40 GB/day	54.79 GB/day	109.9 GB/day	219.8 GB/day	438.6 GB/day	876.72 GB/day
Clear/Write cycles						
Typical ⁴⁾	2,000,000					
Guaranteed	100,000					
Wear leveling	Static					
Error correction coding (ECC)	Yes					
S.M.A.R.T. support	No					
Support						
Hardware	PP300/400, PP500, PPC300, PPC700, PPC725, PPC800, APC620, APC810, APC820					
Operating systems						
Windows 7 32-bit	No	No	No	No	No	Yes
Windows 7 64-bit				No		
Windows Embedded Standard 7, 32-bit	No	No	No	No	Yes	Yes
Windows Embedded Standard 7, 64-bit	No	No	No	No	No	Yes
Windows XP Professional	No	No	No	Yes	Yes	Yes
Windows XP Embedded				Yes		
Windows Embedded Standard 2009	No	Yes	Yes	Yes	Yes	Yes
Windows CE 6.0	Yes	Yes	Yes	Yes	Yes	Yes ⁵⁾
Windows CE 5.0				No		
Software						
PVI Transfer	≥ V3.2.3.8 (part of PVI Development Setup ≥ V2.06.00.3011)	≥ V3.2.3.8 (part of PVI Development Setup ≥ V2.06.00.3011)	≥ V3.2.3.8 (part of PVI Development Setup ≥ V2.06.00.3011)	≥ V3.2.3.8 (part of PVI Development Setup ≥ V2.06.00.3011)	≥ V3.2.3.8 (part of PVI Development Setup ≥ V2.06.00.3011)	≥ V3.6.8.40 (part of PVI Development Setup ≥ V3.0.0.3020)
B&R Embedded OS Installer	≥V3.10	≥V3.10	≥V3.10	≥V3.10	≥V3.10	≥V3.20
Environmental conditions						
Temperature						
Operation	0 to 70°C					
Storage	-65 to 150°C					
Transport	-65 to 150°C					
Relative humidity						
Operation	Max. 85% at 85°C					
Storage	Max. 85% at 85°C					
Transport	Max. 85% at 85°C					
Vibration						
Operation	20 g peak, 20 to 2000 Hz, 4 in each direction (JEDEC JESD22, method B103) 5.35 g RMS, 15 min per level (IEC 68-2-6)					
Storage	20 g peak, 20 to 2000 Hz, 4 in each direction (JEDEC JESD22, method B103) 5.35 g RMS, 15 min per level (IEC 68-2-6)					
Transport	20 g peak, 20 to 2000 Hz, 4 in each direction (JEDEC JESD22, method B103) 5.35 g RMS, 15 min per level (IEC 68-2-6)					
Shock						
Operation	1.5 kg peak, 0.5 ms 5 times (JEDEC JESD22, method B110) 30 g, 11 ms 1 times (IEC 68-2-27)					
Storage	1.5 kg peak, 0.5 ms 5 times (JEDEC JESD22, method B110) 30 g, 11 ms 1 times (IEC 68-2-27)					
Transport	1.5 kg peak, 0.5 ms 5 times (JEDEC JESD22, method B110) 30 g, 11 ms 1 times (IEC 68-2-27)					
Altitude						
Operation	Max. 4572 m					
Mechanical characteristics						
Dimensions						
Width	42.8 ±0.10 mm					
Length	36.4 ±0.15 mm					
Height	3.3 ±0.10 mm					
Weight	10 g					

Table 173: 5CFCRD.0512-04, 5CFCRD.1024-04, 5CFCRD.2048-04, 5CFCRD.4096-04, 5CFCRD.8192-04, 5CFCRD.016G-04 - Technical data

- Speed specification with 1X = 150 Kb/s. All specifications refer to Samsung flash chips, CompactFlash cards in UDMA mode 4 and 30 ns cycle time in True IDE mode with sequential write/read test.
- Yes, although applies only if all components installed within the complete system have this certification

- 3) Endurance of B&R CFs (with linear written block size ≥ 128 kB).
- 4) Depends on the average file size.
- 5) Not supported by the B&R Embedded OS Installer.

4.4.4 Temperature/Humidity diagram

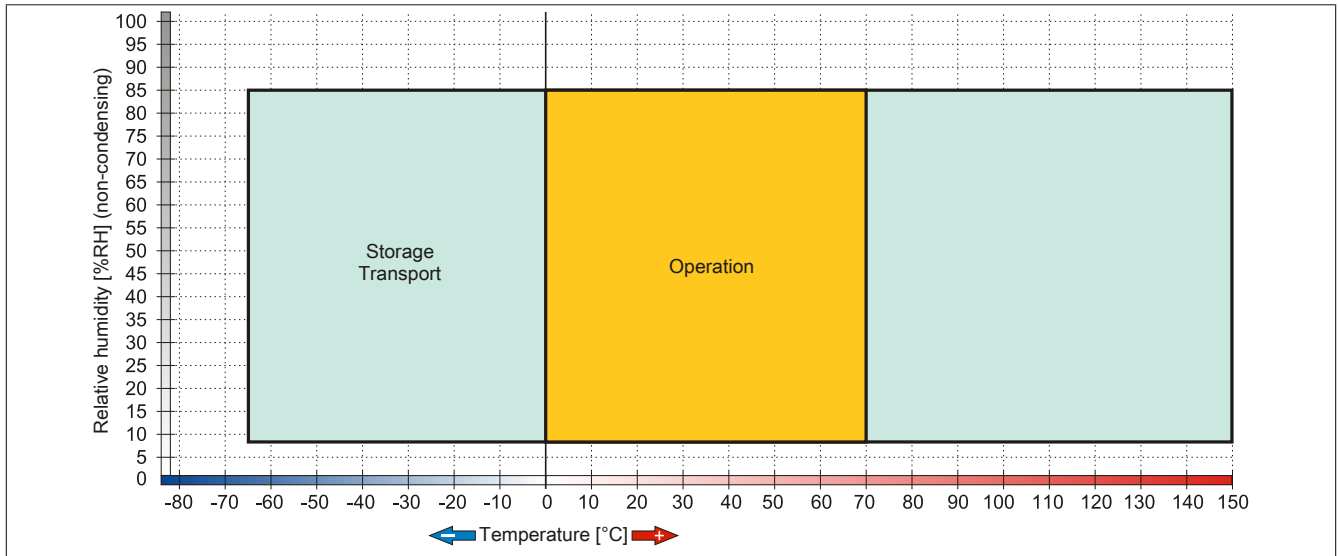

Figure 83: 5CFCRD.xxxx-04 - Temperature/Humidity diagram for CompactFlash cards

4.4.5 Dimensions

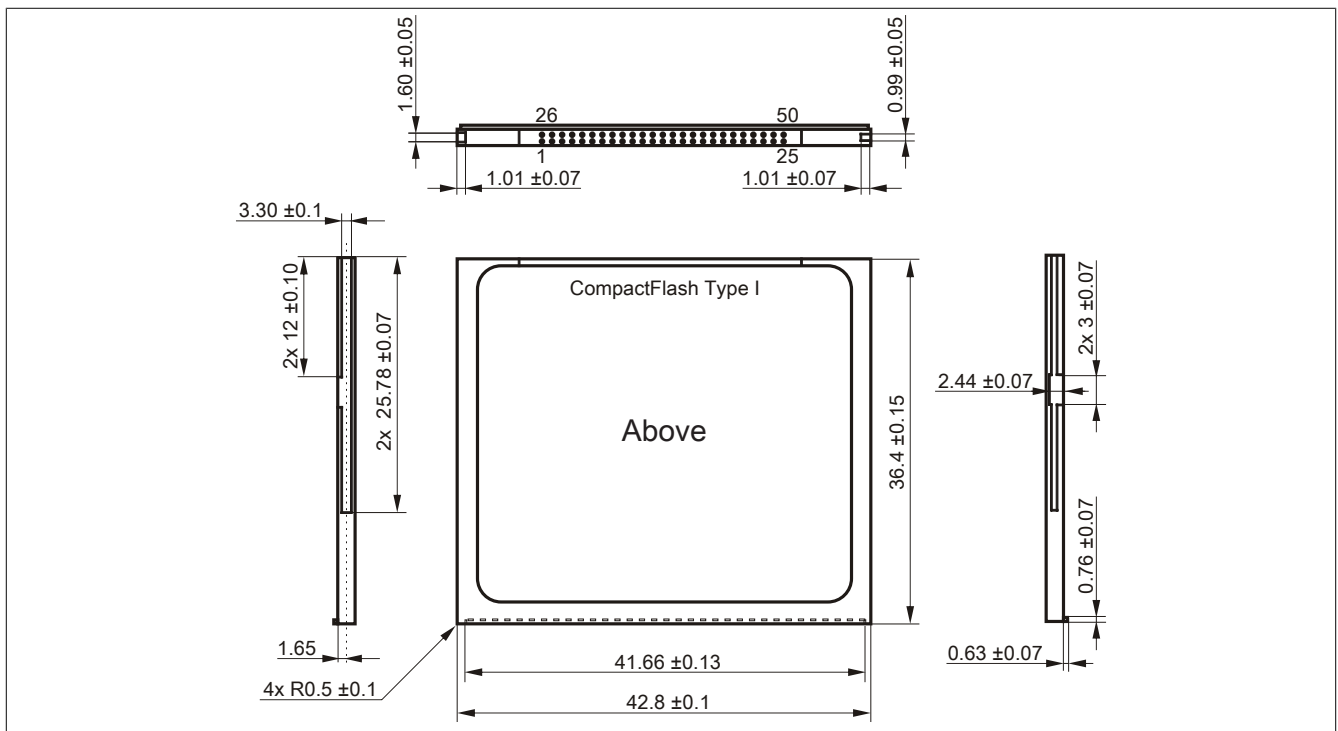

Figure 84: Type I CompactFlash card - Dimensions

4.4.6 Benchmark

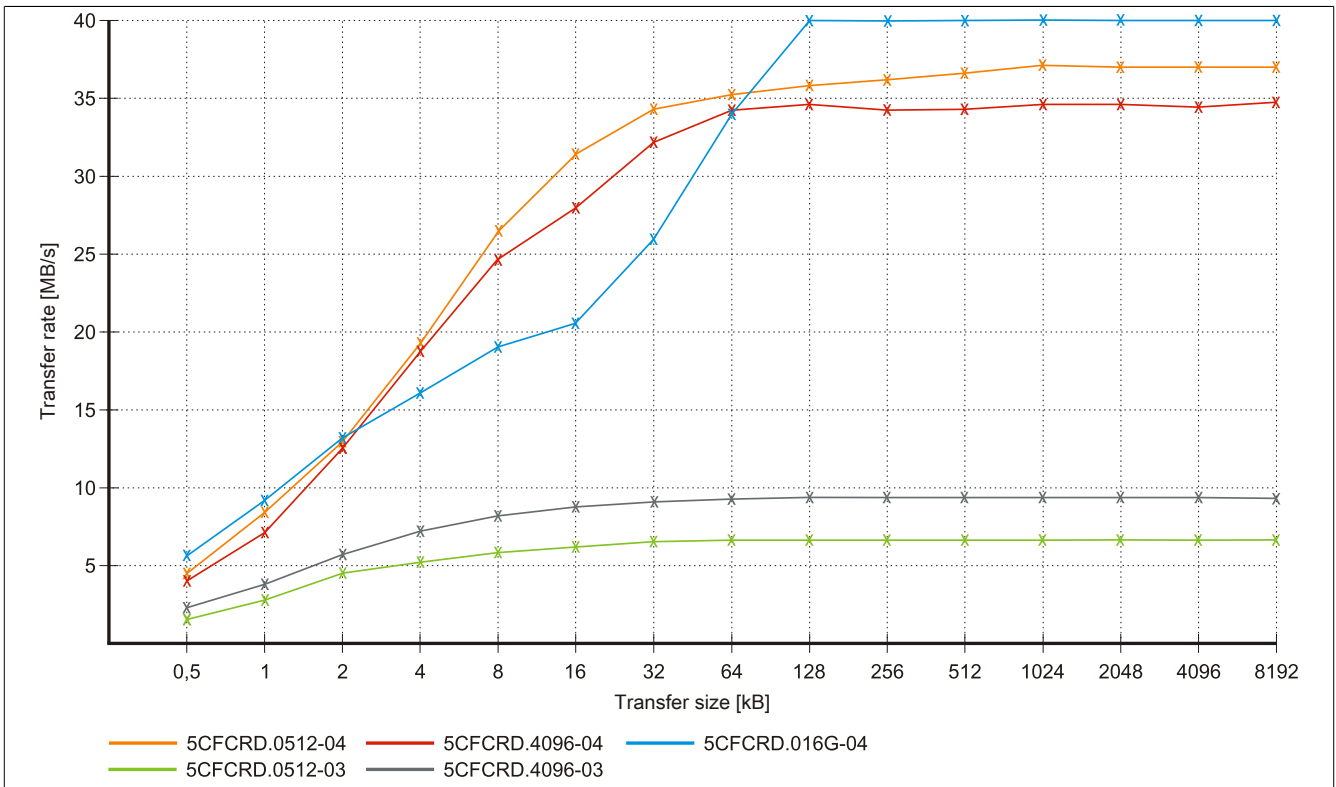

Figure 85: ATTO Disk Benchmark v2.34 read comparison - 5CFCRD.xxxx-03 and 5CFCRD.xxxx-04

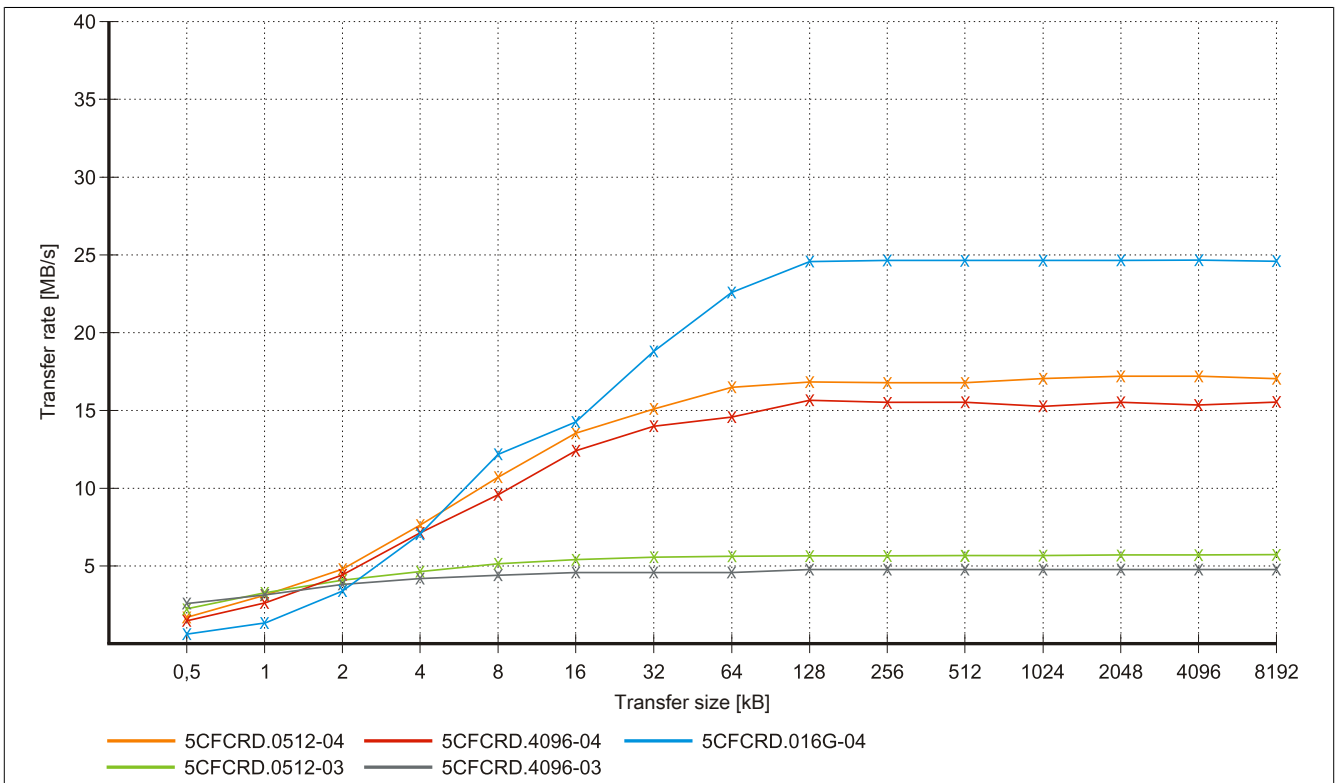

Figure 86: ATTO Disk Benchmark v2.34 write comparison - 5CFCRD.xxxx-03 and 5CFCRD.xxxx-04

4.5 5CFCRD.xxxx-03

4.5.1 General information

Information:

Western Digital CompactFlash cards 5CFCRD.xxxx and CompactFlash cards from a different manufacturer cannot be used in the same system at the same time. Due to differences in technology (older vs. newer technologies), problems can occur during system startup that are caused by different boot times.

see "Known problems/issues" on page 186

Information:

On Windows CE 5.0 devices, 5CFCRD.xxxx-03 CompactFlash cards up to 1 GB are supported.

Information:

On CompactFlash cards 5CFCRD.xxxx-03, only the sticker and the description have changed. The technical data has not been changed.

4.5.2 Order data

Model number	Short description	Figure
	CompactFlash cards	
5CFCRD.0064-03	CompactFlash 64 MB Western Digital (SLC)	
5CFCRD.0128-03	CompactFlash 128 MB Western Digital (SLC)	
5CFCRD.0256-03	CompactFlash 256 MB Western Digital (SLC)	
5CFCRD.0512-03	CompactFlash 512 MB Western Digital (SLC)	
5CFCRD.1024-03	CompactFlash 1 GB Western Digital (SLC)	
5CFCRD.2048-03	CompactFlash 2 GB Western Digital (SLC)	
5CFCRD.4096-03	CompactFlash 4 GB Western Digital (SLC)	
5CFCRD.8192-03	CompactFlash 8 GB Western Digital (SLC)	

Table 174: 5CFCRD.0064-03, 5CFCRD.0128-03, 5CFCRD.0256-03, 5CFCRD.0512-03, 5CFCRD.1024-03, 5CFCRD.2048-03, 5CFCRD.4096-03, 5CFCRD.8192-03 - Order data

4.5.3 Technical data

Caution!

A sudden loss of power may result in data loss! In very rare cases, the mass storage device may also become damaged.

To prevent damage and loss of data, B&R recommends that you use a UPS device.

Information:

The following characteristics, features and limit values only apply to this accessory and can deviate from those specified for the complete system. The data specifications for the complete system take precedence over those of individual components.

Product ID	5CFCRD.0064-03	5CFCRD.0128-03	5CFCRD.0256-03	5CFCRD.0512-03	5CFCRD.1024-03	5CFCRD.2048-03	5CFCRD.4096-03	5CFCRD.8192-03
General information								
Capacity	64 MB	128 MB	256 MB	512 MB	1 GB	2 GB	4 GB	8 GB
Data retention	10 years							
Data reliability	<1 unrecoverable error in 10 ¹⁴ bit read accesses							
Lifetime monitoring	Yes							

Table 175: 5CFCRD.0064-03, 5CFCRD.0128-03, 5CFCRD.0256-03, 5CFCRD.0512-03, 5CFCRD.1024-03, 5CFCRD.2048-03, 5CFCRD.4096-03, 5CFCRD.8192-03 - Technical data

Accessories • CompactFlash cards

Product ID	5CFCRD.0064-03	5CFCRD.0128-03	5CFCRD.0256-03	5CFCRD.0512-03	5CFCRD.1024-03	5CFCRD.2048-03	5CFCRD.4096-03	5CFCRD.8192-03
MTBF	>4,000,000 hours (at 25°C)							
Maintenance	None							
Supported operating modes	PIO Mode 0-4, Multiword DMA Mode 0-2							
Sequential read Typical	8 MB/s							
Sequential write Typical	6 MB/s							
Certification CE cULus GOST-R GL	Yes Yes Yes Yes ¹⁾							
Endurance								
SLC flash	Yes							
Clear/Write cycles Typical	>2,000,000							
Wear leveling	Static							
Error correction coding (ECC)	Yes							
S.M.A.R.T. support	No							
Support								
Hardware	MP100/200, PP100/200, PP300/400, PP500, PPC300, PPC700, PPC725, PPC800, Provit 2000, Provit 5000, APC620, APC680, APC810, APC820							
Operating systems								
Windows 7 32-bit	No							
Windows 7 64-bit	No							
Windows Embedded Standard 7, 32-bit	No	No	No	No	No	No	No	Yes
Windows Embedded Standard 7, 64-bit	No							
Windows XP Professional	No	No	No	No	No	No	Yes	Yes
Windows XP Embedded	No	No	No	Yes	Yes	Yes	Yes	Yes
Windows Embedded Standard 2009	No	No	No	No	Yes	Yes	Yes	Yes
Windows CE 6.0	Yes	Yes	Yes	Yes	Yes	Yes	Yes	Yes ²⁾
Windows CE 5.0	Yes	Yes	Yes	Yes	Yes	No	No	No
Software								
PVI Transfer	≥V2.57 (part of PVI Development Setup ≥ V2.5.3.3005)							
B&R Embedded OS Installer	≥V2.21							
Environmental conditions								
Temperature								
Operation	0 to 70°C							
Storage	-50 to 100°C							
Transport	-50 to 100°C							
Relative humidity								
Operation	8 to 95%, non-condensing							
Storage	8 to 95%, non-condensing							
Transport	8 to 95%, non-condensing							
Vibration								
Operation	Max. 16.3 g (159 m/s ² 0-peak)							
Storage	Max. 30 g (294 m/s ² 0-peak)							
Transport	Max. 30 g (294 m/s ² 0-peak)							
Shock								
Operation	Max. 1000 g (9810 m/s ² 0-peak)							
Storage	Max. 3000 g (29430 m/s ² 0-peak)							
Transport	Max. 3000 g (29430 m/s ² 0-peak)							
Altitude								
Operation	Max. 24383 m							
Mechanical characteristics								
Dimensions								
Width	42.8 ±0.10 mm							
Length	36.4 ±0.15 mm							
Height	3.3 ±0.10 mm							
Weight	11.4 g							

Table 175: 5CFCRD.0064-03, 5CFCRD.0128-03, 5CFCRD.0256-03, 5CFCRD.0512-03, 5CFCRD.1024-03, 5CFCRD.2048-03, 5CFCRD.4096-03, 5CFCRD.8192-03 - Technical data

- 1) Yes, although applies only if all components installed within the complete system have this certification
- 2) Not supported by the B&R Embedded OS Installer.

4.5.4 Temperature/Humidity diagram

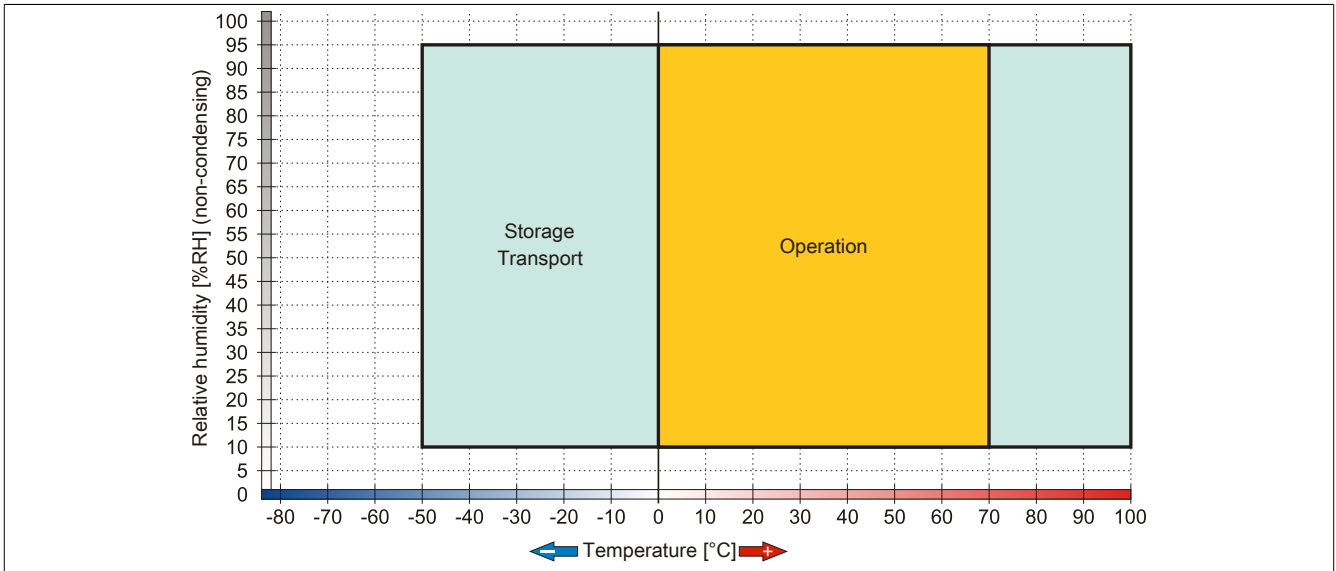

Figure 87: 5CFCRD.xxxx-03 - Temperature/Humidity diagram for CompactFlash cards

4.5.5 Dimensions

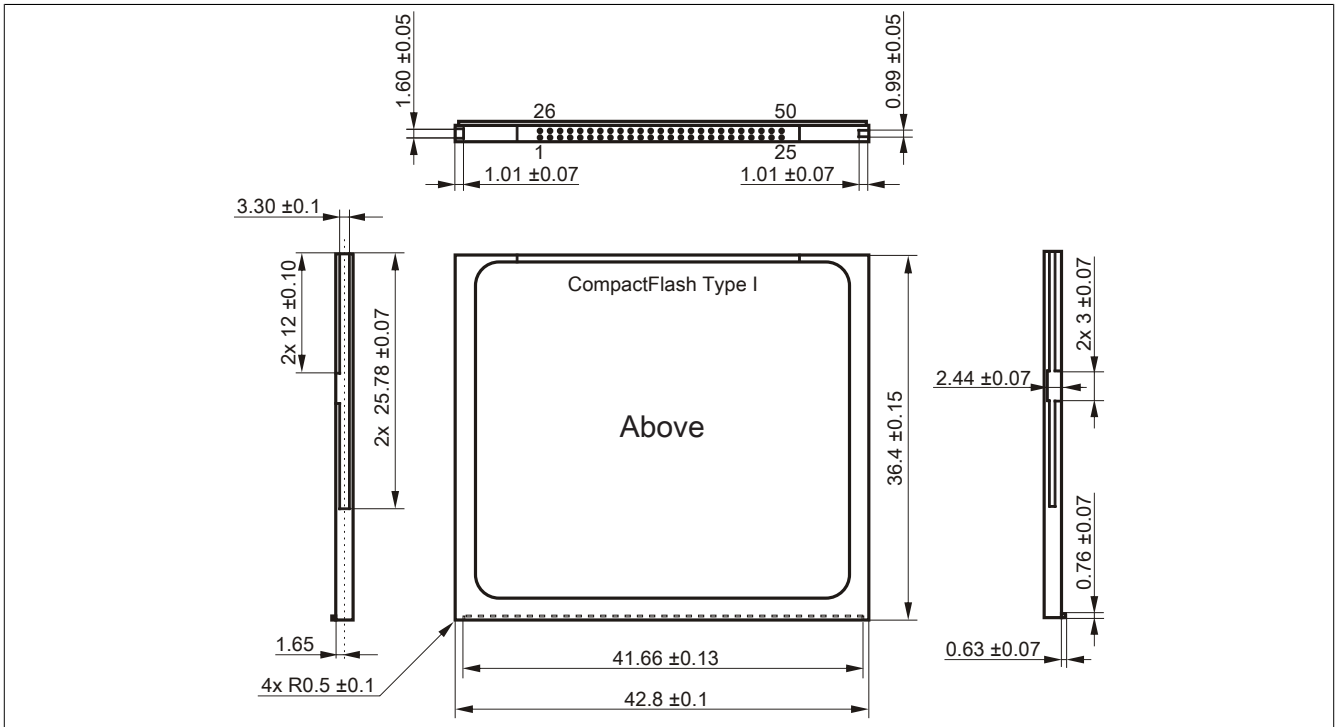

Figure 88: Type I CompactFlash card - Dimensions

4.6 Known problems/issues

The following is a known issue for devices with two CompactFlash slots:

- Using two different types of CompactFlash cards can cause problems with Automation PCs and Panel PCs. For example, it is possible that one of the two cards is not detected during system startup. This is caused by different startup speeds. CompactFlash cards with older technology require significantly more time during system startup than CompactFlash cards with newer technology. This behavior occurs near the end of the time frame provided for startup. The problem described can occur because the startup time for the CompactFlash cards fluctuates due to the different components being used. Depending on the CompactFlash card being used, this error might never, sometimes or always occur.

5 USB flash drives

5.1 5MMUSB.2048-00

5.1.1 General information

USB flash drives are storage media that are easy to exchange. Because of their high-speed data transfer (USB 2.0), USB flash drives are ideal for use as portable data storage. Without requiring additional drivers ("hot plugging", except in the case of Windows 98SE), the USB flash drive can immediately act as an additional drive for reading or writing data.

Information:

Due to the large number of USB flash drives available on the market as well as their short product life cycle, we reserve the right to supply alternative products at any time. The following measures may therefore be necessary in order to boot from these flash drives as well:

- The flash drive must be reformatted or in some cases even repartitioned (set active partition).
- The flash drive must be the first bootable device in the BIOS boot order; alternatively, the IDE controllers can be disabled in BIOS. This can be avoided in most cases if the "fdisk /mbr" command is additionally executed on the USB flash drive.

5.1.2 Order data

Model number	Short description	Figure
	USB accessories	
5MMUSB.2048-00	USB 2.0 flash drive, 2048 MB	

Table 176: 5MMUSB.2048-00 - Order data

5.1.3 Technical data

Information:

The following characteristics, features and limit values only apply to this accessory and can deviate from those specified for the complete system. The data specifications for the complete system take precedence over those of individual components.

Product ID	5MMUSB.2048-00
General information	
Data retention	10 years
LEDs	1 LED (green) ¹⁾
MTBF	100,000 hours (at 25°C)
Type	USB 1.1, USB 2.0
Maintenance	None
Certification CE	Yes
Interfaces	
USB	
Type	USB 1.1, USB 2.0
Connection	To any USB type A interface
Transfer rate	Low speed (1.5 Mbit/s), full speed (12 Mbit/s), high speed (480 Mbit/s)
Sequential reading	Max. 8.7 MB/s
Sequential writing	Max. 1.7 MB/s
Support	
Operating systems	
Windows XP Professional	Yes
Windows XP Embedded	Yes
Windows ME	Yes
Windows 2000	Yes
Windows CE 5.0	Yes
Windows CE 4.2	Yes
Electrical characteristics	
Power consumption	650 µA sleep mode, 150 mA read/write

Table 177: 5MMUSB.2048-00 - Technical data

Product ID	5MMUSB.2048-00
Environmental conditions	
Temperature	
Operation	0 to 45°C
Storage	-20 to 60°C
Transport	-20 to 60°C
Relative humidity	
Operation	10 to 90%, non-condensing
Storage	5 to 90%, non-condensing
Transport	5 to 90%, non-condensing
Vibration	
Operation	10 to 500 Hz: 2 g (19.6 m/s ² 0-peak), oscillation rate 1/minute
Storage	10 to 500 Hz: 2 g (19.6 m/s ² 0-peak), oscillation rate 1/minute
Transport	10 to 500 Hz: 2 g (19.6 m/s ² 0-peak), oscillation rate 1/minute
Shock	
Operation	Max. 40 g (392 m/s ² 0-peak) and 11 ms duration
Storage	Max. 80 g (784 m/s ² 0-peak) and 11 ms duration
Transport	Max. 80 g (784 m/s ² 0-peak) and 11 ms duration
Altitude	
Operation	Max. 3048 m
Storage	Max. 12192 m
Transport	Max. 12192 m
Mechanical characteristics	
Dimensions	
Width	19 mm
Length	52.2 mm
Height	7.9 mm

Table 177: 5MMUSB.2048-00 - Technical data

1) Indicates data being transferred (sending and receiving).

5.1.4 Temperature/Humidity diagram

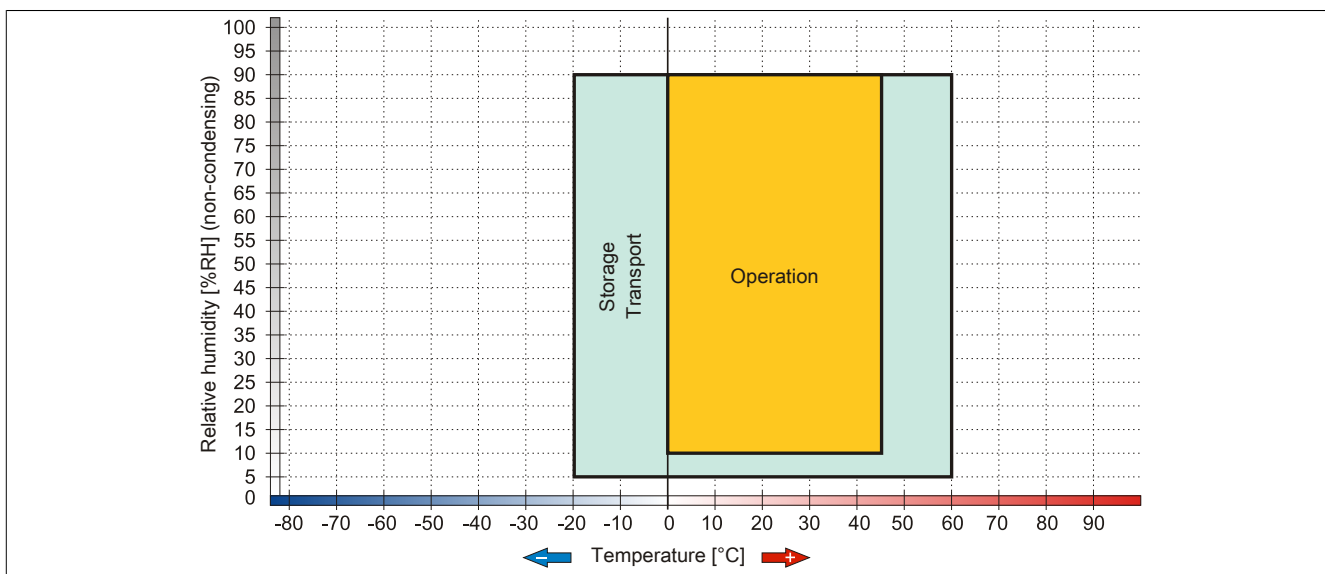

Figure 89: 5MMUSB.2048-00 - Temperature/Humidity diagram

5.2 5MMUSB.xxxx-01

5.2.1 General information

USB flash drives are storage media that are easy to exchange. Because of their high-speed data transfer (USB 2.0), USB flash drives are ideal for use as portable data storage. Without requiring additional drivers ("hot plugging", except in the case of Windows 98SE), the USB flash drive can immediately act as an additional drive for reading or writing data.

Information:

Due to the large number of USB flash drives available on the market as well as their short product life cycle, we reserve the right to supply alternative products at any time. The following measures may therefore be necessary in order to boot from these flash drives as well:

- The flash drive must be reformatted or in some cases even repartitioned (set active partition).
- The flash drive must be the first bootable device in the BIOS boot order; alternatively, the IDE controllers can be disabled in BIOS. This can be avoided in most cases if the "fdisk /mbr" command is additionally executed on the USB flash drive.

5.2.2 Order data

Model number	Short description	Figure
	USB accessories	
5MMUSB.2048-01	USB 2.0 flash drive, 2048 MB, B&R	
5MMUSB.4096-01	USB 2.0 flash drive, 4096 MB, B&R	

Table 178: 5MMUSB.2048-01, 5MMUSB.4096-01 - Order data

5.2.3 Technical data

Product ID	5MMUSB.2048-01	5MMUSB.4096-01
General information		
Capacity	2 GB	4 GB
LEDs	1 LED (green) ¹⁾	
MTBF	>3,000,000 hours	
Type	USB 1.1, USB 2.0	
Maintenance	None	
Default file system	FAT16	FAT32
Certification		
CE	Yes	
GOST-R	Yes	
Interfaces		
USB		
Type	USB 1.1, USB 2.0	
Connection	To any USB type A interface	
Transfer rate	Low speed (1.5 Mbit/s), full speed (12 Mbit/s), high speed (480 Mbit/s)	
Sequential reading	Full speed max. 1 MB/s, high speed max. 32 MB/s	
Sequential writing	Full speed max. 0.9 MB/s, high speed max. 23 MB/s	
Endurance		
SLC flash	Yes	
Data retention	>10 years	
Data reliability	<1 unrecoverable error in 10 ¹⁴ bit read accesses	
Connection cycles	>1,500	
Support		
Operating systems		
Windows 7	Yes	
Windows XP Professional	Yes	
Windows XP Embedded	Yes	
Windows ME	Yes	
Windows 2000	Yes	
Windows CE 5.0	Yes	
Windows CE 4.2	Yes	
Electrical characteristics		
Current consumption	Max. 500 µA sleep mode, max. 120 mA read/write	

Table 179: 5MMUSB.2048-01, 5MMUSB.4096-01 - Technical data

Product ID	5MMUSB.2048-01	5MMUSB.4096-01
Environmental conditions		
Temperature		
Operation	0 to 70°C	
Storage	-50 to 100°C	
Transport	-50 to 100°C	
Relative humidity		
Operation	85%, non-condensing	
Storage	85%, non-condensing	
Transport	85%, non-condensing	
Vibration		
Operation	20 to 2000 Hz: 20 g (peak)	
Storage	20 to 2000 Hz: 20 g (peak)	
Transport	20 to 2000 Hz: 20 g (peak)	
Shock		
Operation	Max. 1500 g (peak)	
Storage	Max. 1500 g (peak)	
Transport	Max. 1500 g (peak)	
Altitude		
Operation	Max. 3048 m	
Storage	Max. 12192 m	
Transport	Max. 12192 m	
Mechanical characteristics		
Dimensions		
Width	17.97 mm	
Length	67.85 mm	
Height	8.35 mm	

Table 179: 5MMUSB.2048-01, 5MMUSB.4096-01 - Technical data

1) Indicates data being transferred (sending and receiving).

5.2.4 Temperature/Humidity diagram

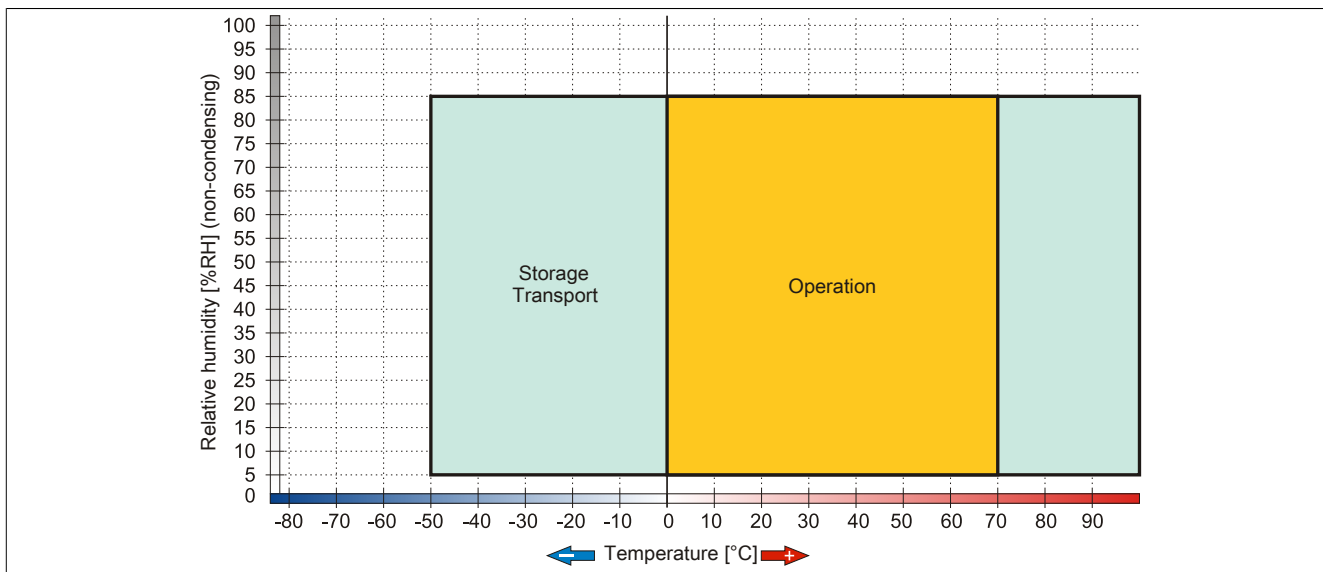

Figure 90: 5MMUSB.xxxx-01 - Temperature/Humidity diagram

6 Cables

6.1 DVI cables

6.1.1 5CADVI.0xxx-00

6.1.1.1 General information

5CADVI.0xxx-00 DVI cables are designed for use in inflexible applications.

Caution!

Power must be disconnected before connecting or disconnecting cables.

6.1.1.2 Order data

Model number	Short description	Figure
	DVI cables	
5CADVI.0018-00	DVI-D cable - 1.8 m	
5CADVI.0050-00	DVI-D cable - 5 m	
5CADVI.0100-00	DVI-D cable - 10 m	

Table 180: 5CADVI.0018-00, 5CADVI.0050-00, 5CADVI.0100-00 - Order data

6.1.1.3 Technical data

Product ID	5CADVI.0018-00	5CADVI.0050-00	5CADVI.0100-00
General information			
Certification			
CE		Yes	
cULus		Yes	
GOST-R		Yes	
GL		Yes ¹⁾	
Cable construction			
Wire cross section		AWG 28	
Shield		Individual cable pairs and entire cable	
Complete shielding		Tinned copper braiding, optical coverage >86%	
Outer sheathing			
Material		PVC	
Color		Beige	
Labeling		AWM STYLE 20276 80°C 30V VW1 DVI DIGITAL SINGLE LINK DER AN	
Connector			
Type		2x DVI-D (18+1), male	
Connection cycles		100	
Locating screw tightening torque		Max. 0.5 Nm	
Electrical characteristics			
Conductor resistance		Max. 237 Ω/km	
Insulation resistance		Min. 100 MΩ/km	
Mechanical characteristics			
Dimensions			
Length	1.8 m ±50 mm	5 m ±80 mm	10 m ±100 mm
Diameter		Max. 8.5 mm	
Flex radius	≥5x cable diameter (male connector - ferrite bead and ferrite bead - ferrite bead)		
Weight	Approx. 260 g	Approx. 460 g	Approx. 790 g

Table 181: 5CADVI.0018-00, 5CADVI.0050-00, 5CADVI.0100-00 - Technical data

1) Yes, although applies only if all components installed within the complete system have this certification.

6.1.1.4 Flex radius specifications

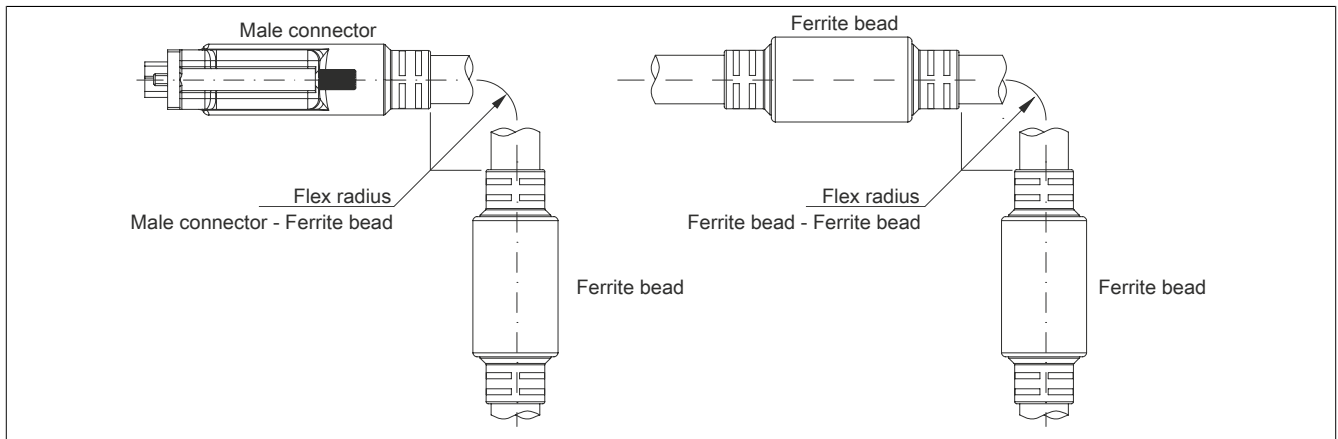

Figure 91: Flex radius specifications

6.1.1.5 Dimensions

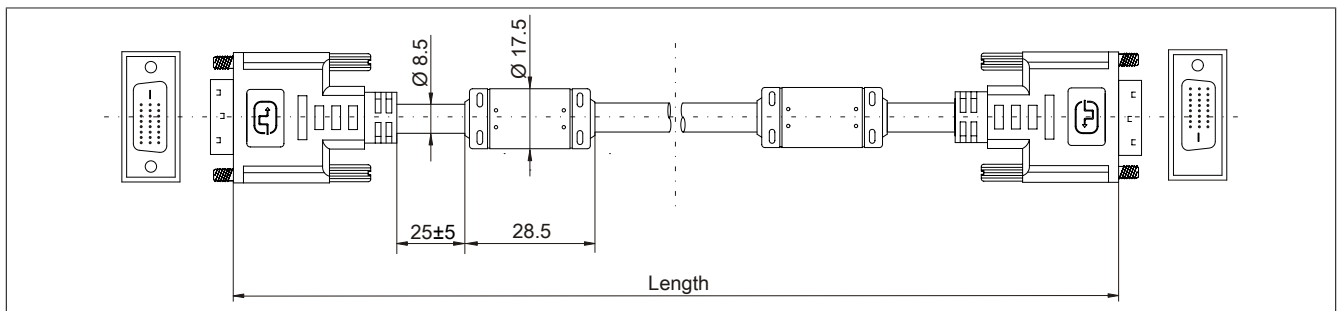

Figure 92: 5CADVI.0xxx-00 - Dimensions

6.1.1.6 Cable pinout

Warning!

Field-assembled cables must be wired according to these specifications.

If a field-assembled cable is used, B&R cannot guarantee that it will function properly. All cables provided by B&R are guaranteed to function properly, however.

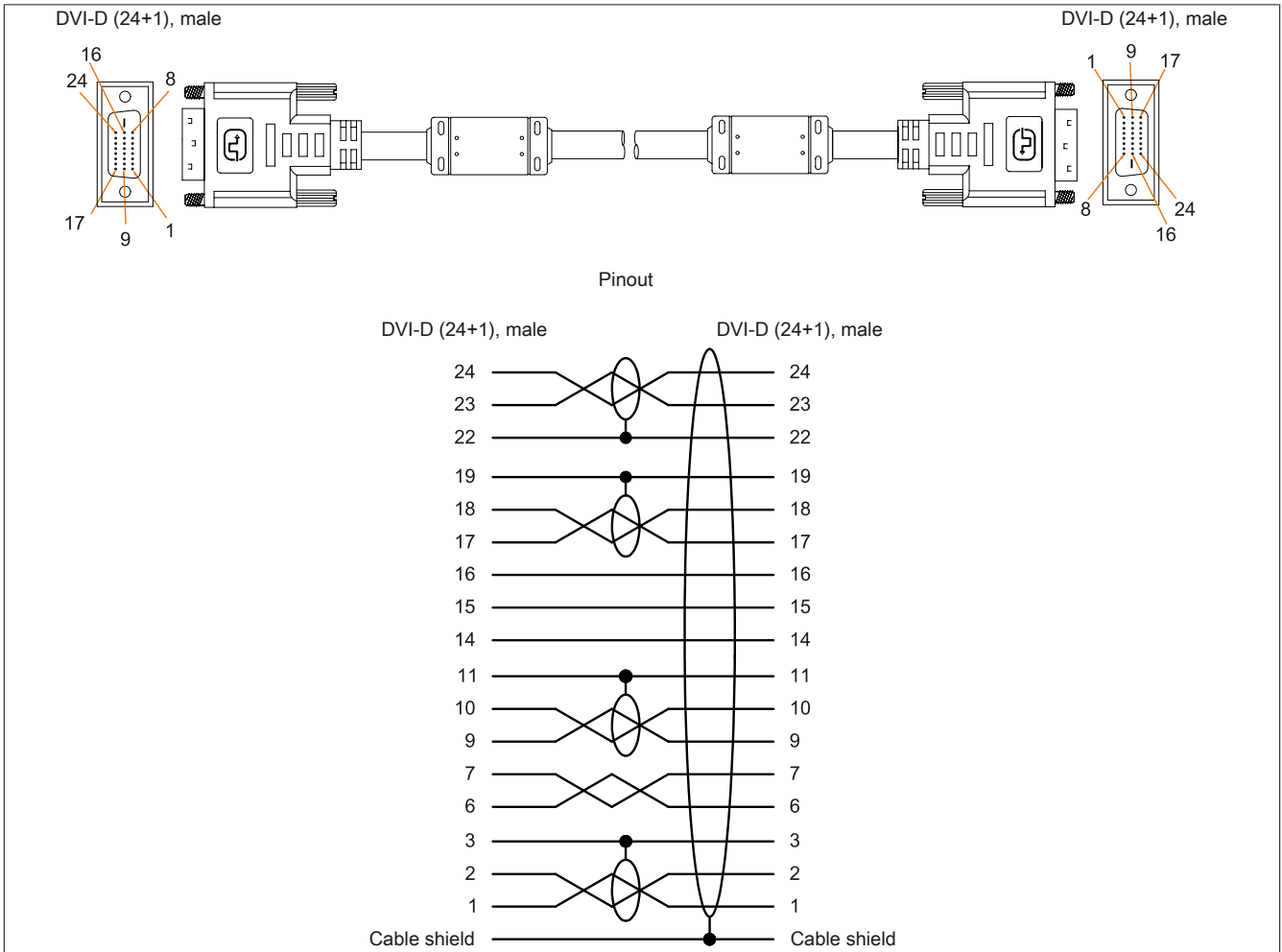

Figure 93: 5CADVI.0xxx-00 - Pinout

6.2 SDL cables

6.2.1 5CASDL.0xxx-00

6.2.1.1 General information

5CASDL.0xxx-00 SDL cables are designed for use in inflexible applications. 5CASDL.0xxx-03 SDL flex cables are required for flexible applications (e.g. swing arm systems).

Caution!

Power must be disconnected before connecting or disconnecting cables.

6.2.1.2 Order data

Model number	Short description	Figure
	SDL cables	
5CASDL.0018-00	SDL cable - 1.8 m	
5CASDL.0050-00	SDL cable - 5 m	
5CASDL.0100-00	SDL cable, 10 m	
5CASDL.0150-00	SDL cable, 15 m	
5CASDL.0200-00	SDL cable, 20 m	
5CASDL.0250-00	SDL cable, 25 m	
5CASDL.0300-00	SDL cable, 30 m	

Table 182: 5CASDL.0018-00, 5CASDL.0050-00, 5CASDL.0100-00, 5CASDL.0150-00, 5CASDL.0200-00, 5CASDL.0250-00, 5CASDL.0300-00 - Order data

6.2.1.3 Technical data

Product ID	5CASDL. 0018-00	5CASDL. 0050-00	5CASDL. 0100-00	5CASDL. 0150-00	5CASDL. 0200-00	5CASDL. 0250-00	5CASDL. 0300-00
General information							
Certification				Yes			
CE				Yes			
cULus				Yes			
GOST-R				Yes			
GL				Yes ¹⁾			
Cable construction							
Wire cross section	AWG 28			AWG 24			
Shield	Individual cable pairs and entire cable						
Complete shielding	Tinned copper braiding, optical coverage >85%						
Outer sheathing							
Material	PVC						
Color	Black						
Labeling	E74020-C (UL) AWM STYLE 20176 80°C 30V VW-1 DVI DIGITAL LINK						
Connector							
Type	2x DVI-D (24+1), male						
Connection cycles	100						
Contacts	Gold-plated						
Mechanical protection	Metal cover with crimped stress relief						
Locating screw tightening torque	Max. 0.5 Nm						
Electrical characteristics							
Conductor resistance				≤93 Ω/km			
AWG 24							
AWG 28	≤237 Ω/km						
Insulation resistance	Min. 10 MΩ/km						
Mechanical characteristics							
Dimensions							
Length	1.8 m ±30 mm	5 m ±30 mm	10 m ±50 mm	15 m ±100 mm	20 m ±100 mm	25 m ±100 mm	30 m ±100 mm
Diameter	Typ. 8.6 ±0.2 mm Max. 9 mm			Typ. 11 ±0.2 mm Max. 11.5 mm			
Flex radius	≥5x cable diameter (male connector - ferrite bead and ferrite bead - ferrite bead)						
Flexibility	Limited flexibility, valid for ferrite bead - ferrite bead (tested 100 cycles with 5x cable diameter, 20 cycles/minute)						
Weight	Approx. 300 g	Approx. 580 g	Approx. 1500 g	Approx. 2250 g	Approx. 2880 g	Approx. 4800 g	Approx. 5520 g

Table 183: 5CASDL.0018-00, 5CASDL.0050-00, 5CASDL.0100-00, 5CASDL.0150-00, 5CASDL.0200-00, 5CASDL.0250-00, 5CASDL.0300-00 - Technical data

1) Yes, although applies only if all components installed within the complete system have this certification.

6.2.1.4 Flex radius specifications

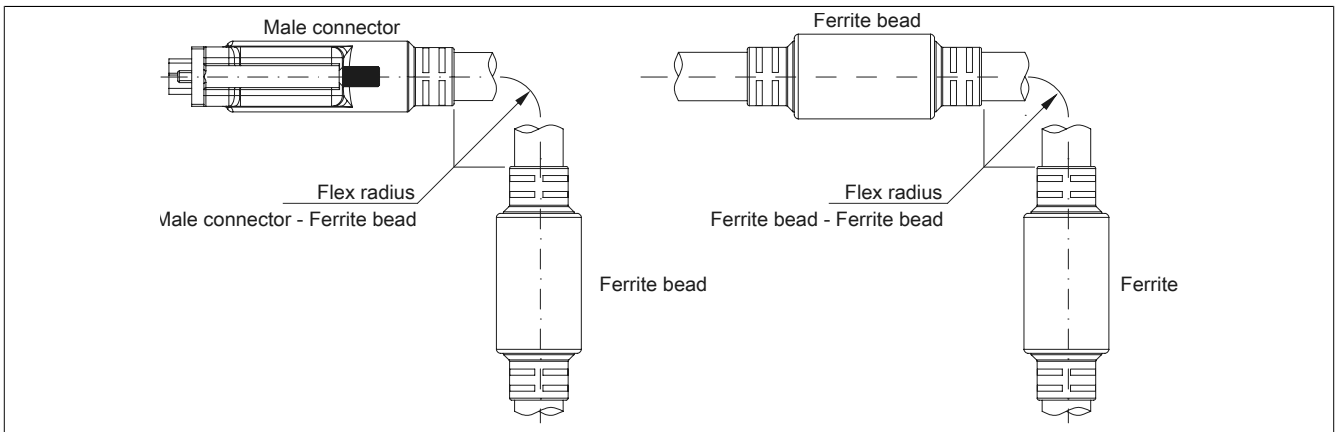

Figure 94: Flex radius specifications

6.2.1.5 Dimensions

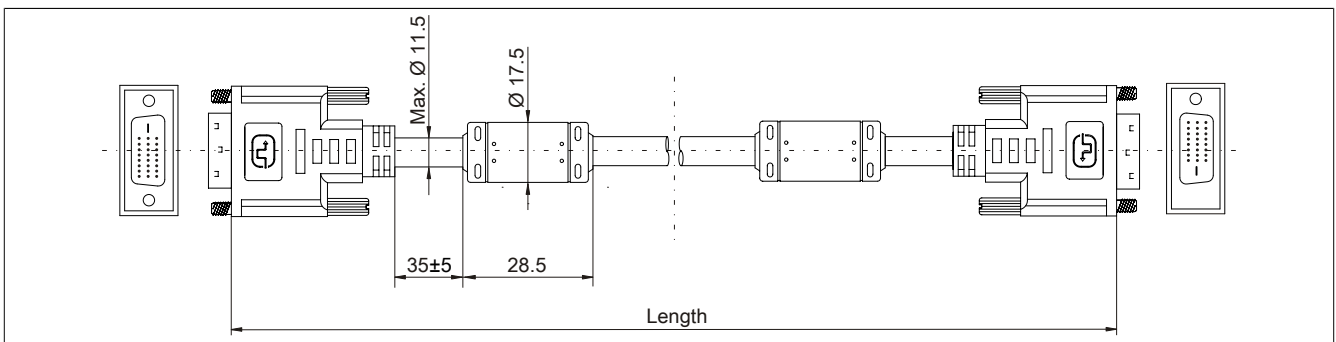

Figure 95: 5CASDL.0xxx-00- Dimensions

6.2.1.6 Cable pinout

Warning!

Field-assembled cables must be wired according to these specifications.

If a field-assembled cable is used, B&R cannot guarantee that it will function properly. All cables provided by B&R are guaranteed to function properly, however.

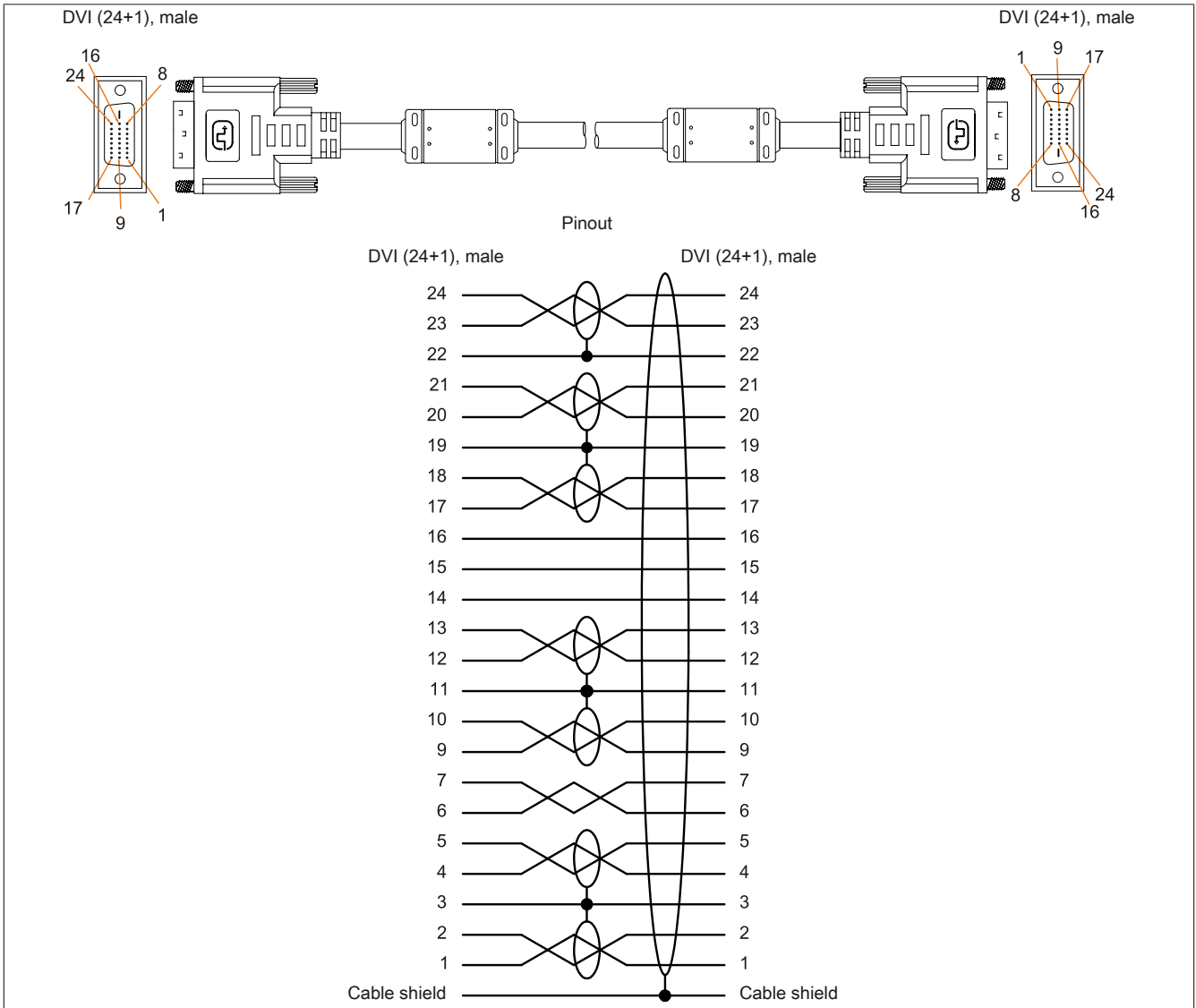

Figure 96: 5CASDL.0xxx-00 - Pinout

6.3 SDL flex cables

6.3.1 5CASDL.0xxx-03

6.3.1.1 General information

5CASDL.0xxx-03 SDL flex cables are designed for use in both inflexible and flexible applications (e.g. swing arm systems).

Caution!

Power must be disconnected before connecting or disconnecting cables.

6.3.1.2 Order data

Model number	Short description	Figure
	SDL flex cables	
5CASDL.0018-03	SDL flex cable - 1.8 m	
5CASDL.0050-03	SDL flex cable, 5 m	
5CASDL.0100-03	SDL flex cable, 10 m	
5CASDL.0150-03	SDL flex cable, 15 m	
5CASDL.0200-03	SDL flex cable, 20 m	
5CASDL.0250-03	SDL flex cable, 25 m	
5CASDL.0300-03	SDL flex cable, 30 m	

Table 184: 5CASDL.0018-03, 5CASDL.0050-03, 5CASDL.0100-03, 5CASDL.0150-03, 5CASDL.0200-03, 5CASDL.0250-03, 5CASDL.0300-03 - Order data

6.3.1.3 Technical data

Product ID	5CASDL. 0018-03	5CASDL. 0050-03	5CASDL. 0100-03	5CASDL. 0150-03	5CASDL. 0200-03	5CASDL. 0250-03	5CASDL. 0300-03
General information							
Certification				Yes			
CE				Yes			
cULus				Yes			
GOST-R				Yes			
GL				Yes ¹⁾			
Cable construction							
Wire cross section				AWG 24 (control wires) AWG 26 (DVI, USB, data)			
Features				Silicone- and halogen-free			
Shield				Individual cable pairs and entire cable			
Complete shielding				Aluminum-clad foil + tinned copper braiding			
Outer sheathing				Special semi-glossy TMPU			
Material				Black			
Color				(B&R) SDL Cable (UL) AWM 20236 80°C 30V E 63216			
Labeling							
Connector							
Type				2x DVI-D (24+1), male			
Connection cycles				Min. 200			
Contacts				Gold-plated			
Mechanical protection				Metal cover with crimped stress relief			
Locating screw tightening torque				Max. 0.5 Nm			
Electrical characteristics							
Operating voltage				≤30 V			
Test voltage				1 kV			
Wire/Wire				0.5 kV			
Wire/Shield							
Wave impedance				100 ±10 Ω			
Conductor resistance				≤95 Ω/km			
AWG 24				≤145 Ω/km			
AWG 26							
Insulation resistance				>200 MΩ/km			
Operating conditions							
Approbation				UL AWM 20236 80°C 30 V			
Flame-retardant				In accordance with UL758 (cable vertical flame test)			
Oil and hydrolysis resistance				In accordance with VDE 0282-10			

Table 185: 5CASDL.0018-03, 5CASDL.0050-03, 5CASDL.0100-03, 5CASDL.0150-03, 5CASDL.0200-03, 5CASDL.0250-03, 5CASDL.0300-03 - Technical data

Product ID	5CASDL.0018-03	5CASDL.0050-03	5CASDL.0100-03	5CASDL.0150-03	5CASDL.0200-03	5CASDL.0250-03	5CASDL.0300-03
Environmental conditions							
Temperature							
Storage	-20 to 80°C						
Fixed installation	-20 to 80°C						
Flexible installation	-5 to 60°C						
Mechanical characteristics							
Dimensions							
Length	1.8 m ±20 mm 5 m ±45 mm 10 m ±90 mm 15 m ±135 mm 20 m ±180 mm 25 m ±225 mm 30 m ±270 mm						
Diameter	Max. 12 mm						
Flex radius							
Fixed installation	≥6x cable diameter (from male connector - ferrite bead)						
	≥10x cable diameter (from ferrite bead - ferrite bead)						
Flexible installation	≥15x cable diameter (from ferrite bead - ferrite bead)						
Flexibility	Flexible, valid for ferrite bead - ferrite bead (tested 300,000 cycles with 15x cable diameter, 4800 cycles/hour)						
Drag chain data							
Flex cycles	300,000						
Speed	4800 cycles/hour						
Flex radius	180 mm, 15x cable diameter						
Hub	460 mm						
Weight	Approx. 460 g	Approx. 1020 g	Approx. 1940 g	Approx. 2840 g	Approx. 3740 g	Approx. 4560 g	Approx. 5590 g
Tension							
During operation	≤50 N						
During installation	≤400 N						

Table 185: 5CASDL.0018-03, 5CASDL.0050-03, 5CASDL.0100-03, 5CASDL.0150-03, 5CASDL.0200-03, 5CASDL.0250-03, 5CASDL.0300-03 - Technical data

1) Yes, although applies only if all components installed within the complete system have this certification.

6.3.1.4 Flex radius specifications

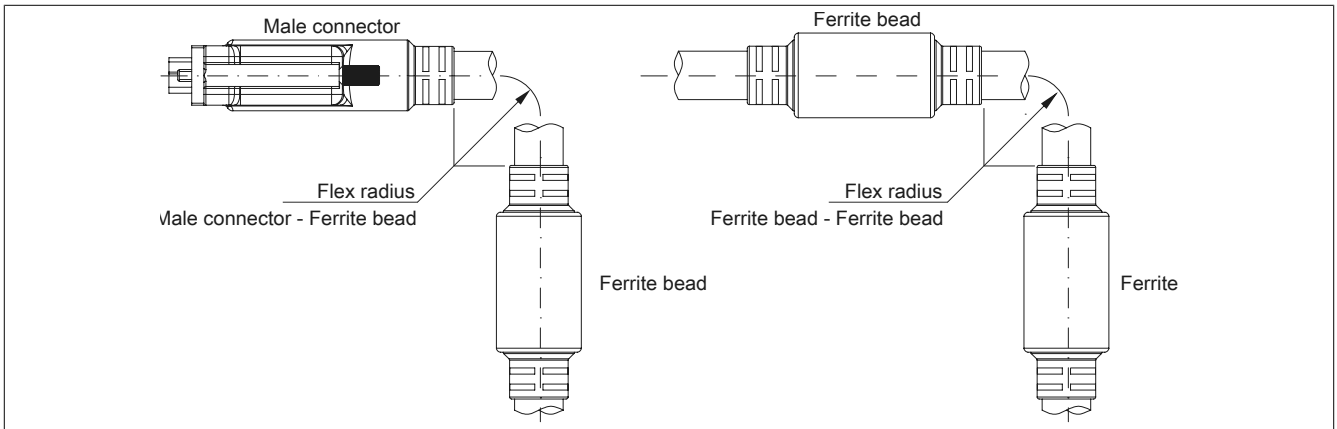

Figure 97: Flex radius specifications

6.3.1.5 Dimensions

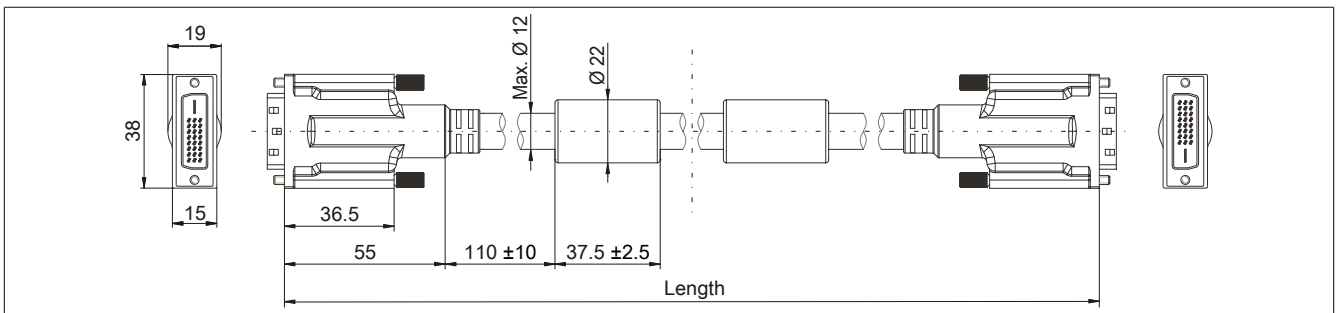

Figure 98: 5CASDL.0xxx-03 - Dimensions

6.3.1.6 Design

Element	Assignment	Cross section
DVI	TMDS data 0	26 AWG
	TMDS data 1	26 AWG
	TMDS data 2	26 AWG
	TMDS cycle	26 AWG
USB	XUSB0	26 AWG
	XUSB1	26 AWG
Data	SDL	26 AWG
	DDC cycle	24 AWG
Control wires	DDC data	24 AWG
	+5 V	24 AWG
	Ground	24 AWG
	Hot plug detect	24 AWG

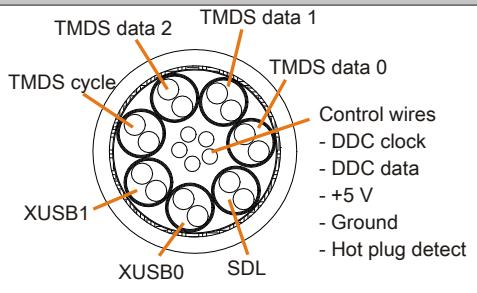

Table 186: 5CASDL.0xxx-03 SDL flex cables - Structure

6.3.1.7 Cable pinout

Warning!

Field-assembled cables must be wired according to these specifications.

If a field-assembled cable is used, B&R cannot guarantee that it will function properly. All cables provided by B&R are guaranteed to function properly, however.

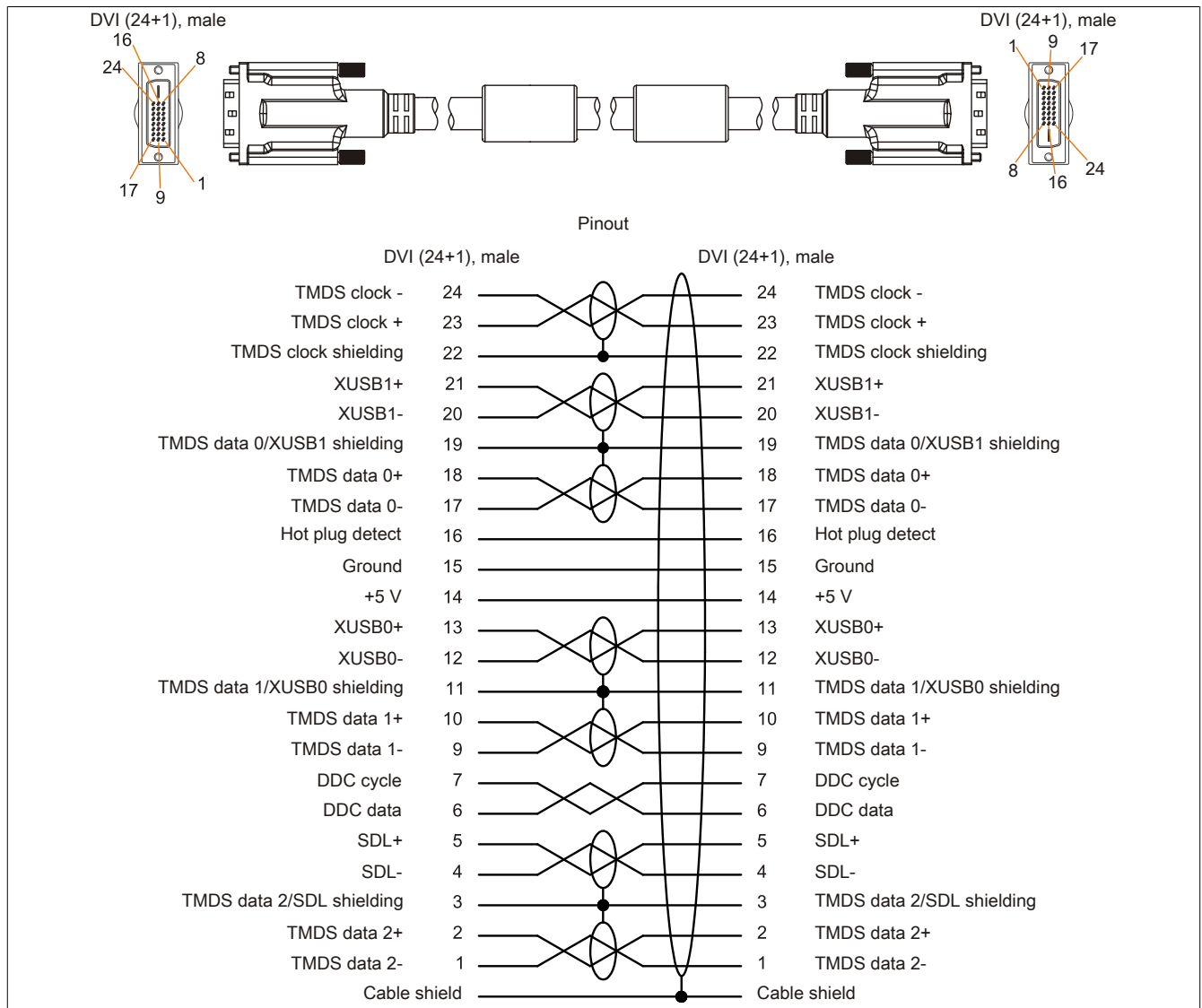

Figure 99: 5CASDL.0xxx-03 - Pinout

6.4 SDL flex cables with extender

6.4.1 5CASDL.0xx0-13

6.4.1.1 General information

5CASDL.0xx0-13 SDL flex cables with an extender are designed for use in both inflexible and flexible applications (e.g. swing arm systems).

Caution!

Power must be disconnected before connecting or disconnecting cables.

6.4.1.2 Order data

Model number	Short description	Figure
	SDL flex cables	
5CASDL.0300-13	SDL flex cable with extender, 30 m	
5CASDL.0400-13	SDL flex cable with extender, 40 m	
5CASDL.0430-13	SDL flex cable with extender, 43 m	

Table 187: 5CASDL.0300-13, 5CASDL.0400-13, 5CASDL.0430-13 - Order data

6.4.1.3 Technical data

Product ID	5CASDL.0300-13	5CASDL.0400-13	5CASDL.0430-13
General information			
Certification		Yes	
CE		Yes	
cULus		Yes	
GOST-R		Yes	
GL		Yes ¹⁾	
Cable construction			
Wire cross section		AWG 24 (control wires) AWG 26 (DVI, USB, data)	
Features		Silicone- and halogen-free	
Shield		Individual cable pairs and entire cable	
Complete shielding		Aluminum-clad foil + tinned copper braiding	
Outer sheathing			
Material		Special semi-glossy TMPU	
Color		Black	
Labeling		(B&R) SDL cable (UL) AWM 20236 80°C 30V E63216	
Connector			
Type		2x DVI-D (24+1), male	
Connection cycles		Min. 200	
Contacts		Gold-plated	
Mechanical protection		Metal cover with crimped stress relief	
Locating screw tightening torque		Max. 0.5 Nm	
Electrical characteristics			
Operating voltage		≤30 V	
Test voltage			
Wire/Wire		1 kV	
Wire/Shield		0.5 kV	
Wave impedance		100 ±10 Ω	
Conductor resistance			
AWG 24		≤95 Ω/km	
AWG 26		≤145 Ω/km	
Insulation resistance		>200 MΩ/km	
Operating conditions			
Approbation		UL AWM 20236 80°C 30 V	
Flame-retardant		In accordance with UL758 (cable vertical flame test)	
Oil and hydrolysis resistance		In accordance with VDE 0282-10	
Environmental conditions			
Temperature			
Storage		-20 to 60°C	
Fixed installation		-20 to 60°C	
Flexible installation		-5 to 60°C	

Table 188: 5CASDL.0300-13, 5CASDL.0400-13, 5CASDL.0430-13 - Technical data

Product ID	5CASDL.0300-13	5CASDL.0400-13	5CASDL.0430-13
Mechanical characteristics			
Dimensions			
Length	30 m ±280 mm	40 m ±380 mm	43 m ±410 mm
Diameter		Max. 12 mm	
Extender box			
Width		35 mm	
Length		125 mm	
Height		18.5 mm	
Flex radius			
Fixed installation	≥6x cable diameter (from male connector - ferrite bead) ≥10x cable diameter (from ferrite bead - ferrite bead)		
Flexible installation	≥15x cable diameter (from ferrite bead - ferrite bead)		
Flexibility	Flexible, valid for ferrite bead - ferrite bead (tested 300,000 cycles with 15x cable diameter, 4800 cycles/hour)		
Drag chain data			
Flex cycles	300,000		
Speed	4800 cycles/hour		
Flex radius	180 mm, 15x cable diameter		
Hub	460 mm		
Weight	Approx. 5430 g	Approx. 7200 g	Approx. 7790 g
Tension			
During operation	≤50 N		
During installation	≤400 N		

Table 188: 5CASDL.0300-13, 5CASDL.0400-13, 5CASDL.0430-13 - Technical data

1) Yes, although applies only if all components installed within the complete system have this certification.

6.4.1.4 Flex radius specifications

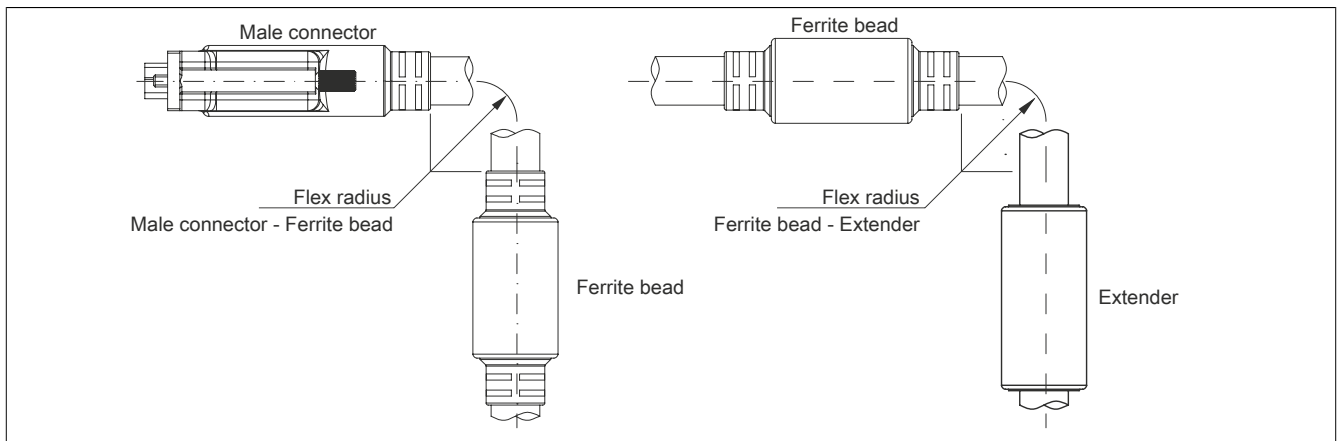

Figure 100: Flex radius specification with extender

6.4.1.5 Dimensions

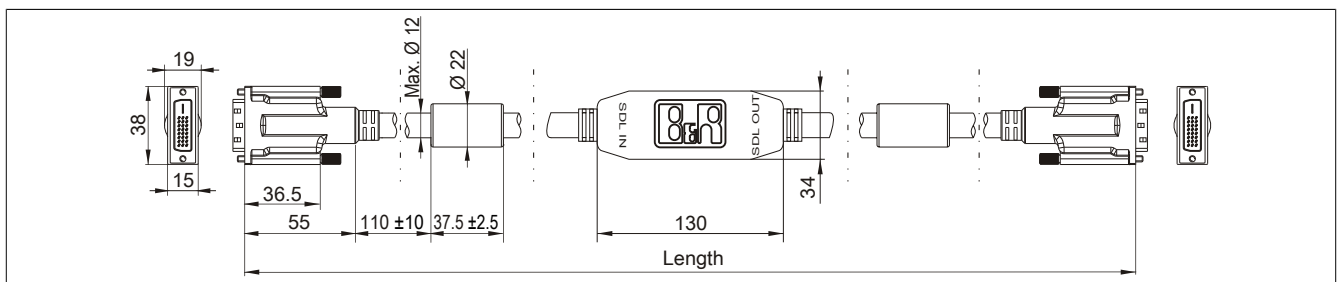

Figure 101: 5CASDL.0xx0-13 - Dimensions

6.4.1.6 Cable pinout

Warning!

Field-assembled cables must be wired according to these specifications.

If a field-assembled cable is used, B&R cannot guarantee that it will function properly. All cables provided by B&R are guaranteed to function properly, however.

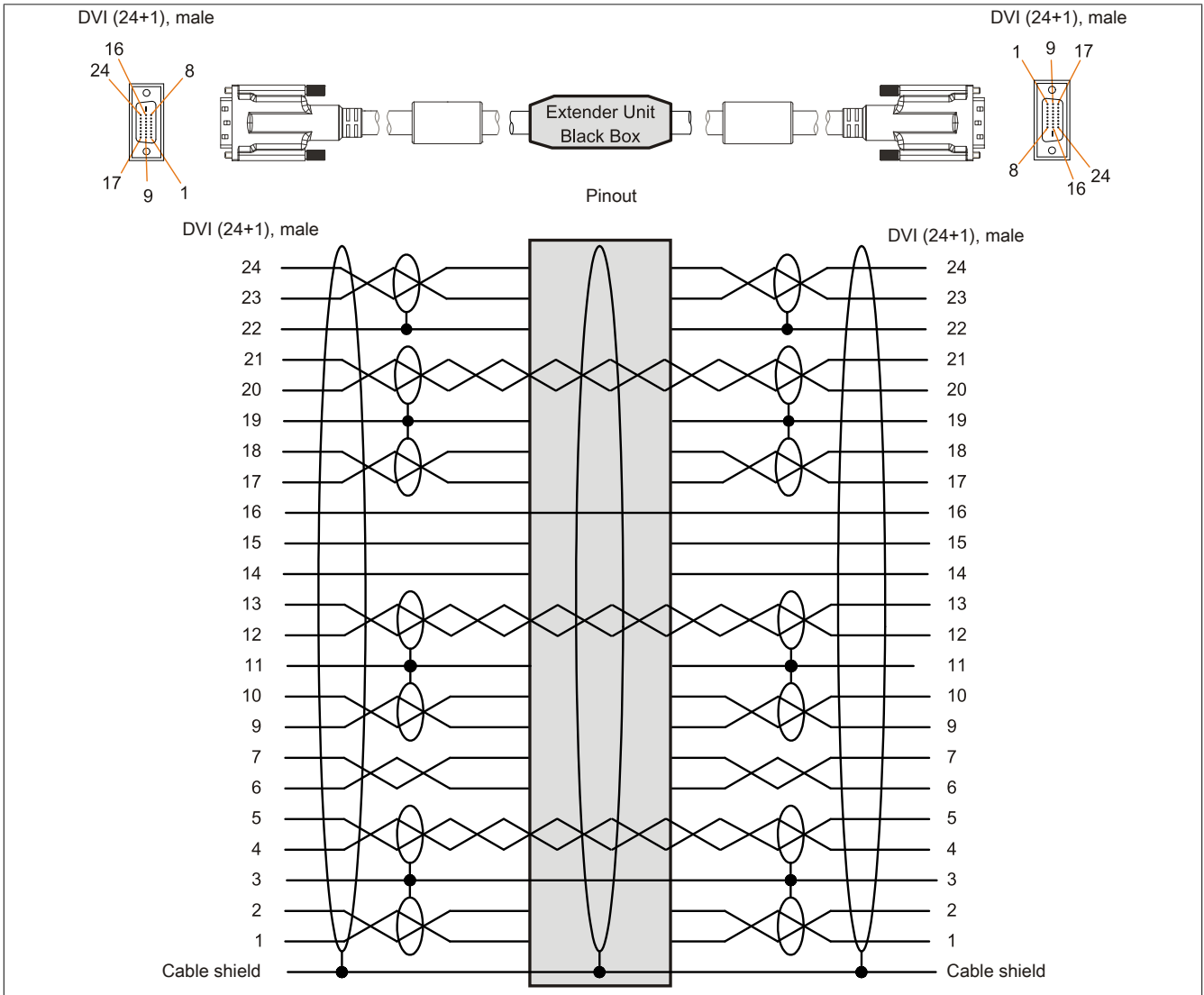

Figure 102: 5CASDL.0xx0-13 - Pinout

6.4.1.7 Cable connection

SDL flex cables with an extender must be connected between the B&R Industrial PC and the Automation Panel display unit in the correct direction. The proper signal direction is indicated on the extender.

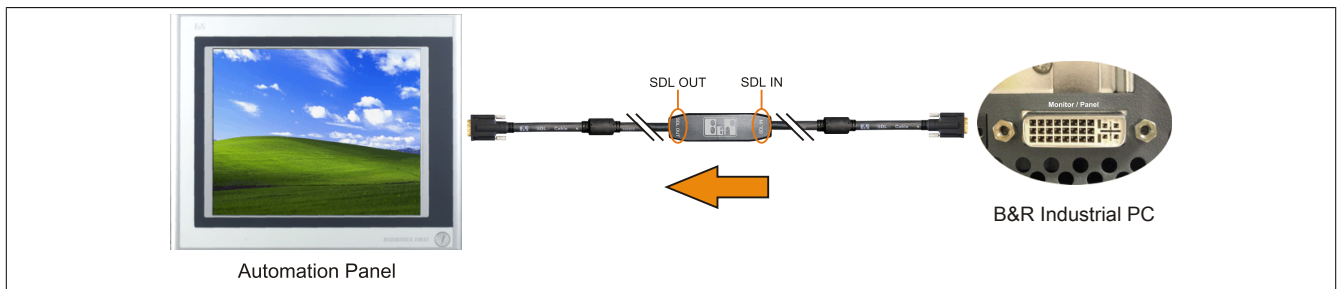

Figure 103: Example of the signal direction for an SDL flex cable with extender

6.5 SDL cables with 45° male connector

6.5.1 5CASDL.0xxx-01

6.5.1.1 General information

5CASDL.0xxx-01 SDL cables with a 45° connector are designed for use in inflexible applications.

Caution!

Power must be disconnected before connecting or disconnecting cables.

6.5.1.2 Order data

Model number	Short description	Figure
	SDL cables with 45° connectors	
5CASDL.0018-01	SDL cable - 45° connector - 1.8 m	
5CASDL.0050-01	SDL cable with 45° male connector, 5 m	
5CASDL.0100-01	SDL cable with 45° male connector, 10 m	
5CASDL.0150-01	SDL cable with 45° male connector, 15 m	

Table 189: 5CASDL.0018-01, 5CASDL.0050-01, 5CASDL.0100-01, 5CASDL.0150-01 - Order data

6.5.1.3 Technical data

Product ID	5CASDL.0018-01	5CASDL.0050-01	5CASDL.0100-01	5CASDL.0150-01
General information				
Certification				
CE			Yes	
cULus			Yes	
GOST-R			Yes	
GL			Yes ¹⁾	
Cable construction				
Wire cross section	AWG 28		AWG 24	
Shield	Individual cable pairs and entire cable			
Complete shielding	Tinned copper braiding, optical coverage >85%			
Outer sheathing				
Material	PVC			
Color	Black			
Connector				
Type	2x DVI-D (24+1), male			
Connection cycles	100			
Contacts	Gold-plated			
Mechanical protection	Metal cover with crimped stress relief			
Locating screw tightening torque	Max. 0.5 Nm			
Electrical characteristics				
Conductor resistance				
AWG 24	-		≤93 Ω/km	
AWG 28	≤237 Ω/km		-	
Insulation resistance	Min. 10 MΩ/km			
Mechanical characteristics				
Dimensions				
Length	1.8 m ±30 mm	5 m ±50 mm	10 m ±100 mm	15 m ±100 mm
Diameter	Max. 9 mm		Max. 11.5 mm	
Flex radius	≥5x cable diameter (male connector - ferrite bead and ferrite bead - ferrite bead)			
Fixed installation				
Flexibility	Limited flexibility, valid for ferrite bead - ferrite bead (tested 100 cycles with 5x cable diameter, 20 cycles/minute)			
Weight	Approx. 300 g	Approx. 590 g	Approx. 2800 g	Approx. 2860 g

Table 190: 5CASDL.0018-01, 5CASDL.0050-01, 5CASDL.0100-01, 5CASDL.0150-01 - Technical data

1) Yes, although applies only if all components installed within the complete system have this certification.

6.5.1.4 Flex radius specifications

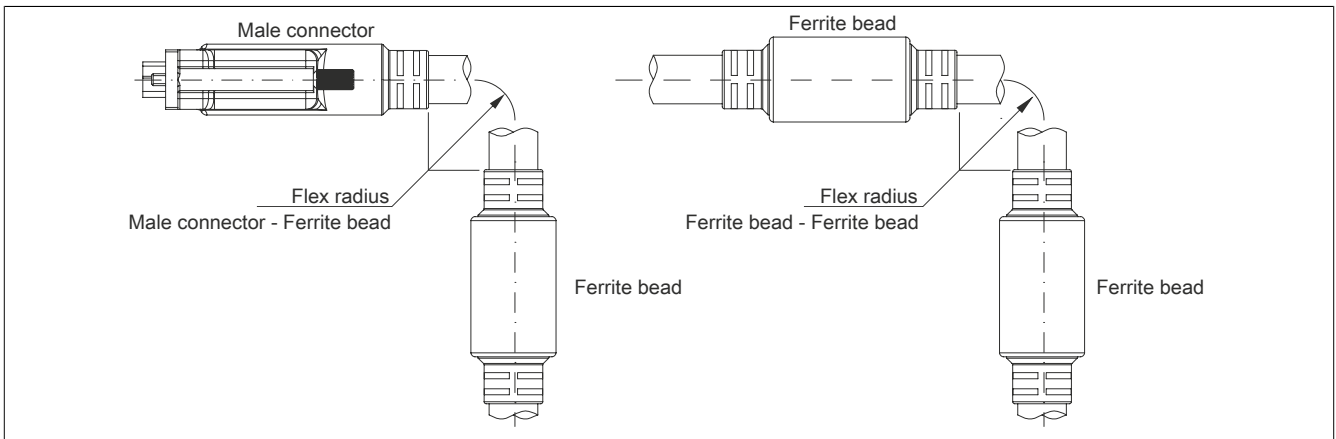

Figure 104: Flex radius specifications

6.5.1.5 Dimensions

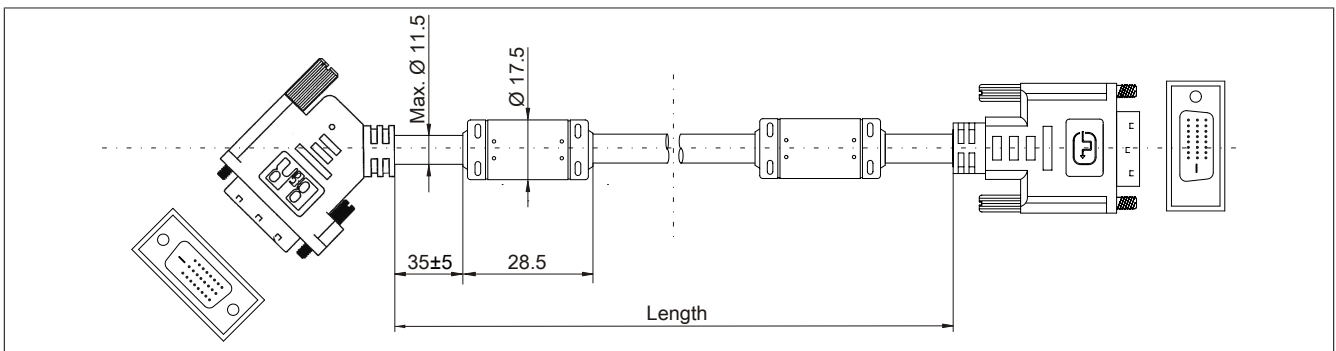

Figure 105: 5CASDL.0xxx-01 - Dimensions

6.5.1.6 Cable pinout

Warning!

Field-assembled cables must be wired according to these specifications.

If a field-assembled cable is used, B&R cannot guarantee that it will function properly. All cables provided by B&R are guaranteed to function properly, however.

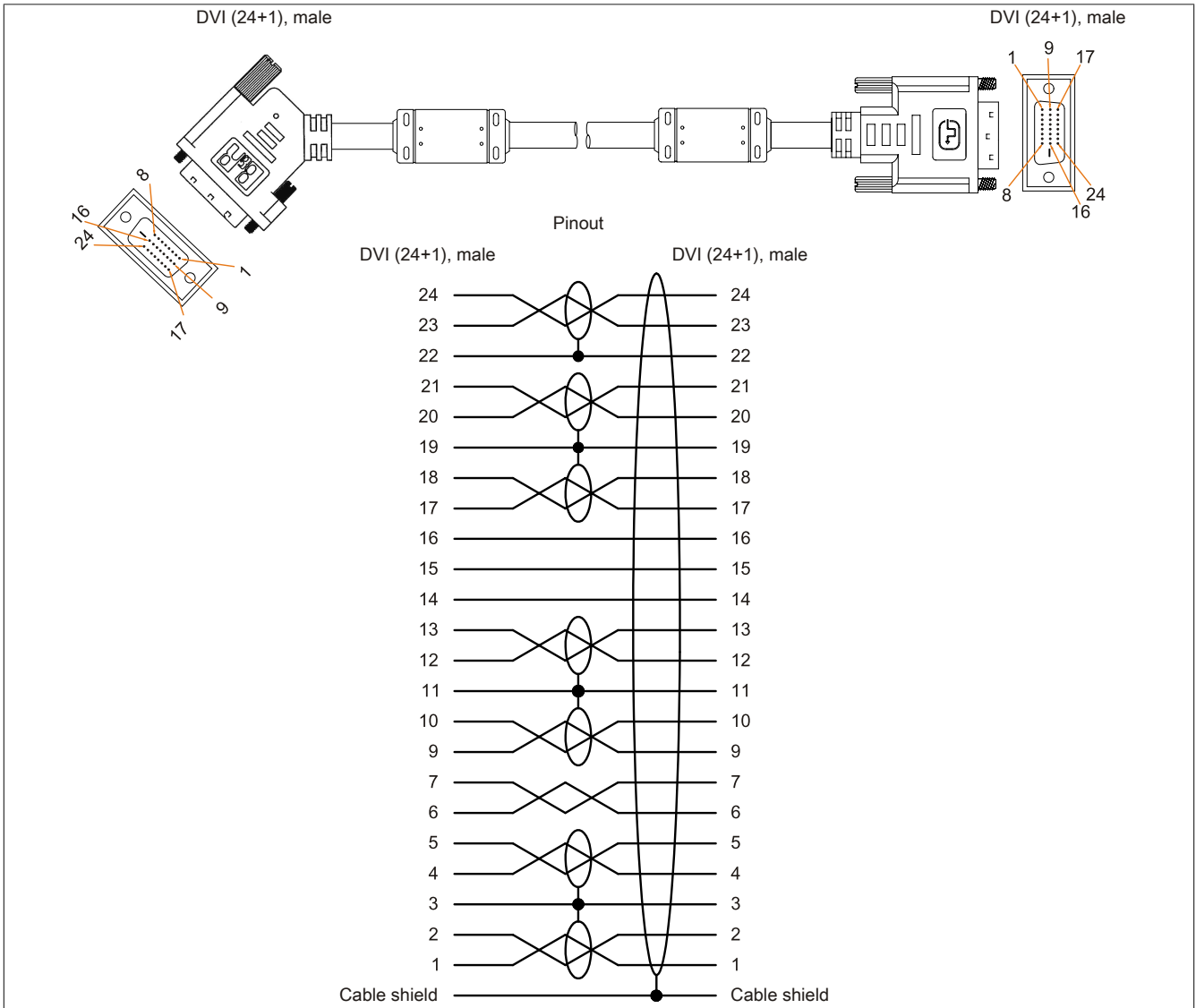

Figure 106: 5CASDL.0xxx-01 - Pinout

6.6 USB cables

6.6.1 5CAUSB.00xx-00

6.6.1.1 General information

USB cables are designed to achieve USB 2.0 transfer speeds.

6.6.1.2 Order data

Model number	Short description	Figure
	USB cables	
5CAUSB.0018-00	USB 2.0 connection cable type A - type B, 1.8 m	
5CAUSB.0050-00	USB 2.0 connection cable type A - type B, 5 m	

Table 191: 5CAUSB.0018-00, 5CAUSB.0050-00 - Order data

6.6.1.3 Technical data

Product ID	5CAUSB.0018-00	5CAUSB.0050-00
General information		
Certification		
CE		Yes
cULus		Yes
GOST-R		Yes
Cable construction		
Wire cross section		AWG 24, 28
Shield		Entire cable
Outer sheathing		
Color		Beige
Connector		
Type	USB type A male and USB type B male	
Mechanical characteristics		
Dimensions		
Length	1.8 m ±30 mm	5 m ±50 mm
Diameter		Max. 5 mm
Flex radius		Min. 100 mm

Table 192: 5CAUSB.0018-00, 5CAUSB.0050-00 - Technical data

6.6.1.4 Cable pinout

Warning!

Field-assembled cables must be wired according to these specifications.

If a field-assembled cable is used, B&R cannot guarantee that it will function properly. All cables provided by B&R are guaranteed to function properly, however.

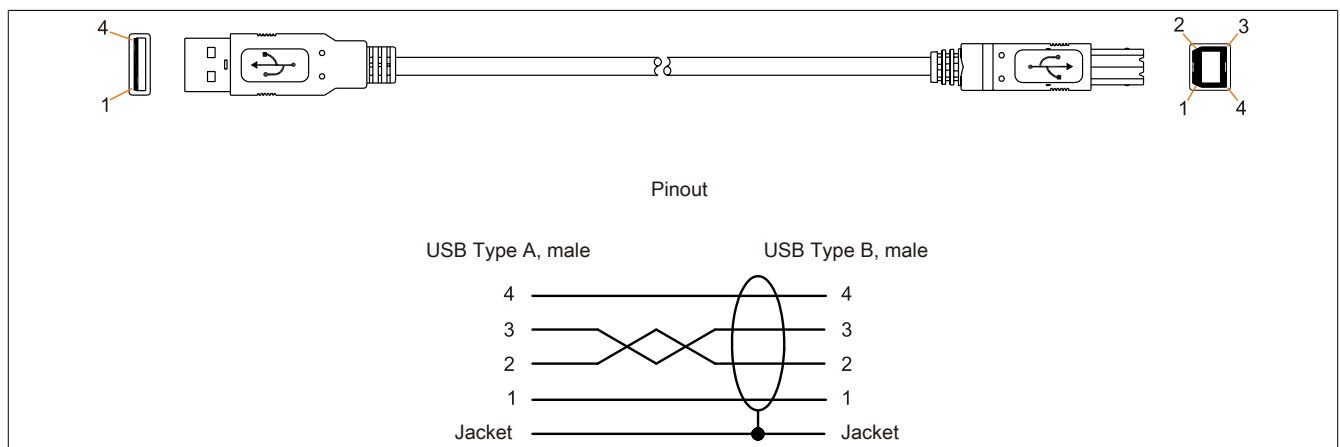

Figure 107: 5CAUSB.00xx-00 USB cables - Pinout

6.7 RS232 cables

6.7.1 9A0014.xx

6.7.1.1 General information

RS232 cables are used as extension cables between two RS232 interfaces.

6.7.1.2 Order data

Model number	Short description	Figure
	RS232 cables	
9A0014.02	RS232 extension cable for remote operation of a display unit with touch screen, 1.8 m	
9A0014.05	RS232 extension cable for remote operation of a display unit with touch screen, 5 m	
9A0014.10	RS232 extension cable for remote operation of a display unit with touch screen, 10 m	

Table 193: 9A0014.02, 9A0014.05, 9A0014.10 - Order data

6.7.1.3 Technical data

Product ID	9A0014.02	9A0014.05	9A0014.10
General information			
Certification		Yes	Yes
CE			
GOST-R	-		
Cable construction			
Wire cross section		AWG 26	
Shield		Entire cable	
Outer sheathing			
Color		Beige	
Connector			
Type		9-pin male/female DSUB connector	
Locating screw tightening torque		Max. 0.5 Nm	
Mechanical characteristics			
Dimensions			
Length	1.8 m ±50 mm	5 m ±80 mm	10 m ±100 mm
Diameter		Max. 5 mm	
Flex radius		Min. 70 mm	

Table 194: 9A0014.02, 9A0014.05, 9A0014.10 - Technical data

6.7.1.4 Cable pinout

Warning!

Field-assembled cables must be wired according to these specifications.

If a field-assembled cable is used, B&R cannot guarantee that it will function properly. All cables provided by B&R are guaranteed to function properly, however.

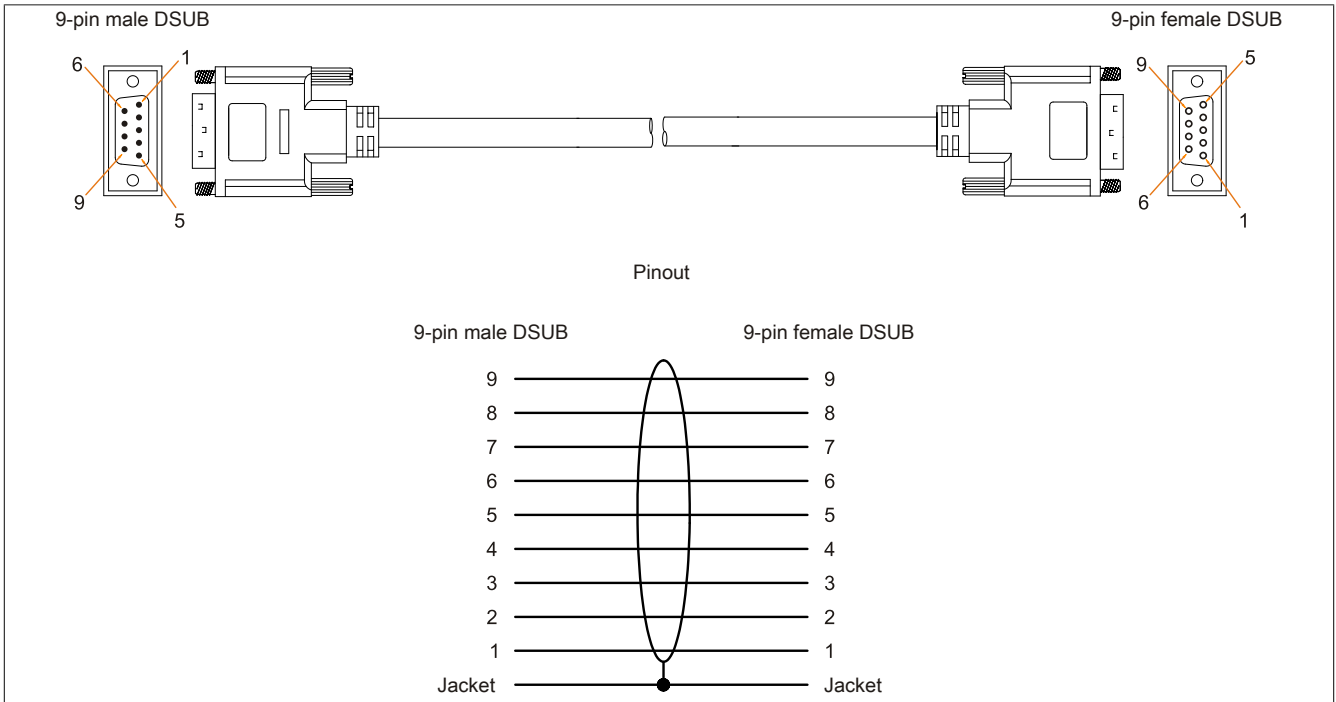

Figure 108: 9A0014.xx RS232 cables - Pinout

7 HMI Drivers & Utilities DVD

7.1 5SWHMI.0000-00

7.1.1 General information

This DVD contains drivers, utilities, software upgrades and user's manuals for B&R panel system products (see the "Industrial PCs" or "Visualization and operation" section of the B&R website at www.br-automation.com).

When the DVD is created, its contents are identical to the files found in the Downloads section of the B&R website (Service / Material-related downloads).

7.1.2 Order data

Model number	Short description	Figure
5SWHMI.0000-00	<p>Other</p> <p>HMI Drivers & Utilities DVD</p>	

Table 195: 5SWHMI.0000-00 - Order data

7.1.3 Contents (V2.20)

BIOS product upgrades

- Automation PC 620 / Panel PC 700 CPU board 815E and 855GME BIOS
- Automation PC 620 / Panel PC 700 CPU board X855GME BIOS
- Automation PC 620 / Panel PC 700 CPU board 945GME BIOS
- Automation PC 620 / Panel PC 700 CPU board 945GME N270 BIOS
- Automation PC 680
- Automation PC 810 / Automation PC 820 / Panel PC 800 B945GME BIOS
- Automation PC 810 / Panel PC 800 945GME N270 CPU board BIOS
- Automation PC 810 / Panel PC 800 GM45 CPU board BIOS
- Provit 2000 product family - IPC2000/2001/2002
- Provit 5000 product family - IPC5000/5600/5000C/5600C
- Power Panel 100 BIOS devices
- Mobile Panel 100 BIOS devices
- Power Panel 100 / Mobile Panel 100 user boot logo
- Power Panel 100 / Mobile Panel 100 REMHOST utility
- Power Panel 300/400 BIOS devices
- Power Panel 300/400 BIOS user boot logo
- Power Panel 500 / Automation PC 510 / Automation PC 511 BIOS
- Panel PC 310

Device drivers

- Automation Device Interface (ADI)
- Audio
- Chipset
- CD-ROM
- LS120

- Graphics
- Network
- PCI / SATA RAID controller
- Touch screen
- Touchpad
- Interface board

Firmware upgrades

- Automation PC 620 / Panel PC 700 (MTCX, SDLR, SDLT)
- Automation PC 810 (MTCX, SDLR, SDLT)
- Automation PC 820 (MTCX, SDLR, SDLT)
- Mobile Panel 100 (SMCX)
- Panel PC 300 (MTCX)
- Power Panel 100 (aPCI)
- Power Panel 300/400 (aPCI)
- Power Panel 300/400 (MTCX)
- Power Panel 500 / Automation PC 510 / Automation PC 511 (MTCX, SDLR, I/O board)
- Panel PC 800 (MTCX, SDLR, SDLT)
- UPS firmware

Utilities/Tools

- B&R Embedded OS Installer
- Windows CE Tools
- User boot logo conversion program
- SATA RAID Installation Utility
- Automation Device Interface (ADI)
- CompactFlash service life calculator (Silicon Systems)
- Miscellaneous
- MTC utilities
- B&R Key Editor
- MTC & Mkey utilities
- Mkey utilities
- UPS configuration software
- ICU ISA configuration
- Intel PCI NIC boot ROM
- Diagnostic programs

Windows

- Windows CE 6.0
- Windows CE 5.0
- Windows CE 4.2
- Windows CE 4.1
- Windows CE Tools
- Windows Embedded Standard 2009
- Windows Embedded Standard 7
- Thin client
- Windows NT Embedded
- Windows XP Embedded
- VNC viewer

MCAD templates for

- Industrial PCs
- Visualization and operating devices
- Slide-in label templates
- Custom designs

ECAD templates for

- Industrial PCs
- Automation PCs
- Automation Panel 900
- Panels (Power Panel)

Documentation for

- Automation PC 511
- Automation PC 620
- Automation PC 680
- Automation PC 810
- Automation PC 820
- Automation Panel 800
- Automation Panel 900
- Panel PC 310
- Panel PC 700
- Panel PC 725
- Panel PC 800
- Power Panel 15/21/35/41
- Power Panel 100/200
- Power Panel 300/400
- Power Panel 500
- Mobile Panel 40/50
- Mobile Panel 100/200
- Mobile Panel connection box
- Provit 2000
- Provit 3030
- Provit 4000
- Provit 5000
- Provit Benchmark
- Provit Mkey
- Windows CE 5.0 help documentation
- Windows CE 6.0 help documentation
- Windows NT Embedded application guide
- Windows XP Embedded application guide
- Uninterruptible power supply
- Implementation guides
- B&R Hilscher fieldbus cards (CANopen, DeviceNet, PROFIBUS, PROFINET)

Service tools

- Acrobat Reader 5.0.5 (freeware in German, English and French)
- Power Archiver 6.0 (freeware in German, English and French)
- Internet Explorer 5.0 (German and English)
- Internet Explorer 6.0 (German and English)

Chapter 7 • Maintenance and service

This chapter describes service/maintenance work that can be carried out by a qualified end user.

1 Replacing the battery

The lithium battery buffers the internal real-time clock (RTC) and CMOS data.

Information:

- The product design allows the battery to be changed with the B&R device switched either on or off. In some countries, safety regulations do not allow batteries to be changed while the module is switched on.
- Any BIOS settings that have been made will remain when the battery is changed with the power turned off (stored in nonvolatile EEPROM). The date and time must be reset later since this data is lost when the battery is changed.
- The battery should only be replaced by qualified personnel.

Warning!

The battery is only permitted to be replaced by a Renata CR2477N battery. The use of another battery may present a risk of fire or explosion.

The battery may explode if handled improperly. Do not recharge, disassemble or dispose of in fire.

The following replacement lithium batteries are available: 4A0006.00-000 (1 pc.) and 0AC201.91 (4 pcs.).

1.1 Evaluating the battery status

The status of the battery is determined immediately after the device is started and subsequently checked by the system every 24 hours. During this measurement, the battery is subjected to a brief load (approximately 1 second) and then evaluated. Once determined, the battery status is displayed in BIOS (Advanced - OEM features - System board features - Voltage values) and in the B&R Control Center (ADI driver); it can also be read in a customer application using the ADI library.

Battery status	Function
N/A	The hardware or firmware being used is too old and does not support reading the battery status.
GOOD	Data buffering is intact.
BAD	From the point when battery capacity is recognized as insufficient (BAD), data buffering is intact for approximately another 500 hours.

Table 196: Battery status

From the point when battery capacity is recognized as insufficient, data buffering is intact for approximately another 500 hours. When replacing the battery, data is buffered for approximately 10 minutes by a gold leaf capacitor.

1.2 Procedure

- Disconnect the power supply to the B&R Industrial PC.
- Touch the housing or ground connection in order to discharge any electrostatic charge from your body.
- Remove the cover from the battery compartment and carefully pull out the battery using the removal strip.

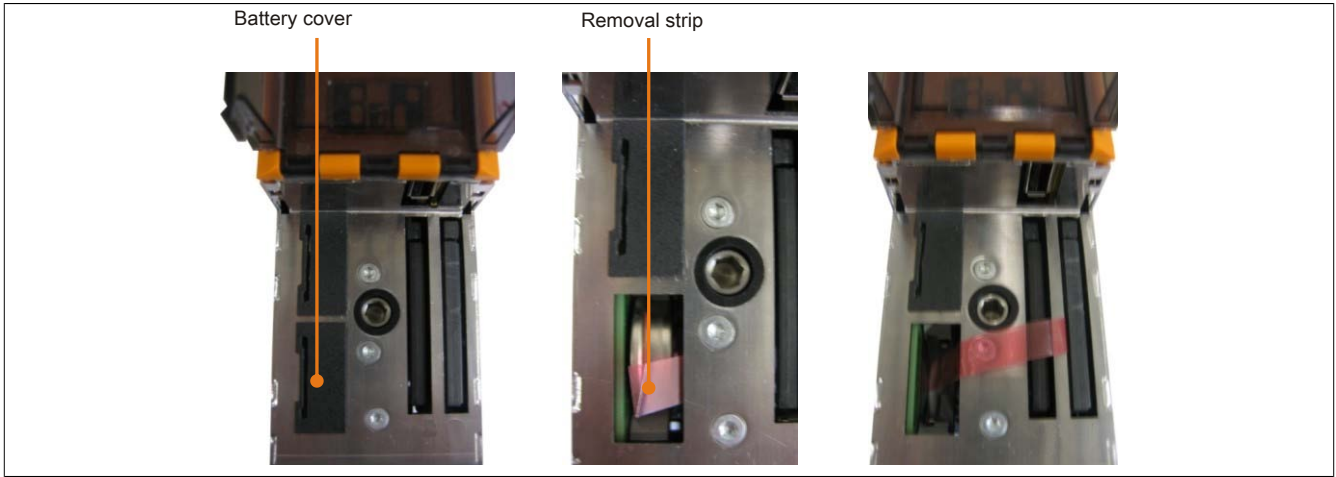

Figure 109: Removing the battery

- The battery should not be held by its edges. Insulated tweezers may also be used to insert the battery.

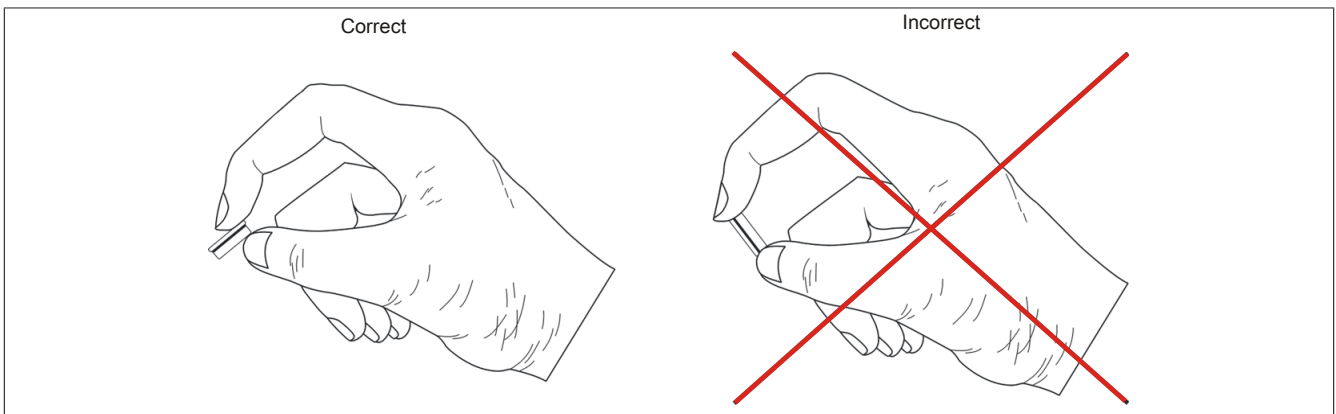

Figure 110: Battery handling

- Insert the new battery with the correct polarity.

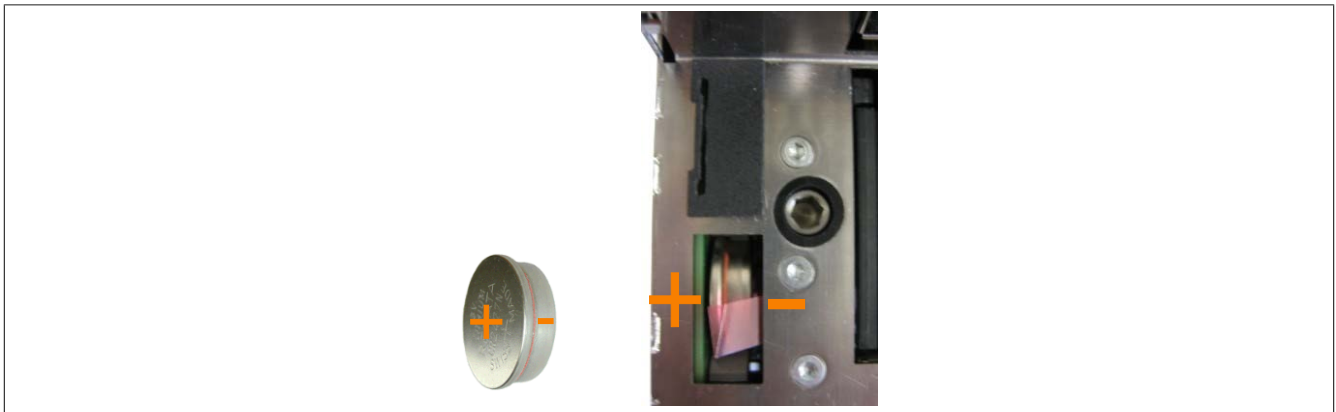

Figure 111: Battery polarity

- To make the next battery replacement easier, be sure the removal strip is in place when inserting the battery.
- Reconnect the power supply to the B&R Industrial PC (plug in the power cable).
- Reset the date and time in BIOS.

Warning!

Lithium batteries are considered hazardous waste. Used batteries should be disposed of in accordance with applicable local regulations.

2 Replacing a CompactFlash card

Caution!

Power must be turned off before replacing CompactFlash cards.

The CompactFlash card can be replaced quickly and easily by pressing the ejector (see image) with a pointed object such as a pen.

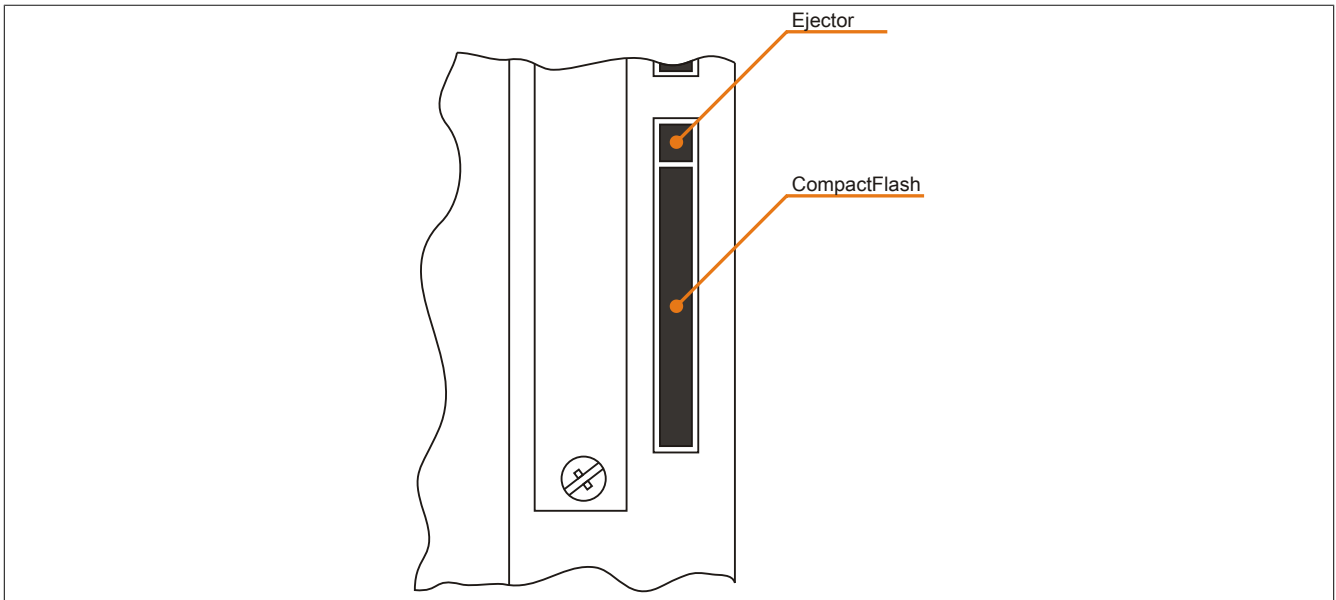

Figure 112: CompactFlash + ejector

3 Changing the fan

3.1 Procedure

- Cut off power supply to the Automation PC 820 (disconnect from the ACOPOSmulti rail).
- Touch the housing or ground connection in order to discharge any electrostatic charge from your body.
- Remove the fan from the holder. To do this, simply press the snap arms inward and carefully remove the fan from the housing.



Figure 113: Removing the fan

- Disconnect the fan cable and remove the fan.

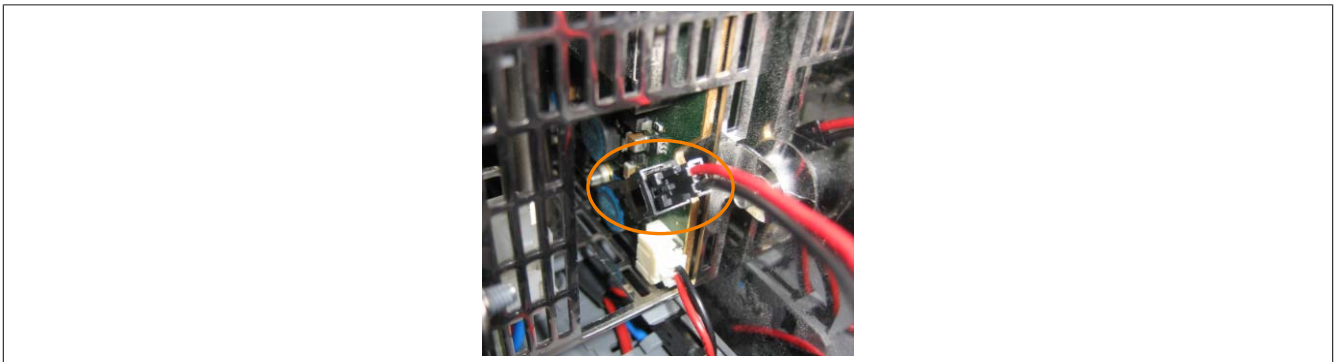

Figure 114: Disconnecting the fan cable

- Install the replacement fan in reverse order.

Appendix A

1 Maintenance Controller Extended (MTCX)

The MTCX controller (FPGA processor) is located on the mainboard (part of every system unit) of the APC820 device.

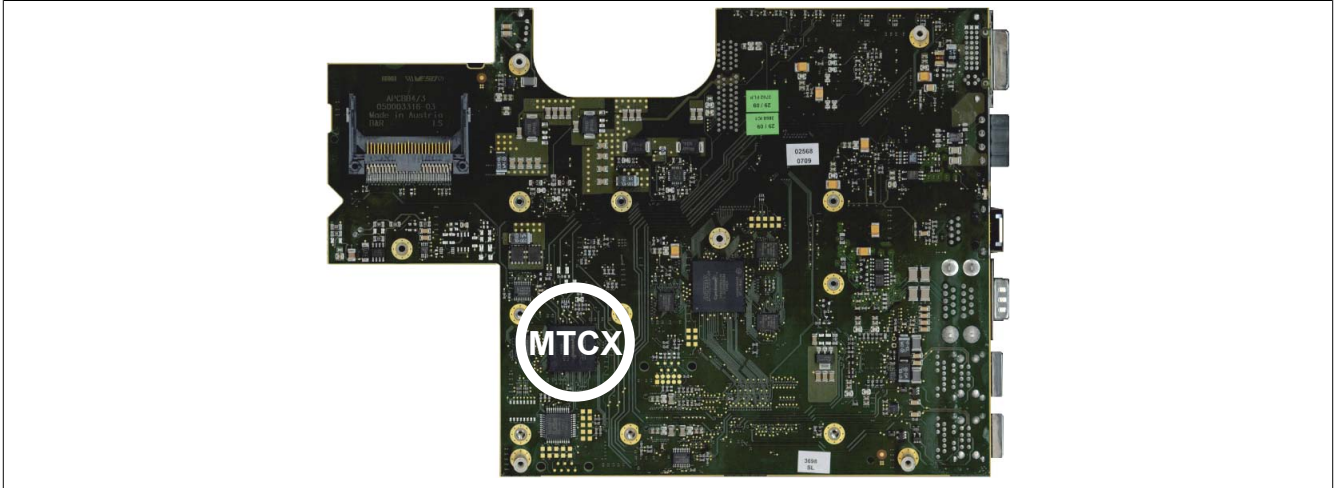

Figure 115: MTCX controller location

The MTCX is responsible for the following monitoring and control functions:

- Power on (power OK sequencing) and power failure logic
- Watchdog handling (NMI and reset handling)
- Temperature monitoring
- Fan control
- Key and LED handling/coordination (matrix keyboard on B&R display units)
- Advanced desktop operation (keys, USB forwarding)
- Daisy chain display operation (touch screen, USB forwarding)
- Panel locking mechanism (can be configured using B&R Control Center - ADI driver)
- Backlight control for connected B&R displays
- Statistical data recording (power cycles - records every switch-on, power on and fan hour; each full hour is counted, i.e. not increased at 50 minutes)
- SDL data transfer (display, matrix keyboard, touch screen, service data, USB)
- Status LEDs (CF, Link)

Extended MTCX functions are available by upgrading firmware ¹⁾. The version can be read in BIOS ("Advanced" - Baseboard/Panel Features) or in approved Microsoft Windows operating systems with the B&R Control Center.

¹⁾ Available in the Downloads section of the B&R website (www.br-automation.com).

1.1 Temperature monitoring Fan control

The MTCX constantly monitors the temperature using temperature sensors (see "Temperature sensor locations" on page 22), which directly determines how the fans are controlled. The speed depends on the measured temperature.

Sensor range	Startup temperature	Max. fan speed at:
CPU	70°C	86°C
Baseboard Out	65°C	81°C
Baseboard Center	65°C	81°C
Baseboard In	54°C	70°C
Power supply	65°C	81°C
IF slot (PCIec card slot)	65°C	81°C

Table 197: Temperature limits of the fan (MTCX PX32 V0.05).

The fans are only switched off again when the evaluated temperature remains 6°C below the start-up temperature for a time span of 30 minutes (=lag-time).

2 Abbreviations

Abbreviation	Stands for	Description
NC	Normally closed	A normally closed relay contact
	Not connected	Used in pinout descriptions if a terminal or pin is not connected to a module
ND	Not defined	In data tables, this stands for a value that has not been defined. This may be because a cable manufacturer does not provide certain technical data, for example.
NO	Normally open	A normally open relay contact
TBD	To be defined	Used in technical data tables when certain information is not yet available. The value will be provided later.

Table 198: Abbreviations in this user's manual

3 Glossary

Address	An address is a character string for identifying a memory location or a memory area, where data is stored and can be retrieved. It is also a symbol (e.g. with numerical controllers) for identifying a function unit for which subsequent geometrical or technological data are determined by the symbol.
Algorithms	<p>According to DIN 19226: Algorithms are a finite series of well-defined regulations. The desired output quantities are created from permitted system input quantities. It describes how something is to be done. A procedure must at least satisfy the following requirements to be valid as an algorithm in a mathematical context.</p> <p><i>Discreteness:</i> An algorithm is made up of a finite series of steps.</p> <p><i>Determinacy:</i> Under the same start conditions, it always creates the same end result.</p> <p><i>Clearness:</i> The series of steps is clearly defined.</p> <p><i>Finiteness:</i> It ends after a finite number of steps.</p> <p>From a quantity theory perspective, an algorithm is clearly defined by a set of sizes [input, intermediate and output sizes], a set of elementary operations and also by a regulation, which specifies when and in what sequence certain operations should be carried out. From a functional perspective, it transfers a set of input sizes into a set of output sizes. It can be represented in text form in a natural or artificial formal language or using graphic representations [graph, program flow chart, structured chart, Petri Nets etc.].</p>
Analog Signal	A signal, whose information parameters can accept any number of values, within specific technical limits. Theoretically, they can have an infinitely high resolution. However, in practice it is limited to a range of only 1 to 104. In addition, long-term storage and allocation causes many size problems. Therefore, digital signals are predominantly used in modern automation technology.
ANSI	American National Standards Institute > this organization promotes and manages American industrial standards.
APC	Abbreviation for »Automation PC«
Application software	Software, which is not used for operation by the computer itself, but rather when a computer is used to process a concrete application problem. It sets up the system software and uses this for fulfilling individual tasks. Application software can be accommodated in standard software used by a large number of customers in a wide range of industries. Common examples are Word, Excel, PowerPoint, Paint, Matlab etc. Industrial software tailored to the respective problems of a certain industry and individual software created for solving the particular problems of an individual user.
Automation	According to Brockhaus: The application of technical means, using specific programs that (either partially or totally) do not require human intervention to perform operations.
Automation Runtime	A uniform runtime system for all B&R automation components.
Failure	Failure according to IEC 61508: A function unit loses the ability to perform a required function. In regards to safety-oriented systems, a distinction is made between dangerous and safe failures. This depends on whether the status of the system failure is considered dangerous or safe. The cause of the failure may be load related or age-related, and therefore a random failure, or related to a flaw inherent in the system. In this case, it is known as a systematic failure.

Figure 1:	Configuration - Base system.....	19
Figure 2:	Configuration - Optional components.....	20
Figure 3:	Temperature sensor position.....	22
Figure 4:	Supply voltage block diagram.....	24
Figure 5:	Block diagram - Automation PC 820.....	26
Figure 6:	RS232/RS422/RS485 interface - Operation in RS485 mode.....	33
Figure 7:	APC820 interface overview - Front side ≤ A0.....	44
Figure 8:	APC820 interface overview - Front side ≥ A1.....	45
Figure 9:	APC820 LED description - Front side ≥ A1.....	46
Figure 10:	APC820 interface overview - Top side ≤ A0.....	47
Figure 11:	APC820 interface overview - Top side ≥ A1.....	48
Figure 12:	5PC820.SX01-00 - Dimensions.....	52
Figure 13:	5PC820.SX01-01 - Dimensions.....	56
Figure 14:	PCI Express compact plug-in cards - Dimensions.....	63
Figure 15:	POWERLINK card - 2-port node number switch.....	69
Figure 16:	Integrating the POWERLINK plug-in card in Automation Studio.....	69
Figure 17:	Installation.....	70
Figure 18:	Permitted mounting orientations.....	72
Figure 19:	Spacing for air circulation.....	73
Figure 20:	Swivel range of the front cover.....	74
Figure 21:	Attaching modules.....	75
Figure 22:	Tightening the fastening screws.....	75
Figure 23:	Flex radius - Cable connection.....	76
Figure 24:	One Automation Panel 900 via DVI.....	78
Figure 25:	One Automation Panel 900 via SDL.....	80
Figure 26:	One Automation Panel 800 via SDL.....	82
Figure 27:	One AP900 and one AP800 via SDL.....	84
Figure 28:	Four Automation Panel 900 units via SDL.....	86
Figure 29:	Local connection of USB peripheral devices on the APC820.....	88
Figure 30:	Remote connection of USB peripheral devices on the APC900 via DVI.....	89
Figure 31:	Remote connection of USB peripheral devices on the APC800/900 via SDL.....	89
Figure 32:	Boot Screen.....	92
Figure 33:	BIOS Main Menü.....	94
Figure 34:	945GME Advanced Menü.....	95
Figure 35:	945GME Advanced ACPI Configuration.....	96
Figure 36:	945GME Advanced PCI Configuration.....	97
Figure 37:	945GME Advanced PCI IRQ Resource Exclusion.....	98
Figure 38:	945GME Advanced PCI Interrupt Routing.....	99
Figure 39:	945GME Advanced PCI Express Configuration.....	100
Figure 40:	945GME Advanced Graphics Configuration.....	102
Figure 41:	945GME Advanced CPU Configuration.....	104
Figure 42:	945GME Advanced Chipset Configuration.....	105
Figure 43:	945GME Advanced I/O Interface Configuration.....	106
Figure 44:	945GME Advanced Clock Configuration.....	107
Figure 45:	945GME Advanced IDE Configuration.....	107
Figure 46:	945GME Primary IDE Master.....	108
Figure 47:	945GME Primary IDE Slave.....	109
Figure 48:	945GME Secondary IDE Master.....	110
Figure 49:	945GME Secondary IDE Slave.....	111
Figure 50:	945GME Advanced USB Configuration.....	112
Figure 51:	945GME Advanced Keyboard/Mouse Configuration.....	114
Figure 52:	945GME Advanced Remote Access Configuration.....	114
Figure 53:	945GME Advanced CPU Board Monitor.....	116
Figure 54:	945GME Advanced Baseboard/Panel Features.....	117
Figure 55:	945GME Panel Control.....	118
Figure 56:	945GME Baseboard Monitor.....	119
Figure 57:	945GME Legacy Devices.....	120

Figure 58:	945GME Boot Menü.....	121
Figure 59:	945GME Security Menü.....	122
Figure 60:	945GME Hard Disk Security User Password.....	123
Figure 61:	945GME Hard Disk Security Master Password.....	124
Figure 62:	945GME Power Menü.....	124
Figure 63:	945GME Exit Menü.....	126
Figure 64:	Interrupt routing for BIOS up to V1.12.....	136
Figure 65:	Interrupt routing for BIOS starting with V1.14.....	136
Figure 66:	Softwareversion.....	137
Figure 67:	Firmware version of the AP Link SDL transmitter.....	138
Figure 68:	Creating a bootable diskette in Windows XP - Step 1.....	142
Figure 69:	Creating a bootable diskette in Windows XP - Step 2.....	142
Figure 70:	Creating a bootable diskette in Windows XP - Step 3.....	142
Figure 71:	Creating a bootable diskette in Windows XP - Step 4.....	143
Figure 72:	Creating a bootable diskette in Windows XP - Step 5.....	143
Figure 73:	Creating a USB flash drive for B&R upgrade files.....	144
Figure 74:	Creating a CompactFlash card for B&R upgrade files.....	145
Figure 75:	ADI Control Center screenshots - Examples.....	158
Figure 76:	ADI Development Kit Screenshots (Version 3.70).....	160
Figure 77:	ADI .NET SDK screenshots (version 2.10).....	162
Figure 78:	B&R Key Editor screenshots (version 3.50).....	164
Figure 79:	5CFCRD.xxxx-06 - Temperature/Humidity diagram for CompactFlash cards.....	177
Figure 80:	Type I CompactFlash card - Dimensions.....	177
Figure 81:	ATTO Disk Benchmark v2.34 read comparison - 5CFCRD.xxxx-04 and 5CFCRD.xxxx-06.....	178
Figure 82:	ATTO Disk Benchmark v2.34 write comparison - 5CFCRD.xxxx-04 and 5CFCRD.xxxx-06.....	178
Figure 83:	5CFCRD.xxxx-04 - Temperature/Humidity diagram for CompactFlash cards.....	181
Figure 84:	Type I CompactFlash card - Dimensions.....	181
Figure 85:	ATTO Disk Benchmark v2.34 read comparison - 5CFCRD.xxxx-03 and 5CFCRD.xxxx-04.....	182
Figure 86:	ATTO Disk Benchmark v2.34 write comparison - 5CFCRD.xxxx-03 and 5CFCRD.xxxx-04.....	182
Figure 87:	5CFCRD.xxxx-03 - Temperature/Humidity diagram for CompactFlash cards.....	185
Figure 88:	Type I CompactFlash card - Dimensions.....	185
Figure 89:	5MMUSB.2048-00 - Temperature/Humidity diagram.....	188
Figure 90:	5MMUSB.xxxx-01 - Temperature/Humidity diagram.....	190
Figure 91:	Flex radius specifications.....	192
Figure 92:	5CADVI.0xxx-00 - Dimensions.....	192
Figure 93:	5CADVI.0xxx-00 - Pinout.....	193
Figure 94:	Flex radius specifications.....	195
Figure 95:	5CASDL.0xxx-00- Dimensions.....	195
Figure 96:	5CASDL.0xxx-00 - Pinout.....	196
Figure 97:	Flex radius specifications.....	198
Figure 98:	5CASDL.0xxx-03 - Dimensions.....	198
Figure 99:	5CASDL.0xxx-03 - Pinout.....	199
Figure 100:	Flex radius specification with extender.....	201
Figure 101:	5CASDL.0xx0-13 - Dimensions.....	201
Figure 102:	5CASDL.0xx0-13 - Pinout.....	202
Figure 103:	Example of the signal direction for an SDL flex cable with extender.....	203
Figure 104:	Flex radius specifications.....	205
Figure 105:	5CASDL.0xxx-01 - Dimensions.....	205
Figure 106:	5CASDL.0xxx-01 - Pinout.....	206
Figure 107:	5CAUSB.00xx-00 USB cables - Pinout.....	207
Figure 108:	9A0014.xx RS232 cables - Pinout	209
Figure 109:	Removing the battery.....	214
Figure 110:	Battery handling.....	214
Figure 111:	Battery polarity.....	214

Figure 112:	CompactFlash + ejector.....	215
Figure 113:	Removing the fan.....	216
Figure 114:	Disconnecting the fan cable.....	216
Figure 115:	MTCX controller location.....	217

Table 1:	Manual history.....	9
Table 2:	Environmentally friendly separation of materials.....	13
Table 3:	Description of the safety notices used in this documentation.....	14
Table 4:	Range of nominal sizes.....	14
Table 5:	Ambient temperature with a fan kit.....	21
Table 6:	Temperature sensor locations.....	22
Table 7:	Humidity specifications.....	23
Table 8:	Power calculation – APC810.....	24
Table 9:	Monitor / Panel connection - RGB, DVI, SDL.....	27
Table 10:	DVI interface - Pinout.....	28
Table 11:	Cable lengths and resolutions for SDL transmission.....	28
Table 12:	Cable lengths and resolutions for DVI transmission.....	28
Table 13:	USB1, USB2, USB3 and USB4 connections.....	29
Table 14:	USB5 interface.....	29
Table 15:	CompactFlash slot (CF1).....	30
Table 16:	CompactFlash slot (CF2).....	30
Table 17:	COM1 - Pinout.....	31
Table 18:	RS232 - Bus length and transfer rate.....	31
Table 19:	RS232 - Cable requirements.....	31
Table 20:	COM2 - Pinout.....	32
Table 21:	RS232/422/485 - I/O address and IRQ.....	32
Table 22:	RS232 - Bus length and transfer rate.....	32
Table 23:	RS232 - Cable requirements.....	32
Table 24:	RS422 - Bus length and transfer rate.....	33
Table 25:	RS422 - Cable requirements.....	33
Table 26:	RS485 - Bus length and transfer rate.....	33
Table 27:	RS485 - Cable requirements.....	34
Table 28:	CAN interface.....	35
Table 29:	CAN node switch (x1, x16).....	35
Table 30:	CAN terminating switch / LED.....	35
Table 31:	Status LED CAN.....	35
Table 32:	POWERLINK interface.....	36
Table 33:	Status/Error LED - Ethernet mode.....	36
Table 34:	Status/Error LED - POWERLINK V1 operating mode.....	36
Table 35:	Status/Error LED - POWERLINK - Error.....	36
Table 36:	Status/Error LED - POWERLINK - Status.....	37
Table 37:	System stop error codes.....	38
Table 38:	POWERLINK node switch (x1, x16).....	38
Table 39:	Ethernet connection (ETH1).....	39
Table 40:	Ethernet interface (ETH2).....	39
Table 41:	Battery.....	40
Table 42:	Battery status.....	40
Table 43:	Hardware security key.....	41
Table 44:	LED status indicators - Data.....	42
Table 45:	CMOS profile switch.....	42
Table 46:	Power button.....	43
Table 47:	Reset button.....	43
Table 48:	5PC820.SX01-00 - Order data.....	49
Table 49:	5PC820.SX01-00 - Technical data.....	49
Table 50:	5PC820.SX01-01 - Order data.....	53
Table 51:	5PC820.SX01-01 - Technical data.....	53
Table 52:	5PC800.B945-00, 5PC800.B945-01, 5PC800.B945-02, 5PC800.B945-03, 5PC800.B945-04 - Order data.....	57
Table 53:	5PC800.B945-10, 5PC800.B945-11, 5PC800.B945-12, 5PC800.B945-13, 5PC800.B945-14 - Order data.....	57
Table 54:	5PC800.B945-00, 5PC800.B945-01, 5PC800.B945-02, 5PC800.B945-03, 5PC800.B945-04 - Technical data.....	58

Table 55:	5PC800.B945-10, 5PC800.B945-11, 5PC800.B945-12, 5PC800.B945-13, 5PC800.B945-14 - Technical data.....	58
Table 56:	5MMDDR.0512-01, 5MMDDR.1024-01, 5MMDDR.2048-01 - Order data.....	60
Table 57:	5MMDDR.0512-01, 5MMDDR.1024-01, 5MMDDR.2048-01 - Technical data.....	60
Table 58:	5AC802.HS00-00, 5AC802.HS00-01 - Order data.....	61
Table 59:	5AC802.HS00-00, 5AC802.HS00-01 - Technical data.....	61
Table 60:	8BXF001.0000-00 - Order data.....	62
Table 61:	8BXF001.0000-00 - Technical data.....	62
Table 62:	5ACPCC.ETH0-00 - Order data.....	64
Table 63:	5ACPCC.ETH0-00 - Technical data.....	64
Table 64:	5ACPCC.ETH0-00 - Ethernet interface.....	64
Table 65:	5ACPCC.MPL0-00 - Order data.....	66
Table 66:	5ACPCC.MPL0-00 - Technical data.....	66
Table 67:	5ACPCC.MPL0-00 - POWERLINK interface.....	67
Table 68:	Status/Error LED - Ethernet mode.....	67
Table 69:	Status/Error LED - POWERLINK V1 operating mode.....	67
Table 70:	Status/Error LED - POWERLINK - Error.....	67
Table 71:	Status/Error LED - POWERLINK - Status.....	68
Table 72:	System stop error codes.....	69
Table 73:	POWERLINK station number (x1, x16).....	69
Table 74:	Selecting display units.....	77
Table 75:	Possible combinations of system unit and CPU board.....	78
Table 76:	Link modules.....	78
Table 77:	Cables for DVI configurations.....	78
Table 78:	Possible Automation Panel devices, resolutions and segment lengths.....	79
Table 79:	Possible combinations of system unit and CPU board.....	80
Table 80:	Link modules.....	80
Table 81:	Cables for SDL configurations.....	80
Table 82:	Cable lengths and resolutions for SDL transmission.....	81
Table 83:	Possible combinations of system unit and CPU board.....	82
Table 84:	Cables for SDL configurations.....	82
Table 85:	Cable lengths and resolutions for SDL transmission.....	83
Table 86:	Possible combinations of system unit and CPU board.....	84
Table 87:	Link modules.....	84
Table 88:	Possible combinations of system unit and CPU board.....	86
Table 89:	Link modules.....	86
Table 90:	Cables for SDL configurations.....	87
Table 91:	Cable lengths and resolutions for SDL transmission.....	87
Table 92:	BIOS-relevant keys for POST.....	93
Table 93:	BIOS-relevant keys.....	93
Table 94:	945GME - Main Menu - Setting options.....	94
Table 95:	945GME Advanced Menu (Setting options).....	95
Table 96:	945GME - Advanced ACPI configuration - Setting options.....	96
Table 97:	945GME - Advanced PCI configuration - Setting options.....	97
Table 98:	945GME - Advanced PCI IRQ Resource Exclusion - Setting options.....	98
Table 99:	945GME - Advanced PCI Interrupt Routing - Setting options.....	99
Table 100:	945GME Advanced PCI Express Configuration (Setting options).....	100
Table 101:	945GME Advanced Graphics Configuration (Setting options).....	102
Table 102:	945GME Advanced CPU Configuration (Setting options).....	104
Table 103:	945GME Advanced Chipset (Setting options).....	105
Table 104:	945GME Advanced I/O Interface Configuration.....	106
Table 105:	945GME Advanced Clock Configuration (Setting options).....	107
Table 106:	945GME Advanced IDE Configuration (Setting options).....	108
Table 107:	945GME - Primary IDE Master - Setting options.....	108
Table 108:	945GME - Primary IDE Slave - Setting options.....	109
Table 109:	945GME - Secondary IDE Master - Setting options.....	110
Table 110:	945GME - Secondary IDE Slave - Setting options.....	111

Table 111:	945GME - Advanced USB Configuration - Setting options.....	112
Table 112:	945GME Advanced Keyboard/Mouse Configuration (Setting options).....	114
Table 113:	945GME Advanced Remote Access Configuration (Setting options).....	115
Table 114:	945GME Advanced Remote Access Configuration (Setting options).....	116
Table 115:	945GME - Advanced Baseboard/Panel Features - Setting options.....	117
Table 116:	945GME Panel Control (Setting options).....	118
Table 117:	945GME Baseboard Monitor (Setting options).....	119
Table 118:	945GME Legacy Devices (Setting options).....	120
Table 119:	945GME Boot Menu (Setting options).....	121
Table 120:	945GME - Advanced PCI configuration - Setting options.....	122
Table 121:	945GME Hard Disk Security User Password.....	123
Table 122:	945GME Hard Disk Security Master Password.....	124
Table 123:	945GME Power Menu (Setting options).....	125
Table 124:	945GME - Advanced PCI configuration - Setting options.....	126
Table 125:	Profile overview.....	127
Table 126:	945GME Main (Profile setting overview).....	127
Table 127:	945GME Advanced - ACPI configuration profile setting overview.....	127
Table 128:	945GME Advanced - PCI configuration profile setting overview.....	127
Table 129:	945GME Advanced - PCI Express configuration profile setting overview.....	128
Table 130:	945GME Advanced - Graphics configuration profile setting overview.....	128
Table 131:	945GME Advanced - CPU configuration profile setting overview.....	129
Table 132:	945GME Advanced - Chipset configuration profile setting overview.....	129
Table 133:	945GME Advanced - I/O Interface Configuration profile setting overview.....	129
Table 134:	945GME Advanced - Clock configuration profile setting overview.....	129
Table 135:	945GME Advanced - IDE configuration profile setting overview.....	129
Table 136:	945GME Advanced - USB configuration profile setting overview.....	130
Table 137:	945GME Advanced - Keyboard/Mouse Configuration profile setting overview.....	130
Table 138:	945GME Advanced - Remote Access Configuration profile setting overview.....	130
Table 139:	945GME Advanced - CPU board monitor profile setting overview.....	130
Table 140:	945GME Advanced - Baseboard/Panel Features profile setting overview.....	130
Table 141:	945GME Main (Profile setting overview).....	131
Table 142:	945GME Security profile setting overview.....	131
Table 143:	945GME Power profile setting overview.....	131
Table 144:	945GME BIOS - POST messages.....	133
Table 145:	RAM address assignment.....	134
Table 146:	I/O address assignment.....	134
Table 147:	IRQ interrupt assignments in PIC mode.....	134
Table 148:	IRQ interrupt assignments in APIC mode.....	135
Table 149:	9S0000.01-010, 9S0000.01-020 - Order data.....	146
Table 150:	Tested resolutions and color depths for DVI signals.....	146
Table 151:	Tested resolutions and color depths for RGB signals.....	146
Table 152:	5SWWXP.0600-GER, 5SWWXP.0600-ENG, 5SWWXP.0600-MUL, 5SWWXP.0500-GER, 5SWWXP.0500-ENG, 5SWWXP.0500-MUL - Order data.....	147
Table 153:	5SWWXP.0428-ENG - Order data.....	149
Table 154:	5SWWXP.0428-ENG - Technical data.....	149
Table 155:	Device functions in Windows XP Embedded with FP2007.....	149
Table 156:	5SWWXP.0728-ENG - Order data.....	151
Table 157:	5SWWXP.0728-ENG - Technical data.....	151
Table 158:	Device functions in Windows Embedded Standard 2009.....	151
Table 159:	5SWWI7.0528-ENG, 5SWWI7.0628-ENG, 5SWWI7.0728-MUL, 5SWWI7.0828-MUL, 5SWWI7.1528-ENG, 5SWWI7.1628-ENG, 5SWWI7.1728-MUL, 5SWWI7.1828-MUL - Order da- ta.....	153
Table 160:	5SWWI7.0528-ENG - Technical data.....	154
Table 161:	Device functions in Windows Embedded Standard 7.....	154
Table 162:	0TG1000.01, 1TG4600.10-5, 1TG4601.06-5 - Order data.....	156
Table 163:	0TB704.9, 0TB704.91 - Order data.....	168
Table 164:	0TB704.9, 0TB704.91 - Technical data.....	168
Table 165:	0AC201.91, 4A0006.00-000 - Order data.....	169

Table 166:	0AC201.91, 4A0006.00-000 - Technical data.....	169
Table 167:	5AC900.1000-00 - Order data.....	170
Table 168:	5CFCRD.0512-06, 5CFCRD.1024-06, 5CFCRD.2048-06, 5CFCRD.4096-06, 5CFCRD.8192-06, 5CFCRD.016G-06, 5CFCRD.032G-06 - Order data.....	173
Table 169:	5CFCRD.0512-06, 5CFCRD.1024-06, 5CFCRD.2048-06, 5CFCRD.4096-06, 5CFCRD.8192-06, 5CFCRD.016G-06, 5CFCRD.032G-06 - Order data.....	173
Table 170:	5CFCRD.0512-06, 5CFCRD.1024-06, 5CFCRD.2048-06, 5CFCRD.4096-06, 5CFCRD.8192-06, 5CFCRD.016G-06, 5CFCRD.032G-06 - Technical data.....	174
Table 171:	5CFCRD.0512-06, 5CFCRD.1024-06, 5CFCRD.2048-06, 5CFCRD.4096-06, 5CFCRD.8192-06, 5CFCRD.016G-06, 5CFCRD.032G-06 - Technical data.....	175
Table 172:	5CFCRD.0512-04, 5CFCRD.1024-04, 5CFCRD.2048-04, 5CFCRD.4096-04, 5CFCRD.8192-04, 5CFCRD.016G-04 - Order data.....	179
Table 173:	5CFCRD.0512-04, 5CFCRD.1024-04, 5CFCRD.2048-04, 5CFCRD.4096-04, 5CFCRD.8192-04, 5CFCRD.016G-04 - Technical data.....	179
Table 174:	5CFCRD.0064-03, 5CFCRD.0128-03, 5CFCRD.0256-03, 5CFCRD.0512-03, 5CFCRD.1024-03, 5CFCRD.2048-03, 5CFCRD.4096-03, 5CFCRD.8192-03 - Order data.....	183
Table 175:	5CFCRD.0064-03, 5CFCRD.0128-03, 5CFCRD.0256-03, 5CFCRD.0512-03, 5CFCRD.1024-03, 5CFCRD.2048-03, 5CFCRD.4096-03, 5CFCRD.8192-03 - Technical data.....	183
Table 176:	5MMUSB.2048-00 - Order data.....	187
Table 177:	5MMUSB.2048-00 - Technical data.....	187
Table 178:	5MMUSB.2048-01, 5MMUSB.4096-01 - Order data.....	189
Table 179:	5MMUSB.2048-01, 5MMUSB.4096-01 - Technical data.....	189
Table 180:	5CADVI.0018-00, 5CADVI.0050-00, 5CADVI.0100-00 - Order data.....	191
Table 181:	5CADVI.0018-00, 5CADVI.0050-00, 5CADVI.0100-00 - Technical data.....	191
Table 182:	5CASDL.0018-00, 5CASDL.0050-00, 5CASDL.0100-00, 5CASDL.0150-00, 5CASDL.0200-00, 5CASDL.0250-00, 5CASDL.0300-00 - Order data.....	194
Table 183:	5CASDL.0018-00, 5CASDL.0050-00, 5CASDL.0100-00, 5CASDL.0150-00, 5CASDL.0200-00, 5CASDL.0250-00, 5CASDL.0300-00 - Technical data.....	194
Table 184:	5CASDL.0018-03, 5CASDL.0050-03, 5CASDL.0100-03, 5CASDL.0150-03, 5CASDL.0200-03, 5CASDL.0250-03, 5CASDL.0300-03 - Order data.....	197
Table 185:	5CASDL.0018-03, 5CASDL.0050-03, 5CASDL.0100-03, 5CASDL.0150-03, 5CASDL.0200-03, 5CASDL.0250-03, 5CASDL.0300-03 - Technical data.....	197
Table 186:	5CASDL.0xxx-03 SDL flex cables - Structure.....	199
Table 187:	5CASDL.0300-13, 5CASDL.0400-13, 5CASDL.0430-13 - Order data.....	200
Table 188:	5CASDL.0300-13, 5CASDL.0400-13, 5CASDL.0430-13 - Technical data.....	200
Table 189:	5CASDL.0018-01, 5CASDL.0050-01, 5CASDL.0100-01, 5CASDL.0150-01 - Order data.....	204
Table 190:	5CASDL.0018-01, 5CASDL.0050-01, 5CASDL.0100-01, 5CASDL.0150-01 - Technical data..	204
Table 191:	5CAUSB.0018-00, 5CAUSB.0050-00 - Order data.....	207
Table 192:	5CAUSB.0018-00, 5CAUSB.0050-00 - Technical data.....	207
Table 193:	9A0014.02, 9A0014.05, 9A0014.10 - Order data.....	208
Table 194:	9A0014.02, 9A0014.05, 9A0014.10 - Technical data.....	208
Table 195:	5SWHMI.0000-00 - Order data.....	210
Table 196:	Battery status.....	213
Table 197:	Temperature limits of the fan (MTCX PX32 V0.05).....	218
Table 198:	Abbreviations in this user's manual.....	219

0AC201.91.....	169
0TB704.9.....	168
0TB704.91.....	168
0TG1000.01.....	156
1TG4600.10-5.....	156
1TG4601.06-5.....	156
4A0006.00-000.....	169
5AC802.HS00-00.....	61
5AC802.HS00-01.....	61
5AC900.1000-00.....	170
5ACPCC.ETH0-00.....	64
5ACPCC.MPL0-00.....	66
5CADVI.0018-00.....	191
5CADVI.0050-00.....	191
5CADVI.0100-00.....	191
5CASDL.0018-00.....	194
5CASDL.0018-01.....	204
5CASDL.0018-03.....	197
5CASDL.0050-00.....	194
5CASDL.0050-01.....	204
5CASDL.0050-03.....	197
5CASDL.0100-00.....	194
5CASDL.0100-01.....	204
5CASDL.0100-03.....	197
5CASDL.0150-00.....	194
5CASDL.0150-01.....	204
5CASDL.0150-03.....	197
5CASDL.0200-00.....	194
5CASDL.0200-03.....	197
5CASDL.0250-00.....	194
5CASDL.0250-03.....	197
5CASDL.0300-00.....	194
5CASDL.0300-03.....	197
5CASDL.0300-13.....	200
5CASDL.0400-13.....	200
5CASDL.0430-13.....	200
5CAUSB.0018-00.....	207
5CAUSB.0050-00.....	207
5CFCRD.0064-03.....	183
5CFCRD.0128-03.....	183
5CFCRD.016G-04.....	179
5CFCRD.016G-06.....	173
5CFCRD.0256-03.....	183
5CFCRD.032G-06.....	173
5CFCRD.0512-03.....	183
5CFCRD.0512-04.....	179
5CFCRD.0512-06.....	173
5CFCRD.1024-03.....	183
5CFCRD.1024-04.....	179
5CFCRD.1024-06.....	173
5CFCRD.2048-03.....	183
5CFCRD.2048-04.....	179
5CFCRD.2048-06.....	173
5CFCRD.4096-03.....	183
5CFCRD.4096-04.....	179
5CFCRD.4096-06.....	173
5CFCRD.8192-03.....	183
5CFCRD.8192-04.....	179
5CFCRD.8192-06.....	173
5MMDDR.0512-01.....	60
5MMDDR.1024-01.....	60
5MMDDR.2048-01.....	60

5MMUSB.2048-00.....	187
5MMUSB.2048-01.....	189
5MMUSB.4096-01.....	189
5PC800.B945-00.....	57
5PC800.B945-01.....	57
5PC800.B945-02.....	57
5PC800.B945-03.....	57
5PC800.B945-04.....	57
5PC800.B945-10.....	57
5PC800.B945-11.....	57
5PC800.B945-12.....	57
5PC800.B945-13.....	57
5PC800.B945-14.....	57
5PC820.SX01-00.....	49
5PC820.SX01-01.....	53
5SWHMI.0000-00.....	210
5SWWI7.0528-ENG.....	153
5SWWI7.0628-ENG.....	153
5SWWI7.0728-MUL.....	153
5SWWI7.0828-MUL.....	153
5SWWI7.1528-ENG.....	153
5SWWI7.1628-ENG.....	153
5SWWI7.1728-MUL.....	153
5SWWI7.1828-MUL.....	153
5SWWXP.0428-ENG.....	149
5SWWXP.0500-ENG.....	147
5SWWXP.0500-GER.....	147
5SWWXP.0500-MUL.....	147
5SWWXP.0600-ENG.....	147
5SWWXP.0600-GER.....	147
5SWWXP.0600-MUL.....	147
5SWWXP.0728-ENG.....	151
8BXF001.0000-00.....	62
9A0014.02.....	208
9A0014.05.....	208
9A0014.10.....	208
9S0000.01-010.....	146
9S0000.01-020.....	146

9

945GME.....	57
945GME CPU board.....	57

A

Accessories.....	168
ACPI.....	134, 135
ADI.....	158
.NET SDK.....	162
Development Kit.....	160
air circulation.....	73
ambient temperature with a fan kit.....	21
ARemb.....	156
ARwin.....	156
Automation Runtime.....	156
Automation Runtime Embedded.....	156
Automation Runtime Windows.....	156

B

B&R Automation Device Interface.....	158
B&R CompactFlash.....	179
B&R Control Center.....	158
B&R Embedded OS Installer.....	145
B&R Key Editor.....	164
Battery.....	40
battery status.....	40
beep codes.....	133
BIOS 945GME	
ACPI Configuration.....	96
Advanced.....	95
Baseboard/Panel Features.....	117
Baseboard Monitor.....	119
Boot.....	121
Chipset Configuration.....	105
Clock Configuration.....	107
CPU Board Monitor.....	116
CPU Configuration.....	104
Exit.....	126
Graphics Configuration.....	102
Hard Disk Security Master Password.....	124
Hard Disk Security User Password.....	123
I/O Interface Configuration.....	106
IDE Configuration.....	107
Keyboard/Mouse Configuration.....	114
Legacy Devices.....	120
PCI Configuration.....	97
PCI Express Configuration.....	100
Power.....	124
Security.....	122
USB Configuration.....	112
BIOS default settings.....	127
BIOS error signals.....	133
BIOS options.....	91
BIOS Setup keys.....	93
BIOS upgrade.....	137
Block diagram.....	26

C	
Cable connections.....	76
Cable lengths.....	28, 28
Cables.....	191
DVI.....	191
RS232.....	208
SDL.....	194
SDL flex.....	197
SDL flex cables with extender.....	200
SDL with 45° male connector.....	204
USB.....	207
CAN	
node switch.....	35
Status LED.....	35
terminating switch.....	35
CE mark.....	166
Certifications.....	167
certifications	
GOST-R.....	167
Certifications	
UL.....	167
Changing the fan.....	216
CMOS.....	42
Cold-plate mounting.....	71
COM1.....	31
COM2.....	32
CompactFlash	
Benchmark.....	182
CompactFlash cards.....	171
CompactFlash slot.....	30, 30
Complete system.....	21
Configuration	
Base system.....	19
Optional components.....	20
Configuration – APC820.....	19
Connection examples.....	77
Control Center.....	158
cooling circulation system.....	71
CPU board.....	57
Creating reports.....	158
D	
Device interfaces and slots.....	27
Dimensions	
Cold-plate mounting.....	52
Wall mounting.....	56
Dimension standards.....	14
Disposal.....	13, 13
Distribution of resources	
I/O address assignments.....	134
RAM address assignment.....	134
dongle.....	41, 157
dual-channel memory.....	60
DVI.....	27
DVI cables.....	191
DVI resolution.....	28
DVI transmission.....	28, 28
Dynamic wear leveling.....	171

E

Electromagnetic compatibility.....	166
Embedded OS Installer.....	145
EMC directive.....	166
ESD.....	11
Electrical components with a housing.....	11
Electrical components without a housing.....	11
Individual components.....	11
Packaging.....	11
ETH1.....	39
ETH2.....	39
Ethernet.....	39, 39
Evaluating the battery status.....	213

F

Fan control.....	217
fan speed.....	218
Feed-through mounting.....	71
Firmware upgrade.....	140
Flex radius.....	76
Flex radius specifications.....	76

G

General tolerance.....	14
GOST-R.....	167
Gosudarstwenny standard.....	167
Grounding.....	27
Guidelines.....	14

H

Hardware security key.....	41
Heat sink with power supply.....	61
Hibernation.....	42
HMI Drivers & Utilities DVD.....	210
Humidity specifications.....	23

I

I/O address assignment.....	134
Installation.....	70
Installation guidelines.....	75
Interfaces.....	27
Interrupt assignment.....	134

K

Key Editor.....	164
Known problems / issues.....	90

L

LED status indicators.....	42
Low voltage directive.....	166

M

Main memory.....	60
------------------	----

Maintenance Controller Extended.....	217
Manual history.....	9
Monitor / Panel connection.....	27
Mounting	
Cold-plate mounting.....	71
Feed-through mounting.....	71
Mounting plates.....	71
Wall mounting.....	71
Mounting orientation.....	72
MS-DOS.....	146
MTCX.....	217

O

Operating system	
Windows Embedded Standard 2009.....	151
Windows Embedded Standard 7.....	153
Windows XP Embedded.....	149
Windows XP Professional.....	147

P

Parity error.....	133
PCIec.....	63
Peripheral USB devices.....	88
plug-in card.....	63
Power button.....	43
Power calculation.....	24
power failure.....	42
POWERLINK.....	36
Card number switch.....	69
Link LED.....	36, 67
node switch.....	38
Speed LED.....	36, 67
station number.....	69
Status/Error LED.....	36, 67
System stop error codes.....	38, 69
Power management.....	24
power supply.....	27
Profile switch.....	42
Proper ESD handling.....	11

R

RAM address assignment.....	134
Relative humidity.....	23
Replacement fan.....	62
Replacing a CompactFlash card.....	215
Replacing the battery.....	213
Reset button.....	43
Resolution.....	57
RGB.....	27
RS232	
Bus length.....	31, 32
Cable type.....	31, 32
RS232 cables.....	208
RS422	
Bus length.....	32
Cable type.....	33
RS485	
Bus length.....	33

Cable type.....	33
RS485 interface.....	33

S

Safety guidelines.....	11
Environmental conditions.....	12
Environmentally friendly disposal.....	13
Installation.....	12
Intended use.....	11
Operation.....	12
Policies and procedures.....	11
Protection against electrostatic discharge.....	11
Separation of materials.....	13
Transport and storage.....	12
SDL.....	27
SDL cables.....	194
SDL cables with 45° male connector.....	204
SDL flex cables.....	197
SDL flex cables with extender.....	200
SDL resolution.....	28
SDL transmission.....	28, 28
Security key.....	41
serial interface.....	31, 32
Service function for MTCX upgrade.....	42
Service mode.....	42
Slots.....	27
Smart Display Link.....	27
software versions.....	158
spacing.....	73
Standards and guidelines.....	166
states.....	42
Static wear leveling.....	171

T

Technology Guarding.....	157
Temperature monitoring.....	217, 218
Temperature sensor locations.....	3, 3
Temperature specifications.....	3, 3
Terminating resistors.....	35

U

UL certification.....	167
Upgrade	
BIOS.....	137
Firmware.....	140
Upgrade failed.....	42
Upgrade information.....	137
USB cables.....	207
USB flash drive.....	187
USB interfaces.....	29
user serial ID.....	158

V

Voltage supply.....	24
Voltage supply block diagram.....	24

W

Wall mounting..... 71
WES2009..... 151
WES7..... 154
Windows Embedded Standard 2009..... 151
Windows Embedded Standard 7..... 153
Windows XP Embedded..... 149
Windows XP Professional..... 147