



## **Touch Panels with TFT-Display**

User manual

# User manual

## Touch Panels with TFT-Display

2017-05-16

---

Designation: UM EN TPXXXSTX

Revision: 00

Order No.: —

This user manual is valid for:

Designation

TP043STB

TP057STV

TP070STW

TP090STW

TP105STS

TP121STS

TP121STM

TP150STX

TP154STM

Order No.

---

## How to contact us

### Internet

Up-to-date information on Phoenix Contact products and our Terms and Conditions can be found on the Internet at:

[phoenixcontact.com](http://phoenixcontact.com)

Make sure you always use the latest documentation.

It can be downloaded at:

[phoenixcontact.net/products](http://phoenixcontact.net/products)

### Subsidiaries

If there are any problems that cannot be solved using the documentation, please contact your Phoenix Contact subsidiary.

Subsidiary contact information is available at [phoenixcontact.com](http://phoenixcontact.com).

### Published by

PHOENIX CONTACT GmbH & Co. KG  
Flachsmarktstraße 8  
32825 Blomberg  
GERMANY

Should you have any suggestions or recommendations for improvement of the contents and layout of our manuals, please send your comments to

[tecdoc@phoenixcontact.com](mailto:tecdoc@phoenixcontact.com)

## General terms and conditions of use for technical documentation

Phoenix Contact reserves the right to alter, correct, and/or improve the technical documentation and the products described in the technical documentation at its own discretion and without giving prior notice, insofar as this is reasonable for the user. The same applies to any technical changes that serve the purpose of technical progress.

The receipt of technical documentation (in particular user documentation) does not constitute any further duty on the part of Phoenix Contact to furnish information on modifications to products and/or technical documentation. You are responsible to verify the suitability and intended use of the products in your specific application, in particular with regard to observing the applicable standards and regulations. All information made available in the technical data is supplied without any accompanying guarantee, whether expressly mentioned, implied or tacitly assumed.

In general, the provisions of the current standard Terms and Conditions of Phoenix Contact apply exclusively, in particular as concerns any warranty liability.

This manual, including all illustrations contained herein, is copyright protected. Any changes to the contents or the publication of extracts of this document is prohibited.

Phoenix Contact reserves the right to register its own intellectual property rights for the product identifications of Phoenix Contact products that are used here. Registration of such intellectual property rights by third parties is prohibited.

Other product identifications may be afforded legal protection, even where they may not be indicated as such.

TPXXXSTX

---

---

PHOENIX CONTACT

# Table of Contents

1	Important Notes .....	7
	1.1 Symbols .....	7
	1.2 Safety Notes .....	7
	1.3 Intended Use .....	8
	1.4 Target Group .....	8
2	Installation and Commissioning .....	9
	2.1 Unpacking the Device.....	9
	2.2 Mounting the Device.....	10
	2.2.1 Front Panel Dimensions .....	11
	2.2.2 Mounting Cutout .....	20
	2.2.3 Side View, Mounting Depth .....	29
	2.3 Connecting the Device .....	38
	2.3.1 Supply Voltage .....	38
	2.3.2 Grounding .....	39
	2.4 Switching On .....	40
	2.5 Identification .....	42
3	Control and Display Elements .....	43
	3.1 Touchscreen .....	43
	3.2 Display.....	43
4	Interfaces of the Device .....	45
	4.1 Standard Interfaces .....	45
	4.1.1 Ethernet (X5) .....	46
	4.1.2 USB (X9, X10) .....	47
	4.1.3 Memory Card .....	48
	4.2 Serial / Field Bus Interfaces .....	49
	4.2.1 CAN (X12, X13) .....	50
	4.2.2 RS-422 / RS-485 (X14) .....	52
	4.2.3 RS232 (X15) .....	55
	4.3 Shielding D-SUB Connectors .....	56
5	Maintenance and Servicing .....	57
	5.1 Maintenance Interval .....	57
	5.2 Front Panel .....	57
	5.3 Fuse .....	57
	5.4 Battery .....	57

6	Technical Data .....	59
6.1	General.....	59
6.2	TP043STB.....	61
6.3	TP057STV.....	62
6.4	TP070STW.....	63
6.5	TP090STW.....	64
6.6	TP105STS.....	65
6.7	TP121STS.....	66
6.8	TP121STM.....	67
6.9	TP150STX.....	68
6.10	TP154STM.....	69

# 1 Important Notes

## 1.1 Symbols

The symbols in this manual are used to draw your attention on notes and dangers.



This symbol indicates hazards that could lead to personal injury.

There are three signal words indicating the severity of a potential injury.

### **DANGER**

Indicates a hazard with a high risk level. If this hazardous situation is not avoided, it will result in death or serious injury.

### **WARNING**

Indicates a hazard with a medium risk level. If this hazardous situation is not avoided, it could result in death or serious injury.

### **CAUTION**

Indicates a hazard with a low risk level. If this hazardous situation is not avoided, it could result in minor or moderate injury.



This symbol together with the **NOTE** signal word alerts the reader to a situation which may cause damage or malfunction to the device, hardware/software, or surrounding property.



Here you will find additional information or detailed sources of information.

## 1.2 Safety Notes

- Read this manual carefully before using the operating device. Keep this manual in a place where it is always accessible to all users.
- Proper transportation, handling and storage, placement and installation of this product are prerequisites for its subsequent flawless and safe operation.
- This user manual contains the most important information for the safe operation of the device.
- The user manual, in particular the safety notes, must be observed by all personnel working with the device.
- Observe the accident prevention rules and regulations that apply to the operating site.
- Installation and operation must only be carried out by qualified and trained personnel.

### 1.3 Intended Use

- The device is designed for use in the industry.
- The device is state-of-the art and has been built to the latest standard safety requirements. However, dangerous situations or damage to the machine itself or other property can arise from the use of this device.
- The device fulfills the requirements of the EMC directives and harmonized European standards. Any modifications to the system can influence the EMC behavior.

**NOTICE: Radio Interference**

This is a class A device. This device may cause radio interference in residential areas. In this case, the user may be required to introduce appropriate countermeasures, and to bear the cost of same.

### 1.4 Target Group

The use of products described in this manual is oriented exclusively to:

- Qualified electricians or persons instructed by them. The users must be familiar with the relevant safety concepts of automation technology as well as applicable standards and other regulations.
- Qualified application programmers and software engineers. The users must be familiar with the relevant safety concepts of automation technology as well as applicable standards and other regulations.



## 2 Installation and Commissioning

### 2.1 Unpacking the Device

Unpack all parts carefully and check the contents for any visible damage in transit. Also check whether the shipment matches the specifications on your delivery note.

If you notice damages in transit or discrepancies, please contact us immediately.

## 2.2 Mounting the Device



**NOTICE: Damage**

When installing the device, leave a gap of at least 30 mm (1.181") around the device to ensure sufficient air circulation.



**NOTICE: Damage**

When the operating device is installed horizontally, please note that additional sources of heat beneath the operating device may result in heat accumulation.

Make sure to allow sufficient heat dissipation!

Please observe the permissible temperature range specified in the technical data when operating the device.



**NOTICE: Damage**

In order to ensure the degree of protection specified in the technical data, observe the following points:

- A tolerance of  $\pm 0.5$  mm is maintained for the mounting cutout.
- The seal lies flat against the mounting surface.
- The number of mounting brackets, given in the technical data, is used.
- The threaded pins of the mounting brackets are tightened uniformly to a maximum torque of 1 Nm.

The device can be easily and quickly mounted from the rear of the device. A panel thickness of 1 mm to 6 mm (0.039" to 0.236") is permitted for proper mounting.

1. Cut the mounting cutout in the housing for the device size to be installed.
2. Push the device through the mounting cutout from the front.

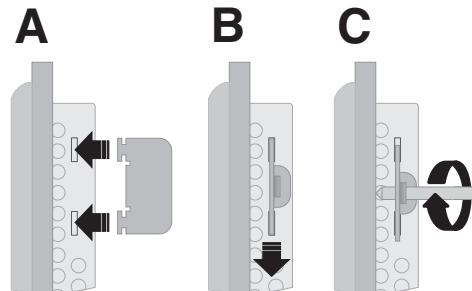

Figure 2-1 Mounting the device using a mounting bracket

3. Fix the mounting brackets in the recesses provided (A).
4. Pull the mounting brackets down until the snap into place (B).
5. Secure the device using the threaded pins (C).

## 2.2.1 Front Panel Dimensions

### 2.2.1.1 TP043STB

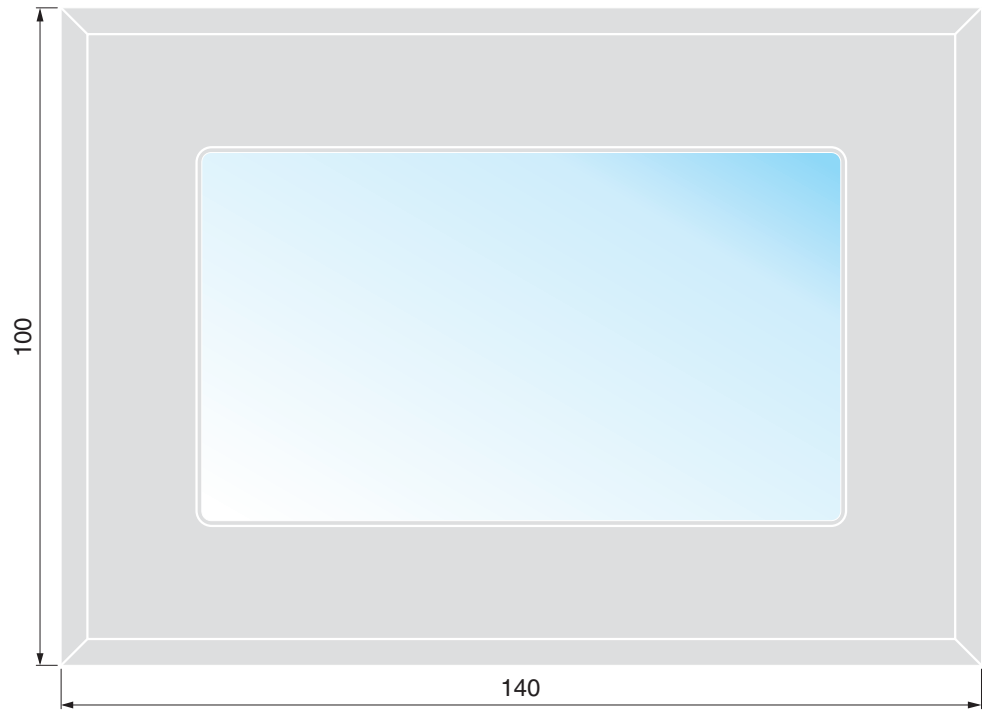

Figure 2-2 Front panel (dimensions in mm)

2.2.1.2 TP057STV

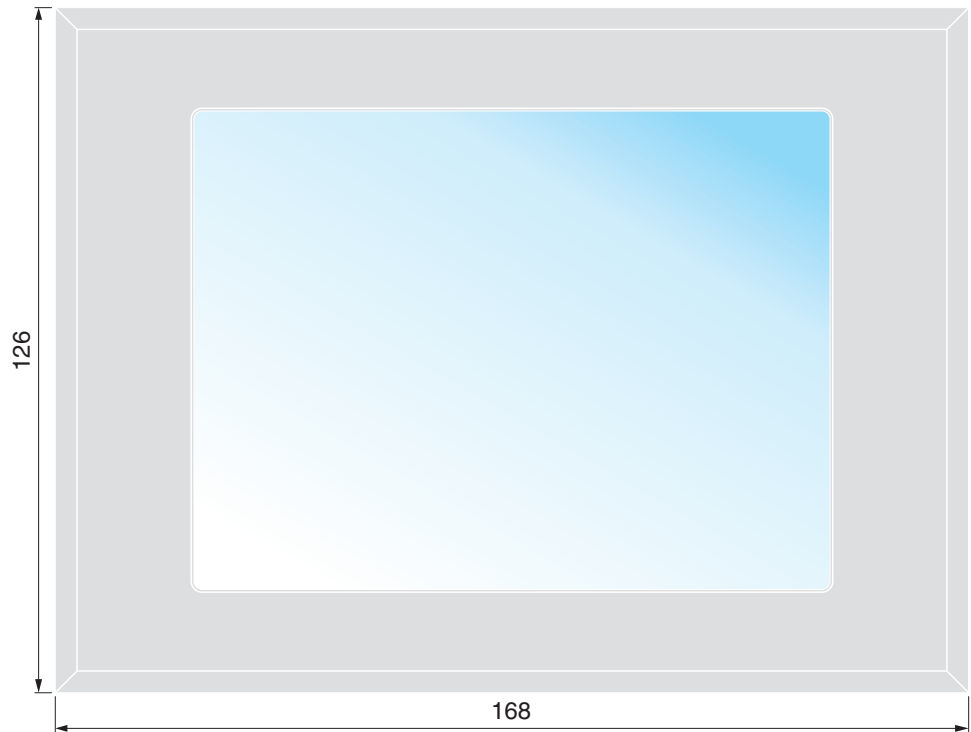

Figure 2-3 Front panel (dimensions in mm)

2.2.1.3 TP070STW

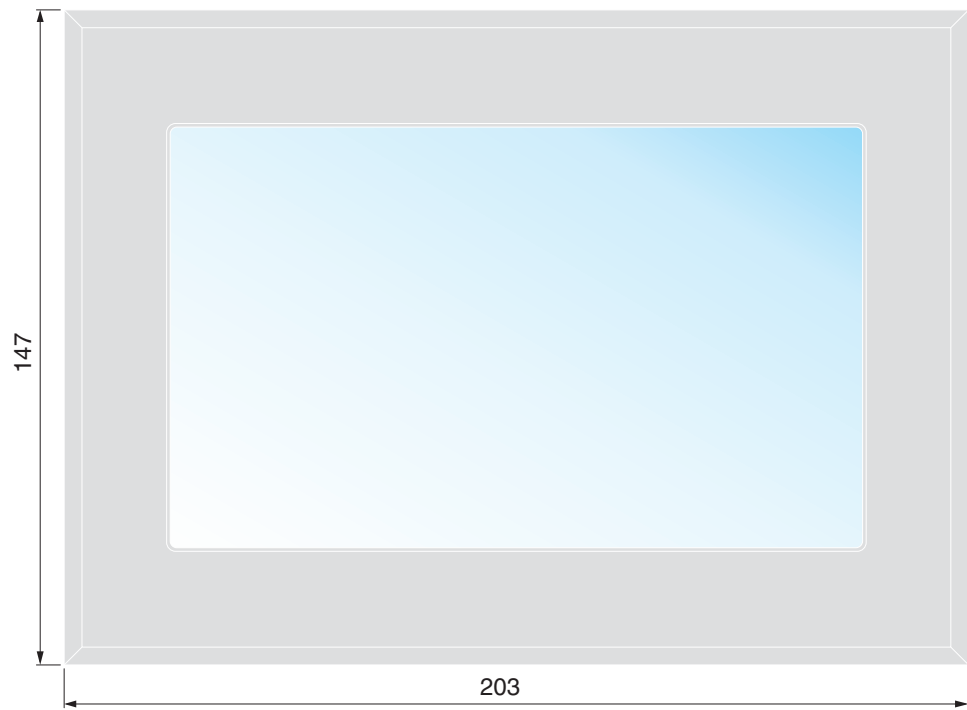

Figure 2-4 Front panel (dimensions in mm)

2.2.1.4 TP090STW

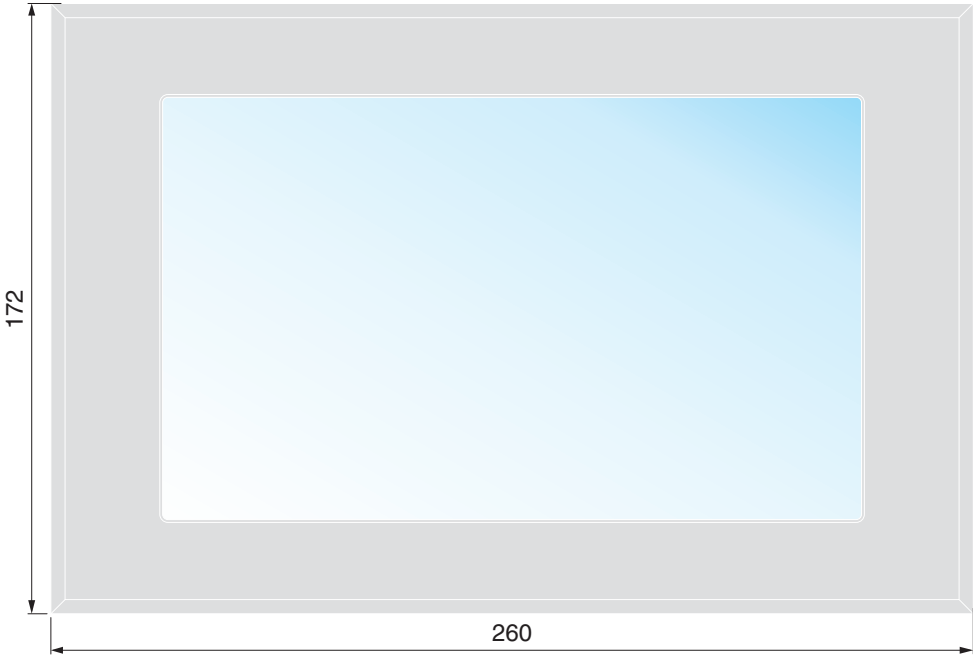

Figure 2-5 Front panel (dimensions in mm)

2.2.1.5 TP105STS



Figure 2-6 Front panel (dimensions in mm)

2.2.1.6 TP121STS

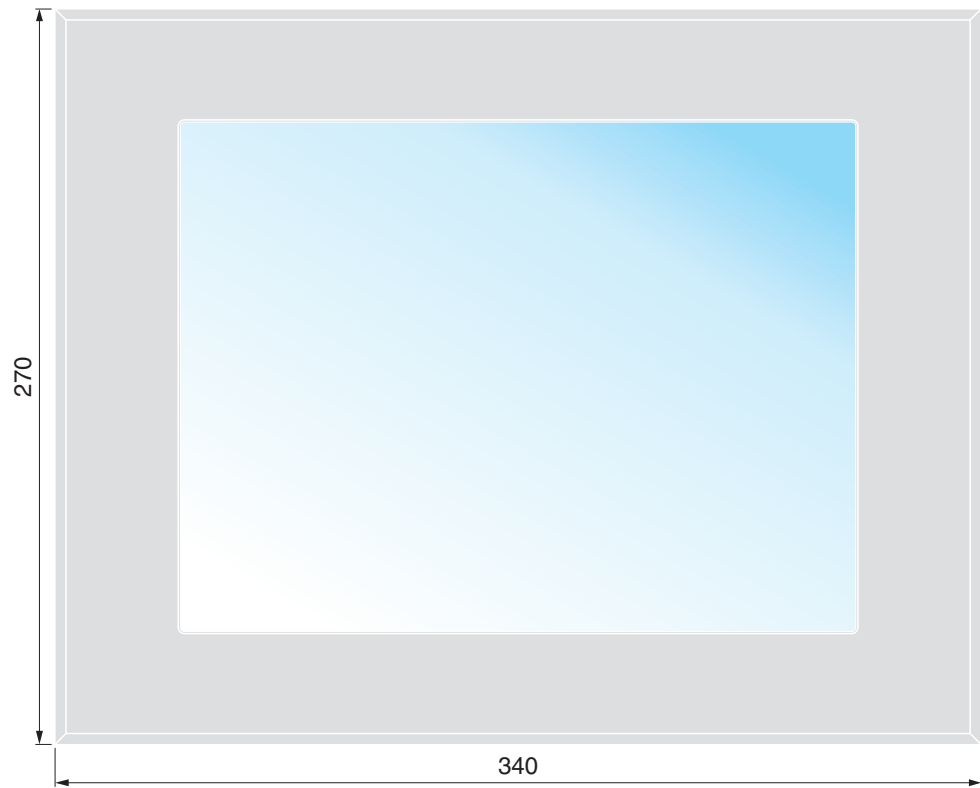

Figure 2-7 Front panel (dimensions in mm)



2.2.1.7 TP121STM

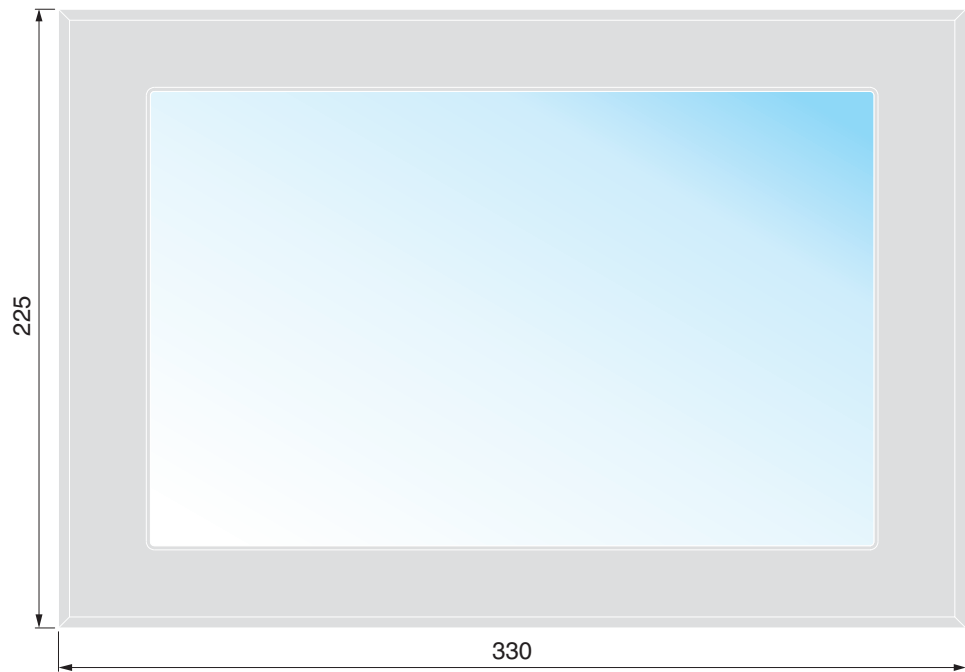

Figure 2-8 Front panel (dimensions in mm)

2.2.1.8 TP150STX

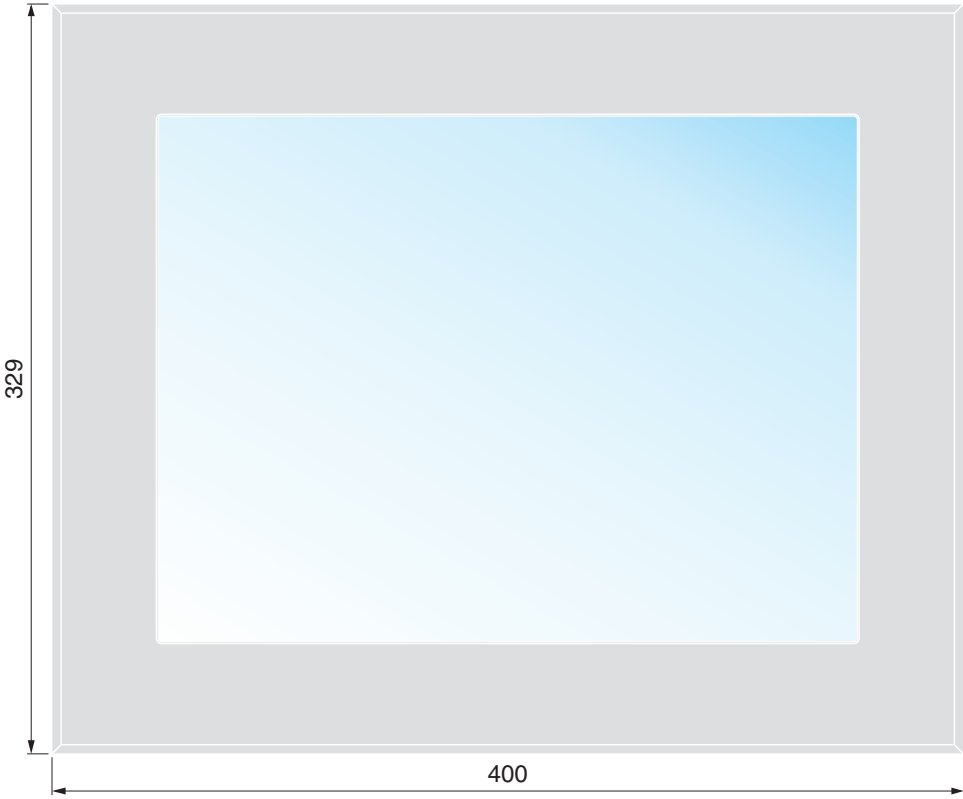

Figure 2-9 Front panel (dimensions in mm)

2.2.1.9 TP154STM

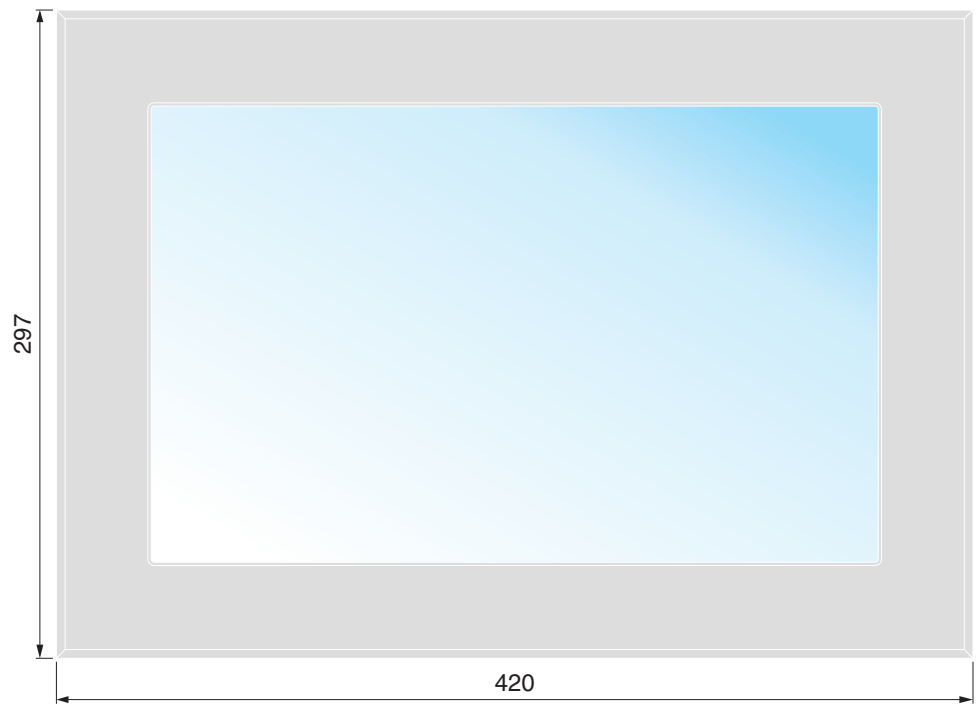

Figure 2-10 Front panel (dimensions in mm)

## 2.2.2 Mounting Cutout

### 2.2.2.1 TP043STB

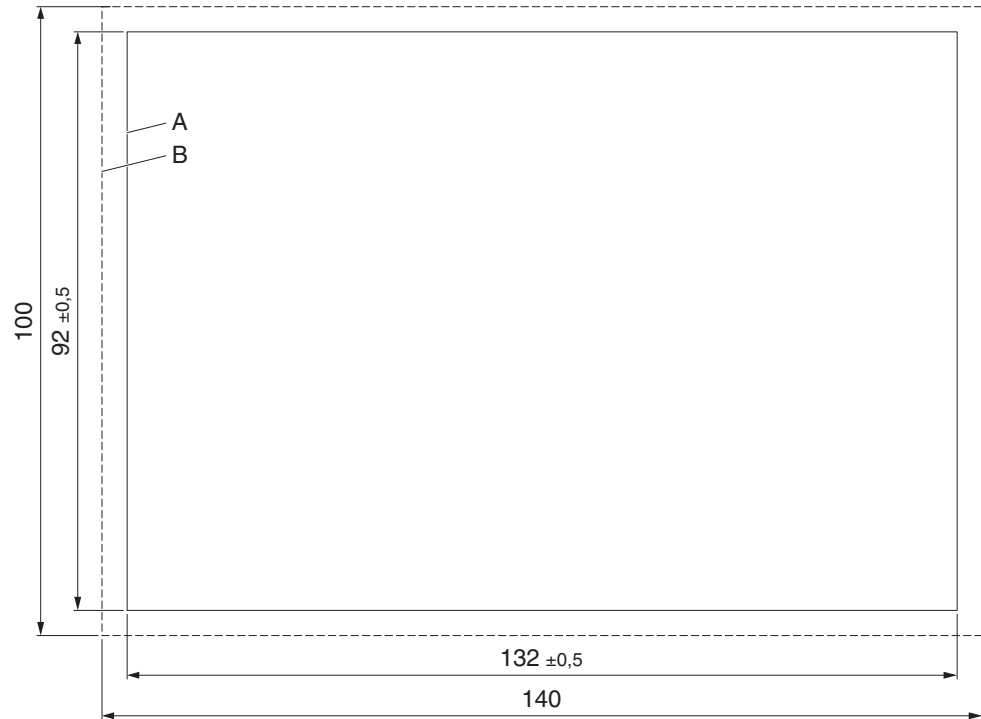

Figure 2-11 Mounting cutout (dimensions in mm)

- A** Mounting Cutout
- B** Front Panel

2.2.2.2 TP057STV

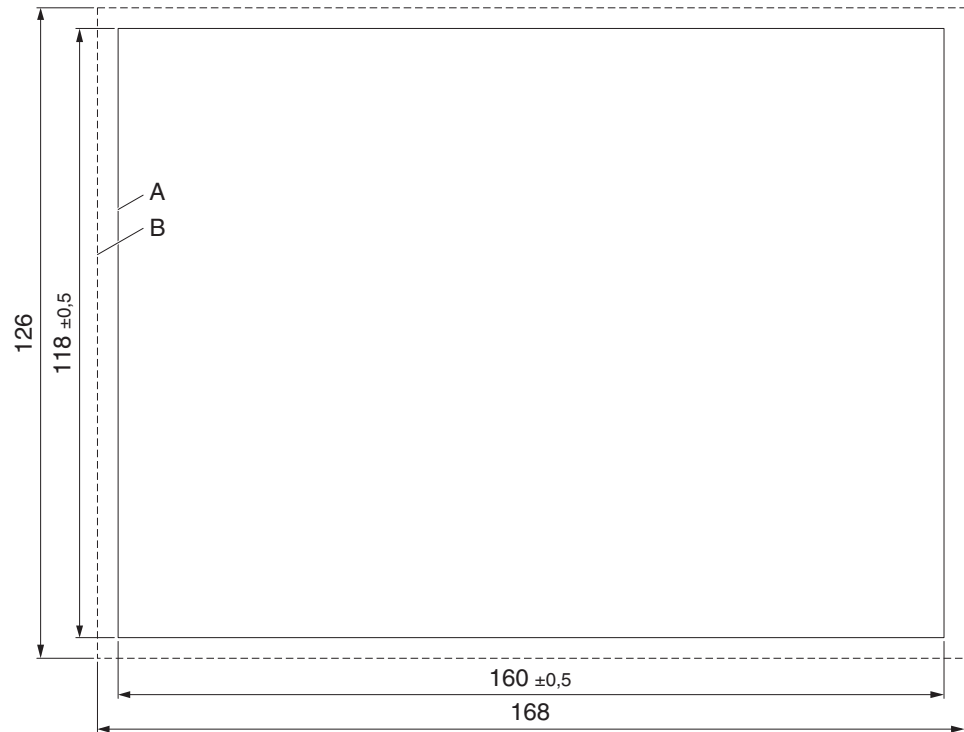

Figure 2-12 Mounting cutout (dimensions in mm)

- A** Mounting Cutout
- B** Front Panel

2.2.2.3 TP070STW

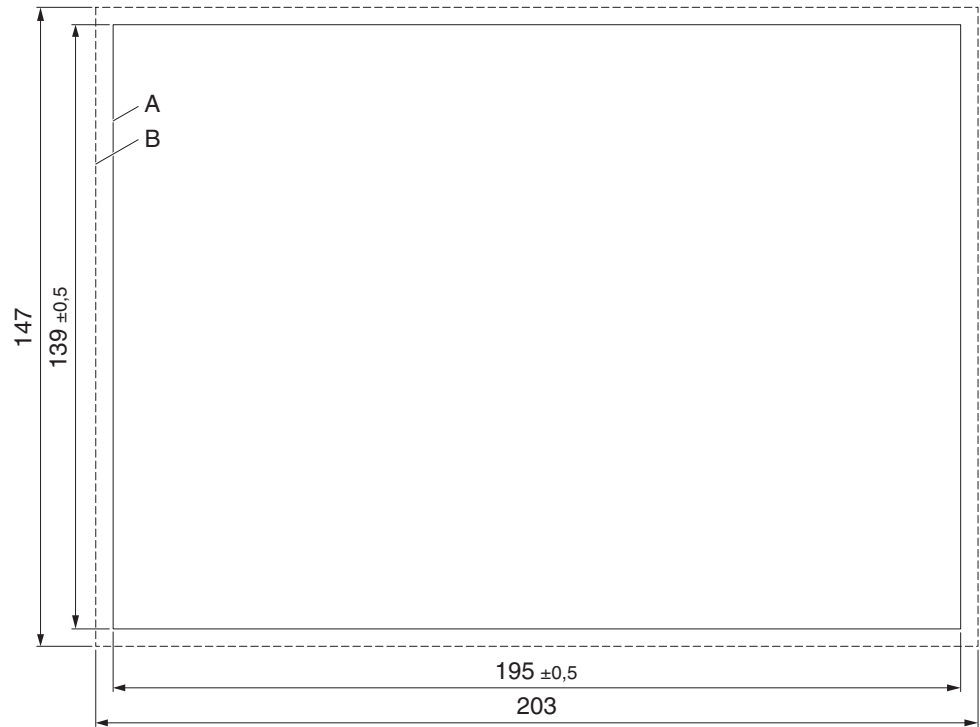

Figure 2-13 Mounting cutout (dimensions in mm)

- A** Mounting Cutout
- B** Front Panel

2.2.2.4 TP090STW

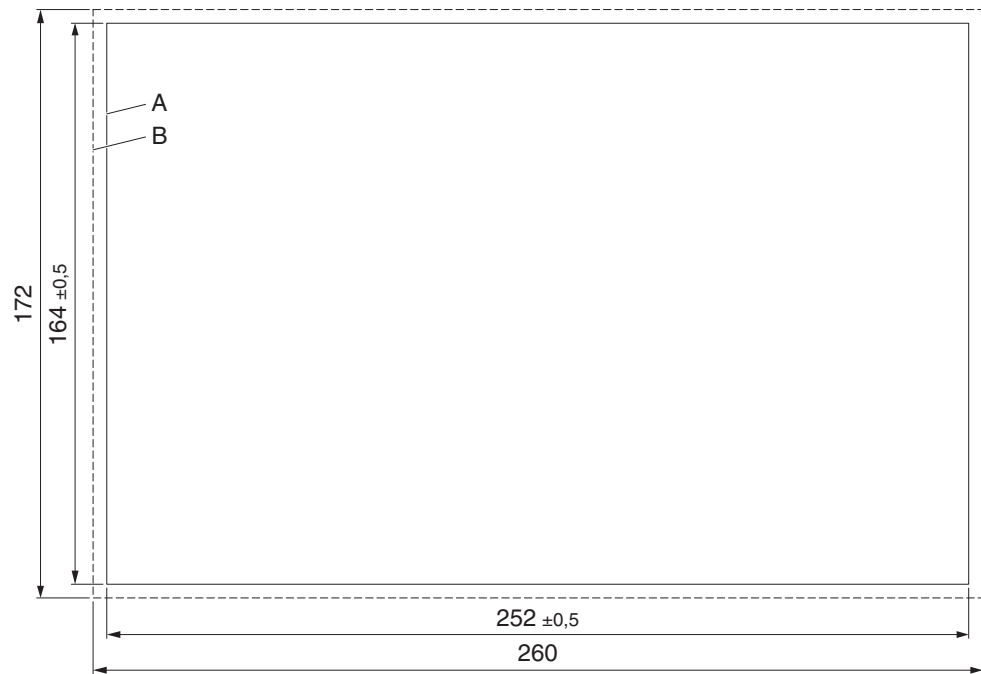

Figure 2-14 Mounting cutout (dimensions in mm)

- A** Mounting Cutout
- B** Front Panel

2.2.2.5 TP105STS

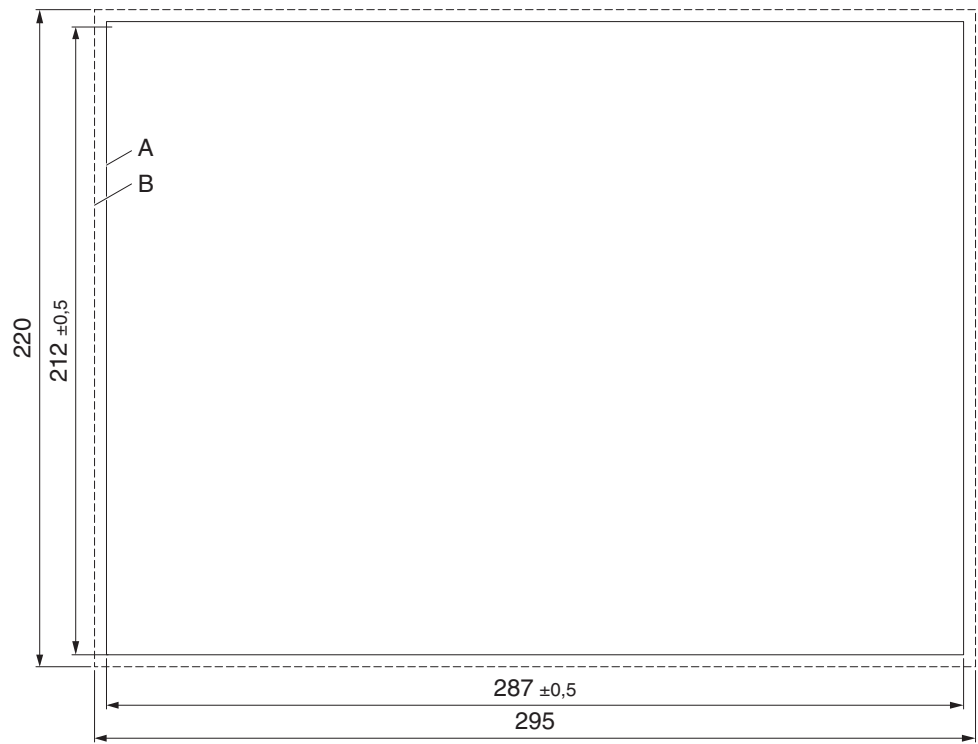

Figure 2-15 Mounting cutout (dimensions in mm)

- A** Mounting Cutout
- B** Front Panel



2.2.2.6 TP121STS

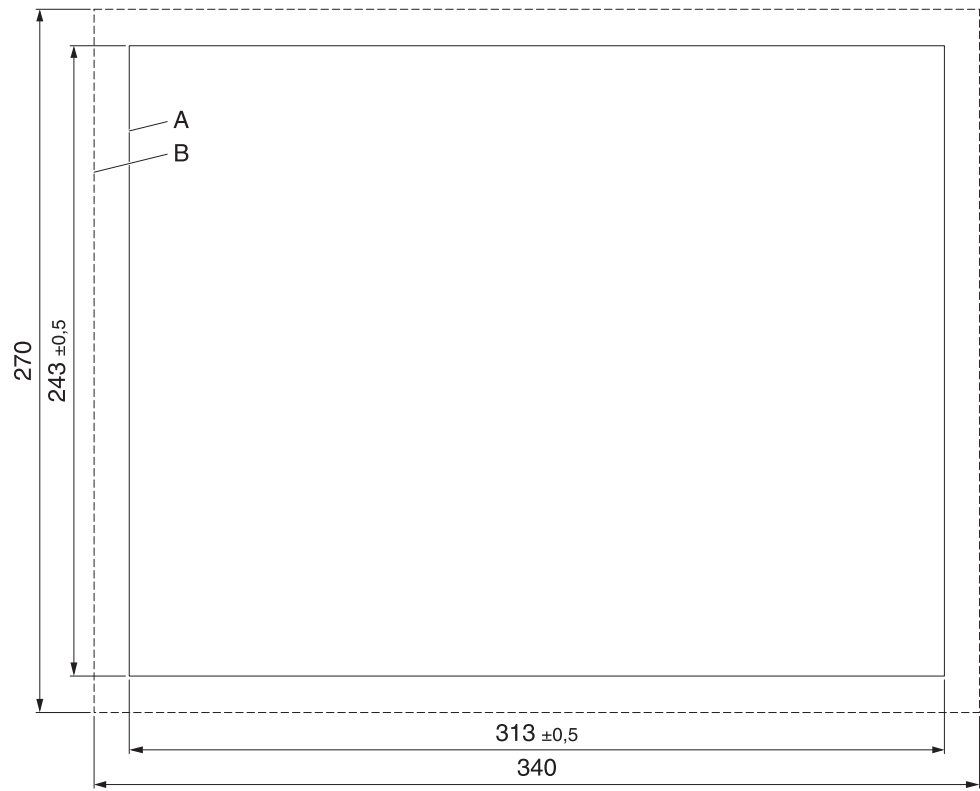

Figure 2-16 Mounting cutout (dimensions in mm)

- A** Mounting Cutout
- B** Front Panel

2.2.2.7 TP121STM

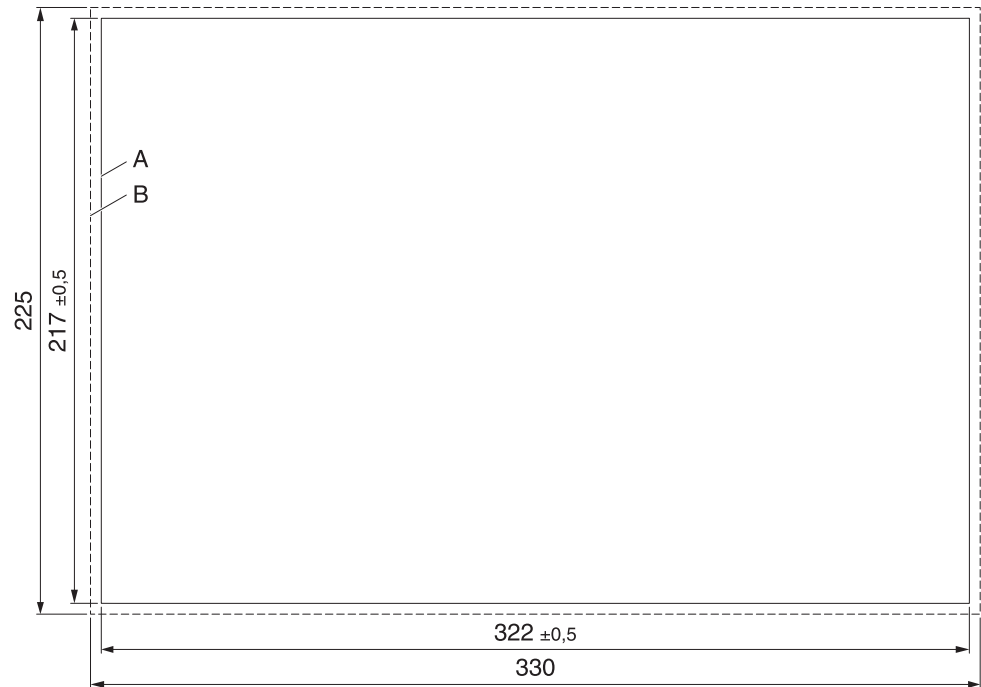

Figure 2-17 Mounting cutout (dimensions in mm)

- A** Mounting Cutout
- B** Front Panel

2.2.2.8 TP150STX

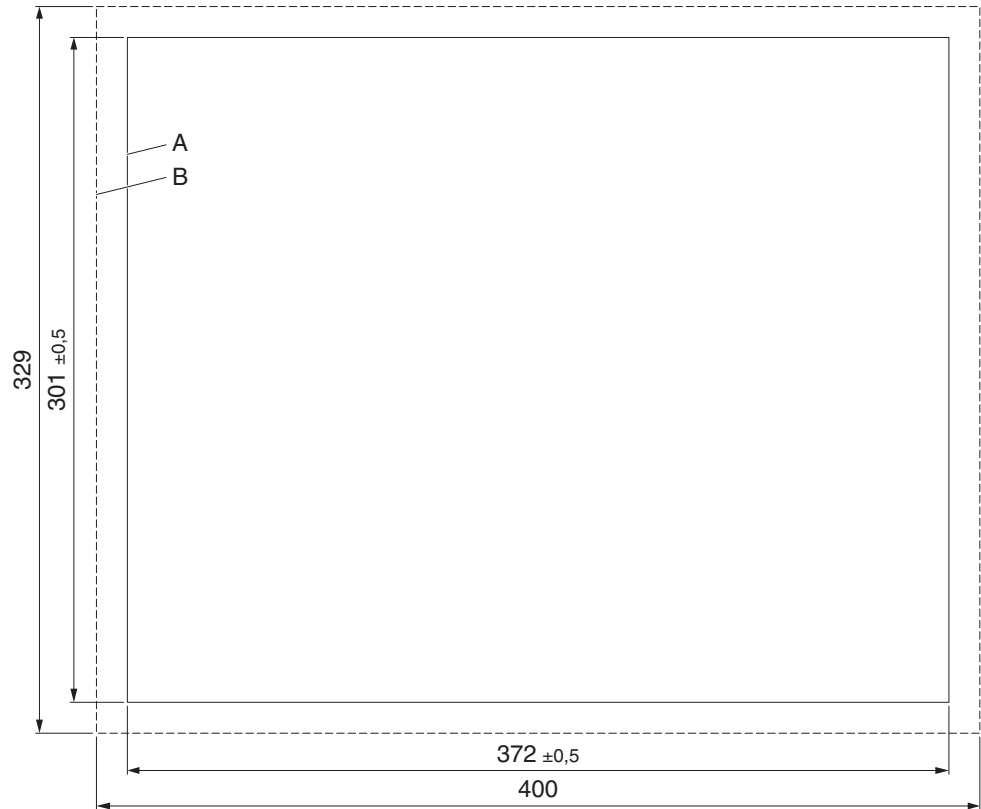

Figure 2-18 Mounting cutout (dimensions in mm)

- A** Mounting Cutout
- B** Front Panel

2.2.2.9 TP154STM

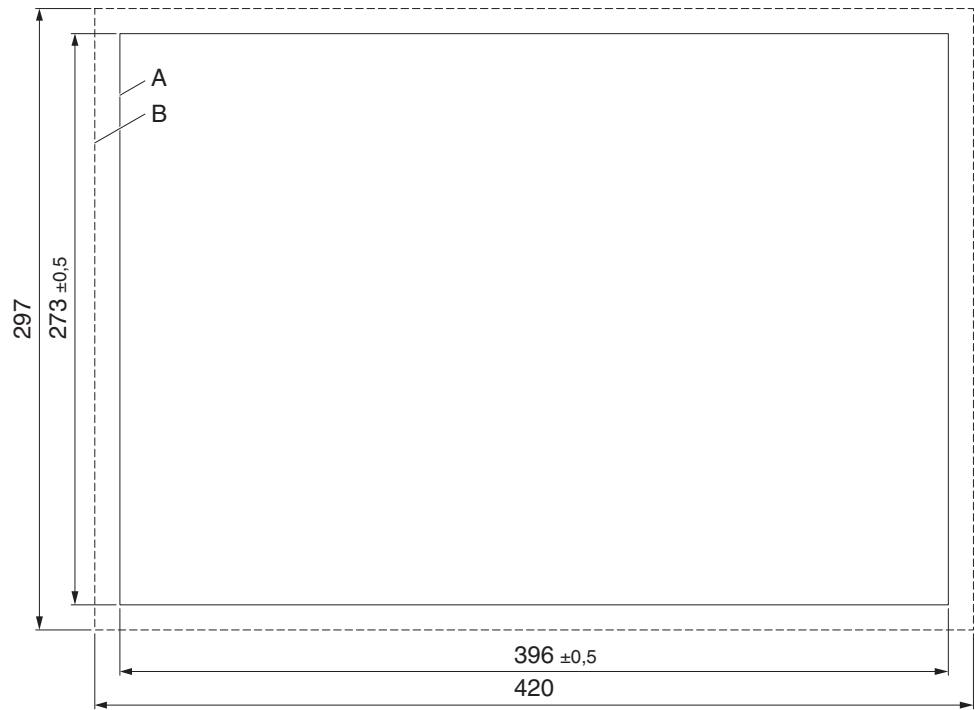

Figure 2-19 Mounting cutout (dimensions in mm)

- A** Mounting Cutout
- B** Front Panel

## 2.2.3 Side View, Mounting Depth

### 2.2.3.1 TP043STB

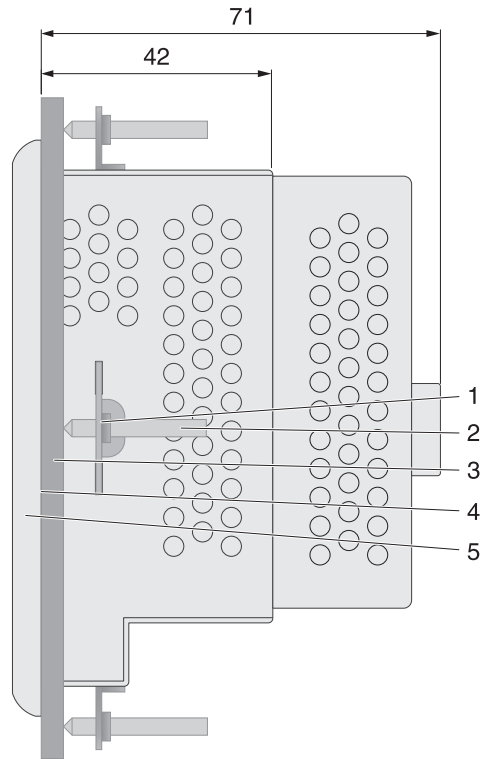

Figure 2-20 Side view, mounting depth (dimensions in mm)

- 1 Mounting Bracket
- 2 Threaded Pin
- 3 Mounting Surface Thickness 1 mm to 6 mm
- 4 Circumferential Seal
- 5 Front Panel

2.2.3.2 TP057STV

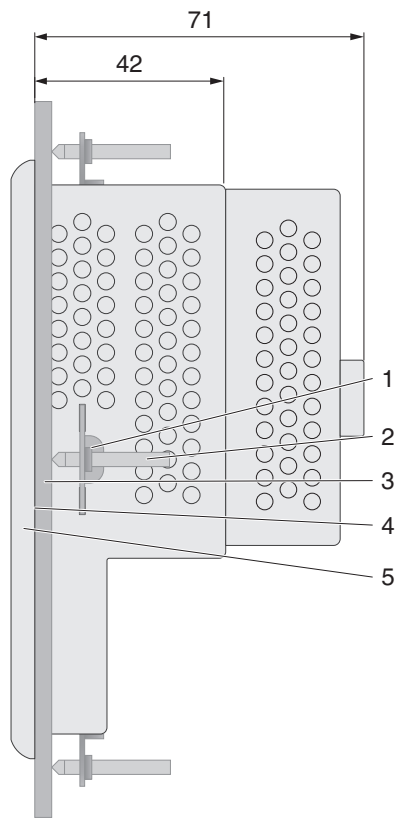

Figure 2-21 Side view, mounting depth (dimensions in mm)

- 1 Mounting Bracket
- 2 Threaded Pin
- 3 Mounting Surface Thickness 1 mm to 6 mm
- 4 Circumferential Seal
- 5 Front Panel

2.2.3.3 TP070STW

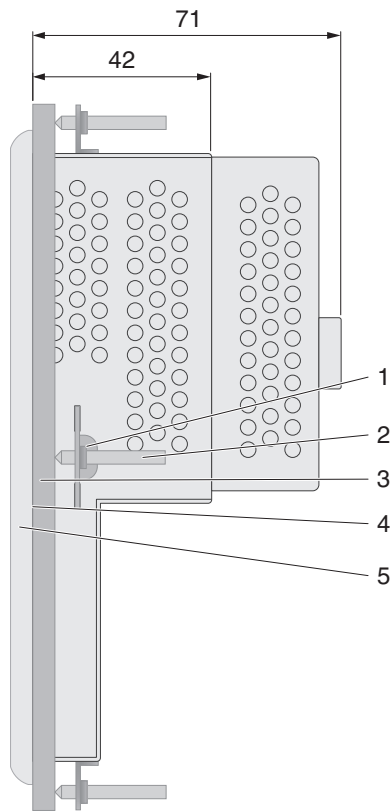

Figure 2-22 Side view, mounting depth (dimensions in mm)

- 1 Mounting Bracket
- 2 Threaded Pin
- 3 Mounting Surface Thickness 1 mm to 6 mm
- 4 Circumferential Seal
- 5 Front Panel

2.2.3.4 TP090STW

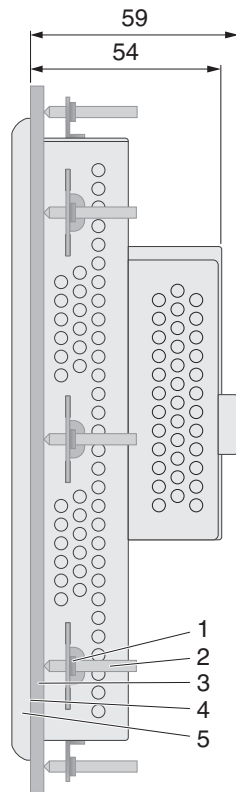

Figure 2-23 Side view, mounting depth (dimensions in mm)

- 1 Mounting Bracket
- 2 Threaded Pin
- 3 Mounting Surface Thickness 1 mm to 6 mm
- 4 Circumferential Seal
- 5 Front Panel



2.2.3.5 TP105STS

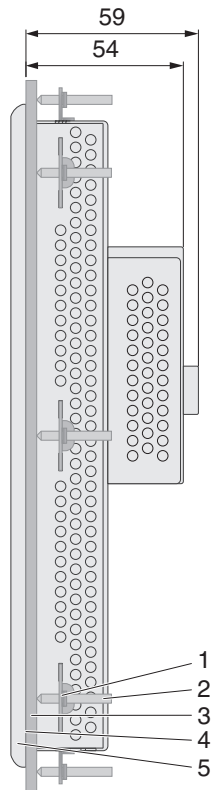

Figure 2-24 Side view, mounting depth (dimensions in mm)

- 1 Mounting Bracket
- 2 Threaded Pin
- 3 Mounting Surface Thickness 1 mm to 6 mm
- 4 Circumferential Seal
- 5 Front Panel

2.2.3.6 TP121STS

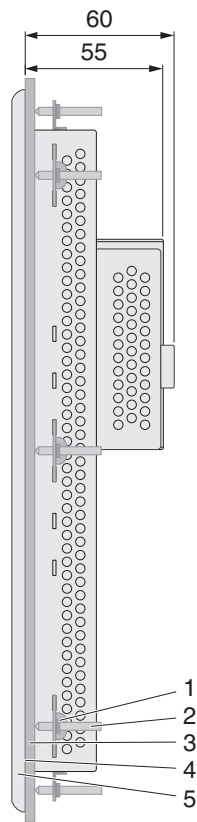

Figure 2-25 Side view, mounting depth (dimensions in mm)

- 1 Mounting Bracket
- 2 Threaded Pin
- 3 Mounting Surface Thickness 1 mm to 6 mm
- 4 Circumferential Seal
- 5 Front Panel

2.2.3.7 TP121STM

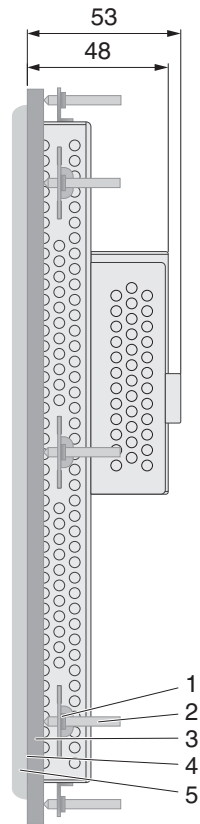

Figure 2-26 Side view, mounting depth (dimensions in mm)

- 1 Mounting Bracket
- 2 Threaded Pin
- 3 Mounting Surface Thickness 1 mm to 6 mm
- 4 Circumferential Seal
- 5 Front Panel

2.2.3.8 TP150STX

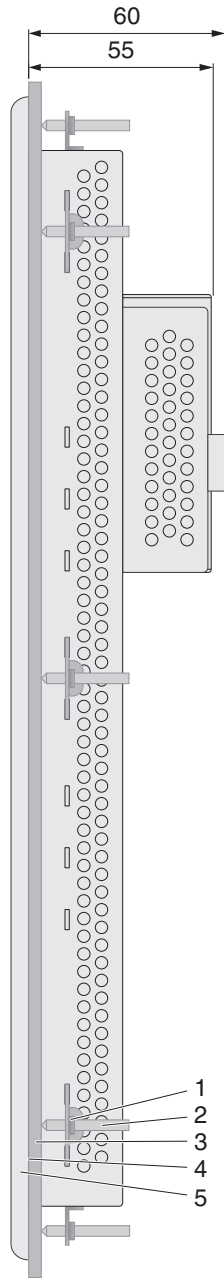

Figure 2-27 Side view, mounting depth (dimensions in mm)

- 1 Mounting Bracket
- 2 Threaded Pin
- 3 Mounting Surface Thickness 1 mm to 6 mm
- 4 Circumferential Seal
- 5 Front Panel

2.2.3.9 TP154STM

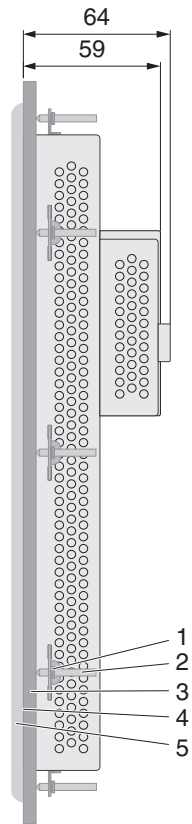

Figure 2-28 Side view, mounting depth (dimensions in mm)

- 1 Mounting Bracket
- 2 Threaded Pin
- 3 Mounting Surface Thickness 1 mm to 6 mm
- 4 Circumferential Seal
- 5 Front Panel

## 2.3 Connecting the Device

### 2.3.1 Supply Voltage

The supply voltage is supplied via pin strip X1. A suitable socket strip is supplied. Refer to the technical data for the permissible supply voltage of the operating device.



The device has reverse polarity protection. In case of wrong polarity, the device will not operate.



This is a protection class I device. For safe operation, safety extra-low voltage (SELV) in accordance with DIN EN 61131 must be used for the supply voltage.

Connector in the operating device: 3 pin pin strip

Table 2-1 Pin assignment supply voltage

Pin	Designation	Function
1		Noiseless ground / functional earth ground (FE)
2	0 V	Supply voltage 0 V (GND)
3	--- 24 V	Supply voltage --- 24 V



**DANGER: Hazardous voltages**

Hazardous voltages can exist inside electrical installations that can pose a danger to humans. Coming in contact with live parts may result in electric shock!



**NOTICE: Damage**

Cables with finely stranded copper conductors with a minimum cross-section of 0.75 mm<sup>2</sup> (18 AWG) and a maximum cross-section of 2.5 mm<sup>2</sup> (14 AWG) must be used for the supply voltage.

You must adhere to the following torques at the connector:

Screw connection of terminal blocks: 0.22 Nm (minimal) to 0.25 Nm (maximum)

Screw flange: 0.3 Nm (maximum)

Use the following procedure to connect the device to the supply voltage:

- Strip approx. 30 mm (1.181") off the outer cable sheath and approx. 5 mm (0.197") off the wires.

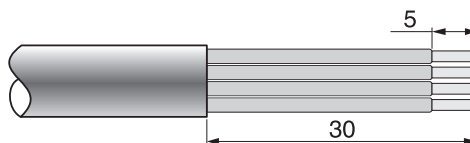

Figure 2-29 Preparing the cable

- Fit the wires with wire end ferrules and connect the wires to the socket strip.
- Plug the socket strip onto pin strip X1.
- Secure the socket strip in place with a screw-type locking to prevent it from slipping out.

### 2.3.2 Grounding

The grounding is performed - depending on the type of device - with a slip-on sleeve (noiseless ground / functional earth ground) or a ring cable lug (protective ground).

**NOTICE: Damage**

A separate copper conductor must always be provided for the grounding. The conductor must have a minimum cross-section of 1.5 mm<sup>2</sup> (16 AWG) and must be kept as short as possible.

You must adhere to a maximum torque of 1 Nm at an protective grounding on the threaded bolt.

1. Strip approx. 5 mm (0.197") off the wires.
2. Fit the stripped wires - depending on the type of device - with a slip-on sleeve or a ring cable lug.
3. Plug the slip-on sleeve on the flat tab or mount the ring cable lug with the nut to the threaded bolt.

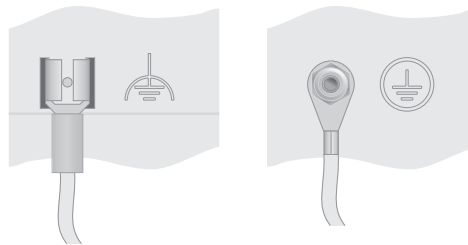

Figure 2-30 Noiseless ground / protective ground

## 2.4 Switching On

When switching on the operating system loads. The interface for SD/SDHC cards is available for applications and other data.

### Automatic start of programs



In the delivery state, the file "starter.bat" is renamed to "\_starter.bat" and therefore inactive.

You can use the file "starter.bat" as follows:

1. Open your FTP program or the Windows Explorer and enter the ip address of the operating device (example: ftp://149.208.160.232).
2. Rename the existing file "\_starter.bat" to "starter.bat".
3. Download an existing file "starter.bat" from the root directory on your local file system or create a new file with this name.
4. Edit the file "starter.bat" with your favorite editor (for example "Notepad") and add the following content:

```
\FlashDrv\MyFolder\MyProgram.exe -parameter
```



With the appropriate paths, different memory areas of the operating device can be accessed:

Memory type	Path
USB stick	\HardDisk\
Internal	\FlashDrv\

5. Save the file.
6. Copy the file "starter.bat" with the FTP program or the Windows Explorer into the root directory of the operating device.
7. Restart the operating device.

Your application is started after the boot sequence.



The operating device allows you - by starting the cockpit during the startup phase - to make changes to the device configuration.

**Start cockpit at system startup**

To start the cockpit, do the following:

1. Wait during the startup phase until the following dialog is displayed:

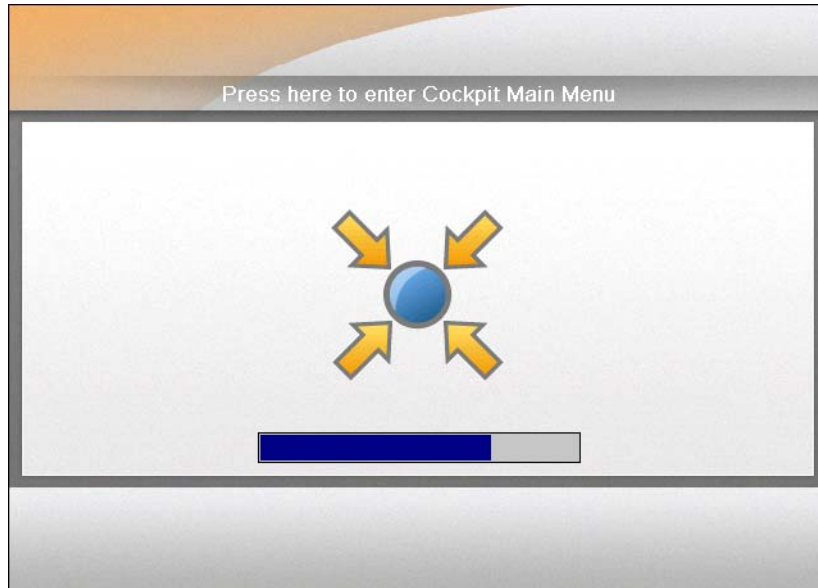

Figure 2-31 Cockpit startup phase



2. Press the button to start the cockpit before the progress bar is down.

You can customize the language of the cockpit interface at the language menu item.



3. Press the button **Language Selection**.

4. Select the desired language.



5. Confirm your selection with the green check.

**Using desktop icon to start cockpit**

You can start the cockpit via the desktop icon at already started operating devices with active desktop:



1. Briefly press twice on the desktop icon.



2. Press the button to start the cockpit before the progress bar is down.

You can customize the language of the cockpit interface at the language menu item.



3. Press the button **Language Selection**.

4. Select the desired language.



5. Confirm your selection with the green check.



For more detailed information, please also refer to the cockpit user manual which can be downloaded at [phoenixcontact.net/products](http://phoenixcontact.net/products).

## 2.5 Identification

The operating device can be identified using the nameplate on the rear of the device.



Figure 2-32 Nameplate (example)

- 1 Device type, article number
- 2 Software version (at time of delivery)
- 3 MAC address
- 4 Voltage and power specification
- 5 Serial number

## 3 Control and Display Elements

### 3.1 Touchscreen

The device is equipped with a resistive 4 wire touch screen. You operate the device using this touch screen.

**NOTICE: Damage**

Pointed or sharp objects, such as pens or fingernails, can lead to irreparable damages of the touch screen. Exclusively therefore use the fingertips or the aids indicated in the technical data for the operation.

### 3.2 Display

**DANGER: Toxic**

If the display is damaged, avoid touching, swallowing or breathing in the liquids or gases which may leak out!

**DANGER: Corrosive**

If the display is damaged, avoid touching, swallowing or breathing in the liquids or gases which may leak out!



Pixel failures, which can occur with TFT displays, are due to production and no complaint reason!

**NOTICE: Damage**

Static screen parts which displayed over a longer time period (> 1 hour) may result in so-called image sticking.

Image sticking shows itself visual like a „burn-in effect“. The screen displayed before remains visible after a change of image as shade furthermore. Higher environmental temperatures during the operation can accelerate this effect. To avoid the danger of an irreversible damage, the display must time controlled - 15 minutes are recommended - set with a black screen. Image sticking is a technologically property and only can be prevented by a suitable application. Image sticking is not appreciated by display suppliers as a guarantee reason.

The operating device is equipped with different displays (see technical data) depending on variant.



## 4 Interfaces of the Device

### 4.1 Standard Interfaces

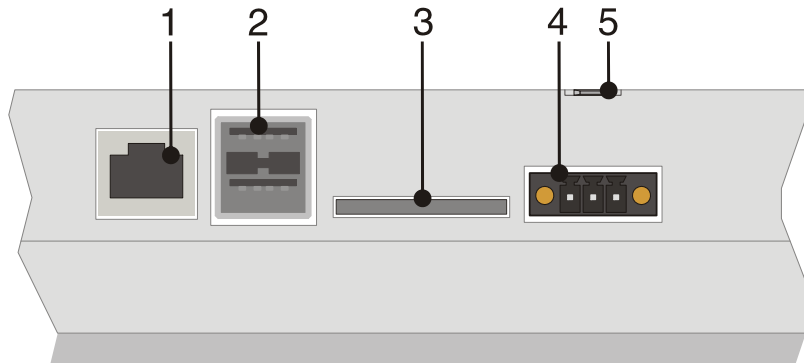

Figure 4-1 Rear view Ethernet

- 1 Female Connector X5 (Ethernet)
- 2 Female Connector X9, X10 (USB Host - Type A)
- 3 Slot for SD / SDHC Memory Card
- 4 Connector X1 (Supply Voltage)
- 5 Flat Push-on Connection for Noiseless Grounding

### 4.1.1 Ethernet (X5)

A 10/100Base-T Ethernet interface is located at the operating device.

#### 4.1.1.1 Pin Assignment

Connector in the operating device: RJ45 female connector.

Table 4-1 Assignment of the Ethernet interface

Pin	Designation	Function
1	Tx+	Transmitted Data, Positive Polarity
2	Tx-	Transmitted Data, Negative Polarity
3	Rx+	Received Data, Positive Polarity
4	n.c.	Not Connected
5	n.c.	Not Connected
6	Rx-	Received Data, Negative Polarity
7	n.c.	Not Connected
8	n.c.	Not Connected

#### 4.1.1.2 Cable



**NOTICE**

Use a twisted pair cable of category 5 (CAT 5). The maximum cable length is 100 m (328.084 feet).



See the IEEE 802.3 standard for further information.

#### 4.1.1.3 Diagnostics

Ethernet diagnostics LEDs are located at the operating device.

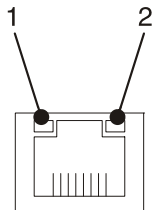

Figure 4-2 Position of the ethernet diagnostics LEDs

Table 4-2 Ethernet diagnostics LEDs

LED	Color	State	Designation	Function
1	Green	On	ACT/LNK	Connected
		Flashing		Sending / receiving ethernet data telegram
2	Yellow	On	SPD 10/100	Operation in 100 MBit/s mode
		Off		Operation in 10 MBit/s mode or disconnected

### 4.1.2 USB (X9, X10)

Two host interfaces are available on the operating device.



**NOTICE:**

Using hardware not suitable for industrial use (for example keyboard, mouse, memory card) in industrial environments may decrease safety of operation. This includes hardware intended for home and office use.

#### 4.1.2.1 Cable



For the specification of a suitable cable, please refer to the „Universal Serial Bus Specification“.



**NOTICE:**

Use industrial-suited USB cables with a length of maximally 2.5 m (8.202 feet).

### 4.1.3 Memory Card

At the underside of the operating device you can plug in an SD card.



**NOTICE:**

Using hardware not suitable for industrial use (for example keyboard, mouse, memory card) in industrial environments may decrease safety of operation. This includes hardware intended for home and office use.

#### 4.1.3.1 Inserting the memory card

When you insert the memory card, make sure the front side (side with contacts is below) of the memory card is visible. Insert the memory card until it snaps into place.

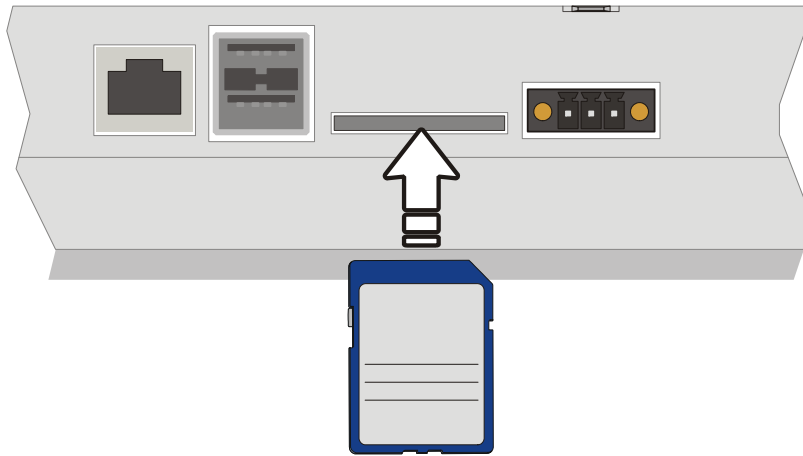

Figure 4-3 Inserting the memory card

#### 4.1.3.2 Ejecting the memory card

To remove, push the memory card into the operating device until it clicks. The memory card bounces when released automatically out of the operating device. Now you can remove the memory card.



## 4.2 Serial / Field Bus Interfaces

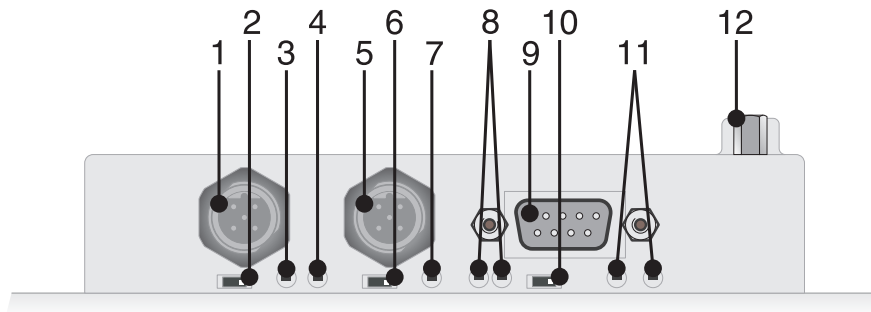

Figure 4-4 Rear view CAN

- 1 Male Connector X12 (CAN1)
- 2 Termination Switch (CAN1)
- 3 Diagnostics LEDs (CAN1)
- 4 Diagnostics LEDs (Microcontroller)
- 5 Male Connector X13 (CAN2)
- 6 Termination Switch (CAN2)
- 7 Diagnostics LEDs (CAN2)
- 8 Diagnostics LEDs (RS-422/RS-485)
- 9 Male Connector X14 (RS-422/RS-485)
- 10 Termination Switch (RS-422/RS-485)
- 11 Diagnostics LEDs (RS-232)
- 12 Male Connector X15 (RS-232)

## 4.2.1 CAN (X12, X13)

### 4.2.1.1 Pin Assignment



Figure 4-5 5 pin M12 male connector

Connector in the operating device: 5 pin M12 male connector.

Table 4-3 Pin assignment CAN 1

Pin	Designation	Function
1	nc	Not Connected
2	Reserved	Reserved for DeviceNet
3	CAN1_GND	CAN Ground
4	CAN1_H	CAN_H Bus Line
5	CAN1_L	CAN_L Bus Line

Table 4-4 Pin assignment CAN 2

Pin	Designation	Function
1	nc	Not Connected
2	Reserved	Reserved for DeviceNet
3	CAN2_GND	CAN Ground
4	CAN2_H	CAN_H Bus Line
5	CAN2_L	CAN_L Bus Line



**NOTICE:**  
The housing of the M12 connectors must be connected to the cable shield.

### 4.2.1.2 Cable



**NOTICE:**  
A shielded twisted-pair cable complying with ISO 11898-2 must be used.



**NOTICE:**  
The housing of the M12 connectors must be connected to the cable shield.



A suitable cable with the designation „SAC-5P- 2,0-920/FS SCO“ is offered by Phoenix Contact with article number 1518216.

The maximum cable length depends on the data transfer rate used.

Table 4-5 Bit rate CAN

Bit rate	Cable length
125 kBit/s	500 m
500 kBit/s	100 m
1 MBit/s	40 m

**4.2.1.3 Termination**

Terminate the CAN bus at both ends by terminating resistors (120 Ohm).



The switch positions for ON or OFF are printed onto the operating device. Only the specified switch positions are allowed.

Table 4-6 Termination switch CAN

Switch position	Function
ON	Termination (120 Ohm)
OFF	No termination

**4.2.1.4 Diagnosis**

Diagnostics LEDs are located on the rear of the operating device. The LEDs show the states of the bus system.

The diagnostics LEDs at the operating device have the following functions:

Table 4-7 Functions of the CAN diagnostics LEDs

Designation	Color	State	Function
CAN1	Green	On	Node is operational
	Green	Flashes	Node is not operational
CAN2	Green	On	Node is operational
	Green	Flashes	Node is not operational
µC	Green	Off	Microcontroller inactive
	Green	Flashes slowly	Microcontroller is operational
	Green	Flashes slowly and fast	Microcontroller is operational Requests of the host CPU are received and processed

### 4.2.2 RS-422 / RS-485 (X14)

The interface standard RS-422 / RS-485 is suitable for point-to-point and multi-point connections.

The wires belonging together are marked with „A“ and „B“. Some descriptions refer to the pins with „-“ and „+“, where A = - and B = +.

Signal Logic 1  $U_A - U_B \leq -0.3 \text{ V}$  i.e. ( $U_A < U_B$ )

Signal Logic 0  $U_A - U_B \geq +0.3 \text{ V}$  i.e. ( $U_A > U_B$ )

The interface is assigned to the port COM4. At an image version before 181 and operating system Windows CE 6.0 the port COM1 is assigned.

#### 4.2.2.1 Pin Assignment

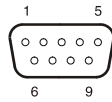

Figure 4-6 9 pin D-SUB male connector strip

Connector in the operating device: 9 pin D-SUB male connector strip.

Table 4-8 Pin assignment RS-422 / RS-485

Pin	Designation	Function		
1	SGND	Signal Ground		
2	T(B)	Transmitted Data	+	P
3	T(A)	Transmitted Data	-	N
4	R(A)	Received Data	-	N
5	R(B)	Received Data	+	P
6	nc	Not Connected		
7	nc	Not Connected		
8	nc	Not Connected		
9	nc	Not Connected		



**NOTICE:**

The D-SUB connector strips must be shielded sufficiently. See chapter “Shielding D-SUB Connectors” on page 56.

### 4.2.2.2 Termination

Always turn on the termination in a 4-wire point-to-point connection (RS-422 / RS-485). A sender termination for the quiescent level of the receiver must exist on the remote station.

Turn on the termination only at the two ends of the lines in a 2- or 4-wire multi-point connection (RS-422 / RS-485).

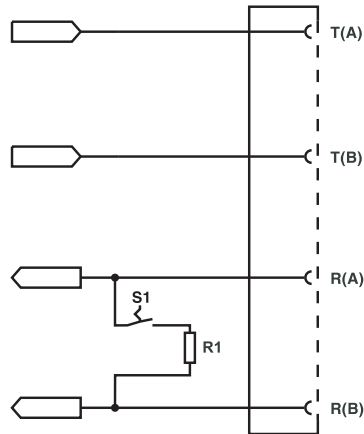

Figure 4-7 Termination possibilities RS-422 / RS-485 (intern)

Table 4-9 Resistance values termination RS-422 / RS-485

Designation	Value
R1	120 Ohm



The switch positions for ON or OFF are printed onto the operating device. Only the specified switch positions are allowed.

Table 4-10 Termination switch RS-422 / RS-485

Switch position	Function
ON	Receiver termination (120 Ohm)
OFF	No receiver termination

### 4.2.2.3 Transmitter Control

Switching between half-duplex and full-duplex is carried out by the DTR signal.

#### Full-duplex (DTR inactive / off):

The transmitter is always active and is not turned off on intermissions.  
The receiver is always active.

#### Half-duplex (DTR active / on):

The transmitter is activated during the transmission. On intermissions, the transmitter is highly resistive.  
The receiver is disabled during the transmission. The operating device does not receive the own transmit data at the receiver.

**4.2.2.4 Diagnosis**

Diagnostics LEDs are located on the rear of the operating device.

The diagnostic LEDs at the operating device have the following functions:

Table 4-11 Functions of the RS-422 / RS-485 diagnostics LEDs

<b>Designation</b>	<b>Color</b>	<b>State</b>	<b>Function</b>
Rx	Green	Flashes	Data transfer active
Tx	Yellow	Flashes	Data transfer active

### 4.2.3 RS232 (X15)

The serial RS-232 interface is suitable to establish a point-to-point connection.

The interface is assigned to the port COM3. At an image version before 181 and operating system Windows CE 6.0 the port COM0 is assigned.

#### 4.2.3.1 Pin Assignment

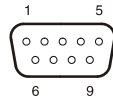

Figure 4-8 9 pin D-SUB male connector strip

Connector in the operating device: 9 pin D-SUB male connector strip.

Table 4-12 Pin assignment RS-232

Pin	Designation	Function
1	nc	Not Connected
2	RD	Received Data
3	TD	Transmitted Data
4	nc	Not Connected
5	GND	Ground
6	nc	Not Connected
7	RTS	Request to Send
8	CTS	Clear to Send
9	nc	Not Connected



**NOTICE:**

The D-SUB connector strips must be shielded sufficiently. See chapter “Shielding D-SUB Connectors” on page 56.

#### 4.2.3.2 Diagnosis

Diagnostics LEDs are located on the rear of the operating device.

The diagnostic LEDs at the operating device have the following functions:

Table 4-13 Functions of the RS-232 diagnostics LEDs

Designation	Color	State	Function
RD	Green	Flashes	Data transfer active
TD	Yellow	Flashes	Data transfer active

### 4.3 Shielding D-SUB Connectors

You must shield D-SUB connectors as follows:

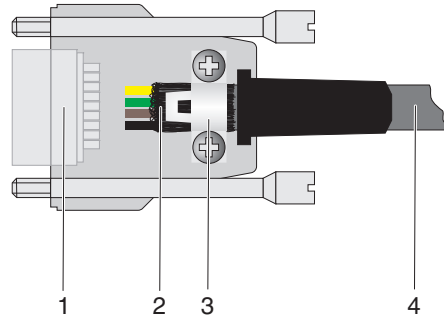

Figure 4-9 Shielding D-SUB connectors

- 1 D-SUB connector
- 2 Shield
- 3 Cable clip
- 4 Cable

The shield must be folded back into a flat position over the cable sheath.

When fastening the cable with the cable clip, as much of the shielding as possible must be in contact with the housing and sufficient strain relieve must be ensured.



## 5 Maintenance and Servicing

### 5.1 Maintenance Interval

The following maintenance intervals are recommended for this operating device:

Table 5-1 Maintenance interval

Maintenance work	Interval
Changing the Battery	4 Years

### 5.2 Front Panel

Only use a damp cloth to remove any dirt from the front panel.

### 5.3 Fuse



**NOTICE: Damage**

The semiconductor fuse cannot be replaced!

A semiconductor fuse is used to protect the device. Once the fuse has been tripped, the device must be disconnected from the supply voltage to allow the semiconductor fuse to regenerate. At an ambient temperature of 20 °C (68 °F), the regeneration takes approximately 20 seconds. The higher the ambient temperature, the longer the regeneration takes.

### 5.4 Battery

The built-in battery supplies the real-time clock with power. The minimum battery life is 5 years, even under unfavorable operating conditions.

We recommend to change the battery approximately every 4 years as part of the regular maintenance work by the service of Phoenix Contact.



## 6 Technical Data

### 6.1 General

#### Ethernet

X5 Ethernet 10/100Base-T

#### USB

Corresponds to the „Universal serial bus specification Rev. 2.0“

X9, X10 Host  
 Min.: 1.5 Mbit/s  
 Max.: 12 Mbit/s  
 Max. output current 100 mA per output

#### Field Bus Interfaces

Variable baud rates and data formats

X12 / X13 CAN  
 In accordance with ISO 11898  
 Galvanically Isolated

#### Serial Interfaces

Variable baud rates and data formats

X14 RS-422 / RS-485  
 In accordance with DIN 66259-4  
 Transmission length: 0 - 1200 m, twisted pair wire, shielded, galvanically isolated

X15 RS-232  
 In accordance with DIN 66259 T1, CCITT V.28  
 Transmission length: 0 - 15 m, conductors layered in strands, shielded, galvanically isolated

#### Central Processing Unit

Central processing unit ARM Cortex™-A8  
 Clock frequency 800 MHz  
 Other features Real-time clock, battery monitoring

#### Memory

Flash 256 MByte / 1 GByte (maximum)  
 RAM 512 MByte  
 SRAM Not available / 1 MByte (maximum)  
 SD/SDHC interface 2 GByte / 32 GByte (maximum)

#### Connection System

Male connector strip Phoenix MINI-COMBICON, 3 pin (Art.-No. 1847068)  
 RJ45 male connector  
 USB male connector type A

**Environmental Conditions**

Temperature during operation	0 °C to 50 °C (32 °F to 122 °F)
Temperature during storage, transport	- 25 °C to + 70 °C (-13°F to + 158°F)
Relative air humidity for operation and storage	20 % to 85 %, no condensation
Application area	Degree of pollution 2, overvoltage category III No direct solar radiation

**Standards and Guidelines**

Interference immunity	DIN EN 61000-4-2 DIN EN 61000-4-3 DIN EN 61000-4-4 DIN EN 61000-4-5 DIN EN 61000-4-6 DIN EN 61000-6-2
Emitted interference	DIN EN 55011 limit value class A DIN EN 55022 limit value class A DIN EN 61000-6-4
Equipment requirements	DIN EN 61131-2
Storage and transportation	DIN EN 61131-2
Power supply	DIN EN 61131-2
Electromagnetic compatibility	2014/30/EU
Degrees of protection	DIN EN 60529
Impact load, shocks	DIN EN 60068-2-27
Sinusoidal vibrations	DIN EN 60068-2-6



**NOTICE: Radio Interference**

This is a class A device. This device may cause radio interference in residential areas. In this case, the user may be required to introduce appropriate countermeasures, and to bear the cost of same.

**Approvals**

CE, UL, cUL

## 6.2 TP043STB

### Touch Screen

Type	Analog resistive, 4 wire technology
Activation force	15 g (Standard) With R8 HS60 silicon rubber
Durability	No damages or malfunctions after 3 million keystrokes as the following: Keystroke element: R8, HS40 silicon rubber Keystroke load: 150 g Keystroke frequency: 3 Hz

### Display

Size (diagonal) in cm (inch)	10.92 (4.3)
Type	TFT (color)
Resolution (pixels)	480 x 272
Colors	262144
Viewing angle (left / right / up / down) in °	75 / 75 / 63 / 75
Half-life backlighting	40,000 h
Brightness in cd/m <sup>2</sup>	385
Display area (H x W) in mm (Inch)	53.8 x 95 (2.118 x 3.74)

### Electrical Data

Supply voltage	24 V DC (SELV / PELV in accordance with DIN EN 61131)
Residual ripple	10 % maximum
Minimum voltage	18 V
Maximum voltage	30 V
Power consumption, typical at 24 V (standard / field bus)	0.2 A / 0.3 A
Connected load (standard / field bus)	4.8 W / 7.2 W
Fuse	Semiconductor fuse, self-resetting
Protection against polarity reversal	Integrated

### Front Panel and Enclosure

Enclosure	Steel sheet, galvanized
Front panel material	Aluminium, brushed, anodized natural finish
Front panel (H x W x D) in mm (Inch)	100 x 140 x 5 (3.937 x 5.511 x 0.197)
Seal	Circumferential rubber seal on the rear
Mounting cutout (H x W) in mm (Inch)	92 x 132 (3.622 x 5.196)
Mounting brackets	4
Mounting depth in mm (Inch) - (standard / field bus)	About 42 (1.653) / 71 (2.795)
Degree of protection	Front: IP65 / Enclosure Type 4X (indoor use only) Rear: IP20
Total weight	About 550 g

## 6.3 TP057STV

### Touch Screen

Type	Analog resistive, 4 wire technology
Activation force	15 g (Standard) With R8 HS60 silicon rubber
Durability	No damages or malfunctions after 3 million keystrokes as the following: Keystroke element: R8, HS40 silicon rubber Keystroke load: 150 g Keystroke frequency: 3 Hz

### Display

Size (diagonal) in cm (inch)	14.48 (5.7)
Type	TFT (color)
Resolution (pixels)	640 x 480
Colors	262144
Viewing angle (left / right / up / down) in °	65 / 65 / 55 / 52
Half-life backlighting	40,000 h
Brightness in cd/m <sup>2</sup>	400
Display area (H x W) in mm (Inch)	86.4 x 115.2 (3.402 x 4.535)

### Electrical Data

Supply voltage	24 V DC (SELV / PELV in accordance with DIN EN 61131)
Residual ripple	10 % maximum
Minimum voltage	18 V
Maximum voltage	30 V
Power consumption, typical at 24 V (standard / field bus)	0.3 A / 0.4 A
Connected load (standard / field bus)	7.2 W / 9.6 W
Fuse	Semiconductor fuse, self-resetting
Protection against polarity reversal	Integrated

### Front Panel and Enclosure

Enclosure	Steel sheet, galvanized
Front panel material	Aluminium, brushed, anodized natural finish
Front panel (H x W x D) in mm (Inch)	126 x 168 x 5 (4.961 x 6.614 x 0.197)
Seal	Circumferential rubber seal on the rear
Mounting cutout (H x W) in mm (Inch)	118 x 160 (4.645 x 6.299)
Mounting brackets	4
Mounting depth in mm (Inch) - (standard / field bus)	About 42 (1.653) / 71 (2.795)
Degree of protection	Front: IP65 / Enclosure Type 4X (indoor use only) Rear: IP20
Total weight	About 800 g

## 6.4 TP070STW

### Touch Screen

Type	Analog resistive, 4 wire technology
Activation force	15 g (Standard) With R8 HS60 silicon rubber
Durability	No damages or malfunctions after 3 million keystrokes as the following: Keystroke element: R8, HS40 silicon rubber Keystroke load: 150 g Keystroke frequency: 3 Hz

### Display

Size (diagonal) in cm (inch)	17.78 (7)
Type	TFT (color)
Resolution (pixels)	800 x 480
Colors	262144
Viewing angle (left / right / up / down) in °	70 / 70 / 65 / 65
Half-life backlighting	40,000 h
Brightness in cd/m <sup>2</sup>	350
Display area (H x W) in mm (Inch)	91.4 x 152.4 (3.598 x 6.0)

### Electrical Data

Supply voltage	24 V DC (SELV / PELV in accordance with DIN EN 61131)
Residual ripple	10 % maximum
Minimum voltage	18 V
Maximum voltage	30 V
Power consumption, typical at 24 V (standard / field bus)	0.3 A / 0.4 A
Connected load (standard / field bus)	7.2 W / 9.6 W
Fuse	Semiconductor fuse, self-resetting
Protection against polarity reversal	Integrated

### Front Panel and Enclosure

Enclosure	Steel sheet, galvanized
Front panel material	Aluminium, brushed, anodized natural finish
Front panel (H x W x D) in mm (Inch)	147 x 203 x 5 (5.787 x 7.992 x 0.197)
Seal	Circumferential rubber seal on the rear
Mounting cutout (H x W) in mm (Inch)	139 x 195 (5.7472 x 7.677)
Mounting brackets	4
Mounting depth in mm (Inch) - (standard / field bus)	About 42 (1.653) / 71 (2.795)
Degree of protection	Front: IP65 / Enclosure Type 4X (indoor use only) Rear: IP20
Total weight	About 800 g

## 6.5 TP090STW

### Touch Screen

Type	Analog resistive, 4 wire technology
Activation force	15 g (Standard) With R8 HS60 silicon rubber
Durability	No damages or malfunctions after 3 million keystrokes as the following: Keystroke element: R8, HS40 silicon rubber Keystroke load: 150 g Keystroke frequency: 3 Hz

### Display

Size (diagonal) in cm (inch)	22.86 (9)
Type	TFT (color)
Resolution (pixels)	800 x 480
Colors	16.77 million
Viewing angle (left / right / up / down) in °	85 / 85 / 85 / 85
Half-life backlighting	70.000 h
Brightness in cd/m <sup>2</sup>	800
Display area (H x W) in mm (Inch)	118 x 197 (4.645 x 7.755)

### Electrical Data

Supply voltage	24 V DC (SELV / PELV in accordance with DIN EN 61131)
Residual ripple	10 % maximum
Minimum voltage	18 V
Maximum voltage	30 V
Power consumption, typical at 24 V (standard / field bus)	0.7 A / 0.8 A
Connected load (standard / field bus)	16.8 W / 19.2 W
Fuse	Semiconductor fuse, self-resetting
Protection against polarity reversal	Integrated

### Front Panel and Enclosure

Enclosure	Steel sheet, galvanized
Front panel material	Aluminium, brushed, anodized natural finish
Front panel (H x W x D) in mm (Inch)	172 x 260 x 5 (6.772 x 10.236 x 0.197)
Seal	Circumferential rubber seal on the rear
Mounting cutout (H x W) in mm (Inch)	164 x 252 (6.456 x 9.921)
Mounting brackets	6
Mounting depth in mm (Inch) - (standard / field bus)	About 54 (2.125) / 59 (2.322)
Degree of protection	Front: IP65 / Enclosure Type 4X (indoor use only) Rear: IP20
Total weight	About 1300 g



## 6.6 TP105STS

### Touch Screen

Type	Analog resistive, 4 wire technology
Activation force	15 g (Standard) With R8 HS60 silicon rubber
Durability	No damages or malfunctions after 3 million keystrokes as the following: Keystroke element: R8, HS40 silicon rubber Keystroke load: 150 g Keystroke frequency: 3 Hz

### Display

Size (diagonal) in cm (inch)	26.42 (10.4)
Type	TFT (color)
Resolution (pixels)	800 x 600
Colors	262144
Viewing angle (left / right / up / down) in °	70 / 70 / 50 / 60
Half-life backlighting	50,000 h
Brightness in cd/m <sup>2</sup>	340
Display area (H x W) in mm (Inch)	158 x 211 (6.22 x 8.307)

### Electrical Data

Supply voltage	24 V DC (SELV / PELV in accordance with DIN EN 61131)
Residual ripple	10 % maximum
Minimum voltage	18 V
Maximum voltage	30 V
Power consumption, typical at 24 V (standard / field bus)	0.5 A / 0.6 A
Connected load (standard / field bus)	12 W / 14.4 W
Fuse	Semiconductor fuse, self-resetting
Protection against polarity reversal	Integrated

### Front Panel and Enclosure

Enclosure	Steel sheet, galvanized
Front panel material	Aluminium, brushed, anodized natural finish
Front panel (H x W x D) in mm (Inch)	220 x 295 x 5 (8.661 x 11.614 x 0.196)
Seal	Circumferential rubber seal on the rear
Mounting cutout (H x W) in mm (Inch)	212 x 287 (8.346 x 11.299)
Mounting brackets	6
Mounting depth in mm (Inch) - (standard / field bus)	About 54 (2.125) / 59 (2.322)
Degree of protection	Front: IP65 / Enclosure Type 4X (indoor use only) Rear: IP20
Total weight	About 1900 g

## 6.7 TP121STS

### Touch Screen

Type	Analog resistive, 4 wire technology
Activation force	15 g (Standard) With R8 HS60 silicon rubber
Durability	No damages or malfunctions after 3 million keystrokes as the following: Keystroke element: R8, HS40 silicon rubber Keystroke load: 150 g Keystroke frequency: 3 Hz

### Display

Size (diagonal) in cm (inch)	30.73 (12.1)
Type	TFT (color)
Resolution (pixels)	800 x 600
Colors	262144
Viewing angle (left / right / up / down) in °	80 / 80 / 60 / 80
Half-life backlighting	50,000 h
Brightness in cd/m <sup>2</sup>	360
Display area (H x W) in mm (Inch)	185 x 246 (7.283 x 9.685)

### Electrical Data

Supply voltage	24 V DC (SELV / PELV in accordance with DIN EN 61131)
Residual ripple	10 % maximum
Minimum voltage	18 V
Maximum voltage	30 V
Power consumption, typical at 24 V (standard / field bus)	0.5 A / 0.6 A
Connected load (standard / field bus)	12 W / 14.4 W
Fuse	Semiconductor fuse, self-resetting
Protection against polarity reversal	Integrated

### Front Panel and Enclosure

Enclosure	Steel sheet, galvanized
Front panel material	Aluminium, brushed, anodized natural finish
Front panel (H x W x D) in mm (Inch)	270 x 340 x 5 (10.63 x 13.386 x 0.197)
Seal	Circumferential rubber seal on the rear
Mounting cutout (H x W) in mm (Inch)	243 x 313 (9.566 x 12.322)
Mounting brackets	8
Mounting depth in mm (Inch) - (standard / field bus)	About 55 (2.165) / 60 (2.362)
Degree of protection	Front: IP65 / Enclosure Type 4X (indoor use only) Rear: IP20
Total weight	About 2.2 Kg

## 6.8 TP121STM

### Touch Screen

Type	Analog resistive, 4 wire technology
Activation force	15 g (Standard) With R8 HS60 silicon rubber
Durability	No damages or malfunctions after 3 million keystrokes as the following: Keystroke element: R8, HS40 silicon rubber Keystroke load: 150 g Keystroke frequency: 3 Hz

### Display

Size (diagonal) in cm (inch)	30.73 (12.1)
Type	TFT (color)
Resolution (pixels)	1280 x 800
Colors	65535
Viewing angle (left / right / up / down) in °	88 / 88 / 88 / 88
Half-life backlighting	50,000 h
Brightness in cd/m <sup>2</sup>	320
Display area (H x W) in mm (Inch)	163.2 x 261.1 (6.425 x 10.28)

### Electrical Data

Supply voltage	24 V DC (SELV / PELV in accordance with DIN EN 61131)
Residual ripple	10 % maximum
Minimum voltage	18 V
Maximum voltage	30 V
Power consumption, typical at 24 V (standard / field bus)	0.7 A / 0.8 A
Connected load (standard / field bus)	16.8 W / 19.2 W
Fuse	Semiconductor fuse, self-resetting
Protection against polarity reversal	Integrated

### Front Panel and Enclosure

Enclosure	Steel sheet, galvanized
Front panel material	Aluminium, brushed, anodized natural finish
Front panel (H x W x D) in mm (Inch)	225 x 330 x 5 (8.858 x 12.992 x 0.197)
Seal	Circumferential rubber seal on the rear
Mounting cutout (H x W) in mm (Inch)	217 x 322 (8.543 x 12.677)
Mounting depth in mm (Inch) - (standard / field bus)	About 48 (1.889) / 53 (2.086)
Degree of protection	Front: IP65 / Enclosure Type 4X (indoor use only) Rear: IP20
Total weight	About 1700 g

## 6.9 TP150STX

### Touch Screen

Type	Analog resistive, 4 wire technology
Activation force	15 g (Standard) With R8 HS60 silicon rubber
Durability	No damages or malfunctions after 3 million keystrokes as the following: Keystroke element: R8, HS40 silicon rubber Keystroke load: 150 g Keystroke frequency: 3 Hz

### Display

Size (diagonal) in cm (inch)	38.1 (15)
Type	TFT (color)
Resolution (pixels)	1024 x 768
Colors	65535
Viewing angle (left / right / up / down) in °	80 / 80 / 65 / 80
Half-life backlighting	50,000 h
Brightness in cd/m <sup>2</sup>	480
Display area (H x W) in mm (Inch)	228 x 304 (8.976 x 11.969)

### Electrical Data

Supply voltage	24 V DC (SELV / PELV in accordance with DIN EN 61131)
Residual ripple	10 % maximum
Minimum voltage	18 V
Maximum voltage	30 V
Power consumption, typical at 24 V (standard / field bus)	0.7 A / 0.8 A
Connected load (standard / field bus)	16.8 W / 19.2 W
Fuse	Semiconductor fuse, self-resetting
Protection against polarity reversal	Integrated

### Front Panel and Enclosure

Enclosure	Steel sheet, galvanized
Front panel material	Aluminium, brushed, anodized natural finish
Front panel (H x W x D) in mm (Inch)	329 x 400 x 5 (12.953 x 15.748 x 0.197)
Seal	Circumferential rubber seal on the rear
Mounting cutout (H x W) in mm (Inch)	301 x 372 (11.85 x 14.645)
Mounting brackets	8
Mounting depth in mm (Inch) - (standard / field bus)	About 55 (2.165) / 60 (2.362)
Degree of protection	Front: IP65 / Enclosure Type 4X (indoor use only) Rear: IP20
Total weight	About 3 Kg

## 6.10 TP154STM

### Touch Screen

Type	Analog resistive, 5 wire technology
Activation force	<= 50 g with R0,8 3H stylus or finger
Durability	Draw test: 100,000 operations Knock test: 35 million operations

### Display

Size (diagonal) in cm (inch)	39.1 (15.4)
Type	TFT (color)
Resolution (pixels)	1280 x 800
Colors	262144
Viewing angle (left / right / up / down) in °	80 / 80 / 65 / 80
Half-life backlighting	50,000 h
Brightness in cd/m <sup>2</sup>	360
Display area (H x W) in mm (Inch)	207 x 331 (8.149 x 13.031)

### Electrical Data

Supply voltage	24 V DC (SELV / PELV in accordance with DIN EN 61131)
Residual ripple	10 % maximum
Minimum voltage	18 V
Maximum voltage	30 V
Power consumption, typical at 24 V (standard / field bus)	0.8 A / 0.9 A
Connected load (standard / field bus)	19.2 W / 21.6 W
Fuse	Semiconductor fuse, self-resetting
Protection against polarity reversal	Integrated

### Front Panel and Enclosure

Enclosure	Steel sheet, galvanized
Front panel material	Aluminium, brushed, anodized natural finish
Front panel (H x W x D) in mm (Inch)	297 x 420 x 5 (11.692 x 16.535 x 0.197)
Seal	Circumferential rubber seal on the rear
Mounting cutout (H x W) in mm (Inch)	273 x 396 (10.748 x 15.59)
Mounting brackets	12
Mounting depth in mm (Inch) - (standard / field bus)	About 59 (2.322) / 64 (2.519)
Degree of protection	Front: IP65 / Enclosure Type 4X (indoor use only) Rear: IP20
Total weight	About 3.3 Kg



## A 1 Index

### B

Battery ..... 57

### C

#### Cable

CAN..... 50

Ethernet..... 46

USB..... 47

Connecting..... 38

### D

#### Diagnosis

CAN..... 51

RS-232 ..... 55

RS-422 ..... 54

RS-485 ..... 54

#### Diagnostics

Ethernet..... 46

#### Dimensions

Cutout..... 20

Front panel ..... 11

Display ..... 43

### F

#### Front panel dimensions

TP043STB..... 11

TP057STV ..... 12

TP070STW..... 13

TP090STW..... 14

TP105STS..... 15

TP121STM..... 17

TP121STS..... 16

TP150STX..... 18

TP154STM..... 19

Fuse..... 57

### I

Identification..... 42

Intended use ..... 8

### Interface

CAN ..... 50

Ethernet..... 46

RS-232..... 55

RS-422..... 52

RS-485..... 52

USB..... 47

### M

Maintenance ..... 57

Maintenance interval..... 57

Memory card..... 48

Mounting..... 10

#### Mounting cutout

TP043STB..... 20

TP057STV..... 21

TP070STW..... 22

TP090STW..... 23

TP105STS..... 24

TP121STM..... 26

TP121STS..... 25

TP150STX..... 27

TP154STM..... 28

#### Mounting depth

TP043STB..... 29

TP057STV..... 30

TP070STW..... 31

TP090STW..... 32

TP105STS..... 33

TP121STM..... 35

TP121STS..... 34

TP150STX..... 36

TP154STM..... 37

### N

Nameplate ..... 42

**P**

Pin assignment

- CAN..... 50
- Ethernet..... 46
- RS-232 ..... 55
- RS-422 ..... 52
- RS-485 ..... 52

**R**

Rear view

- CAN..... 49
- Ethernet..... 45

**S**

Safety notes ..... 7

Servicing ..... 57

Side view

- TP043STB..... 29
- TP057STV..... 30
- TP070STW..... 31
- TP090STW..... 32
- TP105STS..... 33
- TP121STM..... 35
- TP121STS..... 34
- TP150STX..... 36
- TP154STM ..... 37

Standards ..... 60

Supply Voltage..... 38

Switching on..... 40

Symbols ..... 7

**T**

Target group ..... 8

Technical data..... 59

- TP043STB..... 61
- TP057STV..... 62
- TP070STW..... 63
- TP090STW..... 64
- TP105STS..... 65
- TP121STM..... 67
- TP121STS..... 66
- TP150STX..... 68
- TP154STM..... 69

Termination

- CAN ..... 51
- RS-485..... 53
- Touchscreen ..... 43

**U**

Unpacking..... 9