

SIEMENS

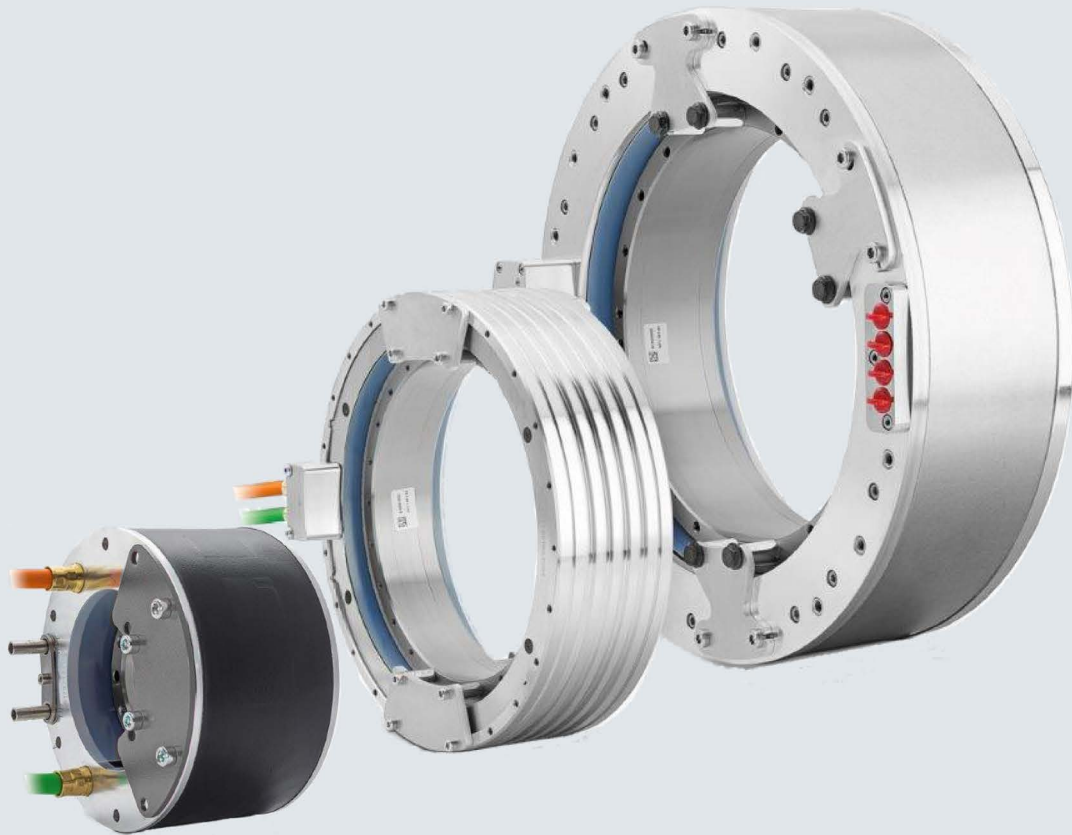

Configuration Manual

SIMOTICS

Built-in torque motors
SIMOTICS T-1FW6

For SINAMICS S120

Edition

07/2017

www.siemens.com

SIEMENS

SIMOTICS

Drive Technology 1FW6 Built-in torque motors

Configuration Manual

Introduction

Fundamental safety instructions

1

Description of the motor

2

Mechanical properties

3

Motor components and options

4

Configuration

5

Technical data and characteristics

6

Preparation for use

7

Electrical connection

8

Installation drawings/Dimension drawings

9

Coupled motors

10



Appendix

A

Legal information

Warning notice system

This manual contains notices you have to observe in order to ensure your personal safety, as well as to prevent damage to property. The notices referring to your personal safety are highlighted in the manual by a safety alert symbol, notices referring only to property damage have no safety alert symbol. These notices shown below are graded according to the degree of danger.

 DANGER
indicates that death or severe personal injury will result if proper precautions are not taken.
 WARNING
indicates that death or severe personal injury may result if proper precautions are not taken.
 CAUTION
indicates that minor personal injury can result if proper precautions are not taken.
NOTICE
indicates that property damage can result if proper precautions are not taken.

If more than one degree of danger is present, the warning notice representing the highest degree of danger will be used. A notice warning of injury to persons with a safety alert symbol may also include a warning relating to property damage.

Qualified Personnel

The product/system described in this documentation may be operated only by **personnel qualified** for the specific task in accordance with the relevant documentation, in particular its warning notices and safety instructions. Qualified personnel are those who, based on their training and experience, are capable of identifying risks and avoiding potential hazards when working with these products/systems.

Proper use of Siemens products

Note the following:

 WARNING
Siemens products may only be used for the applications described in the catalog and in the relevant technical documentation. If products and components from other manufacturers are used, these must be recommended or approved by Siemens. Proper transport, storage, installation, assembly, commissioning, operation and maintenance are required to ensure that the products operate safely and without any problems. The permissible ambient conditions must be complied with. The information in the relevant documentation must be observed.

Trademarks

All names identified by ® are registered trademarks of Siemens AG. The remaining trademarks in this publication may be trademarks whose use by third parties for their own purposes could violate the rights of the owner.

Disclaimer of Liability

We have reviewed the contents of this publication to ensure consistency with the hardware and software described. Since variance cannot be precluded entirely, we cannot guarantee full consistency. However, the information in this publication is reviewed regularly and any necessary corrections are included in subsequent editions.

Introduction

Standard version

This documentation only describes the functionality of the standard version. The machine OEM documents any extensions or changes to the motor made by it.

For reasons of clarity, this documentation cannot contain all of the detailed information on all of the product types. Moreover, this documentation cannot take into consideration every possible type of installation, operation, and maintenance.

This documentation should be kept in a location where it can be easily accessed and made available to the personnel responsible.

Target group

This manual is aimed at planning, project, and design engineers as well as electricians, fitters, and service personnel.

Benefits

This configuration manual enables the target group to comply with the rules and guidelines that apply when torque motors are configured. It helps you select products and functions.

Text features

In addition to the notes that you must observe for your own personal safety as well as to avoid material damage, in this document you will find the following text features:

Operating instructions

Operating instructions with the specified sequence are designated using the following symbols:



The arrow indicates the start of the operating instructions.

The individual handling steps are numbered.

1. Execute the operating instructions in the specified sequence.



The square indicates the end of the operating instruction.

Operating instructions without a specified sequence are identified using a bullet point:

- Execute the operating instructions.

Enumerations

- Enumerations are identified by a bullet point without any additional symbols.
 - Enumerations at the second level are hyphenated.

Notes

Notes are shown as follows:

Note

A Note is an important item of information about the product, handling of the product or the relevant section of the document. Notes provide you with help or further suggestions/ideas.

More information

Information on the following topics is available at:

- Ordering documentation / overview of documentation
- Additional links to download documents
- Using documentation online (find and search in manuals / information)

More information (<https://support.industry.siemens.com/cs/de/en/view/108998034>)

If you have any questions regarding the technical documentation (e.g. suggestions, corrections), please send an e-mail to the following address E-mail (<mailto:docu.motioncontrol@siemens.com>).

Internet address for products

Products (<http://www.siemens.com/motioncontrol>)

My support

The following link provides information on how to create your own individual documentation based on Siemens content, and adapt it for your own machine documentation:

My support (<https://support.industry.siemens.com/My/de/en/documentation>)

Note

If you want to use this function, you must first register.

Later, you can log on with your login data.

Training

The following link provides information on SITRAIN - training from Siemens for products, systems and automation engineering solutions:

SITRAIN (<http://siemens.com/sitrain>)

Technical Support

Country-specific telephone numbers for technical support are provided on the Internet under Contact:

Technical Support (<https://support.industry.siemens.com>)

Usage phases and their documents/tools

Table 1 Usage phases and the required documents/tools

Usage phase	Document / tool / measure
Orientation	<ul style="list-style-type: none"> • SINAMICS S Sales Documentation • Siemens Internet pages Motion Control
Planning / configuring	<ul style="list-style-type: none"> • SIZER configuration tool • CAD-Creator selection and engineering tool for dimension drawings, 2D/3D CAD data, generating system documentation • DT Configurator to select and configure drive products • Configuration Manuals, Motors • Configuring notes from Catalogs NC 61 and NC 62 • SINAMICS S120 Configuration Manuals • SINAMICS S120 Safety Integrated Function Manual • SINAMICS S120 List Manual • Technical Support <ul style="list-style-type: none"> – Mechatronic support – Application support – Technical Application Center
Deciding / ordering	<ul style="list-style-type: none"> • Catalogs NC 61, NC 62, PM 21 • SIZER configuring tool (generating parts lists)
Transporting / storing	<ul style="list-style-type: none"> • Operating instructions, motors

Usage phase	Document / tool / measure
Installation / mounting	<ul style="list-style-type: none"> • Operating instructions, motors • Installation instructions for the machine • SINAMICS S120 Manuals • Documentation for encoders • Examples of additional, possibly necessary documentation for the following system components: <ul style="list-style-type: none"> – Cooling system – Brake – Line filter – HFD reactor or Active Interface Module
Commissioning / operating	<ul style="list-style-type: none"> • Siemens commissioning training courses (SITRAIN courses) • Commissioning support provided by Siemens • Operating instructions, motors • Configuration Manual Motors • STARTER commissioning tool • SINAMICS S120 Getting Started • SINAMICS S120 Manuals • SINAMICS S120 Commissioning Manual • SINAMICS S120 List Manual • SINAMICS S120 Function Manuals • Documentation for encoders • Examples of additional, possibly necessary documentation for the following system components: <ul style="list-style-type: none"> – Cooling system – Brake – Line filter – HFD reactor or Active Interface Module
Maintenance / decommissioning / disposal	<ul style="list-style-type: none"> • Operating instructions, motors

Websites of third parties

This publication contains hyperlinks to websites of third parties. Siemens does not take any responsibility for the contents of these websites or adopt any of these websites or their contents as their own, because Siemens does not control the information on these websites and is also not responsible for the contents and information provided there. Use of these websites is at the risk of the person doing so.

Information regarding third-party products

Note

Recommendation relating to third-party products

This document contains recommendations relating to third-party products. Siemens accepts the fundamental suitability of these third-party products.

You can use equivalent products from other manufacturers.

Siemens does not accept any warranty for the properties of third-party products.

Table of contents

	Introduction	3
1	Fundamental safety instructions	13
1.1	General safety instructions	13
1.2	Equipment damage due to electric fields or electrostatic discharge	19
1.3	Industrial security	20
1.4	Residual risks of power drive systems.....	21
2	Description of the motor	23
2.1	Highlights and benefits.....	24
2.1.1	Overview	24
2.1.2	Benefits	25
2.2	Use for the intended purpose	26
2.3	Technical features and ambient conditions	28
2.3.1	Directives and standards	28
2.3.2	Danger from strong magnetic fields.....	29
2.3.3	Technical features.....	34
2.3.4	Defining the direction of rotation	36
2.3.5	Environmental conditions for stationary use	36
2.3.6	Scope of delivery	38
2.3.6.1	Built-in torque motor with a cooling jacket	38
2.3.6.2	Built-in torque motor with integrated cooling	38
2.3.6.3	Supplied pictograms	38
2.4	Derating factors.....	39
2.5	Selection and ordering data	40
2.5.1	Order designation	40
2.5.1.1	Standard 1FW6 built-in torque motor.....	41
2.5.1.2	Stator as individual component.....	42
2.5.1.3	Rotor as individual component	43
2.5.1.4	Ordering notes	43
2.5.1.5	Ordering examples.....	44
2.5.2	Selection and ordering data 1FW6	44
2.6	Rating plate data.....	52
3	Mechanical properties	53
3.1	Cooling.....	53
3.1.1	Cooling circuits.....	54
3.1.2	Coolant.....	58
3.2	Degree of protection	60
3.3	Vibration response.....	60
3.4	Noise emission.....	61

3.5	Service and inspection intervals	61
3.5.1	Safety instructions for maintenance.....	61
3.5.2	Maintenance work.....	67
3.5.3	Checking the insulation resistance	68
3.5.4	The inspection and change intervals for the coolant	69
4	Motor components and options	71
4.1	Motor components	71
4.1.1	Overview of the motor construction	71
4.1.1.1	Motors with a cooling jacket.....	71
4.1.1.2	Motors with integrated cooling	72
4.1.1.3	Cooling method.....	74
4.1.2	Temperature monitoring and thermal motor protection	74
4.1.2.1	Temperature monitoring circuits Temp-S and Temp-F.....	74
4.1.2.2	Technical features of temperature sensors	78
4.1.3	Encoders	82
4.1.4	Bearings	87
4.1.5	Braking concepts.....	88
4.2	Options.....	91
4.2.1	Round sealing ring (O ring).....	91
4.2.2	Cooling connection adapter	91
4.2.3	Plug connector	92
5	Configuration	93
5.1	Configuring software	93
5.1.1	SIZER configuration tool.....	93
5.1.2	STARTER drive/commissioning software	94
5.2	Configuring workflow.....	94
5.2.1	General mechanical conditions.....	96
5.2.2	Type of load cycle	97
5.2.3	Torque-time diagram.....	100
5.2.4	Selecting motors	103
5.2.5	Uneven current load.....	103
5.2.6	Motor torque-speed diagram.....	104
5.2.7	Torque-speed requirements.....	106
5.2.8	Checking the moments of inertia	107
5.2.9	Selecting the drive system components for the power connection.....	108
5.2.10	Calculation of the required infeed	109
5.2.11	Voltage Protection Module.....	109
5.3	Examples	110
5.4	Installation	115
5.4.1	Safety instructions for mounting.....	115
5.4.2	Forces that occur between the stator and rotor	119
5.4.3	Installation device.....	121
5.4.4	Specifications relating to the mounting side	125
5.4.5	Specifications for mounting torque motors	126
5.4.6	Procedure when installing the motor	128

5.4.7	Cooler connection	130
5.4.7.1	Cooler connection for motors with a cooling jacket	130
5.4.7.2	Cooler connection for motors with integrated cooling.....	132
5.4.7.3	Hoses for the cooling system.....	142
5.4.7.4	Cooling connection adapter	142
5.4.8	Checking the work performed	145
5.4.9	Installation examples	146
6	Technical data and characteristics	155
6.1	Explanations of the formula abbreviations.....	155
6.2	Data sheets and diagrams	163
6.2.1	1FW6050-xxxxx-xxxx.....	164
6.2.2	1FW6060-xxxxx-xxxx.....	191
6.2.3	1FW6090-xxxxx-xxxx.....	220
6.2.4	1FW6130-xxxxx-xxxx.....	244
6.2.5	1FW6150-xxxxx-xxxx.....	268
6.2.6	1FW6160-xxxxx-xxxx.....	292
6.2.7	1FW6190-xxxxx-xxxx.....	341
6.2.8	1FW6230-xxxxx-xxxx.....	390
6.2.9	1FW6290-xxxxx-xxxx.....	438
7	Preparation for use	465
7.1	Transporting	467
7.1.1	Ambient conditions for transportation	467
7.1.2	Packaging specifications for transport by air	468
7.1.3	Lifting rotors	468
7.2	Storage	469
7.2.1	Ambient conditions for long-term storage	469
7.2.2	Storage in rooms and protection against humidity	470
8	Electrical connection	471
8.1	Permissible line system types.....	473
8.2	Motor circuit diagram	474
8.3	System integration	475
8.3.1	Drive system	475
8.3.2	Sensor Module SME12x	478
8.3.3	TM120 Terminal Module.....	479
8.3.4	SMC20 Sensor Module.....	479
8.3.5	Electrical connection components	480
8.3.6	Data for the power cable at the stator.....	506
8.3.7	PIN assignments for plug connectors	510
8.3.8	Power connection	512
8.3.9	Signal connection.....	512
8.3.10	Shielding, grounding, and equipotential bonding.....	515
8.3.11	Requirements for the motor supply cables	516

9	Installation drawings/Dimension drawings	519
9.1	Installation situation for motors with a cooling jacket.....	519
9.2	Information on the installation drawings	519
9.3	Installation drawing/dimension drawing 1FW6050-xxB	522
9.4	Installation drawing/dimension drawing 1FW6060-xxB	526
9.5	Installation drawing/dimension drawing 1FW6090-xxB	530
9.6	Installation drawing/dimension drawing 1FW6130-xxB	531
9.7	Installation drawing/dimension drawing 1FW6150-xxB	532
9.8	Installation drawing/dimension drawing 1FW6160-xxB	534
9.9	Installation drawing/dimension drawing 1FW6190-xxB	535
9.10	Installation drawing/dimension drawing 1FW6230-xxB	536
9.11	Installation drawing/dimension drawing 1FW6290-xxB	537
10	Coupled motors	539
10.1	Operating motors connected to an axis in parallel.....	539
10.2	Master and stoker	540
10.3	Machine design and adjustment of the phase angle	541
10.4	Connection examples for parallel operation	543
10.5	Janus arrangement for 1FW505 and 1FW606	547
A	Appendix	549
A.1	Recommended manufacturers.....	549
A.1.1	Supply sources for connection components and accessories for heat-exchanger units	549
A.1.2	Supply sources for cooling systems	550
A.1.3	Supply sources for anti-corrosion agents	550
A.1.4	Supply sources for braking elements.....	550
A.2	List of abbreviations	551
A.3	Environmental compatibility	552
A.3.1	Environmental compatibility during production	552
A.3.2	Disposal	552
A.3.2.1	Guidelines for disposal.....	552
A.3.2.2	Disposing of 1FW6 rotors	553
A.3.2.3	Disposal of packaging.....	553
	Index	555

Fundamental safety instructions

1.1 General safety instructions



! WARNING

Electric shock and danger to life due to other energy sources

Touching live components can result in death or severe injury.

- Only work on electrical devices when you are qualified for this job.
- Always observe the country-specific safety rules.

Generally, the following six steps apply when establishing safety:

1. Prepare for disconnection. Notify all those who will be affected by the procedure.
2. Isolate the drive system from the power supply and take measures to prevent it being switched back on again.
3. Wait until the discharge time specified on the warning labels has elapsed.
4. Check that there is no voltage between any of the power connections, and between any of the power connections and the protective conductor connection.
5. Check whether the existing auxiliary supply circuits are de-energized.
6. Ensure that the motors cannot move.
7. Identify all other dangerous energy sources, e.g. compressed air, hydraulic systems, or water. Switch the energy sources to a safe state.
8. Check that the correct drive system is completely locked.

After you have completed the work, restore the operational readiness in the inverse sequence.



! WARNING

Electric shock due to connection to an unsuitable power supply

When equipment is connected to an unsuitable power supply, exposed components may carry a hazardous voltage that might result in serious injury or death.

- Only use power supplies that provide SELV (Safety Extra Low Voltage) or PELV (Protective Extra Low Voltage) output voltages for all connections and terminals of the electronics modules.



⚠ WARNING
Electric shock due to damaged motors or devices
Improper handling of motors or devices can damage them.
Hazardous voltages can be present at the enclosure or at exposed components on damaged motors or devices.
<ul style="list-style-type: none">• Ensure compliance with the limit values specified in the technical data during transport, storage and operation.• Do not use any damaged motors or devices.



⚠ WARNING
Electric shock due to unconnected cable shield
Hazardous touch voltages can occur through capacitive cross-coupling due to unconnected cable shields.
<ul style="list-style-type: none">• As a minimum, connect cable shields and the conductors of power cables that are not used (e.g. brake cores) at one end at the grounded housing potential.



⚠ WARNING
Electric shock if there is no ground connection
For missing or incorrectly implemented protective conductor connection for devices with protection class I, high voltages can be present at open, exposed parts, which when touched, can result in death or severe injury.
<ul style="list-style-type: none">• Ground the device in compliance with the applicable regulations.



⚠ WARNING
Arcing when a plug connection is opened during operation
Opening a plug connection when a system is operation can result in arcing that may cause serious injury or death.
<ul style="list-style-type: none">• Only open plug connections when the equipment is in a voltage-free state, unless it has been explicitly stated that they can be opened in operation.

NOTICE**Property damage due to loose power connections**

Insufficient tightening torques or vibration can result in loose power connections. This can result in damage due to fire, device defects or malfunctions.

- Tighten all power connections to the prescribed torque.
- Check all power connections at regular intervals, particularly after equipment has been transported.

 **WARNING****Unexpected movement of machines caused by radio devices or mobile phones**

When radio devices or mobile phones with a transmission power > 1 W are used in the immediate vicinity of components, they may cause the equipment to malfunction. Malfunctions may impair the functional safety of machines and can therefore put people in danger or lead to property damage.

- If you come closer than around 2 m to such components, switch off any radios or mobile phones.
- Use the "SIEMENS Industry Online Support App" only on equipment that has already been switched off.

 **WARNING****Unrecognized dangers due to missing or illegible warning labels**

Dangers might not be recognized if warning labels are missing or illegible. Unrecognized dangers may cause accidents resulting in serious injury or death.

- Check that the warning labels are complete based on the documentation.
- Attach any missing warning labels to the components, where necessary in the national language.
- Replace illegible warning labels.

! WARNING

Unexpected movement of machines caused by inactive safety functions

Inactive or non-adapted safety functions can trigger unexpected machine movements that may result in serious injury or death.

- Observe the information in the appropriate product documentation before commissioning.
- Carry out a safety inspection for functions relevant to safety on the entire system, including all safety-related components.
- Ensure that the safety functions used in your drives and automation tasks are adjusted and activated through appropriate parameterizing.
- Perform a function test.
- Only put your plant into live operation once you have guaranteed that the functions relevant to safety are running correctly.

Note

Important safety notices for Safety Integrated functions

If you want to use Safety Integrated functions, you must observe the safety notices in the Safety Integrated manuals.

! WARNING

Failure of pacemakers or implant malfunctions due to electromagnetic fields

Electromagnetic fields (EMF) are generated by the operation of electrical power equipment, such as transformers, converters, or motors. People with pacemakers or implants are at particular risk in the immediate vicinity of this equipment.

- If you have a heart pacemaker or implant, maintain the minimum distance specified in chapter "Correct usage" from such motors.

**⚠ WARNING****Failure of pacemakers or implant malfunctions due to permanent magnetic fields**

Even when switched off, electric motors with permanent magnets represent a potential risk for persons with heart pacemakers or implants if they are close to converters/motors.

- If you have a heart pacemaker or implant, maintain the minimum distance specified in chapter "Correct usage".
- When transporting or storing permanent-magnet motors always use the original packing materials with the warning labels attached.
- Clearly mark the storage locations with the appropriate warning labels.
- IATA regulations must be observed when transported by air.

⚠ WARNING**Injury caused by moving or ejected parts**

Contact with moving motor parts or drive output elements and the ejection of loose motor parts (e.g. feather keys) out of the motor enclosure can result in severe injury or death.

- Remove any loose parts or secure them so that they cannot be flung out.
- Do not touch any moving parts.
- Safeguard all moving parts using the appropriate safety guards.

⚠ WARNING**Fire due to inadequate cooling**

Inadequate cooling can cause the motor to overheat, resulting in death or severe injury as a result of smoke and fire. This can also result in increased failures and reduced service lives of motors.

- Comply with the specified cooling requirements for the motor.

 **WARNING**

Fire due to incorrect operation of the motor

When incorrectly operated and in the case of a fault, the motor can overheat resulting in fire and smoke. This can result in severe injury or death. Further, excessively high temperatures destroy motor components and result in increased failures as well as shorter service lives of motors.

- Operate the motor according to the relevant specifications.
- Only operate the motors in conjunction with effective temperature monitoring.
- Immediately switch off the motor if excessively high temperatures occur.



 **CAUTION**

Burn injuries caused by hot surfaces

In operation, the motor can reach high temperatures, which can cause burns if touched.

- Mount the motor so that it is not accessible in operation.

Measures when maintenance is required:

- Allow the motor to cool down before starting any work.
- Use the appropriate personnel protection equipment, e.g. gloves.

1.2 Equipment damage due to electric fields or electrostatic discharge

Electrostatic sensitive devices (ESD) are individual components, integrated circuits, modules or devices that may be damaged by either electric fields or electrostatic discharge.



NOTICE

Equipment damage due to electric fields or electrostatic discharge

Electric fields or electrostatic discharge can cause malfunctions through damaged individual components, integrated circuits, modules or devices.

- Only pack, store, transport and send electronic components, modules or devices in their original packaging or in other suitable materials, e.g. conductive foam rubber or aluminum foil.
- Only touch components, modules and devices when you are grounded by one of the following methods:
 - Wearing an ESD wrist strap
 - Wearing ESD shoes or ESD grounding straps in ESD areas with conductive flooring
- Only place electronic components, modules or devices on conductive surfaces (table with ESD surface, conductive ESD foam, ESD packaging, ESD transport container).

1.3 Industrial security

Note

Industrial security

Siemens provides products and solutions with industrial security functions that support the secure operation of plants, systems, machines and networks.

In order to protect plants, systems, machines and networks against cyber threats, it is necessary to implement – and continuously maintain – a holistic, state-of-the-art industrial security concept. Siemens products and solutions only represent one component of such a concept.

The customer is responsible for preventing unauthorized access to its plants, systems, machines and networks. Systems, machines and components should only be connected to the enterprise network or the internet if and to the extent necessary and with appropriate security measures (e.g. use of firewalls and network segmentation) in place.

Additionally, Siemens' guidance on appropriate security measures should be taken into account. For more information about industrial security, please visit:

Industrial security (<http://www.siemens.com/industrialsecurity>).

Siemens' products and solutions undergo continuous development to make them more secure. Siemens strongly recommends to apply product updates as soon as available and to always use the latest product versions. Use of product versions that are no longer supported, and failure to apply latest updates may increase customer's exposure to cyber threats.

To stay informed about product updates, subscribe to the Siemens Industrial Security RSS Feed at:

Industrial security (<http://www.siemens.com/industrialsecurity>).

WARNING

Unsafe operating states resulting from software manipulation

Software manipulations (e.g. viruses, trojans, malware or worms) can cause unsafe operating states in your system that may lead to death, serious injury, and property damage.

- Keep the software up to date.
- Incorporate the automation and drive components into a holistic, state-of-the-art industrial security concept for the installation or machine.
- Make sure that you include all installed products into the holistic industrial security concept.
- Protect files stored on exchangeable storage media from malicious software by with suitable protection measures, e.g. virus scanners.

1.4 Residual risks of power drive systems

When assessing the machine- or system-related risk in accordance with the respective local regulations (e.g., EC Machinery Directive), the machine manufacturer or system installer must take into account the following residual risks emanating from the control and drive components of a drive system:

1. Unintentional movements of driven machine or system components during commissioning, operation, maintenance, and repairs caused by, for example,
 - Hardware and/or software errors in the sensors, control system, actuators, and cables and connections
 - Response times of the control system and of the drive
 - Operation and/or environmental conditions outside the specification
 - Condensation/conductive contamination
 - Parameterization, programming, cabling, and installation errors
 - Use of wireless devices/mobile phones in the immediate vicinity of electronic components
 - External influences/damage
 - X-ray, ionizing radiation and cosmic radiation
2. Unusually high temperatures, including open flames, as well as emissions of light, noise, particles, gases, etc., can occur inside and outside the components under fault conditions caused by, for example:
 - Component failure
 - Software errors
 - Operation and/or environmental conditions outside the specification
 - External influences/damage
3. Hazardous shock voltages caused by, for example:
 - Component failure
 - Influence during electrostatic charging
 - Induction of voltages in moving motors
 - Operation and/or environmental conditions outside the specification
 - Condensation/conductive contamination
 - External influences/damage
4. Electrical, magnetic and electromagnetic fields generated in operation that can pose a risk to people with a pacemaker, implants or metal replacement joints, etc., if they are too close
5. Release of environmental pollutants or emissions as a result of improper operation of the system and/or failure to dispose of components safely and correctly
6. Influence of network-connected communication systems, e.g. ripple-control transmitters or data communication via the network

For more information about the residual risks of the drive system components, see the relevant sections in the technical user documentation.

Description of the motor

1FW6 built-in torque motor

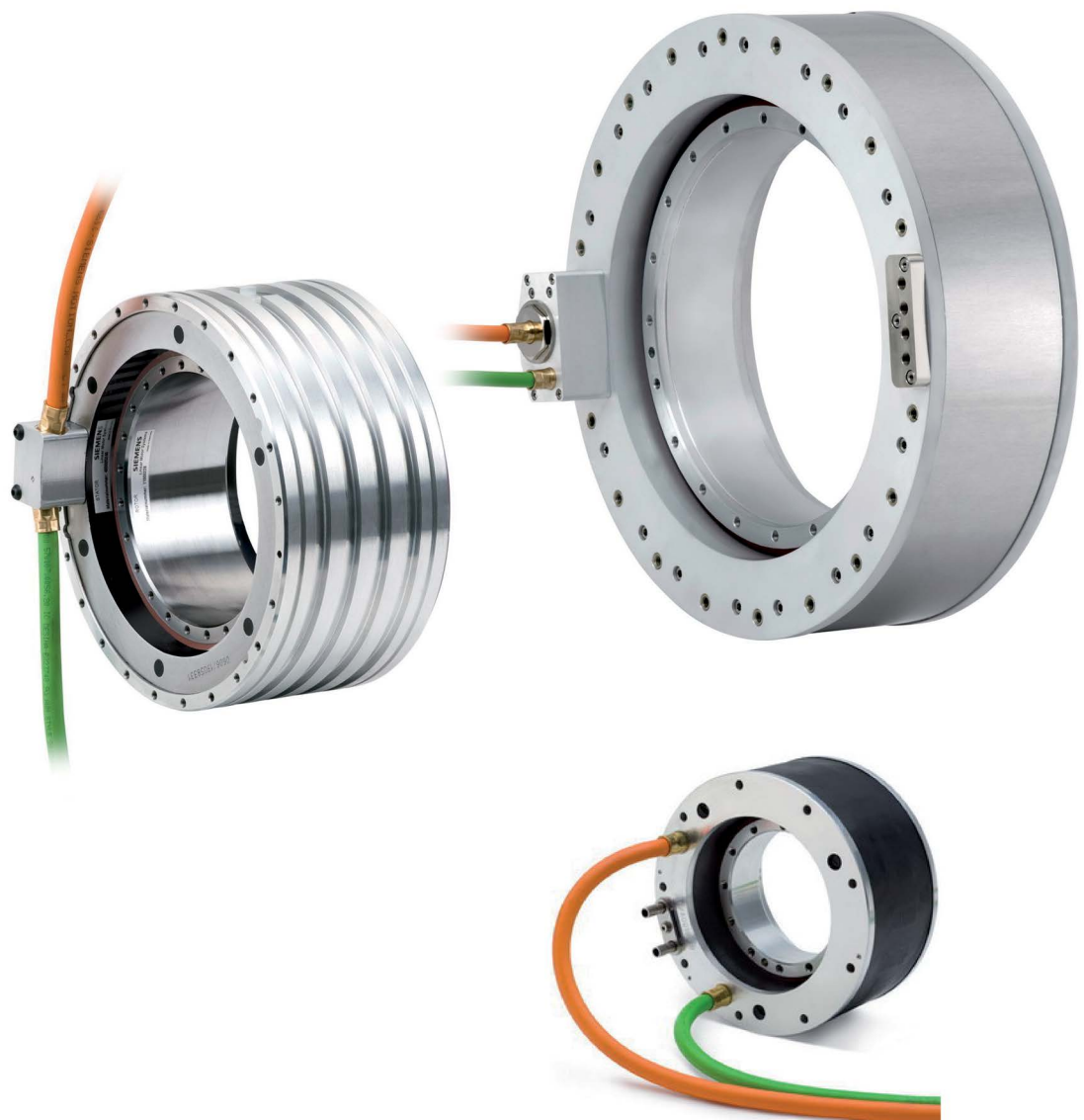

Figure 2-1 1FW6 built-in torque motors with cooling jacket (left) and with integrated cooling (right)

2.1 Highlights and benefits

2.1.1 Overview

Built-in SIMOTICS T-1FW6 torque motors are designed as built-in motors for use in low-speed direct drives with a high torque output.

These built-in torque motors are liquid-cooled, permanent-magnet-excited, high-pole-number three-phase synchronous motors with hollow-shaft rotors. The motors are delivered as components that are subsequently built-in. When delivered, the stator and rotor are kept together using transport locks and the rotor is protected using a spacer film. For a complete drive unit, bearings and rotary encoder are required.

The product range includes 9 frame sizes (or external diameters), each with at least 4 different axis lengths. Most of the motors are available for at least two different speed ranges. Most of the stators and rotors are equipped with flanges at both ends with centering surfaces and tapped holes, which allow them to be integrated into a machine.

The motors are designed for the SINAMICS S120 drive system.

You can use Motor Modules in the "blocksize", "booksize" or "chassis" formats.

Accuracy

The accuracy of a direct drive with torque motor is governed by the:

- Mechanical design of the machine
- Control technology used
- Resolution and measuring accuracy of the encoder

Mechanical system

The potential machining accuracy of a drive system with torque motor is influenced by the:

- Mechanical rigidity and noise immunity of the drive system
- Running smoothness

The running smoothness in the axial and radial direction depends on the bearing version and its accuracy. The requirements here can be fulfilled by means of a suitable axes design.

Control quality

The control quality of a direct drive with torque motor is governed by the:

- Rigidity of the drive system (dynamic quality of the machine construction, bearing, encoder mounting)
- The precision when mounting and adjusting the encoder system
- Quantification of the angular signal and speed signal (the number of encoder lines and their multiplication in the encoder evaluation of the converter for each axes rotation and the measuring accuracy of the encoder are crucial here).
- Sampling time of the current, speed, and position controller.

In addition to selecting a suitable motor, encoder and controller, the precision and control quality of the machine axis is essentially determined by the integration into the overall mechanical system. As a consequence, a general recommendation for integrating the motor cannot be given for all axis concepts.

To ensure that the motor and the encoder are optimally integrated into the mechanical structure, Siemens offers its Mechatronic Support service, see Catalog. For additional information, please contact your Siemens contact person, also refer to the Internet link in the Introduction under "Technical Support".

2.1.2 Benefits

Features of the motors:

- Extremely high power density
- High torque with a compact design and low unit volume
- Wide range of types
- High overload capability (factor 1.4 to 2.2)
- The maximum motor current is adapted to the Motor Modules of the SINAMICS S120 drive system
- Low moment of inertia
- High degree of availability as there are no gearbox components in the mechanical drive transmission line which are subject to wear
- Water cooling to increase the rated power
- Directly flanged to the machine
- Cable outlet, axial, radial towards the outside or tangential for most frame sizes

As a result of water cooling, they fulfill high requirements regarding the thermal behavior within the machine assembly.

2.2 Use for the intended purpose

 WARNING
Risk of death and material damage as a result of incorrect use
<p>There is a risk of death, serious injury and/or material damage when direct drives or their components are used for a purpose for which they were not intended.</p> <ul style="list-style-type: none">• Only use the motors for industrial or commercial plants and systems.• If, in an exceptional case, the motors are not used in industrial or commercial plants and systems, then ensure that increased requirements (e.g. regarding touch protection) are complied with.• Do not install the motors in hazardous zones if the motors have not been expressly and explicitly designed and authorized for this purpose. Carefully observe any special additional notes provided.• Only use direct drives and their components for applications that Siemens has explicitly specified.• Protect the motors against dirt and contact with aggressive substances.• Ensure that the installation conditions comply with the rating plate specifications and the condition specifications contained in this documentation. Where relevant, take into account deviations regarding approvals or country-specific regulations.• Contact your local Siemens office if you have any questions relating to correct use.• If you wish to use special versions and design versions whose technical details vary from the motors described in this document, then you must contact your local Siemens office.

 WARNING
Danger to life for wearers of active implants due to magnetic and electrical fields
<p>Electric motors pose a danger to people with active medical implants, e.g. cardiac stimulators, who come close to the motors.</p> <ul style="list-style-type: none">• If you are affected, stay a minimum distance of 300 mm from the motors (tripping threshold for static magnetic fields of 0.5 mT according to the Directive 2013/35/EU).

In conjunction with the SINAMICS S120 drive system, the built-in torque motors can be used as a direct drive for the following machine applications, for example:

- Rotary axes
- Rotary tables, rotary indexing machines, sub-machine assemblies
- Turret indexing and drum indexing for single-spindle and multi-spindle machines
- Dynamic tool magazines
- Rotating spindles
- Roller and cylinder drives
- Infeed and handling axes

You can use Motor Modules in the "blocksize", "booksize" or "chassis" formats.

 **WARNING**

Personal injury and material damage by noncompliance with directive 2006/42/EC

There is a risk of death, serious injury and/or material damage if Directive 2006/42/EC is not carefully observed.

- The products included in the scope of delivery are exclusively designed for installation in a machine. Commissioning is prohibited until it has been fully established that the end product conforms with Directive 2006/42/EC.
- Please take into account all safety instructions and provide these to end users.

Please take note of national and international license terms when operating direct motors so that no patent rights are violated.

Note

Note that when 1FW6 direct motors (torque motors) are used in fork heads for machine tools or robots, a license for US patent US5584621 and the associated international patent protection may be required.

2.3 Technical features and ambient conditions

2.3.1 Directives and standards

Standards that are complied with

SIMOTICS S, SIMOTICS M, SIMOTICS L, SIMOTICS T, SIMOTICS A motors – subsequently called the "SIMOTICS motor series " – comply with the following standards:

- EN 60034-1 – Rotating electrical machines – Dimensioning and operating behavior
- EN 60204-1 – Safety of machinery – Electrical equipment of machines; general requirements

Where applicable, the SIMOTICS motor series are in conformance with the following parts of IEC / EN 60034:

Feature	Standard
Degree of protection	IEC / EN 60034-5
Cooling ¹⁾	IEC / EN 60034-6
Type of construction	IEC / EN 60034-7
Connection designations	IEC / EN 60034-8
Noise levels ¹⁾	IEC / EN 60034-9
Temperature monitoring	IEC / EN 60034-11
Vibration severity levels ¹⁾	IEC / EN 60034-14

¹⁾ Standard component, e.g. cannot be applied to built-in motors

Relevant directives

The following directives are relevant for SIMOTICS motors.

European Low-Voltage Directive

SIMOTICS motors comply with the Low-Voltage Directive 2014/35/EU.



European Machinery Directive

SIMOTICS motors do not fall within the area of validity covered by the Machinery Directive.

However, the use of the products in a typical machine application has been fully assessed for compliance with the main regulations in this directive concerning health and safety.

European EMC Directive

SIMOTICS motors do not fall within the area of validity covered by the EMC Directive. The products are not considered as devices in the sense of the directive. Installed and operated with a converter, the motor – together with the Power Drive System – must comply with the requirements laid down in the applicable EMC Directive.

Eurasian conformity

SIMOTICS motors comply with the requirements of the customs union Russia/Belarus/Kazakhstan (EAC).

China Compulsory Certification

SIMOTICS motors do not fall within the area of validity covered by the China Compulsory Certification (CCC).

CCC product certification

(<https://support.industry.siemens.com/cs/products?search=CCC&ctp=Certificate&mf=ps&=DefaultRankingDesc&pnid=13347&lc>)

Underwriters Laboratories

SIMOTICS motors are generally in compliance with UL and cUL as components of motor applications, and are appropriately listed.

Specifically developed motors and functions are the exceptions in this case. Here, it is important that you carefully observe the contents of the quotation and that there is a cUL mark on the rating plate!

Quality systems

Siemens AG employs a quality management system that meets the requirements of ISO 9001 and ISO 14001.

Certificates for SIMOTICS motors can be downloaded from the Internet at the following link:

Certificates for SIMOTICS motors

(<https://support.industry.siemens.com/cs/ww/de/ps/13347/cert>)

European RoHS directive

The SIMOTICS motor series complies with Directive 2011/65/EU to restrict the use of certain hazardous materials.

2.3.2 Danger from strong magnetic fields

Occurrence of magnetic fields

Motor components with permanent magnets generate very strong magnetic fields. In the no-current condition, the magnetic field strength of the motors comes exclusively from the magnetic fields of components equipped with permanent magnets. Additional electromagnetic fields occur in operation.

Components with permanent magnets

The rotors of the 1FW6 built-in torque motors described in this manual contain permanent magnets.

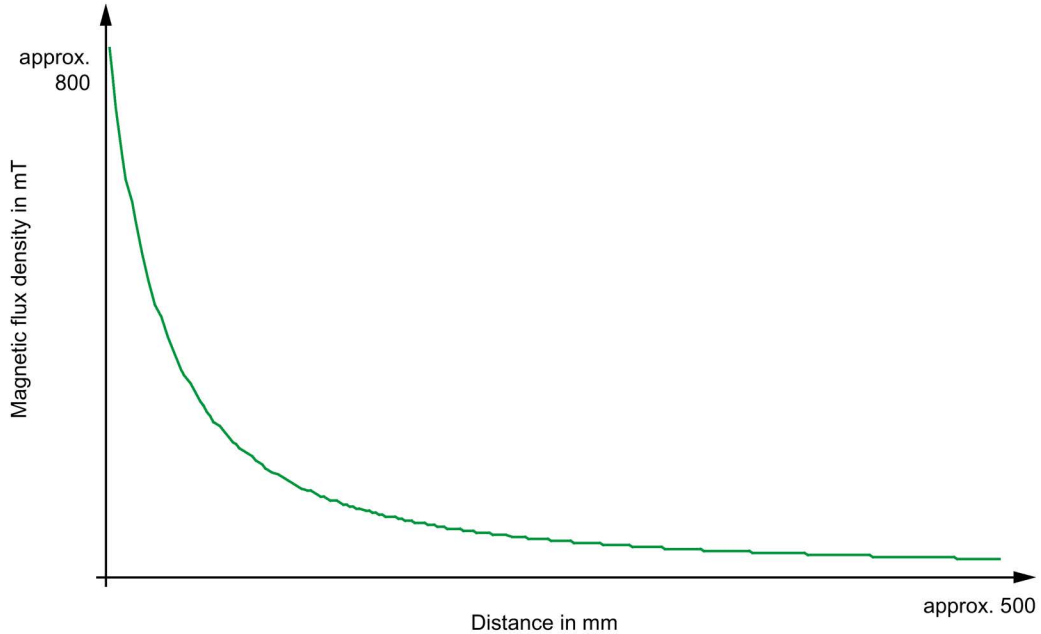

Figure 2-2 Schematic representation of the static magnetic field of a rotor, as a function of distance

Risk to persons as a result of strong magnetic fields



⚠ WARNING

Risk of death as a result of permanent magnet fields

The permanent magnets in the motors represents a danger for people with active medical implants, who come close to the motors. This is also the case when the motor is switched off.

Examples of active medical implants include: Heart pacemakers, insulin pumps.

- If you are affected, stay a minimum distance of 300 mm from the permanent magnets (tripping threshold for static magnetic fields of 0.5 mT according to the Directive 2013/35/EU).

With regard to the effect of strong magnetic fields on people, in Germany the DGUV regulation 103-013 "Electromagnetic fields" of the German Social Accident Insurance must be complied with! This regulation lists all of the requirements that must be observed at workplaces. In other countries, the relevant applicable national and local regulations and requirements must be taken into account.

For magnetic fields, you must carefully comply with the requirements laid down in the DGUV regulation 103-013 of the German Social Accident Insurance.

**⚠ CAUTION****Safety distance to the rotor**

The rotor magnetic fields are permanent. If you come into direct bodily contact with the rotors, a static magnetic flux density of 2 T is not exceeded.

- Carefully comply with the DGUV regulation 103-013, Paragraph 14 "Systems with high static magnetic fields".

**⚠ WARNING****Electrical shock hazard**

Every movement of the rotor compared with the stator and vice versa induces a voltage at the stator power connections.

If you use defective cable ports, you could suffer an electric shock.

- Do not touch the cable ports.
- Correctly connect the stator power connections, or insulate them properly.



! WARNING

Risk of rotor permanent magnets causing crushing injuries

The forces of attraction of magnetic rotors act on materials that can be magnetized. The forces of attraction increase significantly close to the rotor. The response threshold of 3 mT for risk of injury through attraction and causing a projectile effect is reached at a distance of 100 mm (Directive 2013/35/EU). Rotors and materials that can be magnetized can suddenly slam together unintentionally. Two rotors can also unintentionally slam together.

There is a significant risk of crushing when you are close to a rotor.

Close to the motor, the magnetic forces of attraction can be up to several kN. – Example: Magnetic attractive forces are equivalent to a force of 100 kg, which is sufficient to trap a body part.

- Do not underestimate the strength of the attractive forces, and work very carefully.
- Wear safety gloves.
- The work should be done by at least two people.
- Do not unpack the rotor until immediately before assembly.
- Never unpack several rotors at once.
- Never place the rotors directly next to one another without providing adequate protection.
- Never carry any objects made of magnetizable materials (for example watches, steel or iron tools) and/or permanent magnets close to the rotor! If tools that can be magnetized are still required, then hold any tool firmly using both hands. Slowly bring the tool to the rotor.
- Immediately install the rotor after it has been unpacked.
- Use a special installation device when centering and assembling the stator and rotor as individual components. Maintain the special procedure.
- Keep the following tools at hand to release parts of the body (hand, fingers, foot etc.) trapped between two components:
 - A hammer (about 3 kg) made of solid, non-magnetizable material
 - Two pointed wedges (wedge angle approx. 10° - 15°, minimum height 50 mm) made of solid, non-magnetizable material (e.g. hard wood)

First aid in the case of accidents involving permanent magnets

- Stay calm.
- Press the emergency stop switch and, where necessary, switch off the main switch if the machine is live.
- Administer FIRST AID. Call for further help if required.
- To free jammed body parts (e.g., hands, fingers, feet), pull apart components that are clamped together.
 - To do this, use a hammer to drive a wedge into the separating rift
 - Release the jammed body parts.
- If necessary, call for an EMERGENCY DOCTOR.

Material damage caused by strong magnetic fields

NOTICE**Data loss caused by strong magnetic fields**

If you are close to the rotor (< 100 mm) any magnetic or electronic data medium as well as electronic devices that you are carrying can be destroyed. For example, credit cards, USB sticks, floppy disks and watches are at risk.

- Do not carry any magnetic/electronic data media and no electronic devices when you are close to a rotor!

2.3.3 Technical features

Note

The values specified in the following table only apply in conjunction with the system prerequisites described in "System integration".

Table 2- 1 Standard version of the 1FW6 built-in torque motor

Technical feature	Version
Motor type	Synchronous motor with permanent magnet rotor, with a high number of poles (no. of rotor poles: 22 to 98)
Design	Individual components: stator, rotor
Degree of protection according to EN 60034-5	Motor: IP23 The final degree of protection (minimum degree of protection: IP54) of the built-in motor must be realized by the machine manufacturer.
Cooling method	Water cooling <ul style="list-style-type: none"> • Jacket cooling: size 1FW609, 1FW613, 1FW615 • Integrated cooling (1 cooling circuit): sizes 1FW605 and 1FW606 • Integrated cooling (2 cooling circuits): sizes 1FW616, 1FW619, 1FW623, 1FW629
Pressure in the cooling circuit	Max. 10 bar (static)
Cooler connection	Motors with a cooling jacket: Must be connected by customer Motors with integrated cooling: Connection with/without cooling connection adapter, see Chapter "Cooler connection (Page 130)"
Thermal motor protection	1FW605 to 1FW629: 1x PTC for thermistor triplet with response threshold +130 °C (according to DIN 44081/44082) 1FW609 to 1FW629 in conjunction with KTY 84: in addition 1 x PTC triplet with response threshold +150 °C (according to DIN 44081/44082) Evaluation via Sensor Modules: SME120/SME125/TM120 (see SINAMICS S120 Manual)
Temperature monitoring	1FW6xxx-xxxx-xxx1 and 1FW6xxx-xxxx-xxx2: with 1 x KTY 84 (acc. to EN 60034-11) 1FW6xxx-xxxx-xxx3: with 1 x Pt1000 (acc. to EN 60751) Evaluation via Sensor Modules: SME120/SME125/TM120 (see SINAMICS S120 Manual)
2nd rating plate	Enclosed separately

Technical feature	Version
Insulating material class of stator winding according to EN 60034-1	Temperature class 155 (F)
Impulse withstand voltage insulation class according to EN 60034-18-41 (IEC 60034-18-41)	IVIC: C
Magnet material	Rare earth material
Connection, electrical	<p>Cable outlet: axial radial outward (not for 1FW605 and 1FW606) tangential (not in the case of motors with individual conductors)</p> <p>Connection type: Permanently connected power and signal cables with open core ends Length: 2 m Permanently connected power cables with single cores and signal cables with open core ends Length: 1 m Permanently connected power and signal cables pre-assembled with connectors (not in the case of motors with single cores) Length: 0.5 m</p>
Motor feeder cables	For the specifications of the motor feeder cables, see Chapter "Requirements for the motor supply cables (Page 516)"
Torque ripple	$\leq 1.5\% M_0$

2.3.4 Defining the direction of rotation

Direction of rotation

If the built-in torque motor is connected with a phase sequence U-V-W, and is fed from a three-phase system with a clockwise phase sequence, then the rotor rotates clockwise. You can identify the direction of rotation by viewing the DE of the built-in torque motor. The cable outlet of the built-in torque motor is on the opposite side – the NDE.

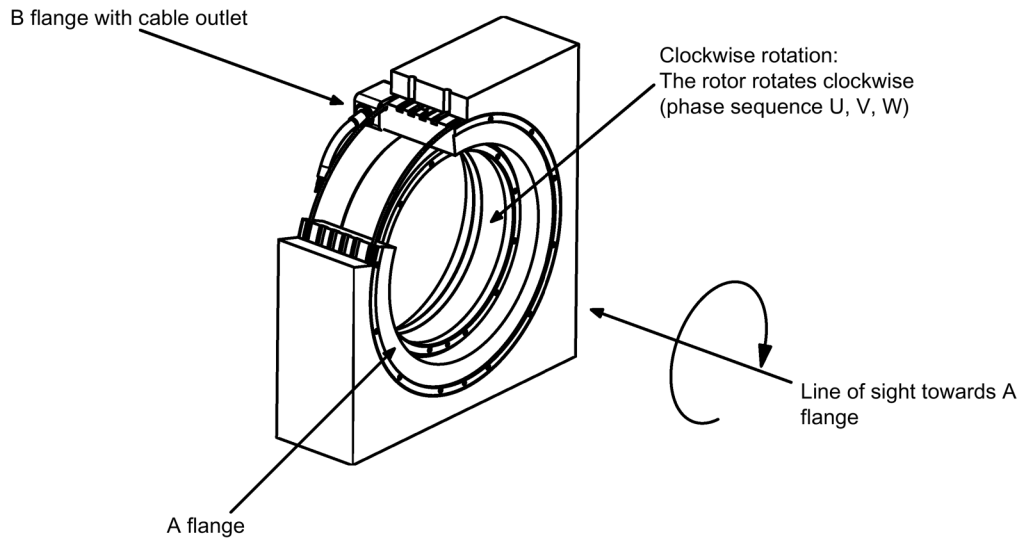

Figure 2-3 Line of sight for determining the direction of rotation

2.3.5 Environmental conditions for stationary use

You can classify the ambient conditions for stationary use at weatherprotected locations according to the standard DIN IEC 60721-3-3. The environmental effects and their limit values are defined in various classes in this standard.

With the exception of "Low air temperature" and "Low air pressure" ambient parameters, you can assign the motors to climatic class 3K3.

Table 2- 2 Ambient conditions are based on climate class 3K3

Ambient parameter		Unit	Value
a)	Low air temperature	°C	- 5
b)	High air temperature	°C	+ 40
c)	Low relative humidity	%	5
d)	High relative humidity	%	85
e)	Low absolute humidity	g/m ³	1
f)	High absolute humidity	g/m ³	25
g)	Rate of temperature change ¹⁾	°C/min	0.5
h)	Low air pressure ⁴⁾	kPa	78.4
i)	High air pressure ²⁾	kPa	106
j)	Solar radiation (insolation)	W/m ²	700
k)	Thermal radiation	-	-
l)	Air movement ³⁾	m/s	1.0
m)	Condensation	-	Not permissible
n)	Wind-driven precipitation (rain, snow, hail, etc.)	-	-
o)	Water (other than rain)	-	See degree of protection
p)	Formation of ice	-	-

¹⁾ Averaged over a period of 5 min

²⁾ Conditions in mines are not considered.

³⁾ A cooling system based on natural convection can be disturbed by unforeseen air movements.

⁴⁾ The limit value of 78.4 KPa covers altitudes up to 2000 m.

Additional ambient conditions applicable for the motors for stationary use at weather-protected locations according to standard DIN IEC 60721-3-3 include.

Mechanically active ambient conditions	Class 3S1
Mechanical ambient conditions	Class 3M3

Note

Installation instructions

SIMOTICS S motors are not suitable for operation

- In salt-laden or aggressive atmospheres
- Outdoors

You can find additional data on the environmental conditions, such as ambient temperatures or conditions for transport and storage of the motors, in the relevant chapters of this documentation.

2.3.6 Scope of delivery

2.3.6.1 Built-in torque motor with a cooling jacket

- The rotor is secured in the stator by means of transport locks and is protected using a spacer film
- Stator with a cooling jacket; one cable for the power connection and one cable for the signal connection with connector or open core ends
- Transportation locks with spacers and screws
- O-rings (quantity: 2)
- Rating plate (attached); additional loose rating plate
- Safety instructions

2.3.6.2 Built-in torque motor with integrated cooling

- The rotor is secured in the stator by means of transport locks and is protected using a spacer film
- Stator with ready-to-connect cooling system; one cable for the power connection and one cable for the signal connection with connector or open conductor ends
- Transportation locks with spacers and screws
- Rating plate (attached); additional loose rating plate
- Safety instructions

2.3.6.3 Supplied pictograms

To warn of hazards, the following durable adhesive stickers are supplied:

Table 2- 3 Warning signs provided according to BGV A8 and EN ISO 7010 and their significance







Sign	Meaning	Sign	Meaning
	Warning against magnetic field (W006)		Warning against hand injuries (W024)
	Warning against electric voltage (W012)		Warning against hot surface (W017)

Table 2- 4 Prohibit signs provided according to BGV A8 and EN ISO 7010 and their significance

Sign	Meaning	Sign	Meaning
	No access for persons with pacemakers or implanted defibrillators (P007)		No access for persons with metal implants (P014)
	Prohibited to carry/wear metal parts or watches (P008)		

Note

The quality of the label can diminish as result of extreme environmental conditions.

Any danger areas encountered during normal operation and when maintaining and servicing the motor must be identified using clearly visible warning and prohibit signs (pictograms) in the immediate vicinity of the danger (close to the motor). The associated texts must be available in the language of the country in which the product is used.

2.4 Derating factors

For installation altitudes more than 2000 m above sea level, reduce the voltage stress of the motors according to the "Factors to reduce the maximum DC link voltage" table (reciprocal values from EN 60664-1 Table A. 2).

Table 2- 5 Factors to reduce the maximum DC link voltage

Installation altitude above sea level in m up to	Factor
2000	1
3000	0.877
4000	0.775
5000	0.656
6000	0.588
7000	0.513
8000	0.444

Reducing the DC link voltage reduces the converter output voltage. The operating range in the M-n diagram is also reduced.

You can find the M-n diagrams in the associated data sheet.

Operation in a vacuum is not permissible due to the low voltage strength and the poor cooling.

2.5 Selection and ordering data

2.5.1 Order designation

The article number serves as order designation. The article number (MLFB) comprises a combination of digits and letters. When placing an order, it is sufficient just to specify the unique Article number.

The Article number consists of three blocks that are separated by hyphens. The first block has seven positions and designates the motor type (1FW6), the frame size and the cooling method. Additional features are coded in the second and third blocks.

Please note that not every theoretical combination is possible.

2.5.1.1 Standard 1FW6 built-in torque motor

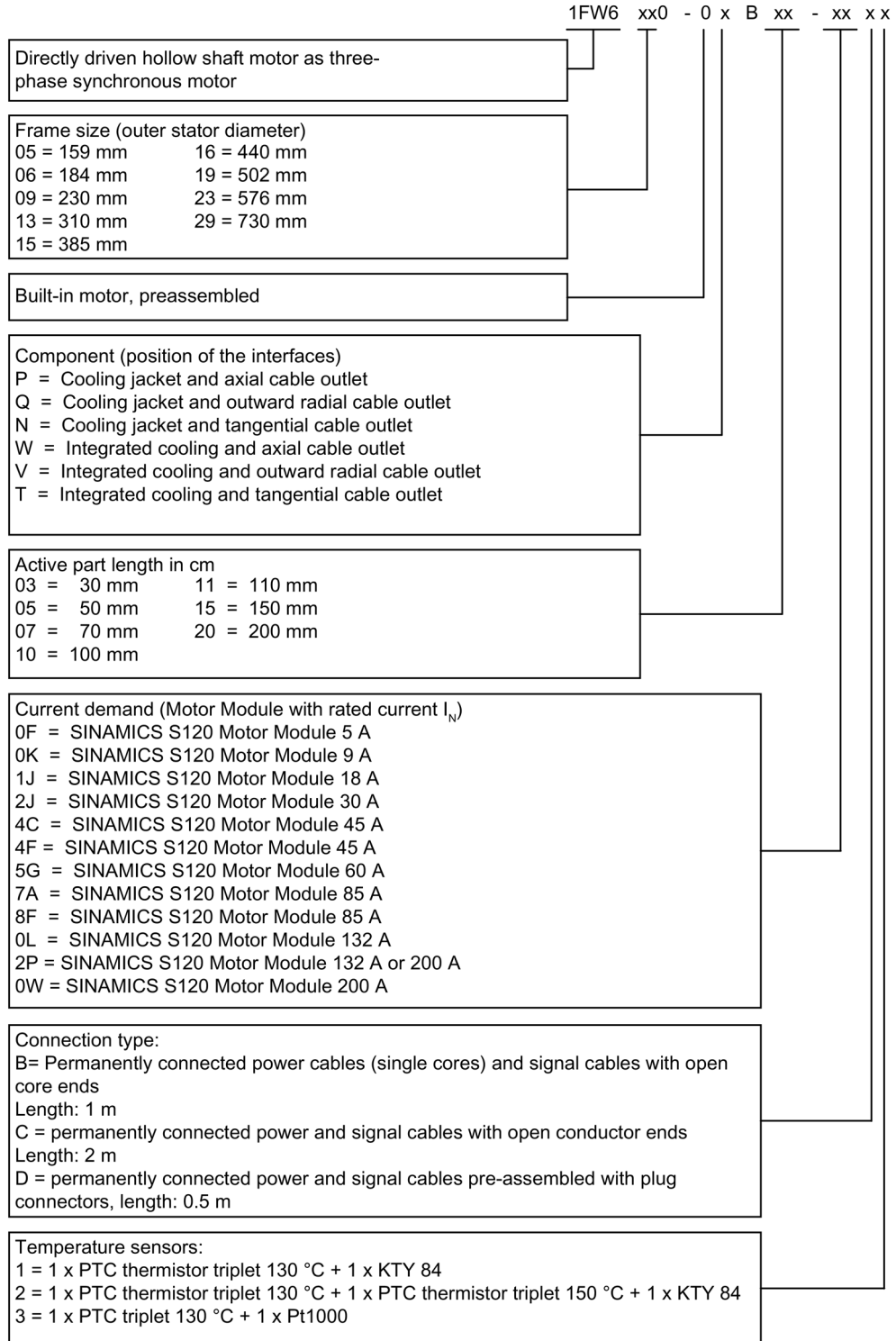

2.5.1.2 Stator as individual component

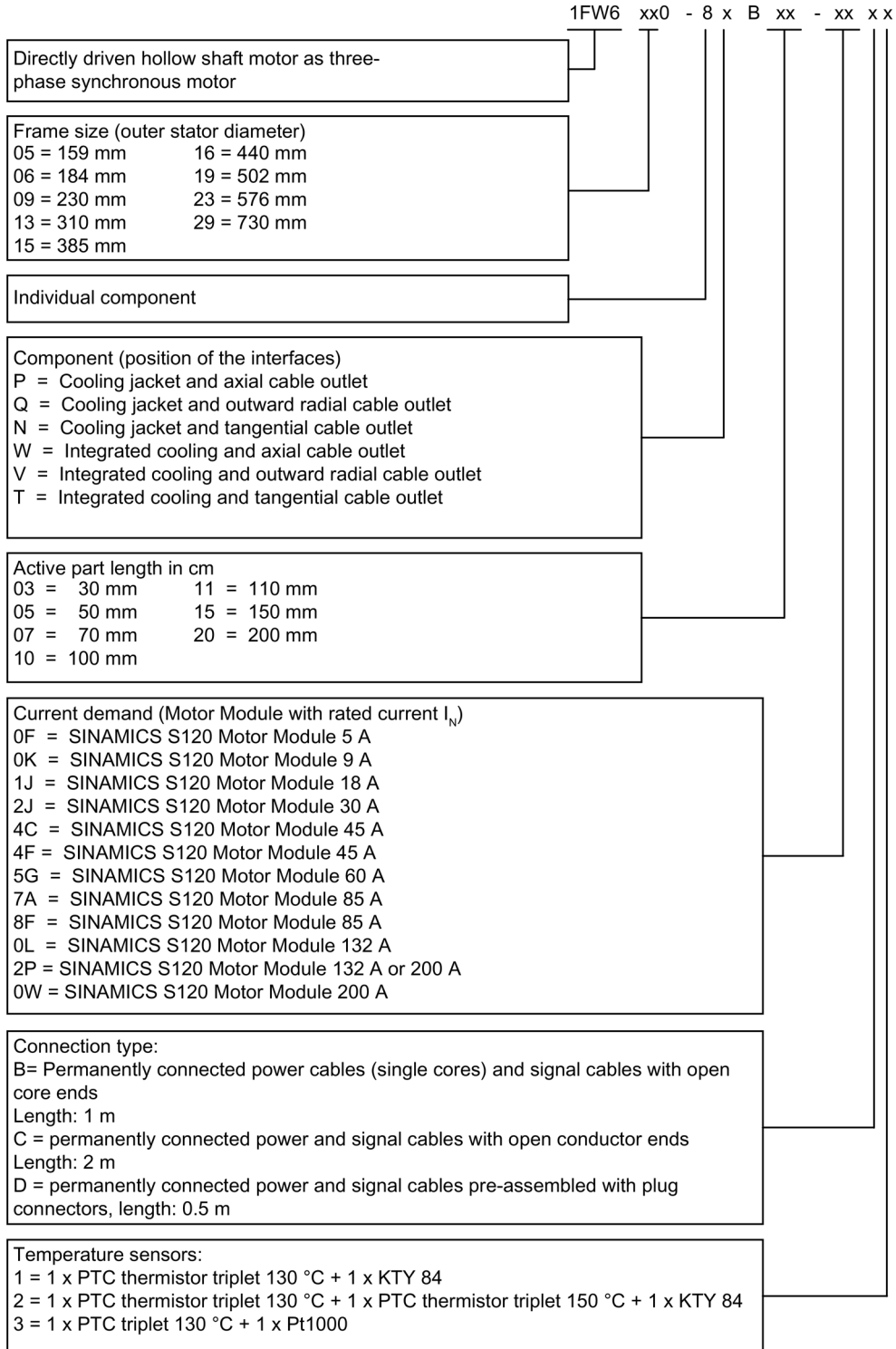

2.5.1.3 Rotor as individual component

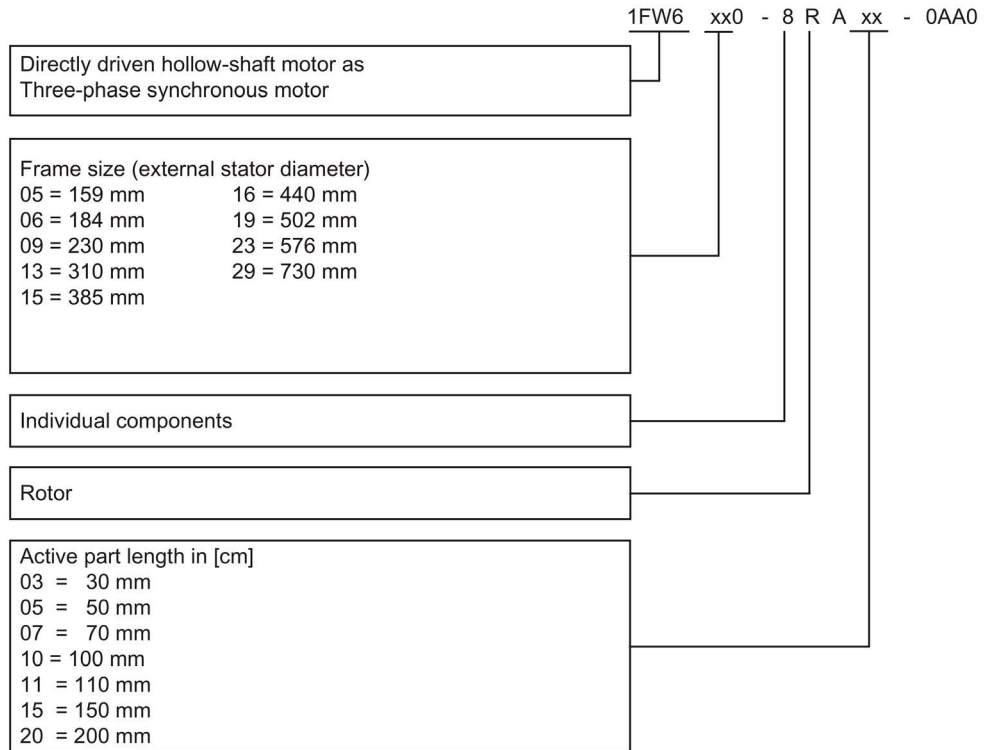

Note

IATA regulations must be complied with when transporting rotors by air.

2.5.1.4 Ordering notes

You can order a complete built-in torque motor (stator, rotor with transport locks) using a single order designation (article number). Spare parts and accessories can be ordered by specifying separate order designations (see "Ordering examples (Page 44)").

Note

The cables are permanently attached. You cannot subsequently change the cables.

When selecting a motor, also observe the information in Chapter "Data for the power cable at the stator (Page 506)".

The cooling connection adapter is not included in the standard built-in torque motor. For the separate order designation, see Chapter "Options (Page 91)".

If, for design reasons, only individual components can be installed (stator and rotor separately), the stator and rotor can be separately ordered and shipped.

2.5.1.5 Ordering examples

Example 1:

Stator and rotor preassembled with transportation locks; cooling jacket; axial cable outlet for SINAMICS S120 drive system, Motor Modules 18 A / 36 A:

Article number 1FW6090-0PB15-1JC2

Example 2:

Stator and rotor preassembled with transportation locks; integrated cooling; radial cable outlet towards the outside for SINAMICS S120 drive system, Motor Modules 18 A / 36 A:

Article number 1FW6190-0VB07-1JC2

Example 3:

Cooling connection adapter (axial/radial) for sizes 1FW616, 1FW619, and 1FW623:

Article number 1FW6160-1BA00-0AA0

Example 4:

Individual component/stator as spare part: Article number 1FW6190-8VB07-1JD2

Individual component/rotor as spare part: Article number 1FW6190-8RA07-0AA0

Individual component/spare part round sealing ring: Article number 1FW6090-1EA00-0AA0
(for size 1FW609x)

2.5.2 Selection and ordering data 1FW6

Note

Overview of important motor data

A selection of important motor data and dimensions is provided in this chapter. You can find all of the data in Chapter "Technical data and characteristics (Page 155)" – and in Chapter "Installation drawings/dimension sheets (Page 519)".

Table 2- 6 Built-in torque motors: overview (part 1 of 2)

Order desig. / Size	Rated torque ¹⁾	Max. torque	Rated cur- rent ¹⁾ I _N	Max. current	Rated speed ²⁾	Max. speed at max. torque ²⁾
	M _N in Nm	M _{MAX} in Nm	in A	I _{MAX} in A	n _N in rpm	n _{MAX,MMAX} in rpm
1FW6050-xxB03-0Fxx	23.2	34.4	4.87	7.61	940	697
1FW6050-xxB05-0Fxx	39.5	57.5	4.98	7.64	525	376
1FW6050-xxB07-0Fxx	55.7	80.6	5.02	7.65	349	236
1FW6050-xxB07-0Kxx	50.9	81.2	9	14.6	895	685
1FW6050-xxB10-0Kxx	73.7	116	9.13	14.6	589	437
1FW6050-xxB15-0Kxx	112	174	9.23	14.6	348	234
1FW6050-xxB15-1Jxx	109	174	18	29.1	850	658
1FW6060-xxB03-0Fxx	32	64.5	4.33	9.81	633	330
1FW6060-xxB05-0Fxx	62	123	4.42	9.85	309	126
1FW6060-xxB05-0Kxx	60.6	123	7.79	17.7	663	399
1FW6060-xxB07-0Fxx	84.3	166	4.45	9.86	203	43.3
1FW6060-xxB07-0Kxx	83	166	7.9	17.8	464	256
1FW6060-xxB10-0Kxx	117	231	7.98	17.8	302	133
1FW6060-xxB10-1Jxx	111	226	14.6	31.5	708	471
1FW6060-xxB15-0Kxx	172	339	8.04	17.8	174	27.6
1FW6060-xxB15-1Jxx	166	332	14.8	31.5	442	260
1FW6090-xxB05-0Fxx	113	179	5.62	9.55	142	50.2
1FW6090-xxB05-0Kxx	109	179	7.47	13.3	250	142
1FW6090-xxB07-0Kxx	154	251	9.52	16.7	224	128
1FW6090-xxB07-1Jxx	142	251	13.9	26.5	428	278
1FW6090-xxB10-0Kxx	231	358	7.97	13.3	83.9	12.4
1FW6090-xxB10-1Jxx	216	358	14.8	26.6	272	170
1FW6090-xxB15-1Jxx	338	537	15.5	26.6	154	80.6
1FW6090-xxB15-2Jxx	319	537	23.8	43.4	312	202
1FW6130-xxB05-0Kxx	241	439	9.06	18.1	132	46.5
1FW6130-xxB05-1Jxx	217	439	14.5	32.3	308	181
1FW6130-xxB07-0Kxx	344	614	10.4	20.3	96.1	21.5
1FW6130-xxB07-1Jxx	324	614	15.5	32.3	201	109
1FW6130-xxB10-1Jxx	484	878	16.2	32.3	123	50.9
1FW6130-xxB10-2Jxx	449	878	24.7	53.1	249	148
1FW6130-xxB15-1Jxx	743	1320	18.7	36.2	78.4	16
1FW6130-xxB15-2Jxx	714	1320	26.9	54.3	152	78.8
1FW6150-xxB05-1Jxx	338	710	17.2	44.1	234	108
1FW6150-xxB05-4Fxx	298	710	36.2	106	654	332
1FW6150-xxB07-2Jxx	470	994	25.6	66.1	259	126

2.5 Selection and ordering data

Order desig. / Size	Rated torque ¹⁾	Max. torque	Rated current ¹⁾	Max. current	Rated speed ²⁾	Max. speed at max. torque ²⁾
	M _N	M _{MAX}	I _N	I _{MAX}	n _N	n _{MAX,MMAX}
	in Nm	in Nm	in A	in A	in rpm	in rpm
1FW6150-xxB07-4Fxx	444	994	38.7	106	449	230
1FW6150-xxB10-2Jxx	688	1420	26.3	66.1	171	75.9
1FW6150-xxB10-4Fxx	663	1420	40.5	106	301	152
1FW6150-xxB15-2Jxx	1050	2130	26.8	66.1	103	33.1
1FW6150-xxB15-4Fxx	1030	2130	41.9	106	188	89.1
1FW6160-xxB05-1Jxx	432	716	16.5	31.6	140	80.6
1FW6160-xxB05-2Jxx	405	716	24.1	49.4	242	142
1FW6160-xxB05-5Gxx	317	716	37.4	98.8	574	308
1FW6160-xxB07-1Jxx	621	1000	17	31.6	93.5	51.7
1FW6160-xxB07-2Jxx	596	1000	25.4	49.4	164	97.2
1FW6160-xxB07-5Gxx	517	1000	43.7	98.8	379	218
1FW6160-xxB07-8Fxx	436	1000	52.4	141	594	320
1FW6160-xxB10-1Jxx	904	1430	17.3	31.6	59	28.5
1FW6160-xxB10-2Jxx	880	1430	26.3	49.4	108	62.4
1FW6160-xxB10-5Gxx	807	1430	48	98.8	250	149
1FW6160-xxB10-8Fxx	737	1430	62.3	141	383	221
1FW6160-xxB10-2Pxx	629	1430	74	198	584	317
1FW6160-xxB15-2Jxx	1350	2150	27	49.4	64.6	33.8
1FW6160-xxB15-5Gxx	1280	2150	51.1	98.8	156	93.8
1FW6160-xxB15-8Fxx	1220	2150	69.1	141	237	142
1FW6160-xxB15-2Pxx	1130	2150	89	198	355	208
1FW6160-xxB15-0Wxx	970	2150	109	282	551	304
1FW6160-xxB20-5Gxx	1760	2860	52.5	98.8	111	65.5
1FW6160-xxB20-8Fxx	1700	2860	72.3	141	170	103
1FW6160-xxB20-2Pxx	1610	2860	95.7	198	253	152
1FW6160-xxB20-0Wxx	1470	2860	124	282	387	225
1FW6190-xxB05-1Jxx	634	990	17	31.8	92.7	51.7
1FW6190-xxB05-2Jxx	608	990	24.4	47.7	155	91
1FW6190-xxB05-5Gxx	516	990	40.8	95.3	364	204
1FW6190-xxB07-1Jxx	907	1390	17.5	31.8	61	31.2
1FW6190-xxB07-2Jxx	881	1390	25.3	47.7	105	60.8
1FW6190-xxB07-5Gxx	798	1390	45.4	95.3	244	143
1FW6190-xxB07-8Fxx	714	1390	57.5	136	377	212
1FW6190-xxB10-1Jxx	1310	1980	17.8	31.8	37.2	14.2
1FW6190-xxB10-2Jxx	1290	1980	26.1	47.7	67.6	37.1
1FW6190-xxB10-5Gxx	1210	1980	48.5	95.3	161	96.6

Order desig. / Size	Rated torque ¹⁾	Max. torque	Rated current ¹⁾ I _N	Max. current	Rated speed ²⁾	Max. speed at
	M _N	M _{MAX}		I _{MAX}	n _N	max. torque ²⁾
	in Nm	in Nm	in A	in A	in rpm	n _{MAX,MMAX} in rpm
1FW6190-xxB10-8Fxx	1140	1980	64.7	136	246	145
1FW6190-xxB10-2Pxx	971	1980	85.9	214	430	238
1FW6190-xxB15-2Jxx	1970	2970	26.6	47.7	39	16.9
1FW6190-xxB15-5Gxx	1890	2970	50.9	95.3	99.8	59.4
1FW6190-xxB15-8Fxx	1830	2970	69.8	136	153	92.3
1FW6190-xxB15-2Pxx	1680	2970	100	214	263	155
1FW6190-xxB15-0Wxx	1560	2970	118	272	352	201
1FW6190-xxB20-5Gxx	2580	3960	52	95.3	70.1	40.1
1FW6190-xxB20-8Fxx	2510	3960	72.2	136	109	65.4
1FW6190-xxB20-2Pxx	2380	3960	107	214	188	113
1FW6190-xxB20-0Wxx	2270	3960	129	272	249	148
1FW6230-xxB05-1Jxx	801	1320	16	31.9	66.1	32.6
1FW6230-xxB05-2Jxx	778	1320	22.2	45.5	104	56
1FW6230-xxB05-5Gxx	669	1320	41.4	101	275	147
1FW6230-xxB07-1Jxx	1140	1840	16.4	31.9	43.2	18
1FW6230-xxB07-2Jxx	1120	1840	22.8	45.5	69.8	35.9
1FW6230-xxB07-5Gxx	1020	1840	45.4	101	185	103
1FW6230-xxB07-8Fxx	936	1840	57.5	139	275	148
1FW6230-xxB10-2Jxx	1630	2630	23.3	45.5	44.4	19.8
1FW6230-xxB10-5Gxx	1530	2630	48.1	101	123	69
1FW6230-xxB10-8Fxx	1460	2630	63.2	139	181	101
1FW6230-xxB10-2Pxx	1330	2630	81.9	199	278	150
1FW6230-xxB15-4Cxx	2450	3950	32.8	63.8	41.5	18.5
1FW6230-xxB15-5Gxx	2380	3950	50.1	101	76.2	41.8
1FW6230-xxB15-8Fxx	2320	3950	67.3	139	113	64
1FW6230-xxB15-2Pxx	2210	3950	91	199	172	97.1
1FW6230-xxB15-0Wxx	2040	3950	117	279	258	141
1FW6230-xxB20-5Gxx	3230	5260	51.1	101	53.4	27.5
1FW6230-xxB20-8Fxx	3170	5260	69.3	139	80.7	44.8
1FW6230-xxB20-2Pxx	3060	5260	95.3	199	123	70
1FW6230-xxB20-0Wxx	2910	5260	126	279	184	104
1FW6290-xxB07-5Gxx	2060	4000	52.3	119	106	57.5
1FW6290-xxB07-0Lxx	1920	4000	86.2	212	204	110
1FW6290-xxB07-2Pxx	1810	4000	105	272	272	144
1FW6290-xxB11-7Axx	3320	6280	59.8	133	72.9	39.3
1FW6290-xxB11-0Lxx	3200	6280	91.8	212	125	68.6

2.5 Selection and ordering data

Order desig. / Size	Rated torque ¹⁾	Max. torque	Rated cur- rent ¹⁾ I _N	Max. current	Rated speed ²⁾	Max. speed at max. torque ²⁾
	M _N in Nm	M _{MAX} in Nm	in A	I _{MAX} in A	n _N in rpm	n _{MAX,MMAX} in rpm
1FW6290-xxB11-2Pxx	3110	6280	114	272	165	90.4
1FW6290-xxB15-7Axx	4600	8570	60.7	133	51.3	26.6
1FW6290-xxB15-0Lxx	4480	8570	94.4	212	88.5	48.7
1FW6290-xxB15-2Pxx	4390	8570	118	272	117	64.9
1FW6290-xxB20-0Lxx	5760	10900	95.8	212	67.9	36.9
1FW6290-xxB20-2Pxx	5670	10900	121	272	90.3	49.9

¹⁾ Water cooling with 35 °C intake temperature; ²⁾ speed and current values at converter DC link voltage U_{DC} = 600 V (regulated) / converter output voltage (rms value) U_{a max} = 425 V (regulated)

Table 2- 7 Built-in torque motors: overview (part 2 of 2)

Order desig. / size	Rated power loss ¹⁾ P _{V,N} in kW	External diameter of stators in mm	Internal diameter of rotors in mm	Length of stator in mm	Motor mass ³⁾ in kg	Moment of inertia of rotor J _L in 10 ⁻² kgm ²
1FW6050-xxB03-0Fxx	0.769	159	64	89	3.08	0.139
1FW6050-xxB05-0Fxx	1.04	159	64	109	5.89	0.267
1FW6050-xxB07-0Fxx	1.27	159	64	129	7.91	0.39
1FW6050-xxB07-0Kxx	1.23	159	64	129	7.91	0.39
1FW6050-xxB10-0Kxx	1.6	159	64	159	11.4	0.488
1FW6050-xxB15-0Kxx	2.27	159	64	209	19.2	0.691
1FW6050-xxB15-1Jxx	2.27	159	64	209	19.2	0.691
1FW6060-xxB03-0Fxx	0.778	184	92	89	7.08	0.347
1FW6060-xxB05-0Fxx	1.06	184	92	109	9.94	0.665
1FW6060-xxB05-0Kxx	1.07	184	92	109	9.94	0.665
1FW6060-xxB07-0Fxx	1.32	184	92	129	12.5	0.904
1FW6060-xxB07-0Kxx	1.33	184	92	129	12.5	0.904
1FW6060-xxB10-0Kxx	1.79	184	92	159	16.2	1.21
1FW6060-xxB10-1Jxx	1.86	184	92	159	16.2	1.21
1FW6060-xxB15-0Kxx	2.48	184	92	209	22.4	1.72
1FW6060-xxB15-1Jxx	2.65	184	92	209	22.4	1.72
1FW6090-xxB05-0Fxx	2.2	230	140	90	9.2	1.52
1FW6090-xxB05-0Kxx	2.14	230	140	90	9.2	1.52
1FW6090-xxB07-0Kxx	2.72	230	140	110	12.2	2.2
1FW6090-xxB07-1Jxx	2.69	230	140	110	12.2	2.2
1FW6090-xxB10-0Kxx	3.52	230	140	140	17.2	3.09
1FW6090-xxB10-1Jxx	3.52	230	140	140	17.2	3.09

Order desig. / size	Rated power loss ¹⁾ P _{V,N} in kW	External diameter of stators in mm	Internal diameter of rotors in mm	Length of stator in mm	Motor mass ³⁾ in kg	Moment of inertia of rotor J _L in 10 ⁻² kgm ²
1FW6090-xxB15-1Jxx	4.9	230	140	190	27.2	4.65
1FW6090-xxB15-2Jxx	4.99	230	140	190	27.2	4.65
1FW6130-xxB05-0Kxx	3.01	310	220	90	13.2	6.37
1FW6130-xxB05-1Jxx	3.03	310	220	90	13.2	6.37
1FW6130-xxB07-0Kxx	3.82	310	220	110	18.2	8.92
1FW6130-xxB07-1Jxx	3.81	310	220	110	18.2	8.92
1FW6130-xxB10-1Jxx	4.98	310	220	140	25.2	12.7
1FW6130-xxB10-2Jxx	5.1	310	220	140	25.2	12.7
1FW6130-xxB15-1Jxx	6.91	310	220	190	38.2	19.1
1FW6130-xxB15-2Jxx	6.91	310	220	190	38.2	19.1
1FW6150-xxB05-1Jxx	2.66	385	265	110	21.7	10.1
1FW6150-xxB05-4Fxx	2.64	385	265	110	21.7	10.1
1FW6150-xxB07-2Jxx	3.38	385	265	130	33.5	14.2
1FW6150-xxB07-4Fxx	3.34	385	265	130	33.5	14.2
1FW6150-xxB10-2Jxx	4.46	385	265	160	47.5	20.9
1FW6150-xxB10-4Fxx	4.4	385	265	160	47.5	20.9
1FW6150-xxB15-2Jxx	6.25	385	265	210	70.8	31.3
1FW6150-xxB15-4Fxx	6.17	385	265	210	70.8	31.3
1FW6160-xxB05-1Jxx	2.94	440	280	110	36.3	19
1FW6160-xxB05-2Jxx	2.95	440	280	110	36.3	19
1FW6160-xxB05-5Gxx	2.99	440	280	110	36.3	19
1FW6160-xxB07-1Jxx	3.69	440	280	130	48.3	25.8
1FW6160-xxB07-2Jxx	3.71	440	280	130	48.3	25.8
1FW6160-xxB07-5Gxx	3.75	440	280	130	48.3	25.8
1FW6160-xxB07-8Fxx	3.84	440	280	130	48.3	25.8
1FW6160-xxB10-1Jxx	4.82	440	280	160	66.3	36
1FW6160-xxB10-2Jxx	4.84	440	280	160	66.3	36
1FW6160-xxB10-5Gxx	4.89	440	280	160	66.3	36
1FW6160-xxB10-8Fxx	5.01	440	280	160	66.3	36
1FW6160-xxB10-2Pxx	4.89	440	280	170	66.3	36
1FW6160-xxB15-2Jxx	6.73	440	280	210	95.3	53.1
1FW6160-xxB15-5Gxx	6.8	440	280	210	95.3	53.1
1FW6160-xxB15-8Fxx	6.96	440	280	210	95.3	53.1
1FW6160-xxB15-2Pxx	6.8	440	280	220	95.3	53.1
1FW6160-xxB15-0Wxx	6.96	440	280	220	95.3	53.1
1FW6160-xxB20-5Gxx	8.7	440	280	260	124	70.1
1FW6160-xxB20-8Fxx	8.91	440	280	260	124	70.1
1FW6160-xxB20-2Pxx	8.7	440	280	270	124	70.1
1FW6160-xxB20-0Wxx	8.91	440	280	270	124	70.1

2.5 Selection and ordering data

Order desig. / size	Rated power loss ¹⁾ P _{V,N} in kW	External diameter of stators in mm	Internal diameter of rotors in mm	Length of stator in mm	Motor mass ³⁾ in kg	Moment of inertia of rotor J _L in 10 ⁻² kgm ²
1FW6190-xxB05-1Jxx	3.63	502	342	110	42.8	35.8
1FW6190-xxB05-2Jxx	3.63	502	342	110	42.8	35.8
1FW6190-xxB05-5Gxx	3.63	502	342	110	42.8	35.8
1FW6190-xxB07-1Jxx	4.56	502	342	130	55.8	48.6
1FW6190-xxB07-2Jxx	4.56	502	342	130	55.8	48.6
1FW6190-xxB07-5Gxx	4.56	502	342	130	55.8	48.6
1FW6190-xxB07-8Fxx	4.71	502	342	130	55.8	48.6
1FW6190-xxB10-1Jxx	5.96	502	342	160	75.8	67.8
1FW6190-xxB10-2Jxx	5.96	502	342	160	75.8	67.8
1FW6190-xxB10-5Gxx	5.96	502	342	160	75.8	67.8
1FW6190-xxB10-8Fxx	6.14	502	342	160	75.8	67.8
1FW6190-xxB10-2Pxx	6.02	502	342	170	75.8	67.8
1FW6190-xxB15-2Jxx	8.28	502	342	210	108	99.8
1FW6190-xxB15-5Gxx	8.28	502	342	210	108	99.8
1FW6190-xxB15-8Fxx	8.53	502	342	210	108	99.8
1FW6190-xxB15-2Pxx	8.36	502	342	220	108	99.8
1FW6190-xxB15-0Wxx	8.53	502	342	220	108	99.8
1FW6190-xxB20-5Gxx	10.6	502	342	260	136	132
1FW6190-xxB20-8Fxx	10.9	502	342	260	136	132
1FW6190-xxB20-2Pxx	10.7	502	342	270	136	132
1FW6190-xxB20-0Wxx	10.9	502	342	270	136	132
1FW6230-xxB05-1Jxx	3.66	576	416	110	44.8	62.2
1FW6230-xxB05-2Jxx	3.78	576	416	110	44.8	62.2
1FW6230-xxB05-5Gxx	3.7	576	416	110	44.8	62.2
1FW6230-xxB07-1Jxx	4.6	576	416	130	58.8	84.3
1FW6230-xxB07-2Jxx	4.74	576	416	130	58.8	84.3
1FW6230-xxB07-5Gxx	4.64	576	416	130	58.8	84.3
1FW6230-xxB07-8Fxx	4.67	576	416	130	58.8	84.3
1FW6230-xxB10-2Jxx	6.19	576	416	160	81.8	118
1FW6230-xxB10-5Gxx	6.06	576	416	160	81.8	118
1FW6230-xxB10-8Fxx	6.09	576	416	160	81.8	118
1FW6230-xxB10-2Pxx	6.24	576	416	160	81.8	118
1FW6230-xxB15-4Cxx	8.66	576	416	210	118	173
1FW6230-xxB15-5Gxx	8.43	576	416	210	118	173
1FW6230-xxB15-8Fxx	8.46	576	416	210	118	173
1FW6230-xxB15-2Pxx	8.67	576	416	210	118	173

Order desig. / size	Rated power loss ¹⁾ P _{V,N} in kW	External diameter of stators in mm	Internal diameter of rotors in mm	Length of stator in mm	Motor mass ³⁾ in kg	Moment of inertia of rotor J _L in 10 ⁻² kgm ²
1FW6230-xxB15-0Wxx	8.46	576	416	220	118	173
1FW6230-xxB20-5Gxx	10.8	576	416	260	154	228
1FW6230-xxB20-8Fxx	10.8	576	416	260	154	228
1FW6230-xxB20-2Pxx	11.1	576	416	260	154	228
1FW6230-xxB20-0Wxx	10.8	576	416	270	154	228
1FW6290-xxB07-5Gxx	5.15	730	520	140	104	228
1FW6290-xxB07-0Lxx	5.14	730	520	140	104	228
1FW6290-xxB07-2Pxx	5.18	730	520	160	104	228
1FW6290-xxB11-7Axx	7.09	730	520	180	159	334
1FW6290-xxB11-0Lxx	7.1	730	520	180	159	334
1FW6290-xxB11-2Pxx	7.15	730	520	200	159	334
1FW6290-xxB15-7Axx	9.05	730	520	220	215	440
1FW6290-xxB15-0Lxx	9.06	730	520	220	215	440
1FW6290-xxB15-2Pxx	9.11	730	520	240	215	440
1FW6290-xxB20-0Lxx	11	730	520	260	261	546
1FW6290-xxB20-2Pxx	11.1	730	520	280	261	546

¹⁾ Water cooling with 35 °C intake temperature; ³⁾ Motor mass not including mass of transportation locks

2.6 Rating plate data

Technical data of the stator is provided on the rating plate (name plate). A second rating plate is provided loose for the stator.

If, at a certain point in time, the stator and rotor are separated, then you must ensure that the stator and rotor can be assigned to one another at a later point in time.

Data on the rating plate

Note

The data on the rating plate only applies in conjunction with the corresponding rotor.

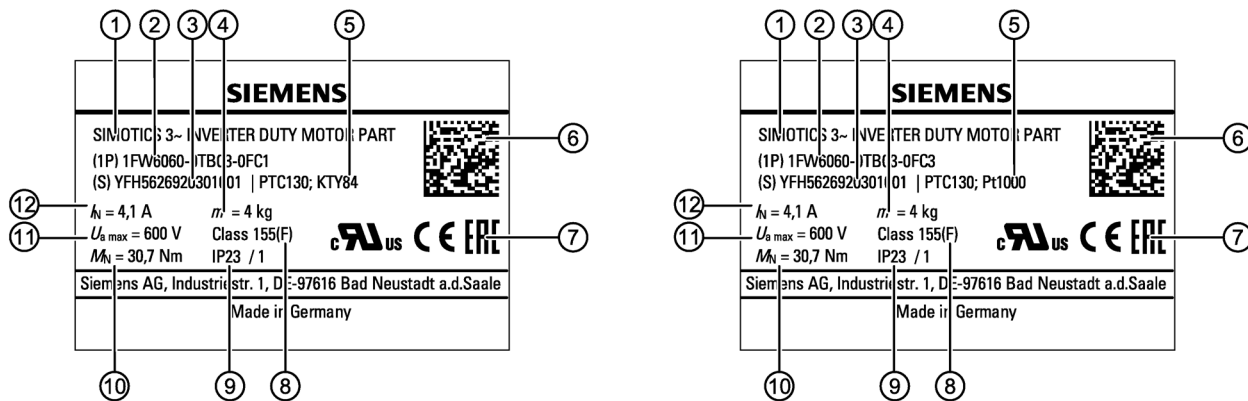

Figure 2-4 Examples of rating plates for 1FW6 built-in torque motors

Table 2- 8 Data on the rating plate for 1FW6 built-in torque motors

Position	Description
1	Type of motor
2	Article No.
3	Serial number
4	Weight
5	Temperature sensors
6	2D code, contains the motor data
7	Approvals/conformities
8	Temperature class
9	Degree of protection
10	Rated torque M_N
11	Maximum permissible rms value of the motor terminal voltage $U_{a \max}$
12	Rated current I_N

Mechanical properties

3.1 Cooling

A water-cooling system dissipates the heat loss generated by the stator winding.

- Connect the cooling ducts to the cooling circuit of a cooling device.

You can find the characteristic curves for the pressure drop of the cooling medium between the inlet and return circuit of the cooling system as a function of the volume flow rate in Chapter "Technical data and characteristics".

In certain operating states, you must expect an additional temperature rise of the rotor as a result of iron losses, e.g. when operating at high speeds or in S1 mode.

The rotor power loss is specified in the "Technical data and characteristics" chapter in the "Rotor power loss with respect to speed" characteristics.

The rated motor torques specified in the data sheets of Chapter "Technical data and characteristics" apply under the following conditions:

- Operation with water cooling with a water intake temperature of 35 °C.
- Rotor flange temperature of the rotor mounting surface 60 °C.

To comply with these conditions, it may be necessary to take additional measures to cool the rotor.

NOTICE

Demagnetization of the rotor magnets

If the heat from the rotor is not sufficiently dissipated via the flange, the rotors can heat up excessively in the upper speed range in duty type S1. which could demagnetize the magnets.

- Ensure that the rotor does not exceed the maximum temperature of 120 °C.

Note

Thermal expansion of the motor

Depending on the load and duty type, the average temperature in the stator and rotor can reach 120 °C. Temperature changes in the stator and rotor can cause the motor components to expand.

- You must take into account the amount of heat transferred into the machine construction as well as the radial and axial thermal expansion of the motor when the designing the machine.
-

3.1.1 Cooling circuits

Cooling circuit requirements

Avoid algae growth by using suitable chemical agents and opaque water lines.

We recommend that the cooling circuits be designed as closed systems. The maximum permissible pressure is 10 bar.

NOTICE
Blocked and clogged cooling circuits
Cooling circuits can become blocked and clogged as a result of pollution and longer-term deposits.
<ul style="list-style-type: none">• We recommend that you use a separate cooling circuit to cool the motors.

- If you use the machine cooling circuits to also cool the motors, you must ensure that the cooling medium fully complies with the requirements listed in this chapter.
- Also note the maximum non-operational times of cooling circuits corresponding to the coolant manufacturer's data.

Materials used in the cooling circuits of torque motors

Table 3- 1 Materials in the cooling circuits of torque motors (not including the material used for the connections)

Cooling jacket for 1FW609, 1FW613 and 1FW615	Integrated cooling (main cooler) for 1FW605, 1FW606 and 1FW616 up to 1FW629	Integrated cooling (precision cooler) for 1FW616 to 1FW629	Cooling connection adapter for 1FW616 to 1FW629
1FW609, 1FW613: <ul style="list-style-type: none"> EN AW-5083 (EN 573-3) Viton® (FPM) gasket 1FW615: <ul style="list-style-type: none"> S355J2G3 (EN 10025) Viton® (FPM) gasket 	1FW605, 1FW606: <ul style="list-style-type: none"> X10CrNiS18-9 (DIN 17440) SF-Cu (DIN 17671) Viton® (FPM) gasket 1FW616 to 1FW629: <ul style="list-style-type: none"> X6CrNiTi18-10 (EN 10088) SF-Cu (DIN 17671) CW617N (EN 12449 / EN 12167) Viton® (FPM) gasket Ag 102 (EN 1045) + welding flux EN 1045-FH10 	<ul style="list-style-type: none"> X6CrNiTi18-10 (EN 10088) SF-Cu (DIN 17671) CW617N (EN 12449) Viton® (FPM) gasket 	<ul style="list-style-type: none"> CW617N (EN 12449) Viton® (FPM) gasket

NOTICE

Corrosion as a result of unsuitable materials used to connect the cooler

Corrosion damage can occur if you use unsuitable materials to connect to the cooler.

- We recommend that you use brass or stainless steel fittings when connecting the cooler.

3.1 Cooling

Calculating the thermal power that can be dissipated by the cooler

$$Q = \rho \cdot c_p \cdot \dot{V} \cdot \Delta T$$

Average density of the coolant:	ρ	in	kg/m ³
Average specific heat capacity of the coolant:	c_p	in	J/(kg K)
Temperature deviation vis-à-vis the intake temperature:	ΔT	in	K
Volume flow:	\dot{V}	in	m ³ /s

Coolant inlet temperature

NOTICE

Corrosion in the machine

Condensation can lead to corrosion in the machine.

- Choose inlet temperatures that prevent condensation from forming on the surface of the motor. Condensation does not occur if the intake temperature T_{VORL} is higher than the ambient temperature - or corresponds to the ambient temperature.

The rated motor data refer to operation at a coolant inlet temperature of 35 °C. If the inlet temperature is different, the continuous motor current changes as shown below:

Note

For a cooler intake temperature of < 35 °C, the possible continuous motor current is greater I_0 .

I_0 is the current (rms value) of the stator at torque M_0 and speed $n = 1$ rpm.

Larger cable cross-sections may be required. This means that you must take into account the rated current of the cables.

The following diagram shows the principle dependency of the relevant continuous motor current on the intake temperature of the cooling water in the main cooler. The rotor losses are omitted as negligible.

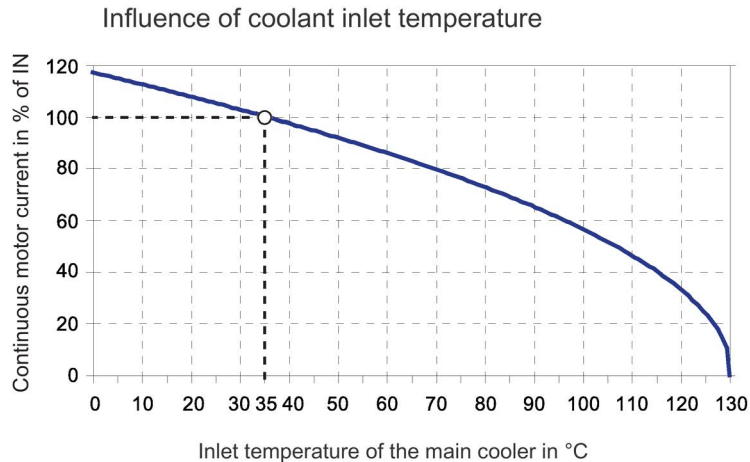

Figure 3-1 Influence of the coolant inlet temperature

Heat-exchanger unit

Use a heat-exchanger unit to ensure an inlet temperature of 35 °C. More than one motor can be operated on a single heat-exchanger unit. The heat-exchanger units are not included in the scope of supply.

The cooling power is calculated from the sum of the power losses of the connected motors. Adapt the pump power to the specified flow and pressure loss of the cooling circuit.

For a list of companies from whom you can obtain heat exchanger units, see the appendix.

Dimensioning the heat-exchanger unit

The power loss generated in the motor during continuous operation causes a thermal flow to take place. The surrounding machine assembly dissipates a small percentage of this thermal flow. The cooling system coolant dissipates the majority of this thermal flow. The cooling system must dissipate 85 % to 90 % of the power loss that occurs. Appropriately dimension the cooling system rating.

If you operate several motors simultaneously on one cooling system, then the cooling system must be able to dissipate the sum of the individual power losses.

In continuous operation, only load the motor so that the continuous rms torque of the duty cycle M_{eff} does not exceed the rated torque M_N . In continuous operation, it is not permissible for the operating point in the M-n diagram to be above the characteristic for S1 duty. As a consequence, the maximum rms power loss P_V only reaches the rated power loss $P_{V,N}$.

3.1 Cooling

$$\frac{P_V}{P_{V,N}} = \left(\frac{M_{\text{eff}}}{M_N} \right)^2$$

If you cannot determine the actual rms power loss P_V then alternatively you can add the rated power losses $P_{V,N}$ of all the motors to be used. The rated power losses $P_{V,N}$ of the motors are listed in the data sheets. Dimension the cooling system based on the sum of the rated power losses determined $P_{V,N}$.

If the sum of the rated power losses $P_{V,N}$ is greater than the actual rms power loss P_V , then this will lead to an overdimensioning of the cooling system.

The cooling system must be sufficiently powerful to ensure the required coolant pressure even at the maximum volume flow rate.

3.1.2 Coolant

Provision of the coolant

The customer must provide the coolant. The motors are designed for use with an anti-corrosion protection agent added to the water.

Note

Power derating when using oil as coolant

If you are using oil as coolant, then this can reduce the power loss dissipated by the cooler. Appropriately reduce the motor power. Please contact your local Siemens office if you have any questions.

Reason for the use of water with an anti-corrosion agent

The use of untreated water may lead to considerable damage and malfunctions due to water hardness deposits, the formation of algae and slime, as well as corrosion, for example:

- Worsening of the heat transfer
- Higher pressure losses due to reductions in cross-sectional area
- Blockage of nozzles, valves, heat exchangers and cooling ducts

General requirements placed on the cooling medium

The cooling medium must be pre-cleaned or filtered in order to prevent the cooling circuit from becoming blocked. The formation of ice is not permitted!

Note

The maximum permissible size for particles in the cooling medium is 100 µm.

Requirements placed on the water

Water which is used as basis for the coolant must comply as a minimum with the following requirements:

- Chloride concentration: $c < 100$ mg/l
- Sulfate concentration: $c < 100$ mg/l
- $6.5 \leq \text{pH value} \leq 9.5$

Contact the anti-corrosion agent manufacturer relating to additional requirements!

Requirements placed on the anti-corrosion agent

The anti-corrosion agent must fulfill the following requirements:

- The basis is ethylene glycol (also called ethanediol)
- The water and anti-corrosion agent do not segregate
- The freezing point of the water used is reduced to at least -5 °C
- The anti-corrosion agent used must be compatible with the fittings and cooling system hoses used as well as the materials of the motor cooler

Check these requirements, especially in regard to material compatibility, with the cooling unit manufacturer and the manufacturer of the anti-corrosion agent!

Suitable mixture

- 25 % - 30 % ethylene glycol (= ethanediol)
- The water used contains a maximum of 2 g/l dissolved mineral salt and is largely free from nitrates and phosphates

Manufacturer recommendations: see appendix

3.2 Degree of protection

NOTICE
Damage to the motor caused by pollution
If the area where the motor is installed is polluted and dirty, then the motor can malfunction and clog up.
<ul style="list-style-type: none">• Keep the area where the motor is installed free of all dirt and pollution.

The machine construction surrounding the motor must fulfill degree of protection IP54 to EN 60529 as a minimum.

The degree of protection for built-in motors is governed by the surrounding machine construction. The better the motor installation space is protected against the ingress of foreign particles (ferromagnetic particles), the longer the service life.

In particular, foreign particles in the air gap between the stator and rotor can destroy the motor during operation.

This also applies to corrosive chemicals (e.g. coolants, oil) that could penetrate the motor compartment. Corrosive chemicals can damage the magnetic bonds of the rotor.

Liquids can compromise the insulation resistance of the stator.

The thermal properties of the motor are influenced by the ingress of liquids and foreign particles.

1FW6 torque motors have degree of protection IP23.

3.3 Vibration response

The vibration response of build-in motors in operation essentially depends on the machine design and the application itself.

As a result of an unfavorable machine design, configuration or system settings, resonance points can be excited, so that vibration severity level A according to EN 60034-14 (IEC 60034-14) is not reached.

Excessive vibration caused by resonance effects can frequently be avoided by making suitable settings. Contact Mechatronic Support if you require help in applying remedial measures. You can find contact data in the Introduction under "Technical Support".

3.4 Noise emission

The following components and settings influence the noise levels reached when built-in motors are operational:

- Machine design
- Encoder system
- Storage
- Controller settings
- Pulse frequency

As a result of unfavorable machine designs, configuration or system settings, measuring surface sound pressure levels of over 70dB (A) can occur. Contact Mechatronic Support if you require help in applying remedial measures. You can find contact data in the Introduction under "Technical Support".

3.5 Service and inspection intervals

3.5.1 Safety instructions for maintenance

 **WARNING**

Risk of injury as a result of undesirable rotary motion

If, with the motor switched on, you work in the rotational range of the motor, and the motor undesirably rotates, this can result in death, injury and/or material damage.

- Always switch off the motor before working in the rotational range of the motor. Ensure that the motor is in a completely no-voltage condition.



! WARNING
Risk of death and crushing as a result of permanent magnet fields
Severe injury and material damage can result if you do not take into consideration the safety instructions relating to permanent magnet fields.
<ul style="list-style-type: none">• Observe the information in Chapter "Danger from strong magnetic fields (Page 29)".



! WARNING
Risk of rotor permanent magnets causing crushing injuries
The forces of attraction of magnetic rotors act on materials that can be magnetized. The forces of attraction increase significantly close to the rotor. The response threshold of 3 mT for risk of injury through attraction and causing a projectile effect is reached at a distance of 100 mm (Directive 2013/35/EU). Rotors and materials that can be magnetized can suddenly slam together unintentionally. Two rotors can also unintentionally slam together.
There is a significant risk of crushing when you are close to a rotor.
Close to the motor, the magnetic forces of attraction can be up to several kN. – Example: Magnetic attractive forces are equivalent to a force of 100 kg, which is sufficient to trap a body part.
<ul style="list-style-type: none">• Do not underestimate the strength of the attractive forces, and work very carefully.• Wear safety gloves.• The work should be done by at least two people.• Do not unpack the rotor until immediately before assembly.• Never unpack several rotors at once.• Never place the rotors directly next to one another without providing adequate protection.• Never carry any objects made of magnetizable materials (for example watches, steel or iron tools) and/or permanent magnets close to the rotor! If tools that can be magnetized are still required, then hold any tool firmly using both hands. Slowly bring the tool to the rotor.• Immediately install the rotor after it has been unpacked.• Use a special installation device when centering and assembling the stator and rotor as individual components. Maintain the special procedure.• Keep the following tools at hand to release parts of the body (hand, fingers, foot etc.) trapped between two components:<ul style="list-style-type: none">– A hammer (about 3 kg) made of solid, non-magnetizable material– Two pointed wedges (wedge angle approx. 10° - 15°, minimum height 50 mm) made of solid, non-magnetizable material (e.g. hard wood)



⚠ WARNING

Risk of burning when touching hot surfaces

There is a risk of burning when touching hot surfaces immediately after the motor has been operational.

- Wait until the motor has cooled down.



⚠ WARNING

Danger to life when the cooling system bursts

The motor will overheat if it is operated without cooling. When cooling water enters the hot motor, this immediately and suddenly generates hot steam that escapes under high pressure. This can cause the cooling water system to burst, resulting in death, severe injury and material damage.

- Never operate the motor without cooling.
- Only commission the cooling water circuit when the motor is in a cool condition.

⚠ CAUTION

Risk of burns when hot cooling water escapes

There is a risk of burns caused by escaping hot cooling water and steam if you open the cooling circuit of a motor that was previously in operation.

- Do not open the motor cooling circuit until the motor has cooled down.



⚠ WARNING

Risk of electric shock due to incorrect connection

There is a risk of electric shock if direct drives are incorrectly connected. This can result in death, serious injury, or material damage.

- Motors must always be precisely connected up as described in these instructions.
- Direct connection of the motors to the three-phase supply is not permissible.
- Consult the documentation of the drive system being used.



⚠ WARNING

Electrical shock hazard

Every movement of the rotor compared with the stator and vice versa induces a voltage at the stator power connections.

When the motor is switched on, the stator power connections are also at a specific voltage.

If you use defective cable ports, you could suffer an electric shock.

- Only mount and remove the electrical components if you are qualified to do so.
- Any work carried out at the motor must always be done with the system in a no-voltage condition.
- Do not touch the cable ports. Correctly connect the stator power connections, or insulate them properly.
- Do not disconnect the power connections when the stator is under voltage (live).
- Only use the specific power cables intended for the purpose.
- First connect the protective conductor (PE).
- Connect the cable shield through a wide area.
- First connect the power cable to the stator before you connect the power cable to the inverter.
- First disconnect the connection to the inverter before you disconnect the power connection to the stator.
- Disconnect the protective conductor PE last.



! WARNING

Risk of electric shock as a result of residual voltages

There is a risk of electric shock if hazardous residual voltages are present at the motor connections. Even after switching off the power supply, active motor parts can have a charge exceeding 60 μ C. In addition, even after withdrawing the connector 1 s after switching off the voltage, more than 60 V can be present at the free cable ends.

- Wait for the discharge time to elapse.

! WARNING

Risk of injury when carrying out disassembly work

Risk of death, serious personal injury and/or material damage when carrying out disassembly work.

- When carrying out disassembly work, observe the information in Chapter "Decommissioning and disposal " in the operating instructions "SIMOTICS T-1FW6 built-in motors."

The motors have been designed for a long service life. Carefully ensure that maintenance work is correctly performed, e.g. removing chips and particles from the air gap.

For safety reasons it is not permissible to repair the motors:

! WARNING

Risk of injury when changing safety-relevant motor properties

Changing safety-relevant motor properties may result in death, serious injury and/or material damage.

Examples of changed safety-relevant motor properties:

Damaged insulation does not protect against arcing. There is a risk of electric shock!

Damaged sealing no longer guarantees protection against shock, ingress of foreign bodies and water, which is specified as IP degree of protection on the rating plate.

Diminished heat dissipation can result in the motor being prematurely shut down and in machine downtime.

- Do not open the motor.

Note

If incorrect changes or corrective maintenance are carried out by you or a third party on the contractual objects, then for these and the consequential damages, no claims can be made against Siemens regarding personal injury or material damage.

Siemens service centers are available to answer any questions you may have.
Siemens Service Center addresses can be found at
<http://www.siemens.com/automation/service&support>

 **CAUTION**

Sharp edges and falling objects

Sharp edges can cause cuts and falling objects can injure feet.

- Always wear safety shoes and safety gloves!

3.5.2 Maintenance work

Performing maintenance work on the motor

Note

It is essential that you observe the safety information provided in this documentation.

As a result of their inherent principle of operation, the motors are always wear-free. To ensure that the motor functions properly and remains free of wear, the following maintenance work needs to be carried out:

- Regularly check that the rotary axis is free to rotate.
- Ensure perfect operation and that the power losses are adequately dissipated.
 - Keep the air gap free of metal chips and particles.
 - Keep pollution and dirt away from the motor space, e.g. metal chips and oil.
 - Clean the motor, depending on local degree of pollution.
- Regularly check the general condition of the motor components.
- Check the current drawn in the previously defined test cycle.
- Check the cables to ensure that they are not damaged and are not worn. Never use electrical devices and equipment with damaged cables.
- Make sure that the cable glands are secure.

Intervals between maintenance

Since operating conditions differ greatly, it is not possible to specify intervals between maintenance work.

Indications that maintenance work is required

- Dirt in the motor cabinet
- Distinctive changes in the behavior of the machine
- Unusual sounds emitted by the machine
- Problems with positioning accuracy
- Higher current consumption

3.5.3 Checking the insulation resistance

Notes for checking the insulation resistance



⚠ WARNING
Risk of electric shock
<p>If you check the insulation resistance using high voltage on a plant/machine equipped with direct drives or directly at the motors, this can damage the motor insulation! Examples necessitating that the insulation resistance is checked include the installation test, preventive maintenance and troubleshooting.</p>
<ul style="list-style-type: none">• Only use test equipment that is in compliance with EN 61557-1, EN 61557-2 and EN 61010-1 or the corresponding IEC standards.• The test may only be carried out with a maximum direct voltage of 1000 V for a maximum time of 60 s!• Measure the insulation resistance with respect to the PE connection or the motor enclosure.• If a higher DC or AC voltage is necessary to test the machine/plant, you must coordinate the test with your local Siemens office!• Carefully observe the operating instructions of the test equipment!

Always proceed as follows when testing the insulation resistance of individual motors:



1. Connect all winding and temperature sensor connections with each other; the test voltage must not exceed 1000 VDC, 60 s with respect to PE connection.
2. Connect all temperature sensor connections to the PE connection and all winding connections with each other; the test voltage must not exceed 1000 VDC, 60 s, winding with respect to PE connection.



Each insulation resistance must be at least 10 MΩ, otherwise the motor insulation is defective.



⚠ WARNING
Risk of death due to electric shock!
<p>During and immediately after the measurement, in some instances, the terminals are at hazardous voltage levels, which can result in death if touched.</p>
<ul style="list-style-type: none">• Never touch the terminals during or immediately after measurement.

3.5.4 The inspection and change intervals for the coolant

Test and replacement intervals of the cooling medium

The test and replacement intervals for the cooling medium should be agreed with the manufacturers of the anti-corrosion agent and the cooling system.

Motor components and options

4.1 Motor components

4.1.1 Overview of the motor construction

The built-in torque motor contains the following components:

- **Stator:**
this comprises an iron core and a 3-phase winding.
The winding is encapsulated to ensure that the heat loss can be dissipated more effectively. The motor is designed for water cooling (main cooler). The system design depends on the frame size (external diameter) of the motor, see the "Cooling type version" table at the end of this chapter.
- **Rotor:**
this is the reaction part of the motor. It comprises a cylindrical hollow steel shaft with permanent magnets around its circumference.
- **Cooling connection adapter (optional):**
this can be ordered for motors with integrated cooling whereby the main and precision cooler are operated in parallel on one heat-exchanger unit.

4.1.1.1 Motors with a cooling jacket

The cooling jacket surface of the motor contains circular grooves which, in conjunction with a surrounding construction provided by the machine manufacturer, create a closed liquid cooling circuit.

The coolant inlet/return flow circuit must be provided by the machine manufacturer in the surrounding construction.

4.1 Motor components

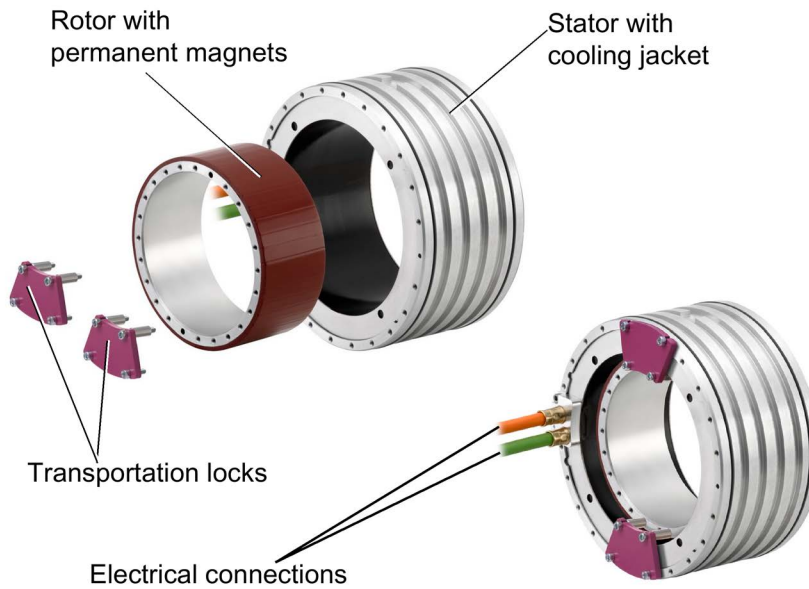

Figure 4-1 Motor components of the 1FW609 and 1FW613 built-in torque motors with cooling jacket

4.1.1.2 Motors with integrated cooling

Motors with integrated single-circuit cooling

These motors have an integrated single-circuit cooling system that is ready to be connected. Further, they are compact, and can therefore be simply integrated into a machine.

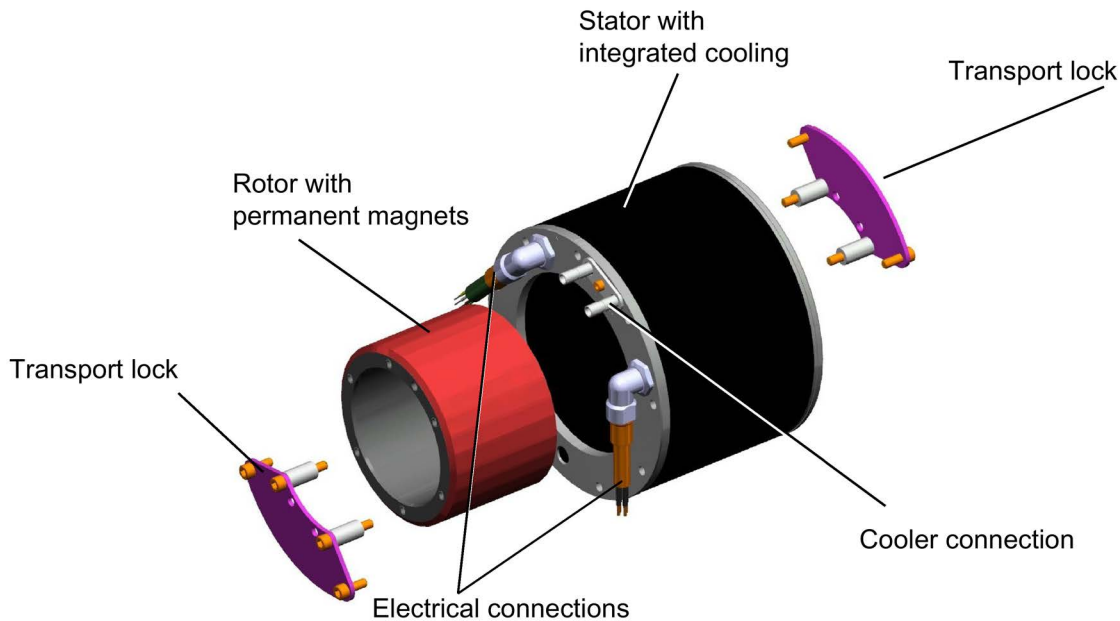

Figure 4-2 Motor components of the 1FW605 and 1FW606 built-in torque motors with integrated cooling (1 cooling circuit)

Motors with integrated dual-circuit cooling

These motors are equipped with a ready-to-connect, integrated dual-circuit cooling system, which provides considerable thermal insulation with respect to the mechanical axis construction.

The dual-circuit cooling system comprises a main and precision cooler (thermo-sandwich® principle).

An internal cooling circuit (main cooler) dissipates most of the winding losses P_v of the stator. A thermal insulation layer between the stator and the mounting flanges of the stator prevents heat from flowing from the motor winding to the machine construction.

Any heat that does flow through the insulation layer is captured, for the most part, by a second heat sink (precision cooler) on the flange surfaces and dissipated. This ensures that the temperature on the mounting surfaces of the stator remains suitably low under all permissible operating conditions.

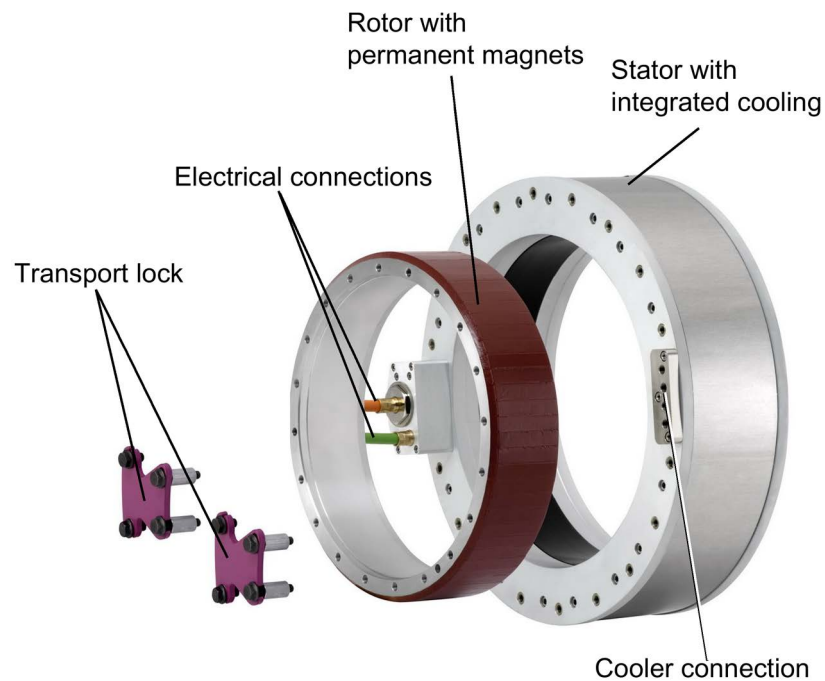

Figure 4-3 Motor components of the 1FW616 to 1FW629 built-in torque motors with integrated cooling (2 cooling circuits)

4.1 Motor components

4.1.1.3 Cooling method

The stator in the built-in torque motors is equipped with a liquid cooler for dissipating heat loss.

The cooling method used depends on the size (external diameter) of the motor as follows.

Table 4- 1 Cooling method

Size	Cooling jacket	Integrated cooling with one cooling circuit (only main cooler)	Integrated cooling with two cooling circuits (main cooler and precision cooler)
1FW605		X	
1FW606		X	
1FW609	X		
1FW613	X		
1FW615	X		
1FW616			X
1FW619			X
1FW623			X
1FW629			X

4.1.2 Temperature monitoring and thermal motor protection

4.1.2.1 Temperature monitoring circuits Temp-S and Temp-F

The motors are equipped with the two temperature monitoring circuits – Temp-S and Temp-F – that are described below.

- Temp-S activates the thermal motor protection when the motor windings are thermally overloaded. In this case the precondition is that Temp-S is correctly connected and evaluated. For a thermal overload, the drive system must bring the motor into a no-current condition.
- Temp-F is used for temperature monitoring and diagnostics during commissioning and in operation.

Both temperature monitoring circuits are independent of one another.

For example, the SME12x sensor module or the TM120 terminal module evaluates the temperature sensor signals.

You can obtain commissioning information from Technical Support. Contact data is provided in the introduction.

Temp-S

All motors are equipped with the following temperature monitoring circuit to protect the motor winding against thermal overload:

- 1 x PTC 130 °C temperature sensor per phase winding U, V and W, i.e. response threshold at 130 °C

In addition, 1FW6090-xxxxx-xxx2 to 1FW6290-xxxxx-xxx2 motors are equipped with the following temperature monitoring circuit:

- 1 x PTC 150 °C temperature sensor for each phase winding U, V and W, response threshold at 150 °C

The three PTC temperature sensors (PTC thermistor temperature sensors) of this temperature monitoring circuit are connected in series with a PTC triplet.

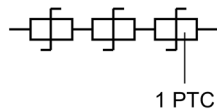

Figure 4-4 PTC triplet

To protect the power connection at the enclosure against thermal overload, an additional PTC 80 °C is connected in series with the PTC 130 °C triplet. For stators of 1FW6090-xxxxx-xxx2 to 1FW6290-xxxxx-xxx2, an additional PTC 80 °C is connected in series with the PTC 150 °C triplet.

4.1 Motor components

Table 4- 2 Types of temperature monitoring circuits

Article No.	Temp-S (PTC 130 °C), Temp-F (KTY 84)	Temp-S (PTC 130 °C), Temp-F (Pt1000)	Temp-S (PTC 130 °C and PTC 150 °C), Temp-F (KTY 84)
1FW6050-xxxxx-xxx1	X		
1FW6050-xxxxx-xxx3		X	
1FW6060-xxxxx-xxx1	X		
1FW6060-xxxxx-xxx3		X	
1FW6090-xxxxx-xxx2			X
1FW6090-xxxxx-xxx3		X	
1FW6130-xxxxx-xxx2			X
1FW6130-xxxxx-xxx3		X	
1FW6150-xxxxx-xxx2			X
1FW6150-xxxxx-xxx3		X	
1FW6160-xxxxx-xxx2			X
1FW6160-xxxxx-xxx3		X	
1FW6190-xxxxx-xxx2			X
1FW6190-xxxxx-xxx3		X	
1FW6230-xxxxx-xxx2			X
1FW6230-xxxxx-xxx3		X	
1FW6290-xxxxx-xxx2			X
1FW6290-xxxxx-xxx3		X	

Every phase winding is monitored so that also uneven currents – and therefore the associated different thermal loads of the individual phase windings – are detected. For the following motion and/or operating states, the individual phase windings have different thermal loads, while the motor simultaneously outputs a torque:

- At standstill (holding)
- When rotating very slowly
- Oscillation through a very small angle

Note

Shutdown time

If Temp-S responds, and its response threshold is not undershot again in the meantime, then the drive system must shut down (de-energize) the motor within 2 seconds. This prevents the motor windings from becoming inadmissibly hot.

NOTICE**Motor destroyed as a result of overtemperature**

The motor can be destroyed if the motor winding overheats.

- Connect Temp-S.
- Evaluate Temp-S.
- Ensure that the shutdown time is not exceeded.

Note**No temperature monitoring with Temp-S**

As a result of their non-linear characteristic, PTC temperature sensors are not suitable for determining the instantaneous temperature.

Temp-F

The Temp-F temperature monitoring circuit comprises an individual temperature sensor. Contrary to Temp-S, this temperature sensor only monitors one phase winding. As a consequence, Temp-F is only used for monitoring the temperature and diagnosing the motor winding temperature.

NOTICE**Motor destroyed as a result of overtemperature**

If you use Temp-F for thermal motor protection, then the motor is not adequately protected against destruction as a result of overtemperature.

- Evaluate the Temp-S temperature monitoring circuit to implement thermal motor protection.

Temp-F as KTY 84 or Pt1000

The 16th Position of the order designation on the stator rating plate indicating as to whether a KTY 84 or a Pt1000 is installed, see Rating plate data (Page 52):

1FW6xxx-xxxxx-xxx1: with KTY 84

1FW6xxx-xxxxx-xxx2: with KTY 84

1FW6xxx-xxxxx-xxx3: with Pt1000

No direct connection of the temperature monitoring circuits



⚠ WARNING
Risk of electric shock when incorrectly connecting the temperature monitoring circuit
In the case of a fault, circuits Temp-S and Temp-F do not provide safe electrical separation with respect to the power components.
<ul style="list-style-type: none">• Use, for example, the TM120 or the SME12x to connect the Temp-S and Temp-F temperature monitoring circuits. You therefore comply with the directives for safe electrical separation according to EN 61800-5-1 (previously safe electrical separation according to EN 50178).

Correctly connecting temperature sensors

NOTICE
Motor destroyed as a result of overtemperature
The motor can be destroyed as a result of overtemperature if you do not correctly connect the temperature sensors.
<ul style="list-style-type: none">• When connecting temperature sensor cables with open conductor ends, adhere to the correct assignment of conductor colors as described in "Signal connection (Page 512)".

4.1.2.2 Technical features of temperature sensors

Technical features of PTC temperature sensors

Every PTC temperature has a "quasi-switching" characteristic. The resistance suddenly increases in the vicinity of the response threshold (nominal response temperature ϑ_{NAT}).

PTC temperature sensors have a low thermal capacity – and have good thermal contact with the motor winding. As a consequence, the temperature sensors and the system quickly respond to inadmissibly high motor winding temperatures.

Table 4- 3 Technical data of the PTC temperature sensors

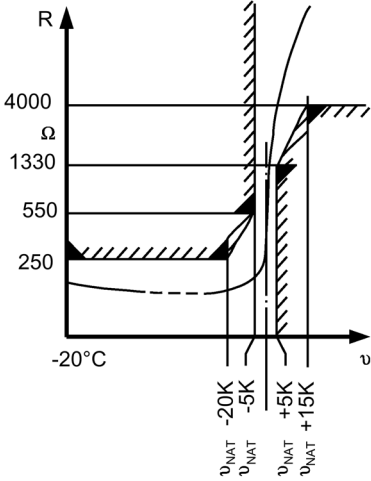
Name	Description
Type	PTC triplet acc. to DIN 44082 Individual PTC temperature sensor according to DIN 44081
Response threshold (nominal response temperature ϑ_{NAT})	150 °C ± 5 K 130 °C ± 5 K 80 °C ± 5 K
Resistance when cold R (20 °C) in the PTC triplet and in the individual PTC temperature sensor	See characteristic at $-20\text{ °C} < T < \vartheta_{NAT} - 20\text{ K}$ $R \leq 3 \times 250\ \Omega + 1 \times 250\ \Omega$ $R \leq 1000\ \Omega$
Minimum resistance when hot R in the PTC triplet and in the individual PTC temperature sensor	See characteristic at $T \leq \vartheta_{NAT} - 5\text{ K}$ $R \leq 3 \times 550\ \Omega + 1 \times 550\ \Omega$ $R \leq 2200\ \Omega$ at $T > \vartheta_{NAT} + 5\text{ K}$ $R \geq 3 \times 1330\ \Omega + 1 \times 1330\ \Omega$ $R \geq 5320\ \Omega$ at $T > \vartheta_{NAT} + 15\text{ K}$ $R \geq 3 \times 4000\ \Omega + 1 \times 4000\ \Omega$ $R \geq 16000\ \Omega$
Typical characteristic R(ϑ) of a PTC temperature sensor according to DIN 44081	 <p>The graph shows resistance R in Ohms (Ω) on the vertical axis and temperature ϑ in degrees Celsius on the horizontal axis. The vertical axis has markings at 250, 550, 1330, and 4000. The horizontal axis has a marking at -20°C. A solid curve shows the resistance increasing with temperature. A dashed curve shows a lower resistance at low temperatures. Vertical lines indicate response thresholds: $\vartheta_{NAT} - 20K$, $\vartheta_{NAT} - 5K$, $\vartheta_{NAT} + 5K$, and $\vartheta_{NAT} + 15K$. Horizontal lines from the y-axis indicate resistance values: 250 Ω, 550 Ω, 1330 Ω, and 4000 Ω. Shaded regions indicate the resistance ranges for different temperature conditions as defined in the table.</p>

Technical features of the KTY 84 temperature sensor

The KTY 84 has a progressive temperature resistance characteristic that is approximately linear. In addition, the KTY 84 has a low thermal capacity and provides good thermal contact with the motor winding. The KTY 84 has a continuous characteristic.

Table 4- 4 Technical data of the KTY 84 PTC thermistor

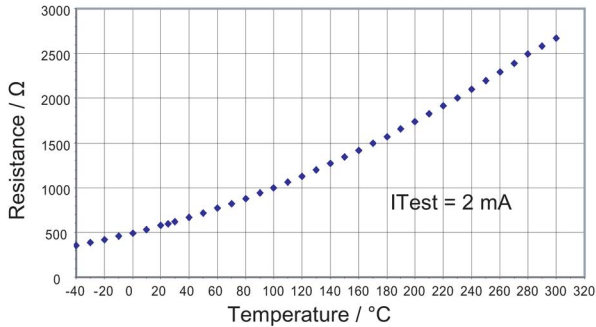
Name	Description																																								
Type	KTY 84 according to EN 60034-11																																								
Transfer range	-40 °C ... +300 °C																																								
Resistance when cold (20 °C)	ca. 580 Ω																																								
Resistance when warm (100 °C)	ca. 1000 Ω																																								
Characteristic of a KTY 84	 <p>The graph plots Resistance in Ohms (Ω) on the y-axis against Temperature in degrees Celsius (°C) on the x-axis. The y-axis scale goes from 0 to 3000 in increments of 500. The x-axis scale goes from -40 to 320 in increments of 20. The data points form a smooth, upward-sloping curve that is nearly linear. A label 'ITest = 2 mA' is present in the lower right area of the graph.</p> <table border="1"> <caption>Approximate data points from the KTY 84 characteristic graph</caption> <thead> <tr> <th>Temperature / °C</th> <th>Resistance / Ω</th> </tr> </thead> <tbody> <tr><td>-40</td><td>400</td></tr> <tr><td>-20</td><td>450</td></tr> <tr><td>0</td><td>500</td></tr> <tr><td>20</td><td>550</td></tr> <tr><td>40</td><td>600</td></tr> <tr><td>60</td><td>700</td></tr> <tr><td>80</td><td>800</td></tr> <tr><td>100</td><td>900</td></tr> <tr><td>120</td><td>1000</td></tr> <tr><td>140</td><td>1150</td></tr> <tr><td>160</td><td>1300</td></tr> <tr><td>180</td><td>1450</td></tr> <tr><td>200</td><td>1600</td></tr> <tr><td>220</td><td>1750</td></tr> <tr><td>240</td><td>1900</td></tr> <tr><td>260</td><td>2100</td></tr> <tr><td>280</td><td>2300</td></tr> <tr><td>300</td><td>2500</td></tr> <tr><td>320</td><td>2700</td></tr> </tbody> </table>	Temperature / °C	Resistance / Ω	-40	400	-20	450	0	500	20	550	40	600	60	700	80	800	100	900	120	1000	140	1150	160	1300	180	1450	200	1600	220	1750	240	1900	260	2100	280	2300	300	2500	320	2700
Temperature / °C	Resistance / Ω																																								
-40	400																																								
-20	450																																								
0	500																																								
20	550																																								
40	600																																								
60	700																																								
80	800																																								
100	900																																								
120	1000																																								
140	1150																																								
160	1300																																								
180	1450																																								
200	1600																																								
220	1750																																								
240	1900																																								
260	2100																																								
280	2300																																								
300	2500																																								
320	2700																																								

Technical features of the Pt1000 temperature sensor

The Pt1000 has a linear temperature resistance characteristic. In addition, the Pt1000 has a low thermal capacity and provides good thermal contact with the motor winding.

Table 4- 5 Technical data of the Pt1000 PTC thermistor

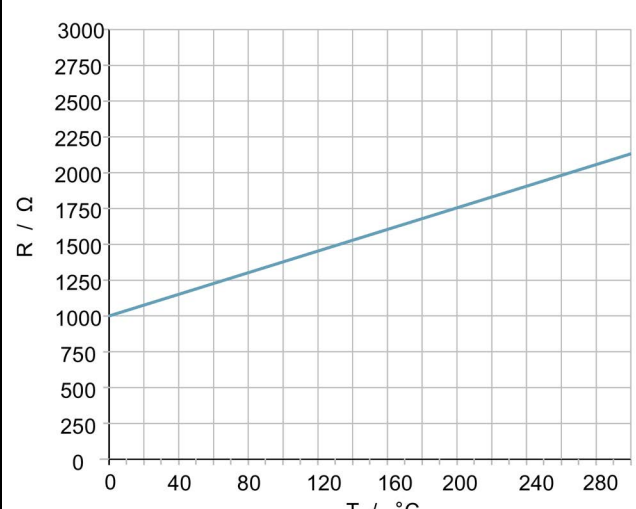
Name	Description
Type	Pt1000 according to EN 60751
Transfer range	0 °C ... +300 °C
Resistance when cold (20 °C)	ca. 1080 Ω
Resistance when warm (100 °C)	ca. 1380 Ω
Characteristic of a Pt1000	

System requirements for the Pt1000 temperature sensor

To use the Pt1000 together with the following systems, you will need at least the specified versions:

SINAMICS S120 Firmware V4.8 and V4.7 HF17

SINUMERIK V4.8 as well as V4.7 SP2 HF1 and V4.5 SP6

SIMOTION V4.5 (SINAMICS Integrated Firmware V4.8)

4.1.3 Encoders

Note

Siemens offers its mechatronic support service

Please contact your local Siemens office if you require mechatronic support regarding,

- the mechanical design of the machine
- the closed-loop control technology to be used
- the resolution and measuring accuracy of the encoder
- the optimum integration of the encoder into the mechanical structure.

When designing, constructing and optimizing your machine, we can support you with measurement-based and computer-based analyses.

You can obtain additional information from your Siemens contact person, also refer to the Internet link in the introduction under "Technical Support".

Encoder system

In the following text, encoder systems stand for angular measuring systems, rotary encoders, encoders etc.

The encoder system has a range of different functions:

- Actual speed value encoder for closed-loop speed control
- Position encoder for closed-loop position control
- Rotor position encoder (commutation)

The encoder system is not included in the scope of delivery. Due to the wide range of different applications, it is not possible to provide a comprehensive list of suitable encoders here. A certain encoder type can be ideal for one application, but essentially unsuitable for another application.

Preferred encoders are absolute angular encoders with DRIVE-CLiQ, EnDat interface or incremental angular encoders with 1 V_{PP-} signals.

Requirements regarding the encoder

Your choice of encoder essentially depends on the following application and converter-specific conditions:

- required maximum speed
- required speed accuracy
- required angular precision and resolution
- pollution level expected
- expected electrical/magnetic interference
- specified ruggedness
- electrical encoder interface

Observe the documentation of the drive system being used and the documentation of the encoder manufacturer.

Encoder systems available in the market use different scanning principles (magnetic, inductive, optical, ...).

In conjunction with this, high-resolution optical or magnetic systems must have a pulse clearance (or a grid spacing) of maximum 0.04 mm at the circumference on the measuring standard.

Systems that do not have a high resolution (e.g. inductive, magnetic) must be designed to be significantly more rugged and insensitive to pollution. With pulse clearances in the range of approx. 1 mm on the measuring standard, these systems achieve angular measuring accuracies that are still sufficient to address positioning accuracy specifications for a wide range of applications.

In some instances, encoder systems also internally interpolate the measurement signal. However, when being used on the drive system, this should be avoided as a result of the highly accurate internal interpolation of the measurement signal in the SINAMICS sensor modules.

Depending on the mechanical design of the machine regarding elasticity and natural oscillation, depending on the speed and grid spacing of the measuring standard, oscillation can be excited and noise generated.

Using a high-resolution optical measuring system, generally, when compared to other techniques, the best dynamic performance, highest control quality, high noise immunity, precision and low noise can be achieved. Further, excitation of oscillation can be also avoided.

Preconditions to achieve this include:

- The overall mechanical system, including motor and encoder mounting, permits this
- Extremely stiff dynamic machine design to avoid the excitation of low-frequency mechanical oscillation

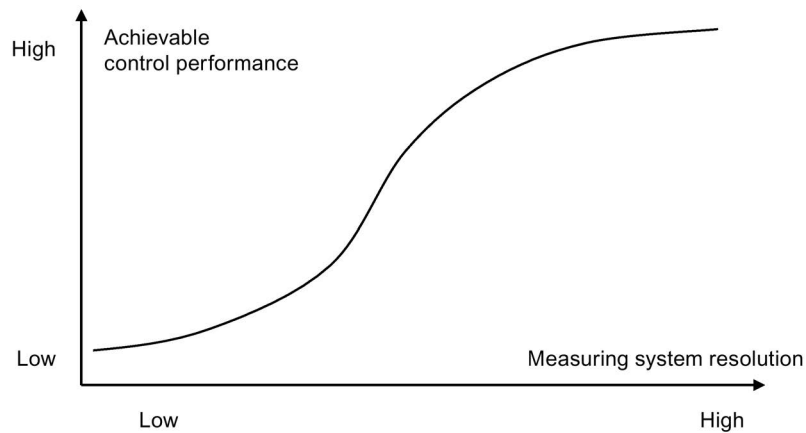

Figure 4-5 Performance-resolution diagram

Note

We cannot guarantee the composition, nature, state, or quality of non-Siemens products. Read the detailed text in "Manufacturer recommendations" in the appendix.

Note

General mechanical conditions

Take into account the permissible mechanical speed, limit frequency of the encoder and Control Unit. When configuring, mounting and adjusting the encoder refer to the appropriate documentation issued by the manufacturer!

Mechanical integration of the encoder

The mechanical integration of an encoder is defined by certain influencing factors, e.g.:

- The requirements specified by the encoder manufacturer (mounting specifications, ambient conditions)
- The closed-motor control (commutation) requires an adequately accurate connection between the motor and encoder without any play
- The closed-loop speed and position control requires that the encoder is integrated into the mechanical structure with the highest possible stiffness and lowest possible vibration
- Using the encoder as an angle measuring system for the machine precision requires that the encoder is connected as close as possible to the process

In addition to selecting a suitable encoder, the performance of the machine axis is essentially determined by the integration into the overall mechanical system.

As a consequence, a general recommendation for integrating the encoder cannot be given for all encoder types and axis concepts.

To ensure that the encoder is optimally integrated into the mechanical system, Siemens offers its Mechatronic Support service, see Catalog. For additional information, please contact your local Siemens office. You can find the "Technical Support" Internet link in Chapter "Introduction".

Two options for integrating an encoder are shown as example in the following example.

Good encoder arrangement

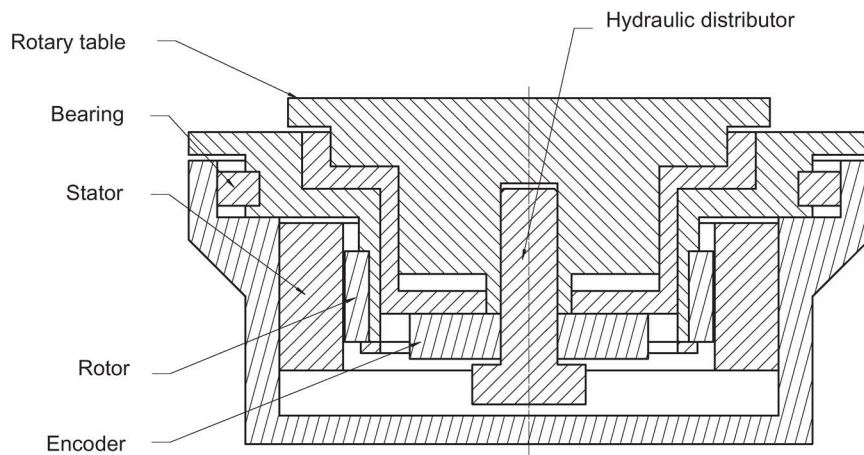

- Small distance between the motor and motor encoder
- Motor encoder securely attached
- No force introduction between the motor and motor encoder

Bad encoder arrangement

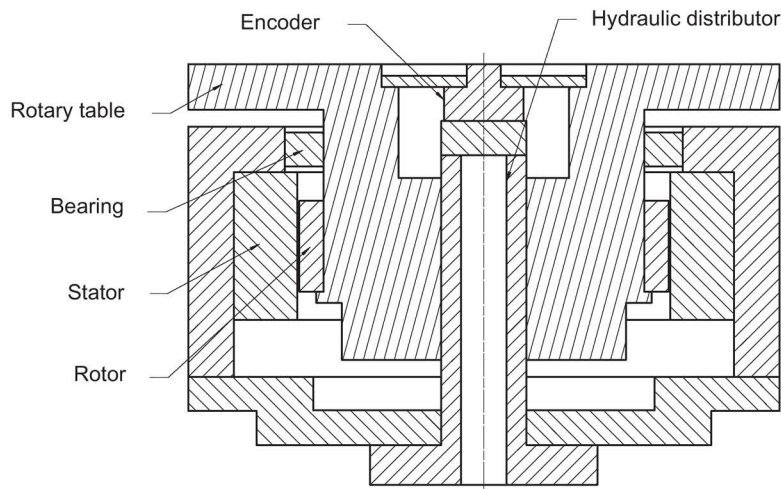

- Large distance between the motor and motor encoder
- Lack of rigidity due to an excessively thin plate for securing the motor encoder
- Force introduction between the motor and motor encoder

Figure 4-6 Mounting diagram (example)

Note

Additional mounting examples are provided in Chapter "Installation examples (Page 146)".

4.1.4 Bearings

Selecting the bearing

1FW6 torque motors are built-in motors for directly driven rotary or swivel axes. To set up a complete drive unit, a bearing between the stator and rotor is required in addition to the phase-angle encoder system.

Your choice of bearing is governed by the following factors:

- Geometric requirements (internal and external diameter)
- Speed
- Load (magnitude, direction)
- Rigidity (accuracy, pretension)
- Service life

The bearing is not included in the scope of supply.



! WARNING

Bearing currents and static charging of the rotor

Depending on the design and properties of the bearing, the rotor may become statically charged!

- Apply the corresponding remedial measures, e.g. insulated bearings or the appropriate grounding.

Note

Radial forces are generated between the stator and rotor. These must be taken into account when you select the bearing, see also the Chapter "Forces that occur between the stator and rotor (Page 119)".

4.1.5 Braking concepts

 **WARNING**

Uncontrolled coast down of the drive as a result of malfunctions

Malfunctions on a rotating machine axes can lead to the drive coasting to a stop in an uncontrolled manner.

- Take the appropriate measures to brake the drive with its maximum possible kinetic energy in the event of a fault.

The design of mechanical braking systems depends on the maximum kinetic energy, that is, the maximum moment of inertia of the rotating mass and its maximum speed.

Possible malfunctions

Malfunctions can occur e.g. for:

- Power failure
- Encoder failure, encoder monitoring responds
- Higher-level control failure (e.g., NCU); bus failure
- Control Unit failure
- Drive fault
- Faults in the NC

Below are a number of options showing how rotating masses can be braked in the event of a malfunction.

Braking and emergency stop concepts

In the case of rotating axes that are restricted to a rotation angle of $< 360^\circ$, damping and impact absorption elements at the limits of the rotation range offer reliable protection.

To dissipate the kinetic energy of the rotating mass before it comes into contact with the damping elements, the following measures should be taken to support mechanical braking systems:

1. Electrical braking using the energy in the DC link:
Please refer to the documentation of the drive system being used!
2. Electrical braking using armature short-circuit of the stator:
Please refer to the documentation of the drive system being used!
Disadvantage: The braking torque depends on the speed and may not be sufficient to bring the rotating masses to a standstill.

Note

If armature short-circuit braking is used, special contactors are required because the currents can be very high. – The release timing for the drive system must be taken into account.

3. Mechanical braking via braking elements:
The braking capacity must be dimensioned as highly as possible so that the rotating masses can be reliably braked at maximum kinetic energy.
Disadvantage: Depending on the speed, the relatively long response time of the brake controller may mean that the rotating mass continues to rotate for some time without being braked.

We recommend that all three measures be implemented together. Measures (2) and (3) are used as an additional protection here in case measure (1) fails: The short-circuiting of the stator works at high speeds to begin with and then the mechanical brake takes effect at lower speeds.

A list of recommended braking element manufacturers is provided in the appendix.

Deploying a holding brake

Due to cogging torques, torque motors can be pulled into a preferable magnetic operating position if the motor is no longer supplied with power from the drive. If the drive is already at a standstill, this can cause unexpected movements in up to a half magnetic pole pitch in both directions. To prevent possible damage to the workpiece and/or tool, it may be advisable to use a holding brake.

⚠ WARNING

Uncontrolled rotation for inclined and horizontal axes

Torque motors are not self clamping. For inclined and horizontal axes in the no current state, if the center of gravity lies outside the axis of rotation and there is no weight equalization, then load can move downwards in an uncontrolled fashion. This can result in injury and material damage.

- Use a holding brake for inclined and horizontal axes that are not equipped with weight equalization.

A holding brake may also be required if:

- The bearing friction does not compensate or exceed the cogging torques and unexpected movements result
- Unexpected movements of the drive can lead to damage (e.g. a motor with a large mass can also generate a high level of kinetic energy)
- Drives with a weight load must be shut down and de-energized in any position

To prevent movements when the drive is switched on or off, the holding brake response must be synchronized with the drive.

During commissioning, refer to the documentation for the drive system being used.

4.2 Options

4.2.1 Round sealing ring (O ring)

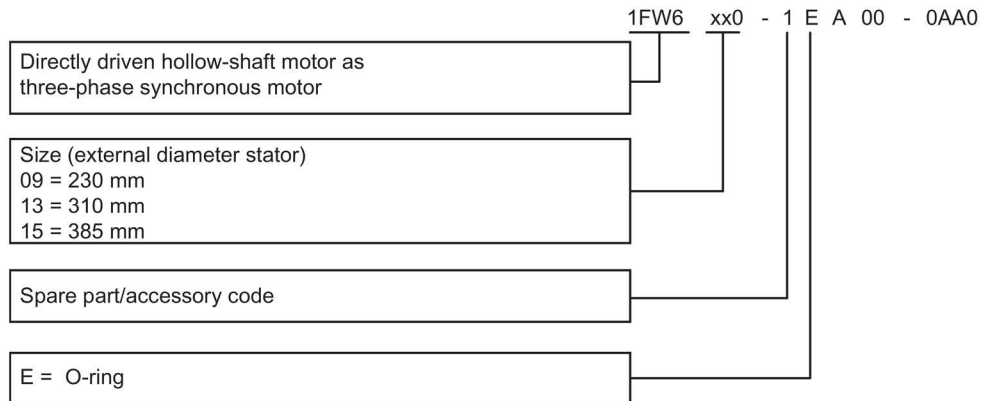

4.2.2 Cooling connection adapter

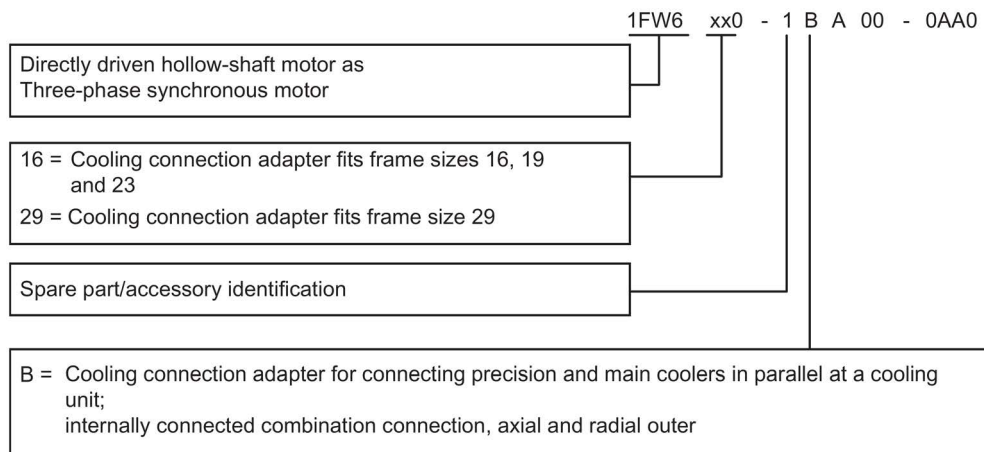

Note

The cooling connection adapter is an option, and only fits for built-torque motors with integrated cooling, for frame sizes 16, 19, 23 and 29. Please order when required.

4.2.3 Plug connector

Connector type	Connector size	Article No.
Power connection	1.5	6FX2003-0LA10
Power connection	1	6FX2003-0LA00
Signal connection	M17	6FX2003-0SU07

Note**Siemens offers its mechatronic support service**

Please contact your local Siemens office if you require mechatronic support regarding,

- the mechanical design of the machine
- the closed-loop control technology to be used
- the resolution and measuring accuracy of the encoder
- the optimum integration of the encoder into the mechanical structure.

When designing, constructing and optimizing your machine, we can support you with measurement-based and computer-based analyses.

You can obtain additional information from your Siemens contact person, also refer to the Internet link in the introduction under "Technical Support".

5.1 Configuring software

5.1.1 SIZER configuration tool

Overview

The SIZER calculation tool supports you in the technical dimensioning of the hardware and firmware components required for a drive task.

SIZER supports the following configuration steps:

- Configuring the power supply
- Designing the motor and gearbox, including calculation of mechanical transmission elements
- Configuring the drive components
- Compiling the required accessories
- Selection of the line-side and motor-side power options

The configuration process produces the following results:

- A parts list of components required (Export to Excel)
- Technical specifications of the system
- Characteristic curves
- Comments on system reactions
- Installation information of the drive and control components
- Energy considerations of the configured drive systems

You can find additional information that you can download in the Internet at SIZER (<https://support.industry.siemens.com/cs/document/54992004/sizer-for-siemens-drives?dti=0&pnid=13434&lc=en-WW>).

5.1.2 STARTER drive/commissioning software

Core statement

The STARTER commissioning tool offers

- Commissioning
- Optimization
- Diagnostics

Table 5- 1 Article number for STARTER

Commissioning tool	Article no. of the DVD
STARTER German, English, French, Italian, Spanish	6SL3072-0AA00-0AG0

5.2 Configuring workflow

Requirements

Your choice of torque motor depends on the following factors:

- The peak and rms torque of the duty cycle required for the application
- The required speed and angular acceleration
- The installation space available
- The required/possible drive arrangement (single/parallel operation)
- The required cooling method

Procedure

Selecting the motors is generally an iterative process because – in particular with highly-dynamic direct drives – the moment of inertia of the motor type is a factor in determining the required torques.

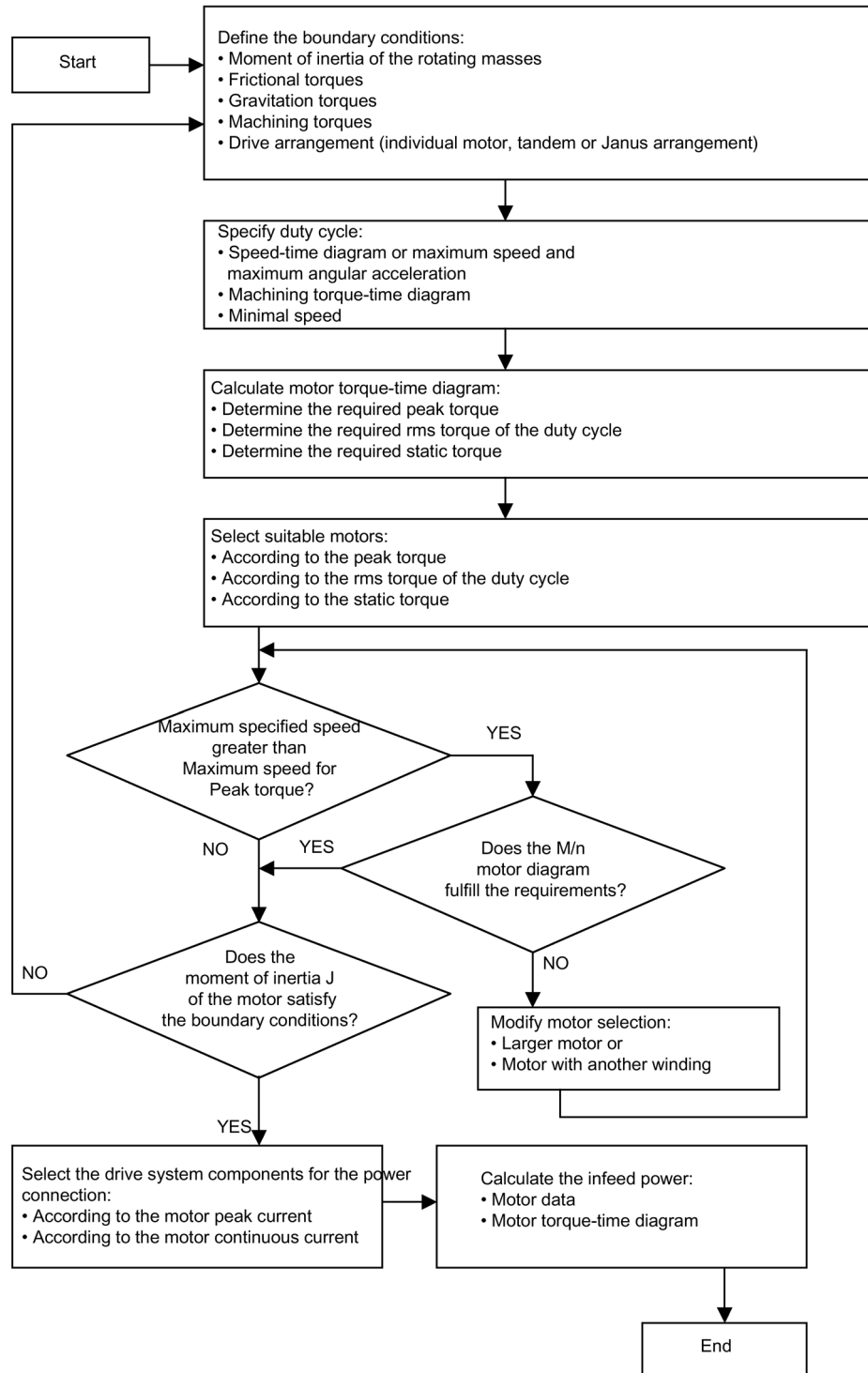

5.2.1 General mechanical conditions

Moment of inertia

The kinetic energy generated by a rotating body is directly proportional to its moment of inertia J in kgm^2 . The moment of inertia takes into account the rotating mass and its spatial distribution across the entire volume of the body with respect to the rotary axes. The rotating mass comprises the mass of the rotating mechanical structure (e.g. tool and holder) and the mass of the rotor.

Frictional torque

The frictional torque M_r is in opposition to the direction in which the rotor rotates. It can be approximately calculated from a combination of the constant "adhesion component" M_{RH} and "sliding friction component" M_{RG} . Both components also depend on the bearing used and its load.

Depending on the mechanical design, loads here generally include axial forces and clamping forces between the bearing components.

Further procedure

The moment of inertia of a suitable motor type can be used here initially.

If it transpires that the discrepancy between the assumed and actual moment of inertia is too great when further calculations are made, you then have to carry out a further iterative step when selecting the motor. To calculate the frictional torque, use the relevant specifications issued by the bearing manufacturer.

5.2.2 Type of load cycle

Uninterrupted duty S1

With uninterrupted duty S1, the motor runs permanently with a constant load. The load period is sufficient to achieve thermal equilibrium.

The rated data is of relevance when dimensioning the motor for uninterrupted duty.

NOTICE

Motor overload

An excessively high load can lead to shutdown, or if the temperature sensors are not correctly evaluated, then the motor could be destroyed.

- Ensure that the load does not exceed the value I_N specified in the data sheets!
- Ensure that the temperature sensors are correctly connected and evaluated.

Short-time duty S2

For short-time duty S2 the load duration is so short that the final thermal state is not reached. The subsequent zero-current break is so long that the motor practically cools down completely.

NOTICE

Motor overload

An excessively high load can lead to shutdown, or if the temperature sensors are not correctly evaluated, then the motor could be destroyed.

- Ensure that the load does not exceed the value I_{MAX} specified in the data sheets!
- Ensure that the temperature sensors are correctly connected and evaluated.

The motor may only be operated for a limited time $t < t_{MAX}$ with a current $I_N < I_M \leq I_{MAX}$. The time t_{MAX} can be calculated using the following logarithmic formula:

$$t_{MAX} = t_{TH} \cdot \ln \left(\frac{v}{v-1} \right)$$

with $v = (I_M / I_N)^2$ and thermal time constants t_{TH} .

The thermal time constants, the maximum currents and the rated currents of the motors can be taken from the data sheets.

The above equation is valid under the precondition that the initial temperature of the motor – the intake temperature of the water cooling T_{VORL} corresponds to what is specified in the data sheet.

Example

A motor should be operated with maximum current from the cold state.

- $I_{MAX} = 47 \text{ A}$, $I_N = 26 \text{ A}$; this results in $v = 3.268$
- $t_{TH} = 180 \text{ s}$

$$t_{MAX} = 180 \text{ s} \cdot \ln \left[\frac{3.268}{3.268 - 1} \right]$$

$$t_{MAX} \approx 66 \text{ s}$$

The motor can be operated for a maximum of 66 s at maximum current.

Intermittent duty S3

With intermittent duty S3, periods of load time Δt_B with constant current alternate with periods of downtime Δt_S with no current feed. The motor heats up during the load time and then cools down again while at standstill. After a sufficient number of duty cycles with cycle duration $\Delta t_{Spiel} = \Delta t_B + \Delta t_S$, the temperature characteristic oscillates between a constant maximum value T_o and a constant minimum value T_u ; see figure below.

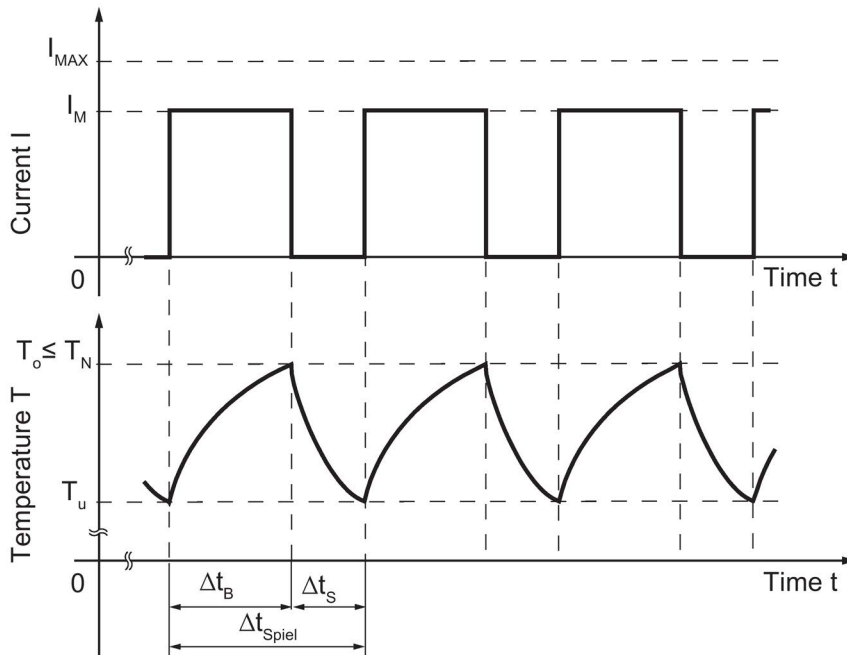

Figure 5-1 Current and temperature characteristic for intermittent duty S3

For currents $I_N < I_M \leq I_{MAX}$, it is not permissible that the rms current exceeds the rated current:

$$I_{\text{eff}} = \sqrt{\frac{1}{\Delta t_{\text{Spiel}}} (I_M^2 \cdot \Delta t_B)} = I_M \sqrt{\frac{\Delta t_B}{\Delta t_{\text{Spiel}}}} < I_N$$

In this respect, the cycle duration should not exceed 10% of the thermal time constant t_{TH} . If a longer cycle duration is necessary, please contact your local Siemens office.

Example

When the thermal time constant $t_{TH} = 180$ s, this results in the following maximum permissible cycle duration:

$$t_{\text{Spiel}} = 0.1 \cdot 180 \text{ s} = 18 \text{ s}$$

Significance of the duty cycle

In addition to the frictional torque, you must also take into account the duty cycle when selecting the motor. The duty cycle contains information regarding the sequence of motion of the drive axes and the machining forces that occur in the process.

Motional sequence

The motional sequence can be specified as a rotation angle-time diagram, angular velocity-time diagram, speed-time diagram, or angular acceleration-time diagram. The torques resulting from the motional sequence (accelerating torque M_a) are proportional with respect to the angular acceleration α and moment of inertia J , and are in opposition to the acceleration.

$$M_a = J \cdot \alpha$$

Angle-time diagrams and speed-time diagrams can be converted to angular acceleration-time diagrams $\alpha(t)$ in accordance with the following correlations:

$$\alpha(t) = \frac{dn(t)}{dt} \quad \alpha(t) = \frac{d^2\varphi(t)}{dt^2}$$

Example

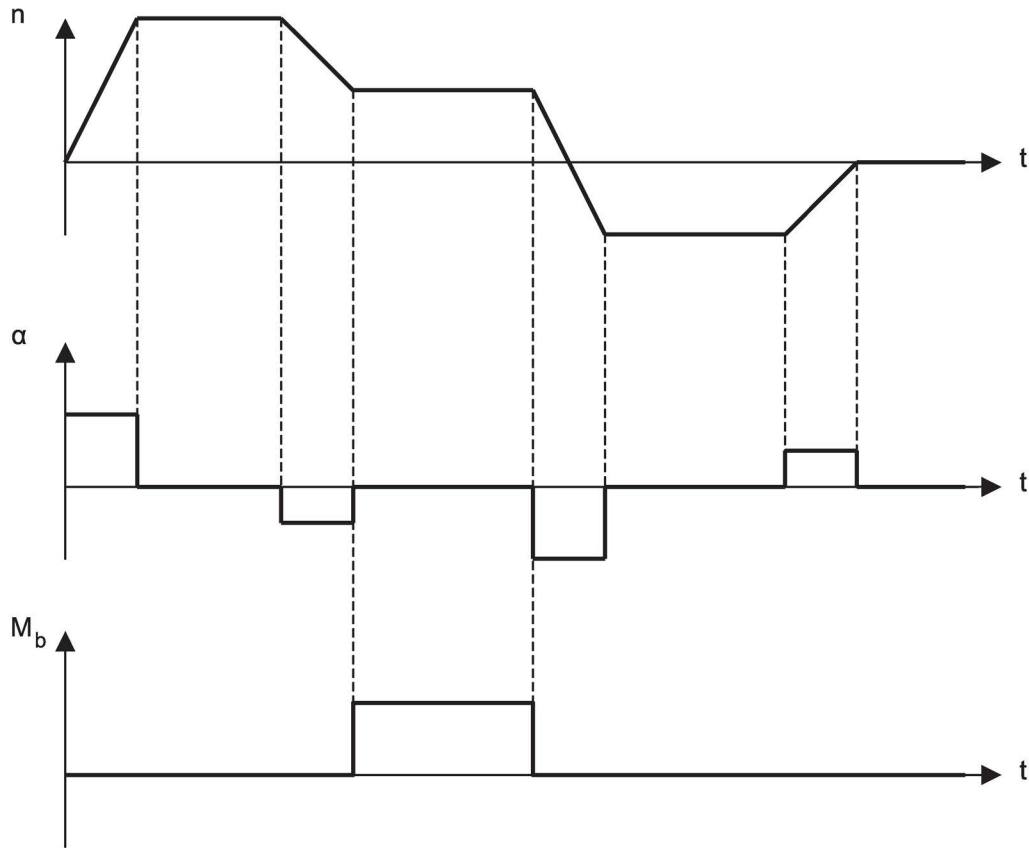

Figure 5-2 Example of a duty cycle with a speed-time diagram $n(t)$, the resulting angular acceleration-time diagram $\alpha(t)$, and a machining torque-time diagram $M_b(t)$

5.2.3 Torque-time diagram

Required motor torque

The required motor torque M_m is always the sum of the individual torques. The sign in front of the torque specifications must always be taken into account.

$$M_m = M_a + M_b + M_r$$

M_a : Accelerating torque

M_b : Machining torque

M_r : Frictional torque

Determining the required motor torque

The frictional torque characteristic can be determined on the basis of the speed characteristic. The total formula can then be used to create the motor torque-time diagram (see diagram below) from which the required peak torque M_{mMAX} can be read directly.

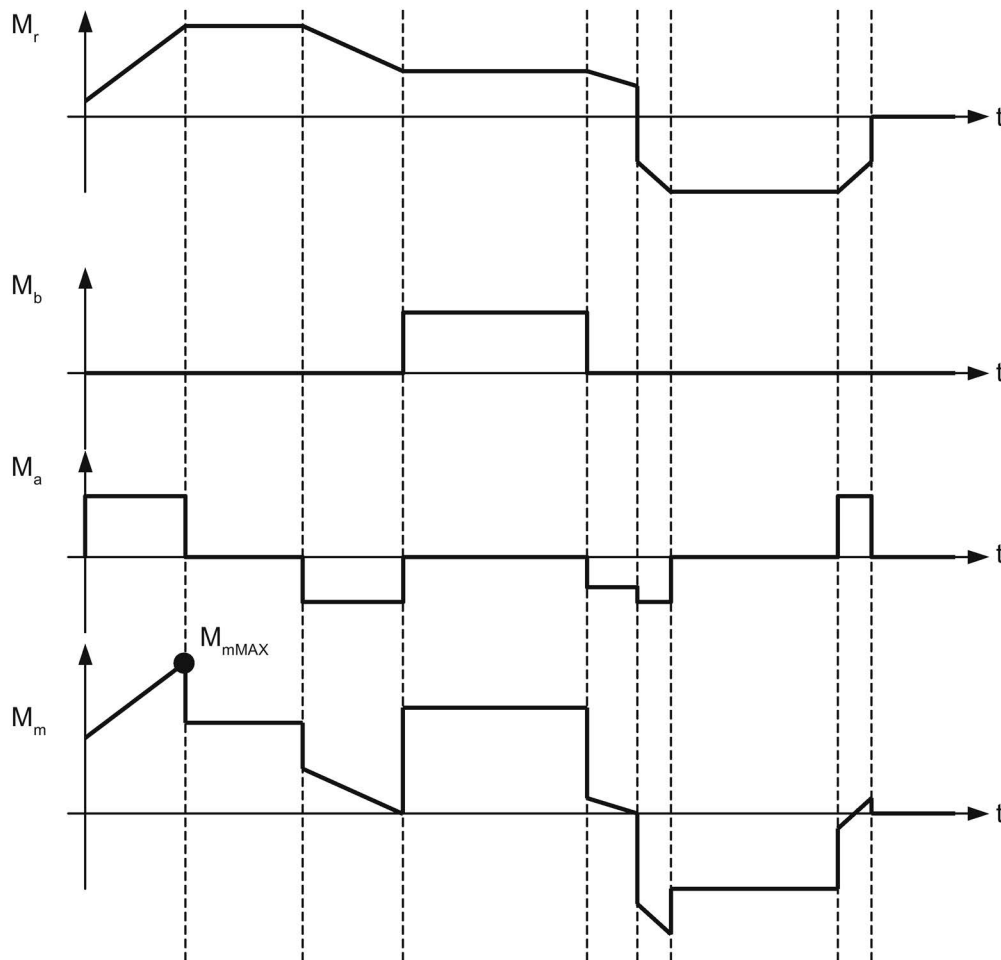

Figure 5-3 Individual torques that occur - and the resulting required motor torque - M_m for a torque drive as characteristic with respect to time

In addition to the peak torque M_{mMAX} , the required rms torque M_{eff} of the motor is also a decisive factor when dimensioning the motor. The rms torque M_{eff} mainly responsible for the temperature rise in the motor can be derived from the motor torque-time diagram by means of quadratic averaging (root mean square) and must not exceed the rated torque M_N .

$$M_{eff} = \sqrt{\frac{1}{t} \cdot \int_0^t M^2(t) dt} \leq M_N$$

If the individual torques are stable in each section, the integral can be simplified to create a totals formula (see also the following diagram).

$$M_{eff} = \sqrt{\frac{M_1^2 \cdot \Delta t_1 + M_2^2 \cdot \Delta t_2 + M_3^2 \cdot \Delta t_3 + M_4^2 \cdot \Delta t_4 + \dots}{\Delta t_1 + \Delta t_2 + \Delta t_3 + \Delta t_4 + \dots}}$$

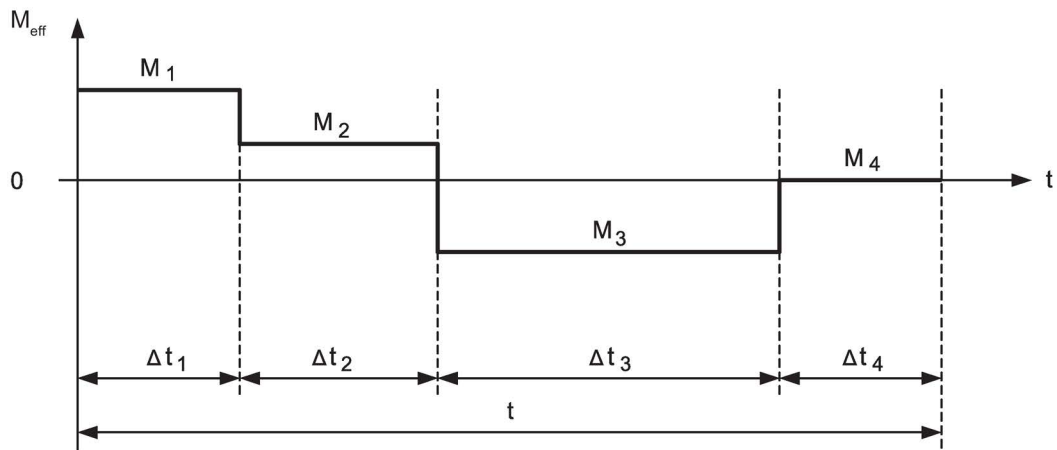

Figure 5-4 Motor torque-time diagram

5.2.4 Selecting motors

Select a suitable torque motor using the values determined for the peak torque M_{mMAX} and rms torque M_{eff} of the duty cycle.

You must take the following factors into account when selecting a motor

- Avoid undesirable limiting effects when control loops overshoot. For the maximum torque M_{MAX} include approximately 10 % control reserve with reference to the required value M_{mMAX} .
- The rated torque M_N of the motor must be at least as high as the rms torque M_{eff} determined for the duty cycle.
- If certain general conditions (e.g. machining torque or frictional torque) are not known, then you are advised to include an even higher reserve.
- In addition to the requirements resulting from the duty cycle, mechanical installation conditions may influence your choice of motor. For instance, the same motor torque can often be generated in a long motor with a smaller diameter as well as in a short motor with a larger diameter.
- If more than one torque motor generates a torque for a specific axis, the values of the peak torques and rms torques of the duty cycle of the individual motors must be added.
- If the motor is to be operated over a longer period of time at minimum speed, then select a motor with an appropriately higher rated torque, see the subsequent Chapter "Uneven current load (Page 103)".

5.2.5 Uneven current load

If the current load of the three phases is continuously uneven, the motor must only be operated at no more than approx. 70 % of its rated torque, see also M_0^* in Chapter "Technical data and characteristics".

For exact configurations, contact your local Siemens office.

Note

Uneven current load

Not all of the three phases are necessarily evenly loaded in all motor operating modes!

Examples of uneven current load:

- Standstill with current fed to the motor, e.g. for:
 - Compensation of a weight force
 - Start-up against a brake system (damping and impact absorption elements)
 - Low speeds over a longer period ($n \ll 1$ rpm)
 - Very small oscillating rotary movements (path on rotor circumference $<$ pole width)
-

5.2.6 Motor torque-speed diagram

Checking torques and speeds

At high speeds, the maximum available motor torque is limited by the available DC link voltage.

The speeds occurring in the motion sequence can exceed the maximum speed $n_{MAX,MMAX}$ specified for the motor type at the maximum torque M_{MAX} . In this case, a check must be made based on the motor torque-speed diagram. This diagram is included with the motor specifications.

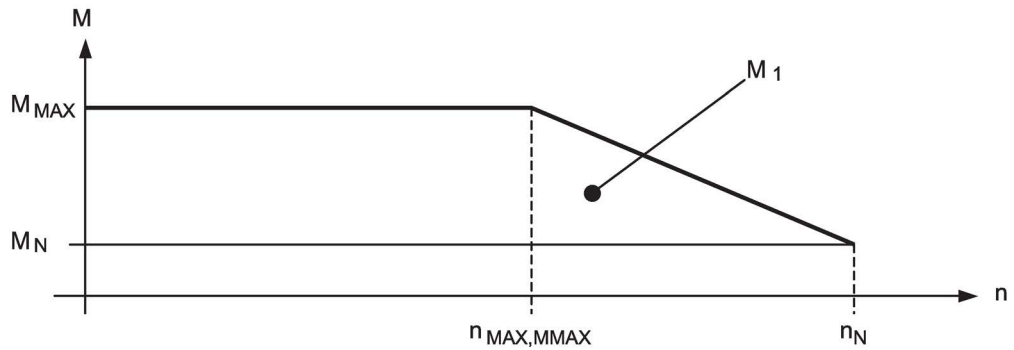

Figure 5-5 Motor torque-speed diagram

Determining the motor torque-speed diagram

If the motor torque-speed diagram is not available, then determine the motor torque-speed diagram from the following data taken from the "Motor torque speed diagram" figure.

- Maximum torque M_{MAX} with the associated speed $n_{MAX,MMAX}$
- Rated torque M_N with the associated speed n_N

In this diagram, transfer all operating points of the duty cycle from the motor torque-time diagram and the speed-time diagram. Generally, you only have to search for critical points in time in the torque-time diagram. Critical points in time are when the maximum speed exceeds the $n_{MAX,MMAX}$ at peak torque.

For these points in time, determine the motor torque (in the example M_1) from the motor torque-time diagram. Check whether the motor torque lies below the characteristic in the motor torque-speed diagram.

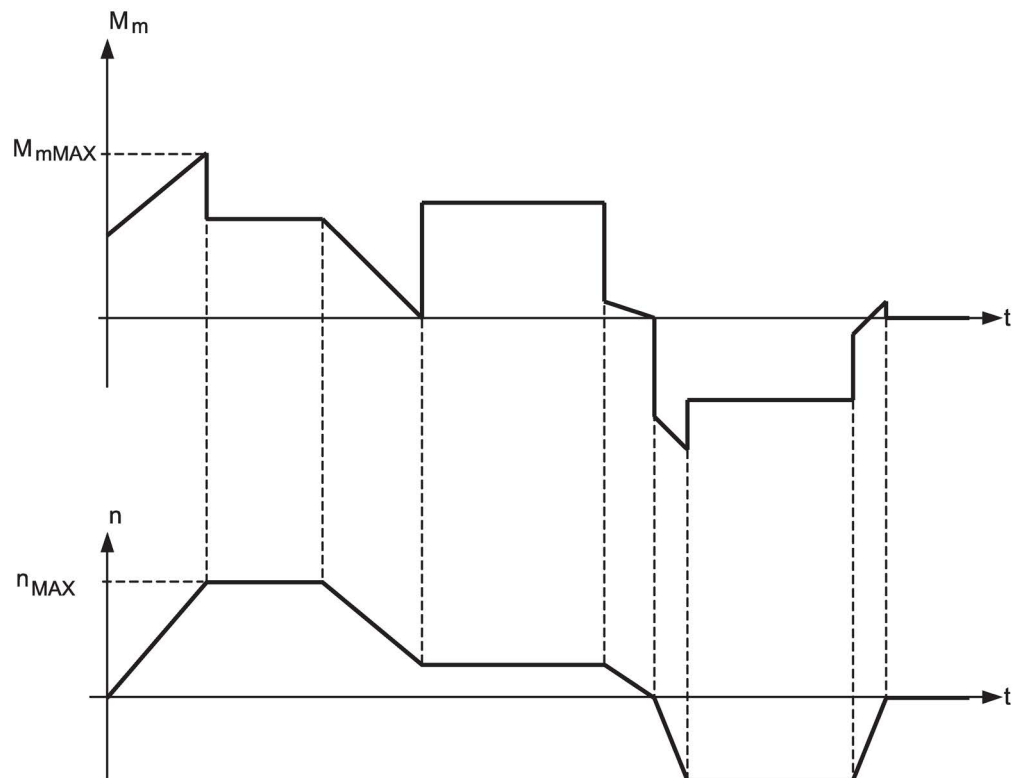

Figure 5-6 Motor torque-time diagram and associated speed-time diagram

5.2.7 Torque-speed requirements

Fulfilling the torque-speed requirements

If the selected torque motor cannot fulfill the torque-speed requirements, the following options are available:

- **Larger motor**

If an operating point in the range A is required, a motor with a larger diameter and/or longer length is required (see motor 2 in the following diagram).

Advantage: Higher torques are available.

Disadvantage: A larger motor installation space is required.

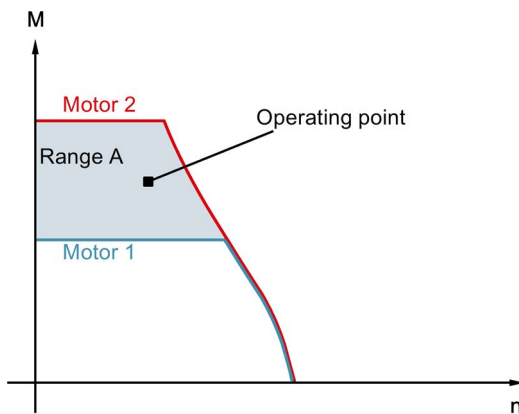

Figure 5-7 Requirement: larger motor

- **Motor with faster winding**

If an operating point in the range B is required, a motor with a lower phase inductance is required (see motor 2 in the following diagram).

Advantage: Higher speeds are possible.

Disadvantage: A higher motor current is required.

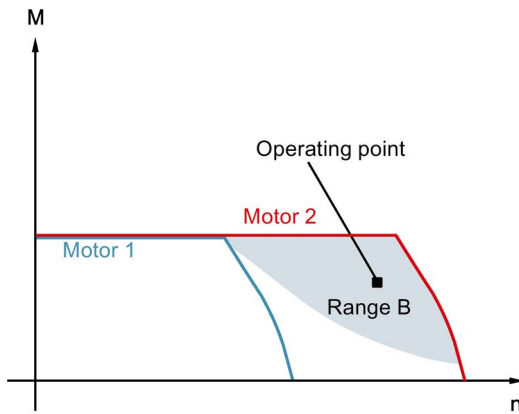

Figure 5-8 Requirement: lower phase inductance

- **Field weakening operation**

If an operating point in range C is required, then the motor must be operated in the field weakening range (see the following diagram).

Advantage: Significantly higher speeds are possible.

Disadvantage: The torques available are very low.

A lower current is required, refer to the description for field weakening operation in Chapter "Technical data and characteristics"

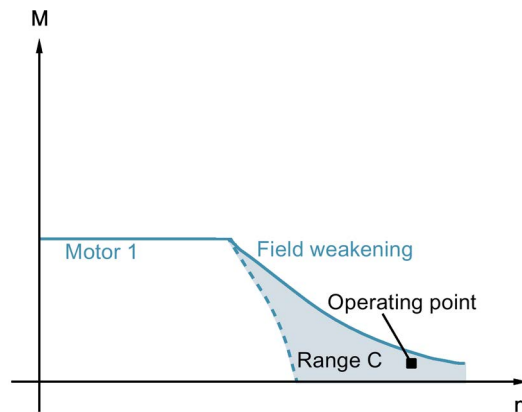

Figure 5-9 Requirement: Field weakening

5.2.8 Checking the moments of inertia

Once a suitable motor has been selected, the moment of inertia of the rotating mass on the axis has been determined. This value can be used to check the assumptions made regarding the duty cycle.

Recalculating the duty cycle

If the moment of inertia initially assumed deviates significantly from the actual moment of inertia, the duty cycle may have to be recalculated.

5.2.9 Selecting the drive system components for the power connection

The drive system components for the power connection are selected on the basis of the peak and continuous currents that occur in the duty cycle. If more than one motor is operated in parallel on a single power unit, the total values of the peak and continuous currents must be taken into account.



NOTICE

Damaged main insulation

In systems where direct drives are used on controlled infeeds, electrical oscillations can occur with respect to ground potential. These oscillations are, among other things, influenced by:

- The lengths of the cables
- The rating of the infeed/regenerative feedback module
- The type of infeed/regenerative feedback module (particularly when an HFD commutating reactor is already present)
- The number of axes
- The size of the motor
- The winding design of the motor
- The type of line supply
- The place of installation

The oscillations lead to increased voltage loads and may damage the main insulation!

- To dampen the oscillations we recommend the use of the associated Active Interface Module or an HFD reactor with damping resistor. For specific details, refer to the documentation of the drive system being used or contact your local Siemens office.

Note

The corresponding Active Interface Module or the appropriate HFD line reactor must be used to operate the Active Line Module controlled infeed unit.

5.2.10 Calculation of the required infeed

Dimensioning the Active Infeed

Use the drive's power balance to dimension the Active Infeed.

The first important quantity to know is the mechanical power P_{mech} to be produced on the motor shaft. Based on this shaft output, the electrical active power P_{Line} to be drawn from the supply system can be determined by adding the power loss of the motor $P_{V \text{ Mot}}$, the power loss of the Motor Module $P_{V \text{ MoMo}}$ and the power loss of the Active Infeed $P_{V \text{ AI}}$ to the mechanical power P_{mech} :

$$P_{\text{Line}} = P_{\text{mech}} + P_{V \text{ Mot}} + P_{V \text{ MoMo}} + P_{V \text{ AI}}$$

The active power to be drawn from the power system depends on the line voltage U_{Line} , the line current I_{Line} and the line-side power factor $\cos\phi_{\text{Line}}$ as defined by the relation

$$P_{\text{Line}} = \sqrt{3} \cdot U_{\text{Line}} \cdot I_{\text{Line}} \cdot \cos\phi_{\text{Line}}$$

This is used to calculate the required line current I_{Line} of the Active Infeed as follows:

$$I_{\text{Line}} = P_{\text{Line}} / (\sqrt{3} \cdot U_{\text{Line}} \cdot \cos\phi_{\text{Line}})$$

If the Active Infeed is operated according to the factory setting, i.e. with a line-side power factor of $\cos\phi_{\text{Line}} = 1$, so that it draws only pure active power from the supply, then the formula can be simplified to

$$I_{\text{Line}} = P_{\text{Line}} / (\sqrt{3} \cdot U_{\text{Line}})$$

The Active Infeed must now be selected such that the permissible line current of the Active Infeed is higher or equal to the required value I_{Line} .

5.2.11 Voltage Protection Module

The VPM Voltage Protection Module is used for motors with an EMF of $\hat{U} > 820 \text{ V}$ to 2000 V ($U_{\text{eff}} > 570 \text{ V}$ to 1400 V), in order to limit the DC voltage at the drive system in the case of a fault.

The VPM identifies an excessively high DC voltage ($U_{\text{DC}} > 820 \text{ V}$), short-circuits the three motor feeder cables and therefore brakes the motor. The energy remaining in the motor is converted into heat as a result of the short-circuit in the VPM and in the motor winding.

The maximum speed $n_{\text{MAX,INV}}$ is specified in the data sheets, where no Voltage Protection Module VPM is required.

You can dimension the VPM using the following formula to calculate the motor short-circuit current I_K :

$$I_K = k_T / (3 \cdot p \cdot L_{\text{STR}})$$

The explanations of the codes used in the formula can be found in Chapter "Technical data and characteristics".

5.3 Examples

Note

The data used here may deviate from the values specified in "Technical data and characteristics". This does not affect the configuration procedure, however.

General conditions for positioning within a defined period

- Moment of inertia in kgm²: $J = 5.1 \text{ kg m}^2$;
moved cylindrical mass $m = 30 \text{ kg}$ with equivalent radius $r = 0.583 \text{ m}$; axis of rotation of the moved masses and the motor are identical;
calculated from

$$J = \frac{1}{2} \cdot m \cdot r^2$$

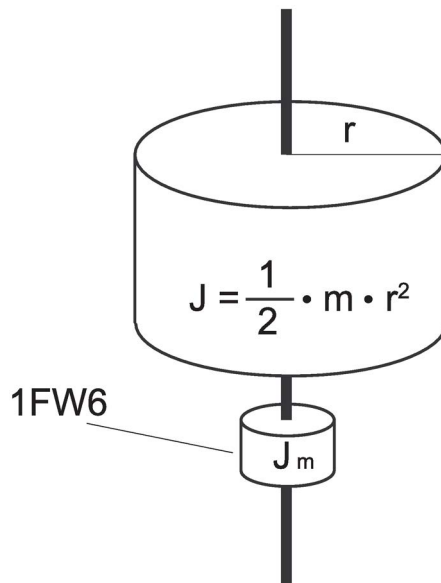

Figure 5-10 Moments of inertia of moving cylindrical mass and torque motor

- Rotation angle
in degrees: $\varphi = 120^\circ$
is equivalent
in rad: $\varphi = 2/3 \pi \text{ rad}$
- Traversing time in s: $t_1 = 0.4 \text{ s}$
- Constant friction torque in Nm: $M_r = 100 \text{ Nm}$

The following must be determined:

- Suitable torque motor
- Angular velocity ω in rad/s or speed n in rpm
- Angular acceleration α in rad/s²

The shape of the traversing profile is not stipulated, but the angle to be traversed and the duration are specified for this.

Provided that no restrictive requirements regarding angular acceleration and/or angular velocity have been specified, the most straightforward suitable traversing operation simply involves acceleration followed by deceleration.

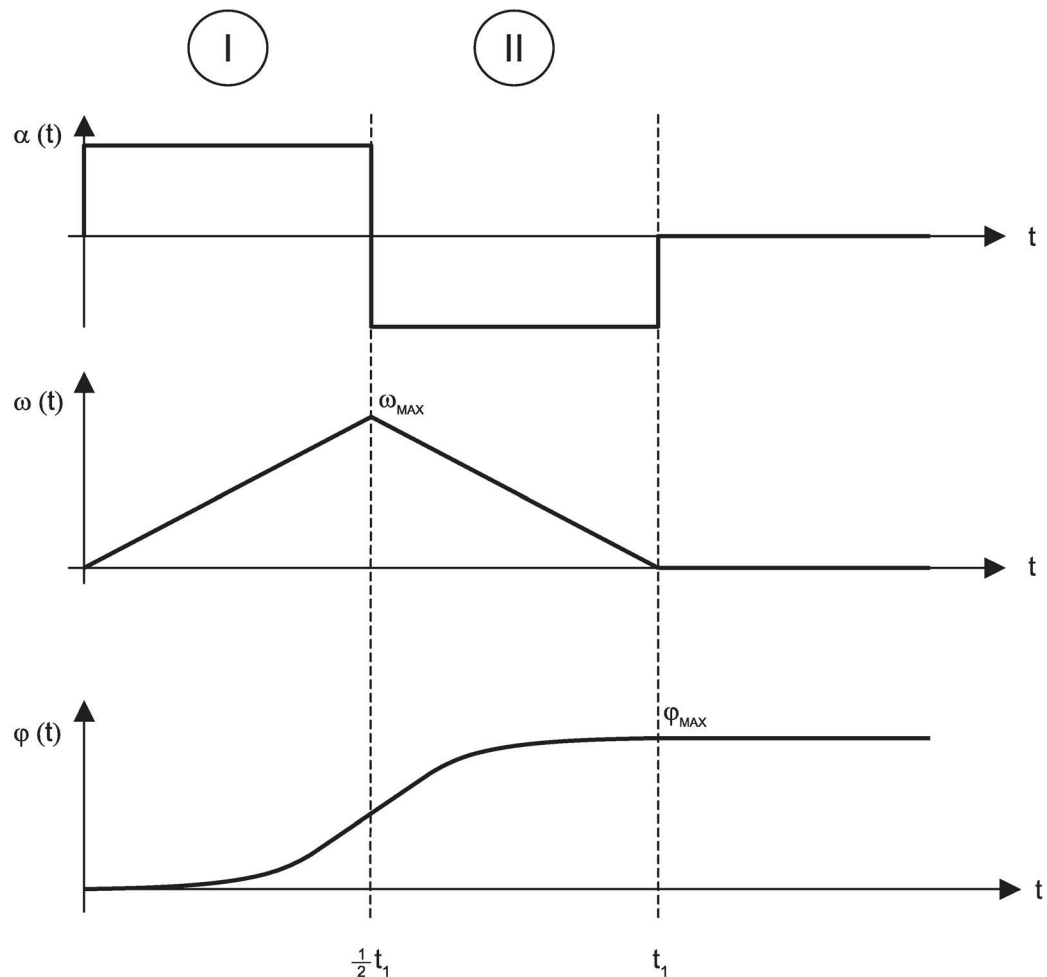

Figure 5-11 Idealized depiction of the traversing profile with angular acceleration $\alpha(t)$, angular velocity $\omega(t)$ and angle $\varphi(t)$

Table 5-2 Functions of the individual sections in the traversing profile

Section I	Section II
$\alpha_I (t) = \alpha$	$\alpha_{II} (t) = -\alpha$
$\omega_I (t) = \alpha t$	$\omega_{II} (t) = -\alpha t + \alpha t_1$
$\varphi_I (t) = \frac{1}{2} \alpha t^2$	$\varphi_{II} (t) = -\frac{1}{2} \alpha t^2 + \alpha t_1 t - \varphi_{MAX}$

The angular acceleration $\alpha (t)$ is constant section by section. In the first section, the angular velocity $\omega (t)$ increases linearly up to the maximum value, and then in the second section, linearly down to standstill.

The angle of rotation $\varphi (t)$ increases in section I and in section II according to parabolic functions. This type of traversing profile allows the shortest positioning times.

The required constant angular acceleration or angular deceleration can be calculated from the defined final angle φ_{MAX} and the associated instant in time t_1 . For the sake of simplicity, momentary transitional phases between acceleration/deceleration and the resulting angle changes are not taken into account.

Since the areas below the curves for $\omega (t)$ are the same in both sections, the following applies:

$$\varphi_{MAX} = 2 \cdot \left[\frac{\alpha}{2} \cdot \left(\frac{t_1}{2} \right)^2 \right] \quad \text{in } ^\circ \text{ or in } \text{rad} \quad \alpha = \frac{4 \cdot \varphi_{MAX}}{(t_1)^2} \quad \text{in } \text{rad/s}^2$$

The angular velocity $\frac{1}{2} t_1$ reached at instant ω_{MAX} is determined from the calculated angular acceleration:

$$\omega_{MAX} = \alpha \cdot \frac{t_1}{2} \quad \text{in } \text{rad/s}$$

The speed n_{MAX} can be calculated from the $n_{MAX} = \omega_{MAX} \cdot 60 / 2\pi$.

Note

1 rad corresponds to $180^\circ / \pi = 57.296^\circ$

1 revolution corresponds to 360° or 2π rad

The following can be calculated with the values specified:

Angular acceleration $\alpha = 52.36 \text{ rad/s}^2$

Angular velocity $\omega_{MAX} = 10.47 \text{ rad/s}$

Speed $n_{MAX} = 100 \text{ rpm}$

The following applies for the required acceleration torque:

$$M_a = (J + J_m) \cdot \alpha$$

Since the moment of inertia J_m for the 1FW6 motor is not known at the time of configuring, then initially $J_m = 0 \text{ kgm}^2$ must be assumed.

$$M_a = 5.1 \text{ kgm}^2 \cdot 52.36 \text{ rad/s}^2 = 267 \text{ Nm}$$

To accelerate the specified mass, a torque M_a of 267 Nm is required.

$$M_m = M_r + M_a$$

$$M_m = 100 \text{ Nm} + 267 \text{ Nm} = 367 \text{ Nm}$$

Together with the constant frictional torque M_r , a motor torque of $M_m = 367 \text{ Nm}$ is obtained.

A suitable motor can be selected from the "Built-in torque motors: overview" table in accordance with the following criteria:

Maximum torque at least 367 Nm.

Maximum speed (specifying the max. torque): at least 100 rpm.

Suitable motors are:

1FW6090-0PB15-2JC2 (diameter 230 mm, length 190 mm)

1FW6130-0PB05-1JC2 (diameter 310 mm, length 90 mm)

The moment of inertia of the motor 1FW6090-0PB15-2JC2 is $J = 0.0465 \text{ kgm}^2$.

The accelerating torque M_a can now be corrected to:

$$M_a = (5.1 \text{ kgm}^2 + 0.0465 \text{ kgm}^2) \cdot 52.36 \text{ rad/s}^2 = 269 \text{ Nm}$$

This means that the total motor torque required increases $M_m = M_r + M_a$ up to 369 Nm.

The moment of inertia of the motor 1FW6130-0PB05-1JC2 is $J = 0.0637 \text{ kgm}^2$.

The accelerating torque M_a can now be corrected to:

$$M_a = (5.1 \text{ kgm}^2 + 0.0637 \text{ kgm}^2) \cdot 52.36 \text{ rad/s}^2 = 270 \text{ Nm}$$

This means that the total motor torque required increases $M_m = M_r + M_a$ up to 370 Nm.

Evaluation

Both motors are suitable for this positioning task. The installation requirements govern which motor is better suited. During positioning, the motor reaches a torque that far exceeds its rated torque M_N , and the resulting power loss is much greater than the permissible continuous power loss. Provided that positioning only takes a short time and the winding temperature remains below the shutdown limit, this high load is permissible. Also see Section "Intermittent duty S3" in Chapter "Specification of the duty cycle".

Periodic duty cycle (S3 mode)

The motor can repeat a drive operation any number of times (e.g. the positioning operation described above), in which $M > M_N$ intermittently occurs, if there are sufficiently long intervals in which the windings are de-energized between the load phases. Also see Section "Intermittent duty S3" in Chapter "Specification of the duty cycle."

The "duty cycle" comprises the load phase and the zero-current (cooling) phase. The cooling phases are crucial here: As a result of the no-load intervals, the effective torque of the duty cycle is reduced to the value of the rated torque M_N of the motor.

If the future duty cycle is either not known or cannot be estimated, the motor can only be selected on the basis of the required maximum speed and peak torque. This means that for the duty cycle, the maximum permissible rms torque M_{eff} of the duty cycle is also defined. This results in a very short cooling phase, the length of which must not be undershot.

A significantly simplified load cycle comprising three time segments with lengths Δt_1 , Δt_2 , Δt_3 is assumed by way of example. In these time segments, torques M_1 , M_2 , M_3 are produced. Each of these torques can have any value between $+M_{MAX}$ and $-M_{MAX}$. The effective torque M_{eff} of this load cycle in Nm can be calculated using the following formula:

$$M_{eff} = \sqrt{\frac{M_1^2 \cdot \Delta t_1 + M_2^2 \cdot \Delta t_2 + M_3^2 \cdot \Delta t_3}{\Delta t_1 + \Delta t_2 + \Delta t_3}}$$

In this case, the cycle duration ($\Delta t_1 + \Delta t_2 + \Delta t_3$) should not be longer than 10 % of the thermal time constant t_{TH} .

The load cycle is permissible, as long as $M_{eff} \leq M_N$.

5.4 Installation

5.4.1 Safety instructions for mounting

 **WARNING**

Risk of death and crushing as a result of permanent magnet fields

Severe injury and material damage can result if you do not take into consideration the safety instructions relating to permanent magnet fields.

- Observe the information in Chapter "Danger from strong magnetic fields (Page 29)".

Installing torque motors involves carrying out work in the vicinity of unpacked rotors. The resulting danger from strong magnetic fields is, therefore, particularly high.

Only remove the transport locks when installing the torque motor in the mechanical axis assembly, see Chapter "Procedure for installing the motor".



! WARNING

Risk of rotor permanent magnets causing crushing injuries

The forces of attraction of magnetic rotors act on materials that can be magnetized. The forces of attraction increase significantly close to the rotor. The response threshold of 3 mT for risk of injury through attraction and causing a projectile effect is reached at a distance of 100 mm (Directive 2013/35/EU). Rotors and materials that can be magnetized can suddenly slam together unintentionally. Two rotors can also unintentionally slam together.

There is a significant risk of crushing when you are close to a rotor.

Close to the motor, the magnetic forces of attraction can be up to several kN. – Example: Magnetic attractive forces are equivalent to a force of 100 kg, which is sufficient to trap a body part.

- Do not underestimate the strength of the attractive forces, and work very carefully.
- Wear safety gloves.
- The work should be done by at least two people.
- Do not unpack the rotor until immediately before assembly.
- Never unpack several rotors at once.
- Never place the rotors directly next to one another without providing adequate protection.
- Never carry any objects made of magnetizable materials (for example watches, steel or iron tools) and/or permanent magnets close to the rotor! If tools that can be magnetized are still required, then hold any tool firmly using both hands. Slowly bring the tool to the rotor.
- Immediately install the rotor after it has been unpacked.
- Use a special installation device when centering and assembling the stator and rotor as individual components. Maintain the special procedure.
- Keep the following tools at hand to release parts of the body (hand, fingers, foot etc.) trapped between two components:
 - A hammer (about 3 kg) made of solid, non-magnetizable material
 - Two pointed wedges (wedge angle approx. 10° - 15°, minimum height 50 mm) made of solid, non-magnetizable material (e.g. hard wood)

NOTICE

Destruction of the motor

If you fix the rotor and/or stator at both ends, this can result in significant material deformation in the machine assembly due to thermal expansion, which could destroy the motor.

- The machine must be designed in such a way that both the rotor and the stator are each secured on one side only. See Chapter "Installation examples".



! WARNING

Electric shock caused by defective cables

Defective connecting cables can cause an electric shock and/or material damage, e.g. by fire.

- When installing the motor, make sure that the connection cables
 - are not damaged
 - are not under tension
 - cannot come into contact with any rotating parts
- Note the permissible bending radii according to Chapter "Data of the power cable at the stator".
- Do not hold a motor by its cables.
- Do not pull the motor cables.



! WARNING

Electrical shock hazard

Every movement of the rotor compared with the stator and vice versa induces a voltage at the stator power connections.

When the motor is switched on, the stator power connections are also at a specific voltage.

If you use defective cable ports, you could suffer an electric shock.

- Only mount and remove the electrical components if you are qualified to do so.
- Any work carried out at the motor must always be done with the system in a no-voltage condition.
- Do not touch the cable ports. Correctly connect the stator power connections, or insulate them properly.
- Do not disconnect the power connections when the stator is under voltage (live).
- Only use the specific power cables intended for the purpose.
- First connect the protective conductor (PE).
- Connect the cable shield through a wide area.
- First connect the power cable to the stator before you connect the power cable to the inverter.
- First disconnect the connection to the inverter before you disconnect the power connection to the stator.
- Disconnect the protective conductor PE last.

⚠ CAUTION

Risk of crushing when the rotor is installed

There is a risk of crushing when the rotor of an installed torque motor rotates!

- Wear safety gloves.
- Take extreme care when performing any work.

⚠ CAUTION

Sharp edges and falling objects

Sharp edges can cause cuts and falling objects can injure feet.

- Always wear safety shoes and safety gloves!

5.4.2 Forces that occur between the stator and rotor

Radial and axial forces

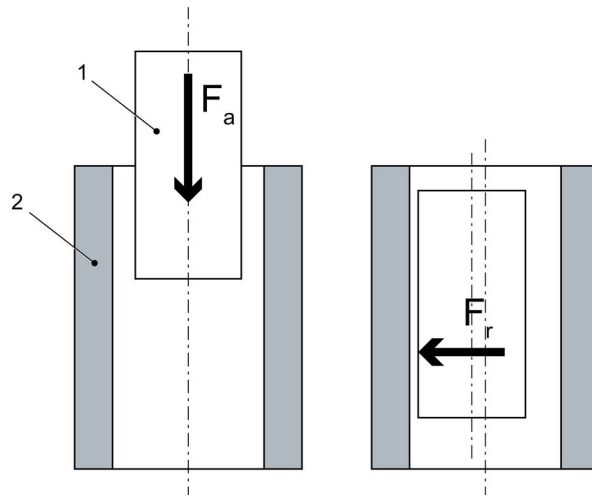

Figure 5-12 Active forces when stators and rotors are installed

- 1 Rotor with permanent magnets
- 2 Stator
- F_a Axial attractive force
- F_r Radial attractive force

Radial forces between the stator and rotor

The following table shows the active radial forces (in N per 0.1 mm centering error) between the stator and rotor. The longer the active component, the greater the radial force.

Table 5- 3 Radial forces in N/0.1 mm with radial centering errors during installation

	Active length in mm						
	30	50	70	100	110	150	200
1FW605	80	140	190	270	-	400	-
1FW606	110	180	250	350	-	520	-
1FW609	-	240	330	470	-	710	-
1FW613	-	360	500	710	-	1070	-
1FW615	-	330	460	660	-	990	-
1FW616	-	290	410	590	-	880	1180
1FW619	-	350	490	710	-	1060	1410
1FW623	-	420	590	840	-	1260	1680
1FW629	-	-	600	-	940	1280	1630

Note

You must note the radial forces between the stator and rotor as well as the maximum permissible concentricity error specified in the dimension drawings.

Example

With torque motor 1FW6090-0Px010-xxxx (active component length: 100 mm), the eccentricity is 0.2 mm, for example.

The active radial force as a result of this centering error is, therefore:

$$0.2 \text{ mm} \cdot \frac{470 \text{ N}}{0.1 \text{ mm}} = \underline{\underline{940 \text{ N}}}$$

Axial forces between the stator and rotor

Table 5- 4 Axial forces (in N) between the stator and rotor during installation

	1FW605	1FW606	1FW609	1FW613	1FW615	1FW616	1FW619	1FW623	1FW629
Axial forces in N	40	60	80	120	150	210	250	300	450

Note

At the beginning and at the end of the insertion process, the axial forces of attraction between the stator and rotor are 4x to 5x higher.

5.4.3 Installation device

Requirements of the installation device

The installation device ensures that the stator and rotor are aligned centrally during the entire installation procedure. When installing, observe the effective axial forces.

The installation device must be adapted by the customer in line with the machine construction. It must be sufficiently rigid so that it is not warped by the strong attractive forces between the stator and rotor. Radial forces must be taken into account when the installation device is dimensioned.

The installation device must not have any loose parts.

NOTICE

Destruction of the motor

The stator and rotor must not come into contact with each other during centering and installation because damage can occur.

- Use the installation device during installation.

Example: Centering and installing motors with a cooling jacket

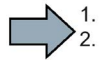

1. Place the stator so that it is centered in the holding fixture of the lower part of the installation device.
2. Place the rotor so that it is centered in the holding fixture of the upper part of the installation device.
3. Insert the spacer film in the stator in such a way that approx. 1/4 of the spacer film protrudes.

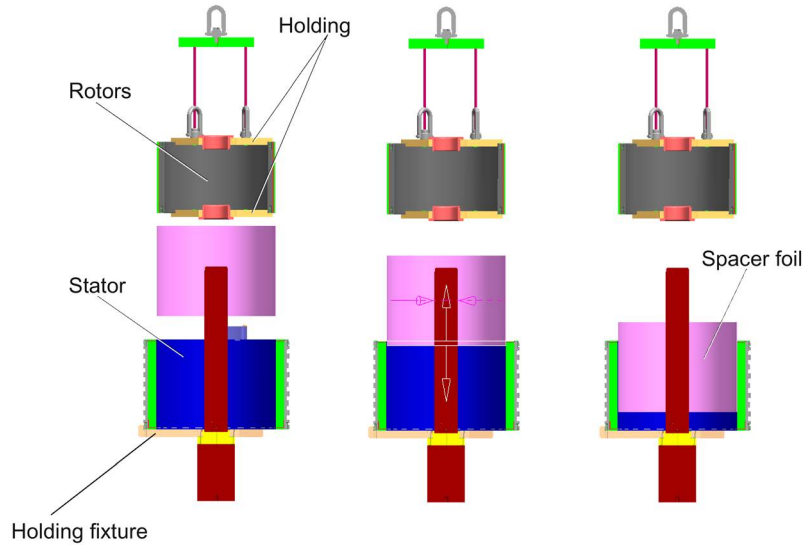

The stator is located in the holding fixture of the lower part of the installation device centered

The rotor is located in the holding fixture of the upper part of the installation device centered

- Carefully lower the rotor using the upper part of the installation device and carefully fit it into the lower part of the installation device in such a way that the rotor can be aligned centrally over the sleeve bearing and shaft in the stator.

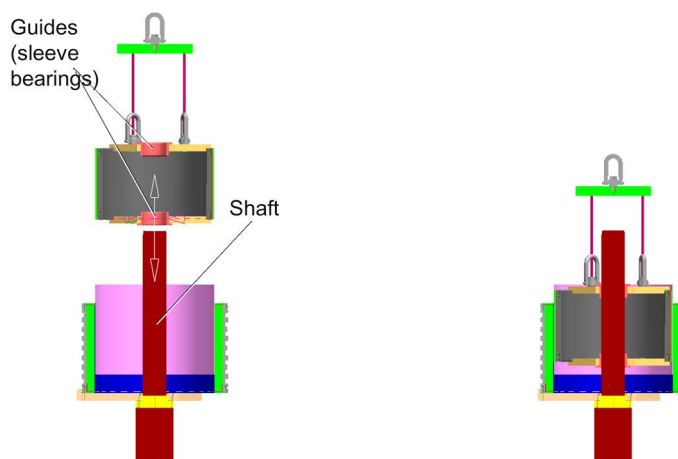

	WARNING
Risk of crushing when the rotor is lowered.	
<ul style="list-style-type: none">• Take extreme care when performing any work.	

- Using the top part of the installation device, lower the rotor as far as it will go into the lower part of the installation device.

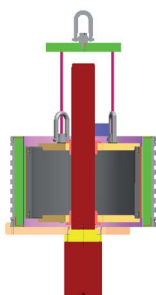

6. Fix the stator and rotor using the transport locks. To do this, tighten the bolts with the specified tightening torques according to the table "Required property classes and tightening torques for stator and rotor."
7. Remove the spacer foil. When the stator and rotor are correctly centered, the spacer film can be easily removed by hand.

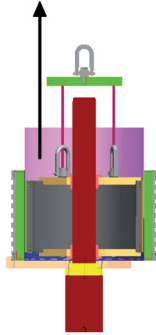

5.4.4 Specifications relating to the mounting side

Permissible mounting side

Note

As a result of the design, the following motors may only be mounted at the A flange.

Table 5- 5 Mounting at the A flange

1FW616	1FW619	1FW623	1FW629
1FW6160-xxB10-2Pxx	1FW6190-xxB10-2Pxx	1FW6230-xxB15-0Wxx	1FW6290-xxB07-2Pxx
1FW6160-xxB15-2Pxx	1FW6190-xxB15-2Pxx	1FW6230-xxB20-0Wxx	1FW6290-xxB11-2Pxx
1FW6160-xxB15-0Wxx	1FW6190-xxB15-0Wxx		1FW6290-xxB15-2Pxx
1FW6160-xxB20-2Pxx	1FW6190-xxB20-2Pxx		1FW6290-xxB20-2Pxx
1FW6160-xxB20-0Wxx	1FW6190-xxB20-0Wxx		

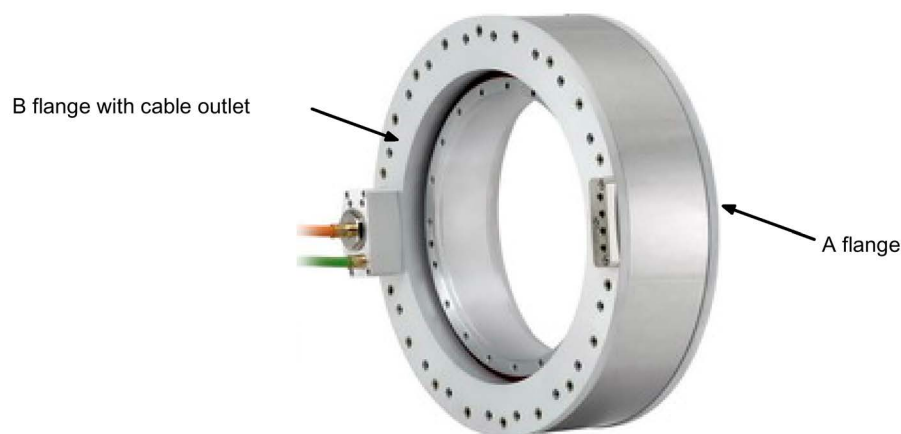

Figure 5-13 A flange and B flange

5.4.5 Specifications for mounting torque motors

Mounting system

The following must be taken into account when the torque motor is mounted:

- Only use new (unused) fixing screws.
- The mounting surfaces must be free of oil and grease.
- Note the maximum permissible insertion depth of the fixing screws in the stator and rotor (refer to the relevant installation drawing or the following table).
- The minimum insertion depth for the fixing screws in the stator:
 - 1.0 x d + section without threads (valid for 1FW605 and 1FW606)
 - 1.3 x d (valid for 1FW609 to 1FW613)
 - 1.0 x d (valid for 1FW615 and higher)
- Minimum insertion depth of the fixing screws in the rotor flange (in steel):
 - 1.1 x d (valid for 1FW605 and 1FW606)
 - 1.0 x d (valid for 1FW609 to 1FW629)
- To secure the screws, choose long clamping lengths l_k , $l_k / d > 5$ if possible; alternatively (if $l_k / d > 5$ is not possible), check pretensioning of the screws at regular intervals (tighten with calibrated torque wrench).
- Note the tightening torques specified in the table below.
- Tighten the screws in such a way that the angle of rotation is controlled. Using a calibrated torque wrench with the shortest possible bit insert, however, ensure that they are tightened in diagonally opposite (180°) pairs.
- Tighten all the screws to minimize the risk of them penetrating other materials.
- Do not use any liquids for securing the screws.

Explanations:

l_k = Clamping length of the screw in mm

d = Nominal diameter of the screw in mm (e.g. M8 screw: d = 8 mm)

Screw material and tightening torques

Screws of varying strength classes are required to secure the motor to the machine structure. The table below shows the required strength classes and tightening torques for the stator and rotor fixing screws.

Table 5- 6 Required strength classes and tightening torques for the stator and rotor

Motor	Screw (strength class)	Tightening torque M_A in Nm
1FW6050-xxB03-xxxx to 1FW6050-xxB15-xxxx	M6 (8.8)	9
1FW6060-xxB03-xxxx to 1FW6060-xxB15-xxxx	M6 (8.8)	9
1FW6090-xxB05-xxxx to 1FW6090-xxB15-xxxx	M5 (8.8)	5.2
1FW6130-xxB05-xxxx to 1FW6130-xxB15-xxxx	M5 (8.8)	5.2
1FW6150-xxB05-xxxx to 1FW6150-xxB15-xxxx	M6 (8.8)	9
1FW6160-xxB05-xxxx to 1FW6160-xxB15-xxxx	M8 (8.8)	21.6
1FW6160-xxB20-xxxx	M8 (10.9)	31.8
1FW6190-xxB05-xxxx to 1FW6190-xxB15-xxxx	M8 (8.8)	21.6
1FW6190-xxB20-xxxx	M8 (10.9)	31.8
1FW6230-xxB05-xxxx to 1FW6230-xxB15-xxxx	M8 (8.8)	21.6
1FW6230-xxB20-xxxx	M8 (10.9)	31.8
1FW6290-xxB07-xxxx to 1FW6290-xxB15-xxxx	M10 (8.8)	43
1FW6290-xxB20-xxxx	M10 (10.9)	61.8

Note

Underlying friction factor $\mu_{ges} = 0.1$

With lower friction values, the tightening torques may have to be reduced.

Also note the maximum tightening torques of the screws used. These may be lower than the values specified in the table above.

Table 5- 7 Maximum permissible screw insertion depths for the stator and rotor

Component	Max. permissible screw-in depth in mm	Thread
1FW605, 1FW606 / stator	8.5 + section without thread *)	M6
1FW605, 1FW606 / rotor	11	M6
1FW609, 1FW613 / stator and rotor	10	M5
1FW615 / stator and rotor	12	M6
1FW616, 1FW619, 1FW623 / stator	13	M8
1FW616, 1FW619, 1FW623 / rotor	12	M8
1FW629 / stator	15	M10
1FW629 / rotor	15	M10

*) See the installation drawing "detail Z"

5.4.6 Procedure when installing the motor

Sequence for installing the motor

<p> WARNING</p> <p>Risk of injury and material damage</p> <p>Injury and/or destruction of motor components can occur if you do not observe the specified sequence when installing the motor.</p> <ul style="list-style-type: none"> • Perform work steps in the specified sequence during installation.
--



1. Preparing and cleaning the mounting surfaces for motor parts and the machine.
 - Deburr and round off the holes (e.g. cooling inlet/outlet holes) inside the machine housing.
 - Carefully remove any machining residue (e.g. chippings, dirt, foreign bodies, etc.).
 - For motors with cooling jacket:
Slightly grease O-rings; for example, by drawing through a cloth dipped in grease. Take into account compatibility with the O-ring material (fluoric rubber, Viton).
2. This point only applies to motors with cooling jacket:
Guide both O-rings over the cooling jacket surface of the motor into the grooves provided.
 - Do not overstretch the O-rings (O-rings maximum of up to 10% during installation, otherwise installation and leak tightness problems may occur).
 - Do not twist the O-rings.
 - Do not use any sharp objects!
 - Use special tools to help you position the components correctly.
 - Use installation devices whenever possible.
3. If necessary, insulate the power connections properly (otherwise there is a risk of electric shock when rotating as a result of the induced voltage and short-circuit braking torques for a phase short-circuit).
4. In the delivery condition, the transport locks on the stator and rotor are attached at both flange surfaces.
Remove the transport locks at the mounting side. Loosen the transport locks on the opposite side.
If transport locks are removed or loosened, the motor must always be carefully moved. Keep the transport locks as they may be required in the case of service and when removing the motor.
Do not manually center and install the stator and rotor as individual components due to the risk of crushing!
To do this, always use the special installation device. Please refer to the description of the installation device in this chapter.
5. This point only applies to motors with cooling jacket:
Insert the motor with the free flange face forwards into the prepared locating hole of the machine housing.
In this case, the O-rings must not be forced out of the slot and damaged.
Ensure that the motor does not become canted in the installation space during the installation procedure. If the motor does however become slightly canted, this can be corrected by gently hitting the flange with a rubber mallet.
6. Screw the flange face of the stator to the machine housing and the flange face of the rotor to the adjustable axle. In this case, observe the specified torques and the mounting technology specifications listed in this chapter.
If the stator and rotor on opposite flange faces are screwed to the machine construction, a special mounting device is required.

7. Completely remove any transport locks that are still in place.
This point is not applicable for stator and rotor as individual components.
8. Remove the spacer film. When the stator and rotor are correctly centered, the spacer film can be easily removed by hand. Keep spacer film safe for subsequent transport, packaging and storage of the motor.
9. Make sure that the rotor can move without hindrance. Make sure that the spacer film and all other foreign bodies are removed from the air gap.
10. Connect the coolant ducts.
11. Connect the power and signal cables.



5.4.7 Cooler connection

The connectors can generally be installed using standard tools.

First determine the sum of the pressure losses of the individual cooling components and the associated piping. Compare the result with the cooling capacity of the cooling unit.

5.4.7.1 Cooler connection for motors with a cooling jacket

The cooler for motors with a cooling jacket is connected via the built-in construction. The cooling water cable cross-sections depend on the cross-sections of the cooling slots in the jacket. These slots are sealed by means of the housing provided by the customer and the O-rings.

In the case a built-in torque motor with a cooling jacket, the coolant must be supplied/ discharged via two holes (cut by the user) in the axes construction (see following diagrams). For information on the installation hole fit, refer to the section titled "Installation drawings/Dimension drawings".

To ensure optimized, uniform cooling across all cooling slots, the coolant infeed for torque motors 1FW609 and 1FW613 must be offset by 90° vis-à-vis the cable outlet for the electrical supply. If a different location is selected for the coolant inlet/outlet, the coolant is not distributed evenly in the cooling slots. The least favorable position for the coolant inlet/outlet is at an angle of 90° counter-clockwise: because, in this case, the coolant can barely flow through the foremost or rearmost cooling slots.

The coolant infeed must be positioned directly above the exit point of the electrical cable outlets on 1FW615 torque motors.

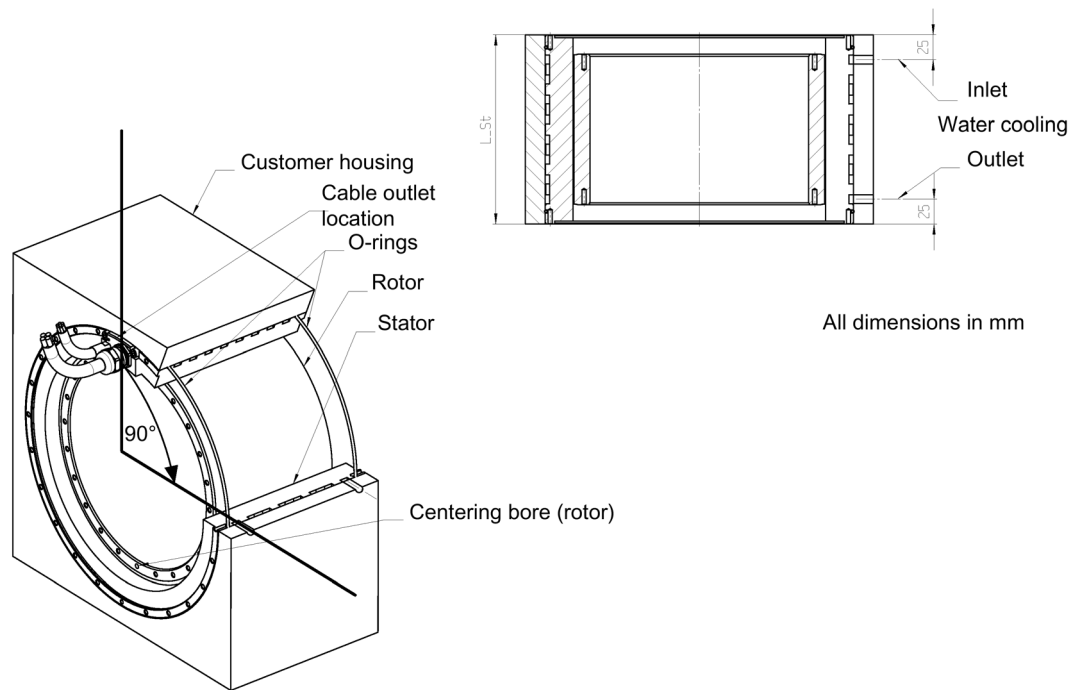

Figure 5-14 Cooler connection for 1FW609 and 1FW613 (example)

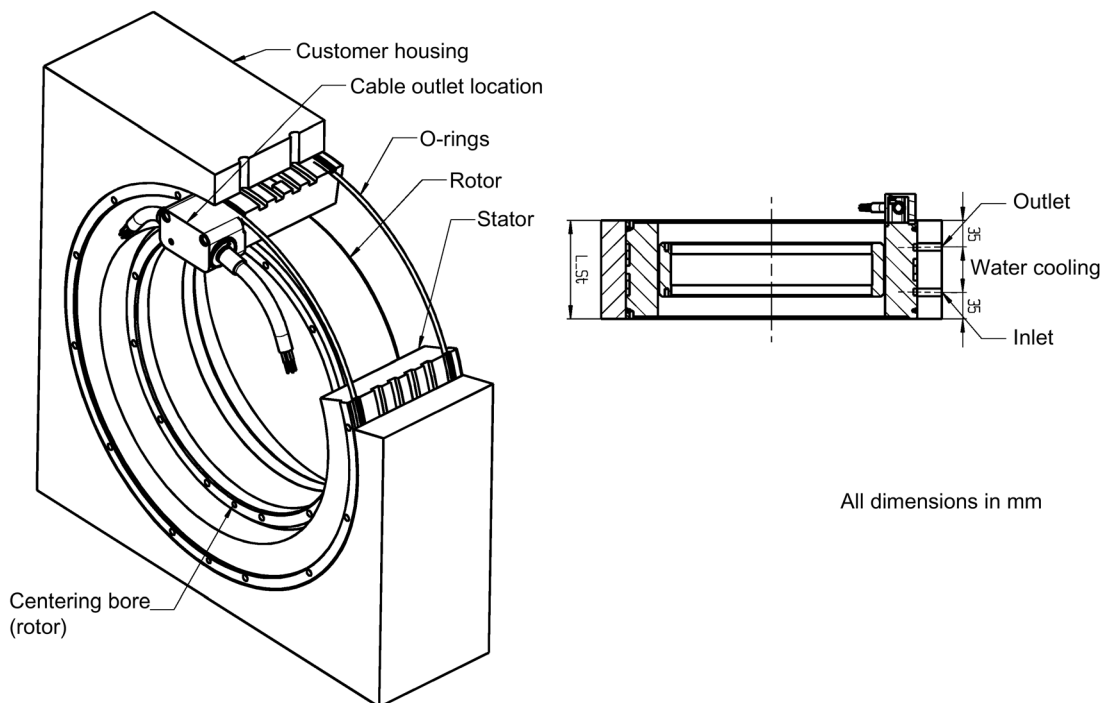

Figure 5-15 Cooler connection for 1FW615 (example)

5.4.7.2 Cooler connection for motors with integrated cooling

For built-in torque motors with integrated cooling, no alterations need to be made on the machine construction for connecting the cooler.

You can directly connect the cooler via the fittings (1/8" pipe thread, DIN 2999). 1FW605 and 1FW606 motors are connected to the cooling system using plug connections that can be simply released. For motors that are equipped with a precision and main cooler, each cooling circuit can be separately fed and controlled.

Suitable connectors are required for connecting the hoses.

Note

Keep the pressure loss for motors with precision and main cooler low

Keep the pressure losses low by applying the following measures:

- Using a cooling connection adapter, connect the precision and main coolers in parallel immediately before the cooler connections.
- Do not use excessively thin hoses directly after the cooling connection adapter.

The optional cooling connection adapter that can be ordered can be connected via a 1/4" pipe thread (DIN 2999) either axially or radially on the outside.

Note

Cooling principle

In a series connection, the coolant must flow through the precision cooler first and then the main cooler. Otherwise, the coolant already warmed up in the main cooler would enter the precision cooler and have a negative impact on the cooling effect.

Every cooler has an inlet and discharge. As far as cooling is concerned, it doesn't make any difference in which direction the coolant flows through the cooling circuit. Which connection is used as inlet and which as discharge can be freely selected.

NOTICE

Destruction of the motor

Most of the motors have a permanently mounted cooling connection plate. If you remove the cooling connection plate, the motor could be destroyed.

- | |
|---|
| <ul style="list-style-type: none">• Do not remove the cooling connection plate. |
|---|

Note

It is only permissible to remove the locking plate for the cooling connection for 1FW605 and 1FW606 motors for service purposes, and this must be done by a Siemens service center employee.

Cooling connection adapter (option)

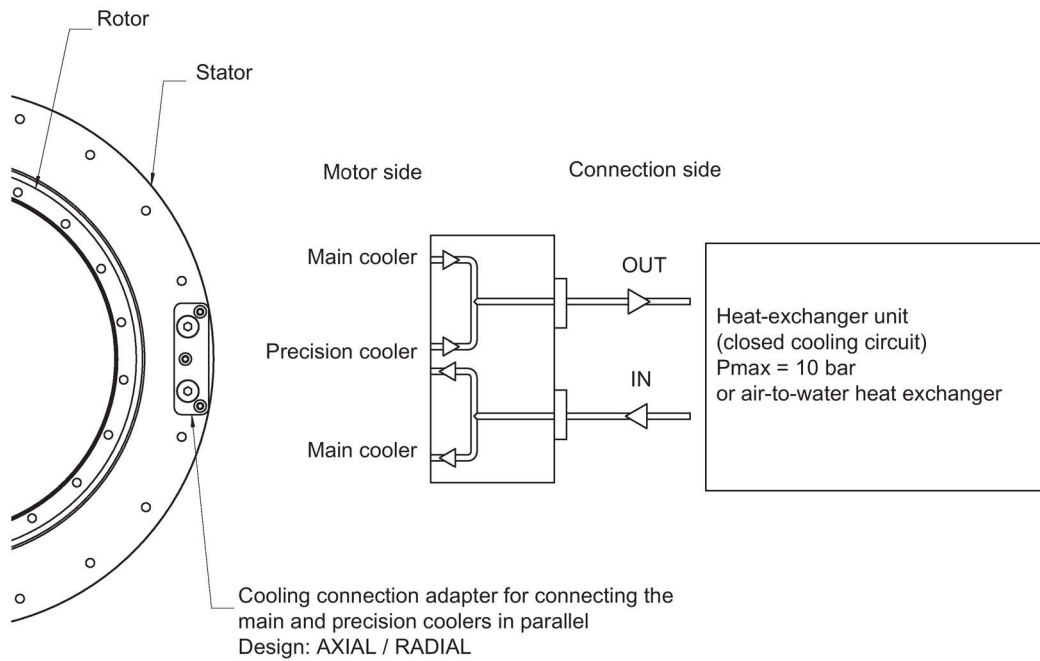

Figure 5-16 Cooling connection adapter (option) for parallel connection of main cooler and precision cooler for 1FW616, 1FW619, 1FW623, 1FW629

Cooler connection for 1FW605 and 1FW606

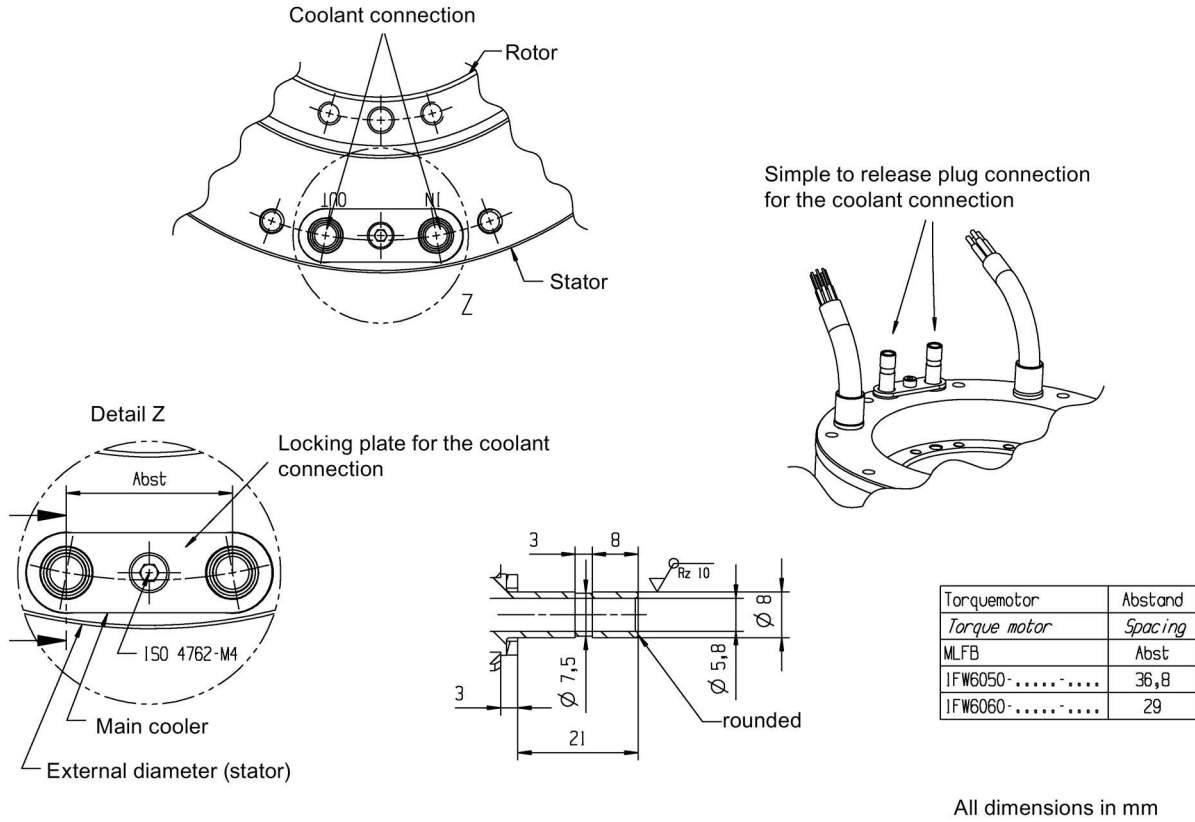

Figure 5-17 Axial cooler connection 1FW605 and 1FW606

Note

Manufacturer's recommendations for plug-in connections for the coolant connection are provided in the Appendix.

Cooler connection for 1FW616, 1FW619 and 1FW623

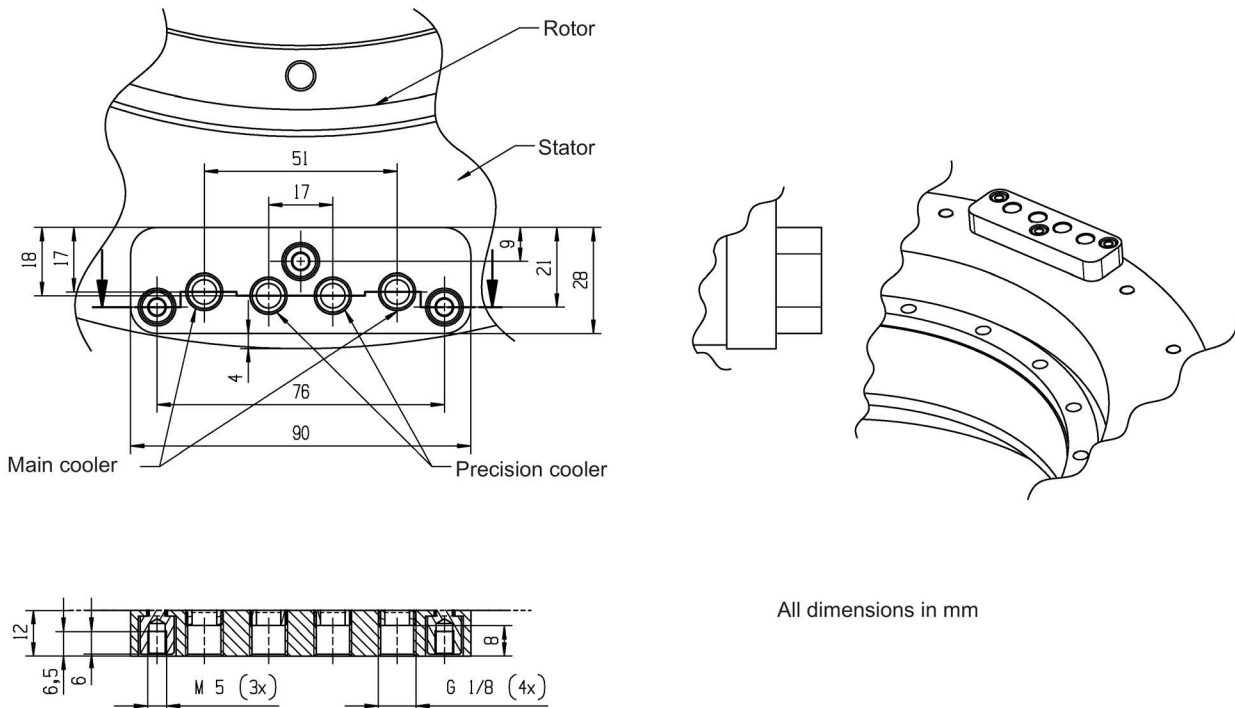

Figure 5-18 Cooling connection plate for 1FW616, 1FW619, 1FW623

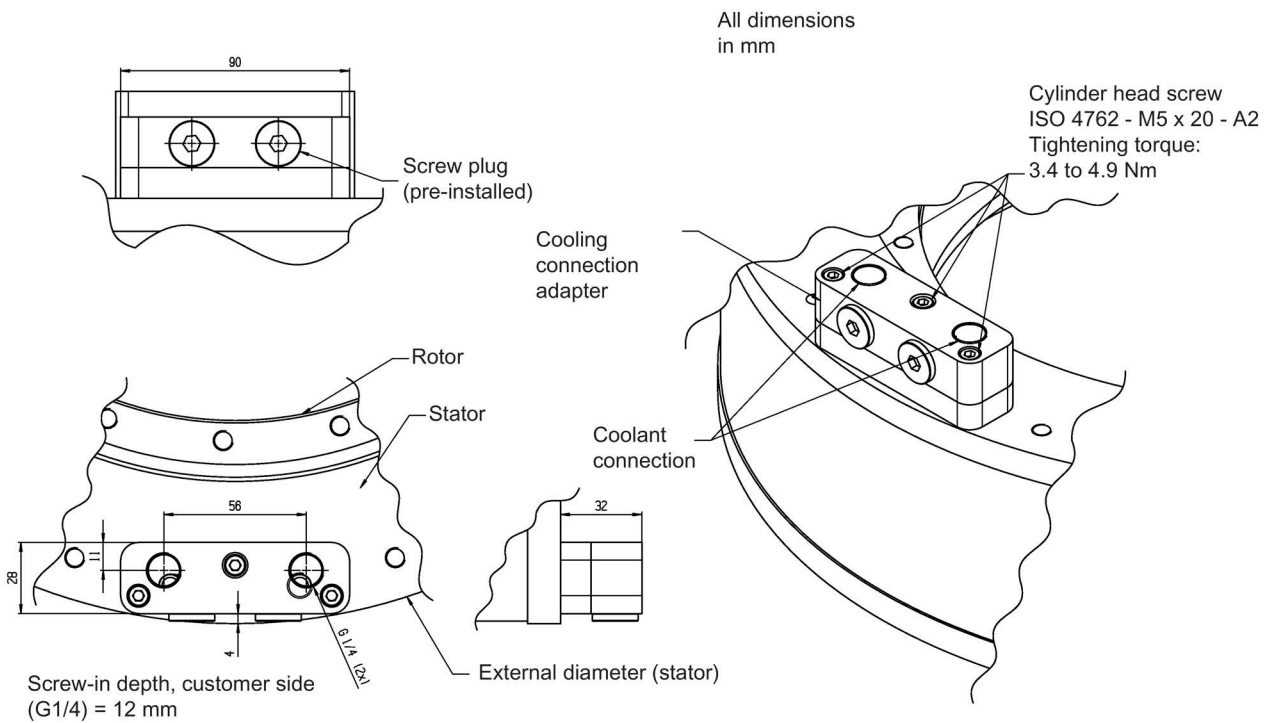

Figure 5-19 Axial cooler connection with cooling connection adapter (option) for 1FW616, 1FW619, 1FW623

All dimensions in mm

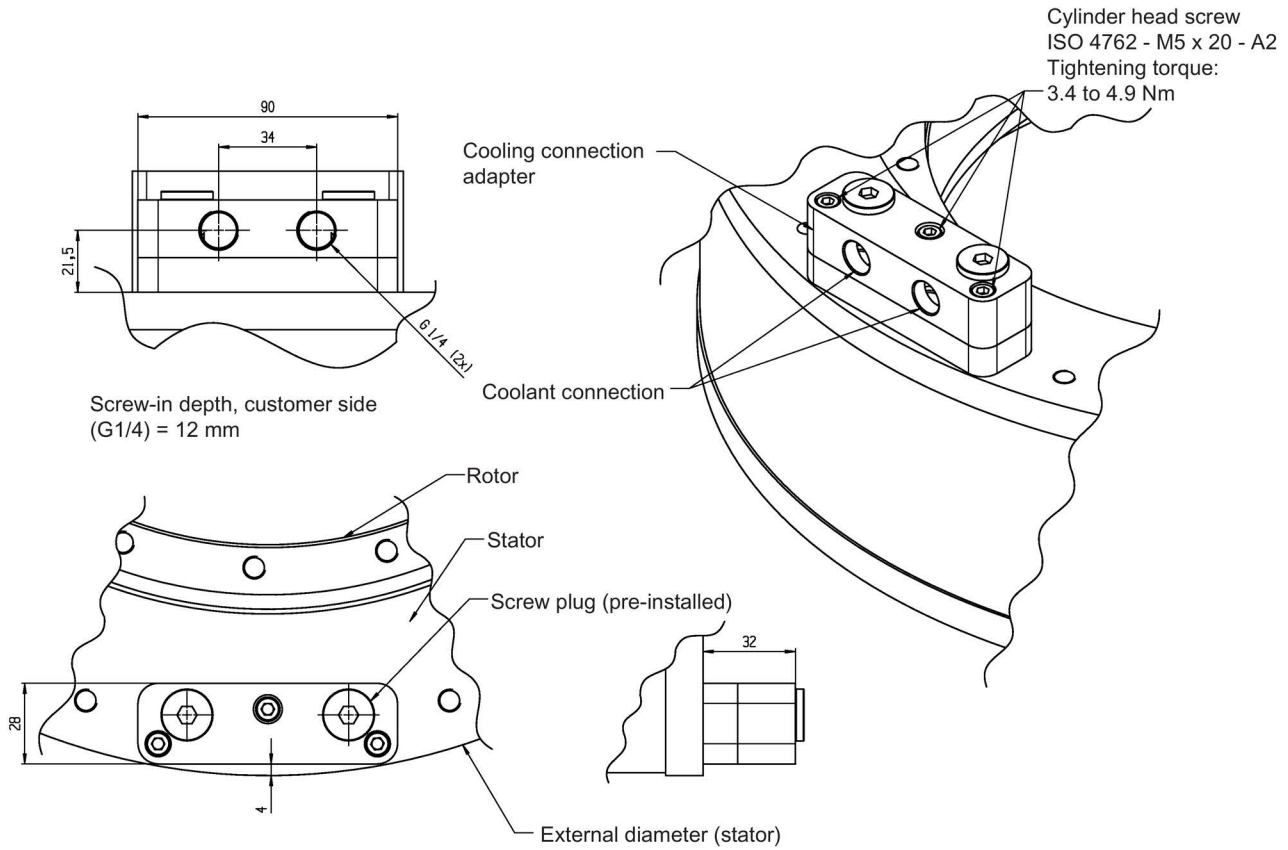
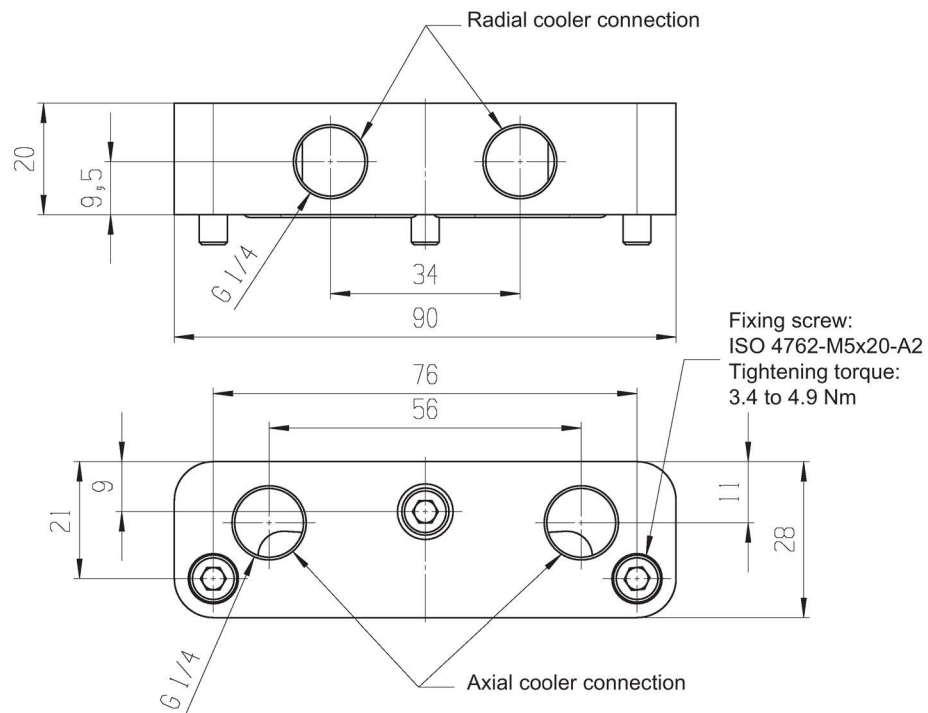

Figure 5-20 Outer radial cooler connection with cooling connection adapter (option) for 1FW616, 1FW619, 1FW623



It is up to the customer to decide whether he requires a radial or axial cooler connection; O-rings and locking/securing screws are included in the scope of supply!

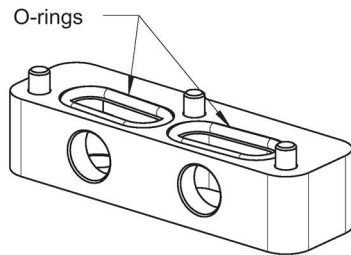

Figure 5-21 Cooling connection adapter (option) for 1FW616, 1FW619, 1FW623

Cooler connection for 1FW629

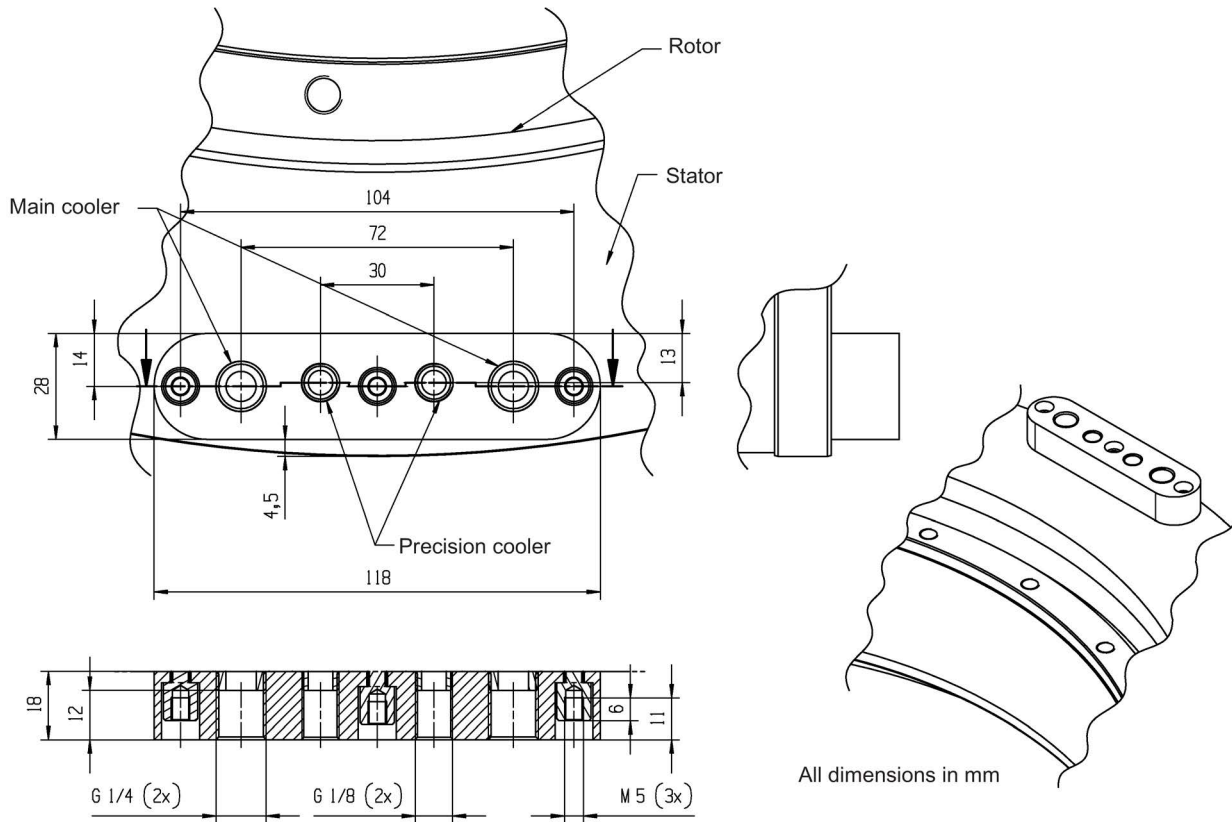

Figure 5-22 Cooling connection plate for 1FW629

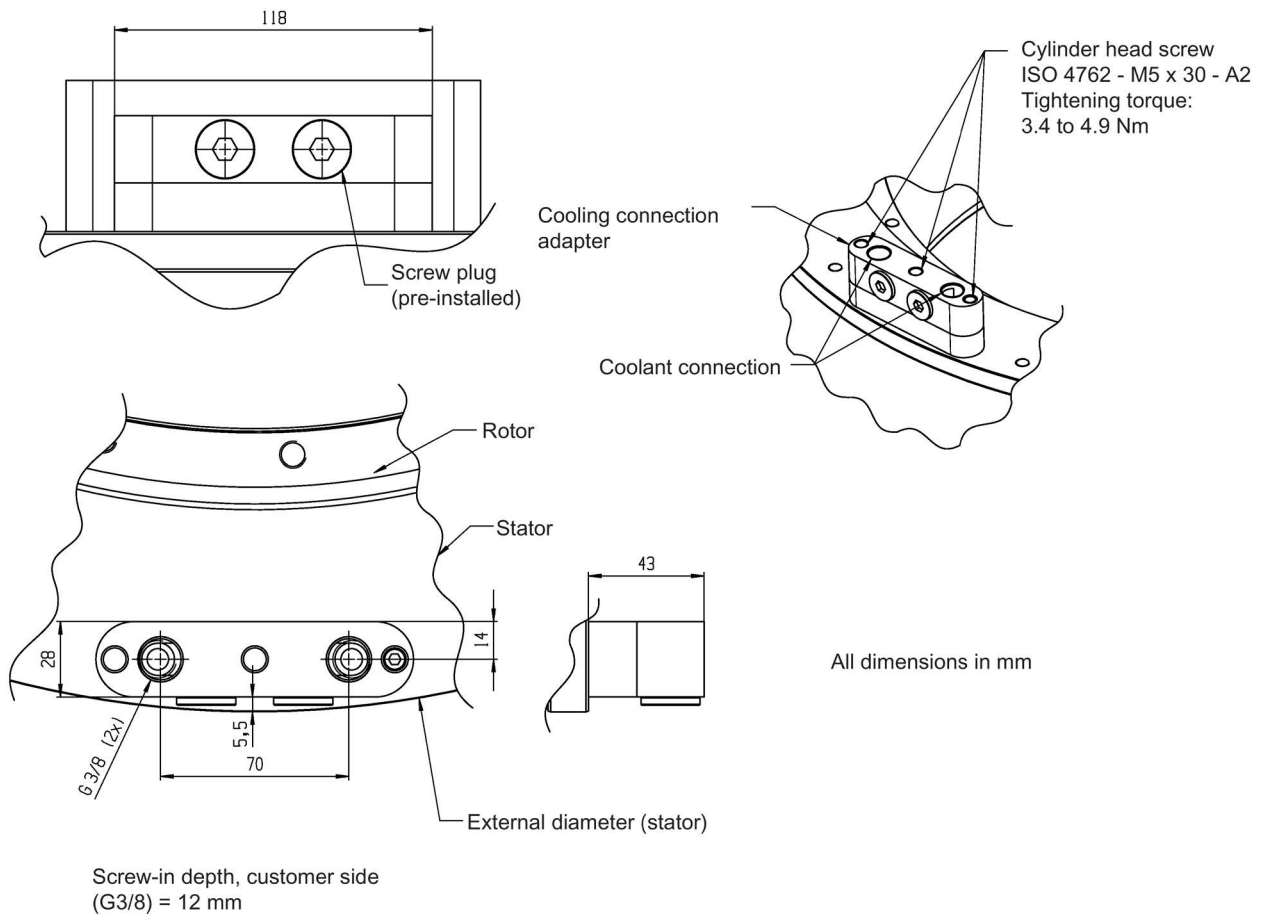

Figure 5-23 Axial cooler connection with cooling connection adapter (option) for 1FW629

5.4 Installation

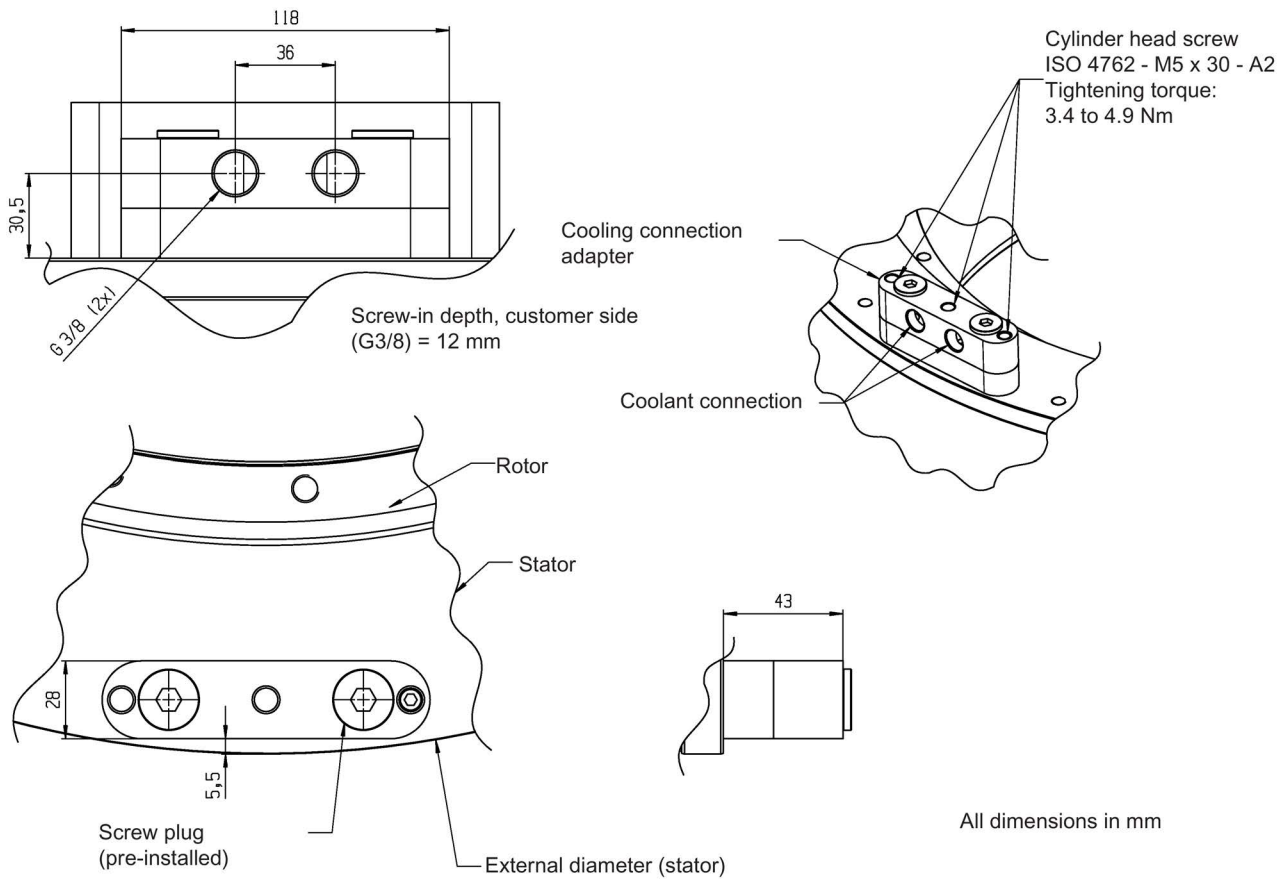
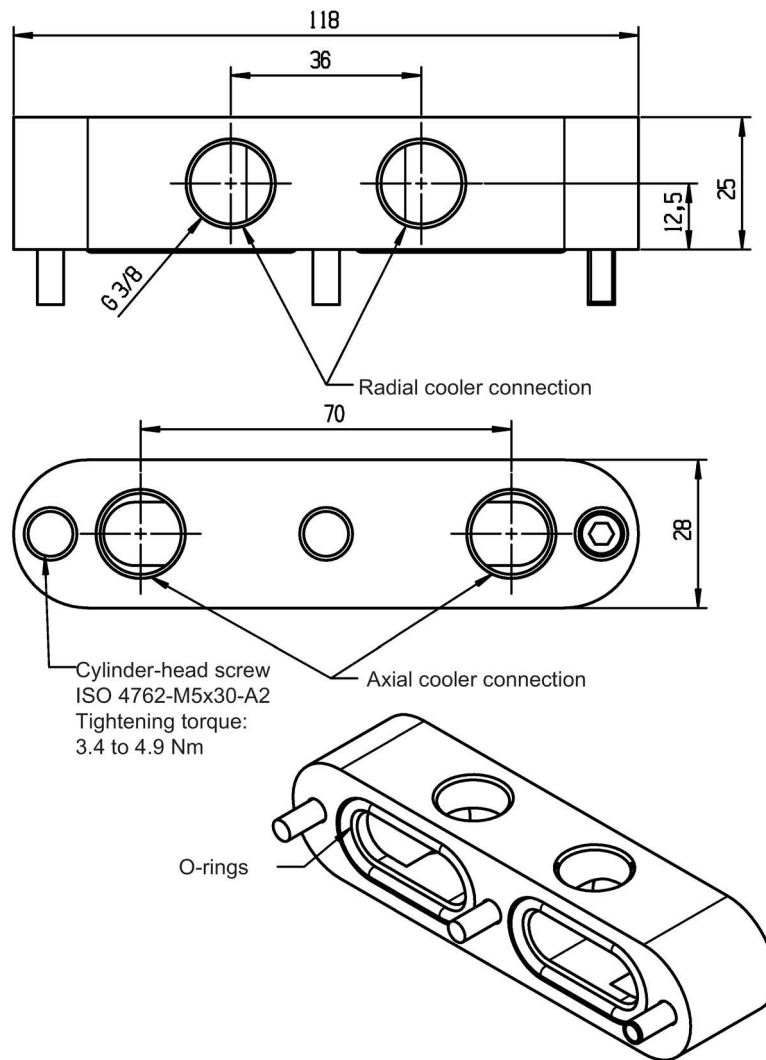

Figure 5-24 Outer radial cooler connection with cooling connection adapter (option) for 1FW629



It is up to the customer to decide whether he requires a radial or axial cooler connection; O-rings and locking/securing screws are included in the scope of supply!

Figure 5-25 Cooling connection adapter (option) for 1FW629

5.4.7.3 Hoses for the cooling system

The hoses for the cooling system must be highly resistant to the coolant, flexible, and abrasion proof. The hoses for the cooling system should not be chosen until all the materials used in the cooling system and the applicable boundary conditions are known.

When using a cooling connection adapter with motors featuring integrated cooling, overly thin hoses should not be used directly following the cooling connection adapter in order to prevent pressure drops.

For a list of companies from whom you can obtain connectors and accessories for cooling systems, see the appendix.

Note

We cannot guarantee the composition, nature, state, or quality of non-Siemens products. Read the detailed text in "Manufacturer recommendations" in the appendix.

5.4.7.4 Cooling connection adapter

Mounting the cooler connection adapter for motors with integrated cooling

The components required for connecting the cooler for motors with integrated cooling can usually be mounted with standard tools. The cooling connection adapter is not mounted for motors which are not equipped with a precision cooler.

The cooling connection adapter is mounted using three cylinder-head screws. The cooling ducts are sealed by means of O-rings (see the following diagrams). The cylinderhead screws and O-rings are supplied with the cooling connection adapter.

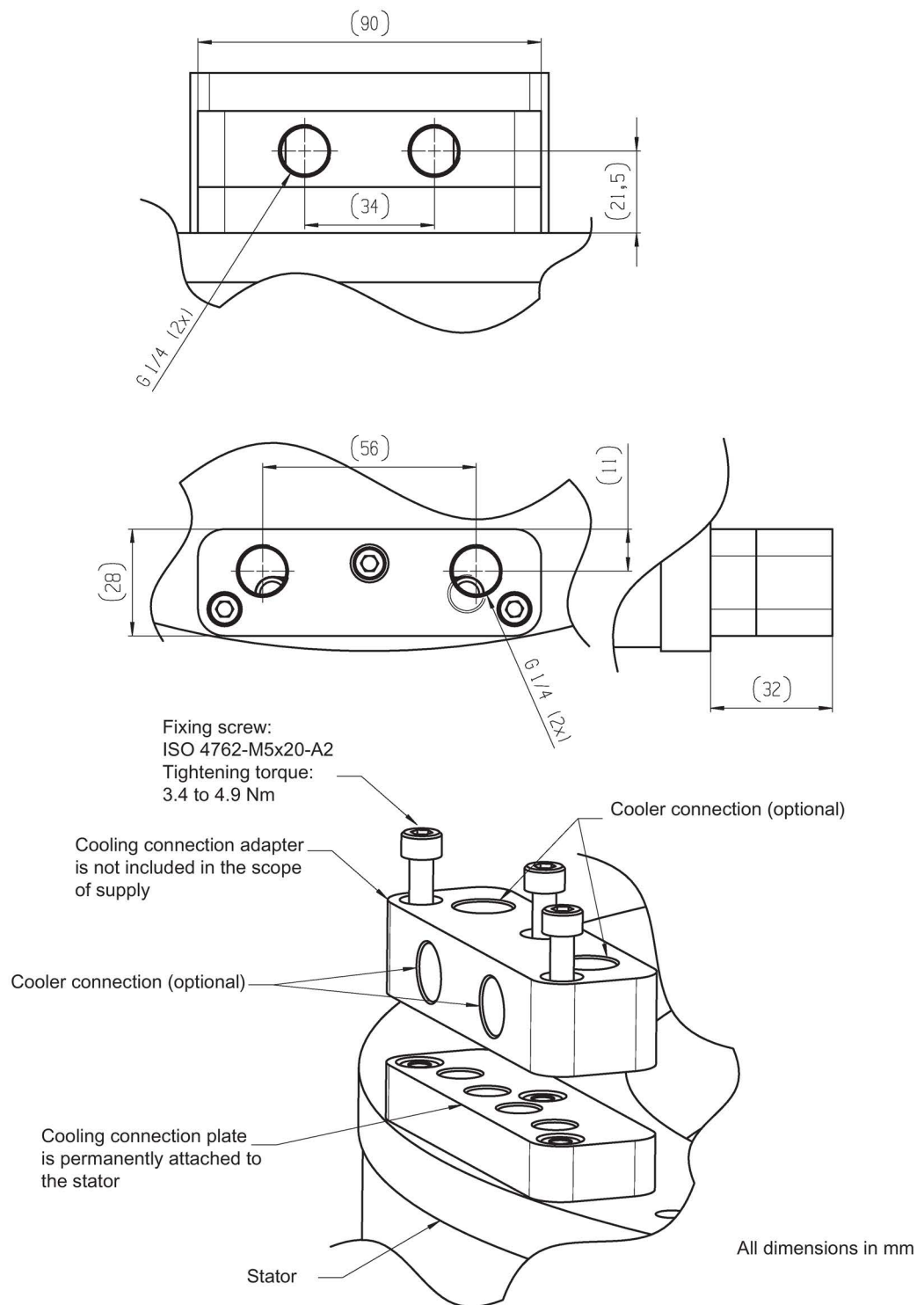

Figure 5-26 Mounting the cooling connection adapter 1FW616, 1FW619, 1FW623

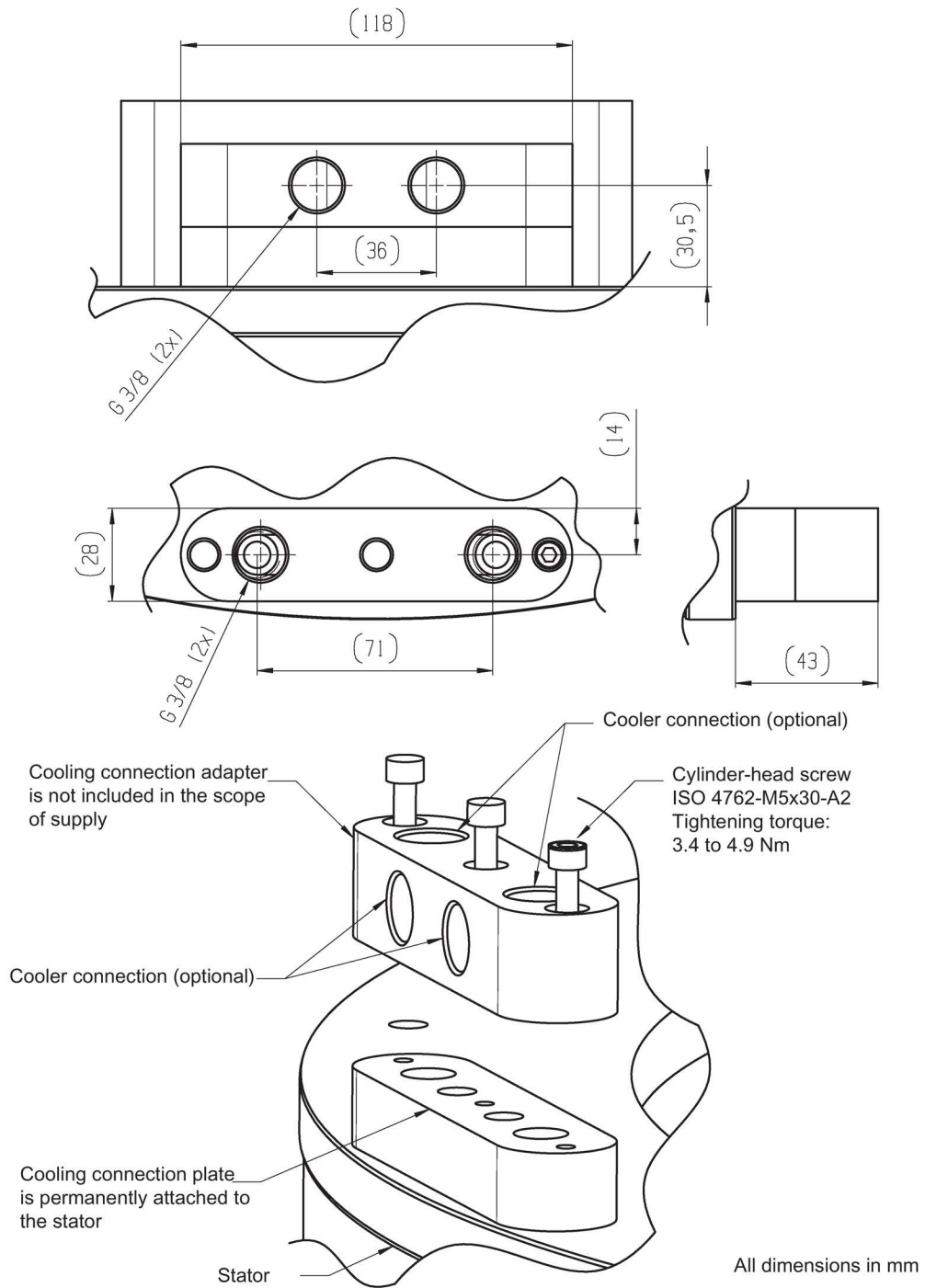

Figure 5-27 Mounting the cooling connection adapter 1FW629

5.4.8 Checking the work performed

Checking the mounting work

After installation has been completed, check that the rotor can freely rotate. Before moving the rotor, remove all tools and objects from the area of the rotor and air gap.



⚠ WARNING
Risk of electric shock
A voltage is induced in the stator when the rotor rotates. You can get an electric shock when touching the terminals, the open cable ends or the plug connector contacts.
<ul style="list-style-type: none">• Correctly connect the motor power cables. Alternatively: Insulate the plug connector contacts or terminals and conductors of open cable ends before you rotate the rotor.

- The mounted rotary axes must always be able to move without hindrance. Examples of axes that cannot necessarily be checked by hand:
 - Large axes with a high friction torque
 - Blocking in a current-free state
 - Uneven weight forces

⚠ WARNING
Danger if an axis moves in an uncontrolled manner.
There is a risk that the axis moves in an uncontrolled fashion if you release the locking or brake when the axis is de-energized and not subject to closed-loop control.
<ul style="list-style-type: none">• Carefully ensure that nobody is in the hazard zone.

- All cables must be routed and secured in such a way that they cannot be bent, pressed against rotating parts or damaged in any other way.
- Coolant supply ducts must be easily accessible and the coolant must be allowed to flow freely.

5.4.9 Installation examples

Note

The examples provided below are not necessarily complete nor are they suitable for all applications.

Note that the rotor and stator are secured on one side on the machine construction. Depending on the machine construction, the stator can be secured on the same side as the rotor or on the opposite side.

Table 5- 8 Explanations of the following diagrams with examples showing the principle of installation

Image title	Description
Rotary table with torque motor with integrated cooling	The construction shown is ideal for precision applications and tilting tables with strong machining forces. The phase-angle encoder is integrated in the bearing.
Rotary table with torque motor with cooling jacket	The construction shown is ideal for precision applications, dividing units, applications with holding operation, and tilting tables with an integrated brake. It is compact and, therefore, easy to integrate.
Part-turn actuator with torque motor with integrated cooling	The construction shown is ideal for robots, robot systems, and tool changers. The phase-angle encoder is sufficiently decoupled from the heat source (motor winding).
Installing a torque motor with integrated cooling on the shaft extension of a part-turn actuator	<p>1.: In the delivery condition, the transport locks on the stator and rotor are attached at both flange surfaces. A spacer film is located between the stator and rotor.</p> <p>2.: The transport locks are removed on the mounting side. Opposite transport locks are released.</p> <p>3.: The rotor is bolted to the shaft extension with its mount. Here, the specified torques and specifications regarding the mounting system should be carefully observed. The stator is located and bolted in its mount. Carefully observe the specified torques and specifications regarding the mounting system. Only after this has been done, have the transport locks and distance film been removed.</p>

Image title	Description
Part-turn actuator with torque motor with cooling jacket	The construction shown is ideal for moderate load forces and medium precision requirements (e.g. woodworking, packaging systems, tool changers). For roller drives, this construction is only suitable for short axes with low deflection.
Roller drive with low shaft deflection with torque motor with integrated cooling	The construction shown is ideal for roller drives with high concentricity requirements and low positioning accuracy. A rotary encoder with a moderate angular resolution is sufficient here. The encoder must be decoupled from the thermal expansion of the shaft by means of a suitable interface.

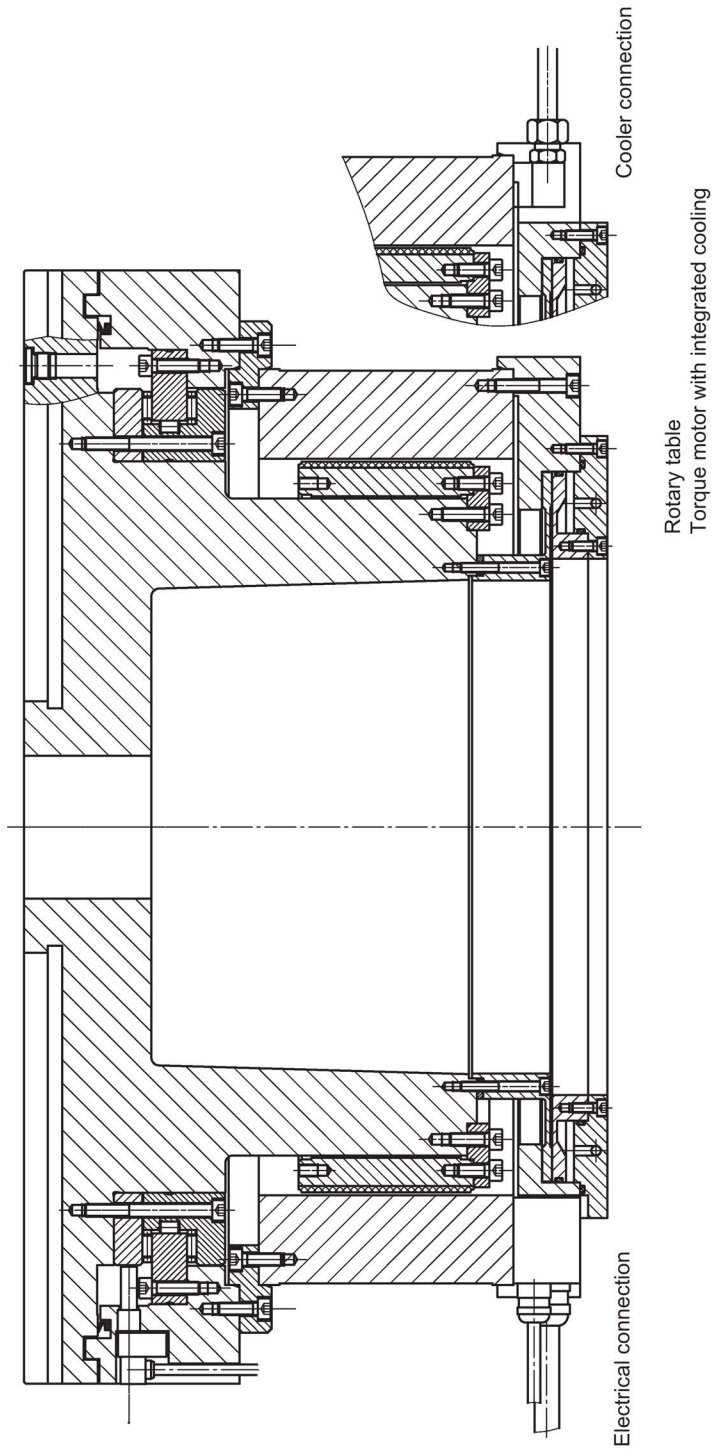

Figure 5-28 Rotary table with torque motor with integrated cooling

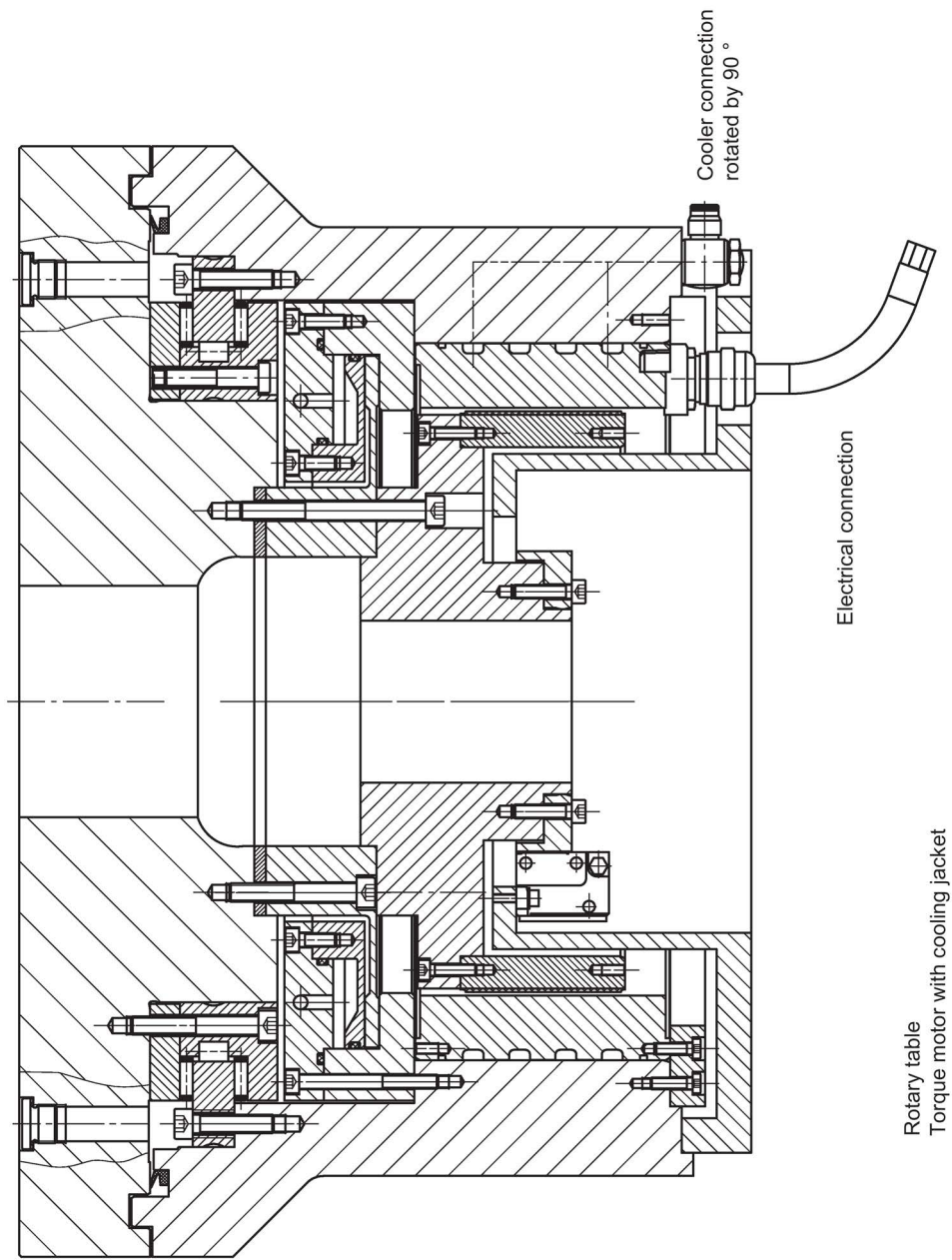

Figure 5-29 Rotary table with torque motor with cooling jacket

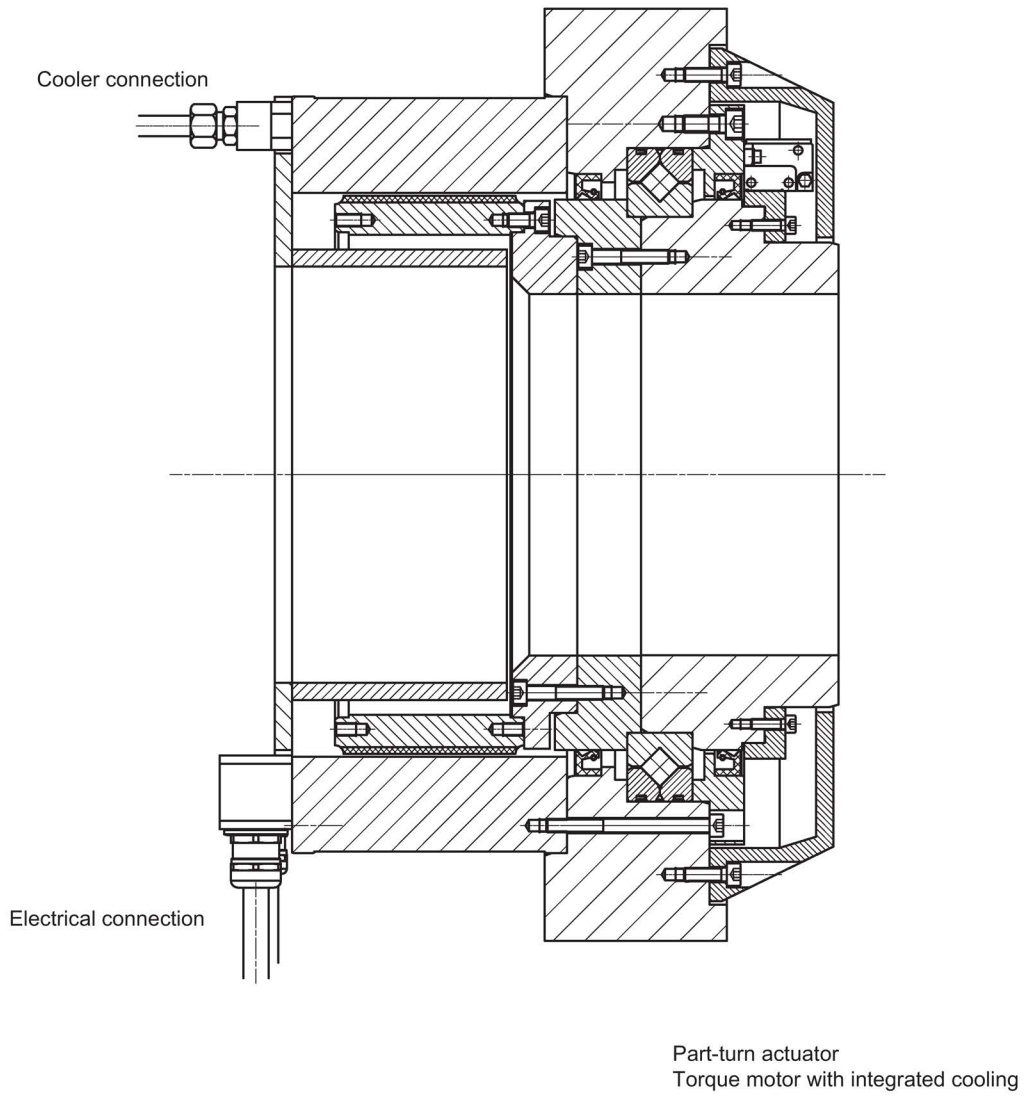

Figure 5-30 Part-turn actuator with torque motor with integrated cooling

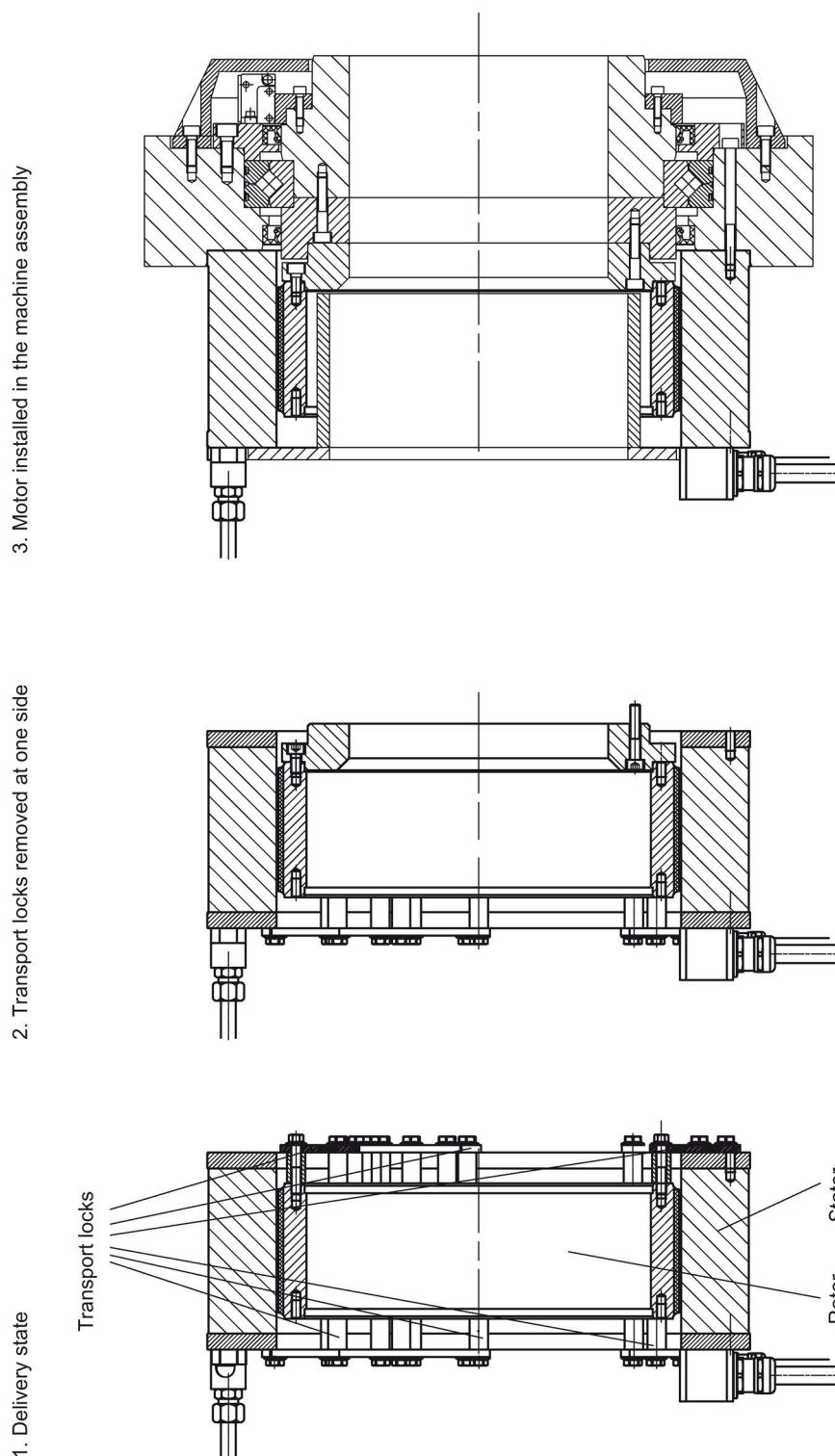

Figure 5-31 Installing a torque motor with integrated cooling on the shaft extension of a part-turn actuator

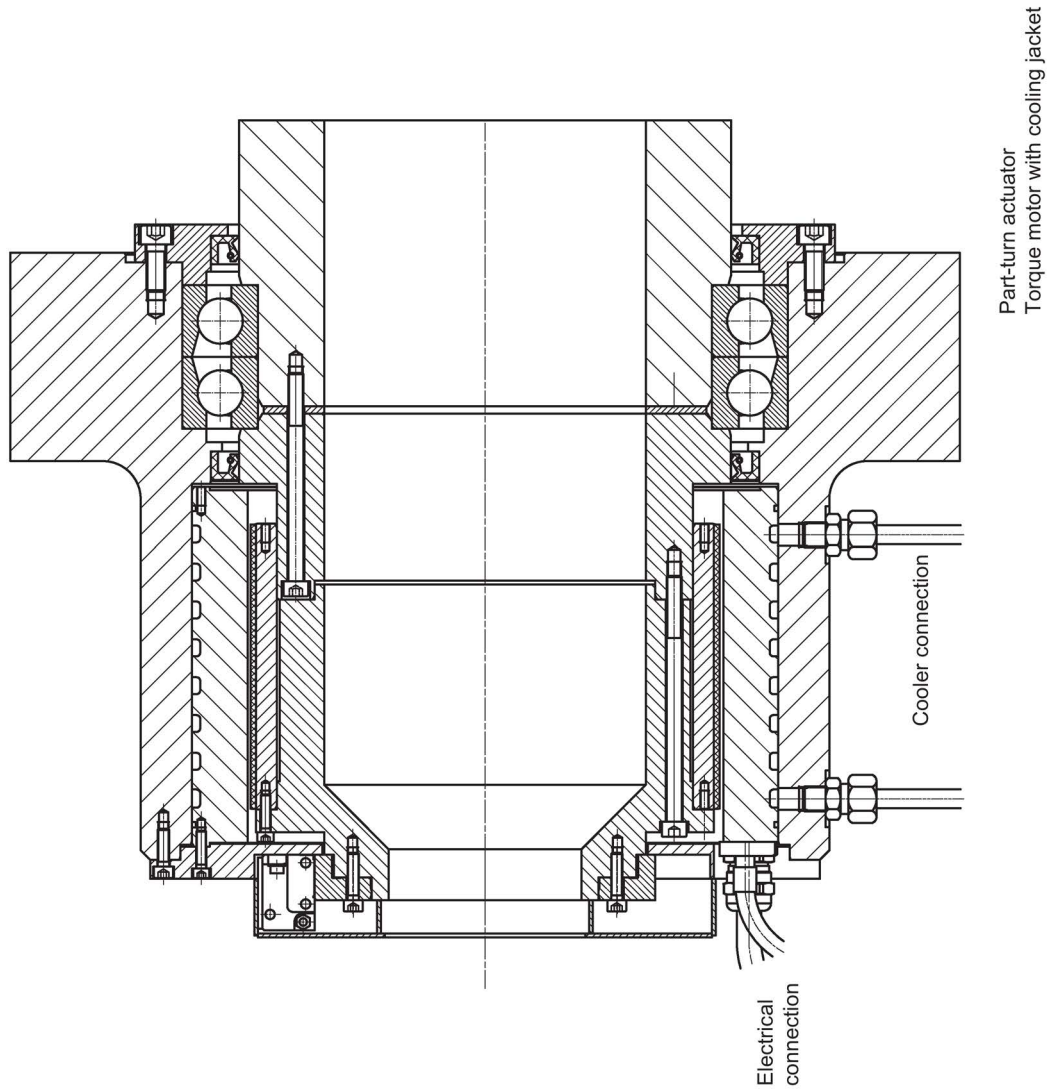

Figure 5-32 Part-turn actuator with torque motor with cooling jacket

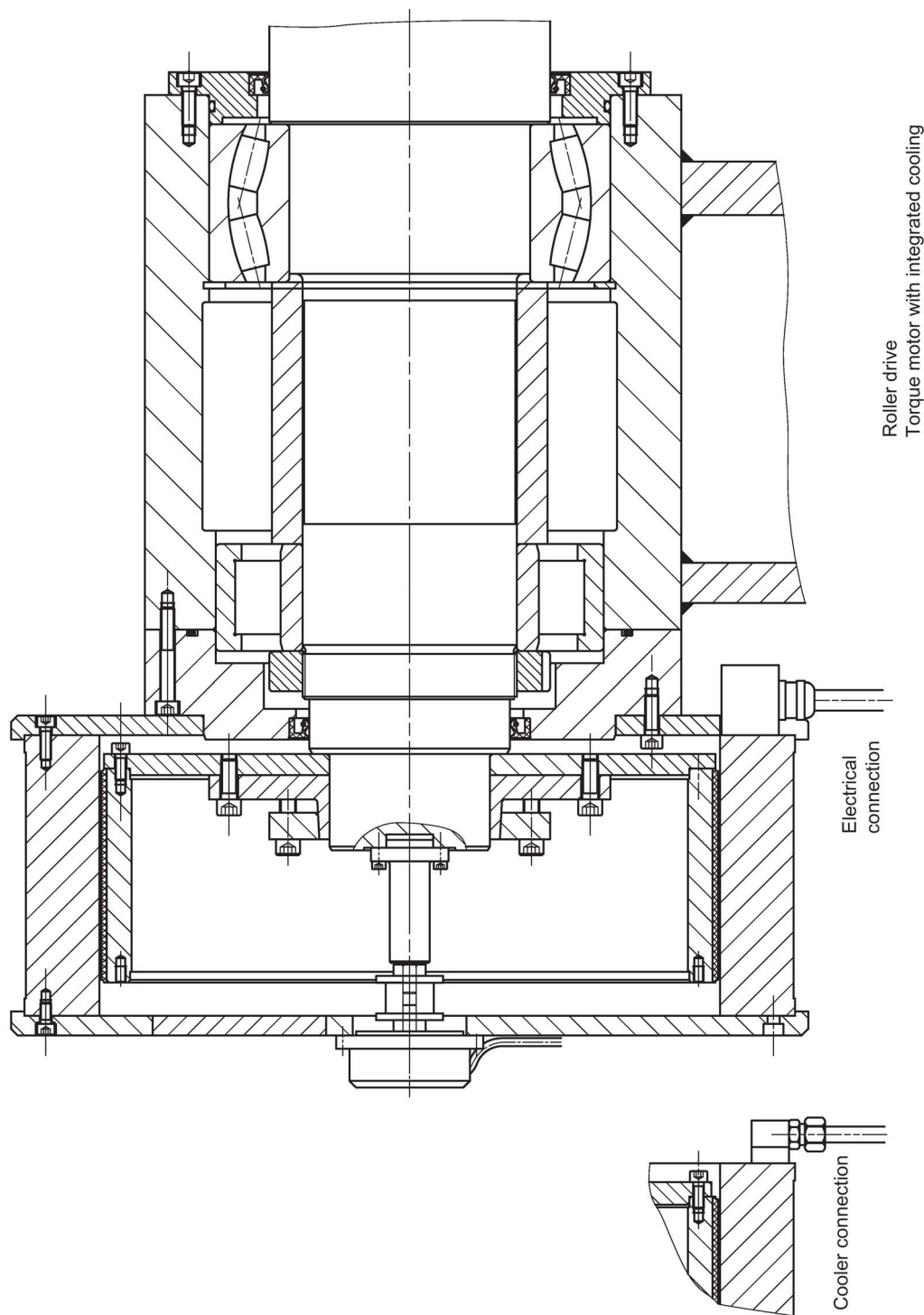

Figure 5-33 Roller drive with low shaft deflection with torque motor with integrated cooling

Technical data and characteristics

The technical data and characteristics for the 1FW6 Built-in torque motors are specified in this Chapter. This data collection provides the motor data required for configuration and contains a number of additional data for more detailed calculations for detailed analyses and problem analyses. Technical data subject to change.

Note

System-specific data refer to the combination of built-in torque motors 1FW6 with SINAMICS S120 drive systems.

Unless otherwise specified, the following boundary conditions apply here:

- The DC link voltage U_{DC} is 600 V, the converter output voltage $U_{a\ max}$ is 425 V
 - The motor is water-cooled with the recommended minimum flow rate according to the data sheet and a water intake temperature T_{VORL} of 35 °C
 - The rated temperature of the motor winding T_N is 130 °C
 - Voltages and currents are specified as rms values
 - Installation altitude of the motors up to 2000 m above sea level
 - For motors with integrated cooling that are equipped with main and precision coolers, the power/performance data has been determined with the use of a cooling connection adapter
-

6.1 Explanations of the formula abbreviations

Content of the data sheet

The data specified on the data sheets is explained in the following section. It is categorized as follows:

- Boundary conditions
- Data at the rated operating point
- Limit data
- Physical constants
- Data for the motor cooler

Boundary conditions

U_{DC}	Converter DC link voltage (direct voltage value). Comment: For converter output voltages $U_{a\ max}$, see Chapter "System integration".
T_{VORL}	Maximum intake temperature of the water cooler for the main cooler and precision cooler if the motor is to be utilized up to its rated torque M_N . For details of the dependency of the continuous motor current on intake temperature of the water cooler, see the characteristic curve in "Cooling".
T_N	Rated temperature of the motor winding.

Rated data

M_N	Rated torque of the motor.
I_N	Rated motor current at the rated torque M_N .
n_N	Rated speed where the motor provides rated torque M_N .
$P_{V,N}$	Motor power loss at the rated operating point (M_N, n_N) at the rated temperature T_N .

Limit data

M_{MAX}	Maximum motor torque.
I_{MAX}	Maximum motor current at the maximum torque M_{MAX} . Maximum possible load duration: see "Short-time duty S2".
$P_{EL,MAX}$	Electric power drawn by the motor at the ($M_{MAX}, n_{MAX,MMAX}$) point at rated temperature T_N .

Note

The sum of the mechanical power P_{mech} output and power loss P_V yields the electric power drawn by the motor P_{EL} .

Also refer to "Calculating the required infeed power."

The rated electric power drawn by the motor **at the rated operating point** with $M = M_N$ and $n = n_N$ can be calculated as follows:

$$P_{EL,N} = P_{mech,N} + P_{V,N} = 2\pi \cdot M_N \cdot n_N + 3 \cdot R_{130} \cdot I_0^2 + P_{LV,N}$$

The stator iron losses are taken into account because instead of I_N , the higher current I_0 is used for the calculation. You can read off the rotor power loss $P_{LV,N}$ from the "Rotor losses with respect to speed" characteristic.

Insert the appropriate data from the Chapter "Data sheets and diagrams" into the following formula. Conversion of the speed n from rpm to s^{-1} and the power from W to kW has already been taken into account.

$$\frac{P_{EL,N}}{kW} = 10^{-3} \cdot \left[2\pi \cdot \frac{M_N}{Nm} \cdot \frac{n_N}{60 s^{-1}} + 3 \cdot \frac{R_{130}}{\Omega} \cdot \frac{I_0^2}{A^2} \right] + \frac{P_{LV,N}}{kW}$$

n_{MAX}	Maximum permissible operating speed.
n_{MAX,MMAX}	Maximum speed at which the motor can supply the maximum torque M_{MAX} .
n_{MAX,INV}	Maximum speed, where a Voltage Protection Module VPM is not required.
n_{MAX,0}	No-load speed; max. speed without load.
M₀	Torque for speed $n = 1$ rpm at which the load and power loss are still evenly distributed across all three motor phases.
I₀	Current (rms value) of the motor at torque M_0 and speed $n = 1$ rpm.
M₀*	Thermal static torque when the current is unevenly distributed across the three motor lines. An uneven current load occurs in the following operating modes: <ul style="list-style-type: none"> • Standstill • Operation with short cyclic rotations (< 1 pole pitch) • for $n \ll 1$ rpm <p>Since the saturation effect can be disregarded for the rated current, the following applies (approximately):</p> $M_0^* \approx 1/\sqrt{2} \cdot M_0$
I₀*	Thermal stall current (rms value) of the motor at M_0^* . The following applies: $I_0^* \approx 1/\sqrt{2} \cdot I_0$

Physical constants

k_{T,20}	Motor torque constants at a rotor temperature of 20 °C (refers to the lower linear range of the torque–current characteristic).
k_E	Voltage constants for calculating the mutually induced line-to-line voltage.
k_{M,20}	Motor constant for a winding temperature of $T = 20$ °C. The motor constant $k_M(T)$ can be calculated for other temperatures: $k_M(T) = k_{M,20} \cdot [1 + \alpha(T - 20 \text{ °C})]$ using the temperature coefficients $\alpha = -0.001$ 1/K for magnets $k_M(T) = k_{M,20} \cdot [1 - 0.001 \cdot (T - 20 \text{ °C})]$
t_{TH}	Thermal time constant of the motor winding. This is derived from the temperature characteristic in the winding with a sudden load and constant current. See diagram below. After time t_{TH} has elapsed, the motor winding reaches approx. 63 % of its final temperature T_{GRENZ} , if the thermal protection does not respond beforehand.

6.1 Explanations of the formula abbreviations

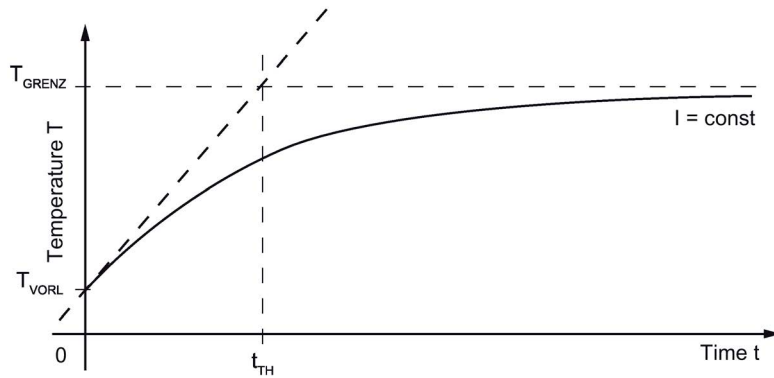

Figure 6-1 Thermal time constant

p Number of pole pairs of the motor.

M_{COG} Cogging torque. This is the torque generated by the interaction between the laminated core and permanent magnets at the air gap in stators that have been disconnected from the power supply.

The cogging torque can be calculated as follows:

$$M_{COG} = \sqrt{a_1^2 + a_2^2 + a_3^2 + a_4^2 + \dots + a_n^2}$$

Here, a₁ to a_n are the amplitudes of the torque harmonics.

m_s Mass of the stator without fixing screws, connectors, connection cables, and coolant.

m_L Mass of the rotor without fixing screws.

J_L Rotor moment of inertia

R_{STR,20} Phase resistance of the winding at a winding temperature of 20 °C.

The value of the phase resistance is required for calculating the power loss, among other things. R₂₀ can be converted for other phase resistances as follows:

$$R_{STR}(T) = R_{STR,20} \cdot [1 + \alpha(T - 20^\circ\text{C})]$$

with the temperature coefficients $\alpha = 0.00393 \cdot 1/\text{K}$ for copper.

The following applies for R_{STR,130}: R_{STR,130} = R_{STR,20} • 1.4323.

L_{STR} Phase inductance of the stator winding with integrated fan.

Data for main motor cooler

- $Q_{H,MAX}$ Maximum thermal power that is dissipated by the main cooler when the motor is utilized up to the rated torque M_N and at the rated temperature T_N .
- $\dot{V}_{H,MIN}$ Recommended minimum volume flow rate in the main cooler to achieve the rated torque M_N .
- ΔT_H The temperature increase of the cooling medium between the inlet and return flow circuit of the main cooler at the operating point $Q_{H,MAX}$ and $\dot{V}_{H,MIN}$ can be estimated with the following formula:

$$\Delta T_H = \frac{Q_{H,MAX}}{\rho \cdot c_p \cdot \dot{V}_{H,MIN}}$$

average density of water: $\rho = 1000 \text{ kg/m}^3$

average specific thermal capacity of water: $c_p = 4.18 \cdot 10^3 \text{ J/(kg K)}$

Temperature change with respect to the intake temperature: ΔT_H in K

volume flow rate: in m^3/s

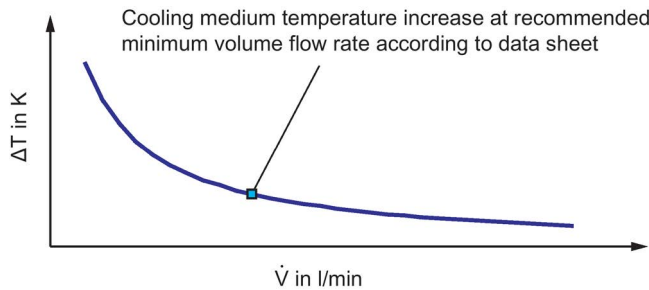

Figure 6-2 Sample characteristic "Temperature increase of the coolant between the inlet and return flow circuit of the main cooler"

- Δp_H Coolant pressure drop between the inlet and return flow circuit of the main cooler with volume flow $\dot{V}_{H,MIN}$.
The main and precision coolers for motors with integrated cooling are connected in parallel. The volume flow rates of the main and precision cooler are added to create a total volume flow rate; the pressure drop in the main cooler Δp_H corresponds to the pressure drop in the precision cooler Δp_P .

6.1 Explanations of the formula abbreviations

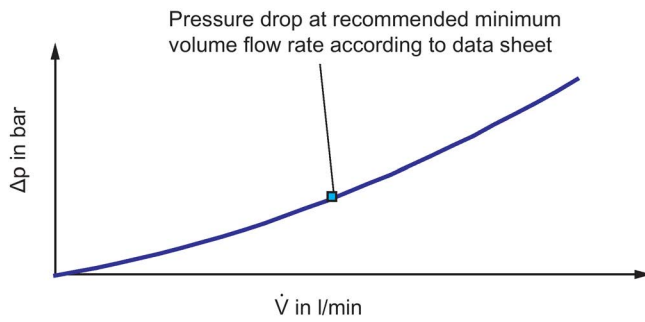

Figure 6-3 Sample characteristic: "Pressure losses in the main cooler over volume flow rate"

Data for precision motor cooler

- $Q_{P,MAX}$ Maximum heat loss dissipated by the precision cooler when the motor is utilized up to its rated torque M_N and at rated temperature T_N .
- $\dot{V}_{P,MIN}$ Recommended minimum volume flow rate in the precision cooler to achieve a minimum temperature increase on the mounting surface of the stator with respect to T_{VORL} .
- ΔT_P The temperature increase of the cooling medium between the inlet and return flow circuit of the precision cooler at the operating point $Q_{P,MAX}$ and $\dot{V}_{P,MIN}$ can be estimated with the following formula:

$$\Delta T_P = \frac{Q_{P,MAX}}{\rho \cdot c_p \cdot \dot{V}_{P,MIN}}$$

average density of water: $\rho = 1000 \text{ kg/m}^3$
 average specific thermal capacity of water: $c_p = 4.18 \cdot 10^3 \text{ J/(kg K)}$
 Temperature change with respect to the intake temperature: ΔT_P in K
 volume flow rate: in m^3/s

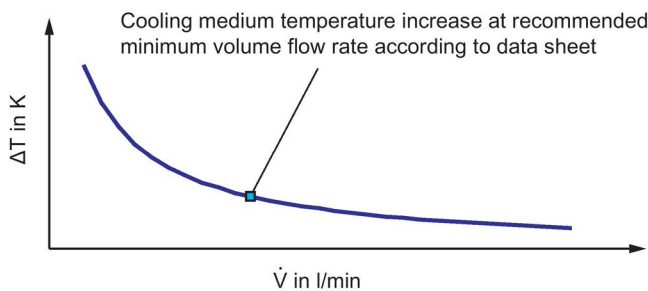
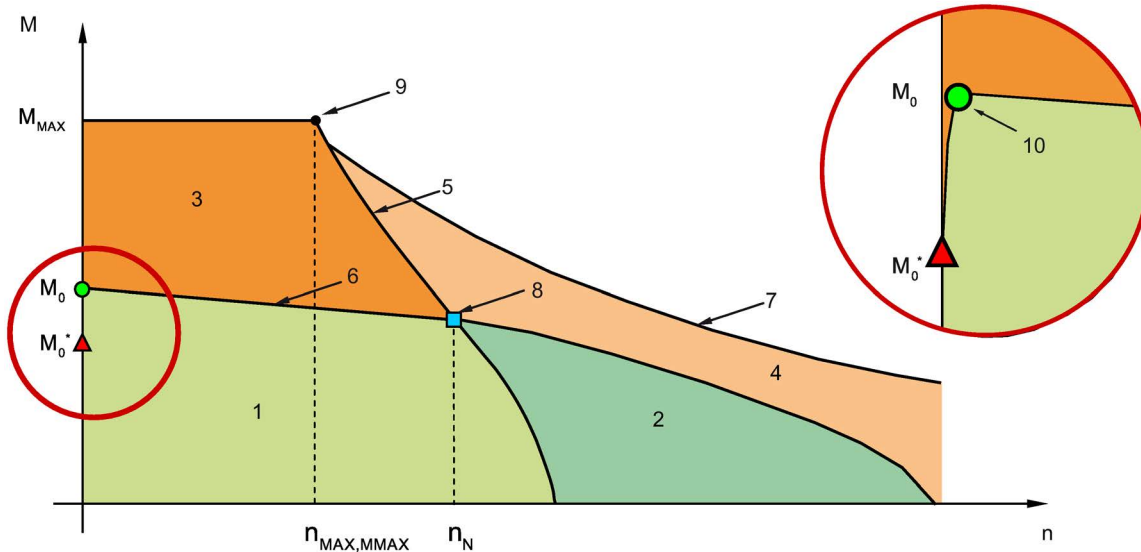

Figure 6-4 Sample characteristic "Temperature increase of the coolant between the inlet and return flow circuit of the precision cooler"

Torque-speed diagram with field weakening



- 1 S1 duty
- 2 S1 duty with field weakening
- 3 S3 duty, cycle duration should not exceed 10 % of the thermal time constant t_{TH}
- 4 S3 duty with field weakening, cycle duration should not exceed 10 % of the thermal time constant t_{TH}
- 5 Voltage limit characteristic
- 6 Limit characteristic for S1 duty
- 7 Voltage limit characteristic with field weakening
- 8 Rated operating point at M_N, n_N, I_N
- 9 Operating point at $M_{MAX}, I_{MAX}, n_{MAX,MMAX}$
- 10 Torque M_0 at speed $n = 1$ rpm

Figure 6-5 Schematic description of the torque-speed diagram

The voltage induced in the motor winding increases as the speed increases. The difference between the DC link voltage of the converter and the induced motor voltage can be used to impress the current.

The torque must be reduced if the voltage limit of the infeed module is reached at speed n .

All operating points that can be achieved with the motor lie below the "voltage limiting characteristic".

6.1 Explanations of the formula abbreviations

For the SINAMICS S120 drive system, as a result of the field weakening function, when the "voltage limiting characteristic" is reached, then the voltage induced in the motor winding is automatically compensated. As a consequence, the speed range of a motor can be extended without requiring a larger power module. The operating points for field weakening that can be reached when motoring, are located to the left or below the "voltage limiting characteristic with field weakening" and to the right of the "voltage limiting characteristic".

Note

Above a certain speed, a Voltage Protection Module VPM is required; refer to the Chapter "Configuring" and "Data sheets and diagrams" regarding this topic.

Please note that as the speed increases, the rotor power loss also increases. This means that additional measures must be taken to dissipate the rotor power loss.

The circle shown in the "Schematic description of the torque-speed diagram" diagram on the torque axis designates the area/range around M_0 and M_0^* . In the detail view it is shown zoomed in.

The motors described are multi-pin and have a sufficiently large thermal time constant. As a consequence, torque M_0 can be reached, even at very low speeds.

The torque-speed diagrams for the motors can be found in Chapter "Data sheets and diagrams."

Rotor power loss

For every frame size and active part length, the rotor power loss P_{LV} is specified as a set of characteristics "Rotor power loss with respect to speed" for the defined torque.

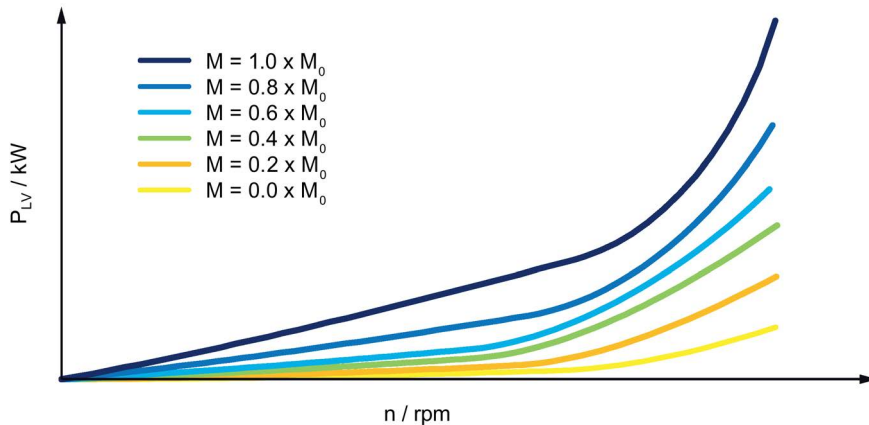

Figure 6-6 Rotor power loss speed diagram (example)

Short-circuit braking torque

For each frame size and active part length, the short-circuit braking torque M_{BR} is specified as characteristic "short-circuit braking torque with respect to speed".

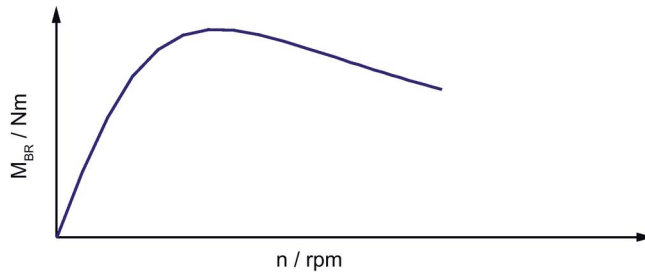





Figure 6-7 Short-circuit braking torque speed diagram (example)

6.2 Data sheets and diagrams

Table 6- 1 Color coding of the M-n characteristics in the diagrams

Color	Resulting DC link voltage U_{DC}	Converter output voltage (rms value) $U_{a\ max}$	Permissible line supply voltage (rms value)	SINAMICS S120 Line Module
	634 V	460 V	3 x AC 480 V	Smart Line Module, uncontrolled with regenerative feedback or Basic Line Module, uncontrolled without regenerative feedback
	600 V	425 V	3 x AC 400 V	Active Line Module, controlled with regenerative feedback
	528 V	380 V	3 x AC 400 V	Smart Line Module, uncontrolled with regenerative feedback or Basic Line Module, uncontrolled without regenerative feedback

6.2.1 1FW6050-xxxxx-xxxx

Data sheet 1FW6050-xxB03-xxxx

Table 6- 2 1FW6050-xxB03-0Fxx

Technical data	Symbol	Unit	-xxB03-0Fxx
1FW6050			
Boundary conditions			
DC link voltage	U_{DC}	V	600
Water cooling inlet temperature	T_{VORL}	°C	35
Rated temperature of winding	T_N	°C	130
Data at the rated operating point			
Rated torque	M_N	Nm	23.2
Rated current	I_N	A	4.87
Rated speed	n_N	rpm	940
Rated power loss	$P_{V,N}$	kW	0.769
Limit data			
Maximum torque	M_{MAX}	Nm	34.4
Maximum current	I_{MAX}	A	7.61
Electric motor power at M_{MAX}	$P_{EL,MAX}$	kW	4.23
Maximum speed	n_{MAX}	rpm	2820
Maximum speed at maximum torque	$n_{MAX,MMAX}$	rpm	697
Max. speed without VPM	$n_{MAX,INV}$	rpm	1970
No-load speed	$n_{MAX,0}$	rpm	1440
Torque at $n = 1$ rpm	M_0	Nm	24.2
Current at M_0 and $n = 1$ rpm	I_0	A	5.09
Thermal static torque	M_0^*	Nm	17.4
Thermal stall current	I_0^*	A	3.6
Physical constants			
Torque constant at 20 °C	$k_{T,20}$	Nm/A	4.87
Voltage constant	k_E	V/(1000/min)	294
Motor constant at 20 °C	$k_{M,20}$	Nm/(W) ^{0.5}	1.07
Thermal time constant	t_{TH}	s	75
No. of pole pairs	p	-	11
Cogging torque	M_{COG}	Nm	0.357
Stator mass	m_S	kg	2.2
Rotor mass	m_L	kg	0.881
Rotor moment of inertia	J_L	10 ⁻² kgm ²	0.139
Phase resistance of winding at 20 °C	$R_{STR, 20}$	Ω	6.91
Phase inductance of winding	L_{STR}	mH	24.5

Technical data	Symbol	Unit	-xxB03-0Fxx
1FW6050			
Data for main motor cooler			
Maximum dissipated thermal power	$Q_{H,MAX}$	kW	0.698
Recommended minimum volume flow	$\dot{V}_{H,MIN}$	l/min	2.6
Cooling medium temperature increase	ΔT_H	K	3.86
Pressure drop	Δp_H	bar	0.133

Characteristics for 1FW6050-xxB03-xxxx

Torque M with respect to speed n

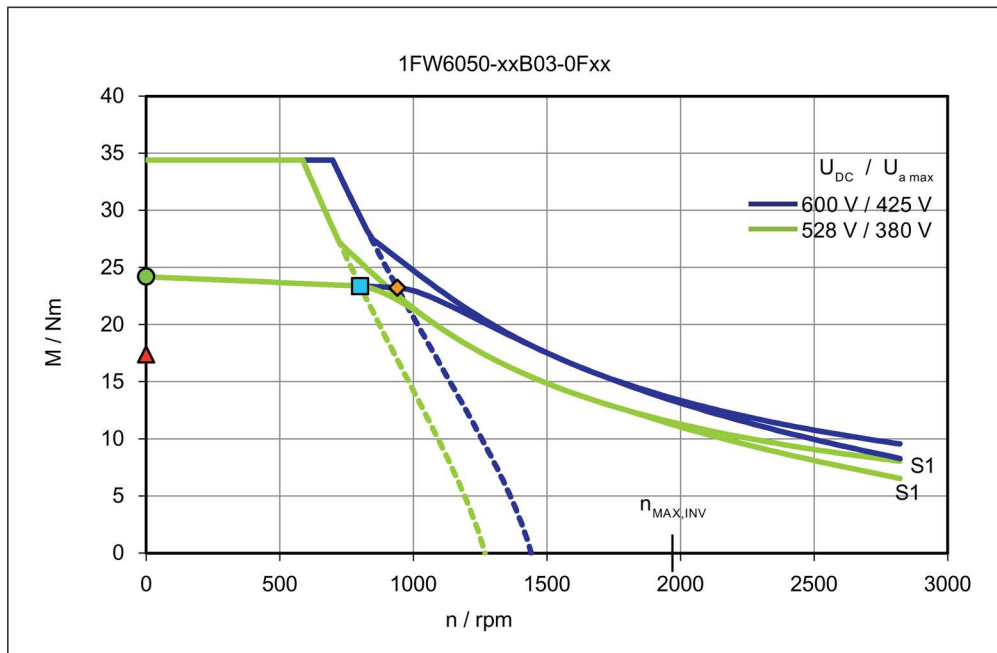

Torque M with respect to speed n

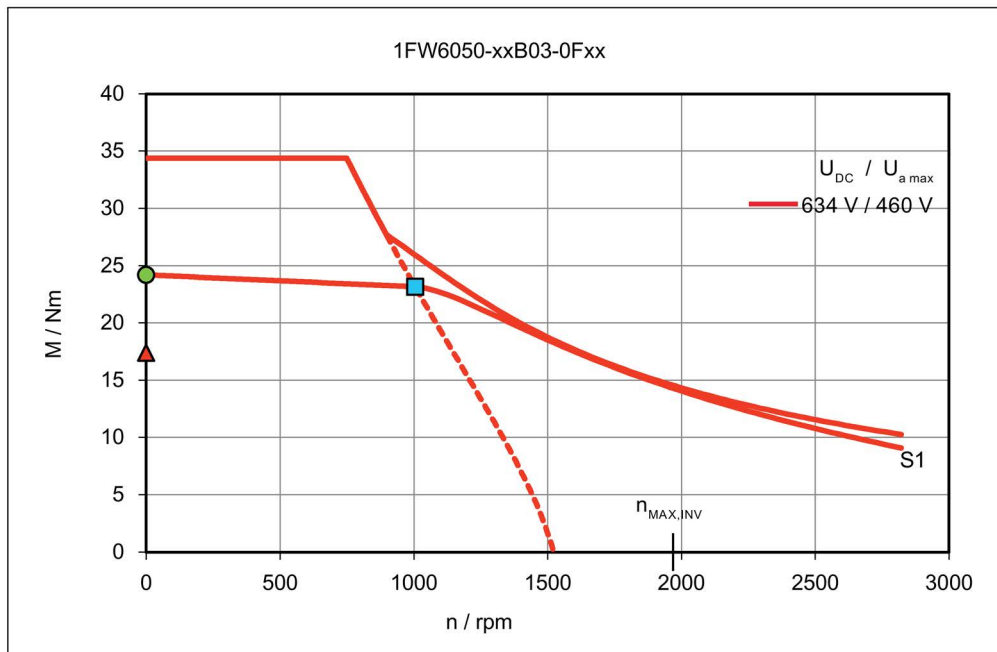

Short-circuit braking torque M_{Br} with respect to speed n

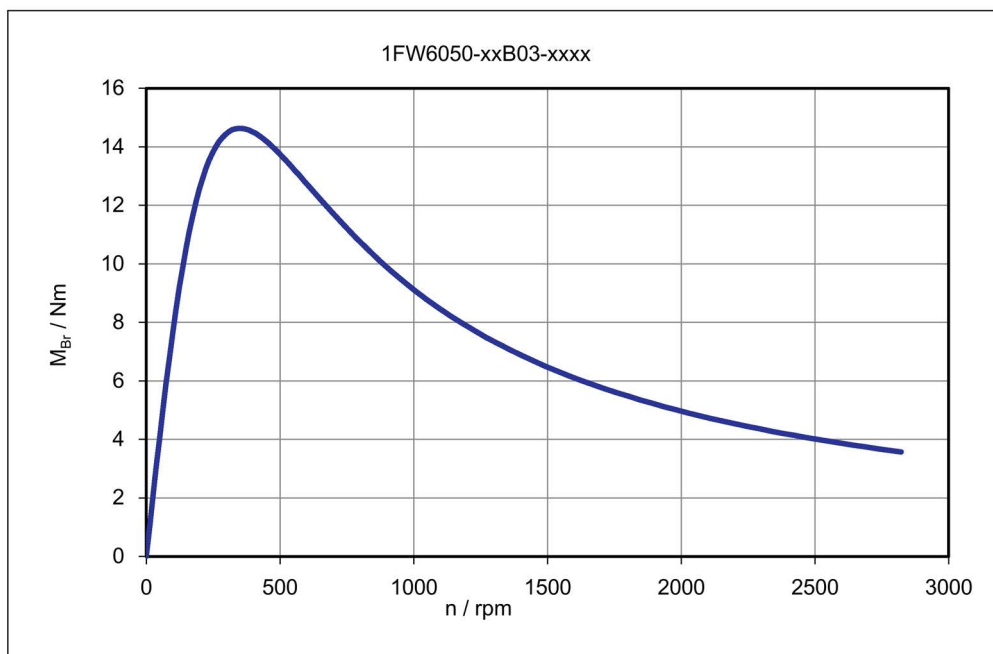

Main cooler - pressure losses Δp with respect to the volume flow \dot{V}

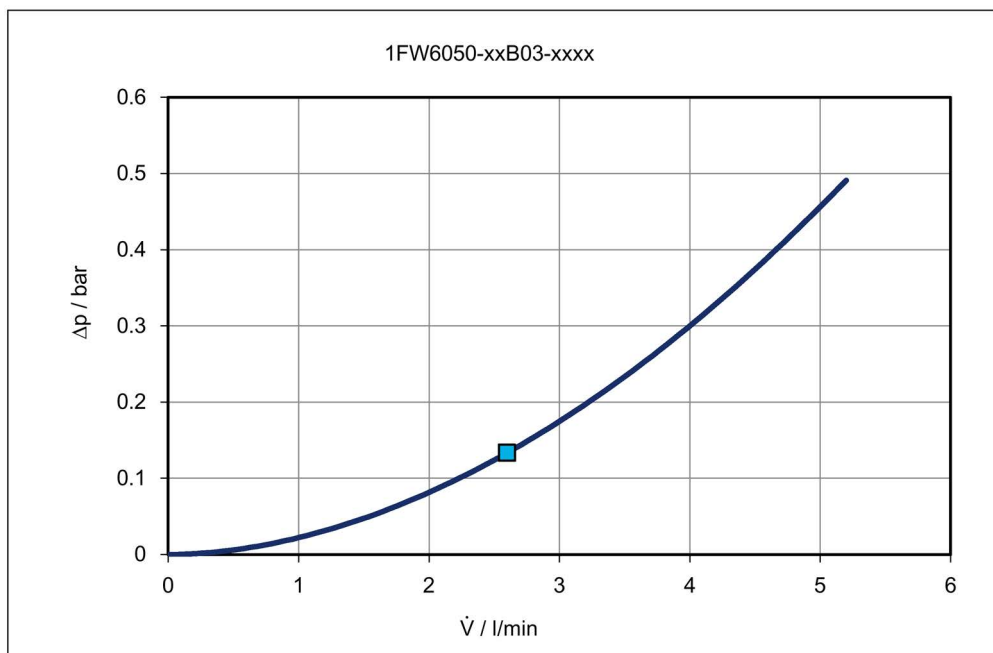

Rotor power loss P_{LV} with respect to speed n

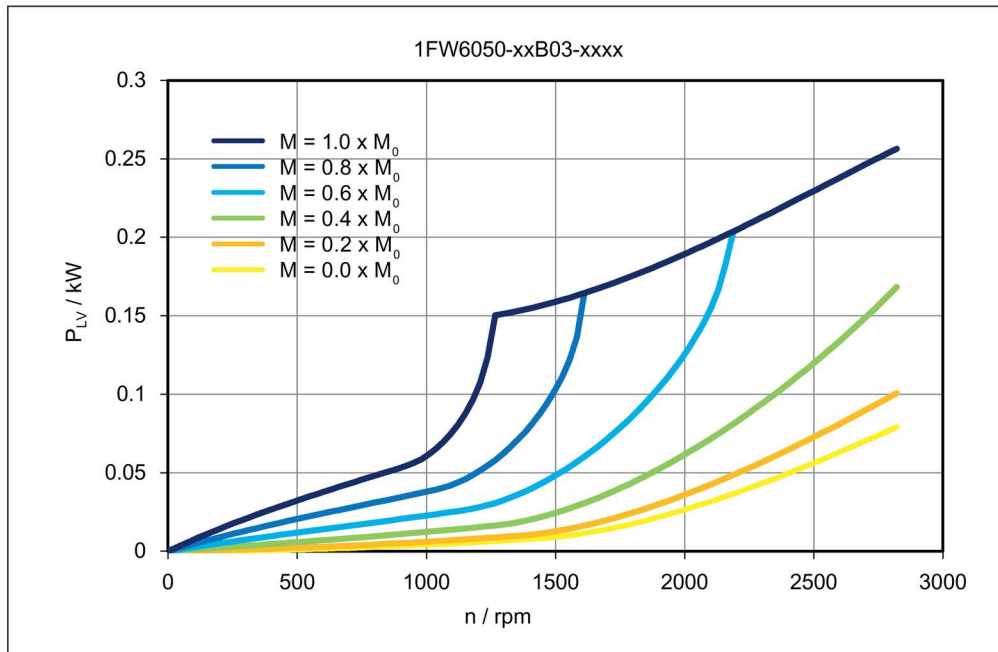

Data sheet 1FW6050-xxB05-xxxx

Table 6- 3 1FW6050-xxB05-0Fxx

Technical data	Symbol	Unit	-xxB05-0Fxx
1FW6050			
Boundary conditions			
DC link voltage	U_{DC}	V	600
Water cooling inlet temperature	T_{VORL}	°C	35
Rated temperature of winding	T_N	°C	130
Data at the rated operating point			
Rated torque	M_N	Nm	39.5
Rated current	I_N	A	4.98
Rated speed	n_N	rpm	525
Rated power loss	$P_{V,N}$	kW	1.04
Limit data			
Maximum torque	M_{MAX}	Nm	57.5
Maximum current	I_{MAX}	A	7.64
Electric motor power at M_{MAX}	$P_{EL,MAX}$	kW	4.59
Maximum speed	n_{MAX}	rpm	1730
Maximum speed at maximum torque	$n_{MAX,MMAX}$	rpm	376
Max. speed without VPM	$n_{MAX,INV}$	rpm	1180
No-load speed	$n_{MAX,0}$	rpm	865
Torque at $n = 1$ rpm	M_0	Nm	40.4
Current at M_0 and $n = 1$ rpm	I_0	A	5.1
Thermal static torque	M_0^*	Nm	29
Thermal stall current	I_0^*	A	3.6
Physical constants			
Torque constant at 20 °C	$k_{T,20}$	Nm/A	8.11
Voltage constant	k_E	V/(1000/min)	491
Motor constant at 20 °C	$k_{M,20}$	Nm/(W) ^{0.5}	1.54
Thermal time constant	t_{TH}	s	75
No. of pole pairs	p	-	11
Cogging torque	M_{COG}	Nm	0.596
Stator mass	m_s	kg	4.2
Rotor mass	m_L	kg	1.69
Rotor moment of inertia	J_L	10 ⁻² kgm ²	0.267
Phase resistance of winding at 20 °C	$R_{STR, 20}$	Ω	9.29
Phase inductance of winding	L_{STR}	mH	39.1

Technical data	Symbol	Unit	-xxB05-0Fxx
1FW6050			
Data for main motor cooler			
Maximum dissipated thermal power	$Q_{H,MAX}$	kW	0.941
Recommended minimum volume flow	$\dot{V}_{H,MIN}$	l/min	3.22
Cooling medium temperature increase	ΔT_H	K	4.2
Pressure drop	Δp_H	bar	0.2

Characteristics for 1FW6050-xxB05-xxxx

Torque M with respect to speed n

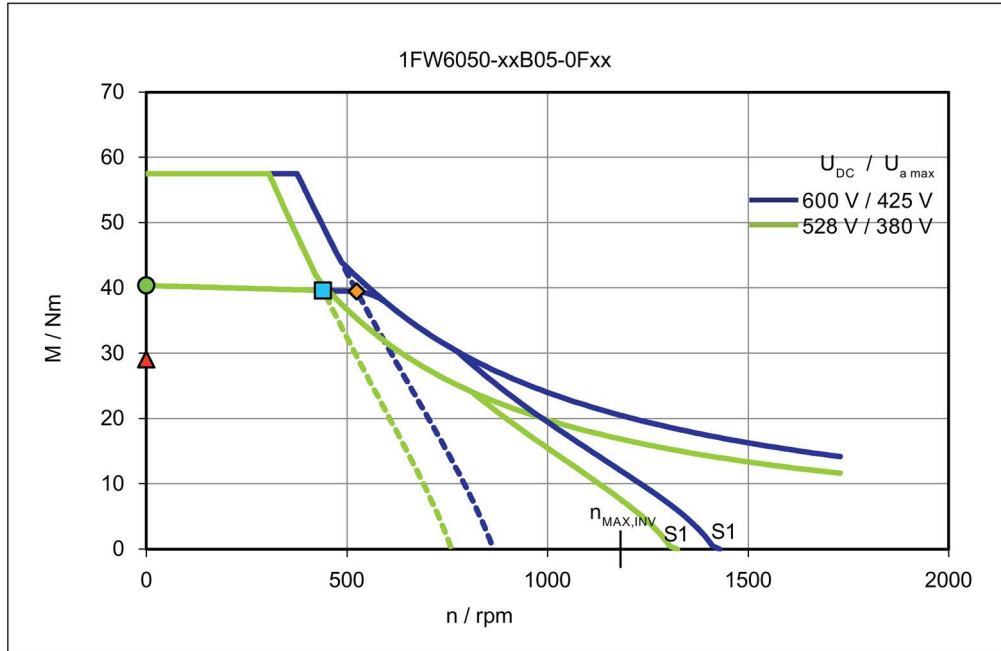

Torque M with respect to speed n

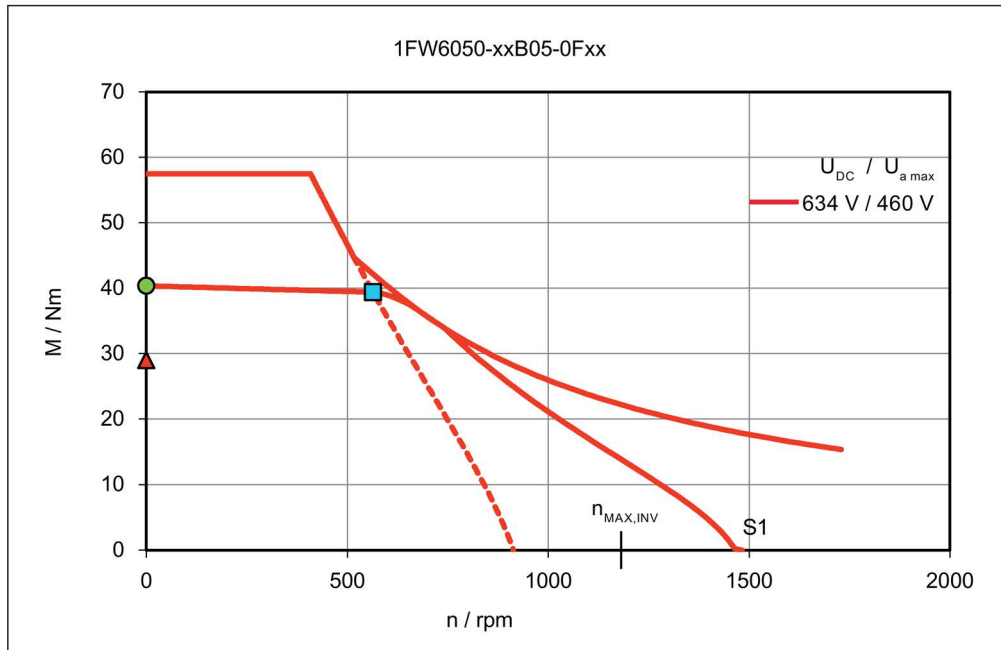

Short-circuit braking torque M_{Br} with respect to speed n

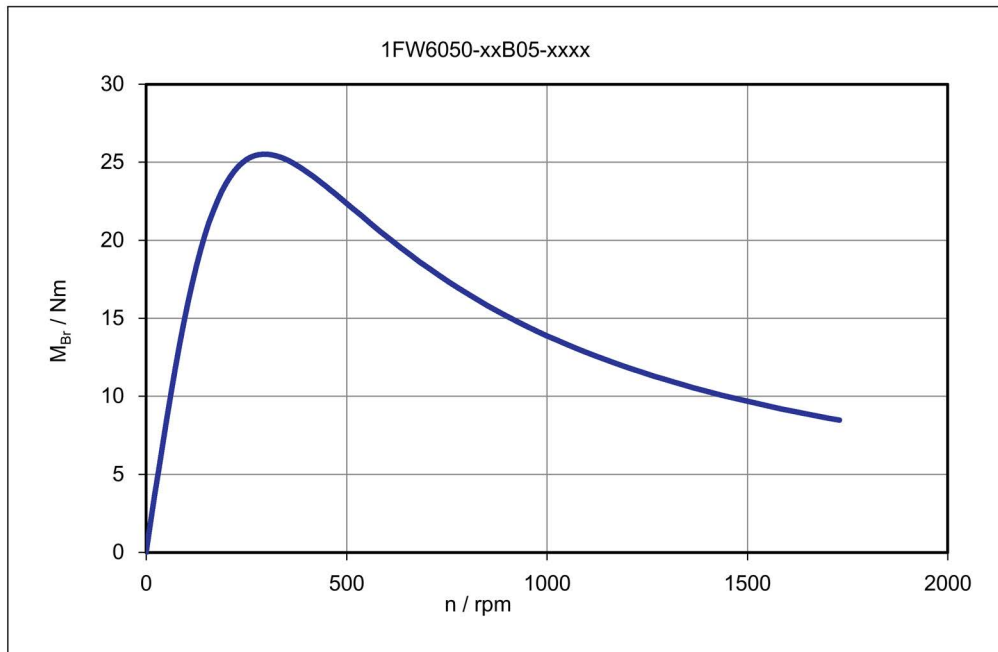

Main cooler - pressure losses Δp with respect to the volume flow \dot{V}

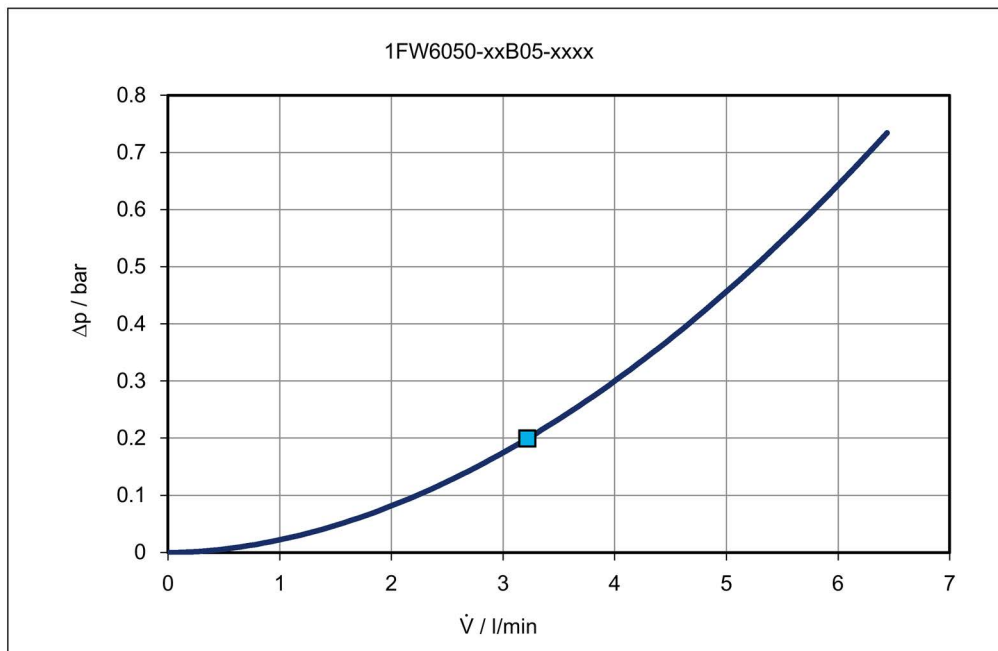

Rotor power loss P_{LV} with respect to speed n

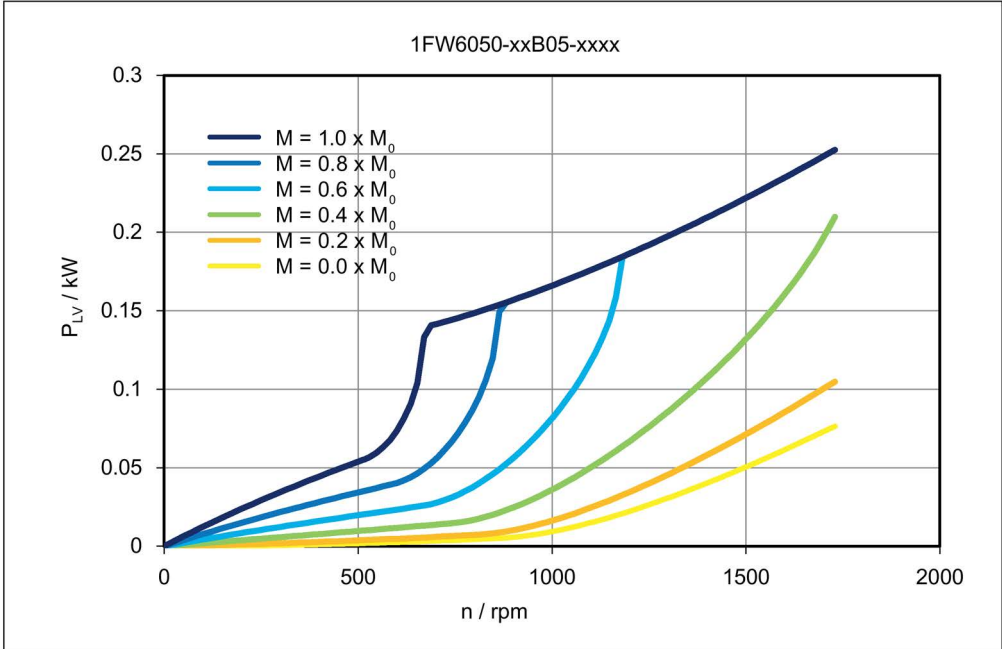

Data sheet 1FW6050-xxB07-xxxx

Table 6- 4 1FW6050-xxB07-0Fxx, 1FW6050-xxB07-0Kxx

Technical data	Symbol	Unit	-xxB07-0Fxx	-xxB07-0Kxx
1FW6050				
Boundary conditions				
DC link voltage	U_{DC}	V	600	600
Water cooling inlet temperature	T_{VORL}	°C	35	35
Rated temperature of winding	T_N	°C	130	130
Data at the rated operating point				
Rated torque	M_N	Nm	55.7	50.9
Rated current	I_N	A	5.02	9
Rated speed	n_N	rpm	349	895
Rated power loss	$P_{V,N}$	kW	1.27	1.23
Limit data				
Maximum torque	M_{MAX}	Nm	80.6	81.2
Maximum current	I_{MAX}	A	7.65	14.6
Electric motor power at M_{MAX}	$P_{EL,MAX}$	kW	4.85	8.79
Maximum speed	n_{MAX}	rpm	1240	2480
Maximum speed at maximum torque	$n_{MAX,MMAX}$	rpm	236	685
Max. speed without VPM	$n_{MAX,INV}$	rpm	844	1700
No-load speed	$n_{MAX,0}$	rpm	618	1240
Torque at $n = 1$ rpm	M_0	Nm	56.6	53
Current at M_0 and $n = 1$ rpm	I_0	A	5.1	9.38
Thermal static torque	M_0^*	Nm	40.7	37.5
Thermal stall current	I_0^*	A	3.61	6.63
Physical constants				
Torque constant at 20 °C	$k_{T,20}$	Nm/A	11.4	5.66
Voltage constant	k_E	V/(1000/min)	687	342
Motor constant at 20 °C	$k_{M,20}$	Nm/(W) ^{0.5}	1.95	1.81
Thermal time constant	t_{TH}	s	75	75
No. of pole pairs	p	-	11	11
Cogging torque	M_{COG}	Nm	0.835	0.835
Stator mass	m_S	kg	5.5	5.5
Rotor mass	m_L	kg	2.41	2.41
Rotor moment of inertia	J_L	10 ⁻² kgm ²	0.39	0.39
Phase resistance of winding at 20 °C	$R_{STR, 20}$	Ω	11.4	3.25
Phase inductance of winding	L_{STR}	mH	53.6	11.9

Technical data	Symbol	Unit	-xxB07-0Fxx	-xxB07-0Kxx
1FW6050				
Data for main motor cooler				
Maximum dissipated thermal power	$Q_{H,MAX}$	kW	1.15	1.12
Recommended minimum volume flow	$\dot{V}_{H,MIN}$	l/min	3.83	3.83
Cooling medium temperature increase	ΔT_H	K	4.32	4.19
Pressure drop	Δp_H	bar	0.276	0.276

Characteristics for 1FW6050-xxB07-xxxx

Torque M with respect to speed n

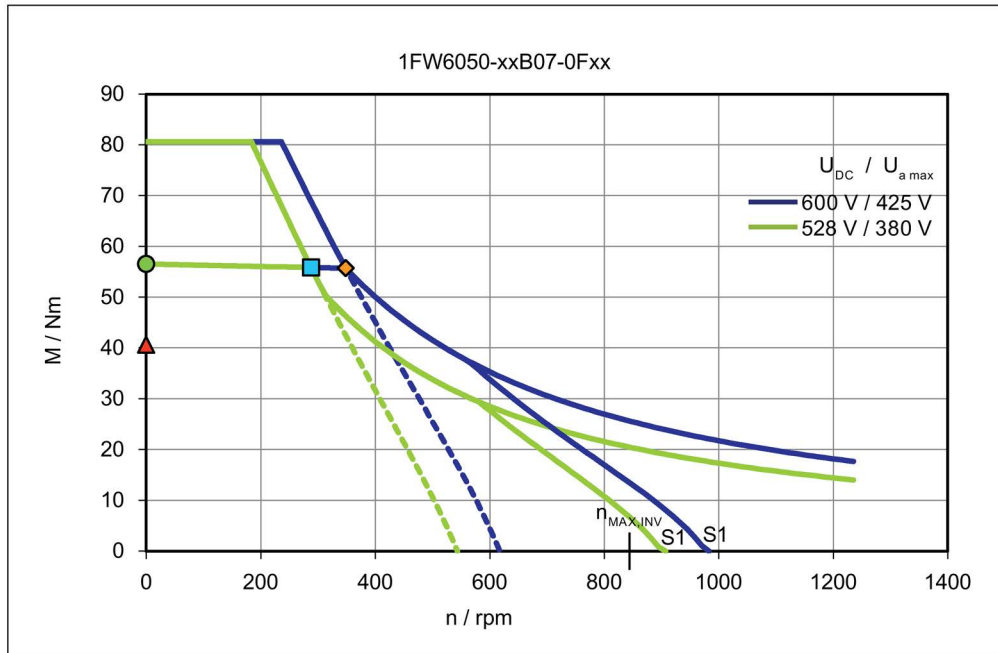

Torque M with respect to speed n

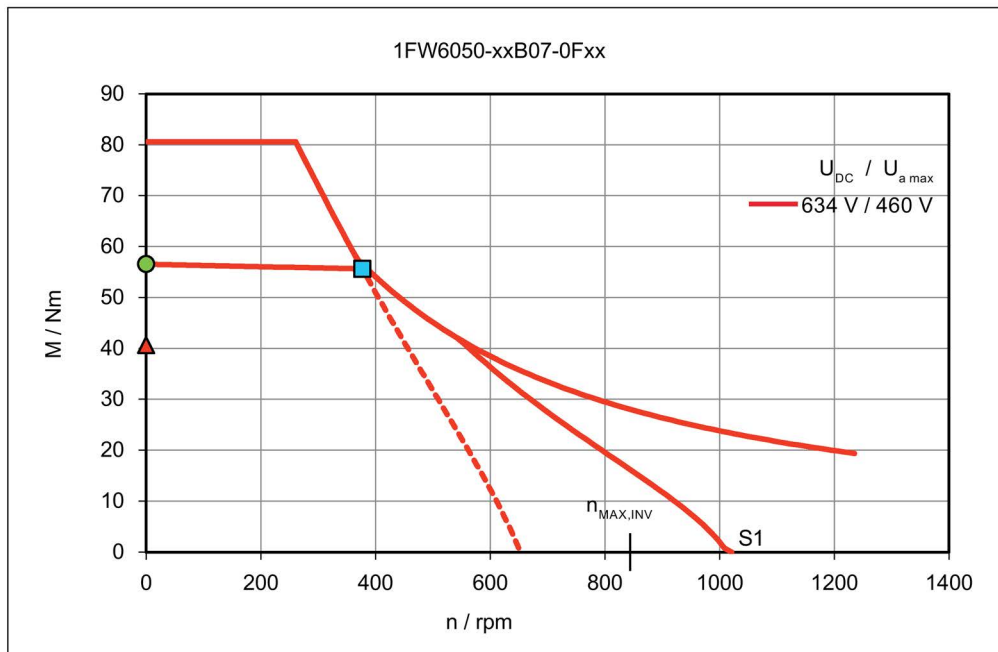

Torque M with respect to speed n

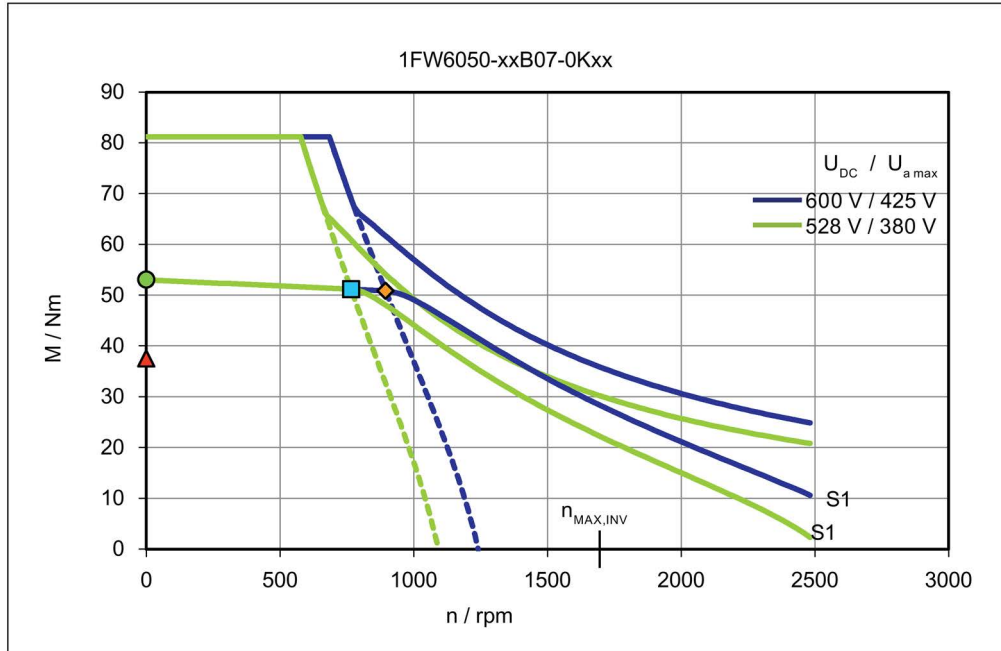

Torque M with respect to speed n

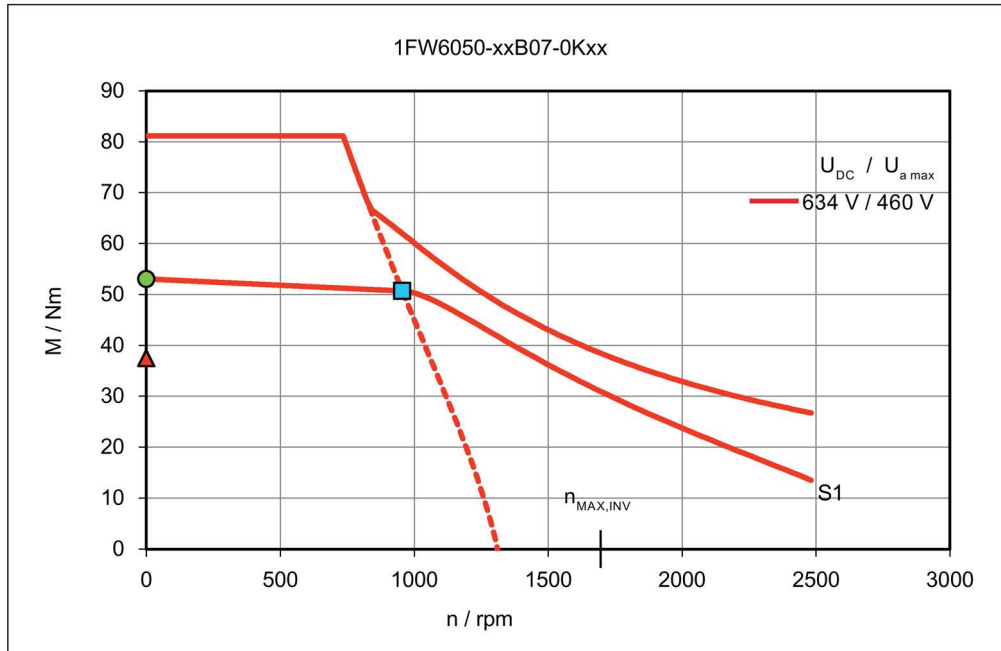

Short-circuit braking torque M_{Br} with respect to speed n

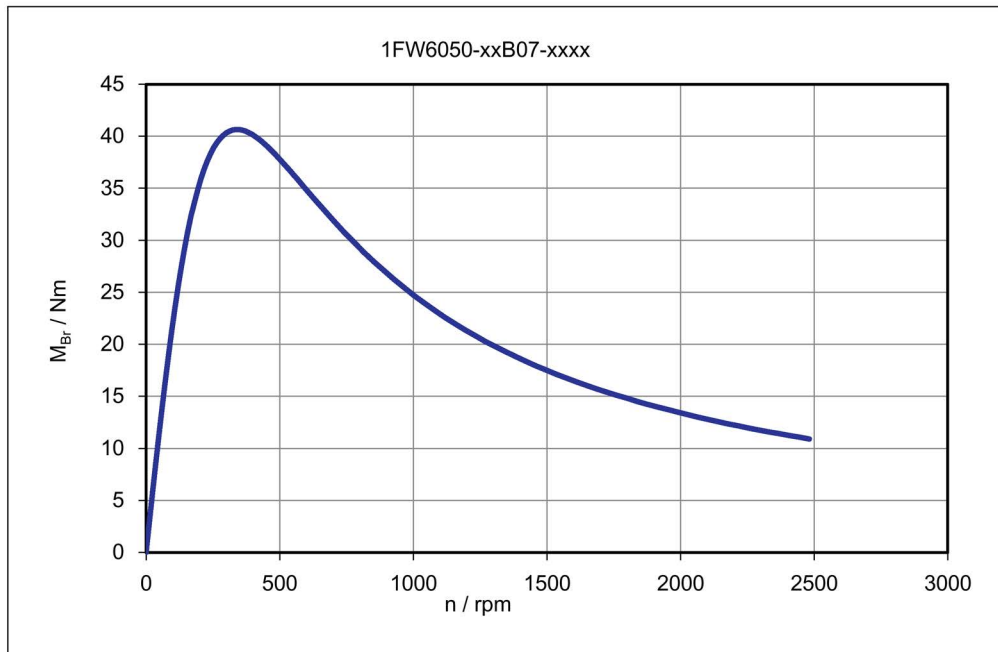

Main cooler - pressure losses Δp with respect to the volume flow \dot{V}

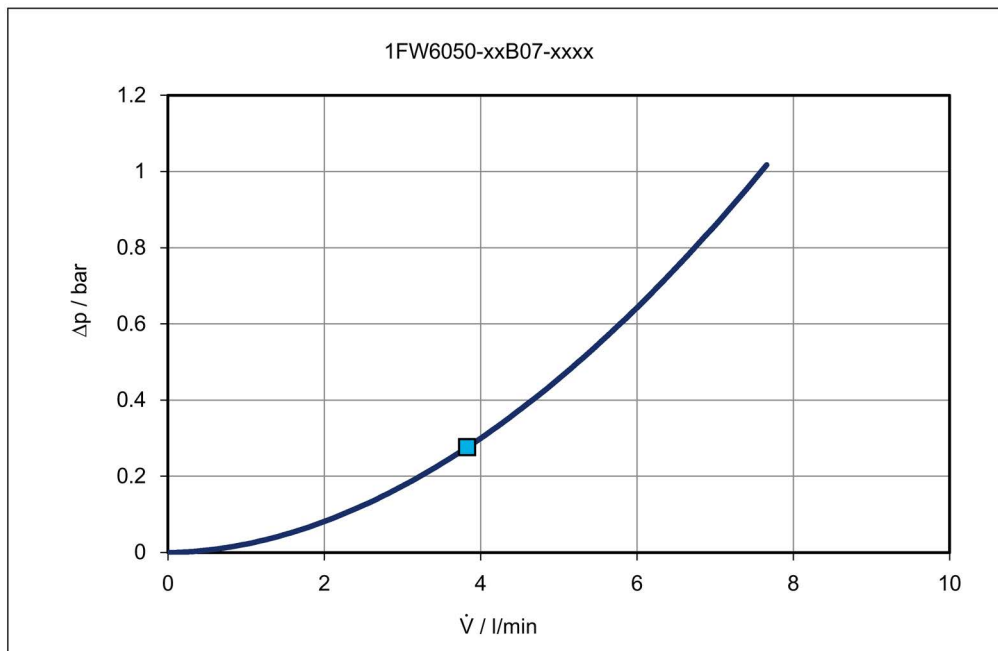

Rotor power loss P_{LV} with respect to speed n

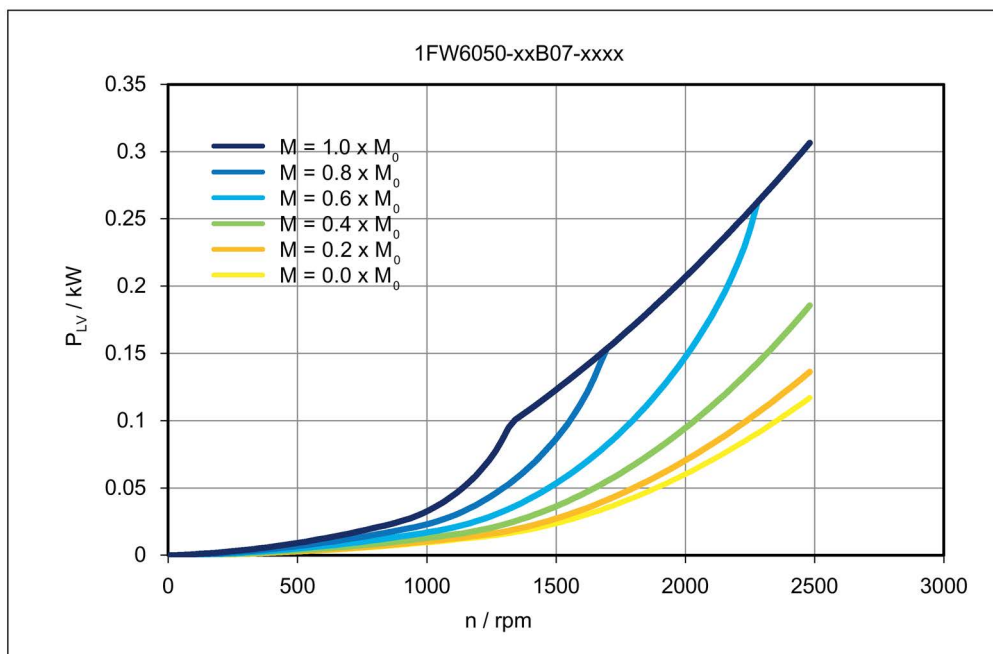

Data sheet 1FW6050-xxB10-xxxx

Table 6- 5 1FW6050-xxB10-0Kxx

Technical data	Symbol	Unit	-xxB10-0Kxx
1FW6050			
Boundary conditions			
DC link voltage	U_{DC}	V	600
Water cooling inlet temperature	T_{VORL}	°C	35
Rated temperature of winding	T_N	°C	130
Data at the rated operating point			
Rated torque	M_N	Nm	73.7
Rated current	I_N	A	9.13
Rated speed	n_N	rpm	589
Rated power loss	$P_{V,N}$	kW	1.6
Limit data			
Maximum torque	M_{MAX}	Nm	116
Maximum current	I_{MAX}	A	14.6
Electric motor power at M_{MAX}	$P_{EL,MAX}$	kW	9.16
Maximum speed	n_{MAX}	rpm	1740
Maximum speed at maximum torque	$n_{MAX,MMAX}$	rpm	437
Max. speed without VPM	$n_{MAX,INV}$	rpm	1190
No-load speed	$n_{MAX,0}$	rpm	869
Torque at $n = 1$ rpm	M_0	Nm	75.8
Current at M_0 and $n = 1$ rpm	I_0	A	9.38
Thermal static torque	M_0^*	Nm	53.6
Thermal stall current	I_0^*	A	6.63
Physical constants			
Torque constant at 20 °C	$k_{T,20}$	Nm/A	8.08
Voltage constant	k_E	V/(1000/min)	488
Motor constant at 20 °C	$k_{M,20}$	Nm/(W) ^{0.5}	2.27
Thermal time constant	t_{TH}	s	75
No. of pole pairs	p	-	11
Cogging torque	M_{COG}	Nm	1.19
Stator mass	m_s	kg	8.3
Rotor mass	m_L	kg	3.07
Rotor moment of inertia	J_L	10 ⁻² kgm ²	0.488
Phase resistance of winding at 20 °C	$R_{STR,20}$	Ω	4.23
Phase inductance of winding	L_{STR}	mH	16.9

Technical data	Symbol	Unit	-xxB10-0Kxx
1FW6050			
Data for main motor cooler			
Maximum dissipated thermal power	$Q_{H,MAX}$	kW	1.45
Recommended minimum volume flow	$\dot{V}_{H,MIN}$	l/min	4.76
Cooling medium temperature increase	ΔT_H	K	4.38
Pressure drop	Δp_H	bar	0.416

Characteristics for 1FW6050-xxB10-xxxx

Torque M with respect to speed n

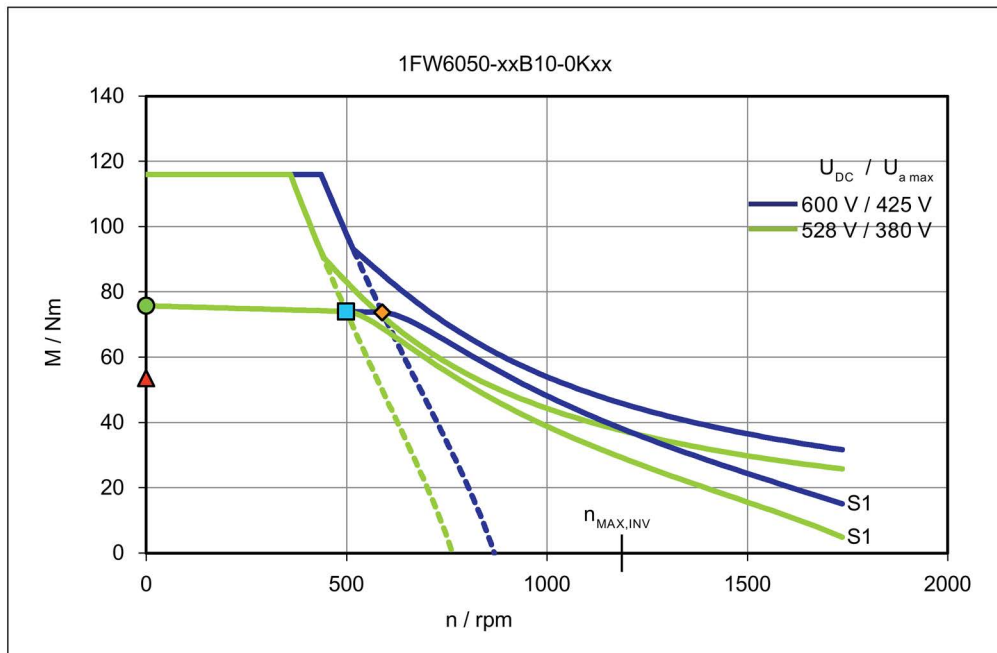

Torque M with respect to speed n

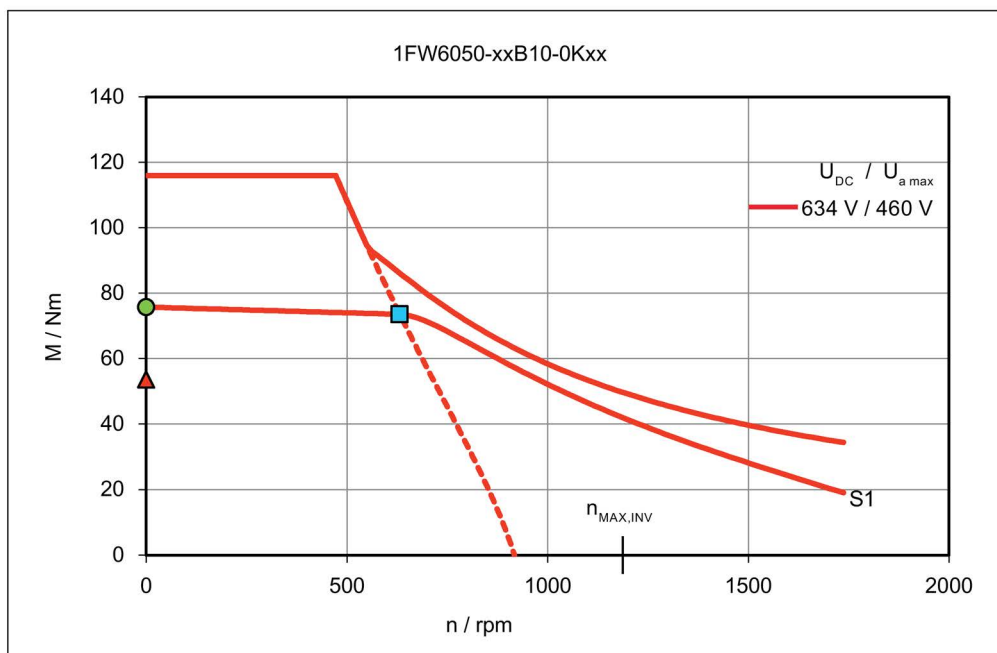

Short-circuit braking torque M_{Br} with respect to speed n

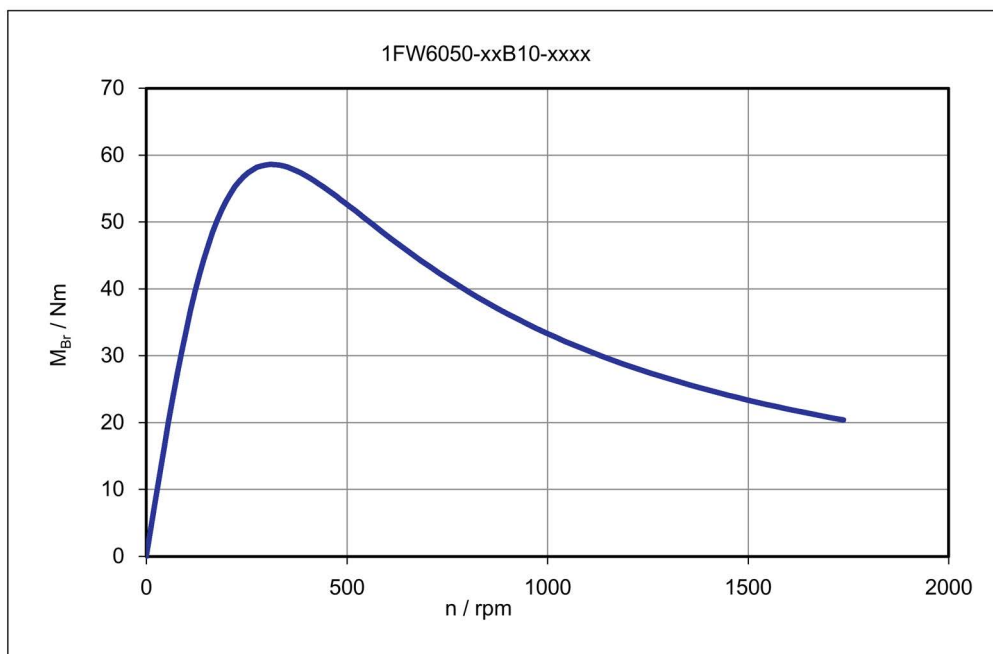

Main cooler - pressure losses Δp with respect to the volume flow \dot{V}

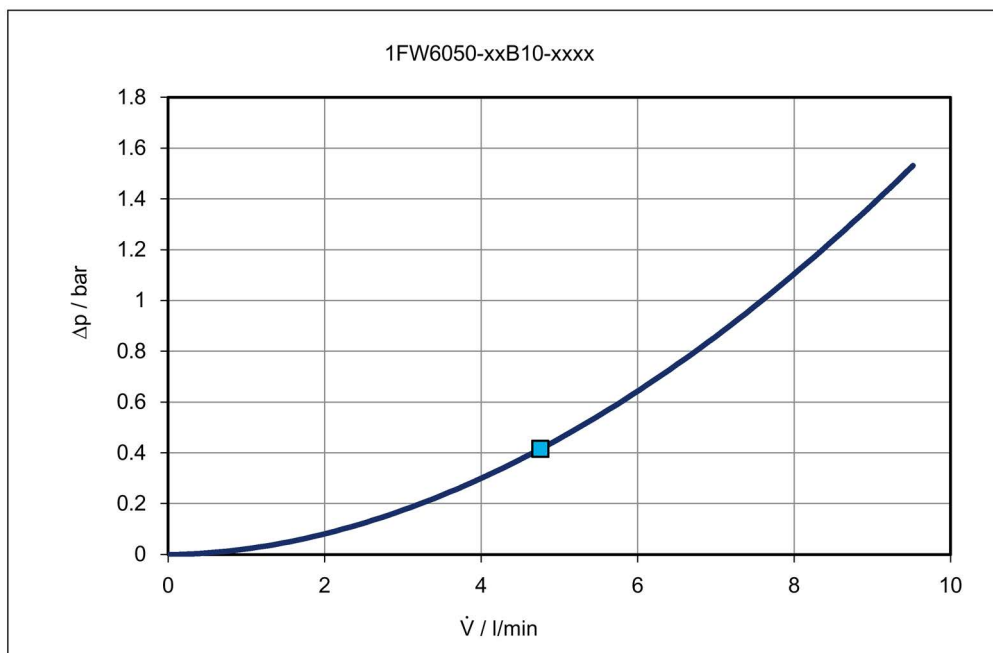

Rotor power loss P_{LV} with respect to speed n

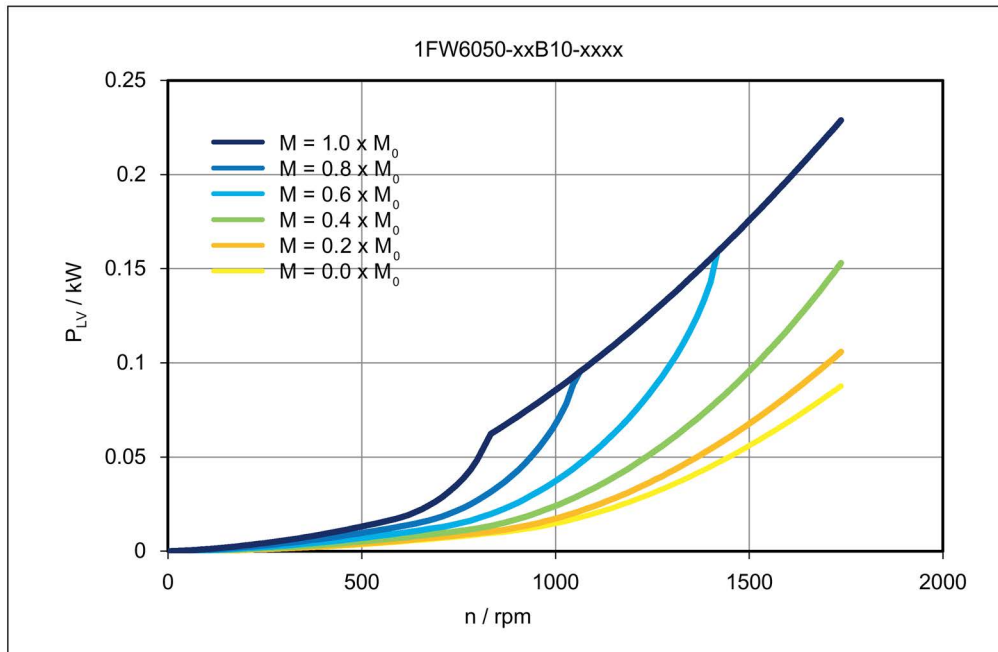

Data sheet 1FW6050-xxB15-xxxx

Table 6- 6 1FW6050-xxB15-0Kxx, 1FW6050-xxB15-1Jxx

Technical data	Symbol	Unit	-xxB15-0Kxx	-xxB15-1Jxx
1FW6050				
Boundary conditions				
DC link voltage	U_{DC}	V	600	600
Water cooling inlet temperature	T_{VORL}	°C	35	35
Rated temperature of winding	T_N	°C	130	130
Data at the rated operating point				
Rated torque	M_N	Nm	112	109
Rated current	I_N	A	9.23	18
Rated speed	n_N	rpm	348	850
Rated power loss	$P_{V,N}$	kW	2.27	2.27
Limit data				
Maximum torque	M_{MAX}	Nm	174	174
Maximum current	I_{MAX}	A	14.6	29.1
Electric motor power at M_{MAX}	$P_{EL,MAX}$	kW	9.74	17.5
Maximum speed	n_{MAX}	rpm	1160	2320
Maximum speed at maximum torque	$n_{MAX,MMAX}$	rpm	234	658
Max. speed without VPM	$n_{MAX,INV}$	rpm	791	1580
No-load speed	$n_{MAX,0}$	rpm	579	1160
Torque at $n = 1$ rpm	M_0	Nm	114	114
Current at M_0 and $n = 1$ rpm	I_0	A	9.38	18.8
Thermal static torque	M_0^*	Nm	80.4	80.4
Thermal stall current	I_0^*	A	6.63	13.3
Physical constants				
Torque constant at 20 °C	$k_{T,20}$	Nm/A	12.1	6.06
Voltage constant	k_E	V/(1000/min)	733	366
Motor constant at 20 °C	$k_{M,20}$	Nm/(W) ^{0.5}	2.86	2.86
Thermal time constant	t_{TH}	s	75	75
No. of pole pairs	p	-	11	11
Cogging torque	M_{COG}	Nm	1.79	1.79
Stator mass	m_s	kg	14.8	14.8
Rotor mass	m_L	kg	4.37	4.37
Rotor moment of inertia	J_L	10 ⁻² kgm ²	0.691	0.691
Phase resistance of winding at 20 °C	$R_{STR, 20}$	Ω	6	1.5
Phase inductance of winding	L_{STR}	mH	25.1	6.28

Technical data	Symbol	Unit	-xxB15-0Kxx	-xxB15-1Jxx
1FW6050				
Data for main motor cooler				
Maximum dissipated thermal power	$Q_{H,MAX}$	kW	2.06	2.06
Recommended minimum volume flow	$\dot{V}_{H,MIN}$	l/min	6.3	6.3
Cooling medium temperature increase	ΔT_H	K	4.7	4.7
Pressure drop	Δp_H	bar	0.705	0.705

Characteristics for 1FW6050-xxB15-xxxx

Torque M with respect to speed n

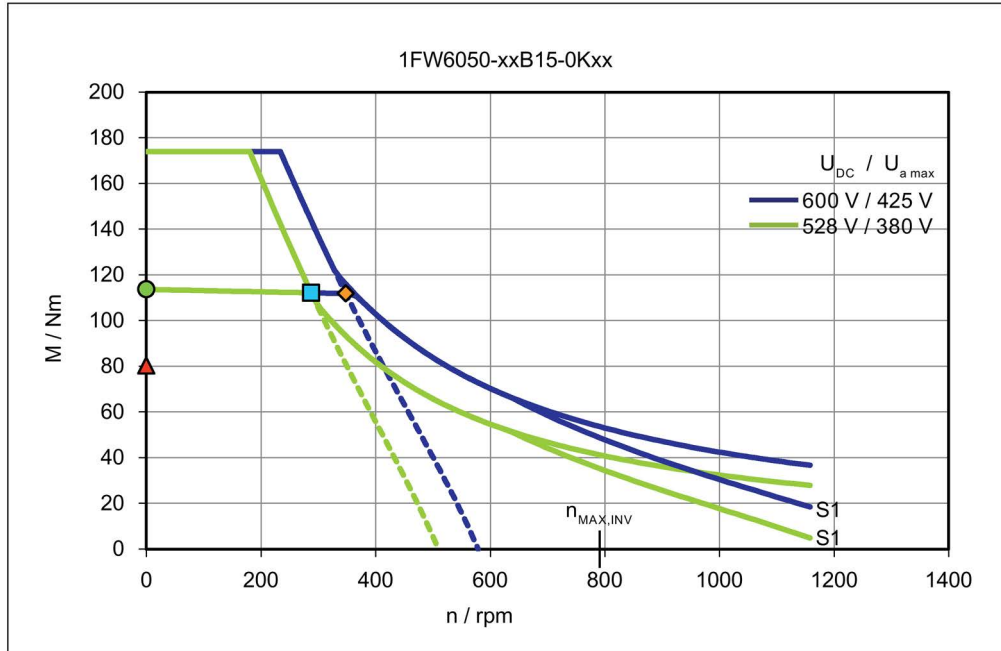

Torque M with respect to speed n

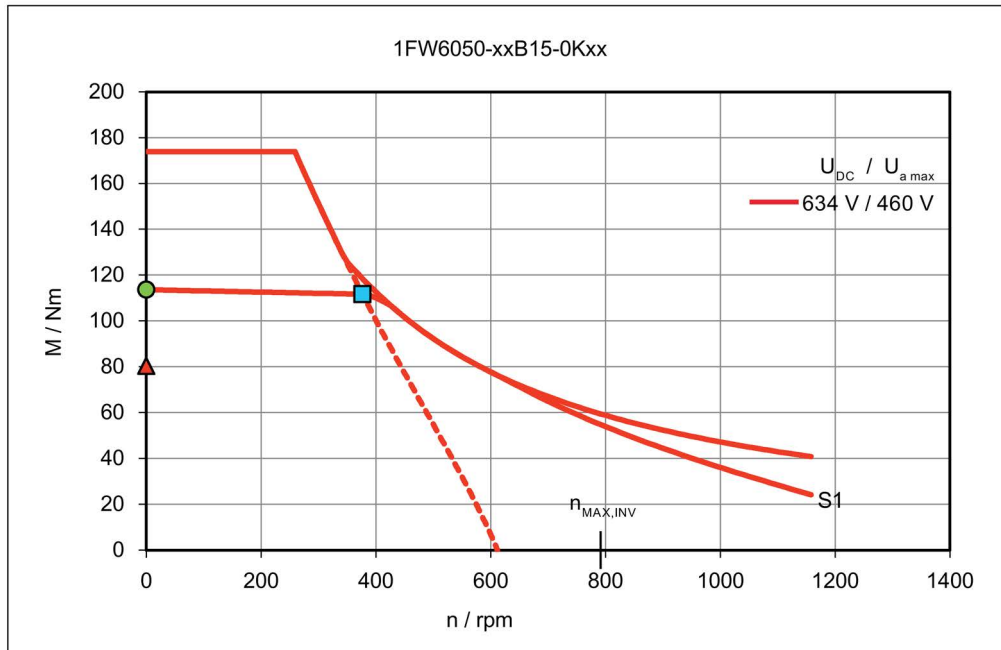

Torque M with respect to speed n

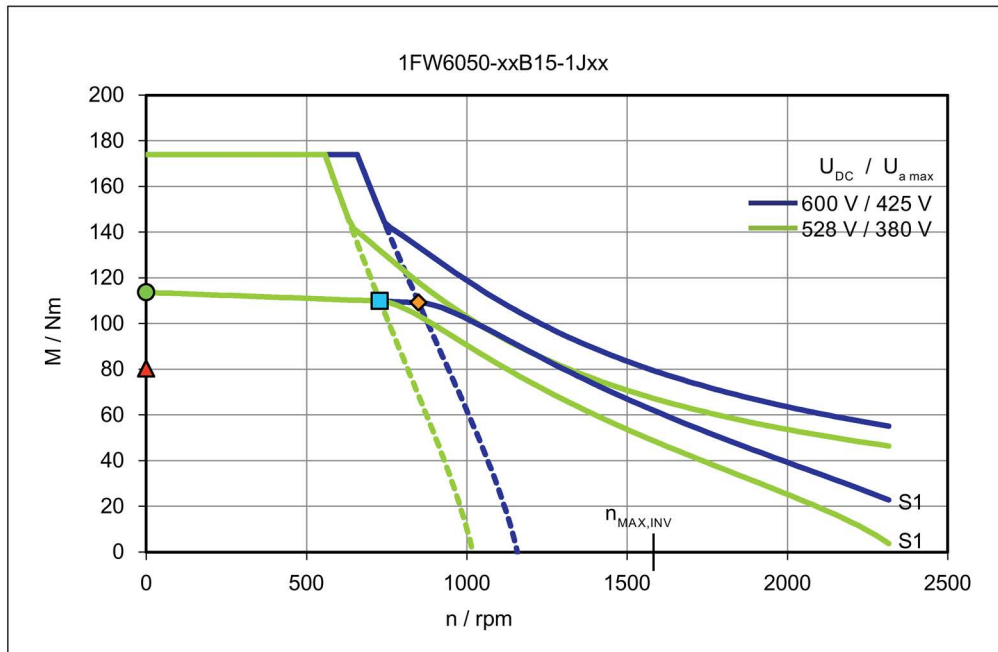

Torque M with respect to speed n

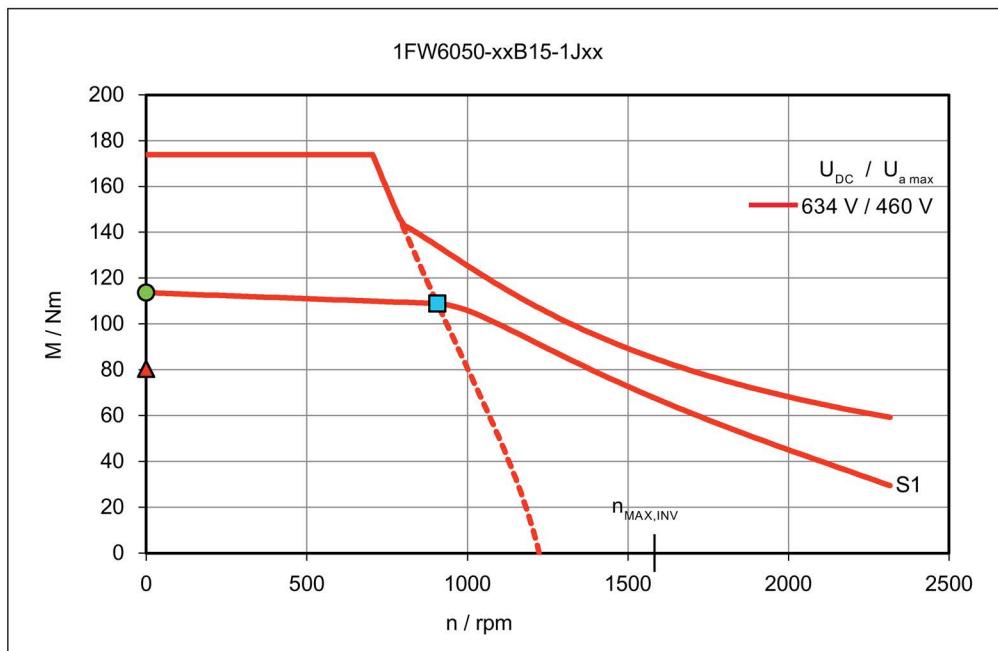

Short-circuit braking torque M_{Br} with respect to speed n

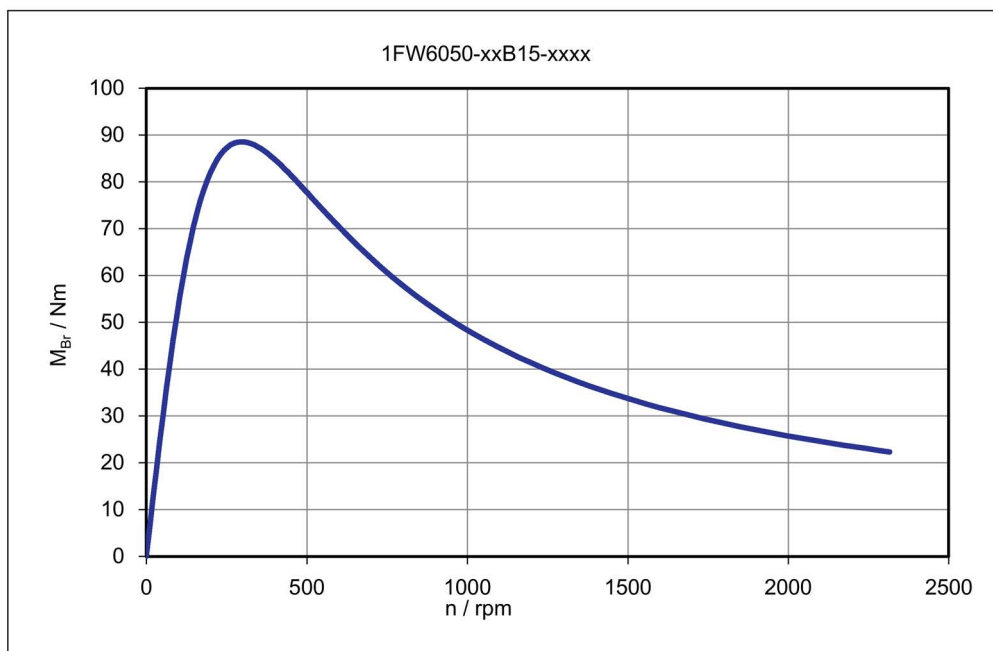

Main cooler - pressure losses Δp with respect to the volume flow \dot{V}

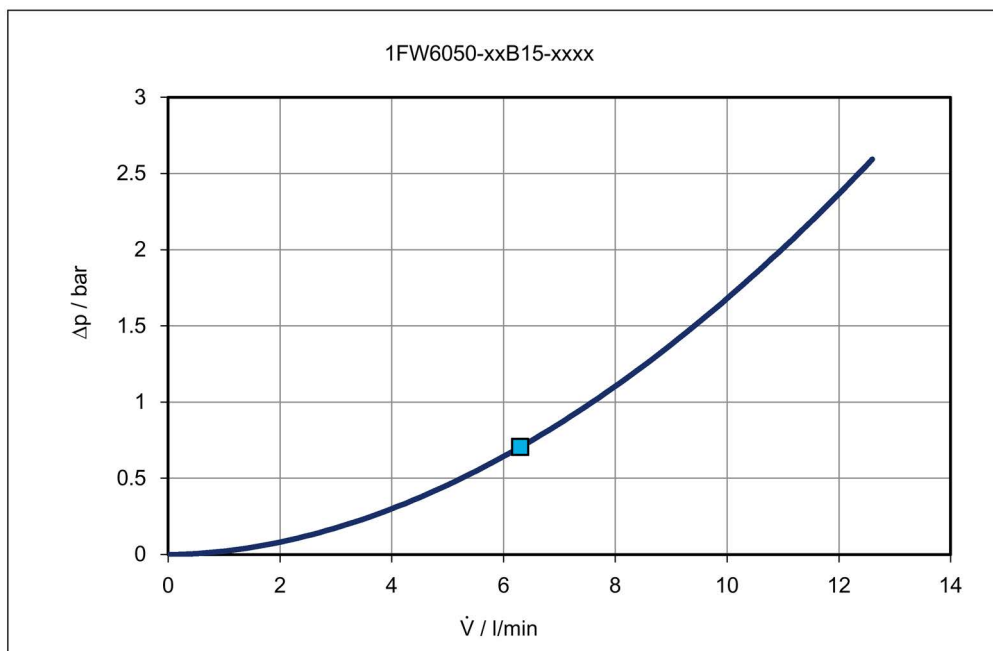

Rotor power loss P_{LV} with respect to speed n

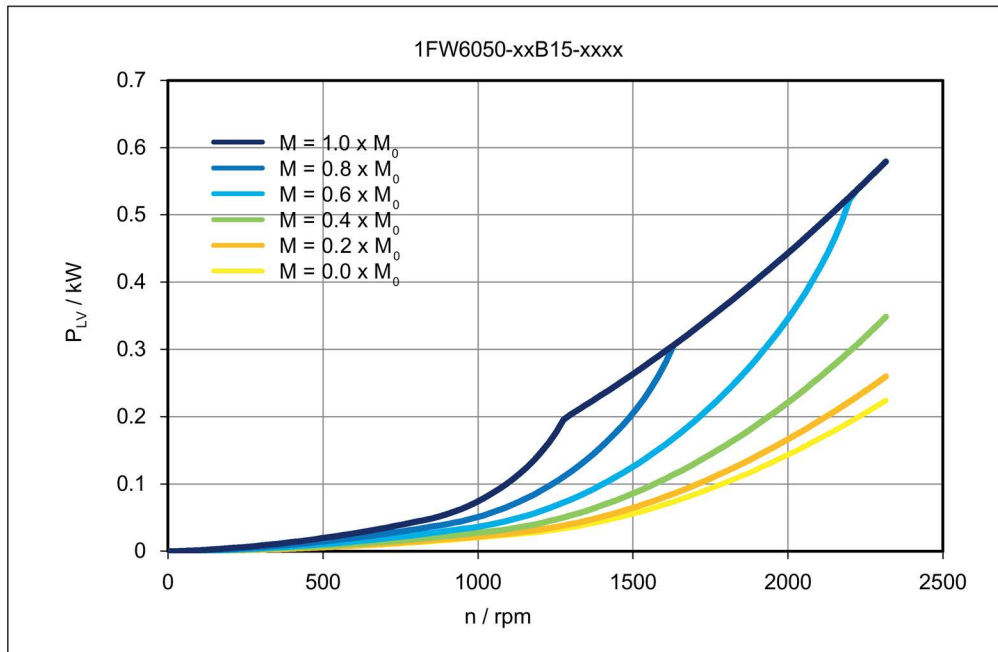

6.2.2 1FW6060-xxxxx-xxxx

Data sheet 1FW6060-xxB03-xxxx

Table 6- 7 1FW6060-xxB03-0Fxx

Technical data	Symbol	Unit	-xxB03-0Fxx
1FW6060			
Boundary conditions			
DC link voltage	U_{DC}	V	600
Water cooling inlet temperature	T_{VORL}	°C	35
Rated temperature of winding	T_N	°C	130
Data at the rated operating point			
Rated torque	M_N	Nm	32
Rated current	I_N	A	4.33
Rated speed	n_N	rpm	633
Rated power loss	$P_{V,N}$	kW	0.778
Limit data			
Maximum torque	M_{MAX}	Nm	64.5
Maximum current	I_{MAX}	A	9.81
Electric motor power at M_{MAX}	$P_{EL,MAX}$	kW	5.91
Maximum speed	n_{MAX}	rpm	1860
Maximum speed at maximum torque	$n_{MAX,MMAX}$	rpm	330
Max. speed without VPM	$n_{MAX,INV}$	rpm	1270
No-load speed	$n_{MAX,0}$	rpm	932
Torque at $n = 1$ rpm	M_0	Nm	33.3
Current at M_0 and $n = 1$ rpm	I_0	A	4.51
Thermal static torque	M_0^*	Nm	23.8
Thermal stall current	I_0^*	A	3.19
Physical constants			
Torque constant at 20 °C	$k_{T,20}$	Nm/A	7.53
Voltage constant	k_E	V/(1000/min)	455
Motor constant at 20 °C	$k_{M,20}$	Nm/(W) ^{0.5}	1.46
Thermal time constant	t_{TH}	s	75
No. of pole pairs	p	-	15
Cogging torque	M_{COG}	Nm	0.466
Stator mass	m_S	kg	5.87
Rotor mass	m_L	kg	1.21
Rotor moment of inertia	J_L	10 ⁻² kgm ²	0.347
Phase resistance of winding at 20 °C	$R_{STR, 20}$	Ω	8.9
Phase inductance of winding	L_{STR}	mH	24.2

Technical data	Symbol	Unit	-xxB03-0Fxx
1FW6060			
Data for main motor cooler			
Maximum dissipated thermal power	$Q_{H,MAX}$	kW	0.647
Recommended minimum volume flow	$\dot{V}_{H,MIN}$	l/min	3.46
Cooling medium temperature increase	ΔT_H	K	2.69
Pressure drop	Δp_H	bar	0.496

Characteristics for 1FW6060-xxB03-xxxx

Torque M with respect to speed n

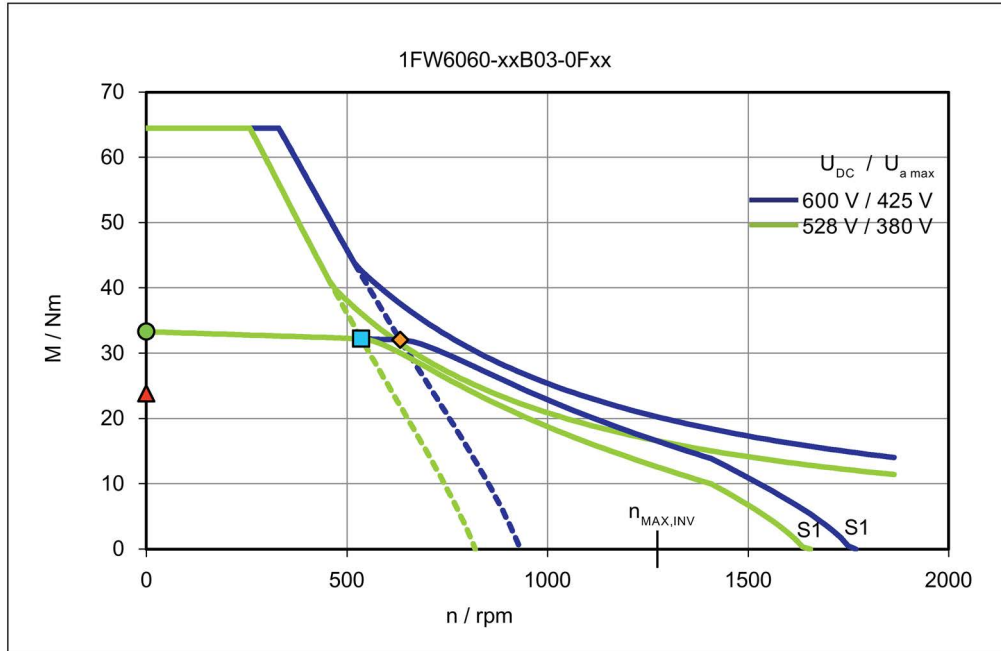

Torque M with respect to speed n

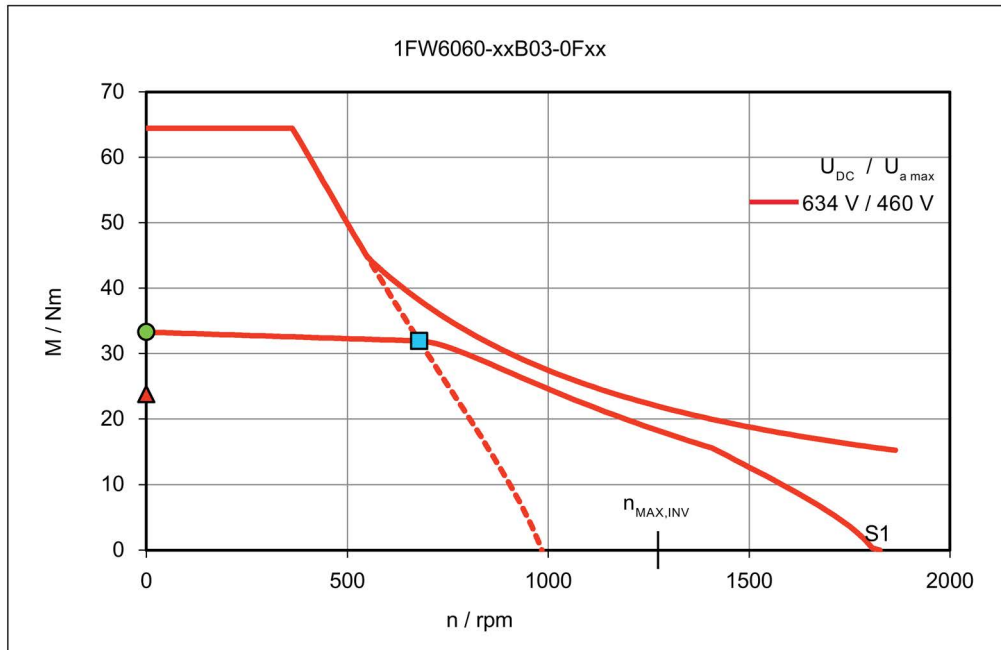

Short-circuit braking torque M_{Br} with respect to speed n

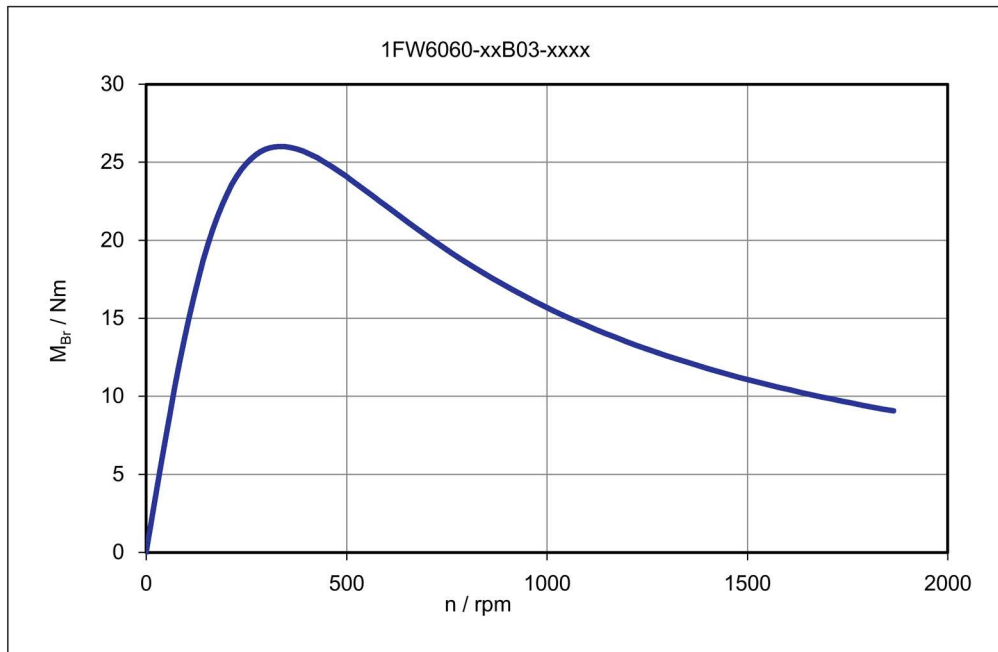

Main cooler - pressure losses Δp with respect to the volume flow \dot{V}

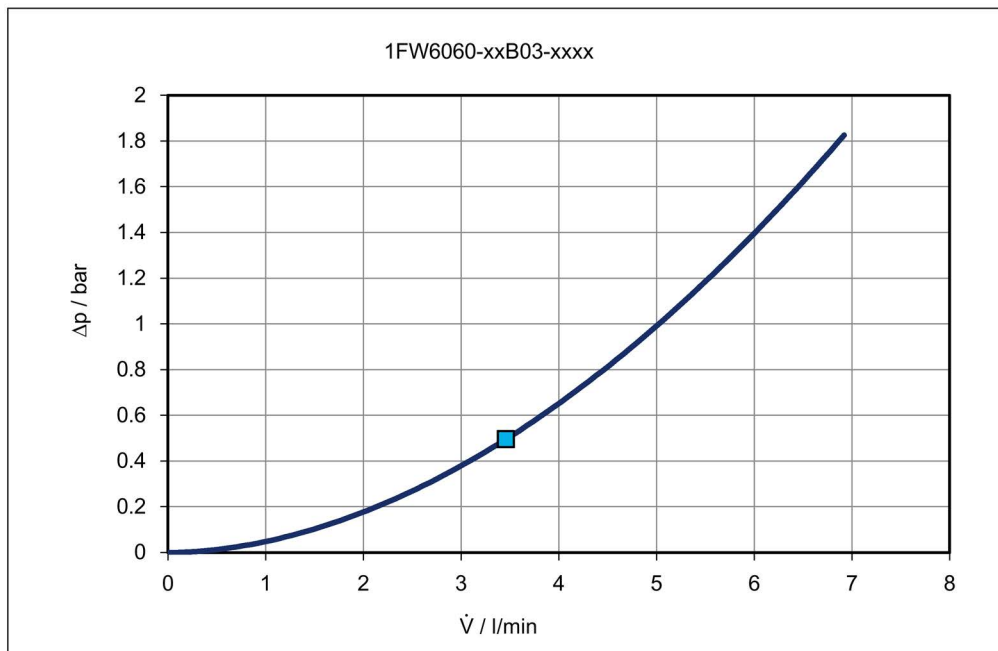

Rotor power loss P_{LV} with respect to speed n

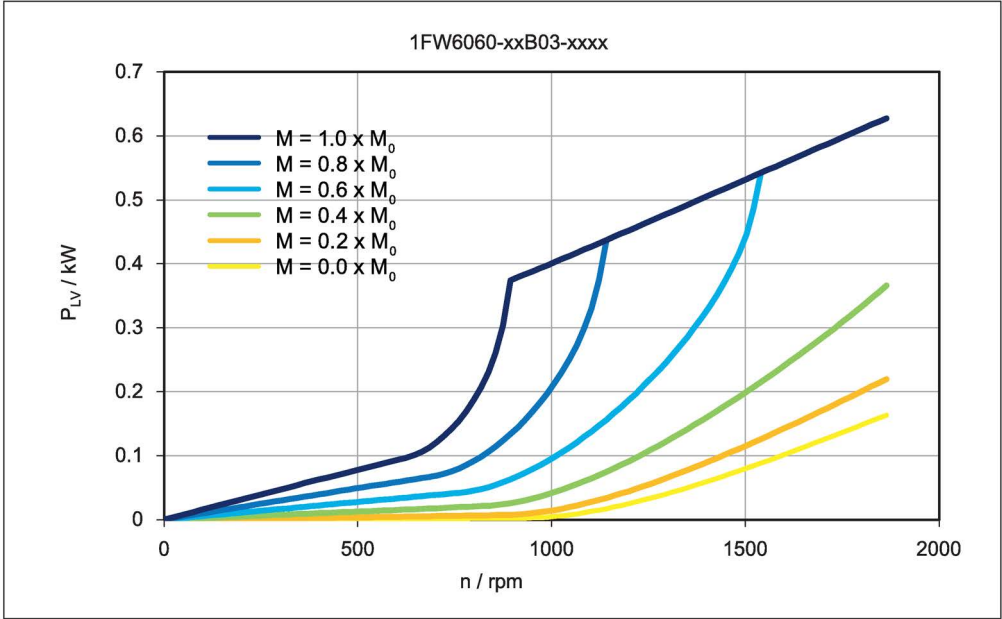

Data sheet 1FW6060-xxB05-xxxx

Table 6- 8 1FW6060-xxB05-0Fxx, 1FW6060-xxB05-0Kxx

Technical data	Symbol	Unit	-xxB05-0Fxx	-xxB05-0Kxx
1FW6060				
Boundary conditions				
DC link voltage	U_{DC}	V	600	600
Water cooling inlet temperature	T_{VORL}	°C	35	35
Rated temperature of winding	T_N	°C	130	130
Data at the rated operating point				
Rated torque	M_N	Nm	62	60.6
Rated current	I_N	A	4.42	7.79
Rated speed	n_N	rpm	309	663
Rated power loss	$P_{V,N}$	kW	1.06	1.07
Limit data				
Maximum torque	M_{MAX}	Nm	123	123
Maximum current	I_{MAX}	A	9.85	17.7
Electric motor power at M_{MAX}	$P_{EL,MAX}$	kW	6.65	10.2
Maximum speed	n_{MAX}	rpm	984	1770
Maximum speed at maximum torque	$n_{MAX,MMAX}$	rpm	126	399
Max. speed without VPM	$n_{MAX,INV}$	rpm	672	1210
No-load speed	$n_{MAX,0}$	rpm	492	886
Torque at $n = 1$ rpm	M_0	Nm	63.1	63.1
Current at M_0 and $n = 1$ rpm	I_0	A	4.51	8.13
Thermal static torque	M_0^*	Nm	45.2	45.2
Thermal stall current	I_0^*	A	3.19	5.75
Physical constants				
Torque constant at 20 °C	$k_{T,20}$	Nm/A	14.3	7.92
Voltage constant	k_E	V/(1000/min)	863	479
Motor constant at 20 °C	$k_{M,20}$	Nm/(W) ^{0.5}	2.37	2.36
Thermal time constant	t_{TH}	s	75	75
No. of pole pairs	p	-	15	15
Cogging torque	M_{COG}	Nm	0.884	0.884
Stator mass	m_S	kg	7.62	7.62
Rotor mass	m_L	kg	2.32	2.32
Rotor moment of inertia	J_L	10 ⁻² kgm ²	0.665	0.665
Phase resistance of winding at 20 °C	$R_{STR, 20}$	Ω	12.1	3.76
Phase inductance of winding	L_{STR}	mH	38.7	11.9

Technical data	Symbol	Unit	-xxB05-0Fxx	-xxB05-0Kxx
1FW6060				
Data for main motor cooler				
Maximum dissipated thermal power	$Q_{H,MAX}$	kW	0.88	0.889
Recommended minimum volume flow	$\dot{V}_{H,MIN}$	l/min	4.28	4.28
Cooling medium temperature increase	ΔT_H	K	2.96	2.99
Pressure drop	Δp_H	bar	0.74	0.74

Characteristics for 1FW6060-xxB05-xxxx

Torque M with respect to speed n

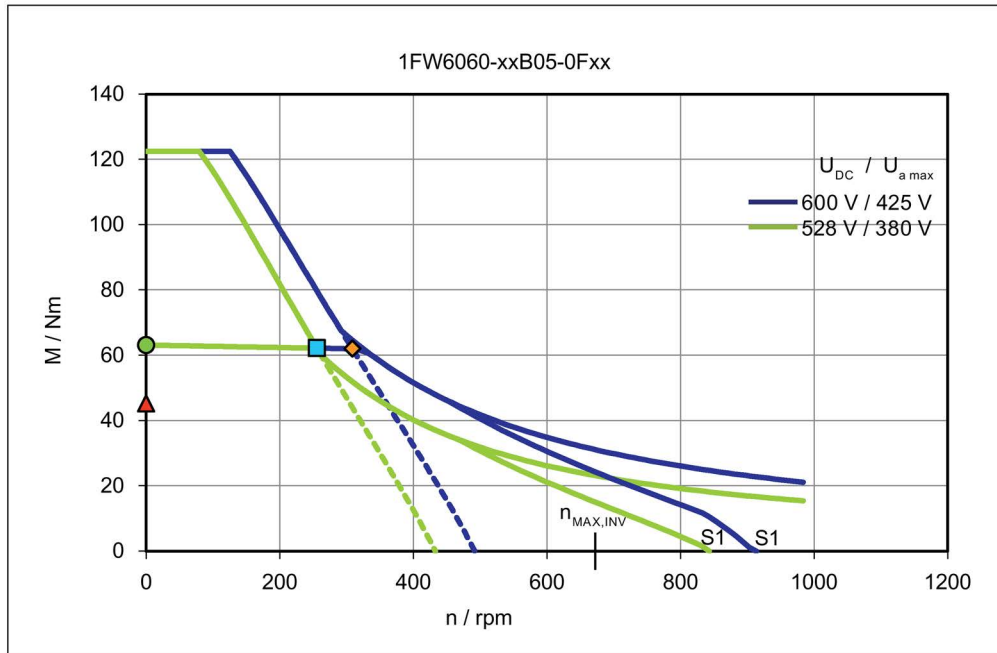

Torque M with respect to speed n

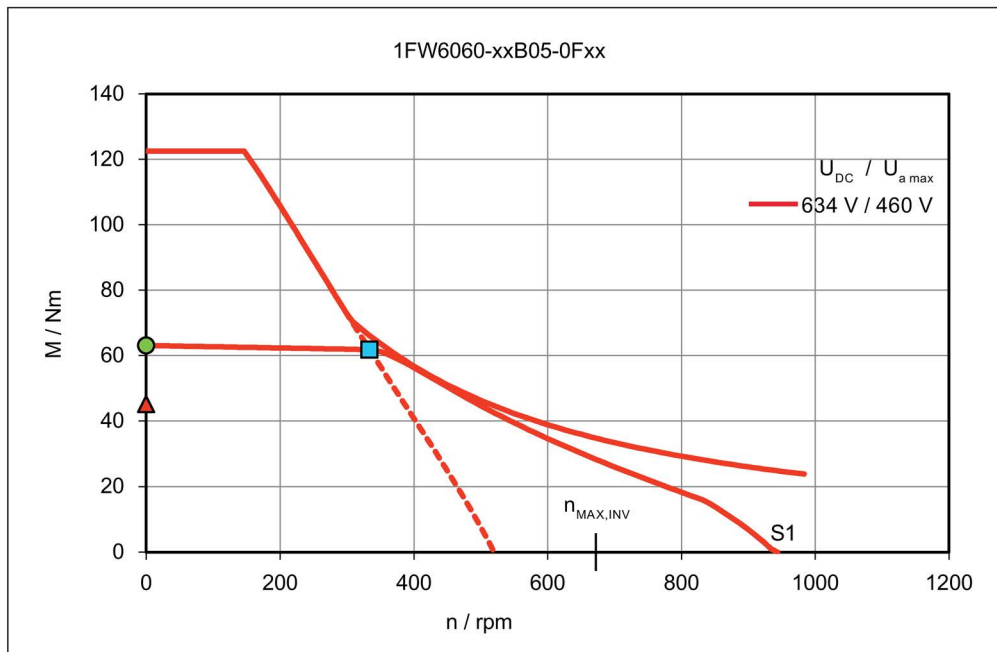

Torque M with respect to speed n

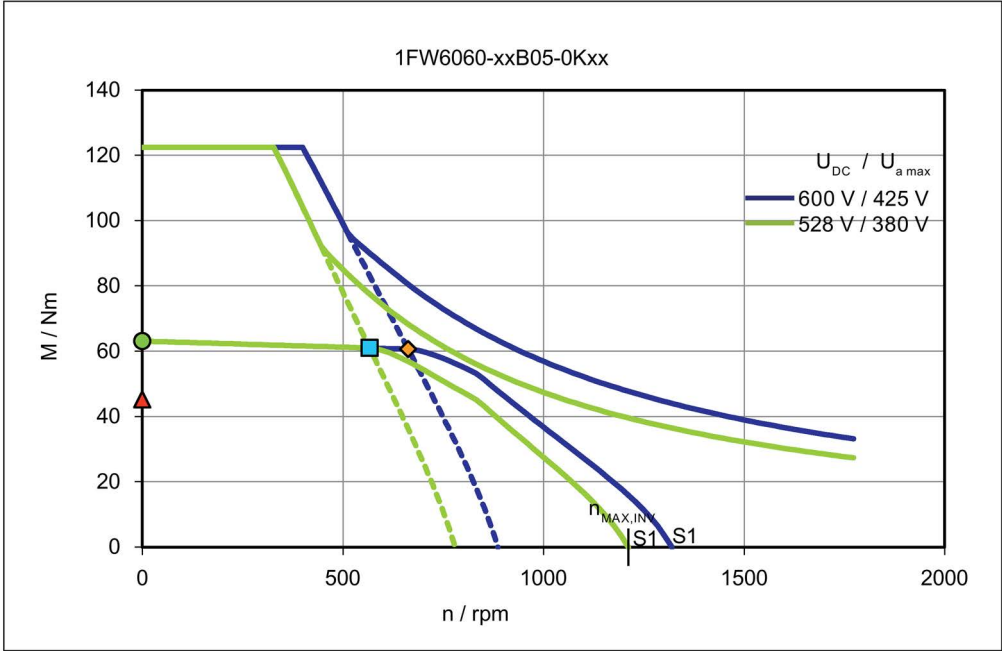

Torque M with respect to speed n

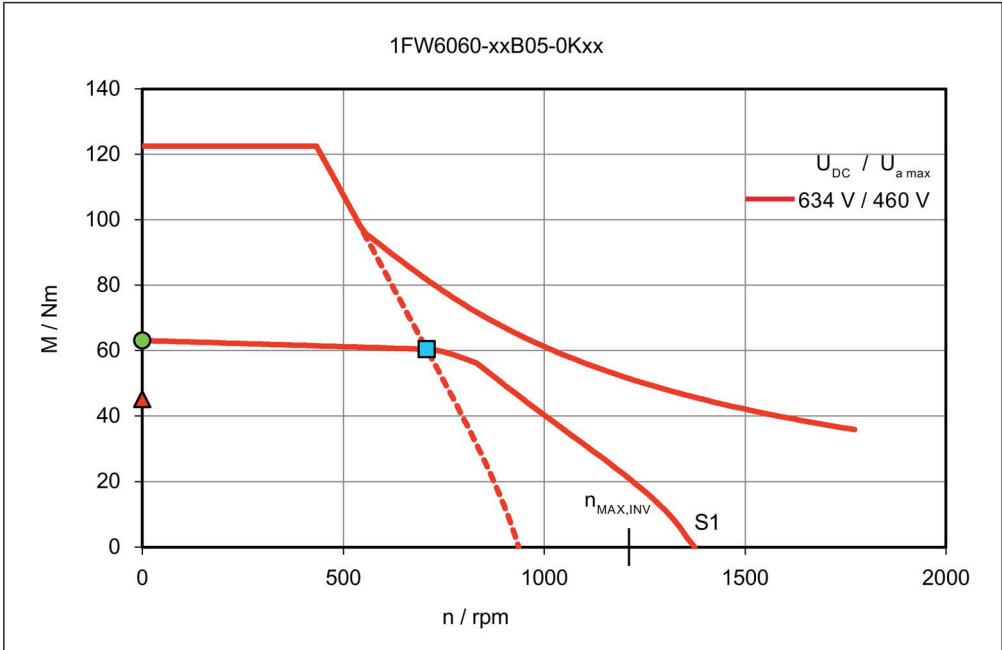

Short-circuit braking torque M_{Br} with respect to speed n

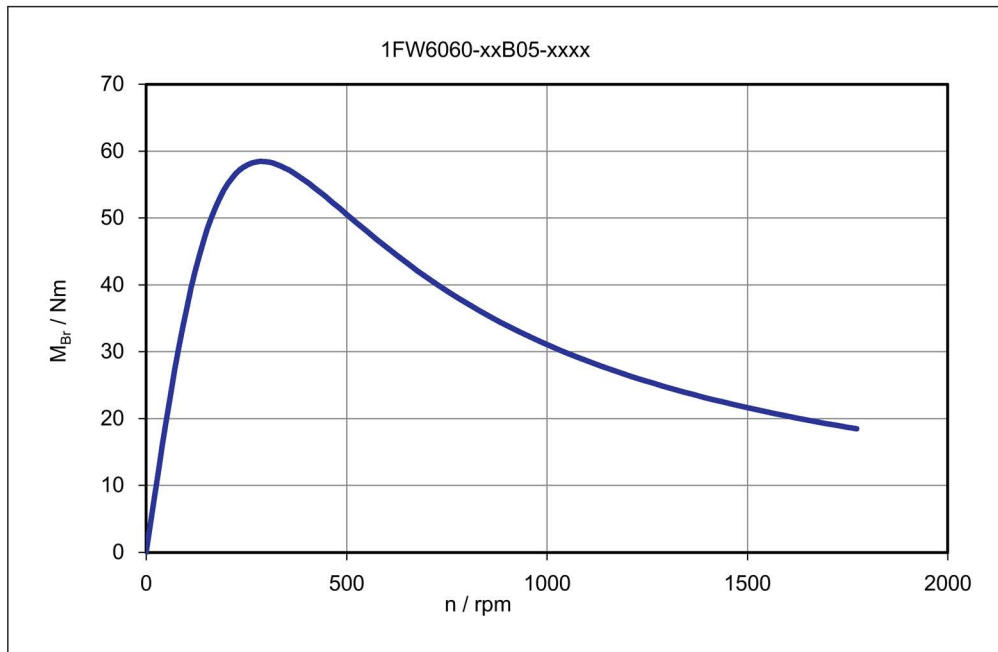

Main cooler - pressure losses Δp with respect to the volume flow \dot{V}

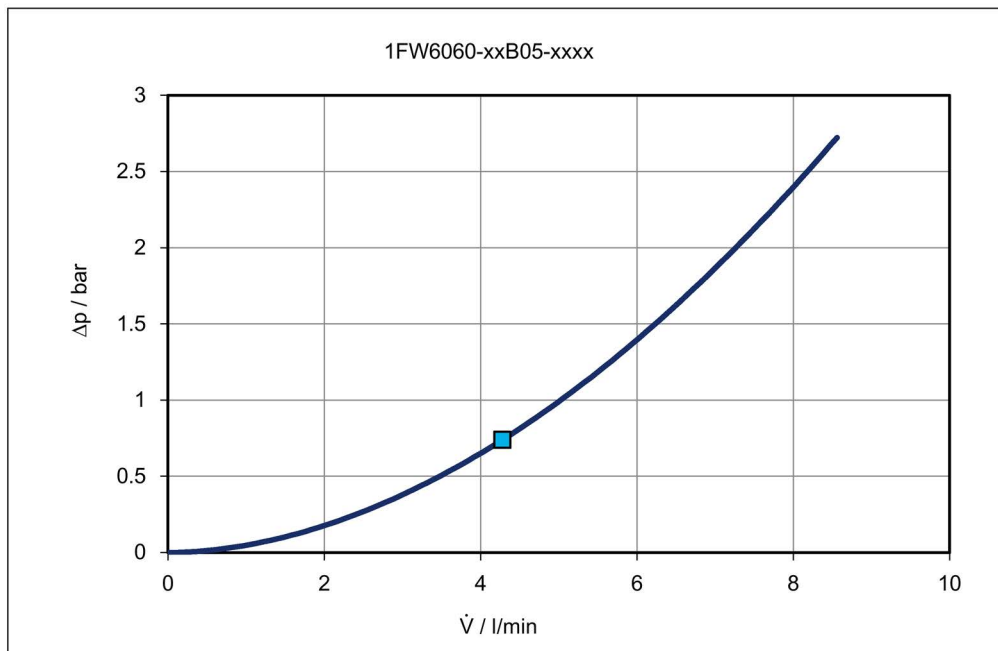

Rotor power loss P_{LV} with respect to speed n

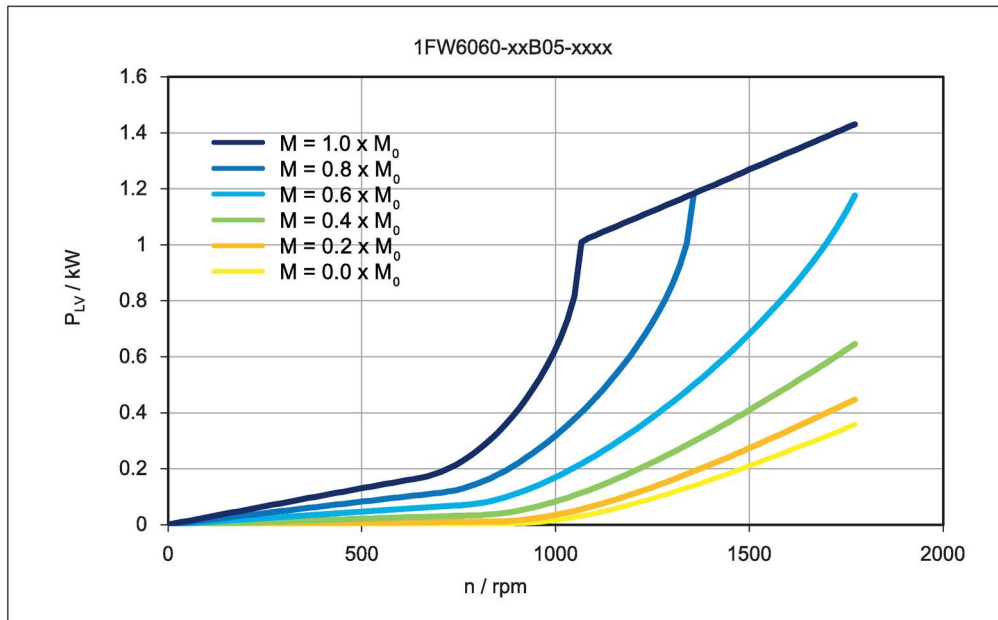

Data sheet 1FW6060-xxB07-xxxx

Table 6- 9 1FW6060-xxB07-0Fxx, 1FW6060-xxB07-0Kxx

Technical data	Symbol	Unit	-xxB07-0Fxx	-xxB07-0Kxx
1FW6060				
Boundary conditions				
DC link voltage	U_{DC}	V	600	600
Water cooling inlet temperature	T_{VORL}	°C	35	35
Rated temperature of winding	T_N	°C	130	130
Data at the rated operating point				
Rated torque	M_N	Nm	84.3	83
Rated current	I_N	A	4.45	7.9
Rated speed	n_N	rpm	203	464
Rated power loss	$P_{V,N}$	kW	1.32	1.33
Limit data				
Maximum torque	M_{MAX}	Nm	166	166
Maximum current	I_{MAX}	A	9.86	17.8
Electric motor power at M_{MAX}	$P_{EL,MAX}$	kW	7.06	10.8
Maximum speed	n_{MAX}	rpm	728	1310
Maximum speed at maximum torque	$n_{MAX,MMAX}$	rpm	43.3	256
Max. speed without VPM	$n_{MAX,INV}$	rpm	497	896
No-load speed	$n_{MAX,0}$	rpm	364	656
Torque at $n = 1$ rpm	M_0	Nm	85.4	85.4
Current at M_0 and $n = 1$ rpm	I_0	A	4.51	8.13
Thermal static torque	M_0^*	Nm	61.1	61.1
Thermal stall current	I_0^*	A	3.19	5.75
Physical constants				
Torque constant at 20 °C	$k_{T,20}$	Nm/A	19.3	10.7
Voltage constant	k_E	V/(1000/min)	1170	647
Motor constant at 20 °C	$k_{M,20}$	Nm/(W) ^{0.5}	2.87	2.85
Thermal time constant	t_{TH}	s	75	75
No. of pole pairs	p	-	15	15
Cogging torque	M_{COG}	Nm	1.19	1.19
Stator mass	m_s	kg	9.37	9.37
Rotor mass	m_L	kg	3.13	3.13
Rotor moment of inertia	J_L	10 ⁻² kgm ²	0.904	0.904
Phase resistance of winding at 20 °C	$R_{STR, 20}$	Ω	15.1	4.69
Phase inductance of winding	L_{STR}	mH	53.2	16.4

Technical data	Symbol	Unit	-xxB07-0Fxx	-xxB07-0Kxx
1FW6060				
Data for main motor cooler				
Maximum dissipated thermal power	$Q_{H,MAX}$	kW	1.1	1.11
Recommended minimum volume flow	$\dot{V}_{H,MIN}$	l/min	5.1	5.1
Cooling medium temperature increase	ΔT_H	K	3.1	3.12
Pressure drop	Δp_H	bar	1.03	1.03

Characteristics for 1FW6060-xxB07-xxxx

Torque M with respect to speed n

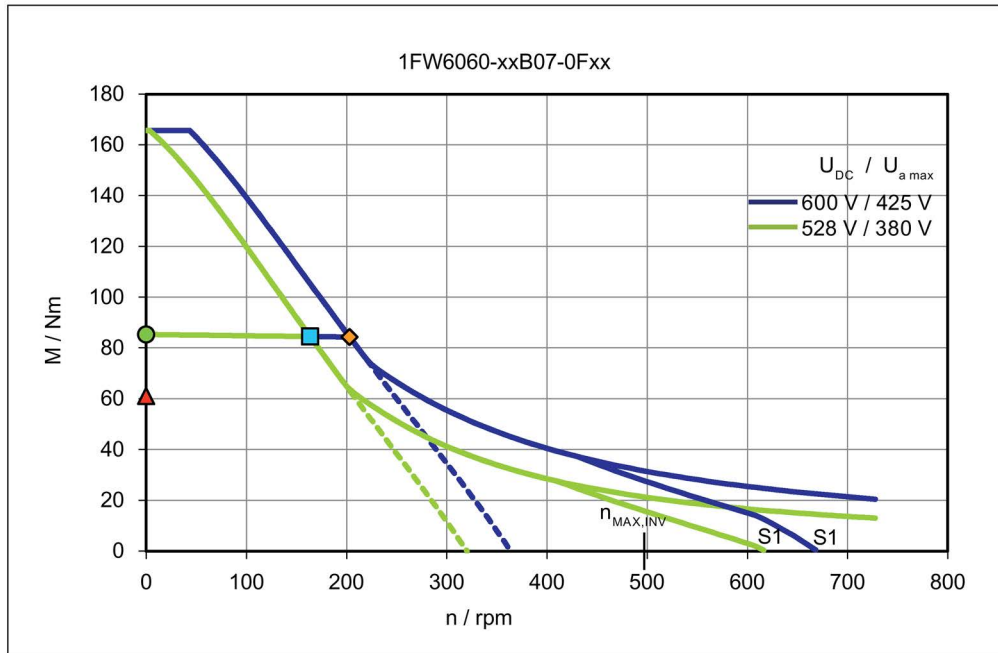

Torque M with respect to speed n

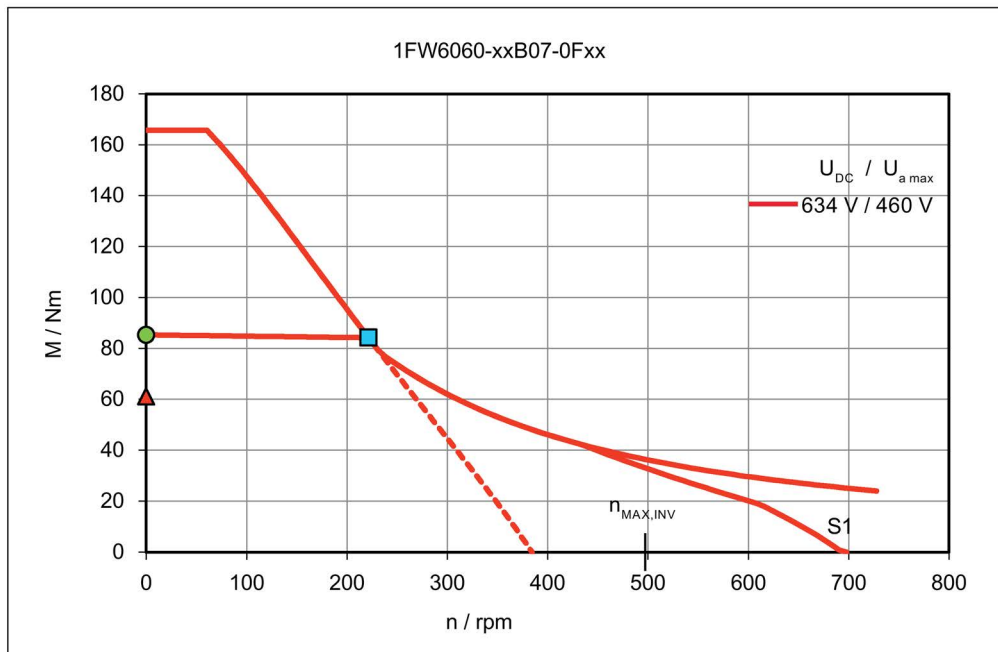

Torque M with respect to speed n

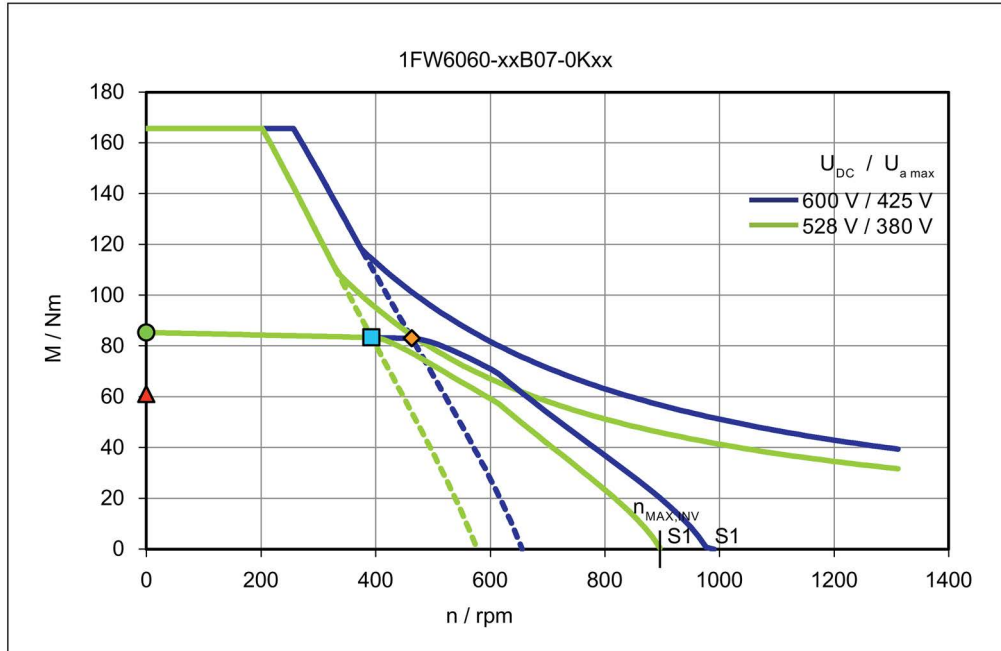

Torque M with respect to speed n

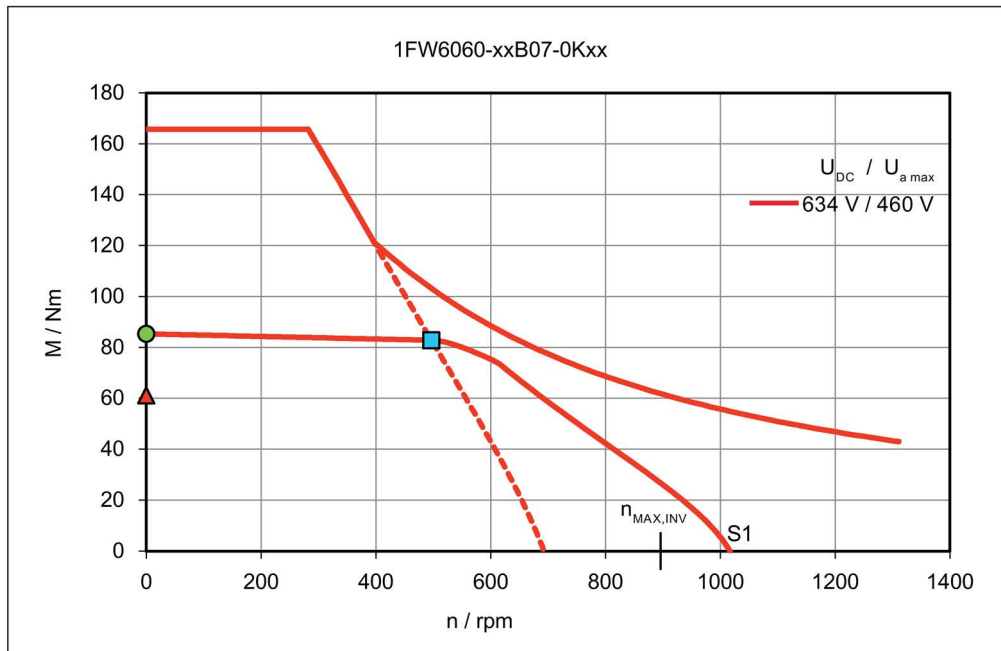

Short-circuit braking torque M_{Br} with respect to speed n

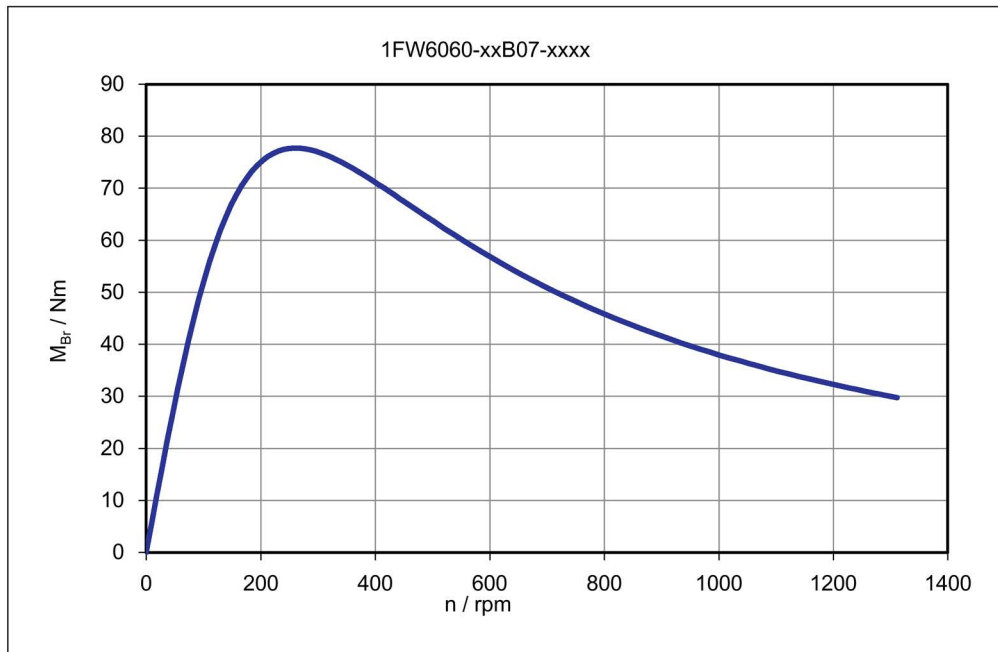

Main cooler - pressure losses Δp with respect to the volume flow \dot{V}

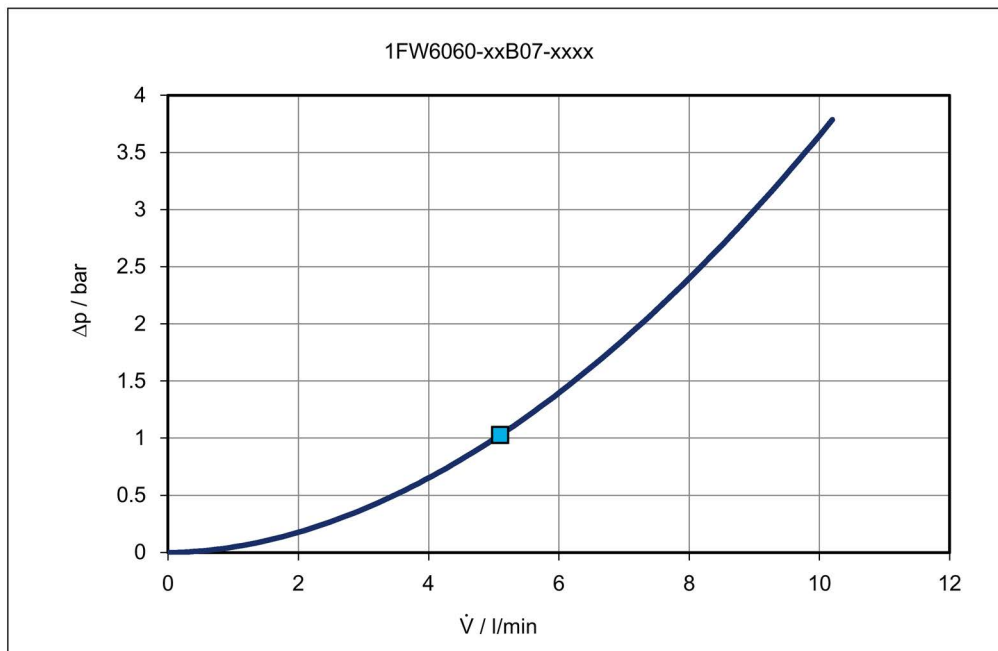

Rotor power loss P_{LV} with respect to speed n

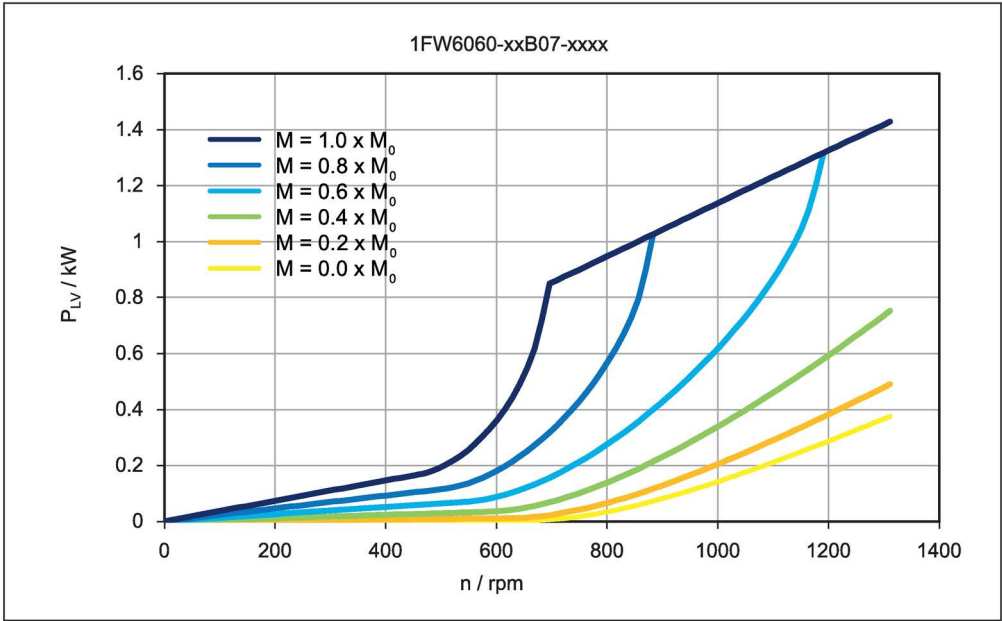

Data sheet 1FW6060-xxB10-xxxx

Table 6- 10 1FW6060-xxB10-0Kxx, 1FW6060-xxB10-1Jxx

Technical data	Symbol	Unit	-xxB10-0Kxx	-xxB10-1Jxx
1FW6060				
Boundary conditions				
DC link voltage	U_{DC}	V	600	600
Water cooling inlet temperature	T_{VORL}	°C	35	35
Rated temperature of winding	T_N	°C	130	130
Data at the rated operating point				
Rated torque	M_N	Nm	117	111
Rated current	I_N	A	7.98	14.6
Rated speed	n_N	rpm	302	708
Rated power loss	$P_{V,N}$	kW	1.79	1.86
Limit data				
Maximum torque	M_{MAX}	Nm	231	226
Maximum current	I_{MAX}	A	17.8	31.5
Electric motor power at M_{MAX}	$P_{EL,MAX}$	kW	11.8	19.1
Maximum speed	n_{MAX}	rpm	943	1830
Maximum speed at maximum torque	$n_{MAX,MMAX}$	rpm	133	471
Max. speed without VPM	$n_{MAX,INV}$	rpm	645	1250
No-load speed	$n_{MAX,0}$	rpm	472	913
Torque at $n = 1$ rpm	M_0	Nm	119	116
Current at M_0 and $n = 1$ rpm	I_0	A	8.13	15.3
Thermal static torque	M_0^*	Nm	85	82.8
Thermal stall current	I_0^*	A	5.75	10.8
Physical constants				
Torque constant at 20 °C	$k_{T,20}$	Nm/A	14.9	7.69
Voltage constant	k_E	V/(1000/min)	900	465
Motor constant at 20 °C	$k_{M,20}$	Nm/(W) ^{0.5}	3.42	3.26
Thermal time constant	t_{TH}	s	75	75
No. of pole pairs	p	-	15	15
Cogging torque	M_{COG}	Nm	1.66	1.66
Stator mass	m_s	kg	12	12
Rotor mass	m_L	kg	4.21	4.21
Rotor moment of inertia	J_L	10 ⁻² kgm ²	1.21	1.21
Phase resistance of winding at 20 °C	$R_{STR,20}$	Ω	6.3	1.85
Phase inductance of winding	L_{STR}	mH	23.1	5.42

Technical data	Symbol	Unit	-xxB10-0Kxx	-xxB10-1Jxx
1FW6060				
Data for main motor cooler				
Maximum dissipated thermal power	$Q_{H,MAX}$	kW	1.49	1.54
Recommended minimum volume flow	$\dot{V}_{H,MIN}$	l/min	6.33	6.33
Cooling medium temperature increase	ΔT_H	K	3.38	3.51
Pressure drop	Δp_H	bar	1.54	1.54

Characteristics for 1FW6060-xxB10-xxxx

Torque M with respect to speed n

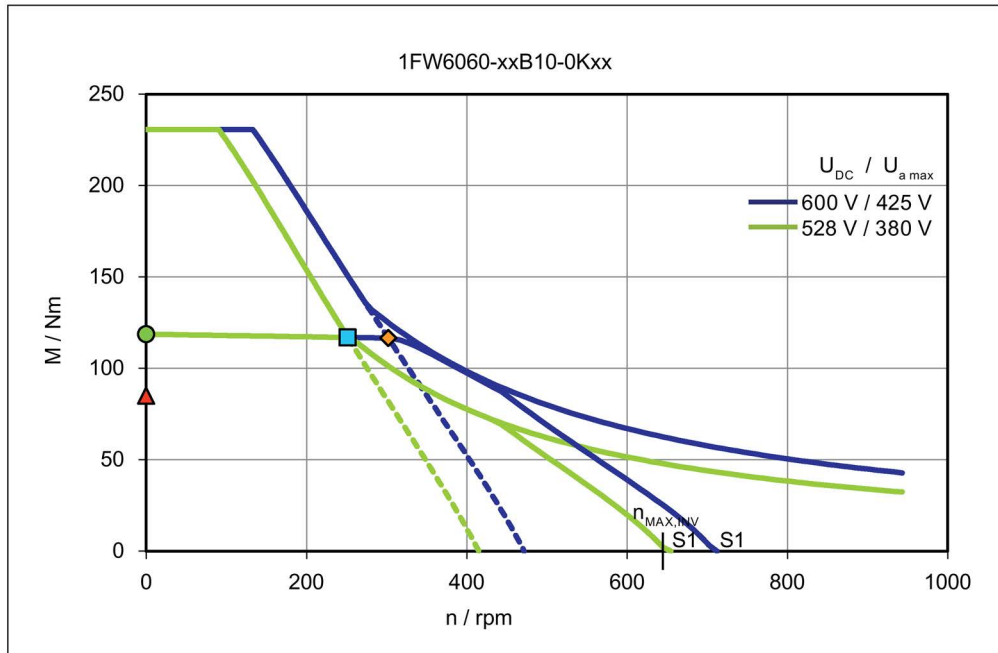

Torque M with respect to speed n

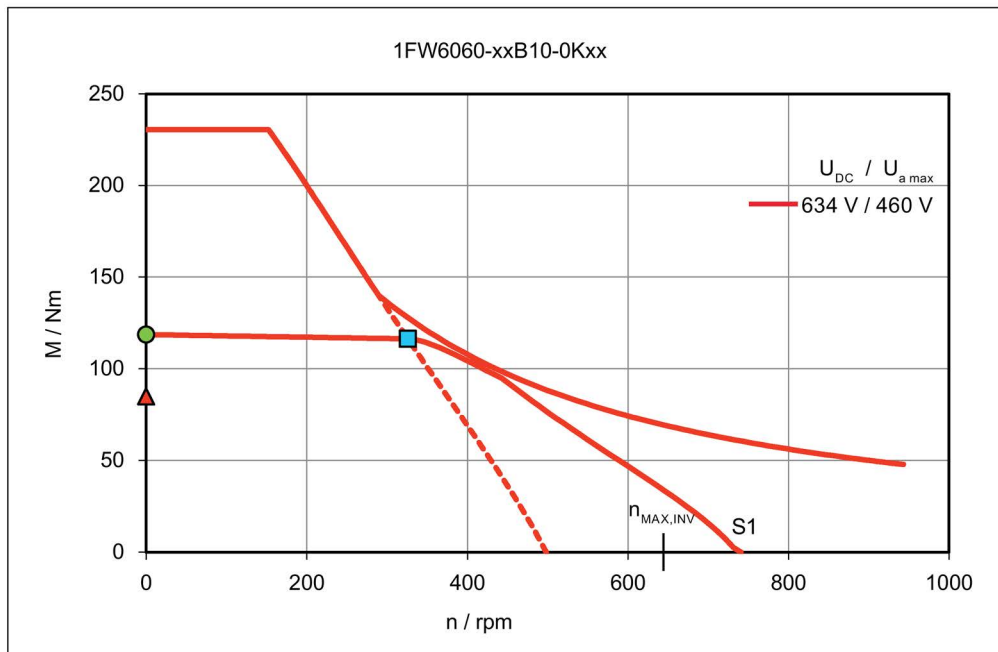

Torque M with respect to speed n

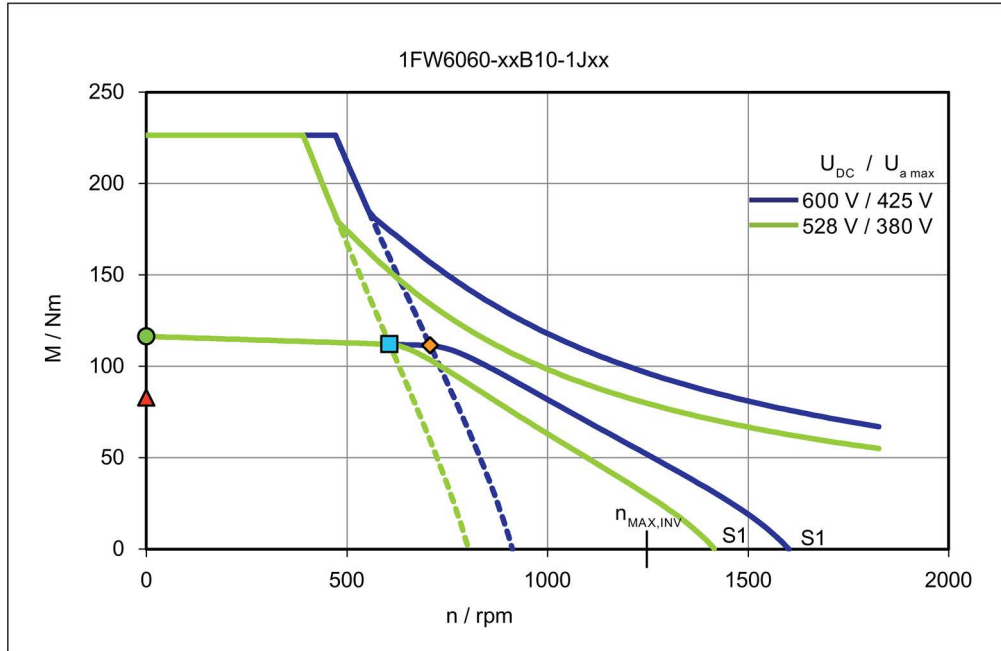

Torque M with respect to speed n

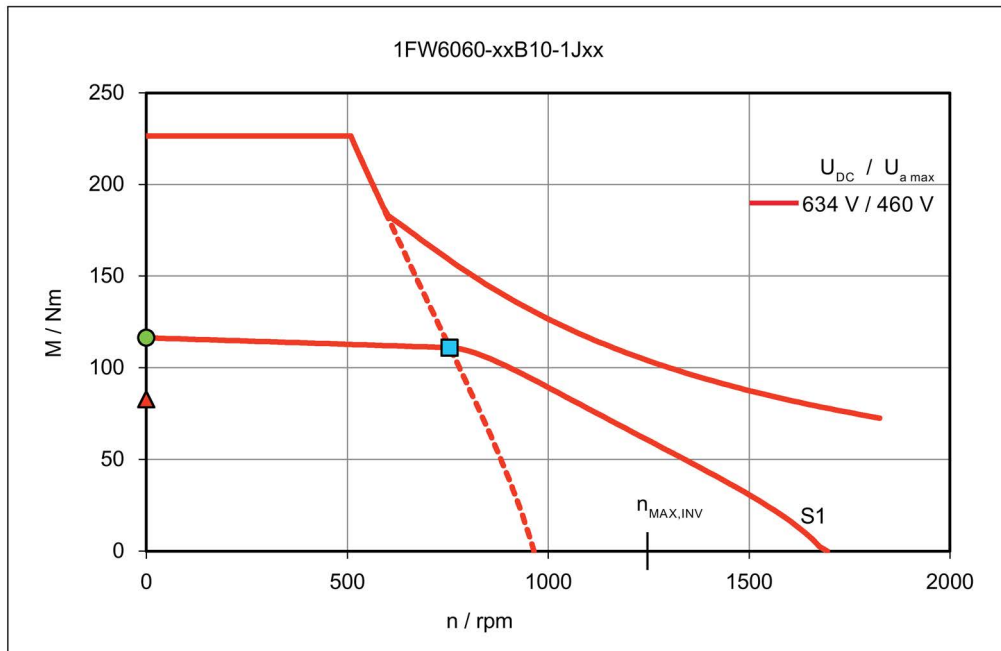

Short-circuit braking torque M_{Br} with respect to speed n

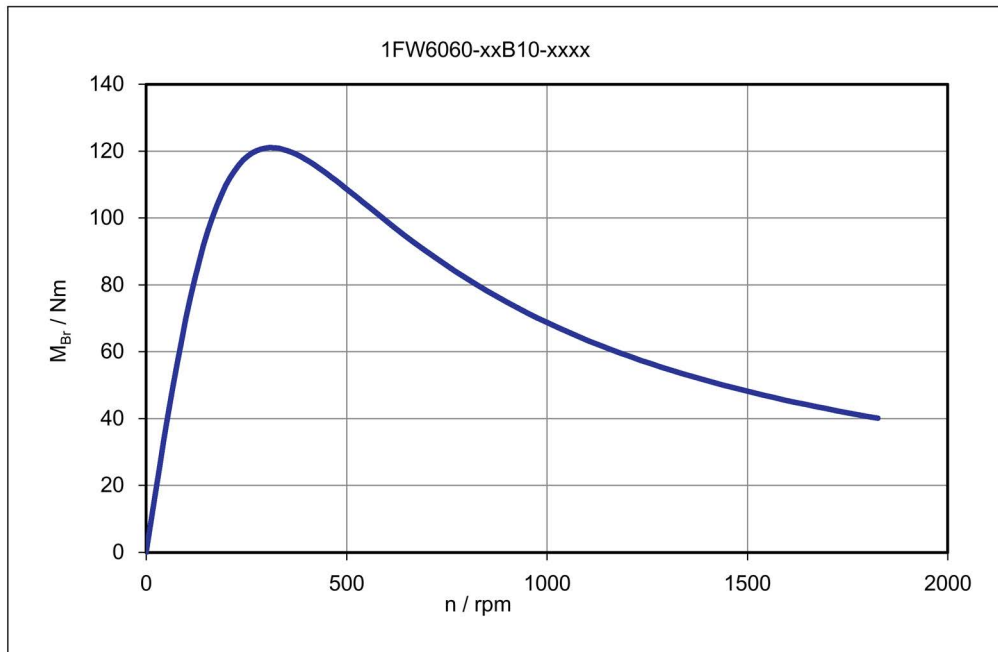

Main cooler - pressure losses Δp with respect to the volume flow \dot{V}

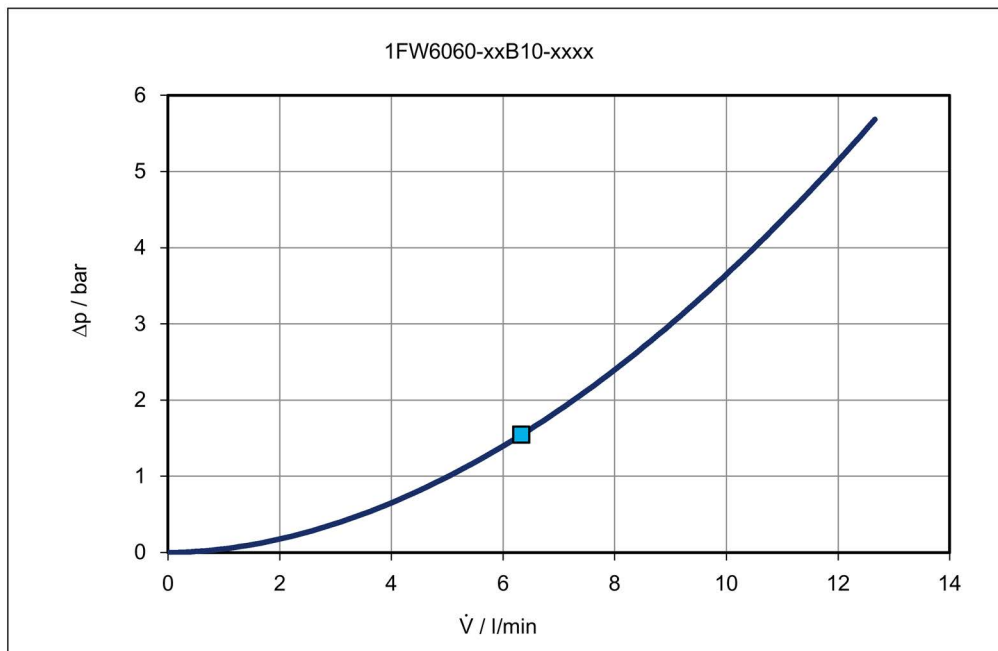

Rotor power loss P_{LV} with respect to speed n

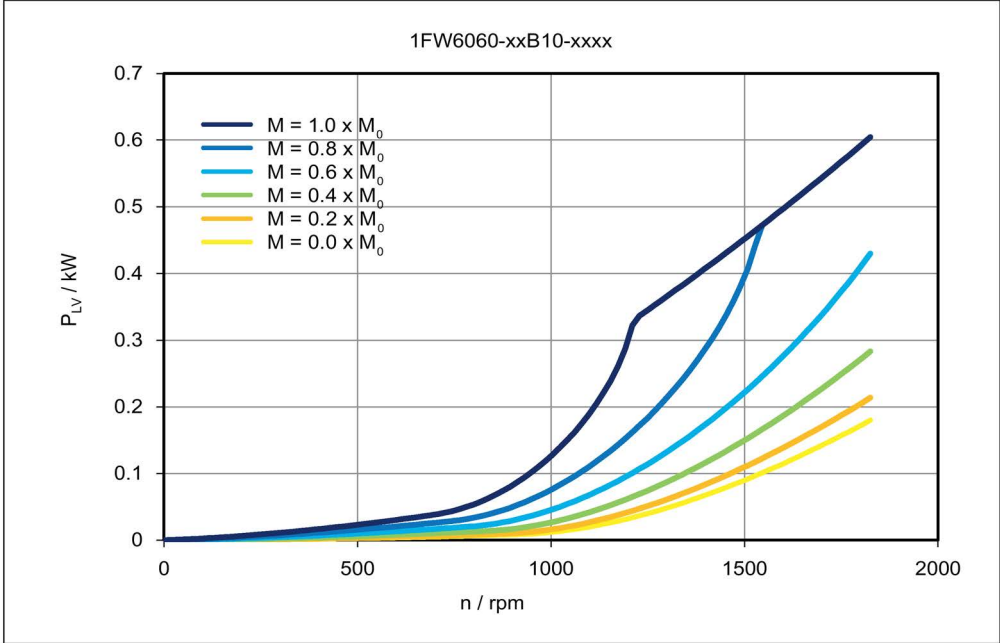

Data sheet 1FW6060-xxB15-xxxx

Table 6- 11 1FW6060-xxB15-0Kxx, 1FW6060-xxB15-1Jxx

Technical data	Symbol	Unit	-xxB15-0Kxx	-xxB15-1Jxx
1FW6060				
Boundary conditions				
DC link voltage	U_{DC}	V	600	600
Water cooling inlet temperature	T_{VORL}	°C	35	35
Rated temperature of winding	T_N	°C	130	130
Data at the rated operating point				
Rated torque	M_N	Nm	172	166
Rated current	I_N	A	8.04	14.8
Rated speed	n_N	rpm	174	442
Rated power loss	$P_{V,N}$	kW	2.48	2.65
Limit data				
Maximum torque	M_{MAX}	Nm	339	332
Maximum current	I_{MAX}	A	17.8	31.5
Electric motor power at M_{MAX}	$P_{EL,MAX}$	kW	12.9	20.3
Maximum speed	n_{MAX}	rpm	643	1240
Maximum speed at maximum torque	$n_{MAX,MMAX}$	rpm	27.6	260
Max. speed without VPM	$n_{MAX,INV}$	rpm	439	850
No-load speed	$n_{MAX,0}$	rpm	321	622
Torque at $n = 1$ rpm	M_0	Nm	174	171
Current at M_0 and $n = 1$ rpm	I_0	A	8.13	15.3
Thermal static torque	M_0^*	Nm	125	122
Thermal stall current	I_0^*	A	5.75	10.8
Physical constants				
Torque constant at 20 °C	$k_{T,20}$	Nm/A	21.8	11.3
Voltage constant	k_E	V/(1000/min)	1320	682
Motor constant at 20 °C	$k_{M,20}$	Nm/(W) ^{0.5}	4.27	4
Thermal time constant	t_{TH}	s	75	75
No. of pole pairs	p	-	15	15
Cogging torque	M_{COG}	Nm	2.44	2.44
Stator mass	m_S	kg	16.4	16.4
Rotor mass	m_L	kg	5.97	5.97
Rotor moment of inertia	J_L	10 ⁻² kgm ²	1.72	1.72
Phase resistance of winding at 20 °C	$R_{STR, 20}$	Ω	8.73	2.65
Phase inductance of winding	L_{STR}	mH	34.2	8.09

Technical data	Symbol	Unit	-xxB15-0Kxx	-xxB15-1Jxx
1FW6060				
Data for main motor cooler				
Maximum dissipated thermal power	$Q_{H,MAX}$	kW	2.06	2.21
Recommended minimum volume flow	$\dot{V}_{H,MIN}$	l/min	8.38	8.38
Cooling medium temperature increase	ΔT_H	K	3.54	3.79
Pressure drop	Δp_H	bar	2.62	2.62

Characteristics for 1FW6060-xxB15-xxxx

Torque M with respect to speed n

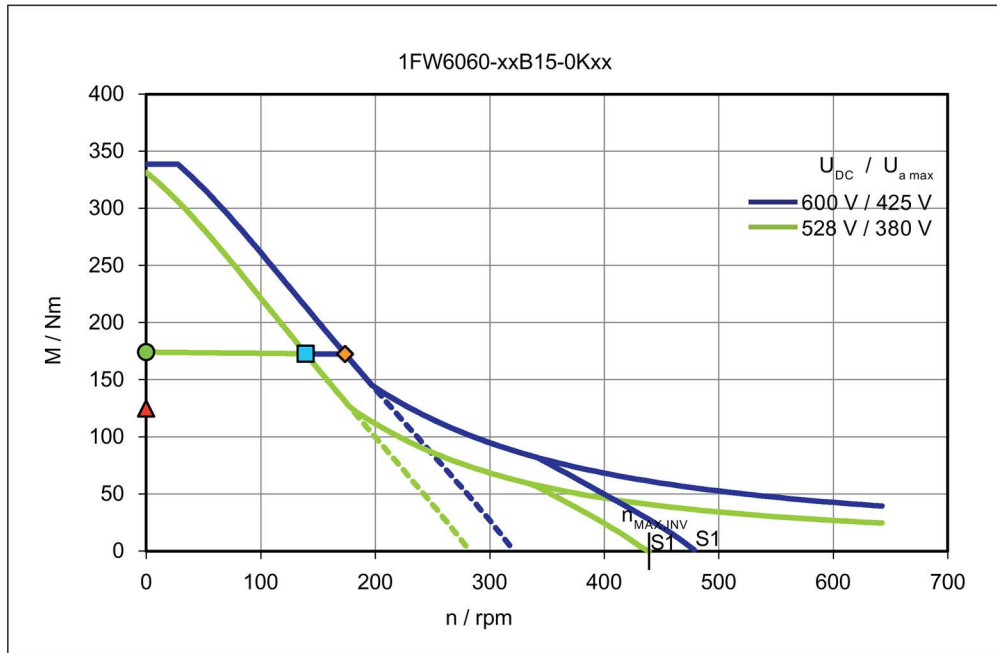

Torque M with respect to speed n

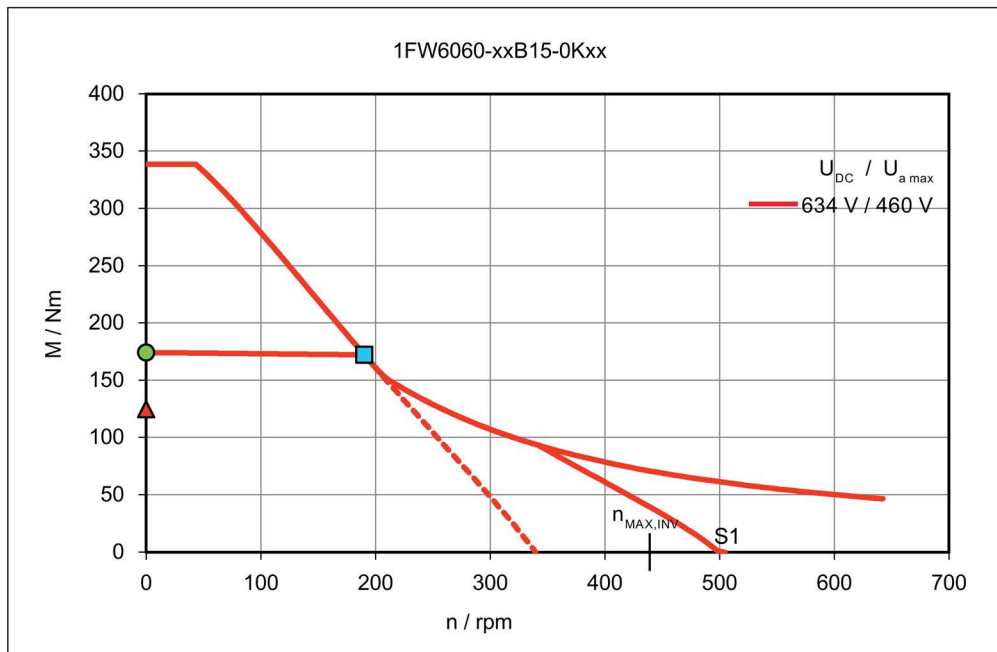

Torque M with respect to speed n

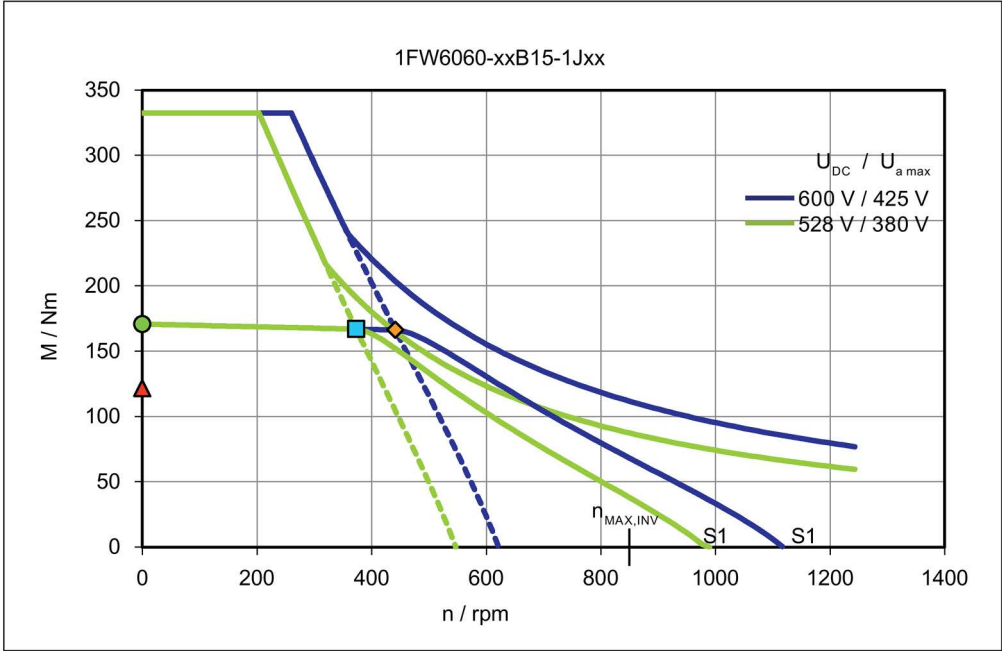

Torque M with respect to speed n

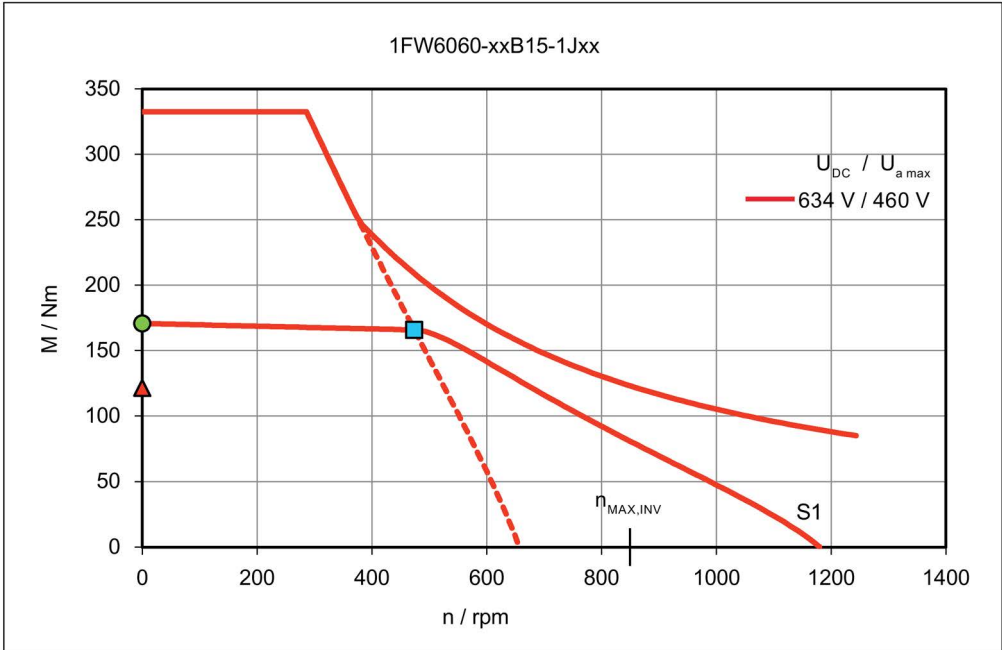

Short-circuit braking torque M_{Br} with respect to speed n

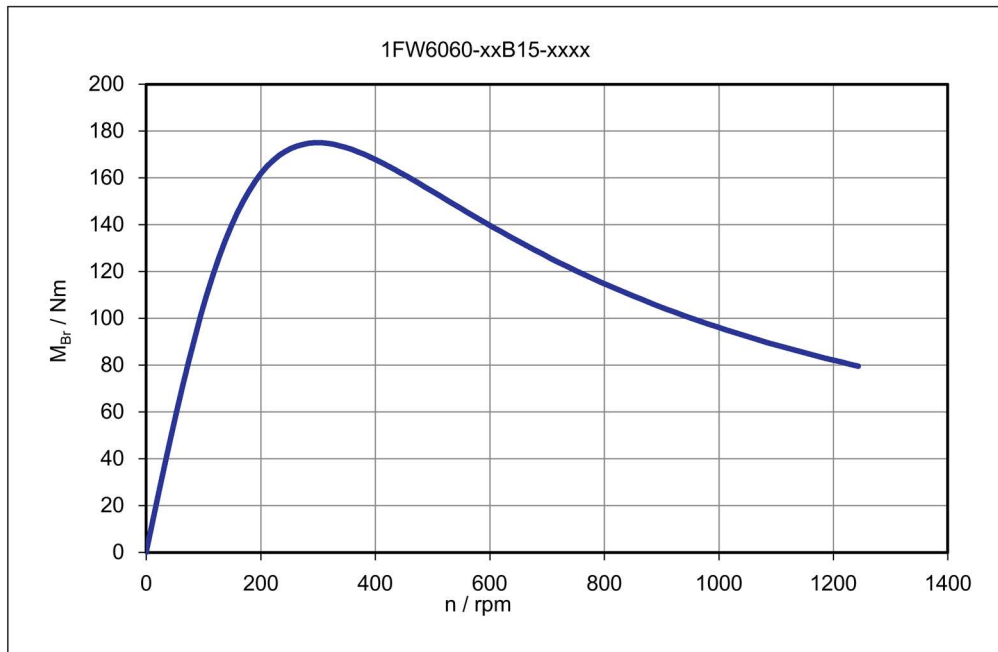

Main cooler - pressure losses Δp with respect to the volume flow \dot{V}

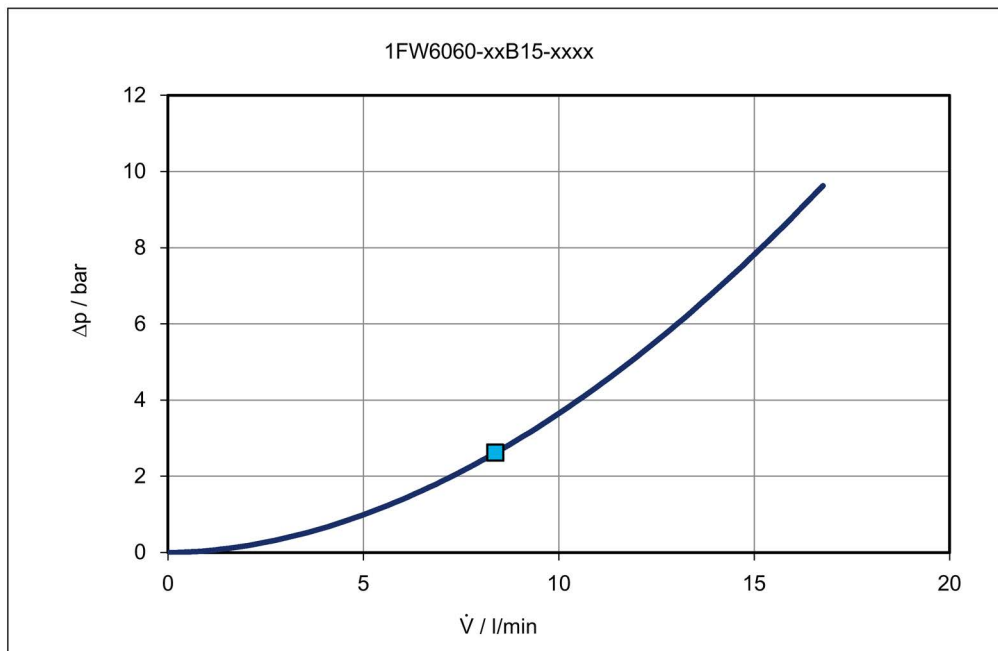

Rotor power loss P_{LV} with respect to speed n

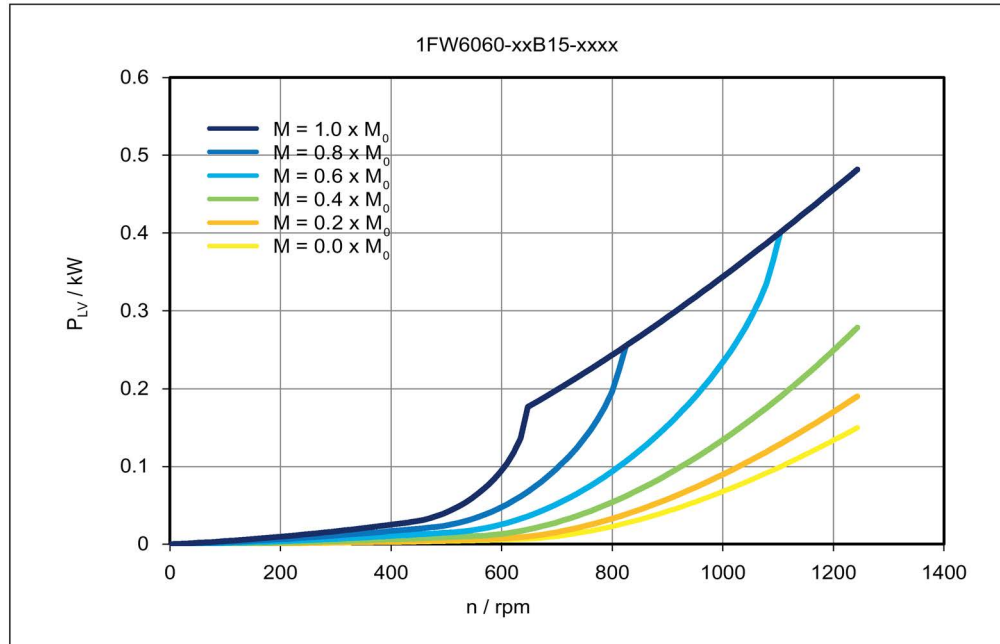

6.2.3 1FW6090-xxxxx-xxxx

Data sheet 1FW6090-xxB05-xxxx

Table 6- 12 1FW6090-xxB05-0Fxx, 1FW6090-xxB05-0Kxx

Technical data	Symbol	Unit	-xxB05-0Fxx	-xxB05-0Kxx
1FW6090				
Boundary conditions				
DC link voltage	U_{DC}	V	600	600
Water cooling inlet temperature	T_{VORL}	°C	35	35
Rated temperature of winding	T_N	°C	130	130
Data at the rated operating point				
Rated torque	M_N	Nm	113	109
Rated current	I_N	A	5.62	7.47
Rated speed	n_N	rpm	142	250
Rated power loss	$P_{V,N}$	kW	2.2	2.14
Limit data				
Maximum torque	M_{MAX}	Nm	179	179
Maximum current	I_{MAX}	A	9.55	13.3
Electric motor power at M_{MAX}	$P_{EL,MAX}$	kW	6.66	8.23
Maximum speed	n_{MAX}	rpm	620	861
Maximum speed at maximum torque	$n_{MAX,MMAX}$	rpm	50.2	142
Max. speed without VPM	$n_{MAX,INV}$	rpm	424	589
No-load speed	$n_{MAX,0}$	rpm	310	431
Torque at $n = 1$ rpm	M_0	Nm	119	119
Current at M_0 and $n = 1$ rpm	I_0	A	5.92	8.22
Thermal static torque	M_0^*	Nm	85.7	85.7
Thermal stall current	I_0^*	A	4.19	5.82
Physical constants				
Torque constant at 20 °C	$k_{T,20}$	Nm/A	20.8	15
Voltage constant	k_E	V/(1000/min)	1260	906
Motor constant at 20 °C	$k_{M,20}$	Nm/(W) ^{0.5}	3.14	3.19
Thermal time constant	t_{TH}	s	60	60
No. of pole pairs	p	-	22	22
Cogging torque	M_{COG}	Nm	1.19	1.19
Stator mass	m_S	kg	6.6	6.6
Rotor mass	m_L	kg	2.6	2.6
Rotor moment of inertia	J_L	10 ⁻² kgm ²	1.52	1.52
Phase resistance of winding at 20 °C	$R_{STR, 20}$	Ω	14.6	7.37
Phase inductance of winding	L_{STR}	mH	47.1	24.4

Technical data	Symbol	Unit	-xxB05-0Fxx	-xxB05-0Kxx
1FW6090				
Data for main motor cooler				
Maximum dissipated thermal power	$Q_{H,MAX}$	kW	1.83	1.78
Recommended minimum volume flow	$\dot{V}_{H,MIN}$	l/min	3.4	3.4
Cooling medium temperature increase	ΔT_H	K	7.74	7.54
Pressure drop	Δp_H	bar	0.168	0.168

Characteristics for 1FW6090-xxB05-xxxx

Torque M with respect to speed n

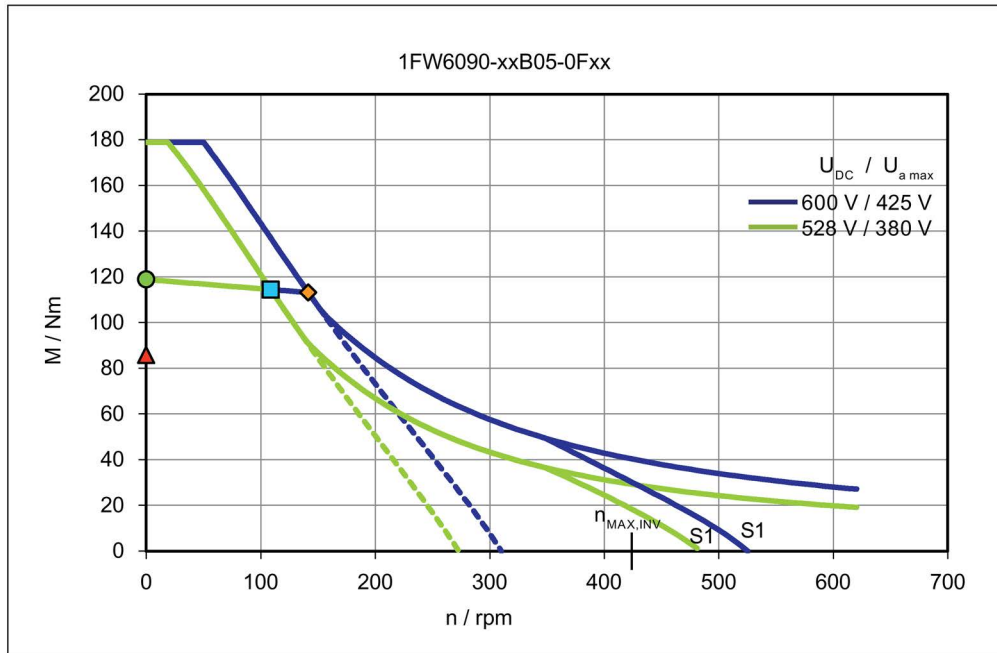

Torque M with respect to speed n

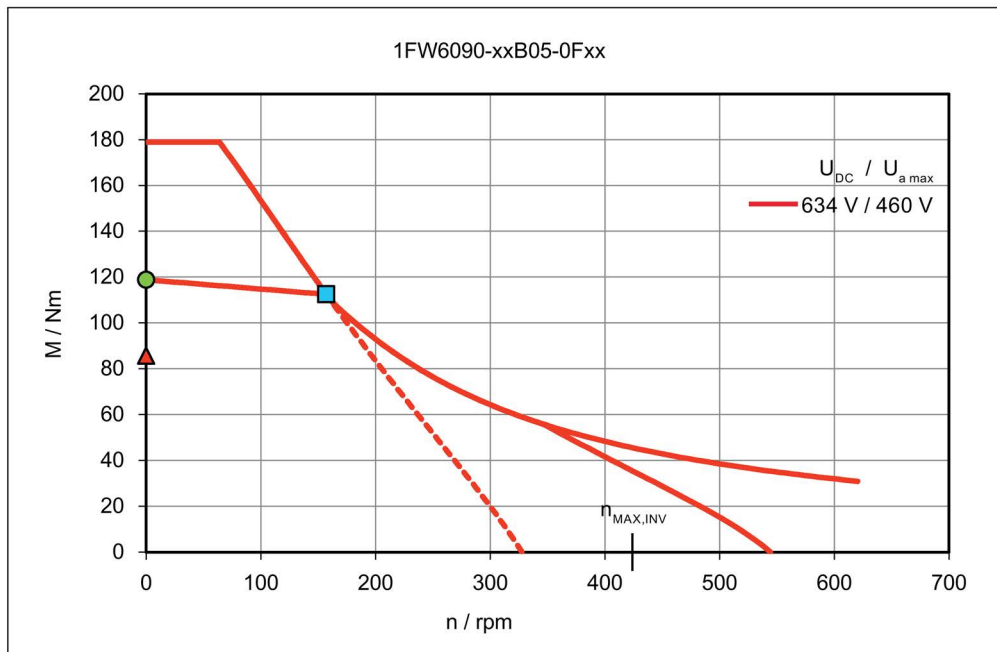

Torque M with respect to speed n

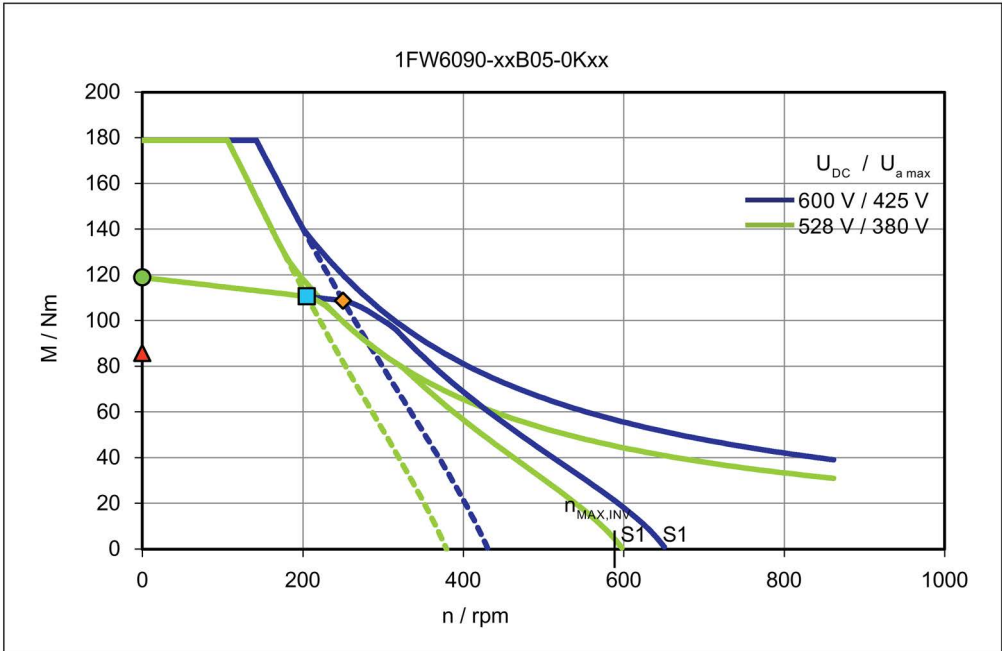

Torque M with respect to speed n

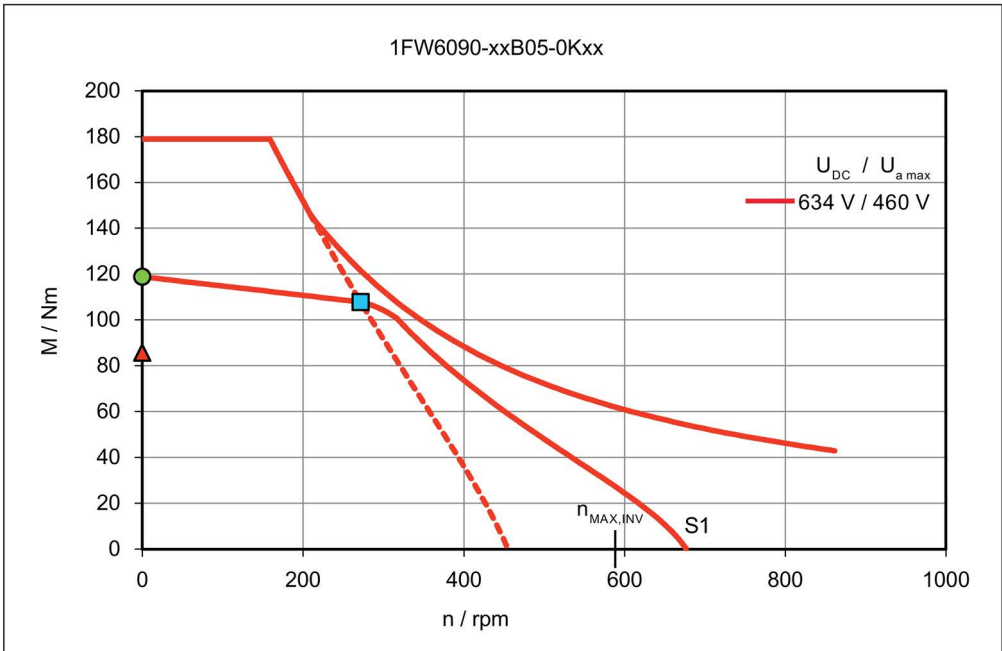

Short-circuit braking torque M_{Br} with respect to speed n

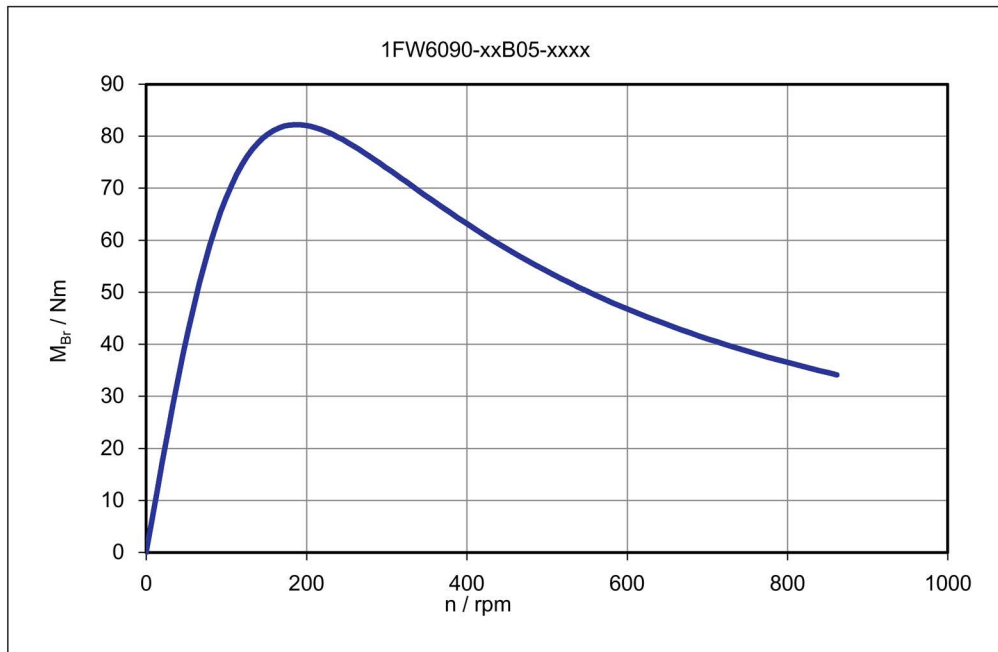

Main cooler - pressure losses Δp with respect to the volume flow \dot{V}

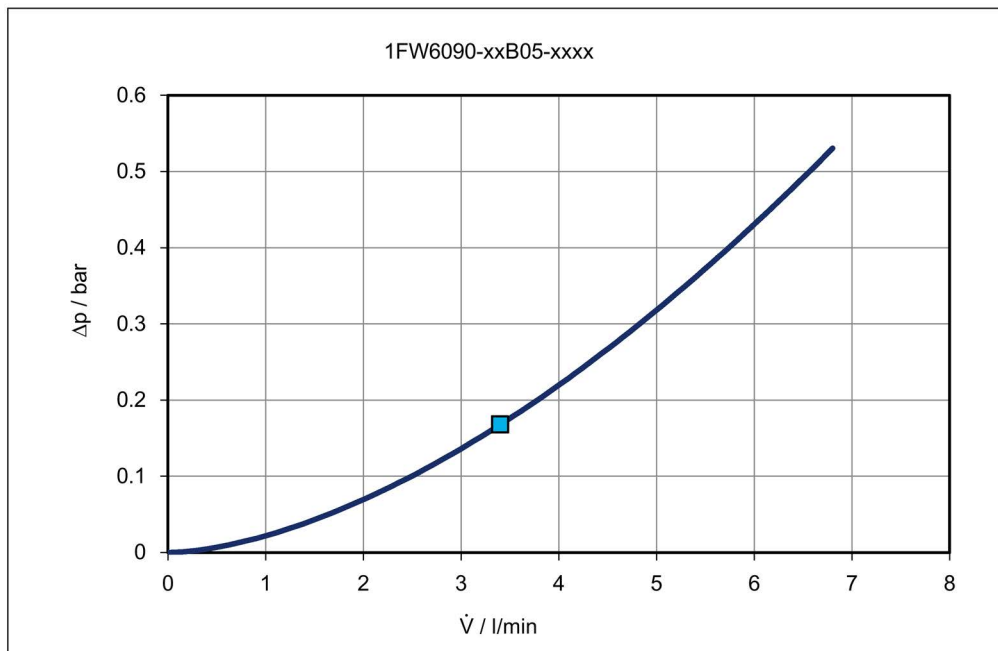

Rotor power loss P_{LV} with respect to speed n

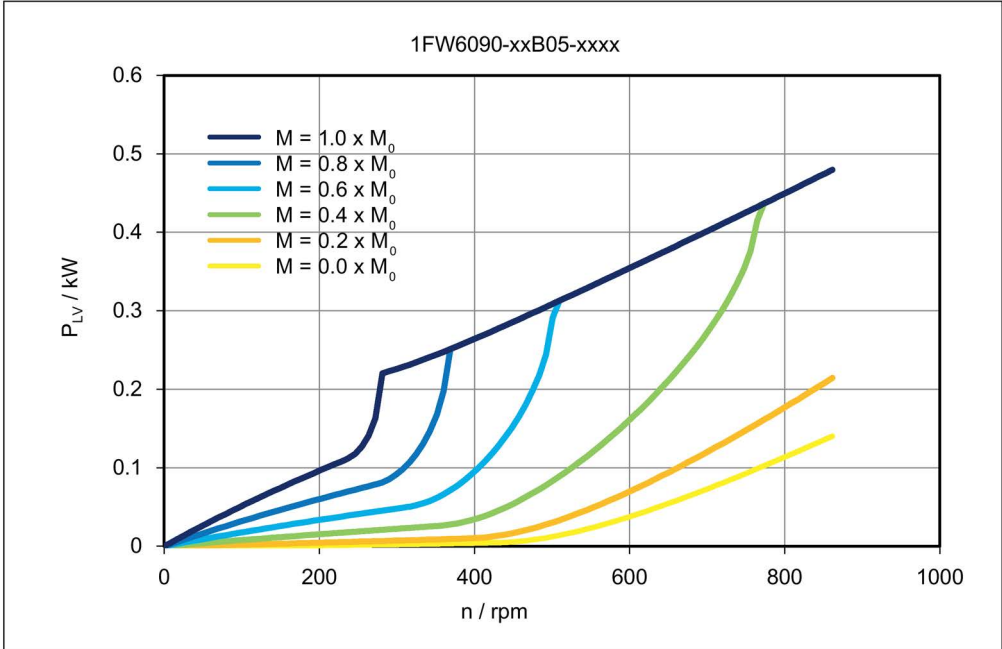

Data sheet 1FW6090-xxB07-xxxx

Table 6- 13 1FW6090-xxB07-0Kxx, 1FW6090-xxB07-1Jxx

Technical data	Symbol	Unit	-xxB07-0Kxx	-xxB07-1Jxx
1FW6090				
Boundary conditions				
DC link voltage	U_{DC}	V	600	600
Water cooling inlet temperature	T_{VORL}	°C	35	35
Rated temperature of winding	T_N	°C	130	130
Data at the rated operating point				
Rated torque	M_N	Nm	154	142
Rated current	I_N	A	9.52	13.9
Rated speed	n_N	rpm	224	428
Rated power loss	$P_{V,N}$	kW	2.72	2.69
Limit data				
Maximum torque	M_{MAX}	Nm	251	251
Maximum current	I_{MAX}	A	16.7	26.5
Electric motor power at M_{MAX}	$P_{EL,MAX}$	kW	10.4	14.3
Maximum speed	n_{MAX}	rpm	776	1230
Maximum speed at maximum torque	$n_{MAX,MMAX}$	rpm	128	278
Max. speed without VPM	$n_{MAX,INV}$	rpm	530	841
No-load speed	$n_{MAX,0}$	rpm	388	615
Torque at $n = 1$ rpm	M_0	Nm	166	166
Current at M_0 and $n = 1$ rpm	I_0	A	10.4	16.5
Thermal static torque	M_0^*	Nm	120	120
Thermal stall current	I_0^*	A	7.33	11.6
Physical constants				
Torque constant at 20 °C	$k_{T,20}$	Nm/A	16.6	10.5
Voltage constant	k_E	V/(1000/min)	1010	634
Motor constant at 20 °C	$k_{M,20}$	Nm/(W) ^{0.5}	3.96	3.98
Thermal time constant	t_{TH}	s	60	60
No. of pole pairs	p	-	22	22
Cogging torque	M_{COG}	Nm	1.66	1.66
Stator mass	m_S	kg	8.6	8.6
Rotor mass	m_L	kg	3.6	3.6
Rotor moment of inertia	J_L	10 ⁻² kgm ²	2.2	2.2
Phase resistance of winding at 20 °C	$R_{STR, 20}$	Ω	5.88	2.32
Phase inductance of winding	L_{STR}	mH	21.2	8.42

Technical data	Symbol	Unit	-xxB07-0Kxx	-xxB07-1Jxx
1FW6090				
Data for main motor cooler				
Maximum dissipated thermal power	$Q_{H,MAX}$	kW	2.26	2.24
Recommended minimum volume flow	$\dot{V}_{H,MIN}$	l/min	4.1	4.1
Cooling medium temperature increase	ΔT_H	K	7.93	7.87
Pressure drop	Δp_H	bar	0.229	0.229

Characteristics for 1FW6090-xxB07-xxxx

Torque M with respect to speed n

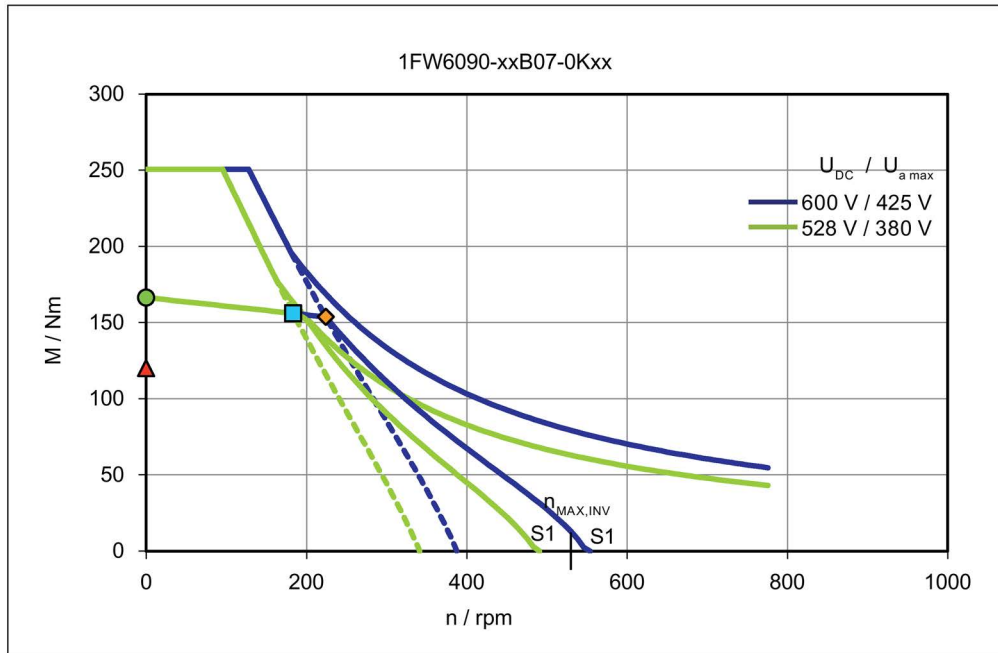

Torque M with respect to speed n

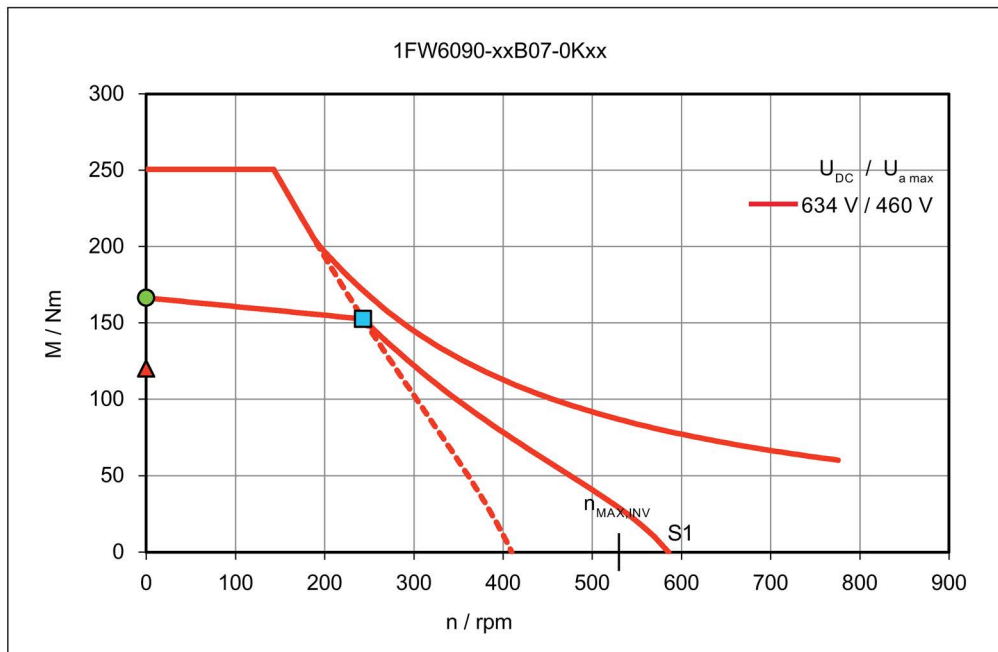

Torque M with respect to speed n

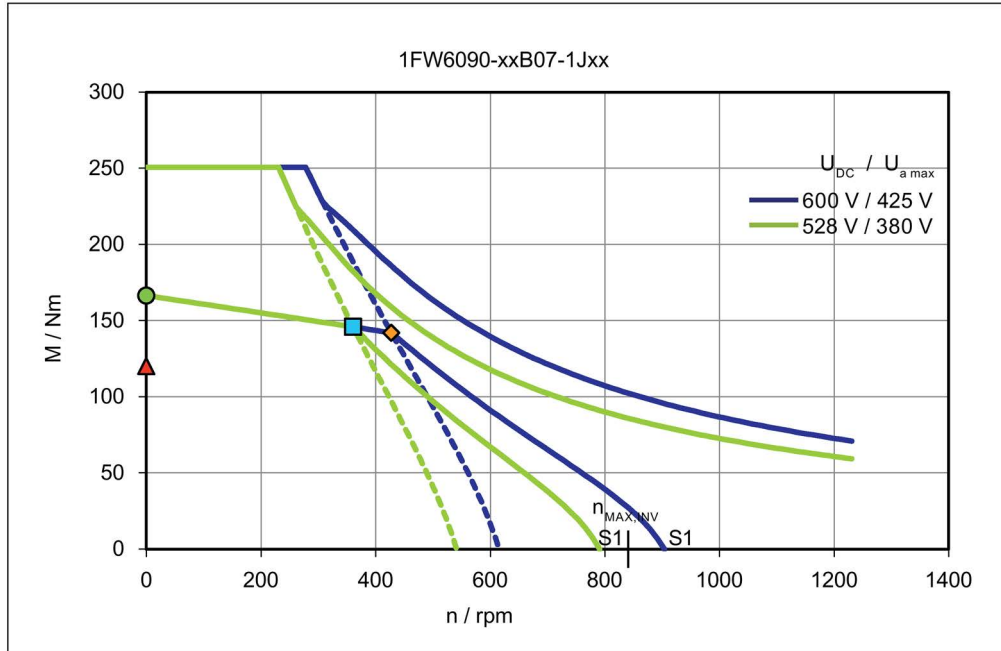

Torque M with respect to speed n

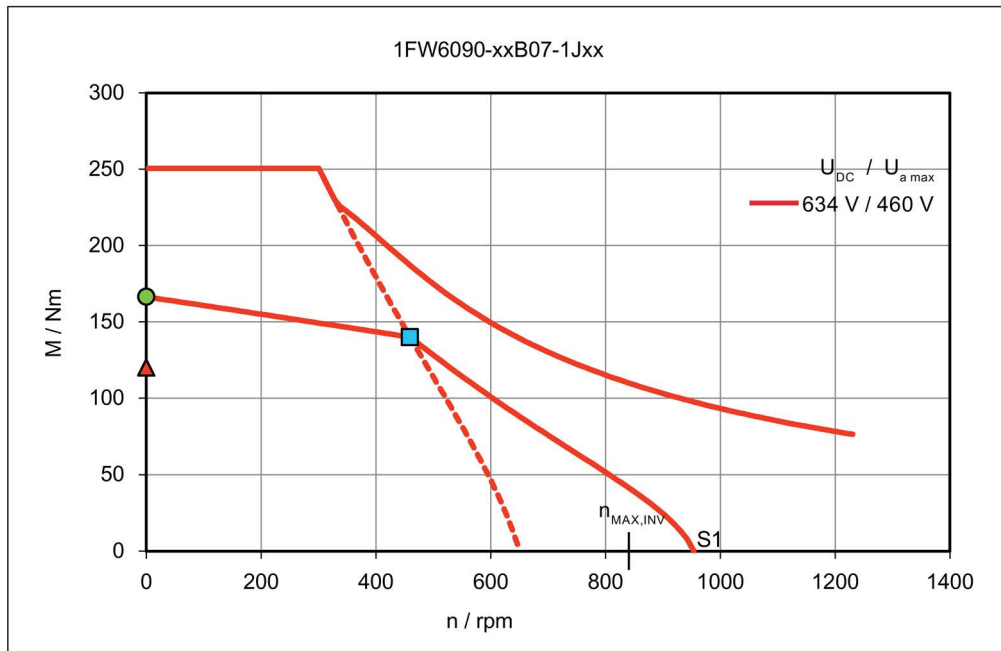

Short-circuit braking torque M_{Br} with respect to speed n

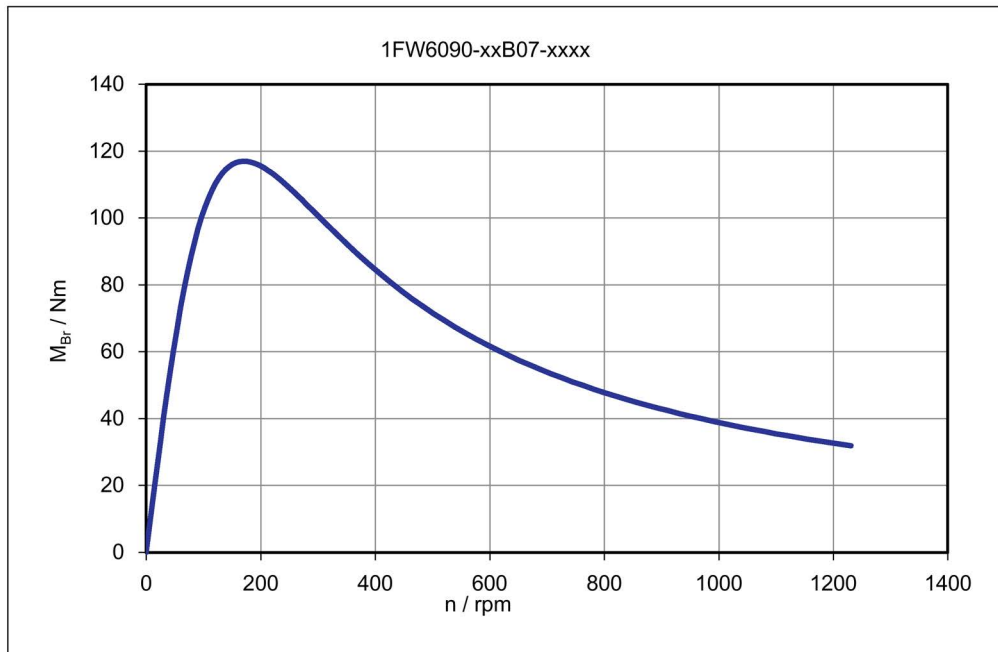

Main cooler - pressure losses Δp with respect to the volume flow rate \dot{V}

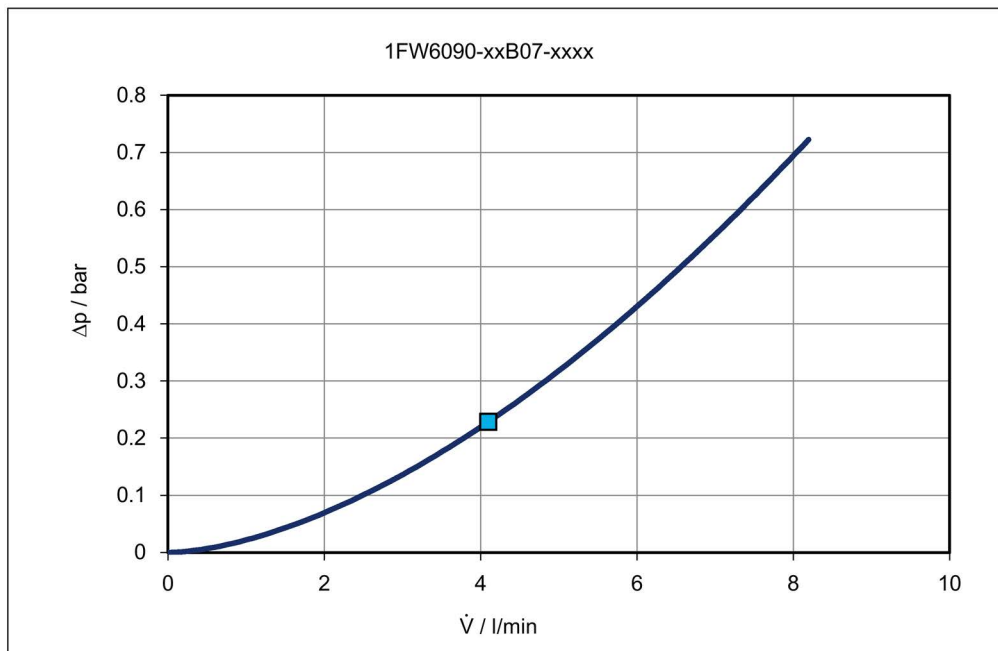

Rotor power loss P_{LV} with respect to speed n

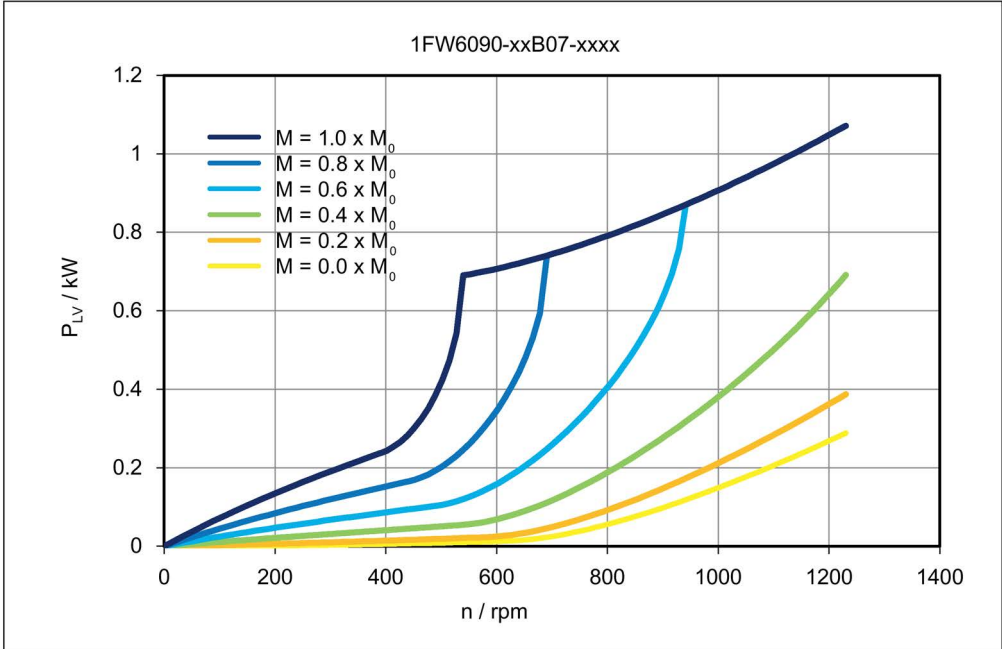

Data sheet 1FW6090-xxB10-xxxx

Table 6- 14 1FW6090-xxB10-0Kxx, 1FW6090-xxB10-1Jxx

Technical data	Symbol	Unit	-xxB10-0Kxx	-xxB10-1Jxx
1FW6090				
Boundary conditions				
DC link voltage	U_{DC}	V	600	600
Water cooling inlet temperature	T_{VORL}	°C	35	35
Rated temperature of winding	T_N	°C	130	130
Data at the rated operating point				
Rated torque	M_N	Nm	231	216
Rated current	I_N	A	7.97	14.8
Rated speed	n_N	rpm	83.9	272
Rated power loss	$P_{V,N}$	kW	3.52	3.52
Limit data				
Maximum torque	M_{MAX}	Nm	358	358
Maximum current	I_{MAX}	A	13.3	26.6
Electric motor power at M_{MAX}	$P_{EL,MAX}$	kW	9.64	15.5
Maximum speed	n_{MAX}	rpm	431	861
Maximum speed at maximum torque	$n_{MAX,MMAX}$	rpm	12.4	170
Max. speed without VPM	$n_{MAX,INV}$	rpm	294	589
No-load speed	$n_{MAX,0}$	rpm	215	431
Torque at $n = 1$ rpm	M_0	Nm	238	238
Current at M_0 and $n = 1$ rpm	I_0	A	8.23	16.5
Thermal static torque	M_0^*	Nm	172	172
Thermal stall current	I_0^*	A	5.82	11.6
Physical constants				
Torque constant at 20 °C	$k_{T,20}$	Nm/A	30	15
Voltage constant	k_E	V/(1000/min)	1810	906
Motor constant at 20 °C	$k_{M,20}$	Nm/(W) ^{0.5}	4.97	4.97
Thermal time constant	t_{TH}	s	60	60
No. of pole pairs	p	-	22	22
Cogging torque	M_{COG}	Nm	2.38	2.38
Stator mass	m_S	kg	12.1	12.1
Rotor mass	m_L	kg	5.1	5.1
Rotor moment of inertia	J_L	10 ⁻² kgm ²	3.09	3.09
Phase resistance of winding at 20 °C	$R_{STR,20}$	Ω	12.1	3.03
Phase inductance of winding	L_{STR}	mH	47.5	11.9

Technical data	Symbol	Unit	-xxB10-0Kxx	-xxB10-1Jxx
1FW6090				
Data for main motor cooler				
Maximum dissipated thermal power	$Q_{H,MAX}$	kW	2.93	2.93
Recommended minimum volume flow	$\dot{V}_{H,MIN}$	l/min	5.4	5.4
Cooling medium temperature increase	ΔT_H	K	7.8	7.8
Pressure drop	Δp_H	bar	0.362	0.362

Characteristics for 1FW6090-xxB10-xxxx

Torque M with respect to speed n

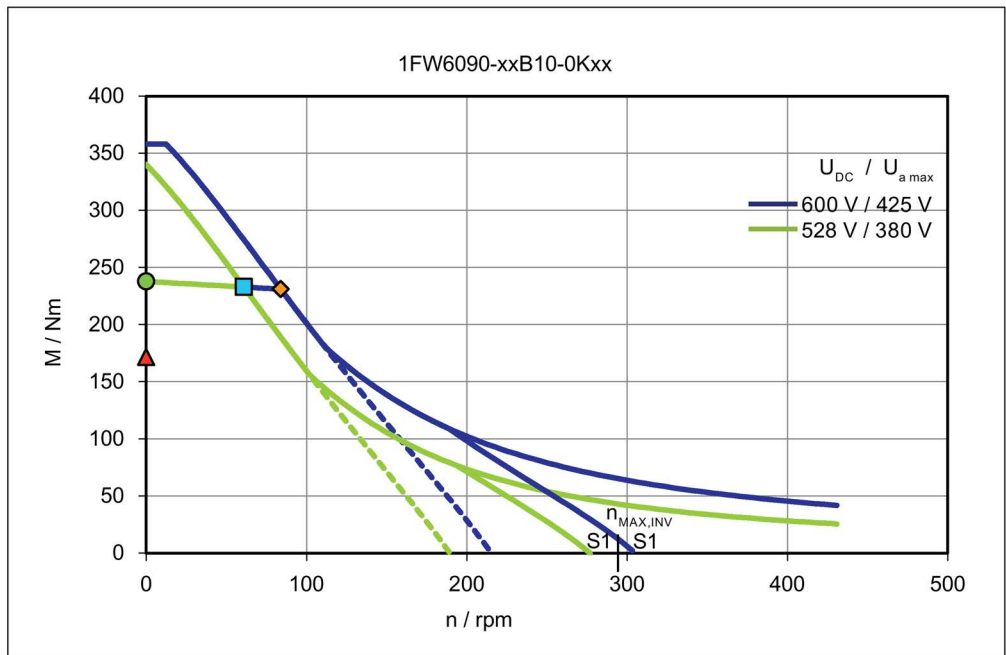

Torque M with respect to speed n

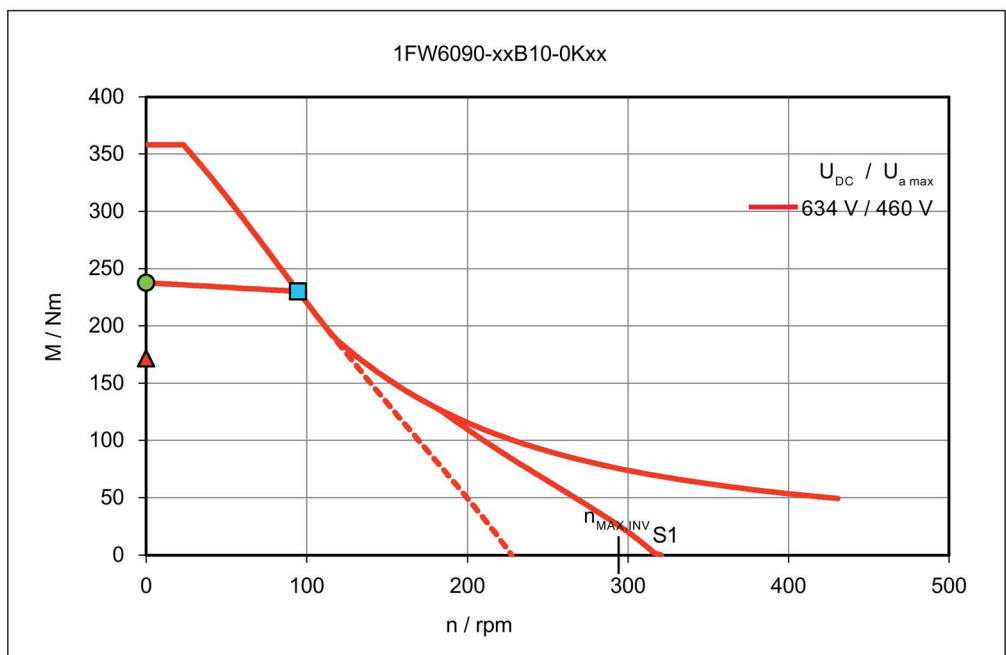

Torque M with respect to speed n

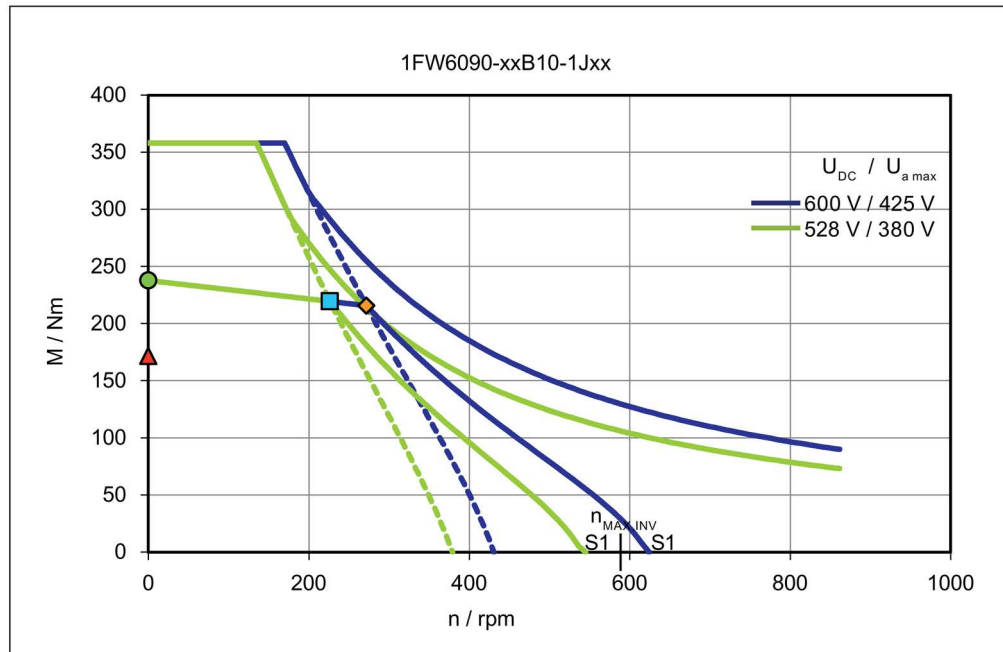

Torque M with respect to speed n

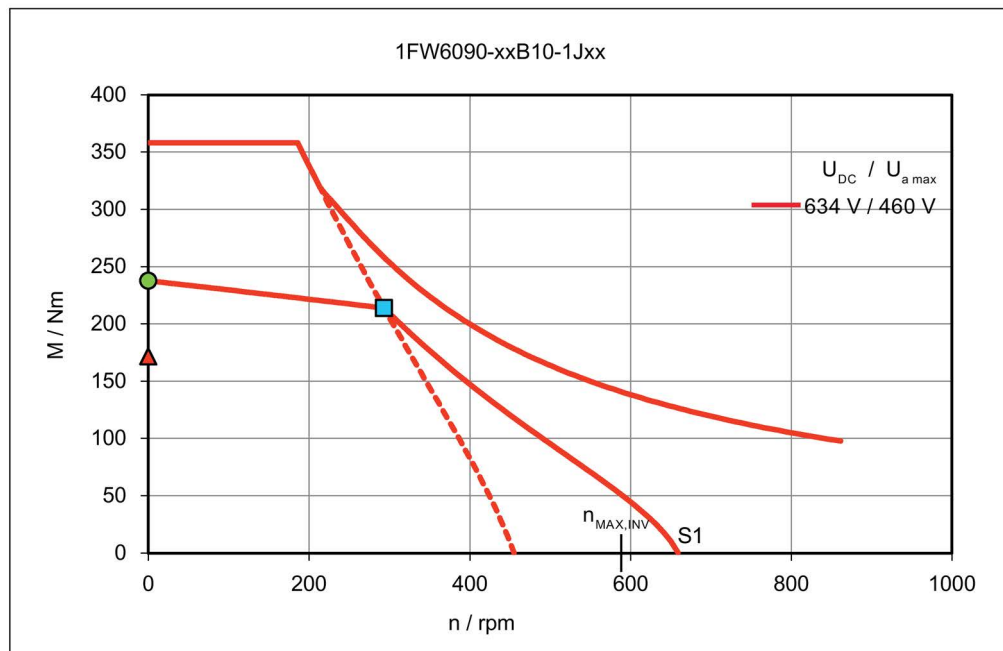

Short-circuit braking torque M_{Br} with respect to speed n

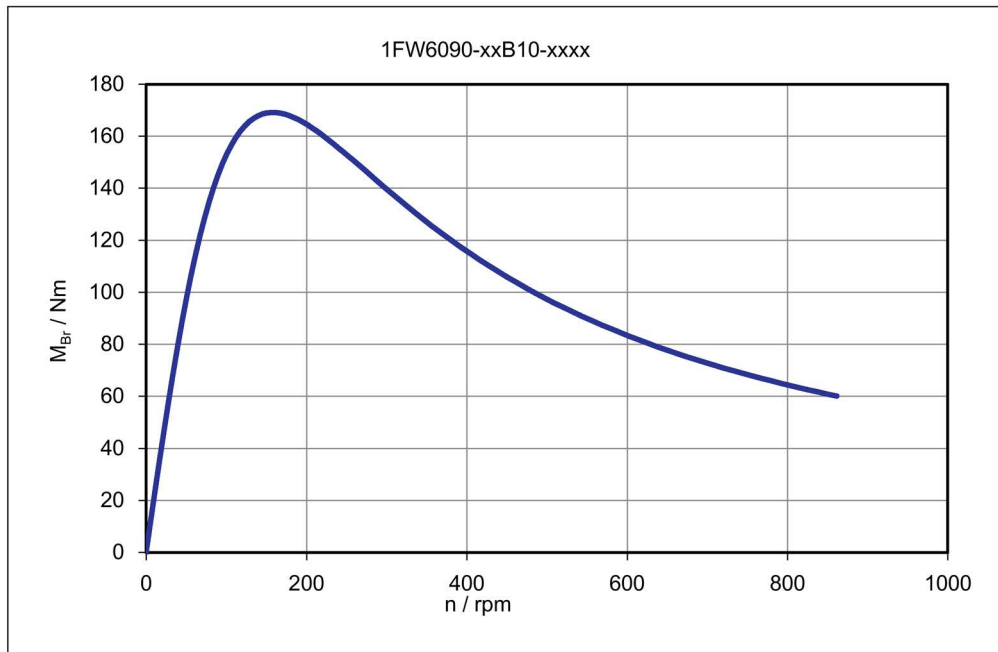

Main cooler - pressure losses Δp with respect to the volume flow \dot{V}

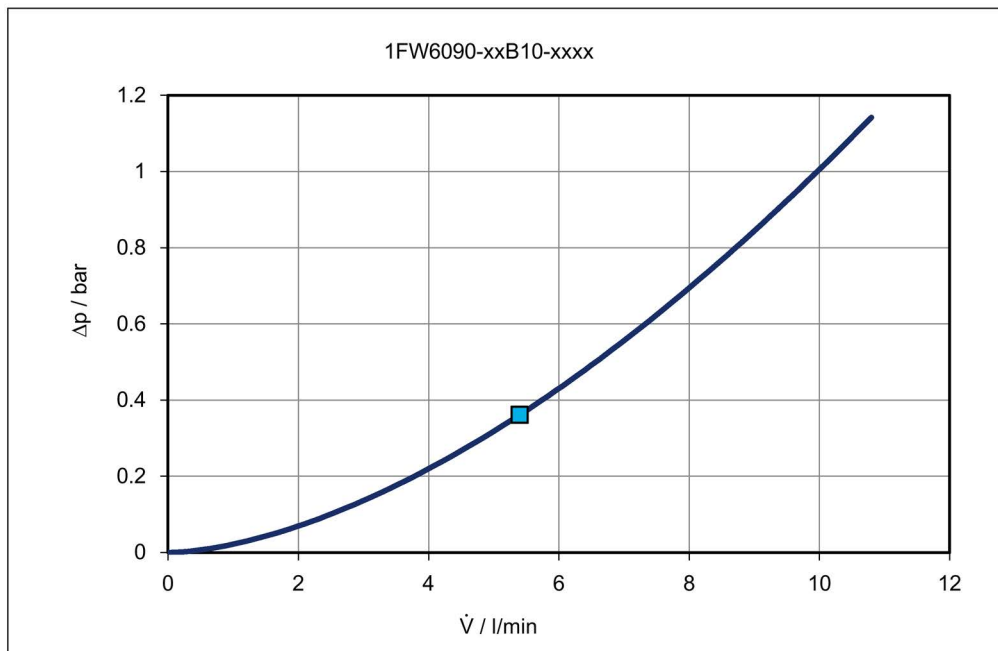

Rotor power loss P_{LV} with respect to speed n

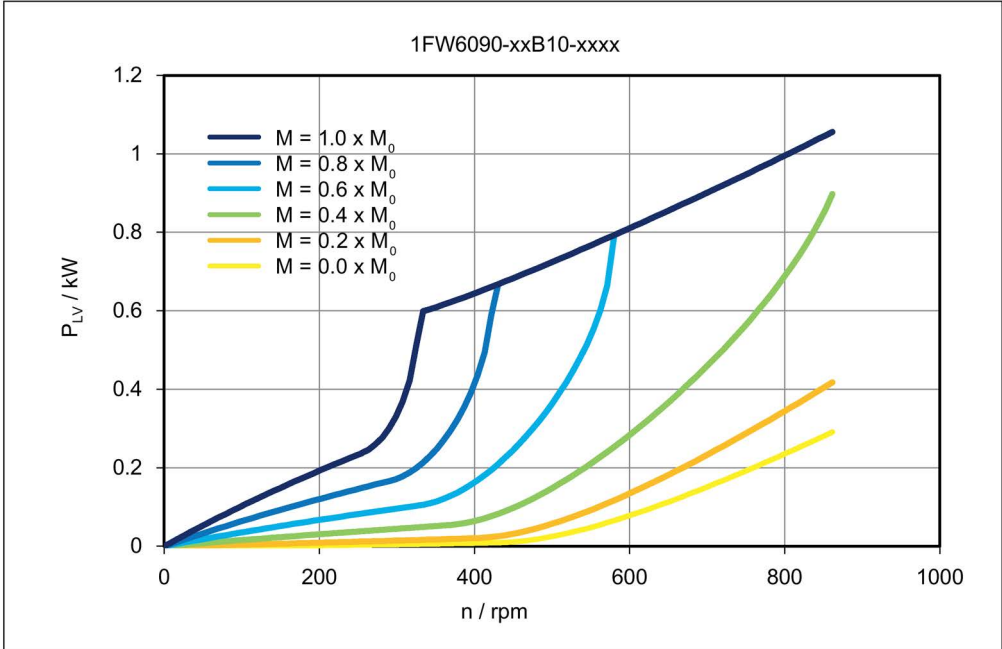

Data sheet 1FW6090-xxB15-xxxx

Table 6- 15 1FW6090-xxB15-1Jxx, 1FW6090-xxB15-2Jxx

Technical data	Symbol	Unit	-xxB15-1Jxx	-xxB15-2Jxx
1FW6090				
Boundary conditions				
DC link voltage	U_{DC}	V	600	600
Water cooling inlet temperature	T_{VORL}	°C	35	35
Rated temperature of winding	T_N	°C	130	130
Data at the rated operating point				
Rated torque	M_N	Nm	338	319
Rated current	I_N	A	15.5	23.8
Rated speed	n_N	rpm	154	312
Rated power loss	$P_{V,N}$	kW	4.9	4.99
Limit data				
Maximum torque	M_{MAX}	Nm	537	537
Maximum current	I_{MAX}	A	26.6	43.4
Electric motor power at M_{MAX}	$P_{EL,MAX}$	kW	17.3	24.4
Maximum speed	n_{MAX}	rpm	574	939
Maximum speed at maximum torque	$n_{MAX,MMAX}$	rpm	80.6	202
Max. speed without VPM	$n_{MAX,INV}$	rpm	392	642
No-load speed	$n_{MAX,0}$	rpm	287	470
Torque at $n = 1$ rpm	M_0	Nm	357	357
Current at M_0 and $n = 1$ rpm	I_0	A	16.5	26.9
Thermal static torque	M_0^*	Nm	257	257
Thermal stall current	I_0^*	A	11.6	19
Physical constants				
Torque constant at 20 °C	$k_{T,20}$	Nm/A	22.5	13.7
Voltage constant	k_E	V/(1000/min)	1360	831
Motor constant at 20 °C	$k_{M,20}$	Nm/(W) ^{0.5}	6.33	6.27
Thermal time constant	t_{TH}	s	60	60
No. of pole pairs	p	-	22	22
Cogging torque	M_{COG}	Nm	3.57	3.57
Stator mass	m_S	kg	19.5	19.5
Rotor mass	m_L	kg	7.7	7.7
Rotor moment of inertia	J_L	10 ⁻² kgm ²	4.65	4.65
Phase resistance of winding at 20 °C	$R_{STR,20}$	Ω	4.21	1.6
Phase inductance of winding	L_{STR}	mH	17.7	6.6

Technical data	Symbol	Unit	-xxB15-1Jxx	-xxB15-2Jxx
1FW6090				
Data for main motor cooler				
Maximum dissipated thermal power	$Q_{H,MAX}$	kW	4.08	4.15
Recommended minimum volume flow	$\dot{V}_{H,MIN}$	l/min	7.02	7.02
Cooling medium temperature increase	ΔT_H	K	8.35	8.5
Pressure drop	Δp_H	bar	0.559	0.559

Characteristics for 1FW6090-xxB15-xxxx

Torque M with respect to speed n

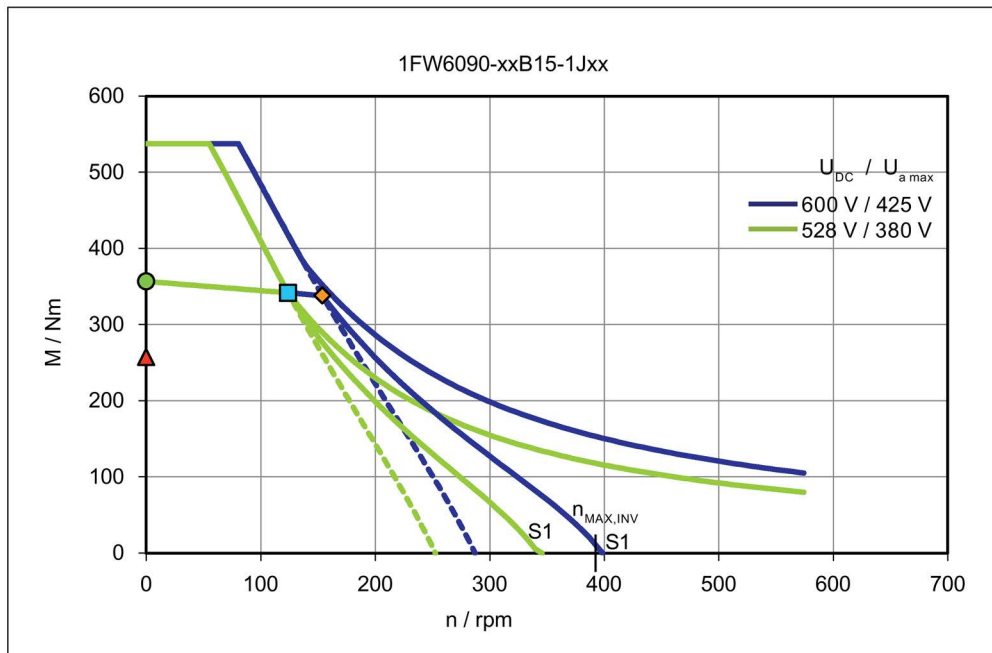

Torque M with respect to speed n

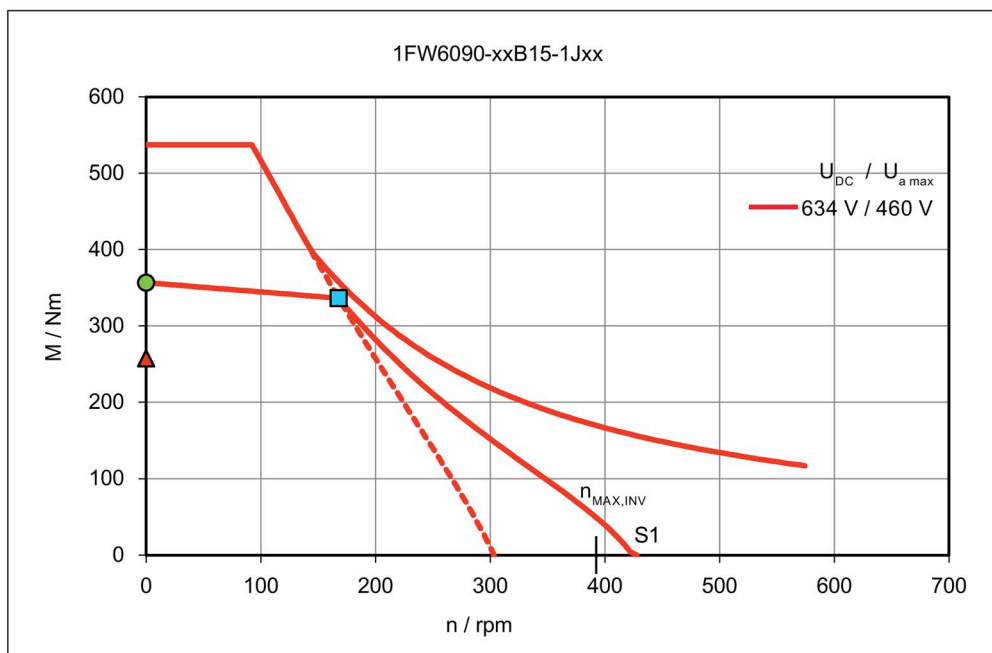

Torque M with respect to speed n

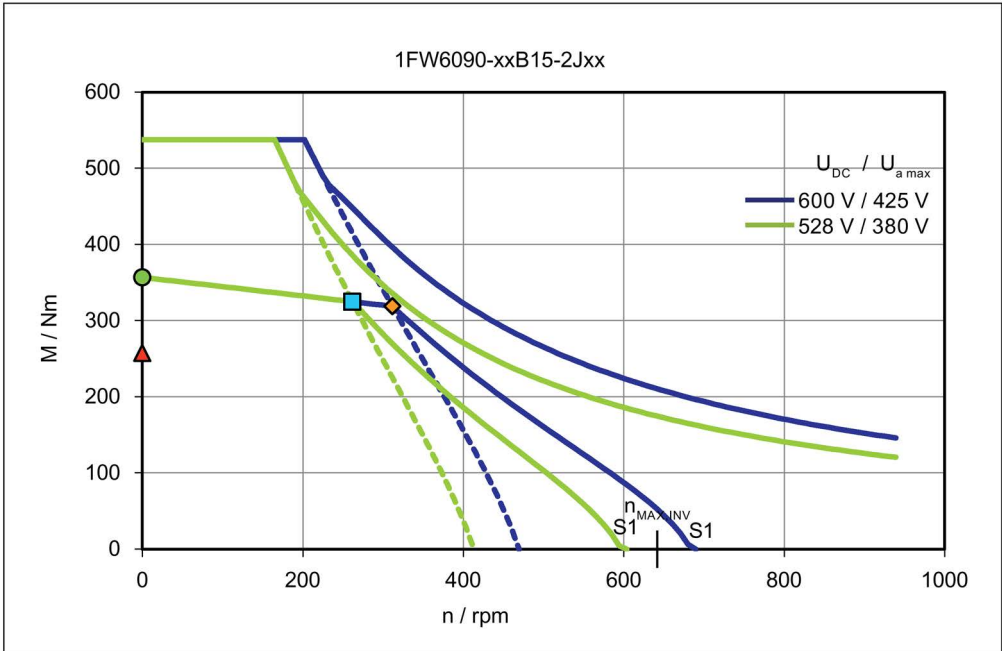

Torque M with respect to speed n

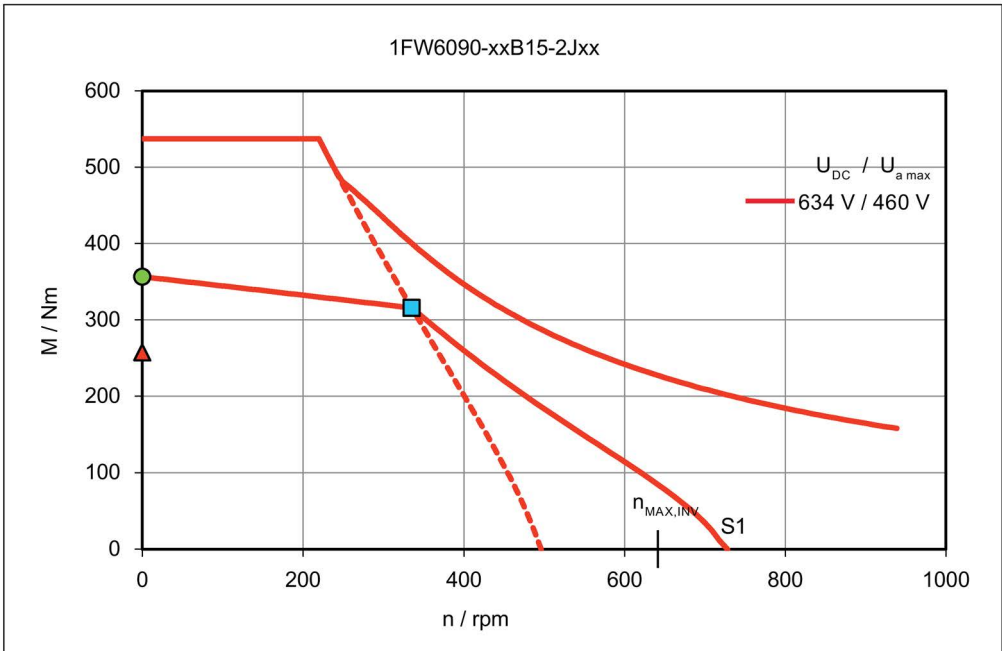

Short-circuit braking torque M_{Br} with respect to speed n

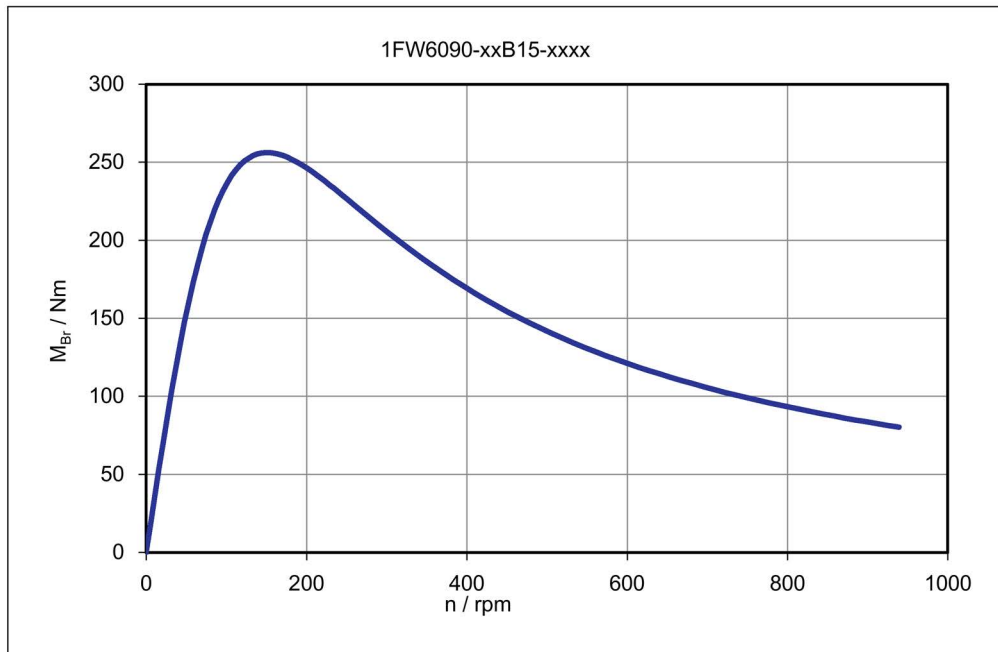

Main cooler - pressure losses Δp with respect to the volume flow \dot{V}

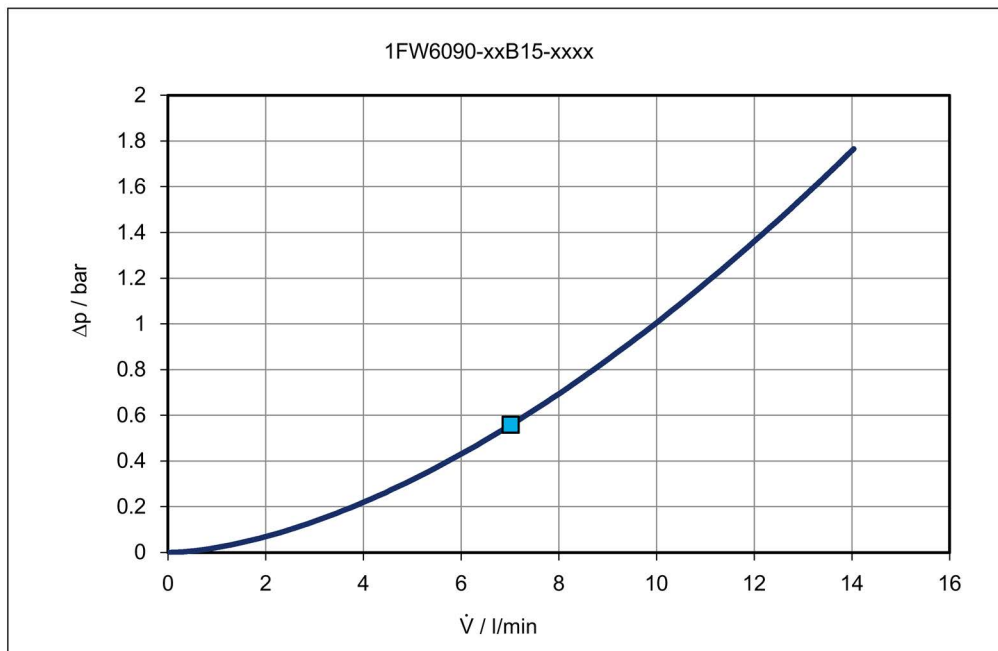

Rotor power loss P_{LV} with respect to speed n

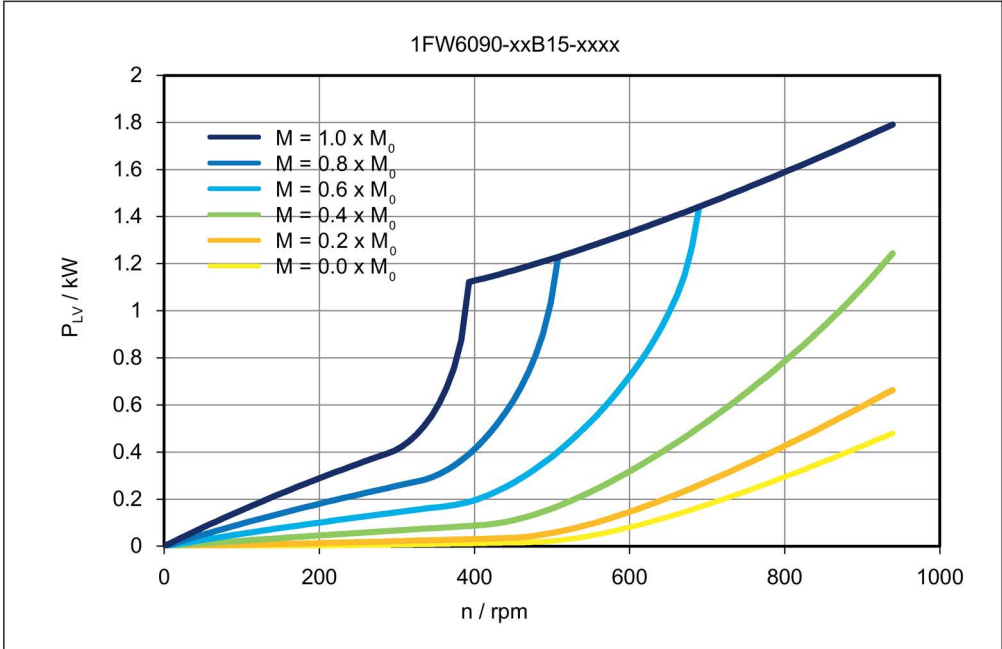

6.2.4 1FW6130-xxxxx-xxxx

Data sheet 1FW6130-xxB05-xxxx

Table 6- 16 1FW6130-xxB05-0Kxx, 1FW6130-xxB05-1Jxx

Technical data	Symbol	Unit	-xxB05-0Kxx	-xxB05-1Jxx
1FW6130				
Boundary conditions				
DC link voltage	U_{DC}	V	600	600
Water cooling inlet temperature	T_{VORL}	°C	35	35
Rated temperature of winding	T_N	°C	130	130
Data at the rated operating point				
Rated torque	M_N	Nm	241	217
Rated current	I_N	A	9.06	14.5
Rated speed	n_N	rpm	132	308
Rated power loss	$P_{V,N}$	kW	3.01	3.03
Limit data				
Maximum torque	M_{MAX}	Nm	439	439
Maximum current	I_{MAX}	A	18.1	32.3
Electric motor power at M_{MAX}	$P_{EL,MAX}$	kW	12.5	18.7
Maximum speed	n_{MAX}	rpm	473	844
Maximum speed at maximum torque	$n_{MAX,MMAX}$	rpm	46.5	181
Max. speed without VPM	$n_{MAX,INV}$	rpm	323	577
No-load speed	$n_{MAX,0}$	rpm	237	422
Torque at $n = 1$ rpm	M_0	Nm	258	258
Current at M_0 and $n = 1$ rpm	I_0	A	9.76	17.4
Thermal static torque	M_0^*	Nm	186	186
Thermal stall current	I_0^*	A	6.9	12.3
Physical constants				
Torque constant at 20 °C	$k_{T,20}$	Nm/A	27.3	15.3
Voltage constant	k_E	V/(1000/min)	1650	925
Motor constant at 20 °C	$k_{M,20}$	Nm/(W) ^{0.5}	5.81	5.79
Thermal time constant	t_{TH}	s	60	60
No. of pole pairs	p	-	33	33
Cogging torque	M_{COG}	Nm	1.29	1.29
Stator mass	m_S	kg	8.7	8.7
Rotor mass	m_L	kg	4.5	4.5
Rotor moment of inertia	J_L	10 ⁻² kgm ²	6.37	6.37
Phase resistance of winding at 20 °C	$R_{STR, 20}$	Ω	7.35	2.32
Phase inductance of winding	L_{STR}	mH	19.2	6.03

Technical data	Symbol	Unit	-xxB05-0Kxx	-xxB05-1Jxx
1FW6130				
Data for main motor cooler				
Maximum dissipated thermal power	$Q_{H,MAX}$	kW	2.5	2.52
Recommended minimum volume flow	$\dot{V}_{H,MIN}$	l/min	4.1	4.1
Cooling medium temperature increase	ΔT_H	K	8.79	8.85
Pressure drop	Δp_H	bar	0.146	0.146

Characteristics for 1FW6130-xxB05-xxxx

Torque M with respect to speed n

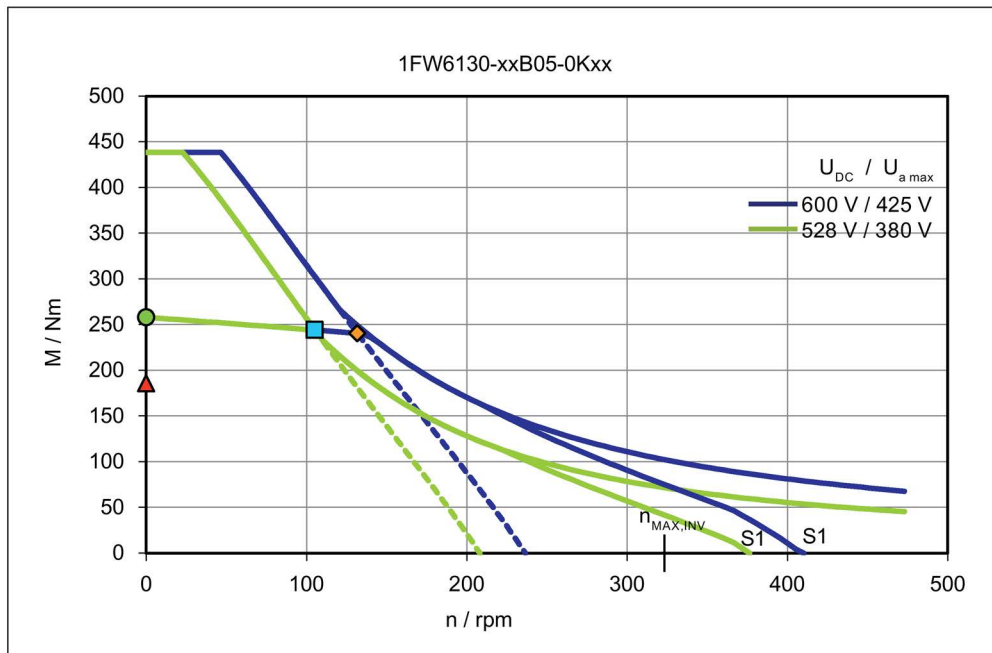

Torque M with respect to speed n

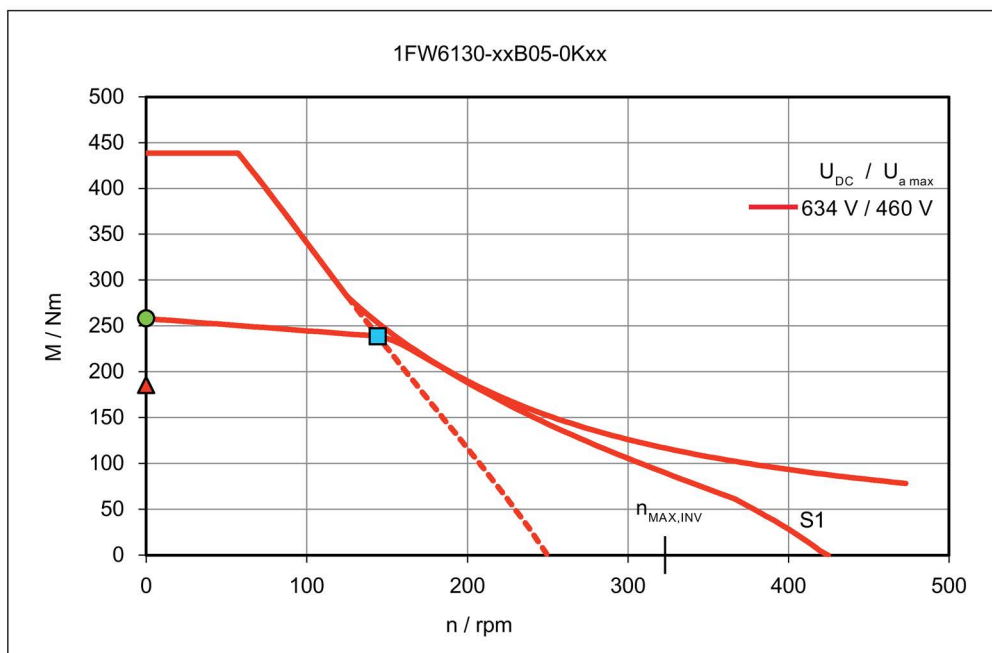

Torque M with respect to speed n

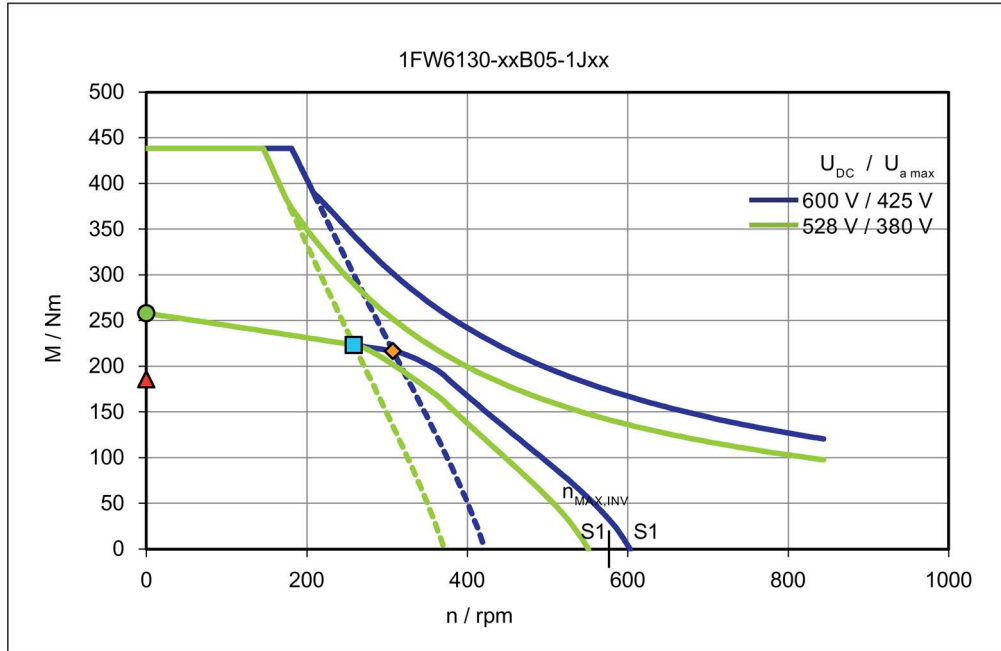

Torque M with respect to speed n

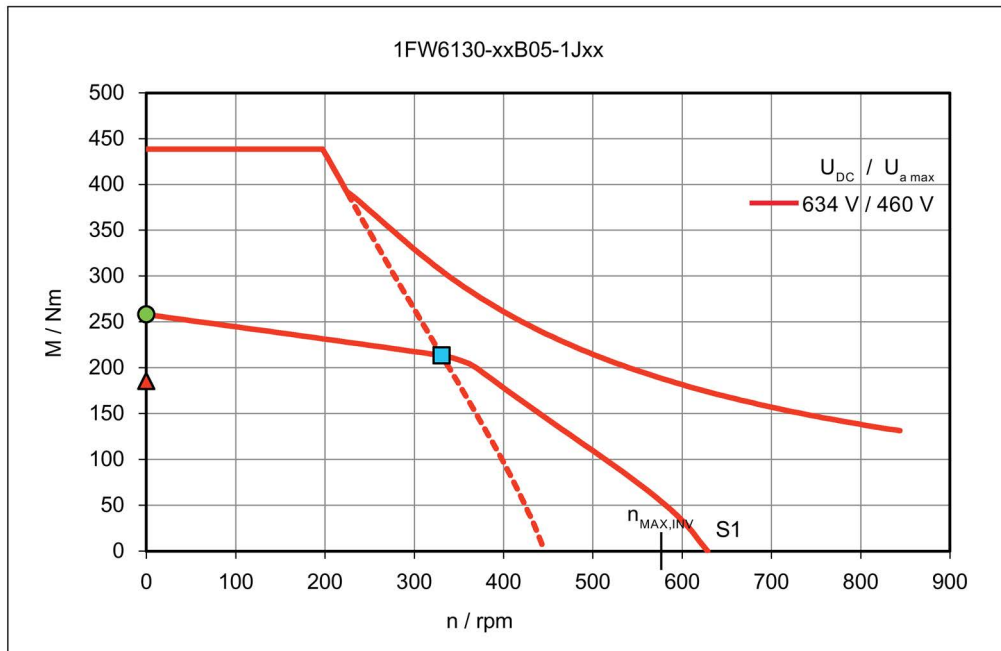

Short-circuit braking torque M_{Br} with respect to speed n

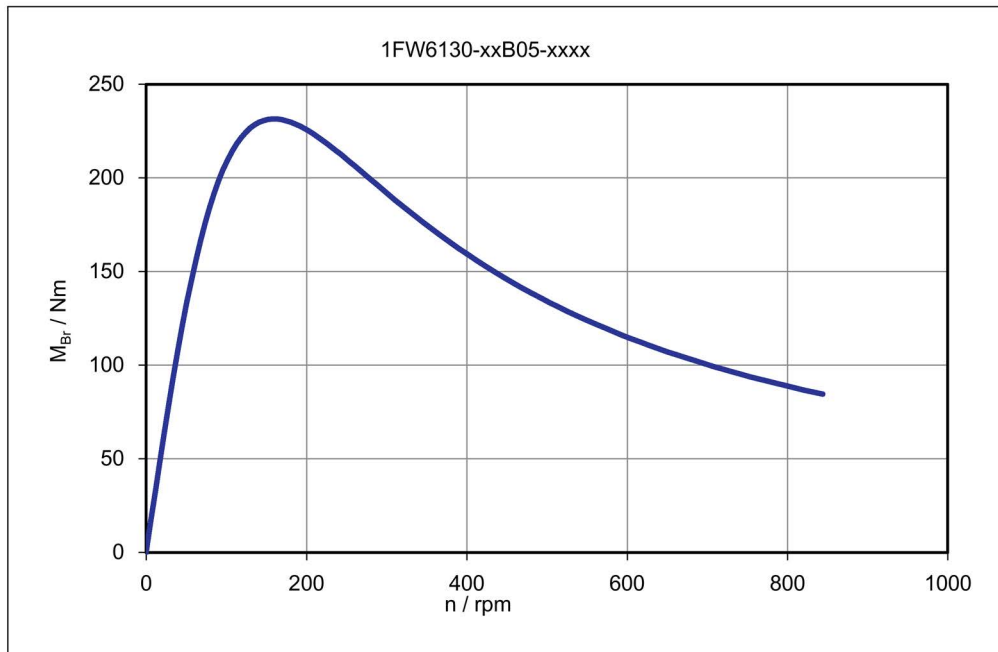

Main cooler - pressure losses Δp with respect to the volume flow \dot{V}

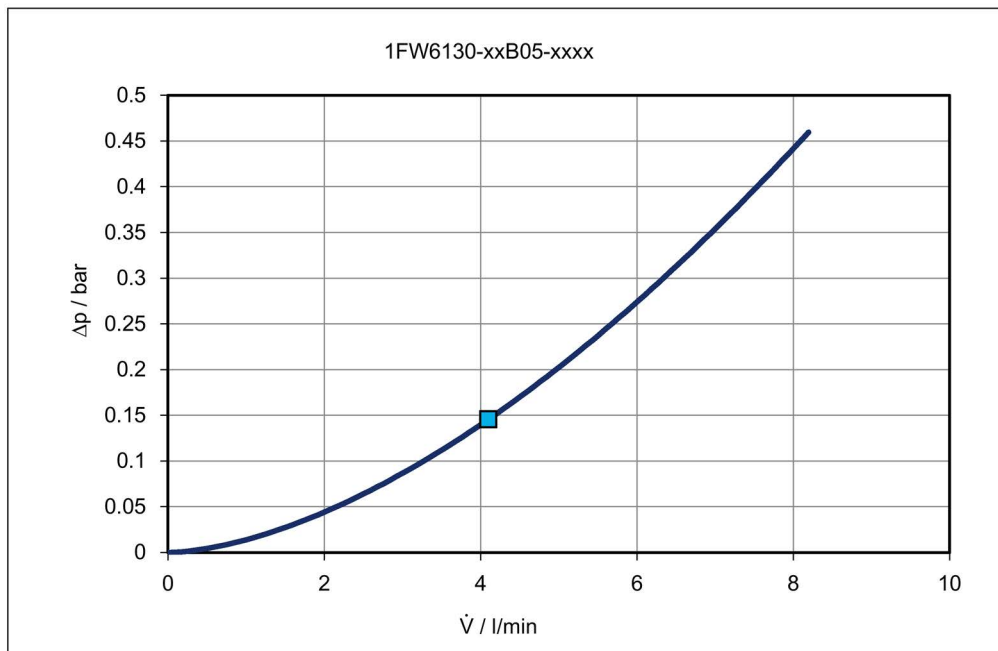

Rotor power loss P_{LV} with respect to speed n

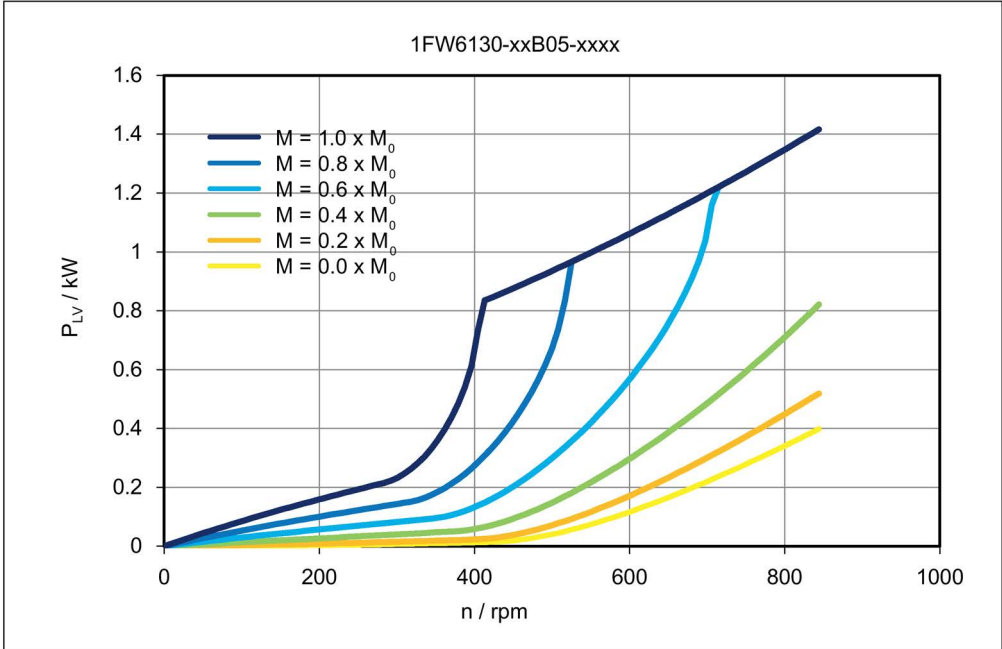

Data sheet 1FW6130-xxB07-xxxx

Table 6- 17 1FW6130-xxB07-0Kxx, 1FW6130-xxB07-1Jxx

Technical data	Symbol	Unit	-xxB07-0Kxx	-xxB07-1Jxx
1FW6130				
Boundary conditions				
DC link voltage	U_{DC}	V	600	600
Water cooling inlet temperature	T_{VORL}	°C	35	35
Rated temperature of winding	T_N	°C	130	130
Data at the rated operating point				
Rated torque	M_N	Nm	344	324
Rated current	I_N	A	10.4	15.5
Rated speed	n_N	rpm	96.1	201
Rated power loss	$P_{V,N}$	kW	3.82	3.81
Limit data				
Maximum torque	M_{MAX}	Nm	614	614
Maximum current	I_{MAX}	A	20.3	32.3
Electric motor power at M_{MAX}	$P_{EL,MAX}$	kW	14.5	20.1
Maximum speed	n_{MAX}	rpm	380	603
Maximum speed at maximum torque	$n_{MAX,MMAX}$	rpm	21.5	109
Max. speed without VPM	$n_{MAX,INV}$	rpm	259	412
No-load speed	$n_{MAX,0}$	rpm	190	301
Torque at $n = 1$ rpm	M_0	Nm	361	361
Current at M_0 and $n = 1$ rpm	I_0	A	11	17.4
Thermal static torque	M_0^*	Nm	260	260
Thermal stall current	I_0^*	A	7.76	12.3
Physical constants				
Torque constant at 20 °C	$k_{T,20}$	Nm/A	34	21.4
Voltage constant	k_E	V/(1000/min)	2060	1290
Motor constant at 20 °C	$k_{M,20}$	Nm/(W) ^{0.5}	7.22	7.23
Thermal time constant	t_{TH}	s	60	60
No. of pole pairs	p	-	33	33
Cogging torque	M_{COG}	Nm	1.81	1.81
Stator mass	m_S	kg	11.9	11.9
Rotor mass	m_L	kg	6.3	6.3
Rotor moment of inertia	J_L	10 ⁻² kgm ²	8.92	8.92
Phase resistance of winding at 20 °C	$R_{STR,20}$	Ω	7.39	2.92
Phase inductance of winding	L_{STR}	mH	21	8.31

Technical data	Symbol	Unit	-xxB07-0Kxx	-xxB07-1Jxx
1FW6130				
Data for main motor cooler				
Maximum dissipated thermal power	$Q_{H,MAX}$	kW	3.18	3.17
Recommended minimum volume flow	$\dot{V}_{H,MIN}$	l/min	5.2	5.2
Cooling medium temperature increase	ΔT_H	K	8.79	8.77
Pressure drop	Δp_H	bar	0.216	0.216

Characteristics for 1FW6130-xxB07-xxxx

Torque M with respect to speed n

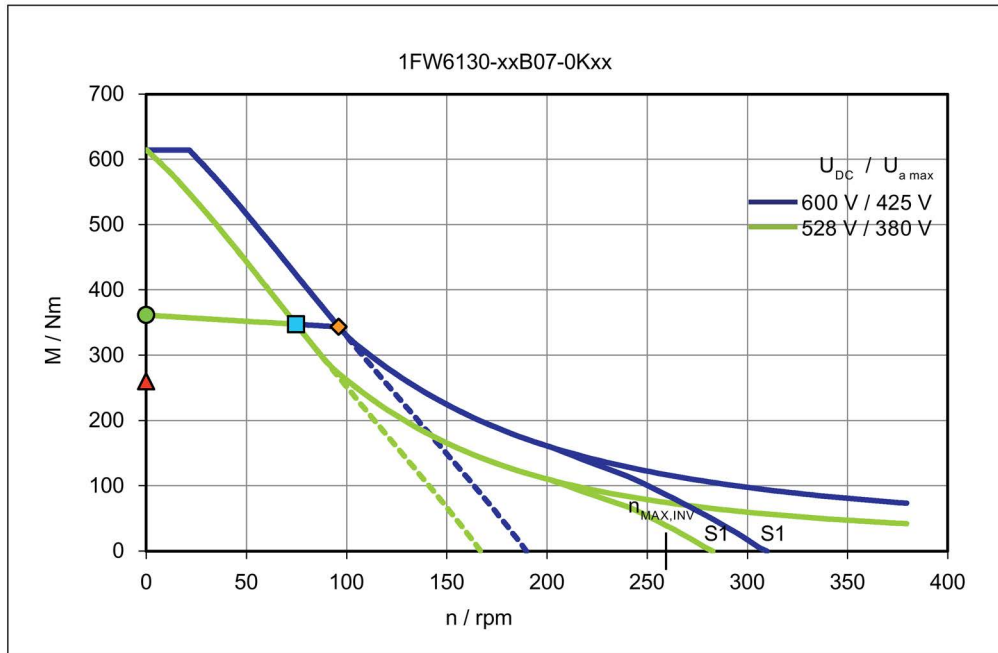

Torque M with respect to speed n

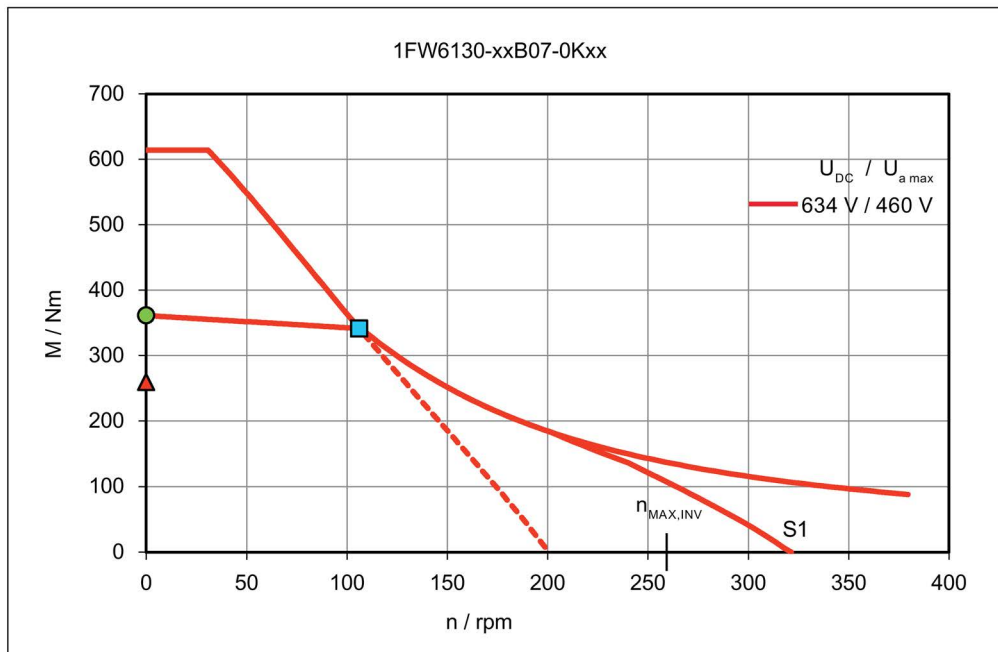

Torque M with respect to speed n

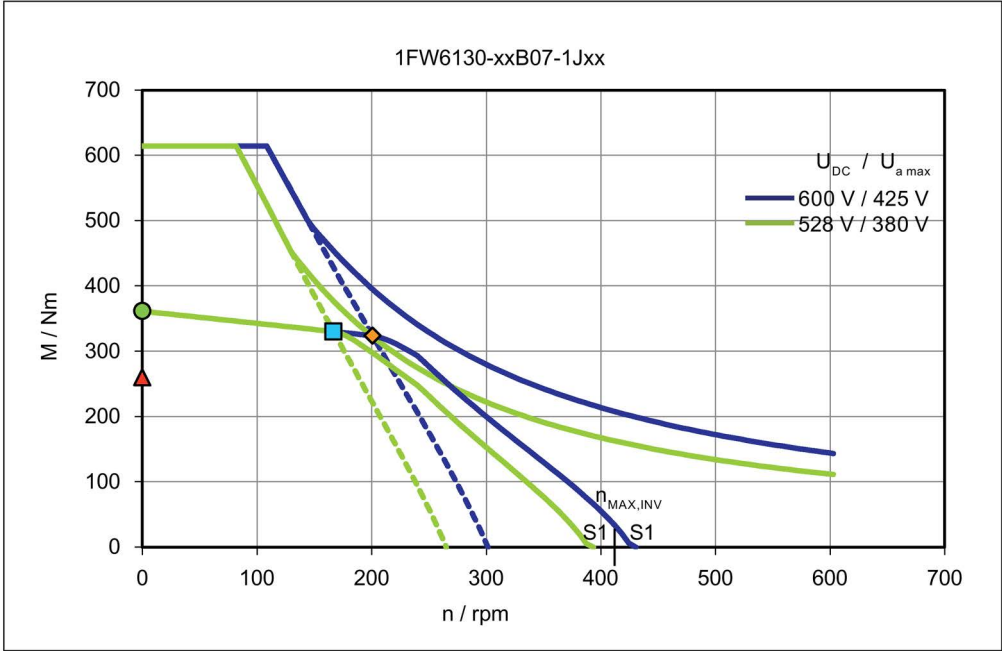

Torque M with respect to speed n

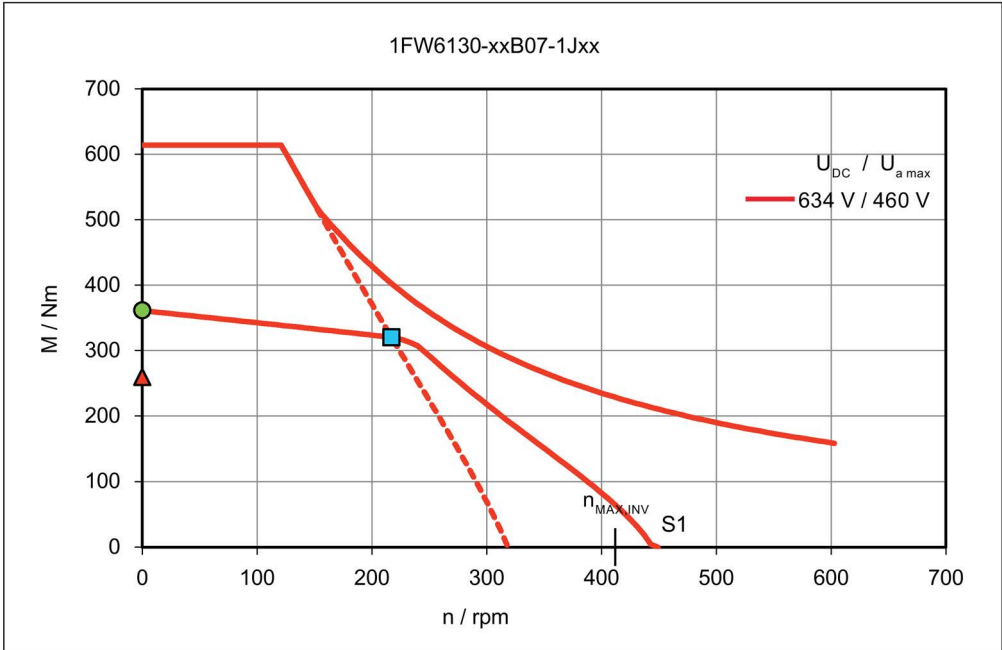

Short-circuit braking torque M_{Br} with respect to speed n

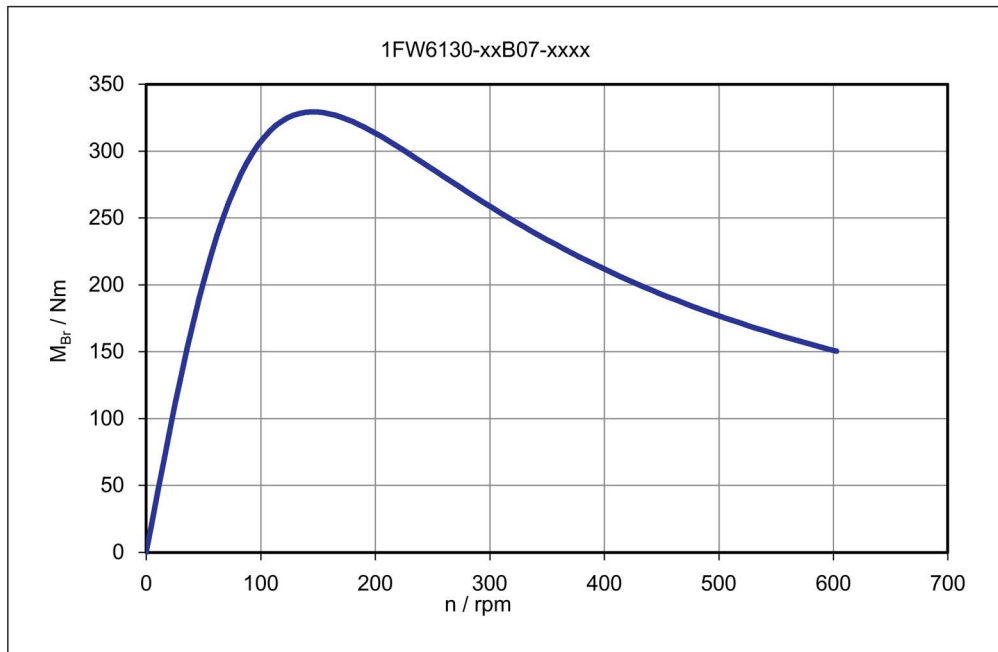

Main cooler - pressure losses Δp with respect to the volume flow \dot{V}

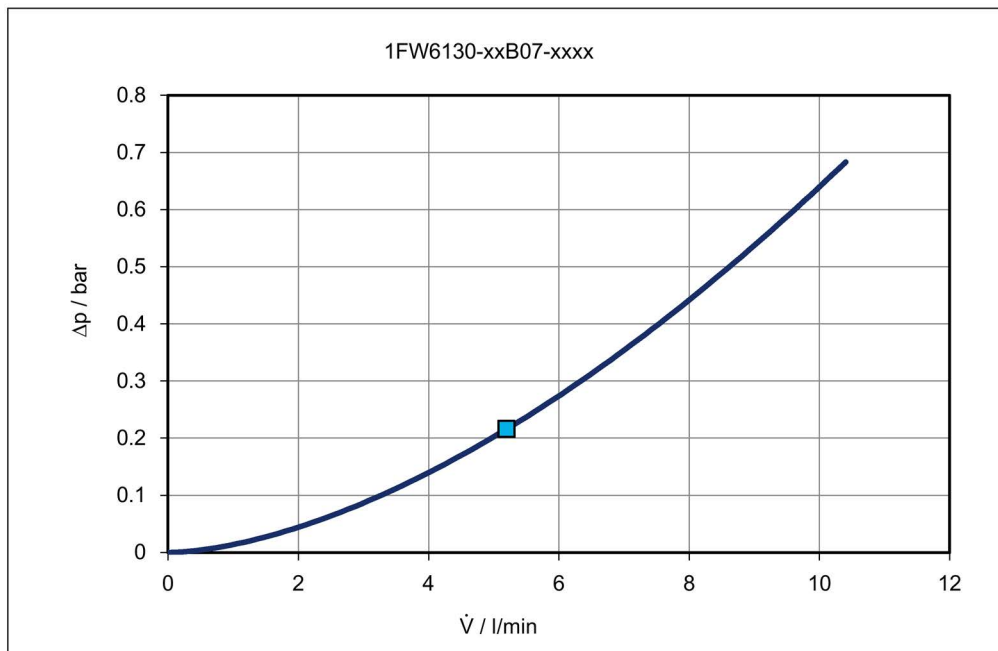

Rotor power loss P_{LV} with respect to speed n

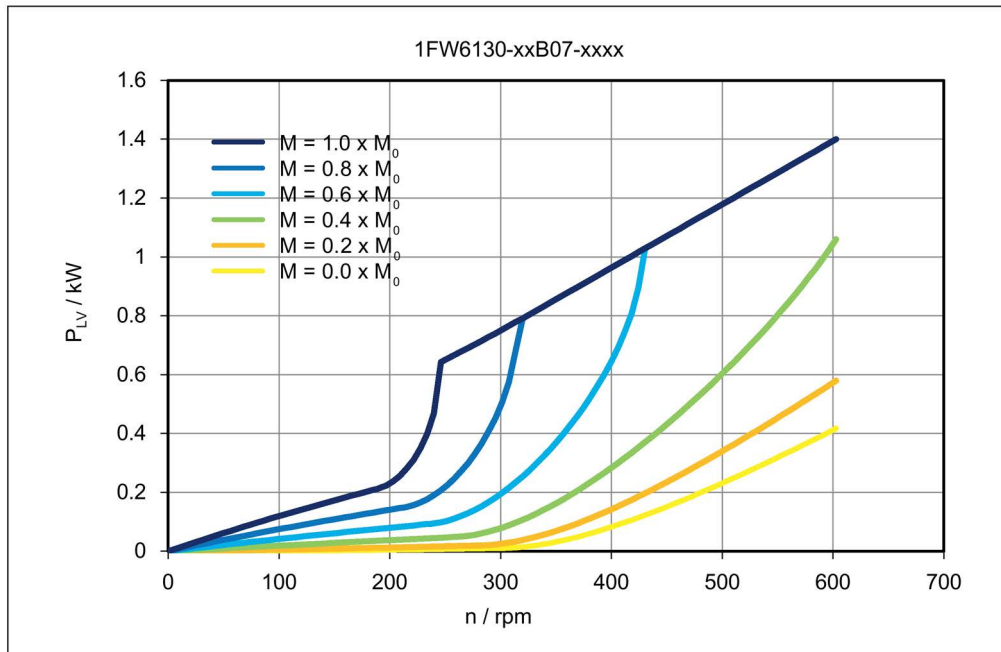

Data sheet 1FW6130-xxB10-xxxx

Table 6- 18 1FW6130-xxB10-1Jxx, 1FW6130-xxB10-2Jxx

Technical data	Symbol	Unit	-xxB10-1Jxx	-xxB10-2Jxx
1FW6130				
Boundary conditions				
DC link voltage	U_{DC}	V	600	600
Water cooling inlet temperature	T_{VORL}	°C	35	35
Rated temperature of winding	T_N	°C	130	130
Data at the rated operating point				
Rated torque	M_N	Nm	484	449
Rated current	I_N	A	16.2	24.7
Rated speed	n_N	rpm	123	249
Rated power loss	$P_{V,N}$	kW	4.98	5.1
Limit data				
Maximum torque	M_{MAX}	Nm	878	878
Maximum current	I_{MAX}	A	32.3	53.1
Electric motor power at M_{MAX}	$P_{EL,MAX}$	kW	21.8	31.2
Maximum speed	n_{MAX}	rpm	422	694
Maximum speed at maximum torque	$n_{MAX,MMAX}$	rpm	50.9	148
Max. speed without VPM	$n_{MAX,INV}$	rpm	288	474
No-load speed	$n_{MAX,0}$	rpm	211	347
Torque at $n = 1$ rpm	M_0	Nm	516	516
Current at M_0 and $n = 1$ rpm	I_0	A	17.4	28.7
Thermal static torque	M_0^*	Nm	371	371
Thermal stall current	I_0^*	A	12.3	20.3
Physical constants				
Torque constant at 20 °C	$k_{T,20}$	Nm/A	30.6	18.6
Voltage constant	k_E	V/(1000/min)	1850	1120
Motor constant at 20 °C	$k_{M,20}$	Nm/(W) ^{0.5}	9.04	8.94
Thermal time constant	t_{TH}	s	60	60
No. of pole pairs	p	-	33	33
Cogging torque	M_{COG}	Nm	2.58	2.58
Stator mass	m_S	kg	16.2	16.2
Rotor mass	m_L	kg	9	9
Rotor moment of inertia	J_L	10 ⁻² kgm ²	12.7	12.7
Phase resistance of winding at 20 °C	$R_{STR, 20}$	Ω	3.82	1.44
Phase inductance of winding	L_{STR}	mH	11.7	4.33

Technical data	Symbol	Unit	-xxB10-1Jxx	-xxB10-2Jxx
1FW6130				
Data for main motor cooler				
Maximum dissipated thermal power	$Q_{H,MAX}$	kW	4.15	4.24
Recommended minimum volume flow	$\dot{V}_{H,MIN}$	l/min	7.02	7.02
Cooling medium temperature increase	ΔT_H	K	8.49	8.69
Pressure drop	Δp_H	bar	0.356	0.356

Characteristics for 1FW6130-xxB10-xxxx

Torque M with respect to speed n

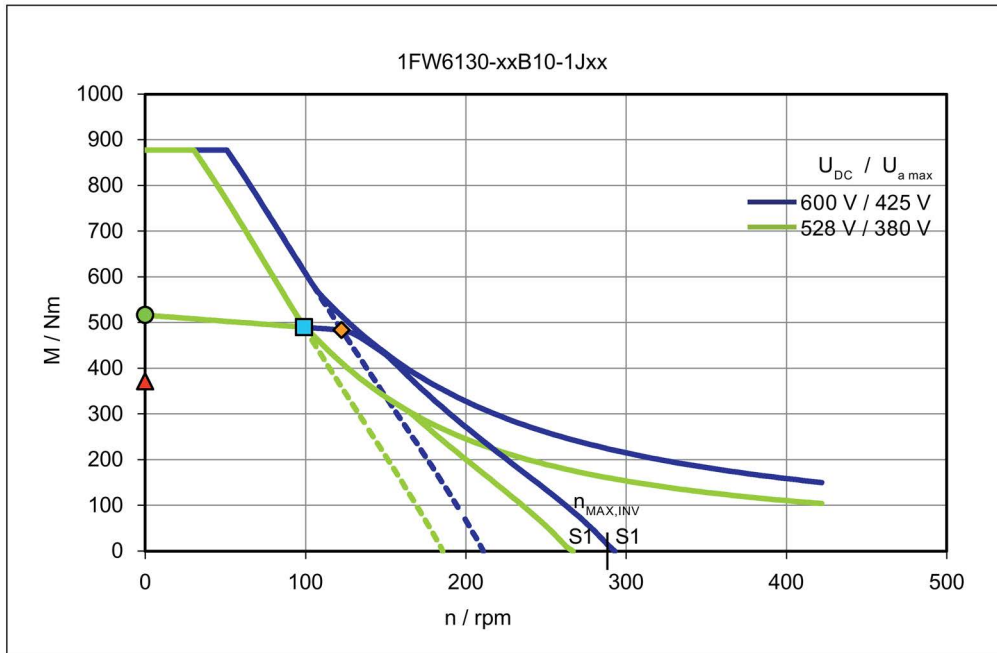

Torque M with respect to speed n

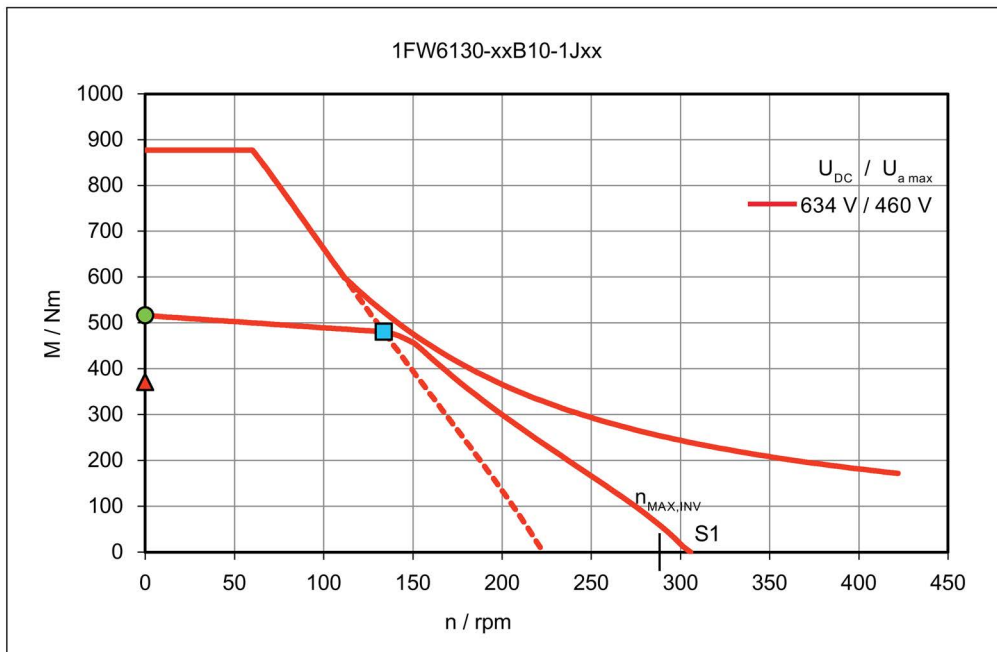

Torque M with respect to speed n

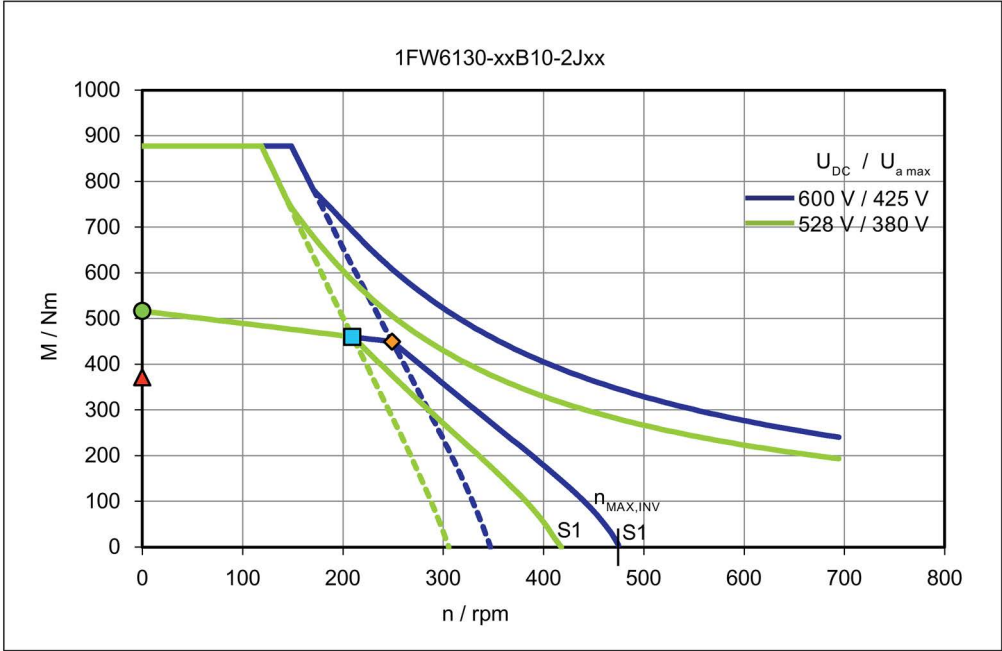

Torque M with respect to speed n

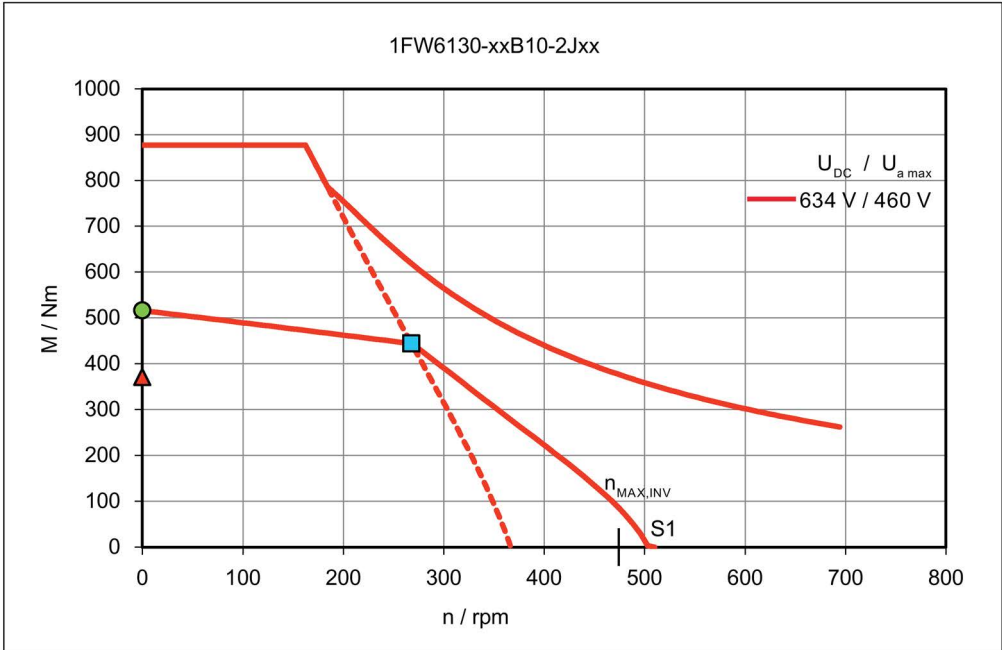

Short-circuit braking torque M_{Br} with respect to speed n

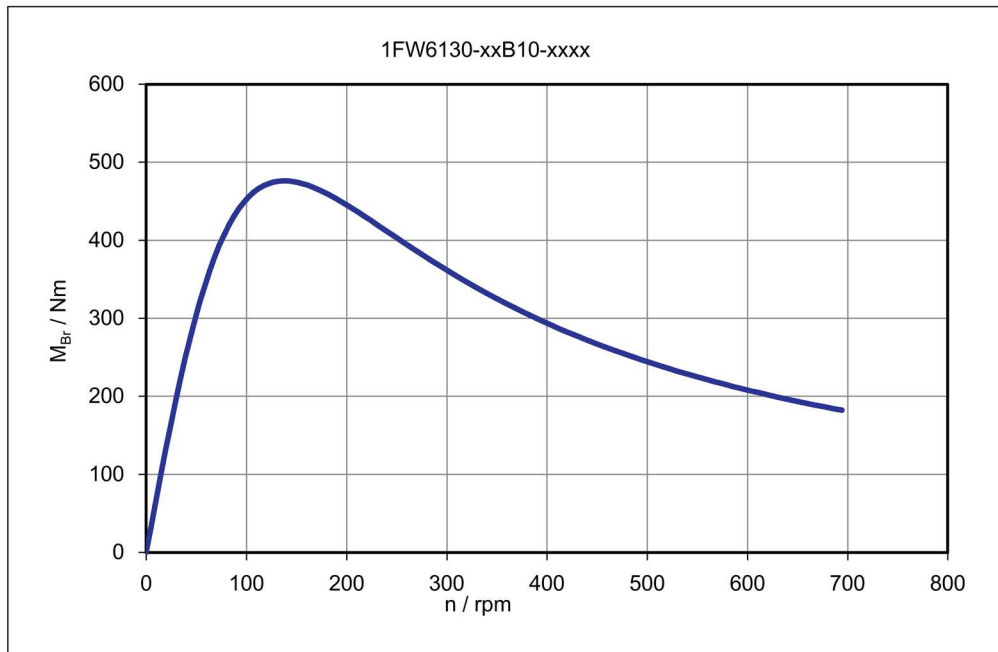

Main cooler - pressure losses Δp with respect to the volume flow \dot{V}

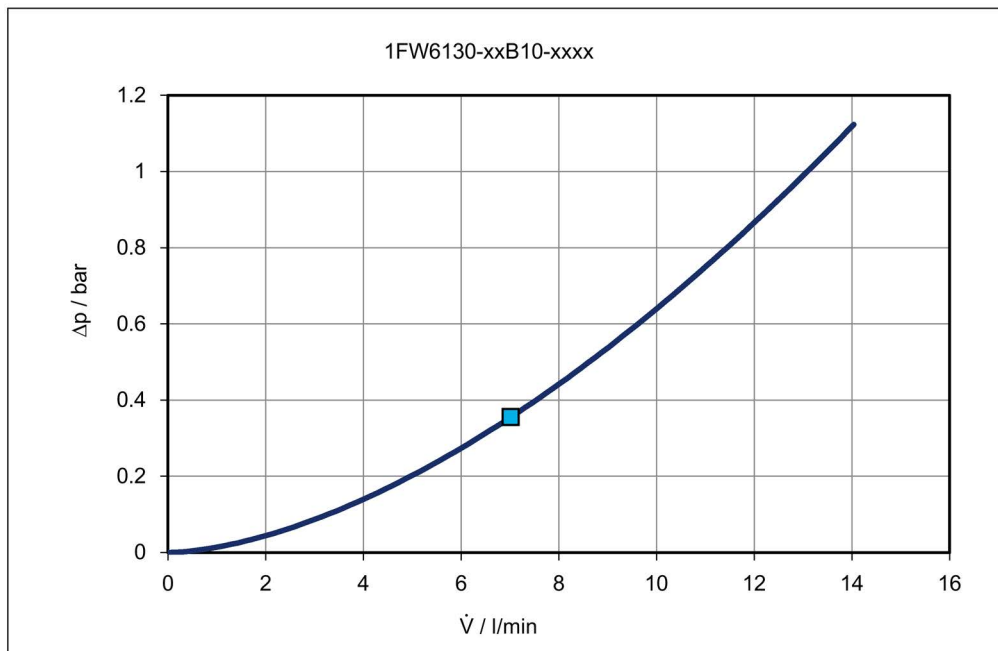

Rotor power loss P_{LV} with respect to speed n

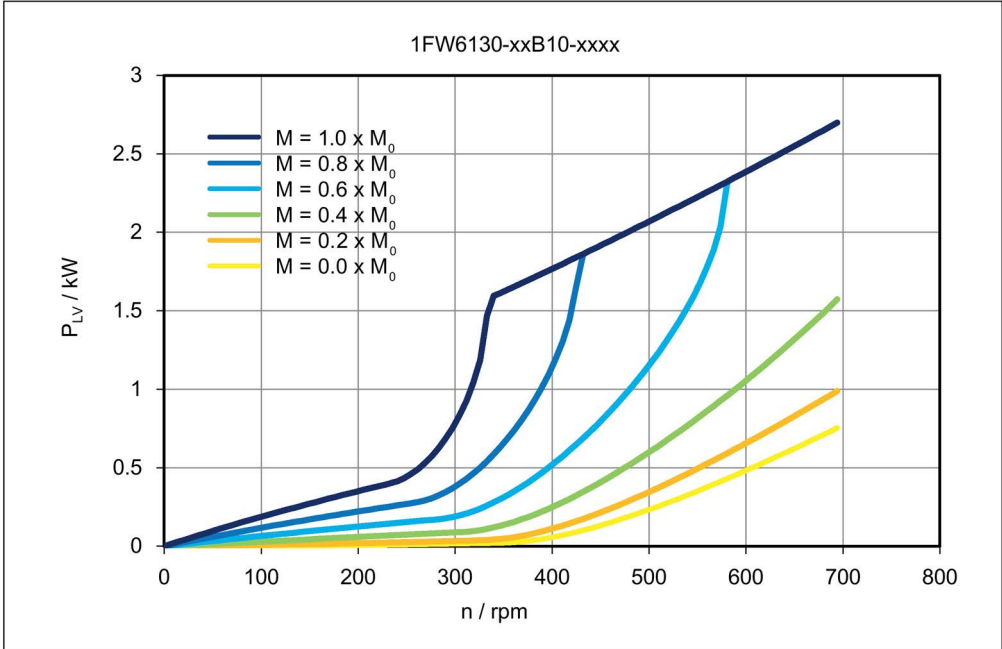

Data sheet 1FW6130-xxB15-xxxx

Table 6- 19 1FW6130-xxB15-1Jxx, 1FW6130-xxB15-2Jxx

Technical data	Symbol	Unit	-xxB15-1Jxx	-xxB15-2Jxx
1FW6130				
Boundary conditions				
DC link voltage	U_{DC}	V	600	600
Water cooling inlet temperature	T_{VORL}	°C	35	35
Rated temperature of winding	T_N	°C	130	130
Data at the rated operating point				
Rated torque	M_N	Nm	743	714
Rated current	I_N	A	18.7	26.9
Rated speed	n_N	rpm	78.4	152
Rated power loss	$P_{V,N}$	kW	6.91	6.91
Limit data				
Maximum torque	M_{MAX}	Nm	1320	1320
Maximum current	I_{MAX}	A	36.2	54.3
Electric motor power at M_{MAX}	$P_{EL,MAX}$	kW	25.9	34.6
Maximum speed	n_{MAX}	rpm	315	473
Maximum speed at maximum torque	$n_{MAX,MMAX}$	rpm	16	78.8
Max. speed without VPM	$n_{MAX,INV}$	rpm	215	323
No-load speed	$n_{MAX,0}$	rpm	158	237
Torque at $n = 1$ rpm	M_0	Nm	775	775
Current at M_0 and $n = 1$ rpm	I_0	A	19.5	29.3
Thermal static torque	M_0^*	Nm	557	557
Thermal stall current	I_0^*	A	13.8	20.7
Physical constants				
Torque constant at 20 °C	$k_{T,20}$	Nm/A	40.9	27.3
Voltage constant	k_E	V/(1000/min)	2480	1650
Motor constant at 20 °C	$k_{M,20}$	Nm/(W) ^{0.5}	11.5	11.5
Thermal time constant	t_{TH}	s	60	60
No. of pole pairs	p	-	33	33
Cogging torque	M_{COG}	Nm	3.87	3.87
Stator mass	m_S	kg	24.7	24.7
Rotor mass	m_L	kg	13.5	13.5
Rotor moment of inertia	J_L	10 ⁻² kgm ²	19.1	19.1
Phase resistance of winding at 20 °C	$R_{STR,20}$	Ω	4.21	1.87
Phase inductance of winding	L_{STR}	mH	13.9	6.16

Technical data	Symbol	Unit	-xxB15-1Jxx	-xxB15-2Jxx
1FW6130				
Data for main motor cooler				
Maximum dissipated thermal power	$Q_{H,MAX}$	kW	5.75	5.75
Recommended minimum volume flow	$\dot{V}_{H,MIN}$	l/min	9.78	9.78
Cooling medium temperature increase	ΔT_H	K	8.45	8.45
Pressure drop	Δp_H	bar	0.617	0.617

Characteristics for 1FW6130-xxB15-xxxx

Torque M with respect to speed n

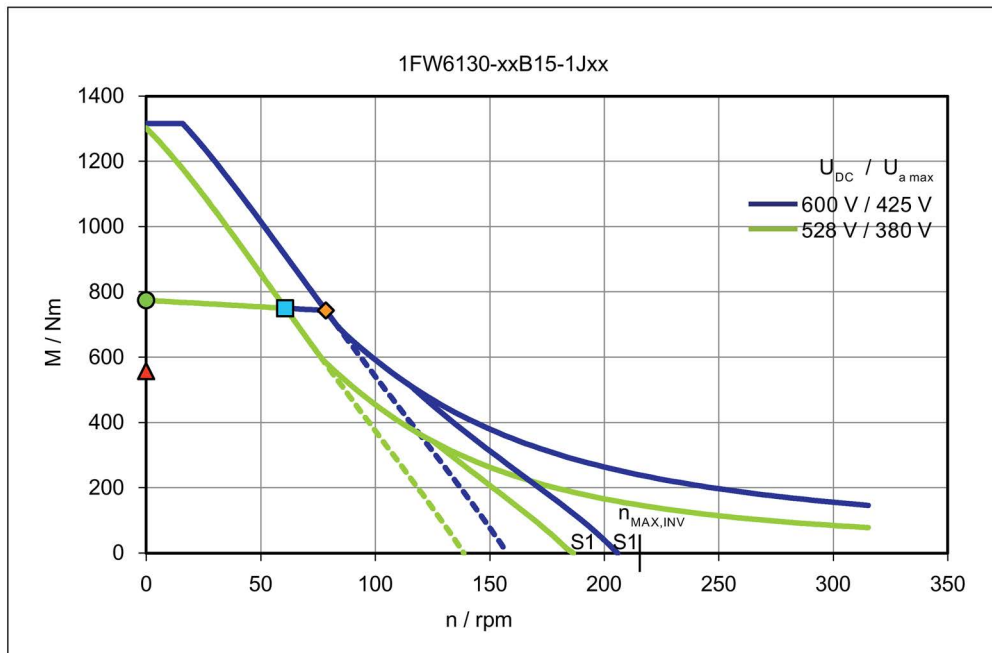

Torque M with respect to speed n

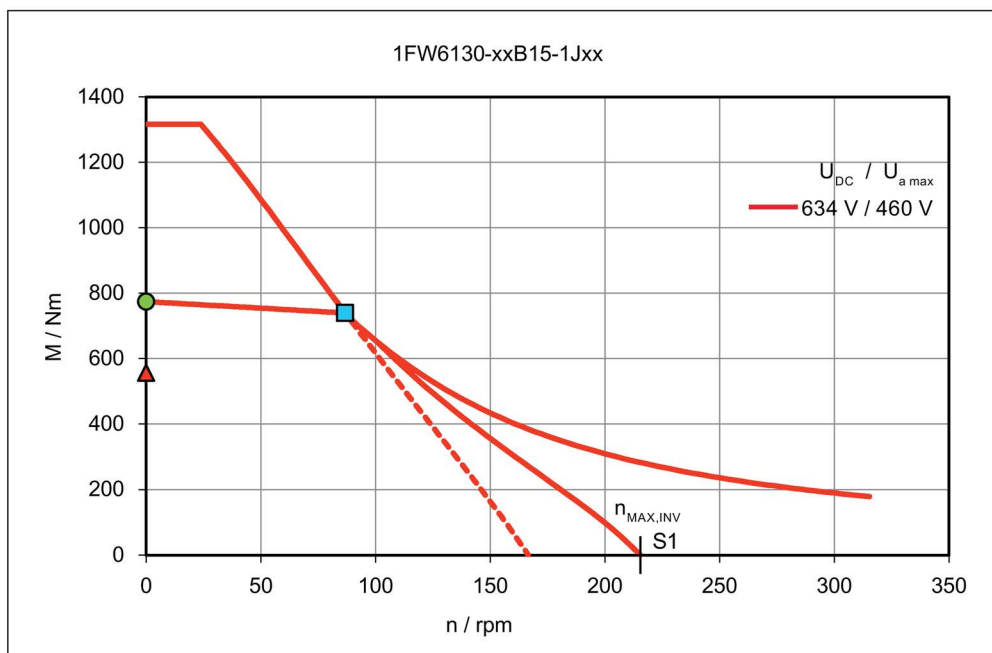

Torque M with respect to speed n

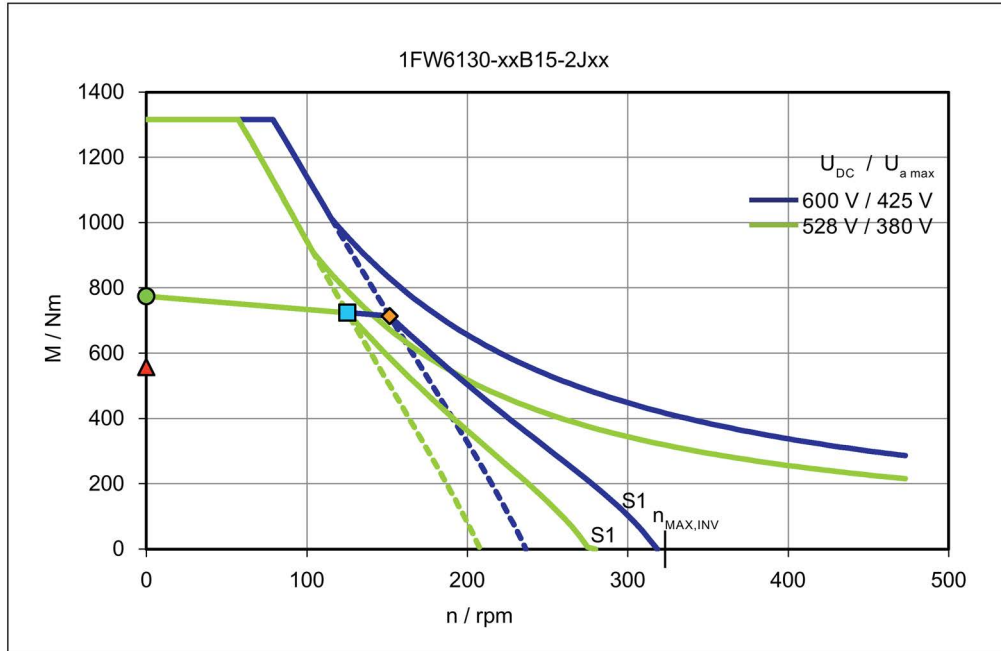

Torque M with respect to speed n

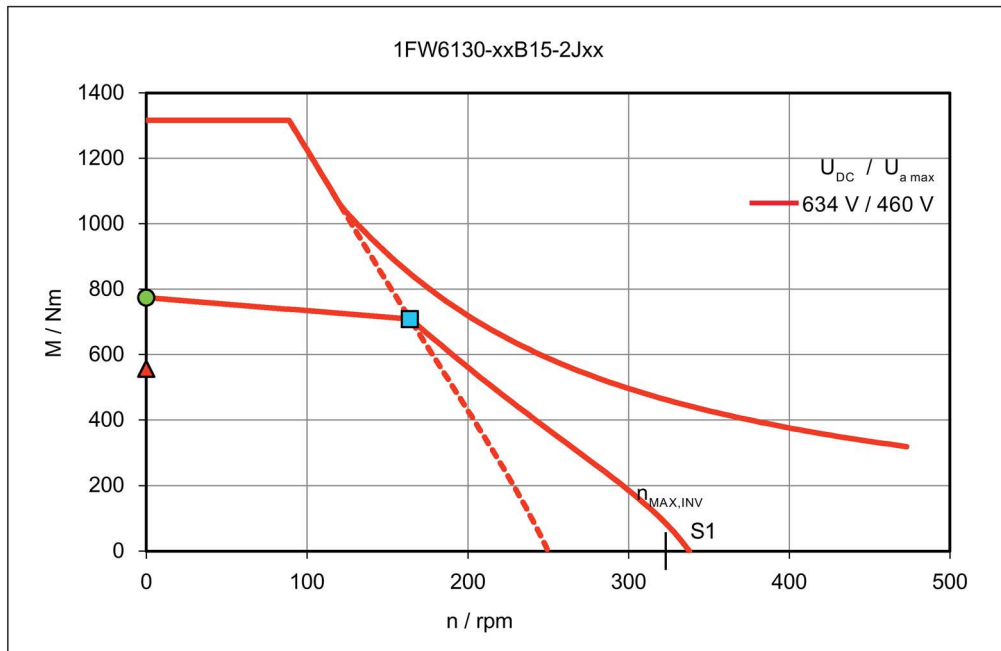

Short-circuit braking torque M_{Br} with respect to speed n

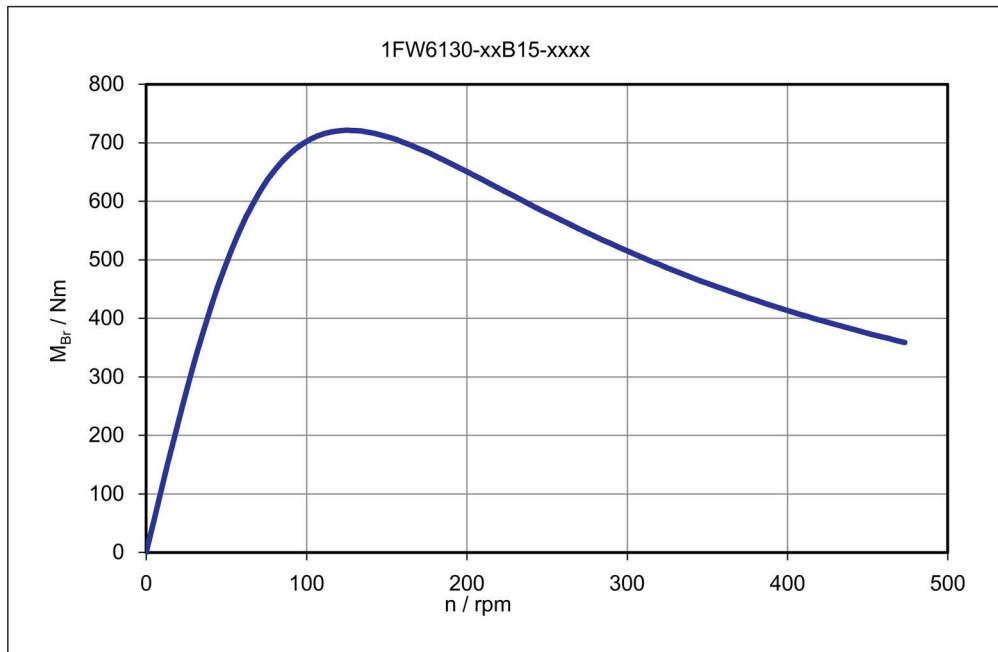

Main cooler - pressure losses Δp with respect to the volume flow \dot{V}

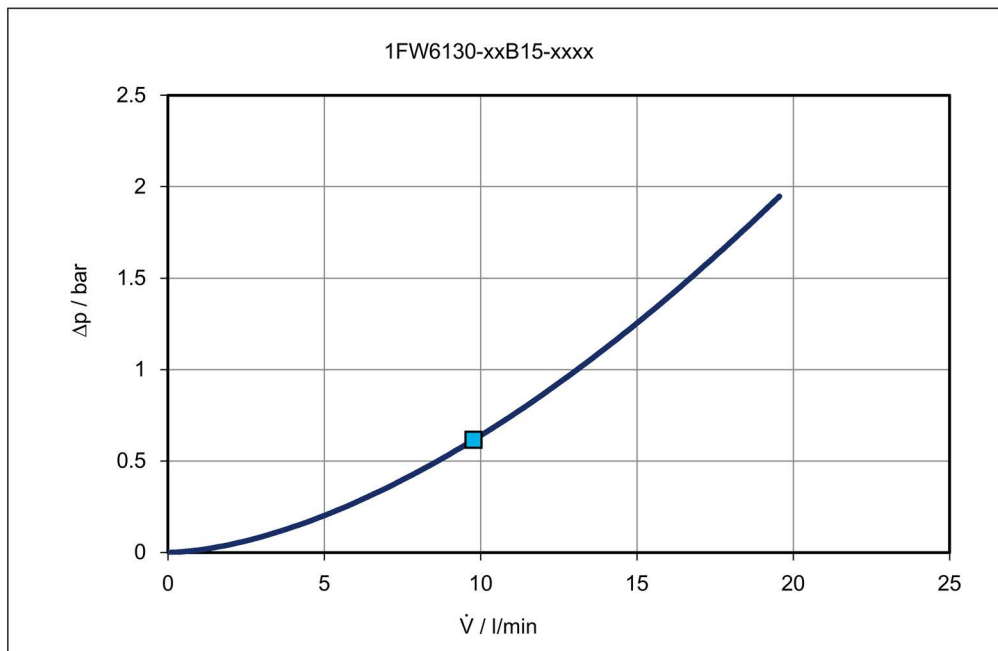

Rotor power loss P_{LV} with respect to speed n

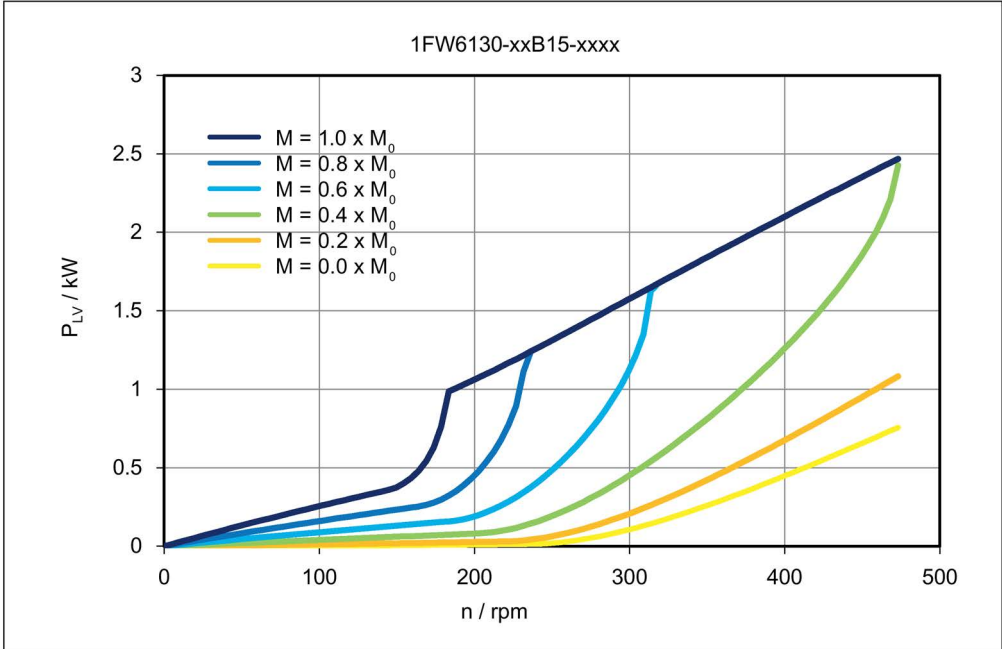

6.2.5 1FW6150-xxxxx-xxxx

Data sheet 1FW6150-xxB05-xxxx

Table 6- 20 1FW6150-xxB05-1Jxx, 1FW6150-xxB05-4Fxx

Technical data	Symbol	Unit	-xxB05-1Jxx	-xxB05-4Fxx
1FW6150				
Boundary conditions				
DC link voltage	U_{DC}	V	600	600
Water cooling inlet temperature	T_{VORL}	°C	35	35
Rated temperature of winding	T_N	°C	130	130
Data at the rated operating point				
Rated torque	M_N	Nm	338	298
Rated current	I_N	A	17.2	36.2
Rated speed	n_N	rpm	234	654
Rated power loss	$P_{V,N}$	kW	2.66	2.64
Limit data				
Maximum torque	M_{MAX}	Nm	710	710
Maximum current	I_{MAX}	A	44.1	106
Electric motor power at M_{MAX}	$P_{EL,MAX}$	kW	23.3	39.8
Maximum speed	n_{MAX}	rpm	708	1560
Maximum speed at maximum torque	$n_{MAX,MMAX}$	rpm	108	332
Max. speed without VPM	$n_{MAX,INV}$	rpm	484	1160
No-load speed	$n_{MAX,0}$	rpm	354	849
Torque at $n = 1$ rpm	M_0	Nm	360	360
Current at M_0 and $n = 1$ rpm	I_0	A	18.4	44.1
Thermal static torque	M_0^*	Nm	257	257
Thermal stall current	I_0^*	A	13	31.2
Physical constants				
Torque constant at 20 °C	$k_{T,20}$	Nm/A	19.8	8.26
Voltage constant	k_E	V/(1000/min)	1200	500
Motor constant at 20 °C	$k_{M,20}$	Nm/(W) ^{0.5}	8.46	8.5
Thermal time constant	t_{TH}	s	60	60
No. of pole pairs	p	-	33	33
Cogging torque	M_{COG}	Nm	1.8	1.8
Stator mass	m_S	kg	17.9	17.9
Rotor mass	m_L	kg	3.78	3.78
Rotor moment of inertia	J_L	10 ⁻² kgm ²	10.1	10.1
Phase resistance of winding at 20 °C	$R_{STR, 20}$	Ω	1.83	0.315
Phase inductance of winding	L_{STR}	mH	9.43	1.64

Technical data	Symbol	Unit	-xxB05-1Jxx	-xxB05-4Fxx
1FW6150				
Data for main motor cooler				
Maximum dissipated thermal power	$Q_{H,MAX}$	kW	2.21	2.19
Recommended minimum volume flow	$\dot{V}_{H,MIN}$	l/min	4.5	4.5
Cooling medium temperature increase	ΔT_H	K	7.08	7.01
Pressure drop	Δp_H	bar	0.185	0.185

Characteristics for 1FW6150-xxB05-xxxx

Torque M with respect to speed n

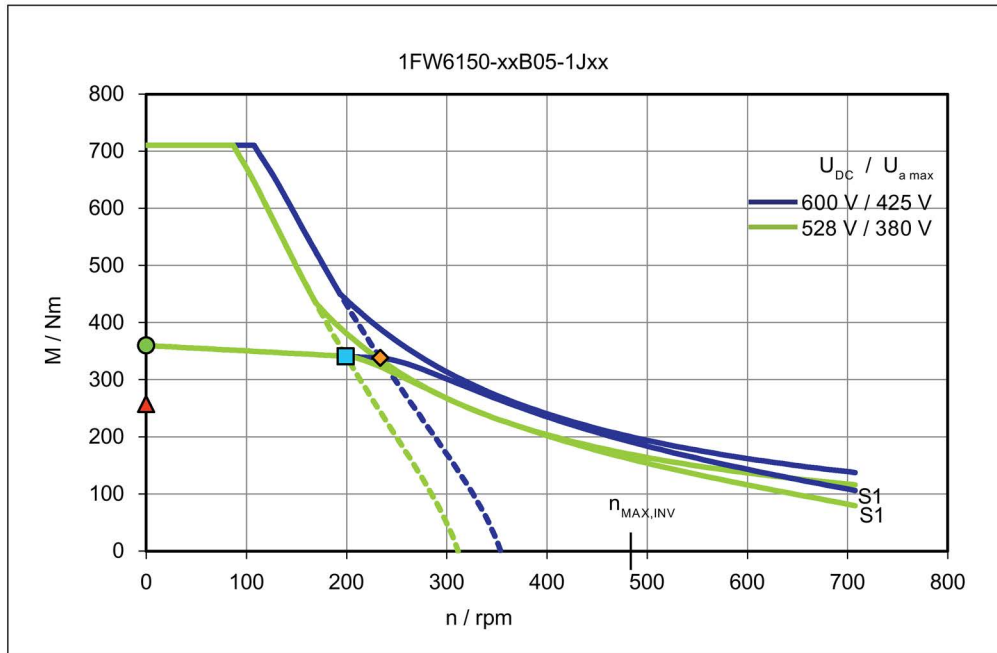

Torque M with respect to speed n

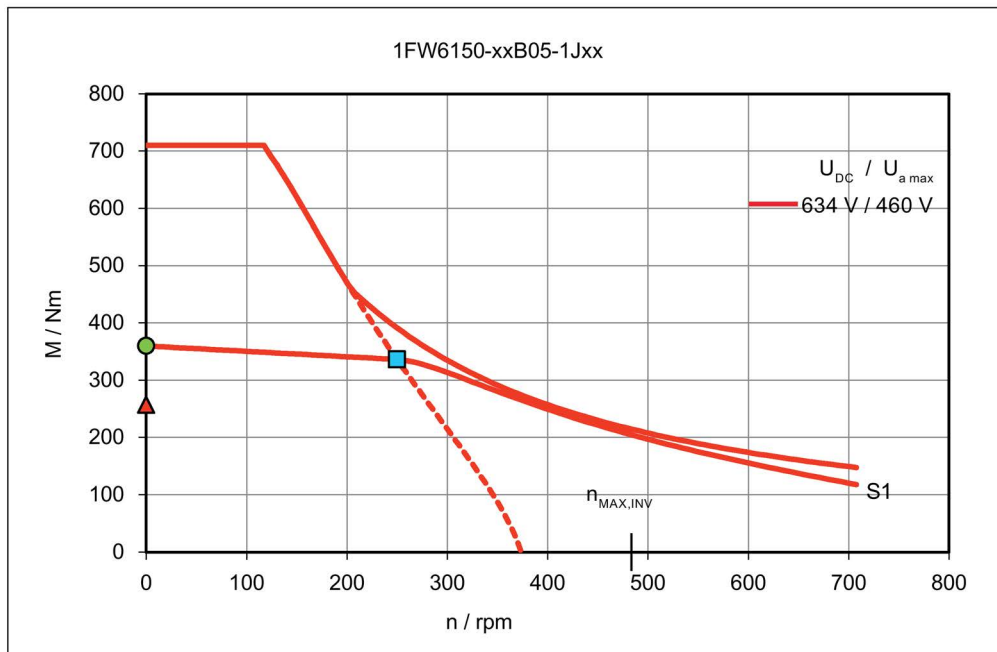

Torque M with respect to speed n

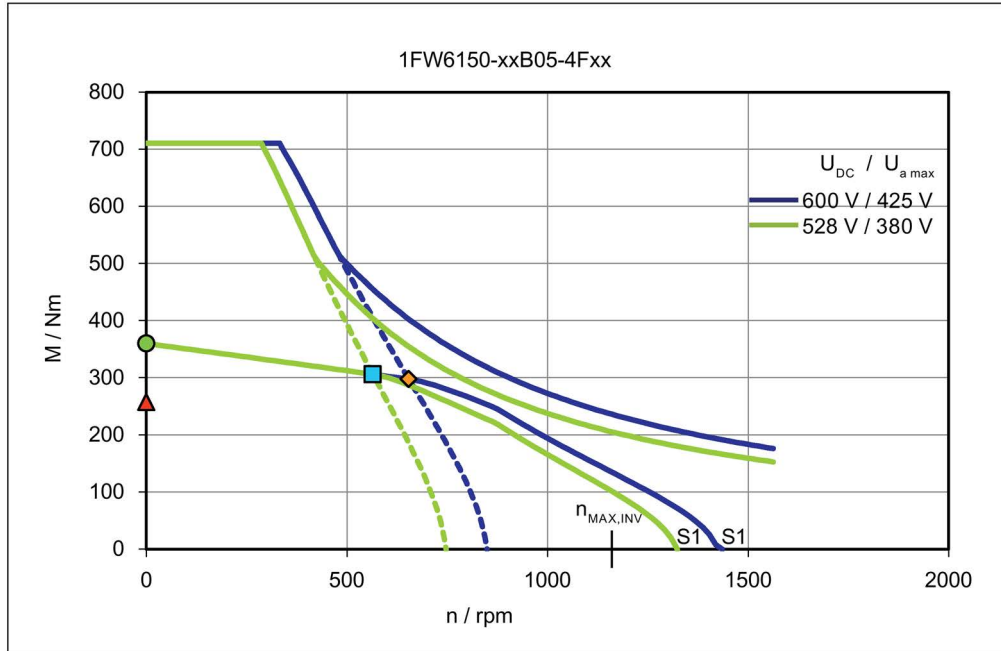

Torque M with respect to speed n

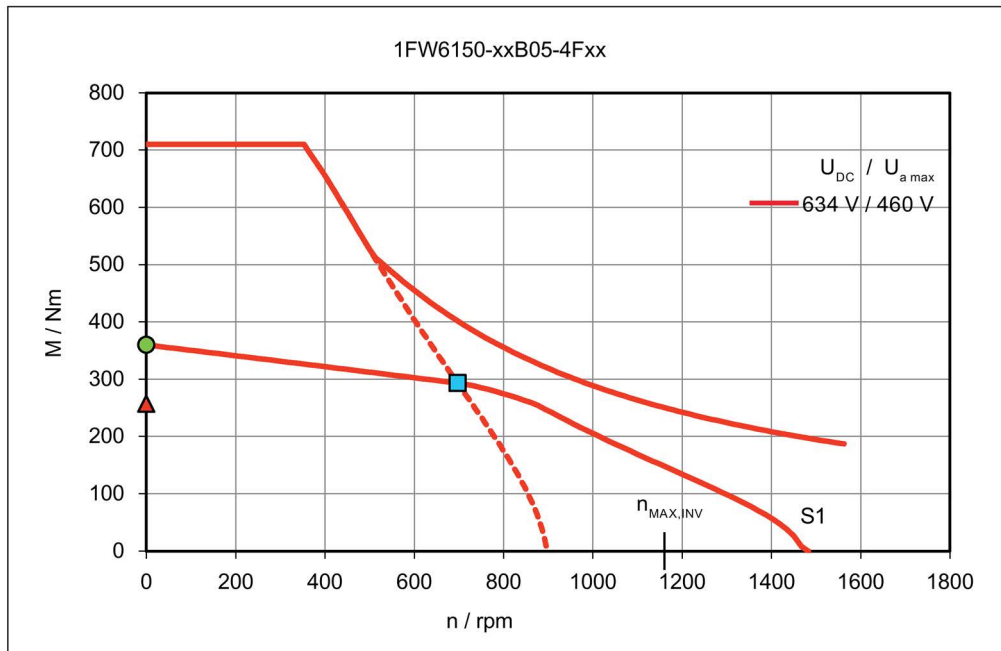

Short-circuit braking torque M_{Br} with respect to speed n

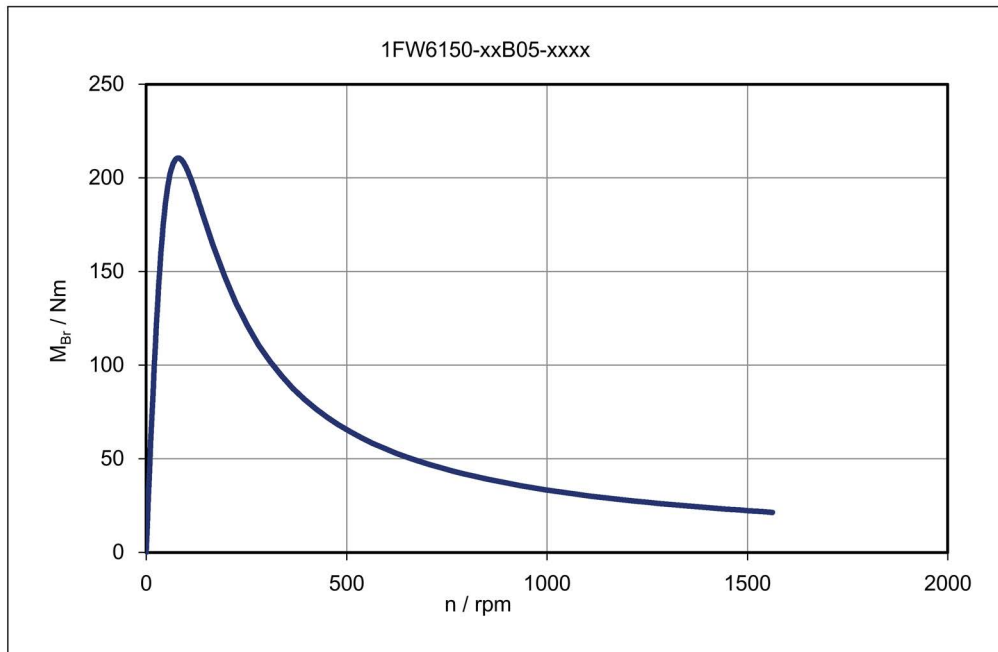

Main cooler - pressure losses Δp with respect to the volume flow \dot{V}

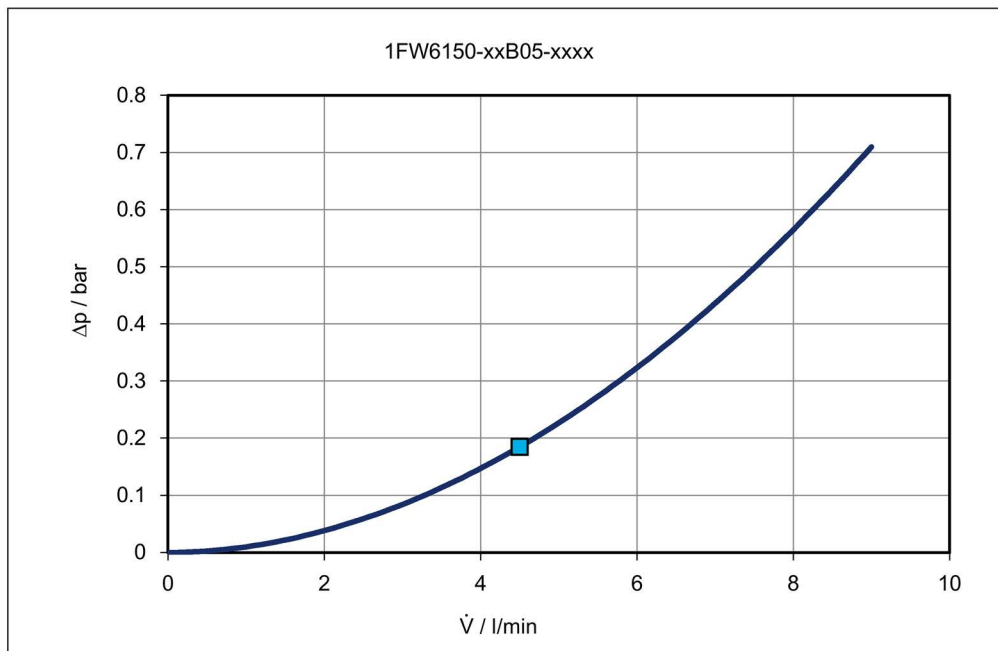

Rotor power loss P_{LV} with respect to speed n

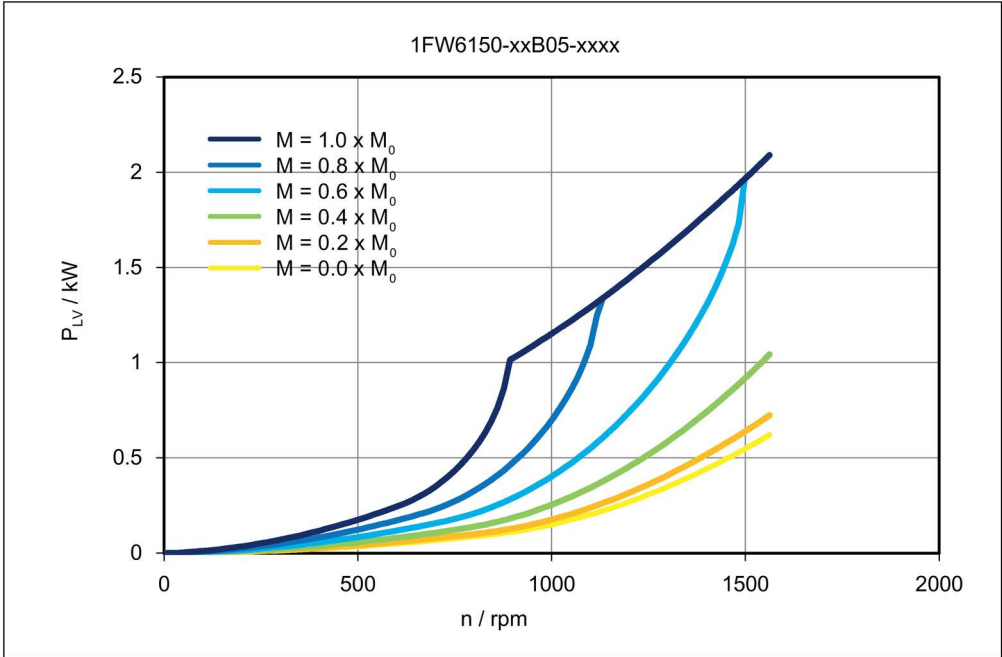

Data sheet 1FW6150-xxB07-xxxx

Table 6- 21 1FW6150-xxB07-2Jxx, 1FW6150-xxB07-4Fxx

Technical data	Symbol	Unit	-xxB07-2Jxx	-xxB07-4Fxx
1FW6150				
Boundary conditions				
DC link voltage	U_{DC}	V	600	600
Water cooling inlet temperature	T_{VORL}	°C	35	35
Rated temperature of winding	T_N	°C	130	130
Data at the rated operating point				
Rated torque	M_N	Nm	470	444
Rated current	I_N	A	25.6	38.7
Rated speed	n_N	rpm	259	449
Rated power loss	$P_{V,N}$	kW	3.38	3.34
Limit data				
Maximum torque	M_{MAX}	Nm	994	994
Maximum current	I_{MAX}	A	66.1	106
Electric motor power at M_{MAX}	$P_{EL,MAX}$	kW	32.5	43.2
Maximum speed	n_{MAX}	rpm	758	1210
Maximum speed at maximum torque	$n_{MAX,MMAX}$	rpm	126	230
Max. speed without VPM	$n_{MAX,INV}$	rpm	518	829
No-load speed	$n_{MAX,0}$	rpm	379	607
Torque at $n = 1$ rpm	M_0	Nm	504	504
Current at M_0 and $n = 1$ rpm	I_0	A	27.6	44.1
Thermal static torque	M_0^*	Nm	360	360
Thermal stall current	I_0^*	A	19.5	31.2
Physical constants				
Torque constant at 20 °C	$k_{T,20}$	Nm/A	18.5	11.6
Voltage constant	k_E	V/(1000/min)	1120	699
Motor constant at 20 °C	$k_{M,20}$	Nm/(W) ^{0.5}	10.5	10.6
Thermal time constant	t_{TH}	s	60	60
No. of pole pairs	p	-	33	33
Cogging torque	M_{COG}	Nm	2.52	2.52
Stator mass	m_S	kg	24.7	24.7
Rotor mass	m_L	kg	8.82	8.82
Rotor moment of inertia	J_L	10 ⁻² kgm ²	14.2	14.2
Phase resistance of winding at 20 °C	$R_{STR, 20}$	Ω	1.03	0.399
Phase inductance of winding	L_{STR}	mH	5.81	2.27

Technical data	Symbol	Unit	-xxB07-2Jxx	-xxB07-4Fxx
1FW6150				
Data for main motor cooler				
Maximum dissipated thermal power	$Q_{H,MAX}$	kW	2.81	2.78
Recommended minimum volume flow	$\dot{V}_{H,MIN}$	l/min	6.5	6.5
Cooling medium temperature increase	ΔT_H	K	6.22	6.15
Pressure drop	Δp_H	bar	0.378	0.378

Characteristics for 1FW6150-xxB07-xxxx

Torque M with respect to speed n

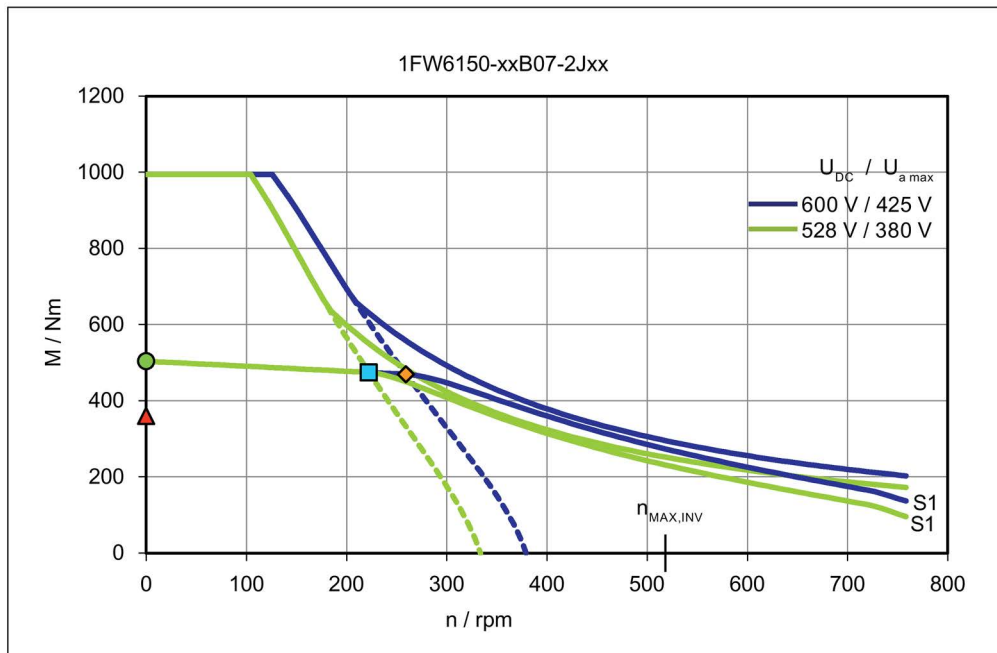

Torque M with respect to speed n

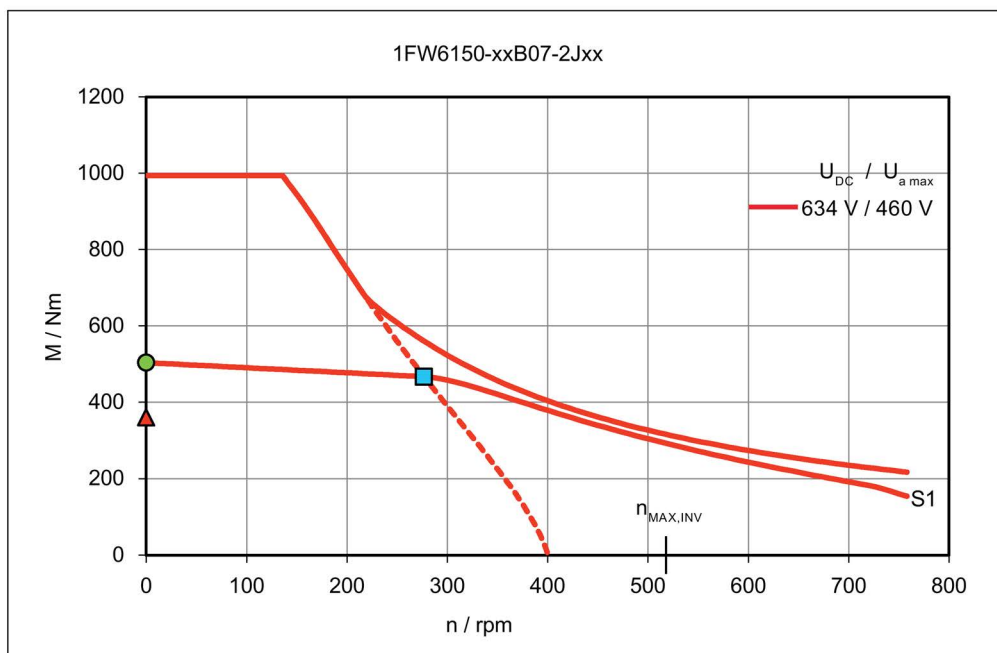

Torque M with respect to speed n

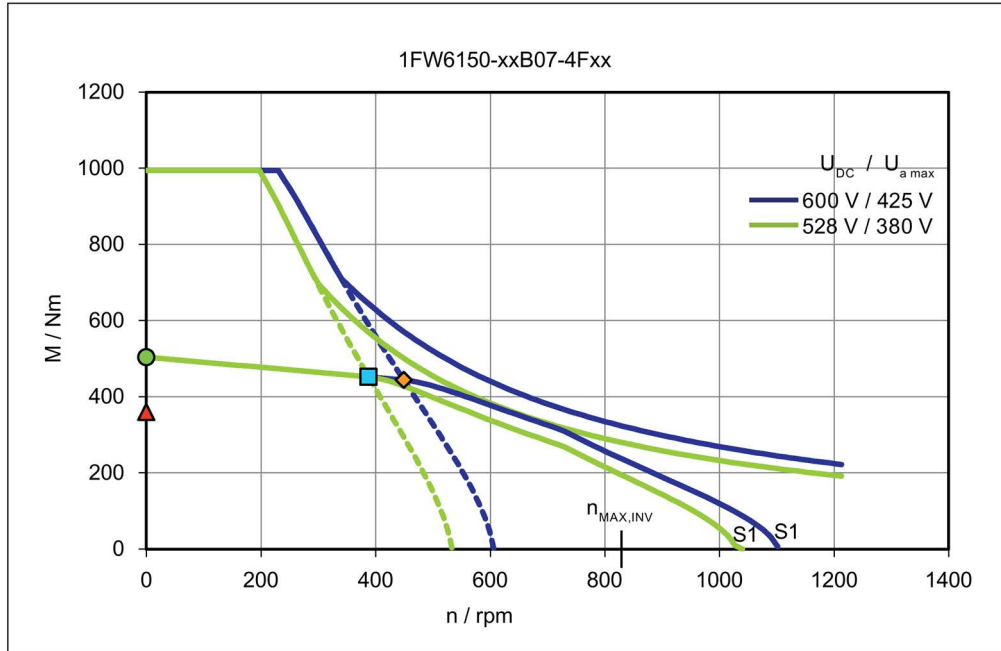

Torque M with respect to speed n

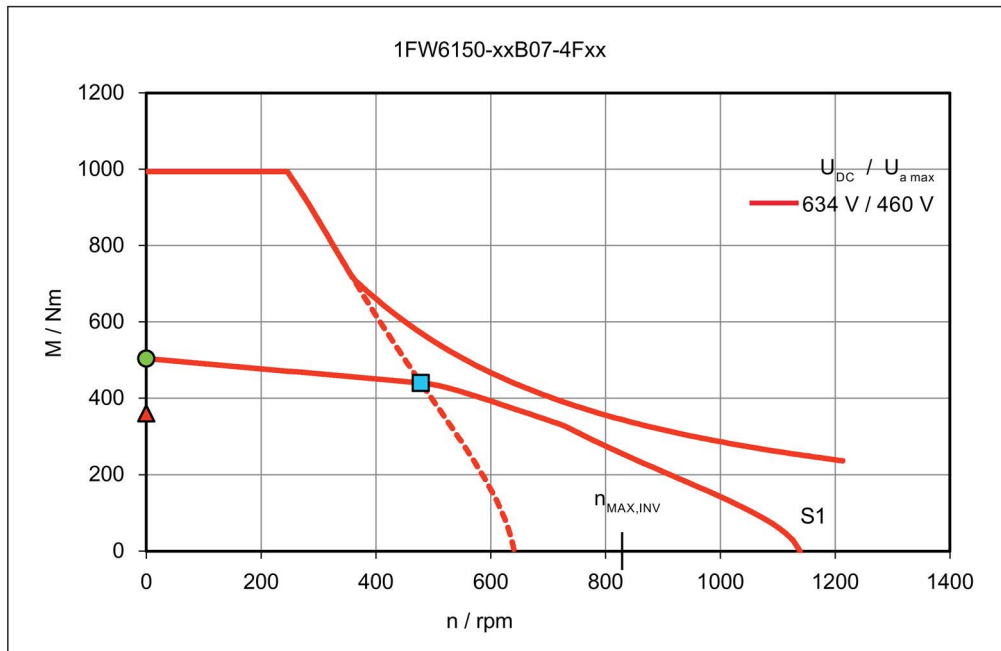

Short-circuit braking torque M_{Br} with respect to speed n

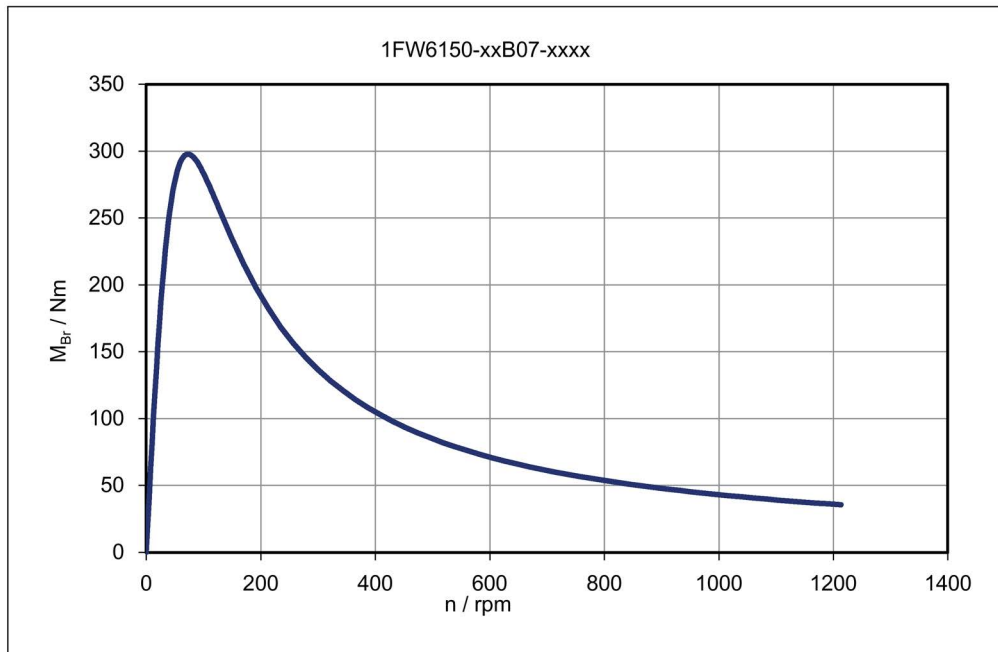

Main cooler - pressure losses Δp with respect to the volume flow \dot{V}

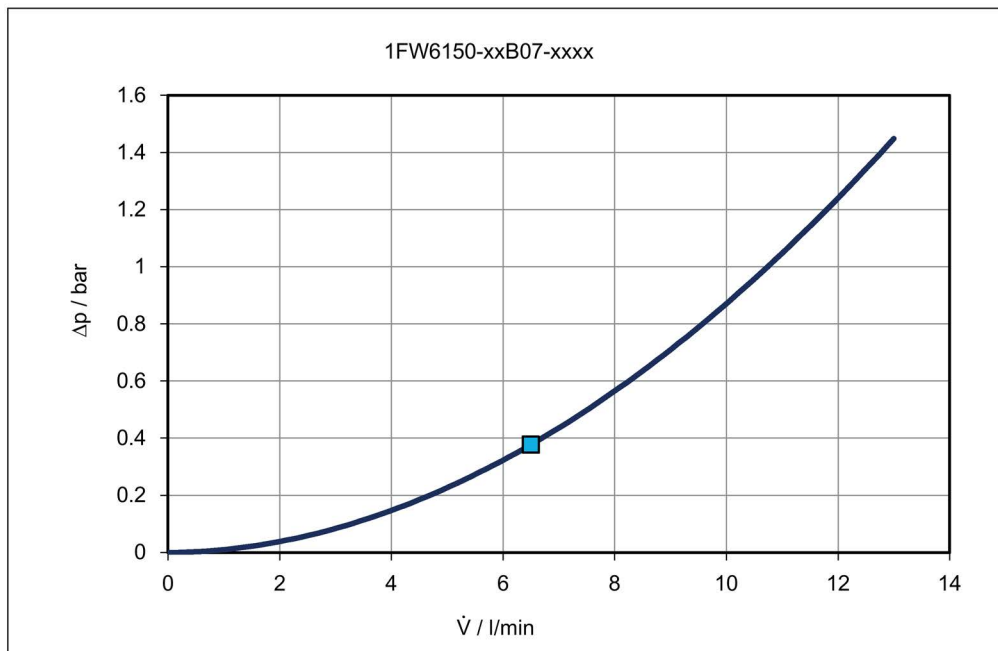

Rotor power loss P_{LV} with respect to speed n

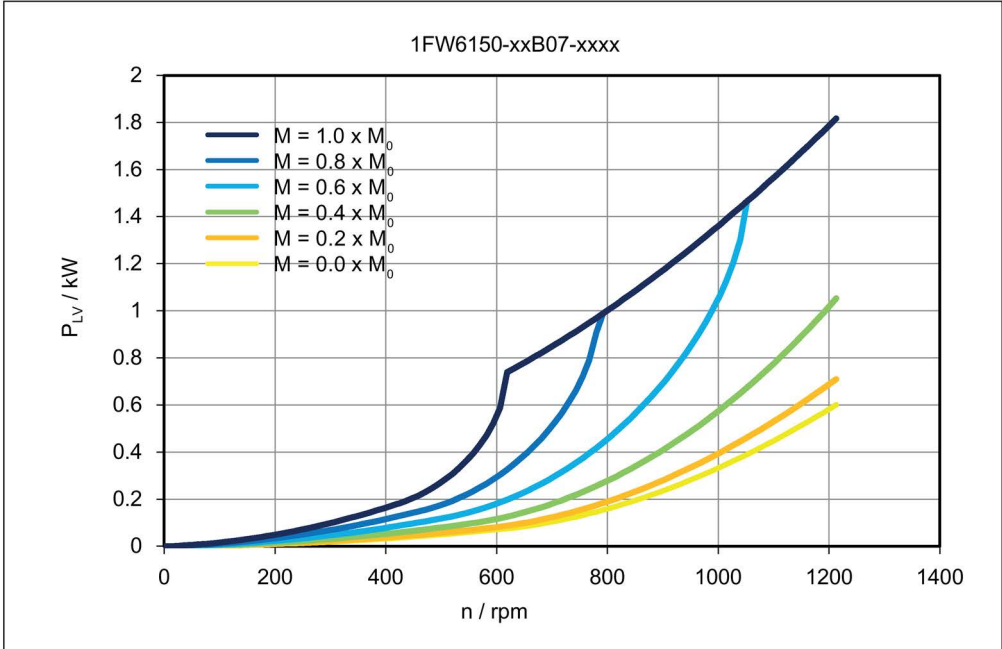

Data sheet 1FW6150-xxB10-xxxx

Table 6- 22 1FW6150-xxB10-2Jxx, 1FW6150-xxB10-4Fxx

Technical data	Symbol	Unit	-xxB10-2Jxx	-xxB10-4Fxx
1FW6150				
Boundary conditions				
DC link voltage	U_{DC}	V	600	600
Water cooling inlet temperature	T_{VORL}	°C	35	35
Rated temperature of winding	T_N	°C	130	130
Data at the rated operating point				
Rated torque	M_N	Nm	688	663
Rated current	I_N	A	26.3	40.5
Rated speed	n_N	rpm	171	301
Rated power loss	$P_{V,N}$	kW	4.46	4.4
Limit data				
Maximum torque	M_{MAX}	Nm	1420	1420
Maximum current	I_{MAX}	A	66.1	106
Electric motor power at M_{MAX}	$P_{EL,MAX}$	kW	36.9	47.9
Maximum speed	n_{MAX}	rpm	531	849
Maximum speed at maximum torque	$n_{MAX,MMAX}$	rpm	75.9	152
Max. speed without VPM	$n_{MAX,INV}$	rpm	363	580
No-load speed	$n_{MAX,0}$	rpm	265	425
Torque at $n = 1$ rpm	M_0	Nm	720	720
Current at M_0 and $n = 1$ rpm	I_0	A	27.6	44.1
Thermal static torque	M_0^*	Nm	515	515
Thermal stall current	I_0^*	A	19.5	31.2
Physical constants				
Torque constant at 20 °C	$k_{T,20}$	Nm/A	26.4	16.5
Voltage constant	k_E	V/(1000/min)	1600	999
Motor constant at 20 °C	$k_{M,20}$	Nm/(W) ^{0.5}	13.1	13.2
Thermal time constant	t_{TH}	s	60	60
No. of pole pairs	p	-	33	33
Cogging torque	M_{COG}	Nm	3.6	3.6
Stator mass	m_S	kg	34.9	34.9
Rotor mass	m_L	kg	12.6	12.6
Rotor moment of inertia	J_L	10 ⁻² kgm ²	20.9	20.9
Phase resistance of winding at 20 °C	$R_{STR, 20}$	Ω	1.36	0.526
Phase inductance of winding	L_{STR}	mH	8.24	3.22

Technical data	Symbol	Unit	-xxB10-2Jxx	-xxB10-4Fxx
1FW6150				
Data for main motor cooler				
Maximum dissipated thermal power	$Q_{H,MAX}$	kW	3.71	3.66
Recommended minimum volume flow	$\dot{V}_{H,MIN}$	l/min	7.5	7.5
Cooling medium temperature increase	ΔT_H	K	7.11	7.02
Pressure drop	Δp_H	bar	0.498	0.498

Characteristics for 1FW6150-xxB10-xxxx

Torque M with respect to speed n

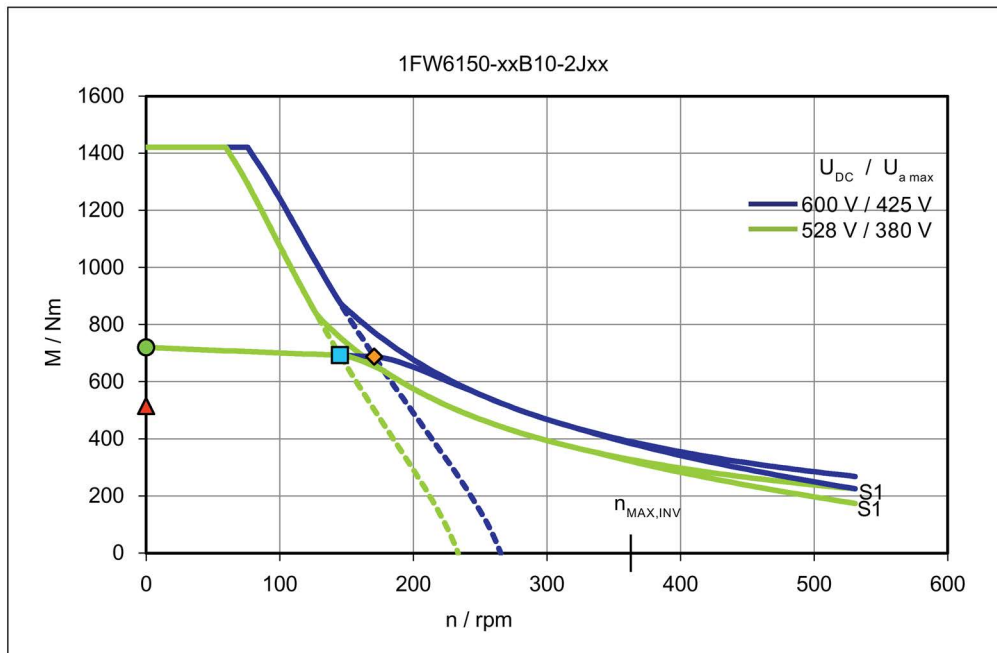

Torque M with respect to speed n

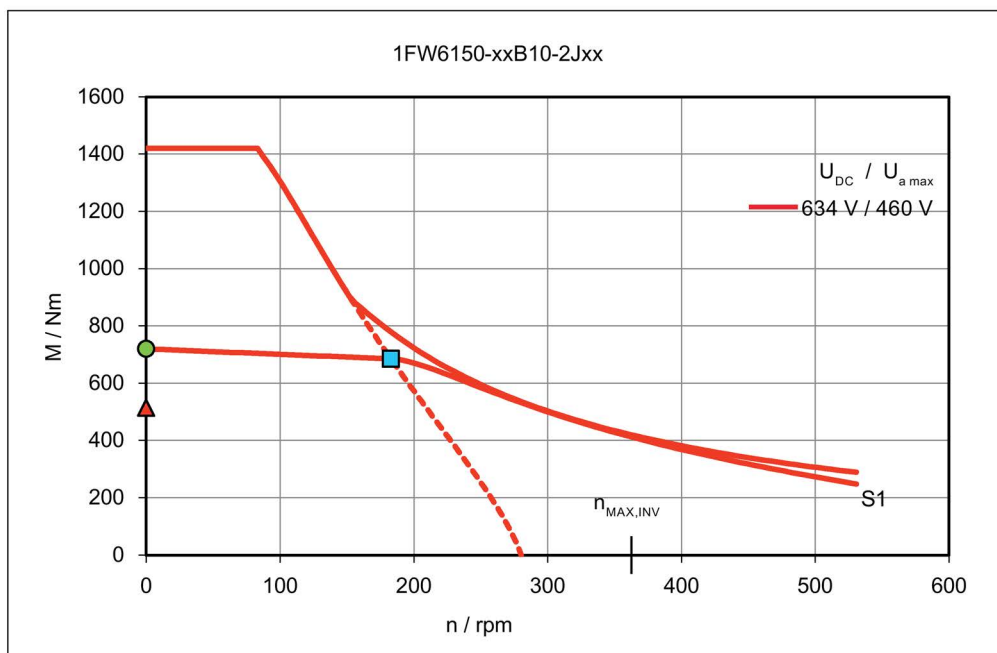

Torque M with respect to speed n

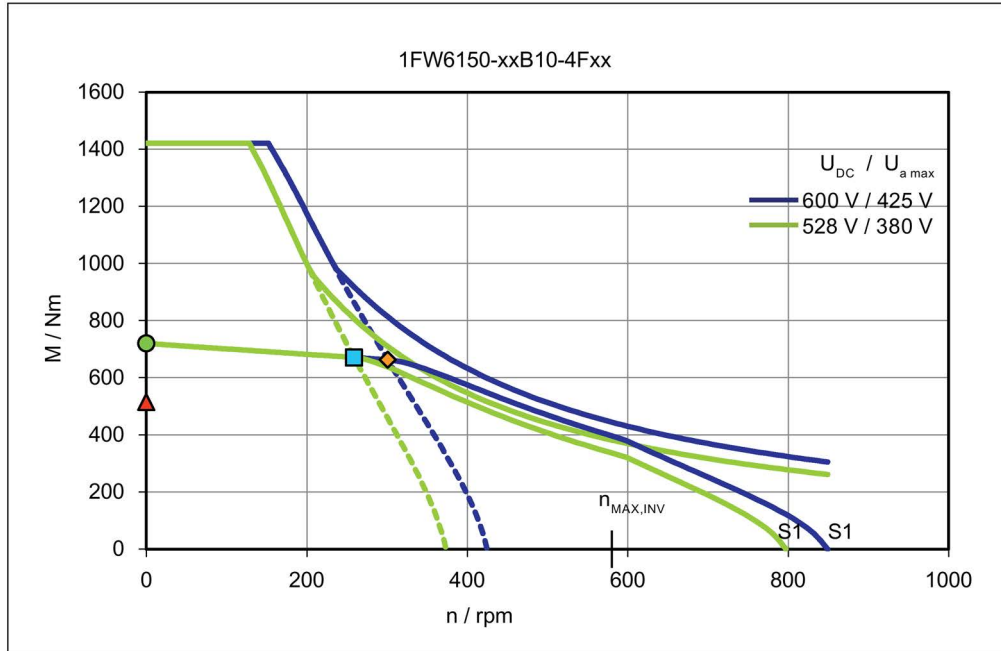

Torque M with respect to speed n

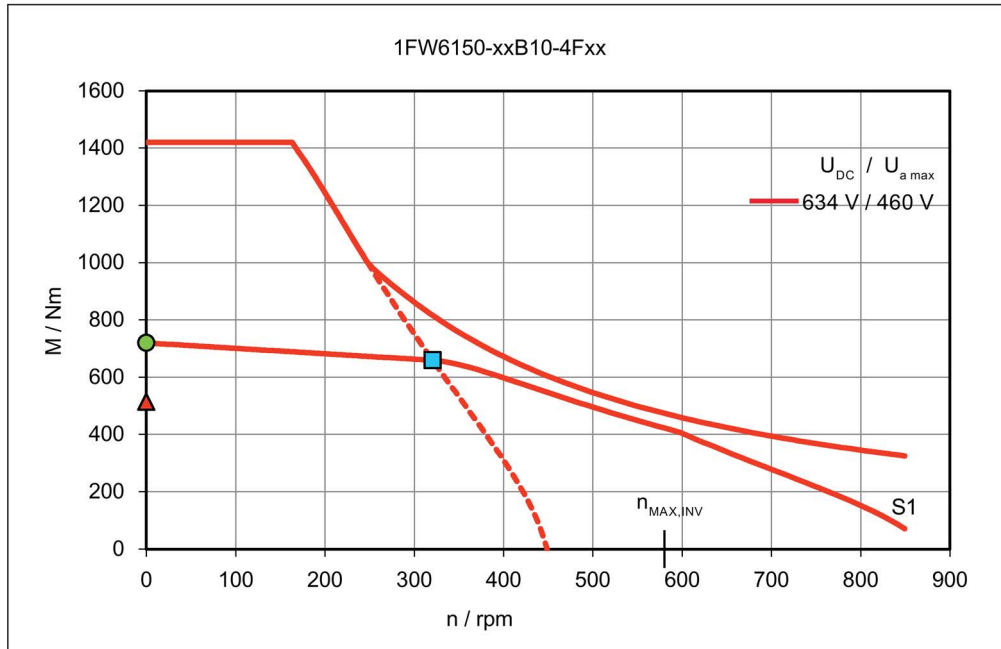

Short-circuit braking torque M_{Br} with respect to speed n

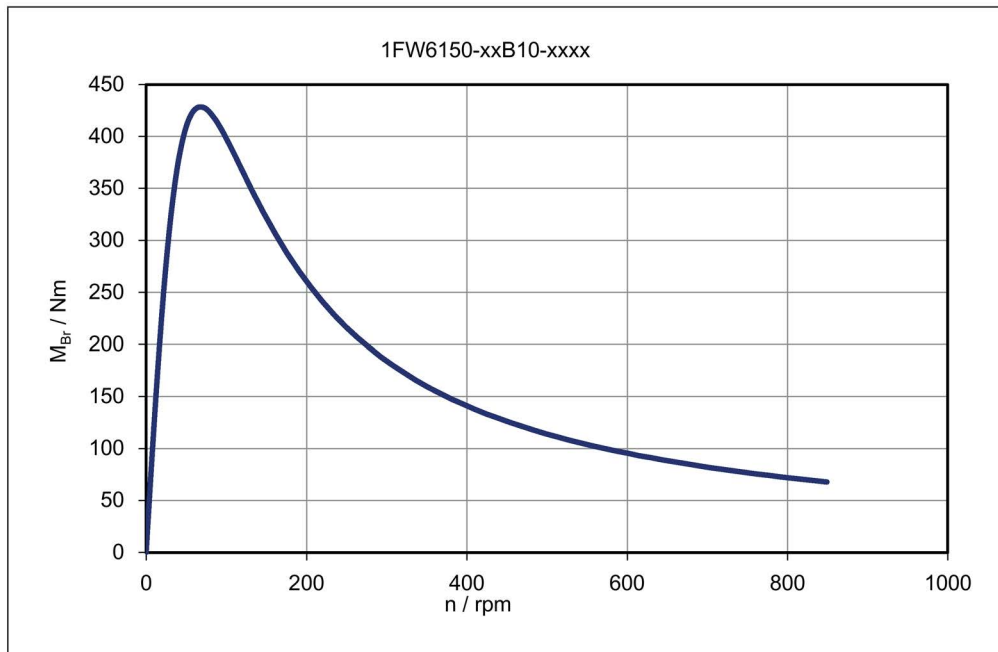

Main cooler - pressure losses Δp with respect to the volume flow \dot{V}

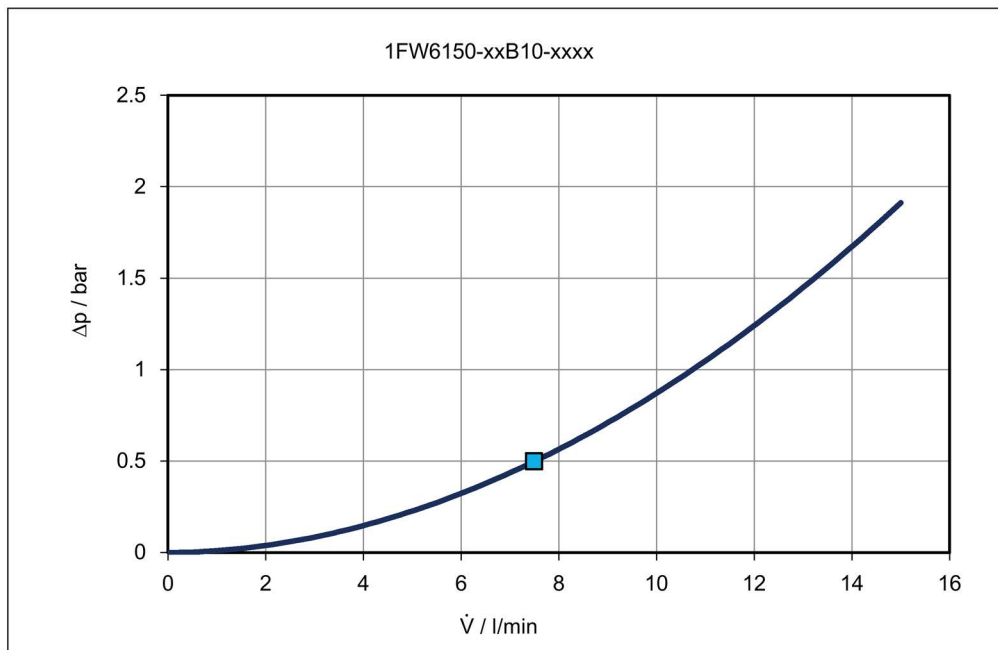

Rotor power loss P_{LV} with respect to speed n

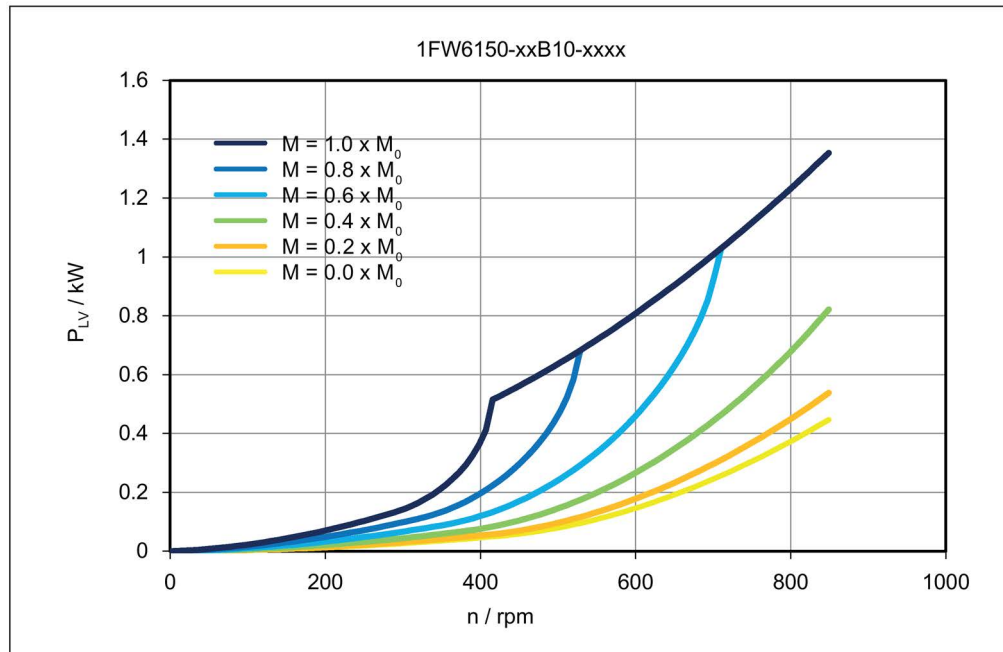

Data sheet 1FW6150-xxB15-xxxx

Table 6- 23 1FW6150-xxB15-2Jxx, 1FW6150-xxB15-4Fxx

Technical data	Symbol	Unit	-xxB15-2Jxx	-xxB15-4Fxx
1FW6150				
Boundary conditions				
DC link voltage	U_{DC}	V	600	600
Water cooling inlet temperature	T_{VORL}	°C	35	35
Rated temperature of winding	T_N	°C	130	130
Data at the rated operating point				
Rated torque	M_N	Nm	1050	1030
Rated current	I_N	A	26.8	41.9
Rated speed	n_N	rpm	103	188
Rated power loss	$P_{V,N}$	kW	6.25	6.17
Limit data				
Maximum torque	M_{MAX}	Nm	2130	2130
Maximum current	I_{MAX}	A	66.1	106
Electric motor power at M_{MAX}	$P_{EL,MAX}$	kW	43.2	55.3
Maximum speed	n_{MAX}	rpm	354	566
Maximum speed at maximum torque	$n_{MAX,MMAX}$	rpm	33.1	89.1
Max. speed without VPM	$n_{MAX,INV}$	rpm	242	387
No-load speed	$n_{MAX,0}$	rpm	177	283
Torque at $n = 1$ rpm	M_0	Nm	1080	1080
Current at M_0 and $n = 1$ rpm	I_0	A	27.6	44.1
Thermal static torque	M_0^*	Nm	772	772
Thermal stall current	I_0^*	A	19.5	31.2
Physical constants				
Torque constant at 20 °C	$k_{T,20}$	Nm/A	39.7	24.8
Voltage constant	k_E	V/(1000/min)	2400	1500
Motor constant at 20 °C	$k_{M,20}$	Nm/(W) ^{0.5}	16.6	16.7
Thermal time constant	t_{TH}	s	60	60
No. of pole pairs	p	-	33	33
Cogging torque	M_{COG}	Nm	5.4	5.4
Stator mass	m_S	kg	51.9	51.9
Rotor mass	m_L	kg	18.9	18.9
Rotor moment of inertia	J_L	10 ⁻² kgm ²	31.3	31.3
Phase resistance of winding at 20 °C	$R_{STR,20}$	Ω	1.91	0.737
Phase inductance of winding	L_{STR}	mH	12.3	4.8

Technical data	Symbol	Unit	-xxB15-2Jxx	-xxB15-4Fxx
1FW6150				
Data for main motor cooler				
Maximum dissipated thermal power	$Q_{H,MAX}$	kW	5.2	5.13
Recommended minimum volume flow	$\dot{V}_{H,MIN}$	l/min	9.5	9.5
Cooling medium temperature increase	ΔT_H	K	7.87	7.77
Pressure drop	Δp_H	bar	0.788	0.788

Characteristics for 1FW6150-xxB15-xxxx

Torque M with respect to speed n

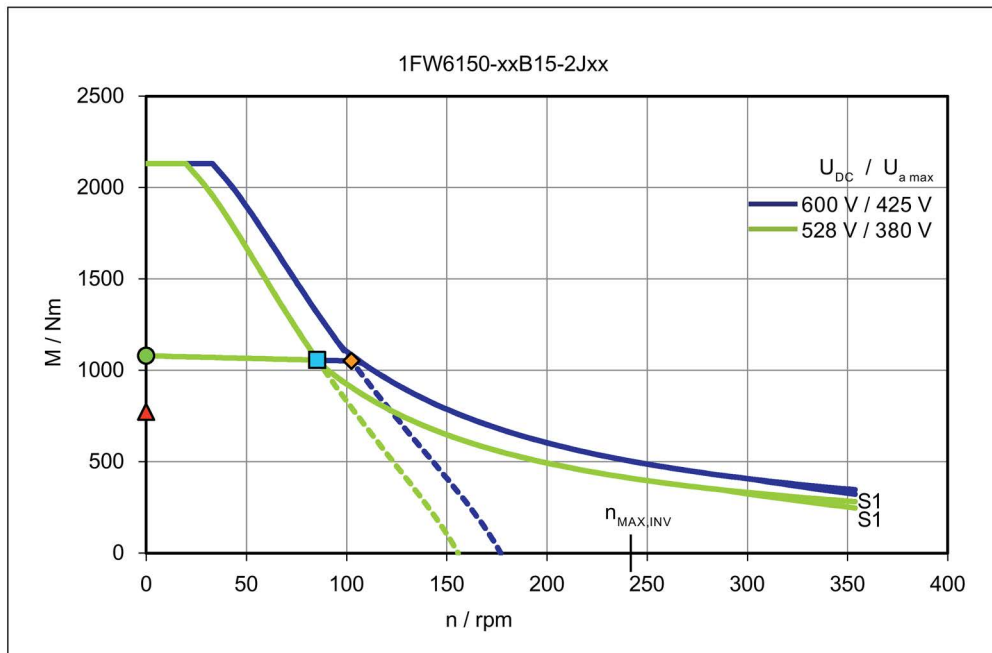

Torque M with respect to speed n

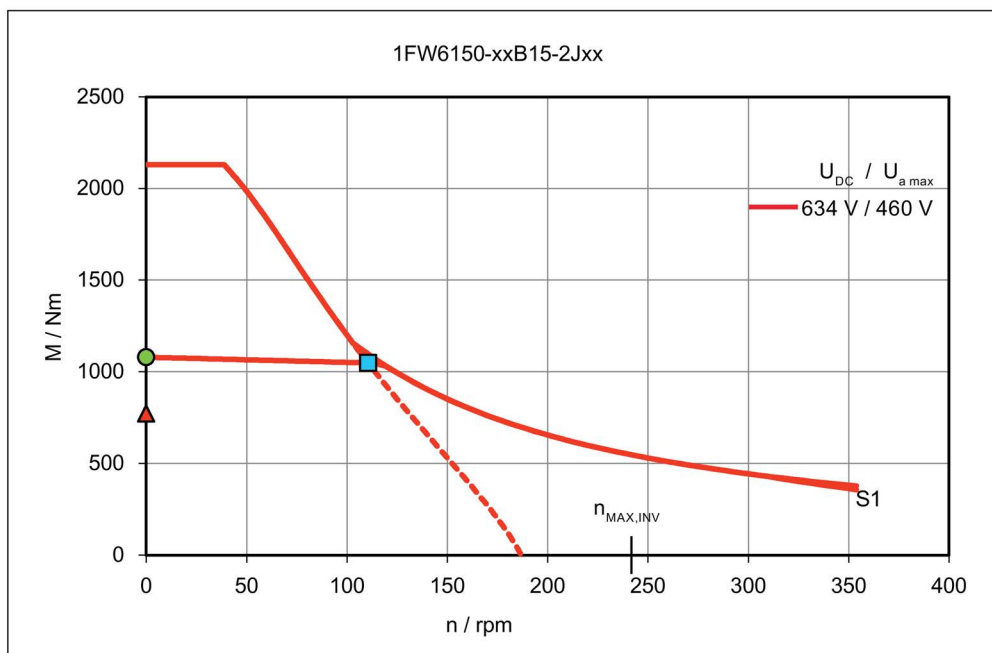

Torque M with respect to speed n

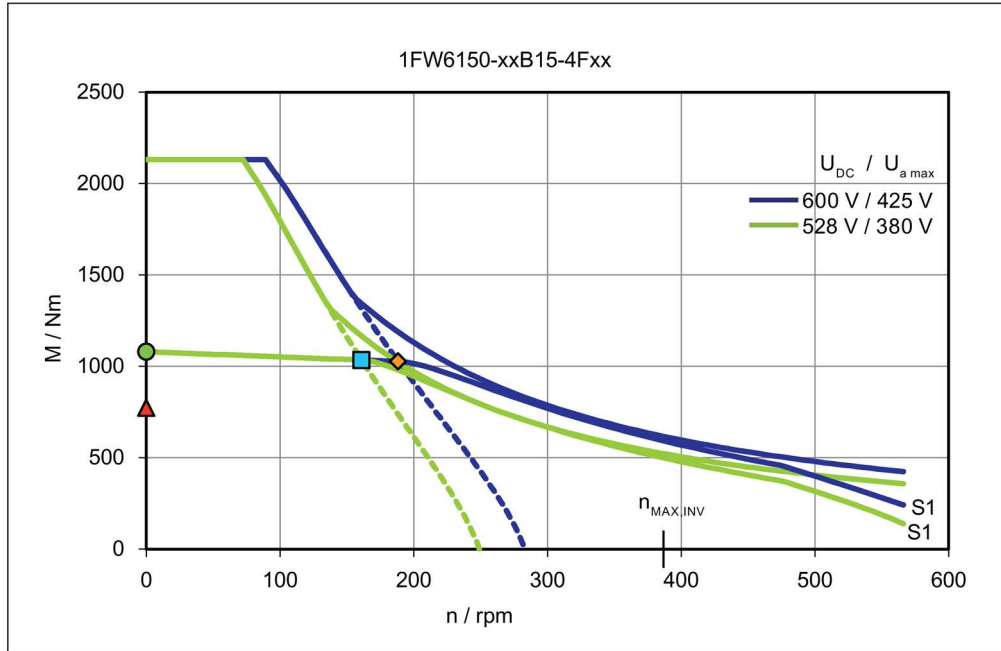

Torque M with respect to speed n

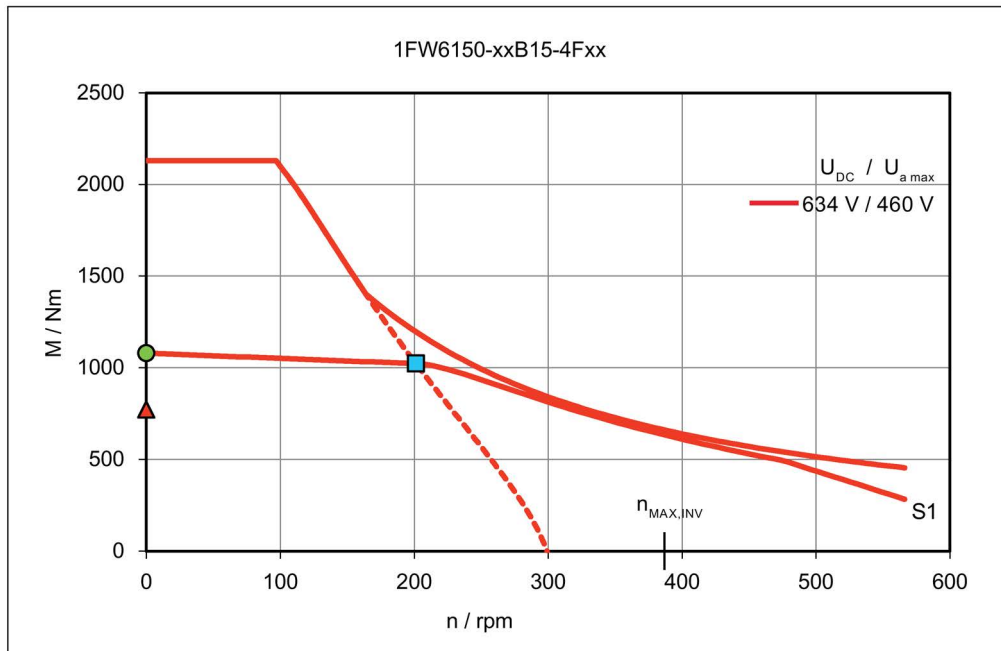

Short-circuit braking torque M_{Br} with respect to speed n

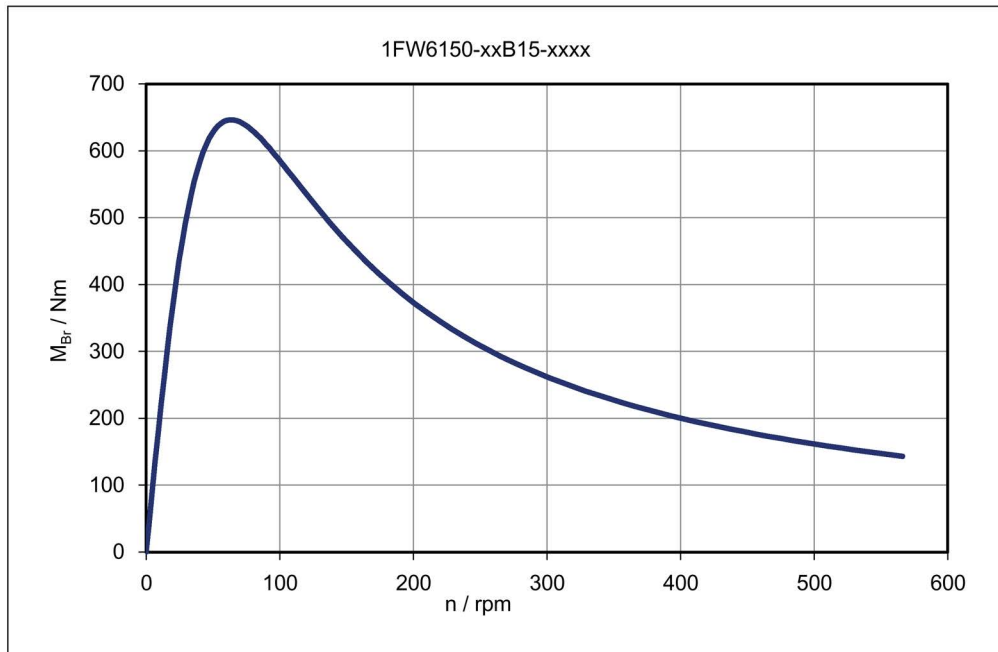

Main cooler - pressure losses Δp with respect to the volume flow \dot{V}

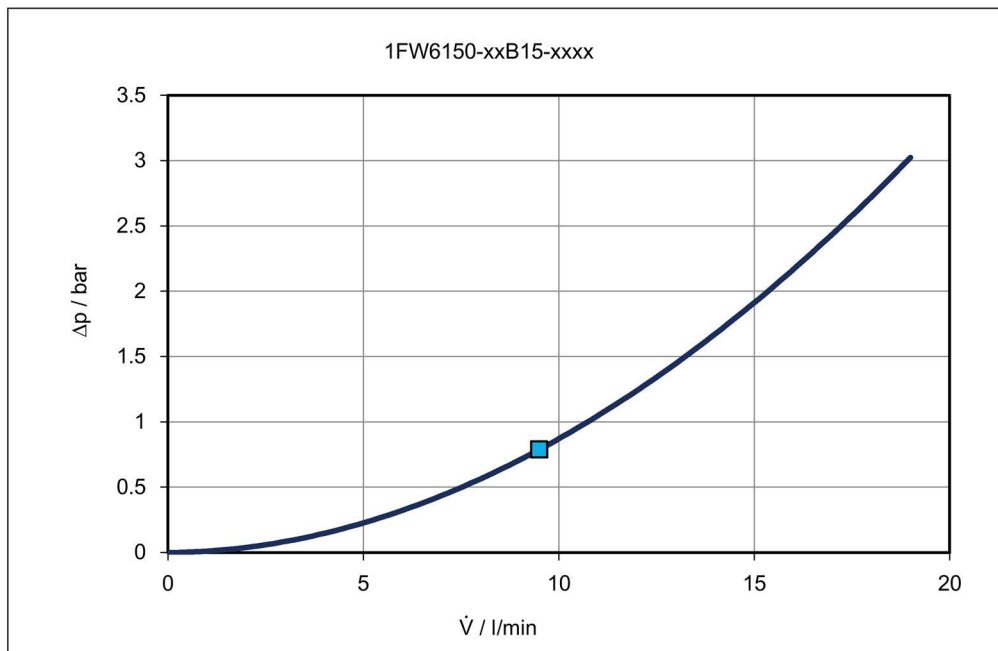

Rotor power loss P_{LV} with respect to speed n

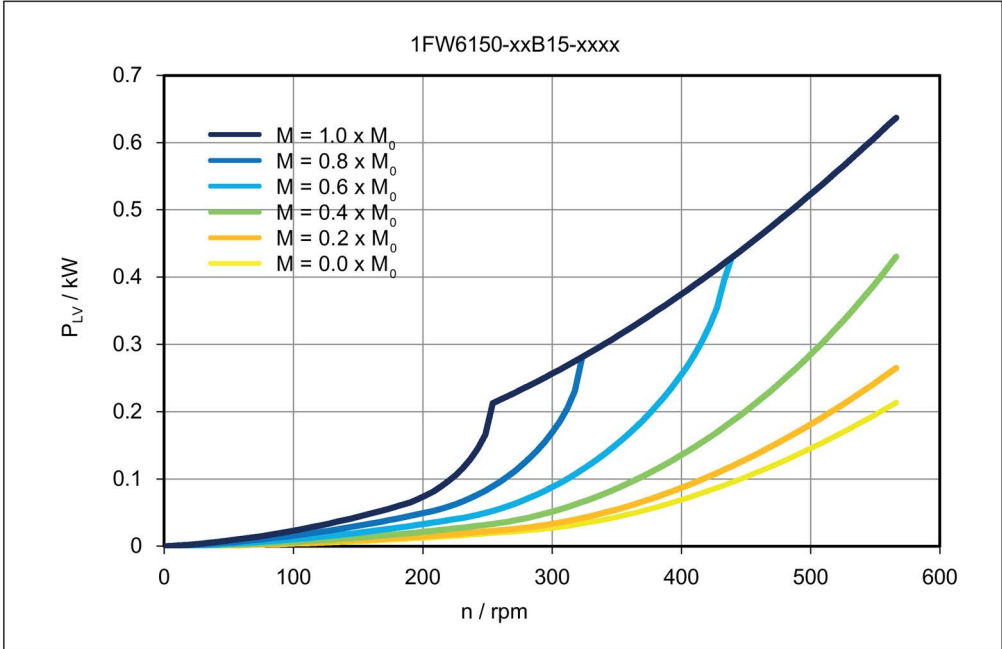

6.2.6 1FW6160-xxxxx-xxxx

Data sheet 1FW6160-xxB05-xxxx

Table 6- 24 1FW6160-xxB05-1Jxx, 1FW6160-xxB05-2Jxx, 1FW6160-xxB05-5Gxx

Technical data	Symbol	Unit	-xxB05-1Jxx	-xxB05-2Jxx	-xxB05-5Gxx
1FW6160					
Boundary conditions					
DC link voltage	U_{DC}	V	600	600	600
Water cooling inlet temperature	T_{VORL}	°C	35	35	35
Rated temperature of winding	T_N	°C	130	130	130
Data at the rated operating point					
Rated torque	M_N	Nm	432	405	317
Rated current	I_N	A	16.5	24.1	37.4
Rated speed	n_N	rpm	140	242	574
Rated power loss	$P_{V,N}$	kW	2.94	2.95	2.99
Limit data					
Maximum torque	M_{MAX}	Nm	716	716	716
Maximum current	I_{MAX}	A	31.6	49.4	98.8
Electric motor power at M_{MAX}	$P_{EL,MAX}$	kW	15.2	19.8	32.4
Maximum speed	n_{MAX}	rpm	485	759	1280
Maximum speed at maximum torque	$n_{MAX,MMAX}$	rpm	80.6	142	308
Max. speed without VPM	$n_{MAX,INV}$	rpm	332	518	1040
No-load speed	$n_{MAX,0}$	rpm	243	379	759
Torque at $n = 1$ rpm	M_0	Nm	467	467	467
Current at M_0 and $n = 1$ rpm	I_0	A	18	28.1	56.1
Thermal static torque	M_0^*	Nm	337	337	337
Thermal stall current	I_0^*	A	12.7	19.9	39.7
Physical constants					
Torque constant at 20 °C	$k_{T,20}$	Nm/A	26.6	17	8.51
Voltage constant	k_E	V/(1000/min)	1610	1030	515
Motor constant at 20 °C	$k_{M,20}$	Nm/(W) ^{0.5}	10.5	10.5	10.5
Thermal time constant	t_{TH}	s	180	180	180
No. of pole pairs	p	-	35	35	35
Cogging torque	M_{COG}	Nm	2.33	2.33	2.33
Stator mass	m_S	kg	27.2	27.2	27.2
Rotor mass	m_L	kg	9.1	9.1	9.1
Rotor moment of inertia	J_L	10 ⁻² kgm ²	19	19	19
Phase resistance of winding at 20 °C	$R_{STR, 20}$	Ω	2.12	0.872	0.221
Phase inductance of winding	L_{STR}	mH	18.1	7.41	1.85

Technical data	Symbol	Unit	-xxB05-1Jxx	-xxB05-2Jxx	-xxB05-5Gxx
1FW6160					
Data for main motor cooler *)					
Maximum dissipated thermal power	$Q_{H,MAX}$	kW	2.21	2.22	2.25
Recommended minimum volume flow	$\dot{V}_{H,MIN}$	l/min	3.84	3.84	3.84
Cooling medium temperature increase	ΔT_H	K	8.28	8.32	8.42
Pressure drop	Δp_H	bar	0.279	0.279	0.279
Data for precision motor cooler *)					
Maximum dissipated thermal power	$Q_{P,MAX}$	kW	0.238	0.239	0.242
Recommended minimum volume flow	$\dot{V}_{P,MIN}$	l/min	1.46	1.46	1.46
Cooling medium temperature increase	ΔT_P	K	2.35	2.36	2.38
Pressure drop	Δp_P	bar	0.279	0.279	0.279

*) Parallel connection of main and precision motor cooler

Characteristics for 1FW6160-xxB05-xxxx

Torque M with respect to speed n

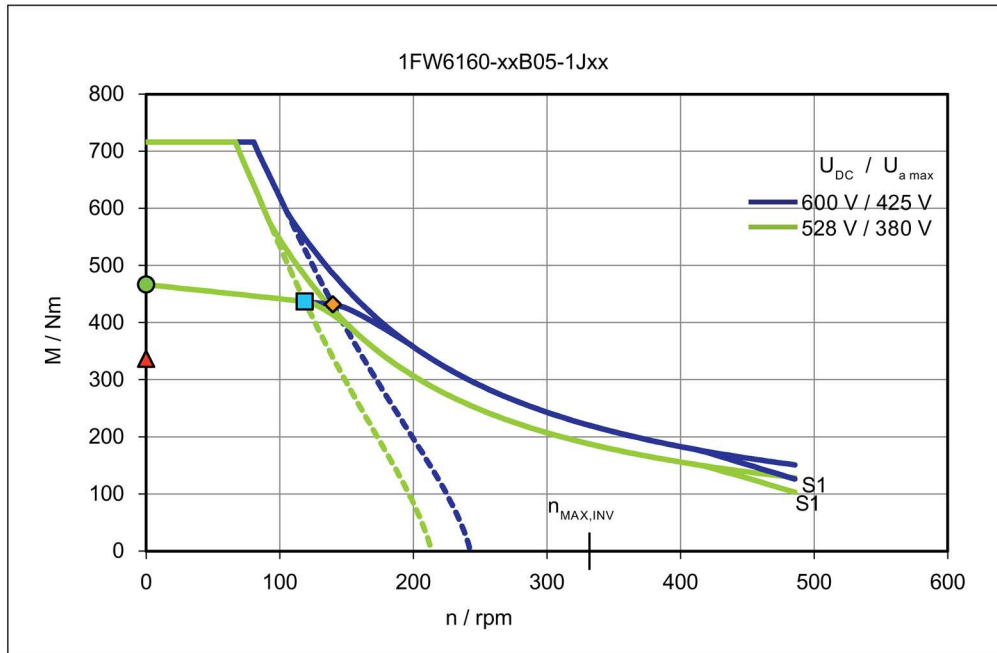

Torque M with respect to speed n

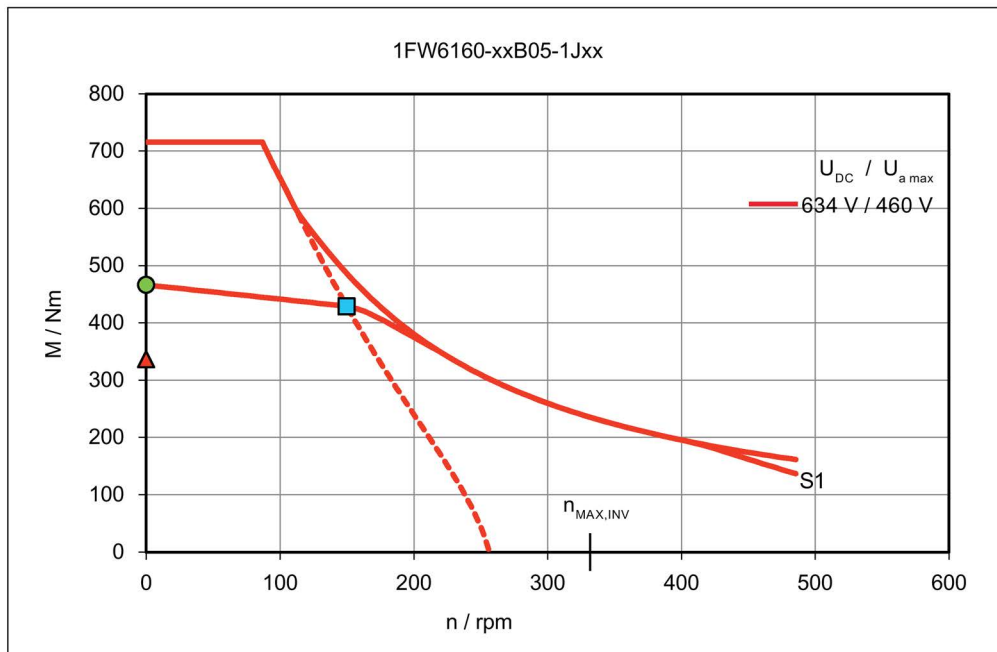

Torque M with respect to speed n

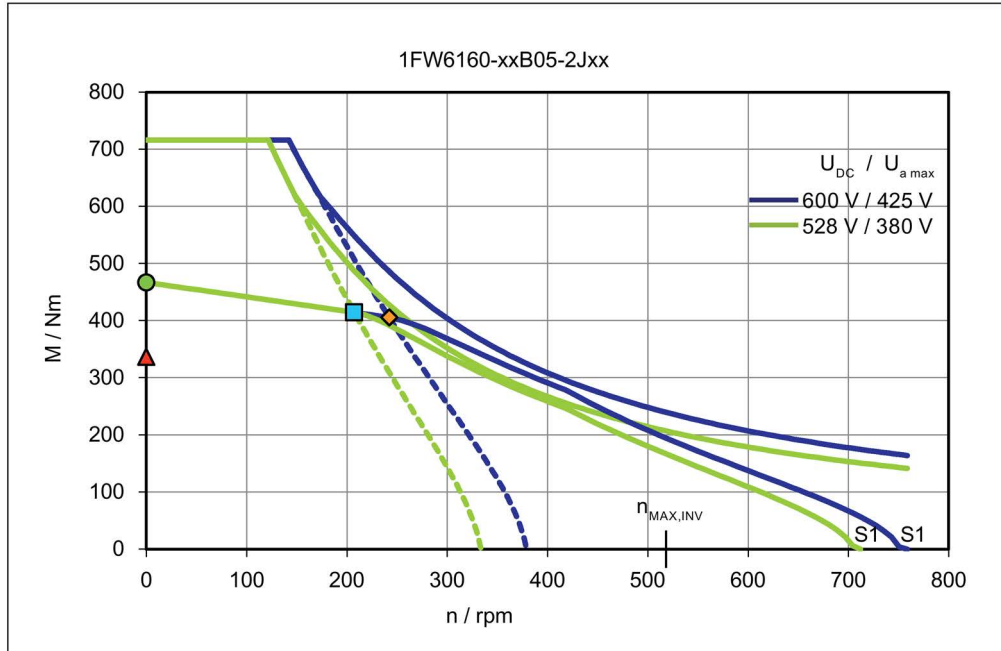

Torque M with respect to speed n

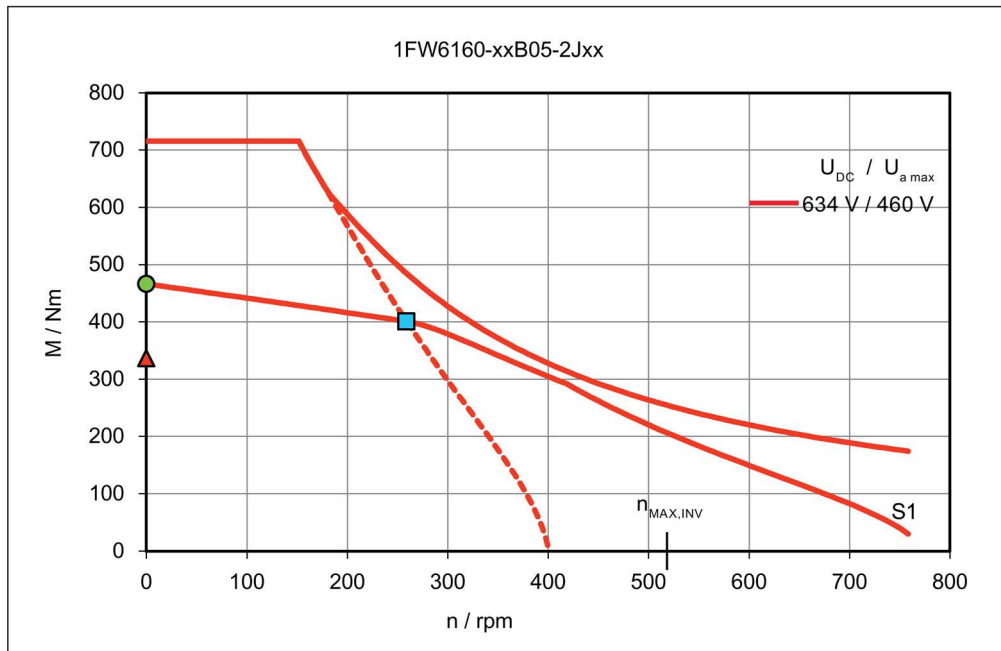

Torque M with respect to speed n

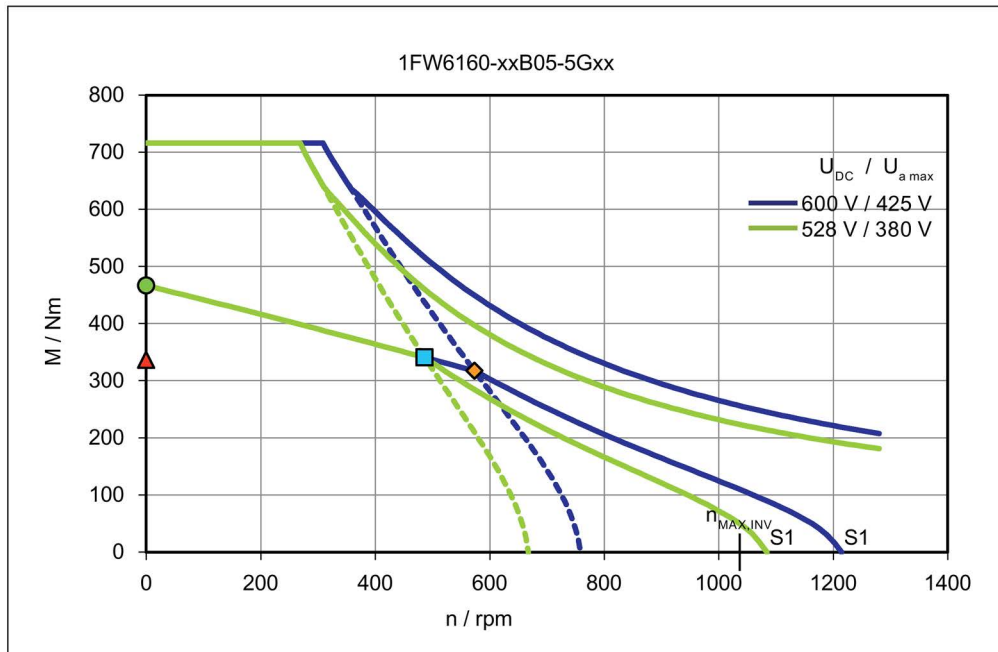

Torque M with respect to speed n

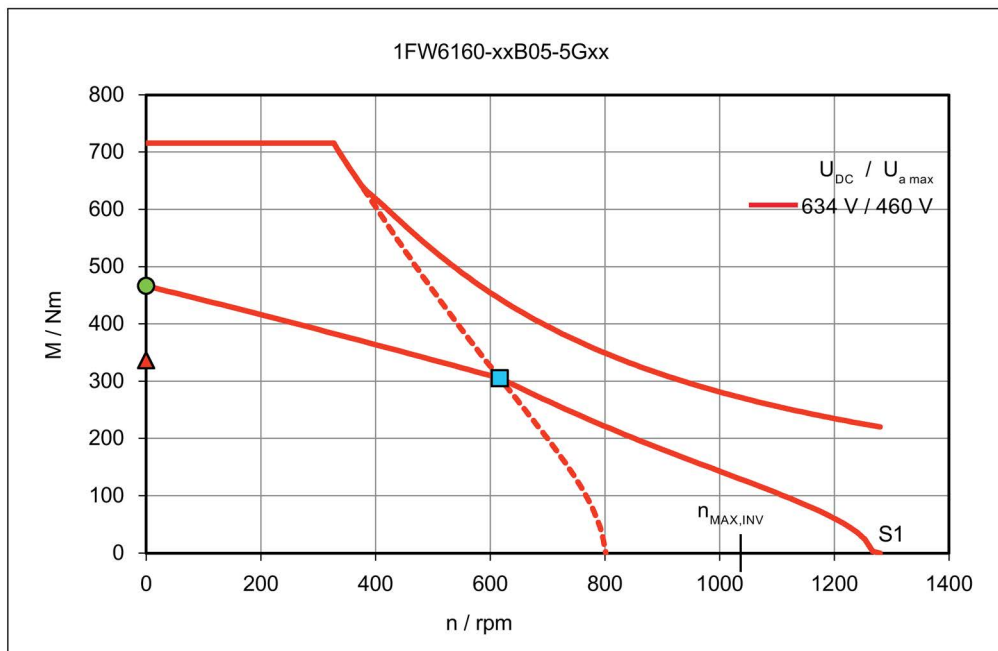

Short-circuit braking torque M_{Br} with respect to speed n

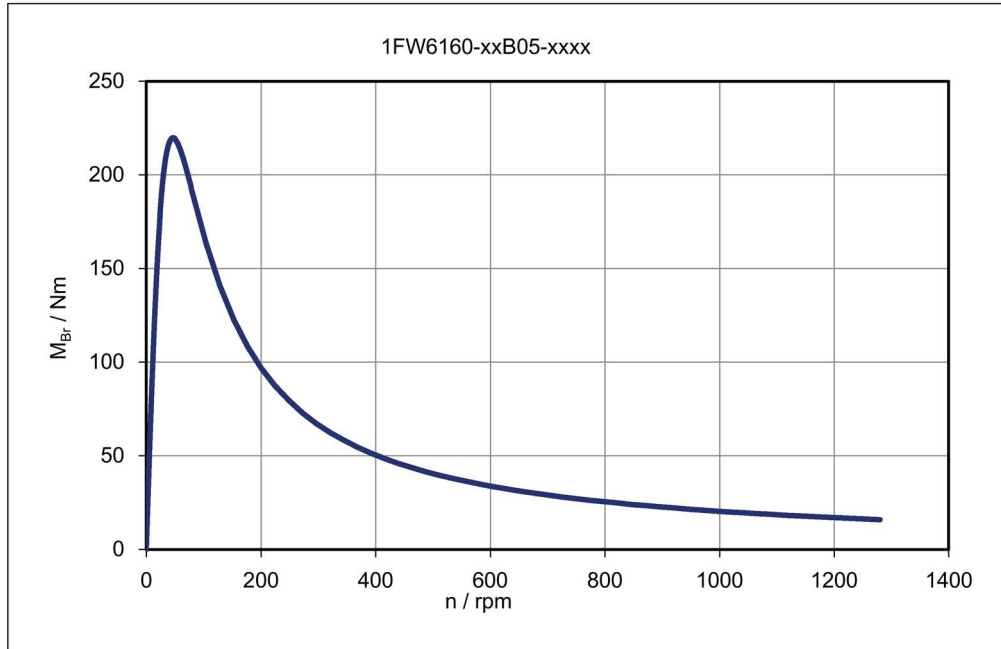

Main cooler and precision cooler - pressure losses Δp with respect to the flow rate \dot{V} (HK || PK: main cooler HK and precision cooler PK connected in parallel)

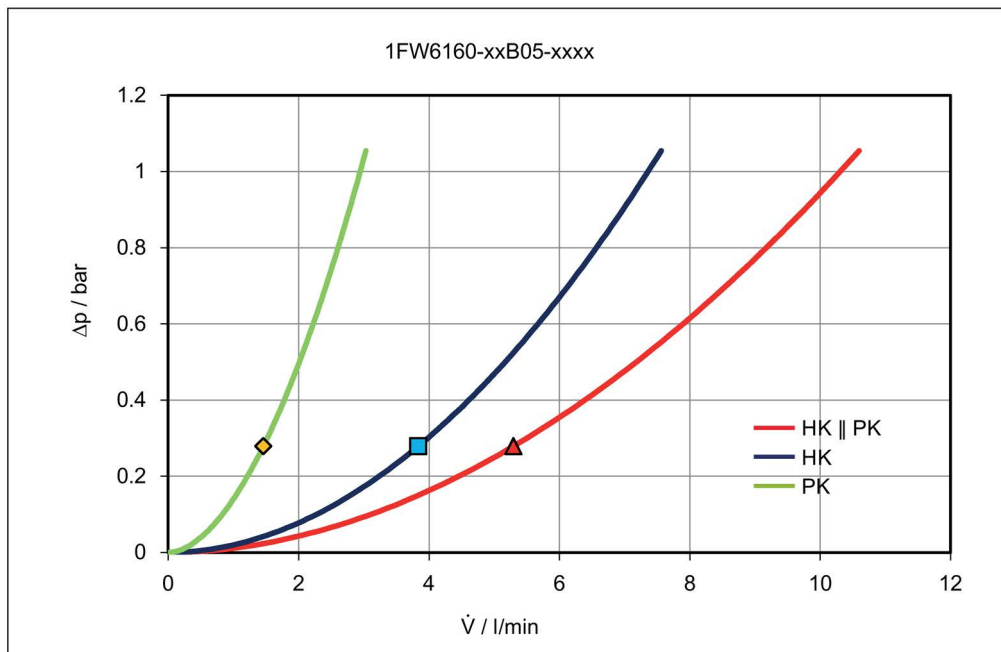

Rotor power loss P_{LV} with respect to speed n

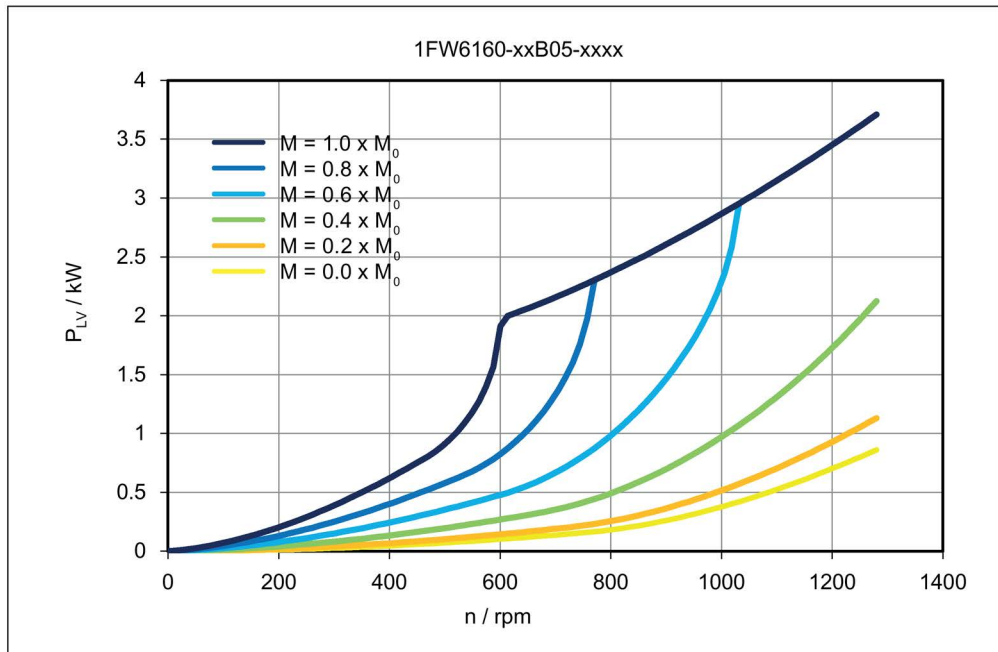

Data sheet 1FW6160-xxB07-xxxx

Table 6- 25 1FW6160 xxB07-1Jxx, 1FW6160-xxB07-2Jxx, 1FW6160-xxB07-5Gxx

Technical data	Symbol	Unit	-xxB07-1Jxx	-xxB07-2Jxx	-xxB07-5Gxx
1FW6160					
Boundary conditions					
DC link voltage	U_{DC}	V	600	600	600
Water cooling inlet temperature	T_{VORL}	°C	35	35	35
Rated temperature of winding	T_N	°C	130	130	130
Data at the rated operating point					
Rated torque	M_N	Nm	621	596	517
Rated current	I_N	A	17	25.4	43.7
Rated speed	n_N	rpm	93.5	164	379
Rated power loss	$P_{V,N}$	kW	3.69	3.71	3.75
Limit data					
Maximum torque	M_{MAX}	Nm	1000	1000	1000
Maximum current	I_{MAX}	A	31.6	49.4	98.8
Electric motor power at M_{MAX}	$P_{EL,MAX}$	kW	16.9	21.7	34.5
Maximum speed	n_{MAX}	rpm	347	542	1080
Maximum speed at maximum torque	$n_{MAX,MMAX}$	rpm	51.7	97.2	218
Max. speed without VPM	$n_{MAX,INV}$	rpm	237	370	741
No-load speed	$n_{MAX,0}$	rpm	173	271	542
Torque at $n = 1$ rpm	M_0	Nm	653	653	653
Current at M_0 and $n = 1$ rpm	I_0	A	18	28.1	56.1
Thermal static torque	M_0^*	Nm	471	471	471
Thermal stall current	I_0^*	A	12.7	19.9	39.7
Physical constants					
Torque constant at 20 °C	$k_{T,20}$	Nm/A	37.2	23.8	11.9
Voltage constant	k_E	V/(1000/min)	2250	1440	720
Motor constant at 20 °C	$k_{M,20}$	Nm/(W) ^{0.5}	13.2	13.1	13.1
Thermal time constant	t_{TH}	s	180	180	180
No. of pole pairs	p	-	35	35	35
Cogging torque	M_{COG}	Nm	3.27	3.27	3.27
Stator mass	m_s	kg	36.2	36.2	36.2
Rotor mass	m_L	kg	12.1	12.1	12.1
Rotor moment of inertia	J_L	10 ⁻² kgm ²	25.8	25.8	25.8
Phase resistance of winding at 20 °C	$R_{STR, 20}$	Ω	2.66	1.1	0.277
Phase inductance of winding	L_{STR}	mH	25.1	10.3	2.57

Technical data	Symbol	Unit	-xxB07-1Jxx	-xxB07-2Jxx	-xxB07-5Gxx
1FW6160					
Data for main motor cooler *)					
Maximum dissipated thermal power	$Q_{H,MAX}$	kW	2.77	2.79	2.82
Recommended minimum volume flow	$\dot{V}_{H,MIN}$	l/min	4.76	4.76	4.76
Cooling medium temperature increase	ΔT_H	K	8.39	8.42	8.52
Pressure drop	Δp_H	bar	0.425	0.425	0.425
Data for precision motor cooler *)					
Maximum dissipated thermal power	$Q_{P,MAX}$	kW	0.299	0.3	0.304
Recommended minimum volume flow	$\dot{V}_{P,MIN}$	l/min	1.84	1.84	1.84
Cooling medium temperature increase	ΔT_P	K	2.34	2.35	2.37
Pressure drop	Δp_P	bar	0.425	0.425	0.425

*) Parallel connection of main and precision motor cooler

Table 6- 26 1FW6160-xxB07-8Fxx

Technical data	Symbol	Unit	-xxB07-8Fxx
1FW6160			
Boundary conditions			
DC link voltage	U_{DC}	V	600
Water cooling inlet temperature	T_{VORL}	°C	35
Rated temperature of winding	T_N	°C	130
Data at the rated operating point			
Rated torque	M_N	Nm	436
Rated current	I_N	A	52.4
Rated speed	n_N	rpm	594
Rated power loss	$P_{V,N}$	kW	3.84
Limit data			
Maximum torque	M_{MAX}	Nm	1000
Maximum current	I_{MAX}	A	141
Electric motor power at M_{MAX}	$P_{EL,MAX}$	kW	45.5
Maximum speed	n_{MAX}	rpm	1280
Maximum speed at maximum torque	$n_{MAX,MMAX}$	rpm	320
Max. speed without VPM	$n_{MAX,INV}$	rpm	1060
No-load speed	$n_{MAX,0}$	rpm	774
Torque at $n = 1$ rpm	M_0	Nm	653
Current at M_0 and $n = 1$ rpm	I_0	A	80.2
Thermal static torque	M_0^*	Nm	471
Thermal stall current	I_0^*	A	56.7
Physical constants			
Torque constant at 20 °C	$k_{T,20}$	Nm/A	8.34
Voltage constant	k_E	V/(1000/min)	504
Motor constant at 20 °C	$k_{M,20}$	Nm/(W) ^{0.5}	12.9
Thermal time constant	t_{TH}	s	180
No. of pole pairs	p	-	35
Cogging torque	M_{COG}	Nm	3.27
Stator mass	m_s	kg	36.2
Rotor mass	m_L	kg	12.1
Rotor moment of inertia	J_L	10 ⁻² kgm ²	25.8
Phase resistance of winding at 20 °C	$R_{STR, 20}$	Ω	0.139
Phase inductance of winding	L_{STR}	mH	1.26

Technical data	Symbol	Unit	-xxB07-8Fxx
1FW6160			
Data for main motor cooler *)			
Maximum dissipated thermal power	$Q_{H,MAX}$	kW	2.88
Recommended minimum volume flow	$\dot{V}_{H,MIN}$	l/min	4.76
Cooling medium temperature increase	ΔT_H	K	8.71
Pressure drop	Δp_H	bar	0.425
Data for precision motor cooler *)			
Maximum dissipated thermal power	$Q_{P,MAX}$	kW	0.311
Recommended minimum volume flow	$\dot{V}_{P,MIN}$	l/min	1.84
Cooling medium temperature increase	ΔT_P	K	2.43
Pressure drop	Δp_P	bar	0.425

*) Parallel connection of main and precision motor cooler

Characteristics for 1FW6160-xxB07-xxxx

Torque M with respect to speed n

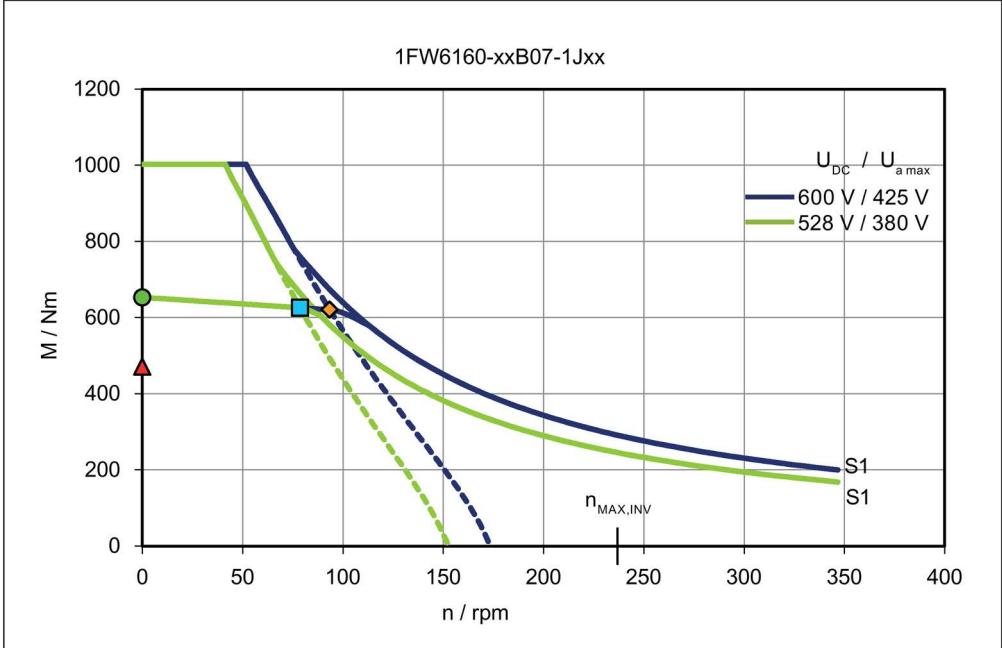

Torque M with respect to speed n

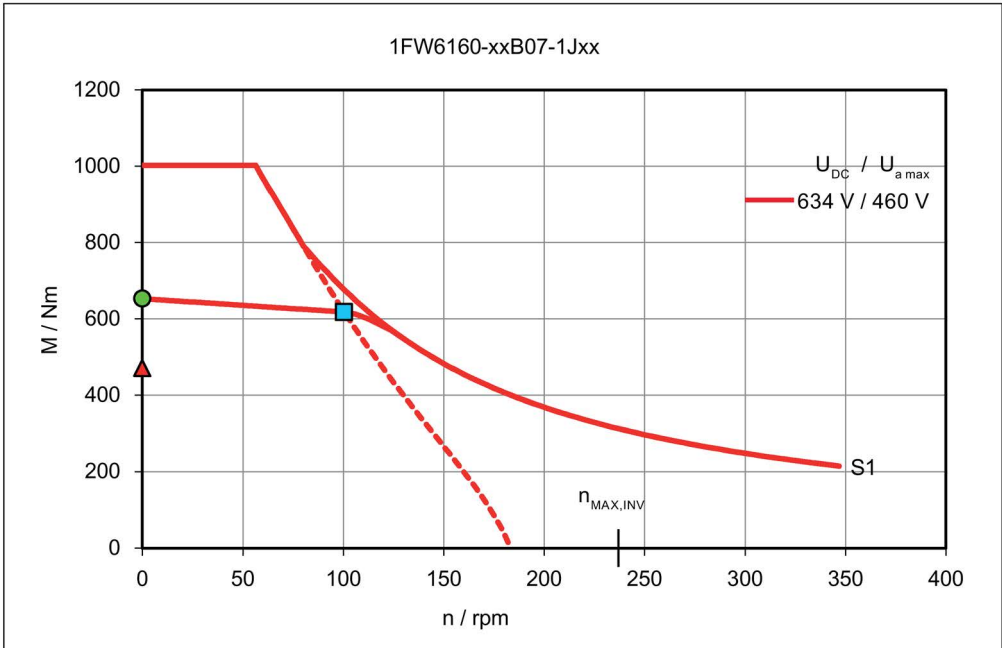

Torque M with respect to speed n

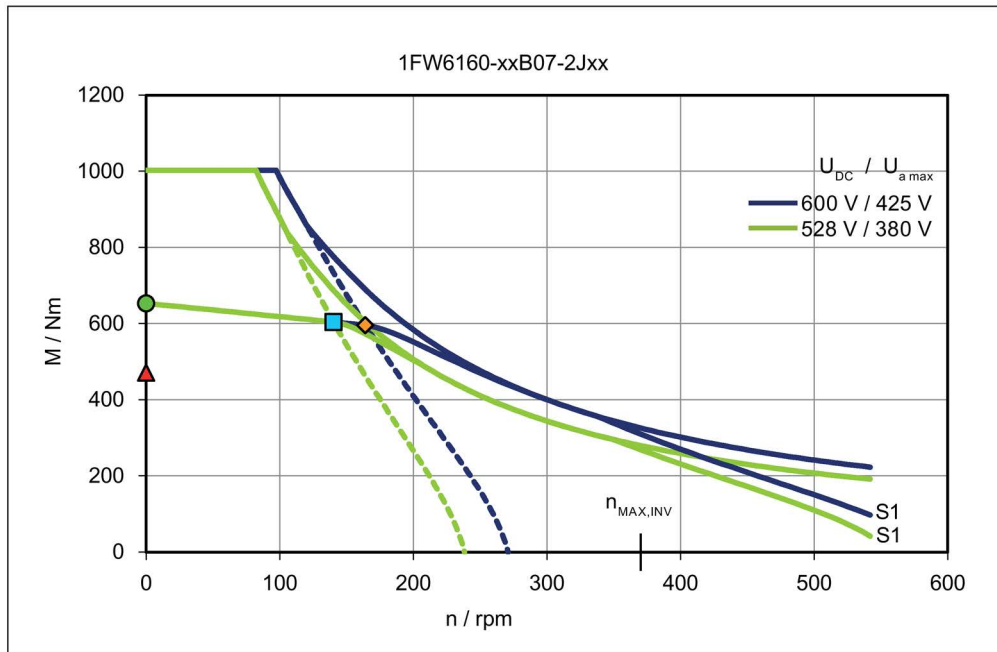

Torque M with respect to speed n

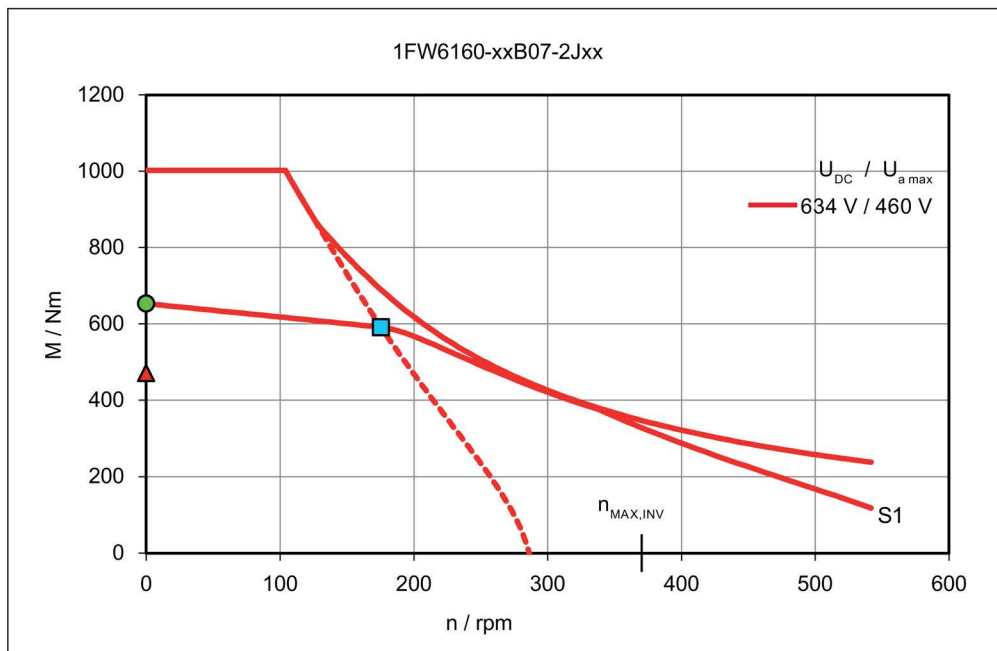

Torque M with respect to speed n

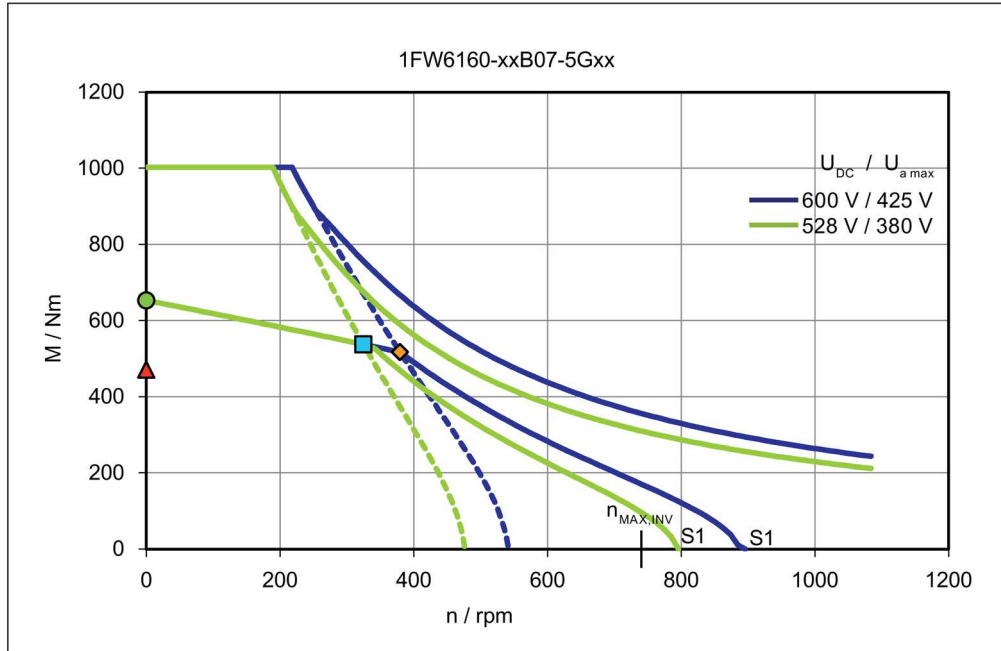

Torque M with respect to speed n

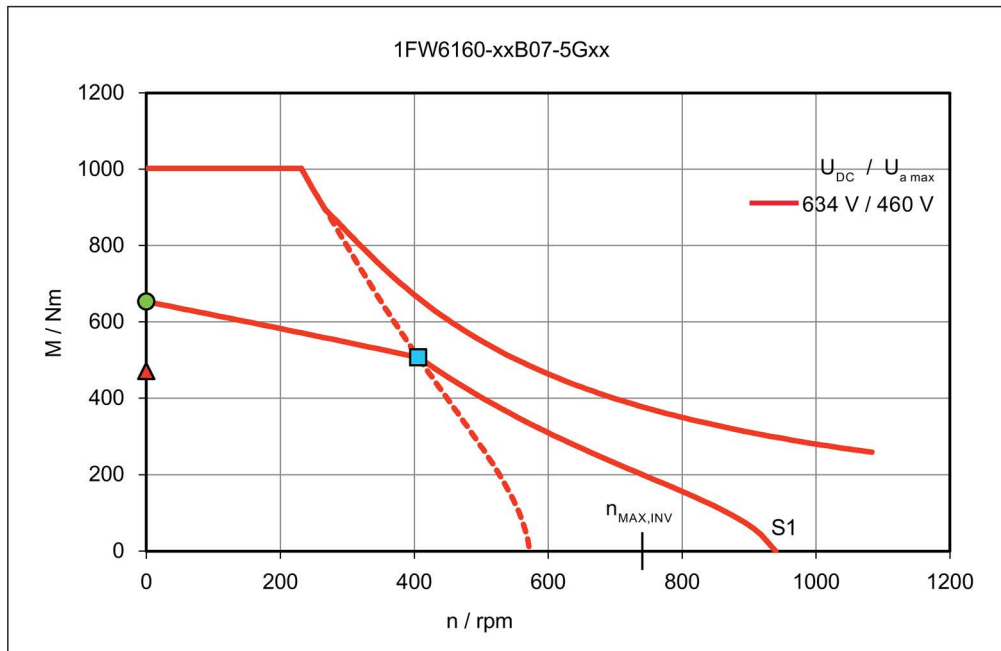

Torque M with respect to speed n

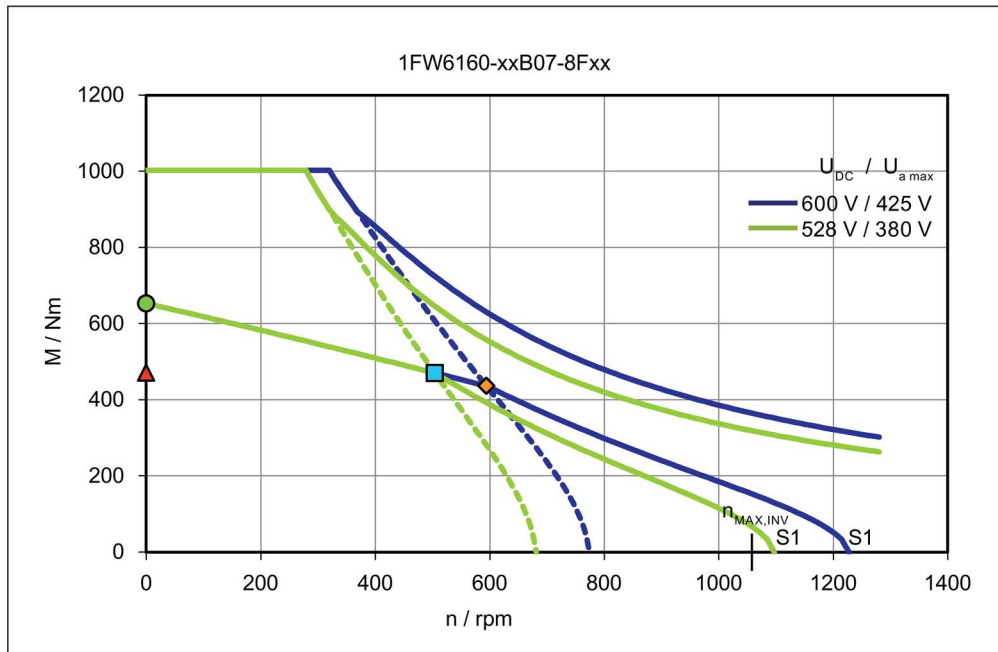

Torque M with respect to speed n

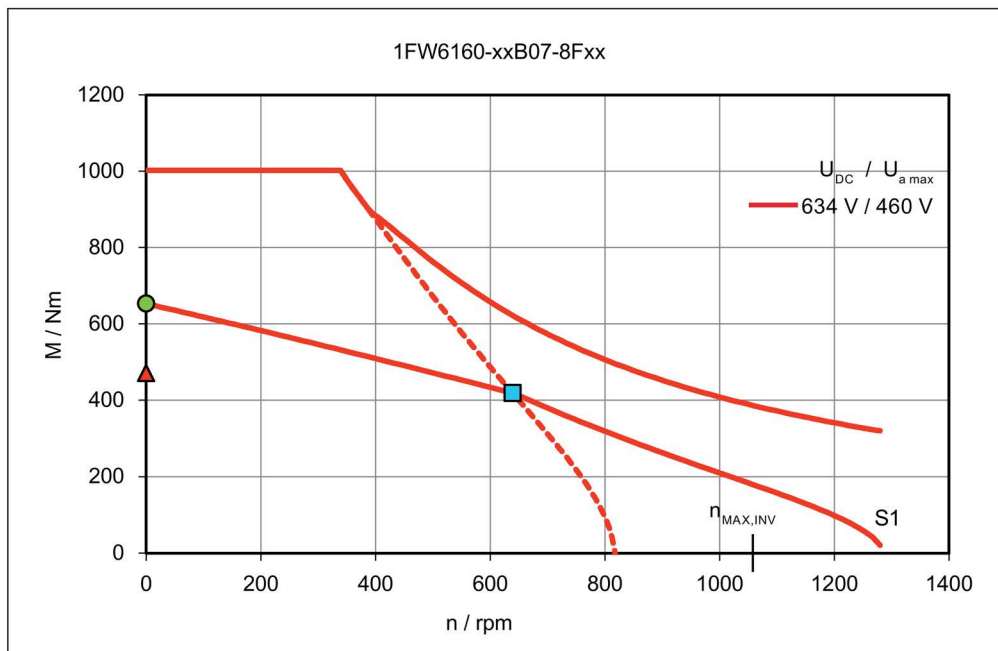

Short-circuit braking torque M_{Br} with respect to speed n

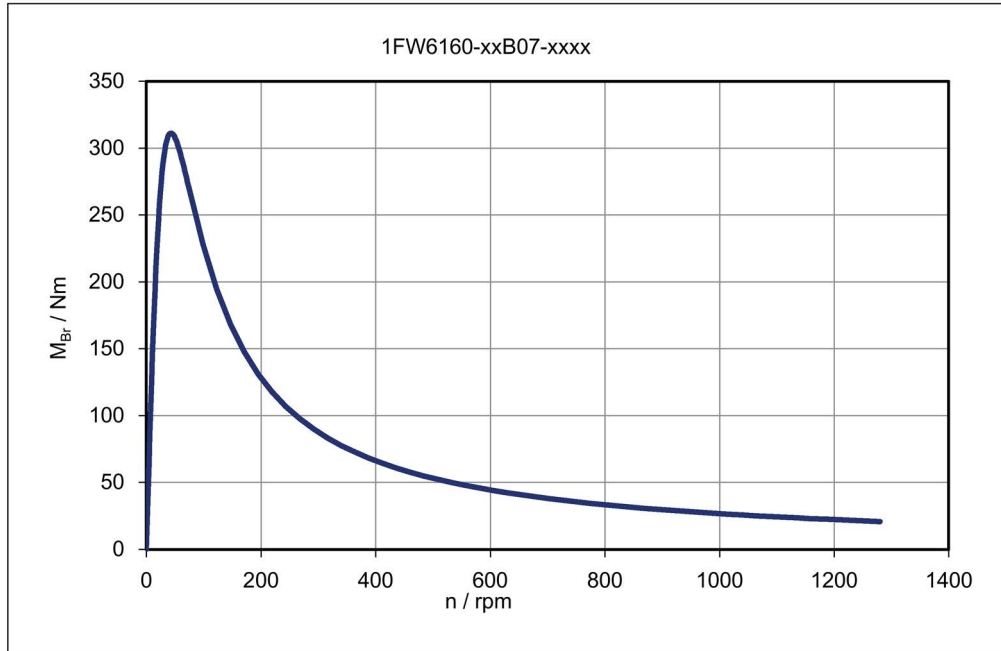

Main cooler and precision cooler - pressure losses Δp with respect to the flow rate \dot{V} (HK || PK: main cooler HK and precision cooler PK connected in parallel)

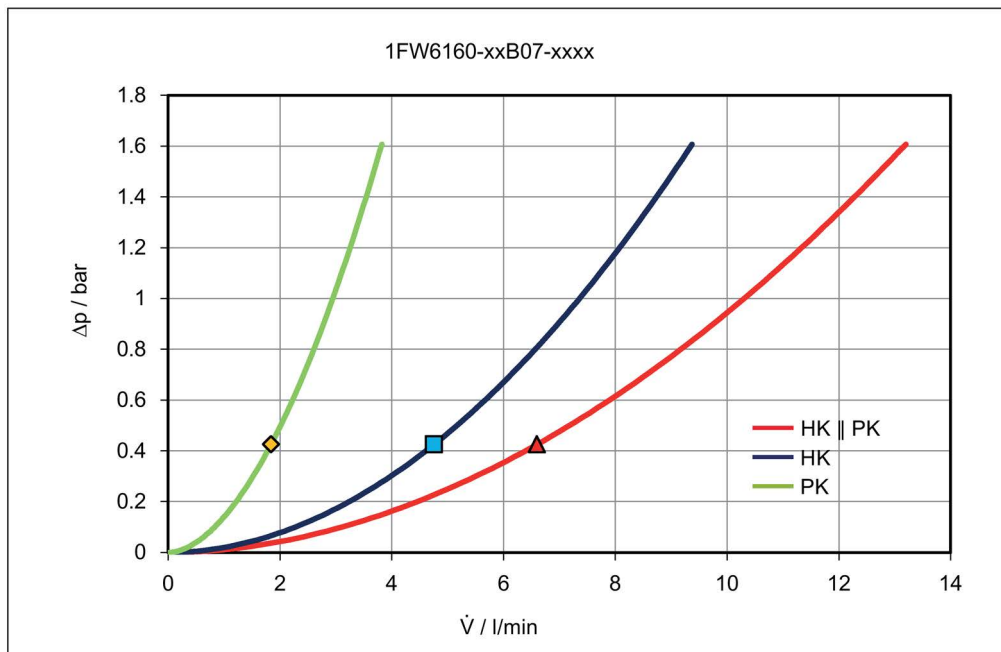

Rotor power loss P_{LV} with respect to speed n

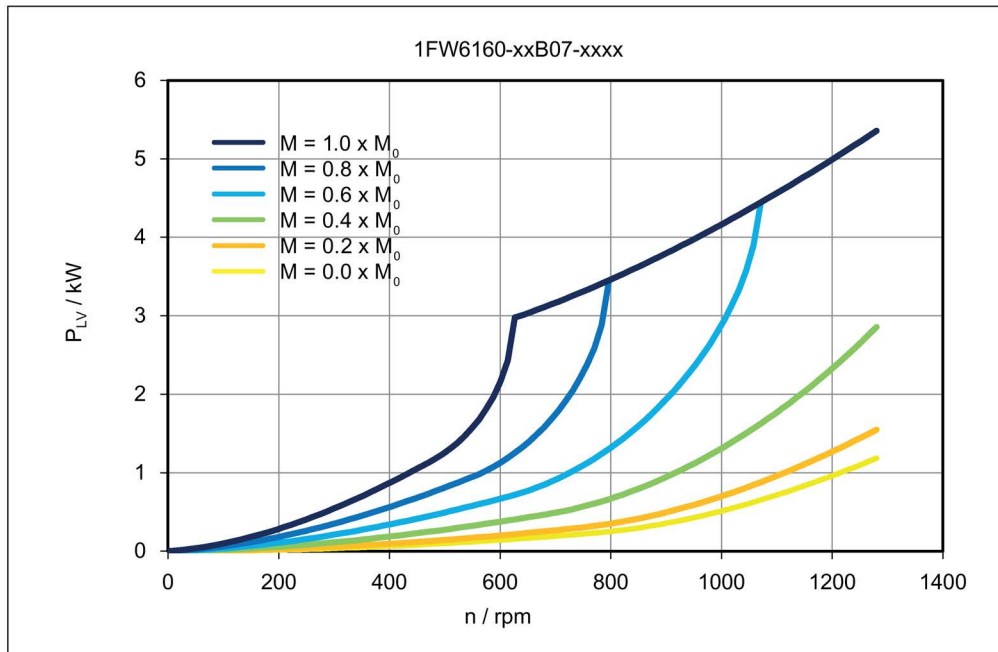

Data sheet 1FW6160-xxB10-xxxx

Table 6- 27 1FW6160-xxB10-1Jxx, 1FW6160-xxB10-2Jxx, 1FW6160-xxB10-5Gxx

Technical data	Symbol	Unit	-xxB10-1Jxx	-xxB10-2Jxx	-xxB10-5Gxx
1FW6160					
Boundary conditions					
DC link voltage	U_{DC}	V	600	600	600
Water cooling inlet temperature	T_{VORL}	°C	35	35	35
Rated temperature of winding	T_N	°C	130	130	130
Data at the rated operating point					
Rated torque	M_N	Nm	904	880	807
Rated current	I_N	A	17.3	26.3	48
Rated speed	n_N	rpm	59	108	250
Rated power loss	$P_{V,N}$	kW	4.82	4.84	4.89
Limit data					
Maximum torque	M_{MAX}	Nm	1430	1430	1430
Maximum current	I_{MAX}	A	31.6	49.4	98.8
Electric motor power at M_{MAX}	$P_{EL,MAX}$	kW	19.2	24.4	37.5
Maximum speed	n_{MAX}	rpm	243	379	759
Maximum speed at maximum torque	$n_{MAX,MMAX}$	rpm	28.5	62.4	149
Max. speed without VPM	$n_{MAX,INV}$	rpm	166	259	518
No-load speed	$n_{MAX,0}$	rpm	121	190	379
Torque at $n = 1$ rpm	M_0	Nm	933	933	933
Current at M_0 and $n = 1$ rpm	I_0	A	18	28.1	56.1
Thermal static torque	M_0^*	Nm	673	673	673
Thermal stall current	I_0^*	A	12.7	19.9	39.7
Physical constants					
Torque constant at 20 °C	$k_{T,20}$	Nm/A	53.2	34	17
Voltage constant	k_E	V/(1000/min)	3220	2060	1030
Motor constant at 20 °C	$k_{M,20}$	Nm/(W) ^{0.5}	16.5	16.4	16.4
Thermal time constant	t_{TH}	s	180	180	180
No. of pole pairs	p	-	35	35	35
Cogging torque	M_{COG}	Nm	4.67	4.67	4.67
Stator mass	m_s	kg	49	49	49
Rotor mass	m_L	kg	17.3	17.3	17.3
Rotor moment of inertia	J_L	10 ⁻² kgm ²	36	36	36
Phase resistance of winding at 20 °C	$R_{STR, 20}$	Ω	3.48	1.43	0.361
Phase inductance of winding	L_{STR}	mH	35.5	14.5	3.63

Technical data	Symbol	Unit	-xxB10-1Jxx	-xxB10-2Jxx	-xxB10-5Gxx
1FW6160					
Data for main motor cooler *)					
Maximum dissipated thermal power	$Q_{H,MAX}$	kW	3.62	3.64	3.67
Recommended minimum volume flow	$\dot{V}_{H,MIN}$	l/min	6.37	6.37	6.37
Cooling medium temperature increase	ΔT_H	K	8.17	8.21	8.29
Pressure drop	Δp_H	bar	0.755	0.755	0.755
Data for precision motor cooler *)					
Maximum dissipated thermal power	$Q_{P,MAX}$	kW	0.391	0.392	0.396
Recommended minimum volume flow	$\dot{V}_{P,MIN}$	l/min	2.52	2.52	2.52
Cooling medium temperature increase	ΔT_P	K	2.23	2.24	2.26
Pressure drop	Δp_P	bar	0.755	0.755	0.755

*) Parallel connection of main and precision motor cooler

Table 6- 28 1FW6160-xxB10-8Fxx, 1FW6160-xxB10-2Pxx

Technical data	Symbol	Unit	-xxB10-8Fxx	-xxB10-2Pxx
1FW6160				
Boundary conditions				
DC link voltage	U_{DC}	V	600	600
Water cooling inlet temperature	T_{VORL}	°C	35	35
Rated temperature of winding	T_N	°C	130	130
Data at the rated operating point				
Rated torque	M_N	Nm	737	629
Rated current	I_N	A	62.3	74
Rated speed	n_N	rpm	383	584
Rated power loss	$P_{V,N}$	kW	5.01	4.89
Limit data				
Maximum torque	M_{MAX}	Nm	1430	1430
Maximum current	I_{MAX}	A	141	198
Electric motor power at M_{MAX}	$P_{EL,MAX}$	kW	48.6	62.8
Maximum speed	n_{MAX}	rpm	1080	1280
Maximum speed at maximum torque	$n_{MAX,MMAX}$	rpm	221	317
Max. speed without VPM	$n_{MAX,INV}$	rpm	741	1040
No-load speed	$n_{MAX,0}$	rpm	542	759
Torque at $n = 1$ rpm	M_0	Nm	933	933
Current at M_0 and $n = 1$ rpm	I_0	A	80.2	112
Thermal static torque	M_0^*	Nm	673	673
Thermal stall current	I_0^*	A	56.7	79.4
Physical constants				
Torque constant at 20 °C	$k_{T,20}$	Nm/A	11.9	8.51
Voltage constant	k_E	V/(1000/min)	720	515
Motor constant at 20 °C	$k_{M,20}$	Nm/(W) ^{0.5}	16.2	16.4
Thermal time constant	t_{TH}	s	180	180
No. of pole pairs	p	-	35	35
Cogging torque	M_{COG}	Nm	4.67	4.67
Stator mass	m_s	kg	49	49
Rotor mass	m_L	kg	17.3	17.3
Rotor moment of inertia	J_L	10 ⁻² kgm ²	36	36
Phase resistance of winding at 20 °C	$R_{STR, 20}$	Ω	0.181	0.0903
Phase inductance of winding	L_{STR}	mH	1.78	0.909
Data for main motor cooler *)				
Maximum dissipated thermal power	$Q_{H,MAX}$	kW	3.76	3.67
Recommended minimum volume flow	$\dot{V}_{H,MIN}$	l/min	6.37	6.37
Cooling medium temperature increase	ΔT_H	K	8.49	8.29
Pressure drop	Δp_H	bar	0.755	0.755

Technical data	Symbol	Unit	-xxB10-8Fxx	-xxB10-2Pxx
1FW6160				
Data for precision motor cooler *)				
Maximum dissipated thermal power	$Q_{P,MAX}$	kW	0.406	0.396
Recommended minimum volume flow	$\dot{V}_{P,MIN}$	l/min	2.52	2.52
Cooling medium temperature increase	ΔT_P	K	2.31	2.26
Pressure drop	Δp_P	bar	0.755	0.755

*) Parallel connection of main and precision motor cooler

Characteristics for 1FW6160-xxB10-xxxx

Torque M with respect to speed n

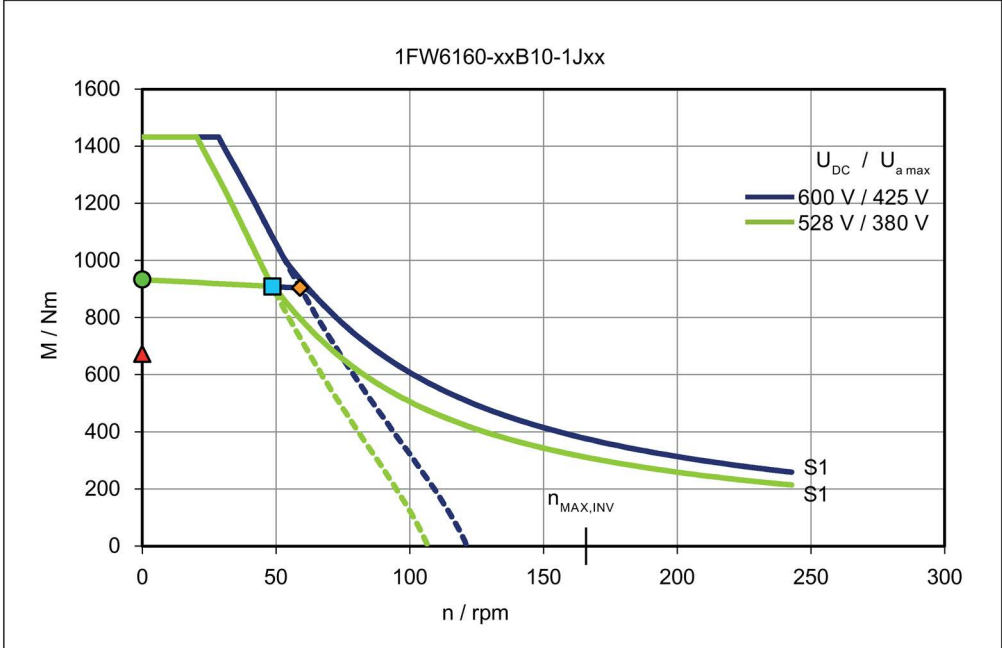

Torque M with respect to speed n

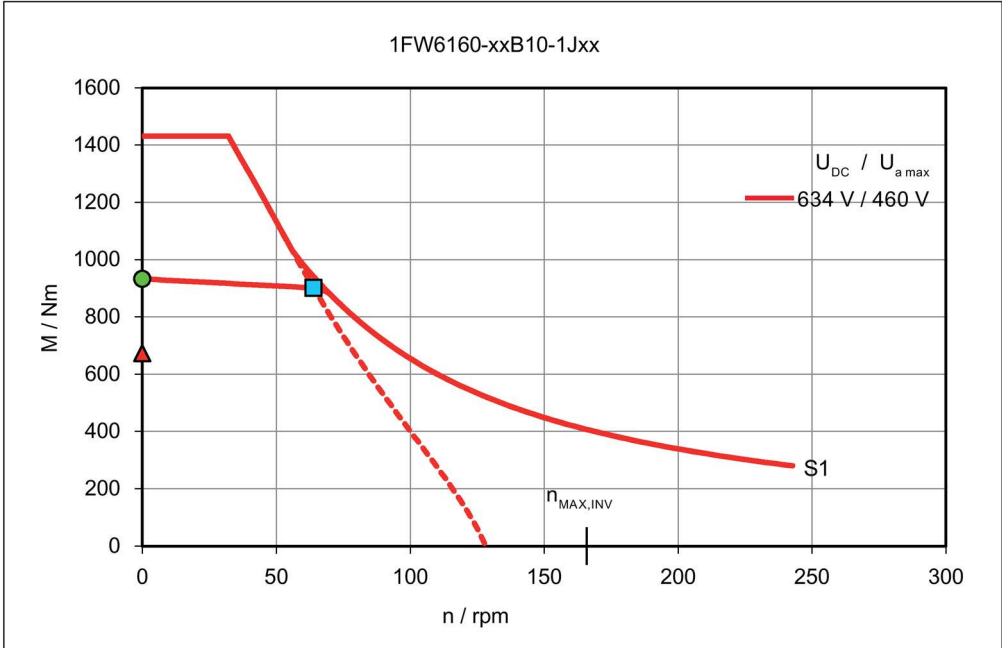

Torque M with respect to speed n

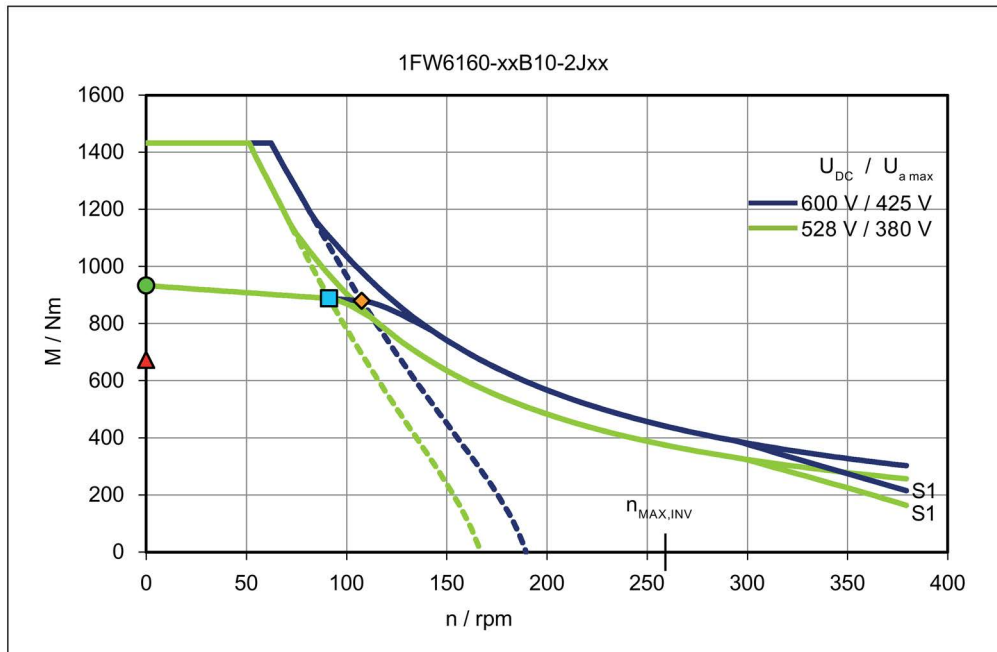

Torque M with respect to speed n

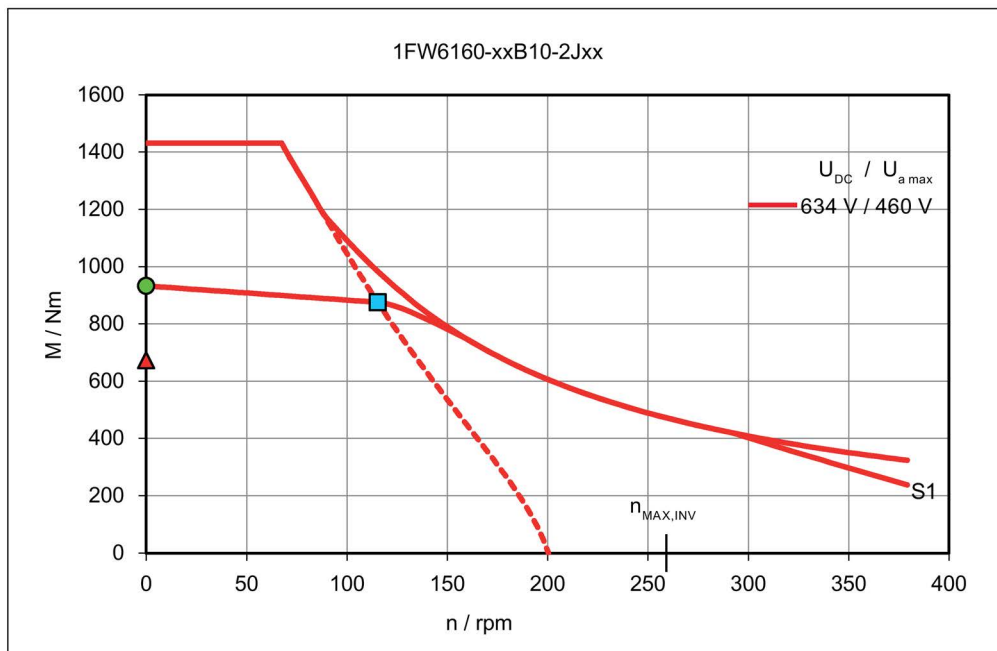

Torque M with respect to speed n

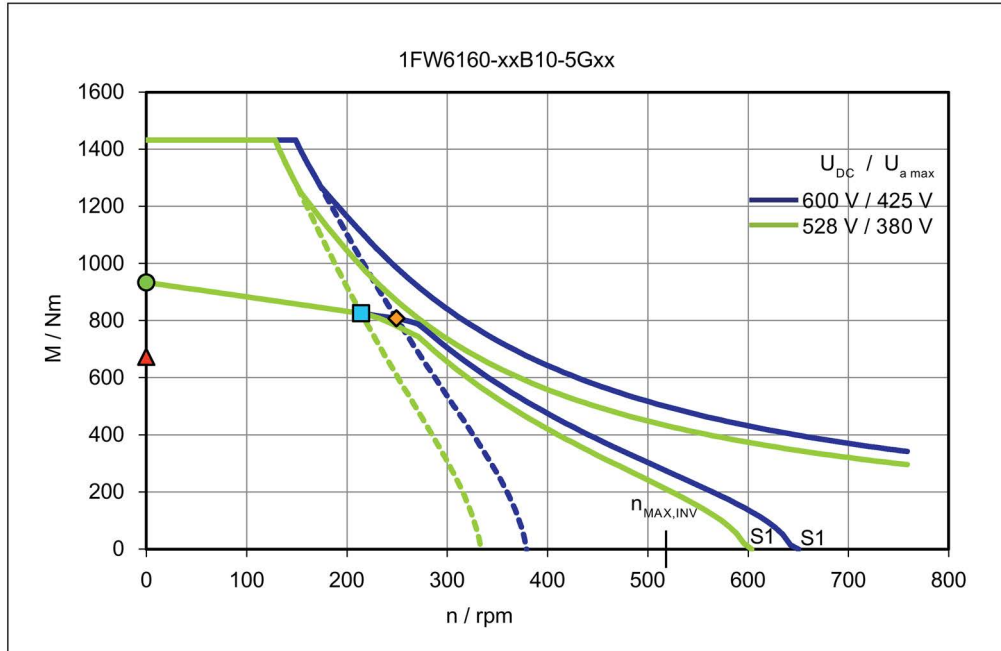

Torque M with respect to speed n

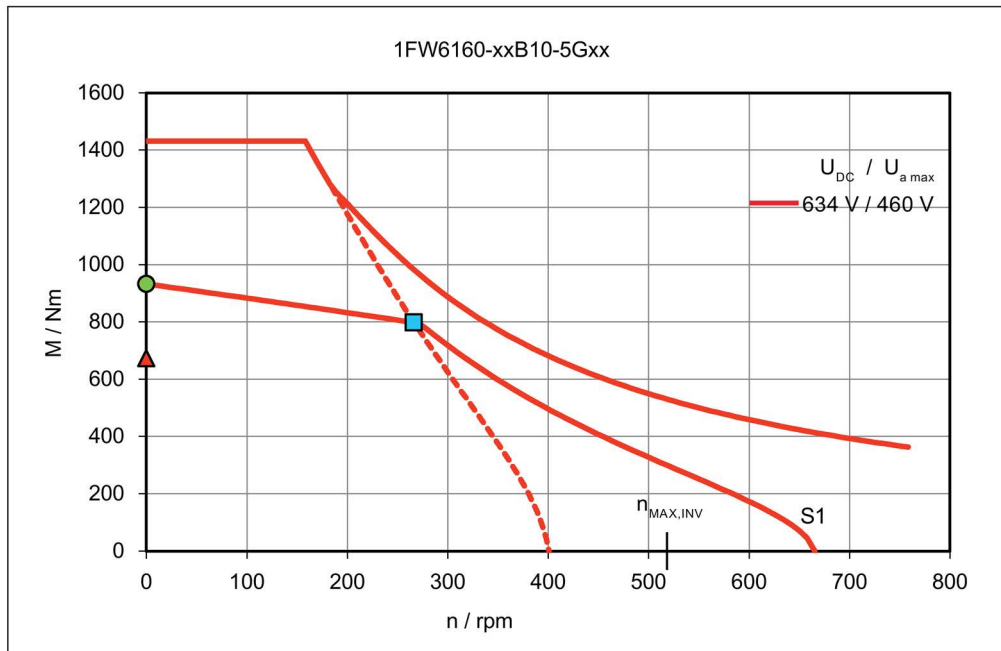

Torque M with respect to speed n

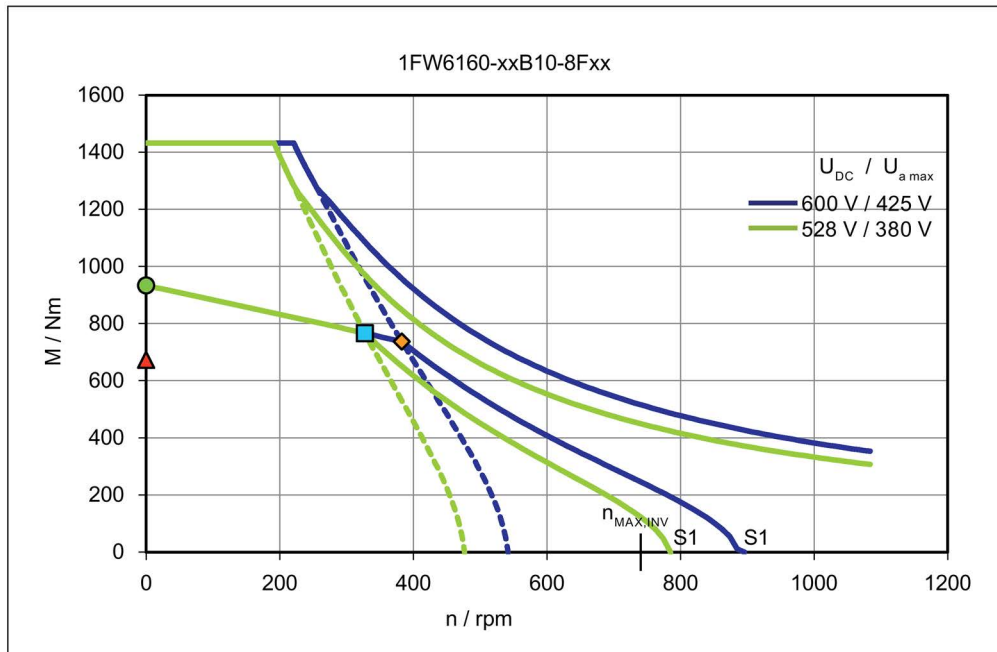

Torque M with respect to speed n

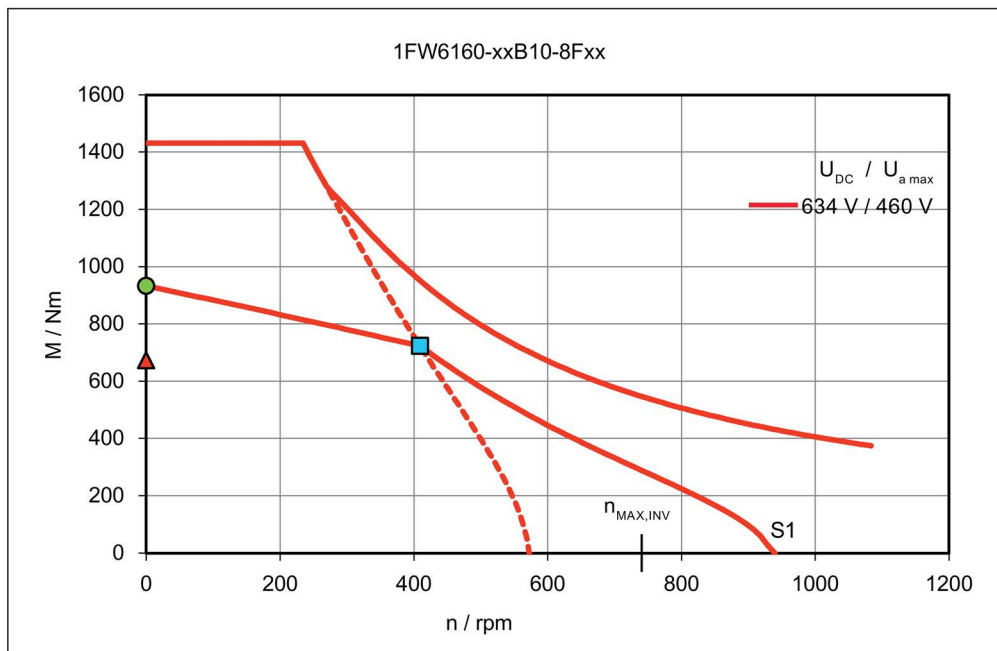

Torque M with respect to speed n

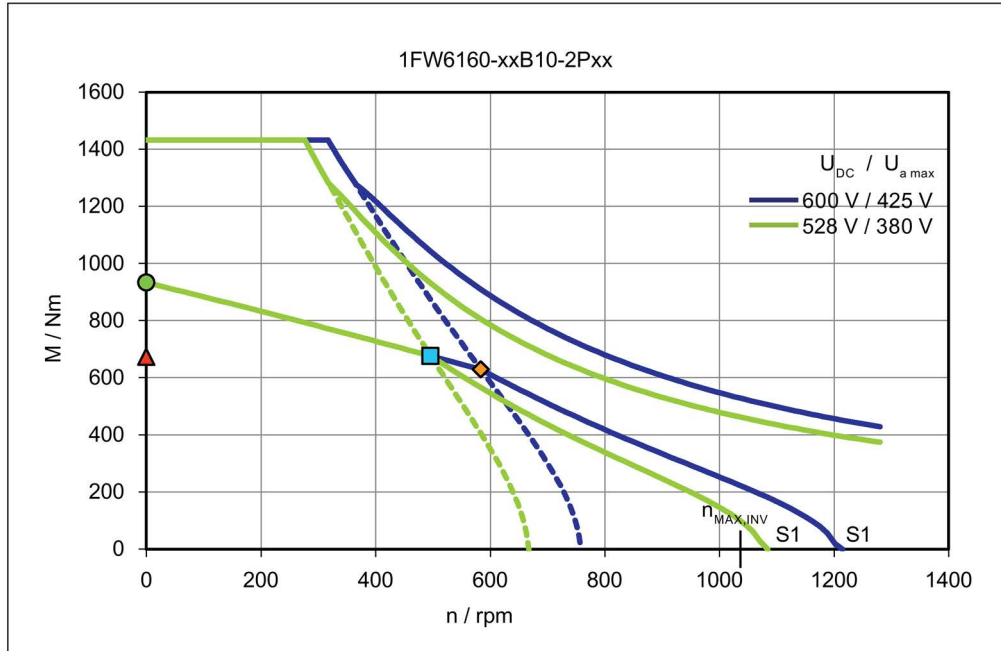

Torque M with respect to speed n

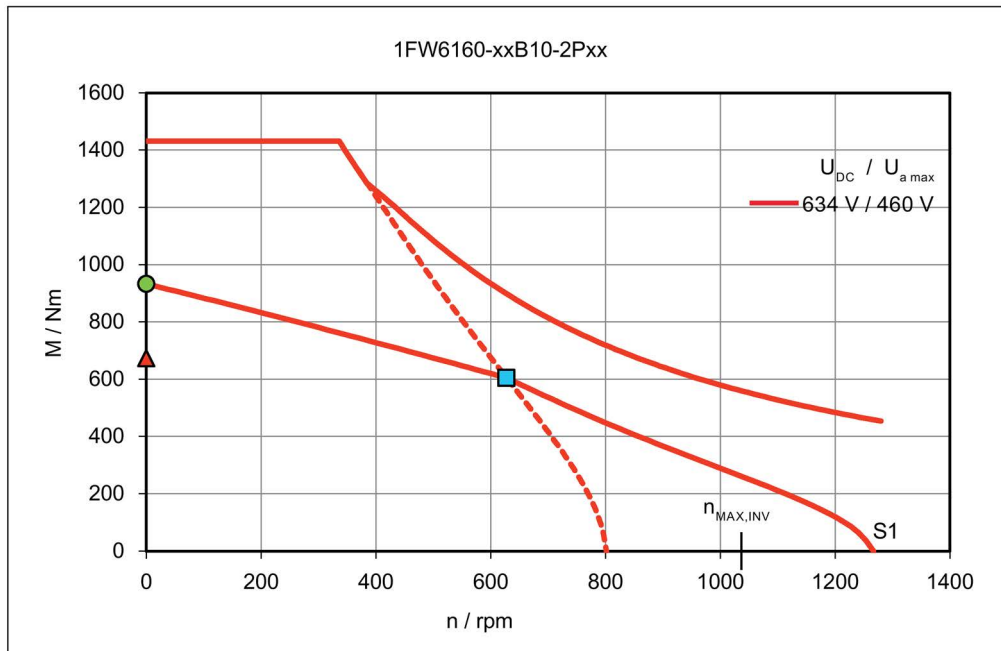

Short-circuit braking torque M_{Br} with respect to speed n

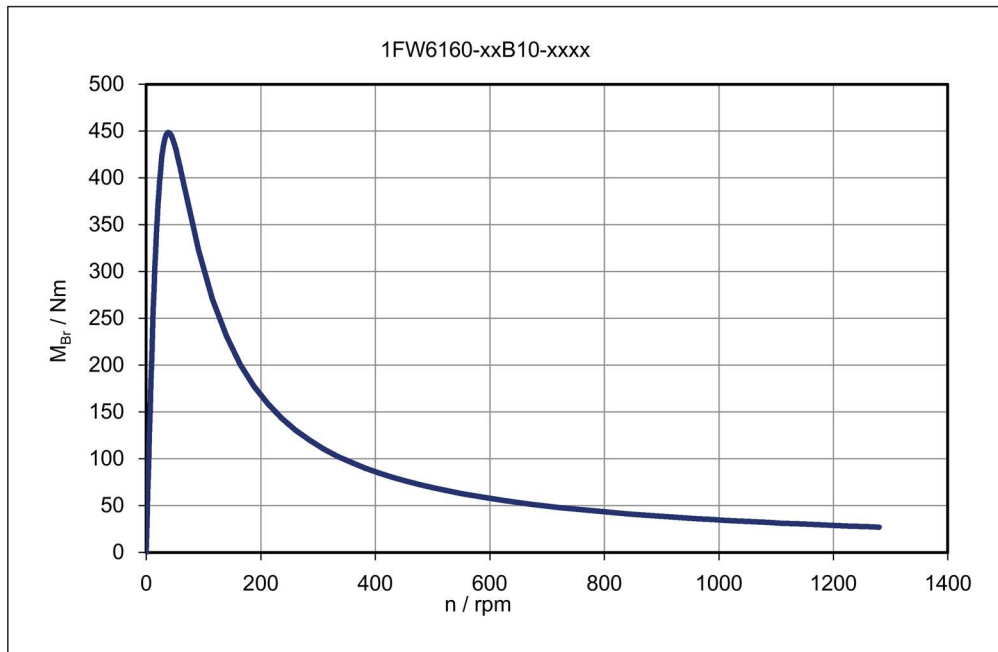

Main cooler and precision cooler - pressure losses Δp with respect to the flow rate \dot{V} (HK || PK: main cooler HK and precision cooler PK connected in parallel)

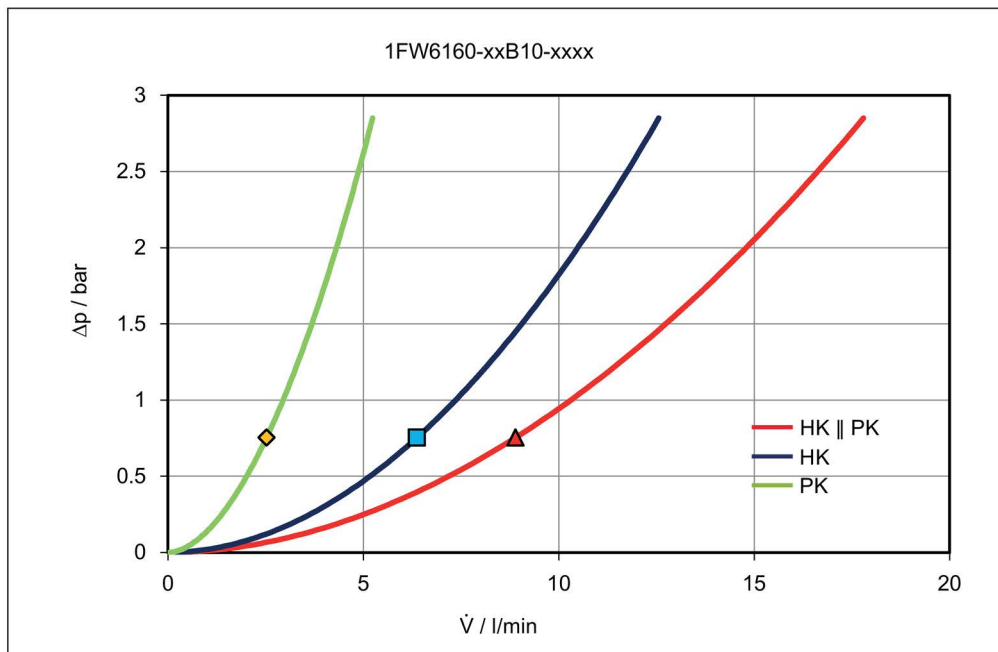

Rotor power loss P_{LV} with respect to speed n

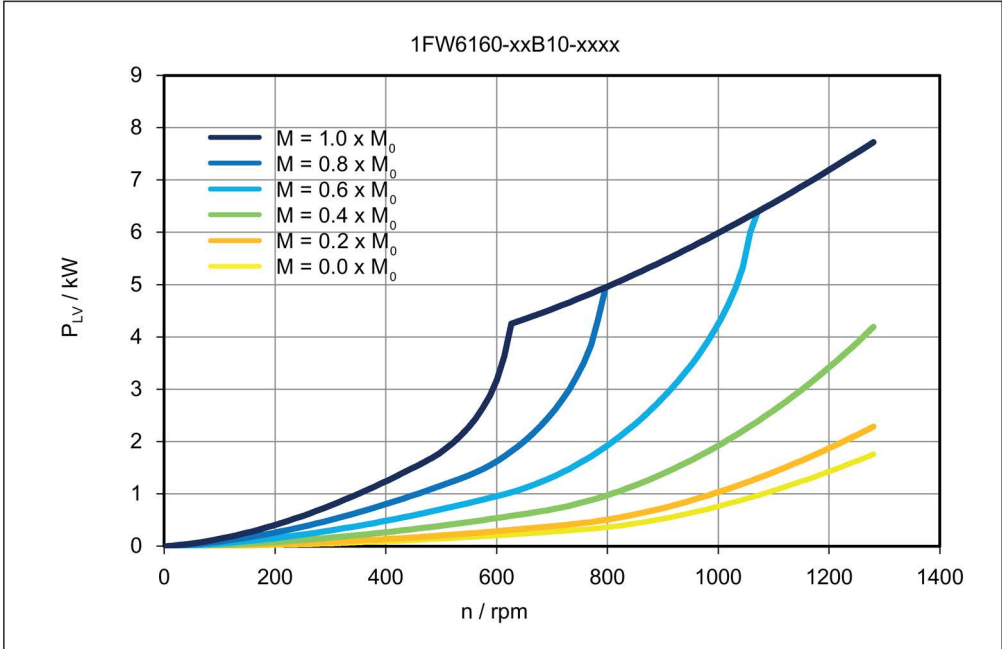

Data sheet 1FW6160-xxB15-xxxx

Table 6- 29 1FW6160-xxB15-2Jxx, 1FW6160-xxB15-5Gxx, 1FW6160-xxB15-8Fxx

Technical data	Symbol	Unit	-xxB15-2Jxx	-xxB15-5Gxx	-xxB15-8Fxx
1FW6160					
Boundary conditions					
DC link voltage	U_{DC}	V	600	600	600
Water cooling inlet temperature	T_{VORL}	°C	35	35	35
Rated temperature of winding	T_N	°C	130	130	130
Data at the rated operating point					
Rated torque	M_N	Nm	1350	1280	1220
Rated current	I_N	A	27	51.1	69.1
Rated speed	n_N	rpm	64.6	156	237
Rated power loss	$P_{V,N}$	kW	6.73	6.8	6.96
Limit data					
Maximum torque	M_{MAX}	Nm	2150	2150	2150
Maximum current	I_{MAX}	A	49.4	98.8	141
Electric motor power at M_{MAX}	$P_{EL,MAX}$	kW	28.4	42.1	53.6
Maximum speed	n_{MAX}	rpm	253	506	722
Maximum speed at maximum torque	$n_{MAX,MMAX}$	rpm	33.8	93.8	142
Max. speed without VPM	$n_{MAX,INV}$	rpm	173	346	494
No-load speed	$n_{MAX,0}$	rpm	126	253	361
Torque at $n = 1$ rpm	M_0	Nm	1400	1400	1400
Current at M_0 and $n = 1$ rpm	I_0	A	28.1	56.1	80.2
Thermal static torque	M_0^*	Nm	1010	1010	1010
Thermal stall current	I_0^*	A	19.9	39.7	56.7
Physical constants					
Torque constant at 20 °C	$k_{T,20}$	Nm/A	51.1	25.5	17.9
Voltage constant	k_E	V/(1000/min)	3090	1540	1080
Motor constant at 20 °C	$k_{M,20}$	Nm/(W) ^{0.5}	20.9	20.8	20.6
Thermal time constant	t_{TH}	s	180	180	180
No. of pole pairs	p	-	35	35	35
Cogging torque	M_{COG}	Nm	7	7	7
Stator mass	m_S	kg	69.8	69.8	69.8
Rotor mass	m_L	kg	25.5	25.5	25.5
Rotor moment of inertia	J_L	10 ⁻² kgm ²	53.1	53.1	53.1
Phase resistance of winding at 20 °C	$R_{STR, 20}$	Ω	1.99	0.502	0.252
Phase inductance of winding	L_{STR}	mH	21.7	5.41	2.65

Technical data	Symbol	Unit	-xxB15-2Jxx	-xxB15-5Gxx	-xxB15-8Fxx
1FW6160					
Data for main motor cooler *)					
Maximum dissipated thermal power	$Q_{H,MAX}$	kW	5.05	5.1	5.23
Recommended minimum volume flow	$\dot{V}_{H,MIN}$	l/min	8.88	8.88	8.88
Cooling medium temperature increase	ΔT_H	K	8.19	8.27	8.47
Pressure drop	Δp_H	bar	1.44	1.44	1.44
Data for precision motor cooler *)					
Maximum dissipated thermal power	$Q_{P,MAX}$	kW	0.545	0.55	0.564
Recommended minimum volume flow	$\dot{V}_{P,MIN}$	l/min	3.6	3.6	3.6
Cooling medium temperature increase	ΔT_P	K	2.18	2.2	2.25
Pressure drop	Δp_P	bar	1.44	1.44	1.44

*) Parallel connection of main and precision motor cooler

Table 6- 30 1FW6160-xxB15-2Pxx, 1FW6160-xxB15-0Wxx

Technical data	Symbol	Unit	-xxB15-2Pxx	-xxB15-0Wxx
1FW6160				
Boundary conditions				
DC link voltage	U_{DC}	V	600	600
Water cooling inlet temperature	T_{VORL}	°C	35	35
Rated temperature of winding	T_N	°C	130	130
Data at the rated operating point				
Rated torque	M_N	Nm	1130	970
Rated current	I_N	A	89	109
Rated speed	n_N	rpm	355	551
Rated power loss	$P_{V,N}$	kW	6.8	6.96
Limit data				
Maximum torque	M_{MAX}	Nm	2150	2150
Maximum current	I_{MAX}	A	198	282
Electric motor power at M_{MAX}	$P_{EL,MAX}$	kW	67.8	89.9
Maximum speed	n_{MAX}	rpm	1010	1280
Maximum speed at maximum torque	$n_{MAX,MMAX}$	rpm	208	304
Max. speed without VPM	$n_{MAX,INV}$	rpm	691	987
No-load speed	$n_{MAX,0}$	rpm	506	722
Torque at $n = 1$ rpm	M_0	Nm	1400	1400
Current at M_0 and $n = 1$ rpm	I_0	A	112	160
Thermal static torque	M_0^*	Nm	1010	1010
Thermal stall current	I_0^*	A	79.4	113
Physical constants				
Torque constant at 20 °C	$k_{T,20}$	Nm/A	12.8	8.94
Voltage constant	k_E	V/(1000/min)	772	540
Motor constant at 20 °C	$k_{M,20}$	Nm/(W) ^{0.5}	20.8	20.6
Thermal time constant	t_{TH}	s	180	180
No. of pole pairs	p	-	35	35
Cogging torque	M_{COG}	Nm	7	7
Stator mass	m_S	kg	69.8	69.8
Rotor mass	m_L	kg	25.5	25.5
Rotor moment of inertia	J_L	10 ⁻² kgm ²	53.1	53.1
Phase resistance of winding at 20 °C	$R_{STR,20}$	Ω	0.125	0.0629
Phase inductance of winding	L_{STR}	mH	1.35	0.663
Data for main motor cooler *)				
Maximum dissipated thermal power	$Q_{H,MAX}$	kW	5.1	5.23
Recommended minimum volume flow	$\dot{V}_{H,MIN}$	l/min	8.88	8.88
Cooling medium temperature increase	ΔT_H	K	8.27	8.47
Pressure drop	Δp_H	bar	1.44	1.44

Technical data	Symbol	Unit	-xxB15-2Pxx	-xxB15-0Wxx
1FW6160				
Data for precision motor cooler *)				
Maximum dissipated thermal power	$Q_{P,MAX}$	kW	0.55	0.564
Recommended minimum volume flow	$\dot{V}_{P,MIN}$	l/min	3.6	3.6
Cooling medium temperature increase	ΔT_P	K	2.2	2.25
Pressure drop	Δp_P	bar	1.44	1.44

*) Parallel connection of main and precision motor cooler

Characteristics for 1FW6160-xxB15-xxxx

Torque M with respect to speed n

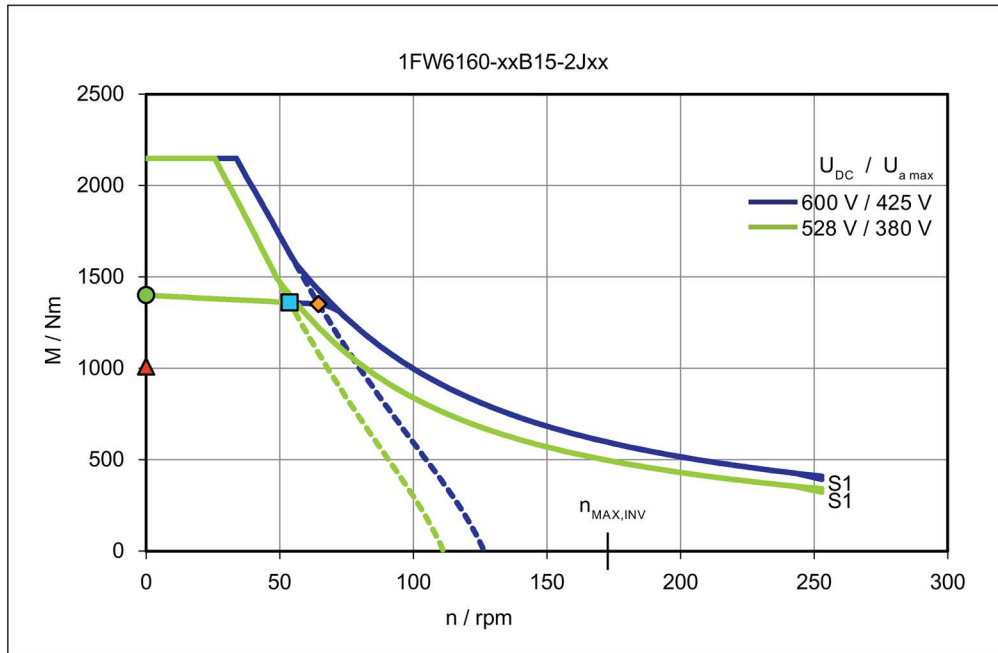

Torque M with respect to speed n

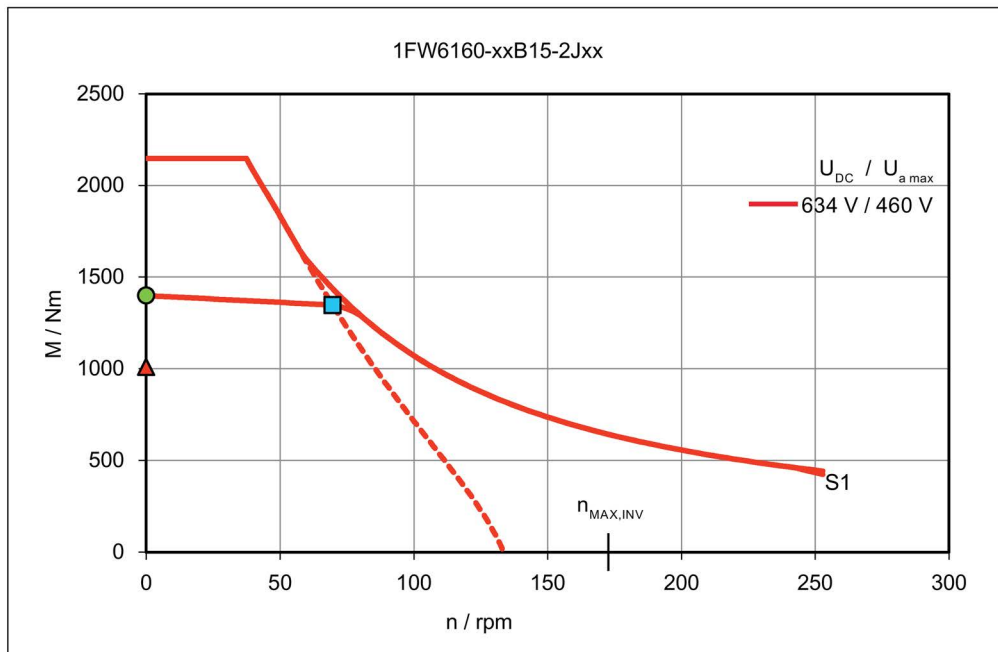

Torque M with respect to speed n

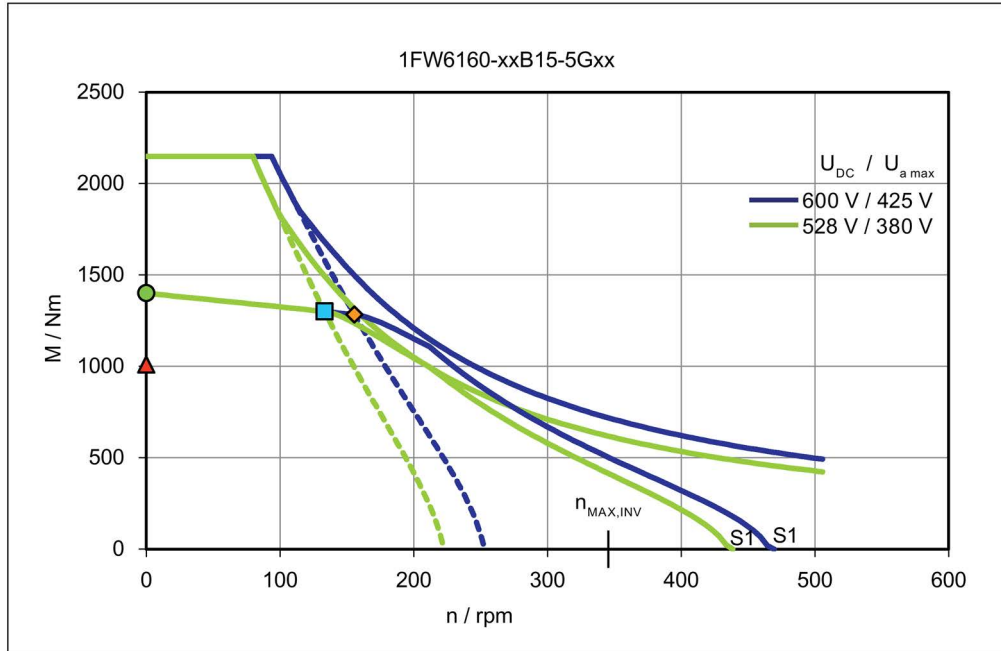

Torque M with respect to speed n

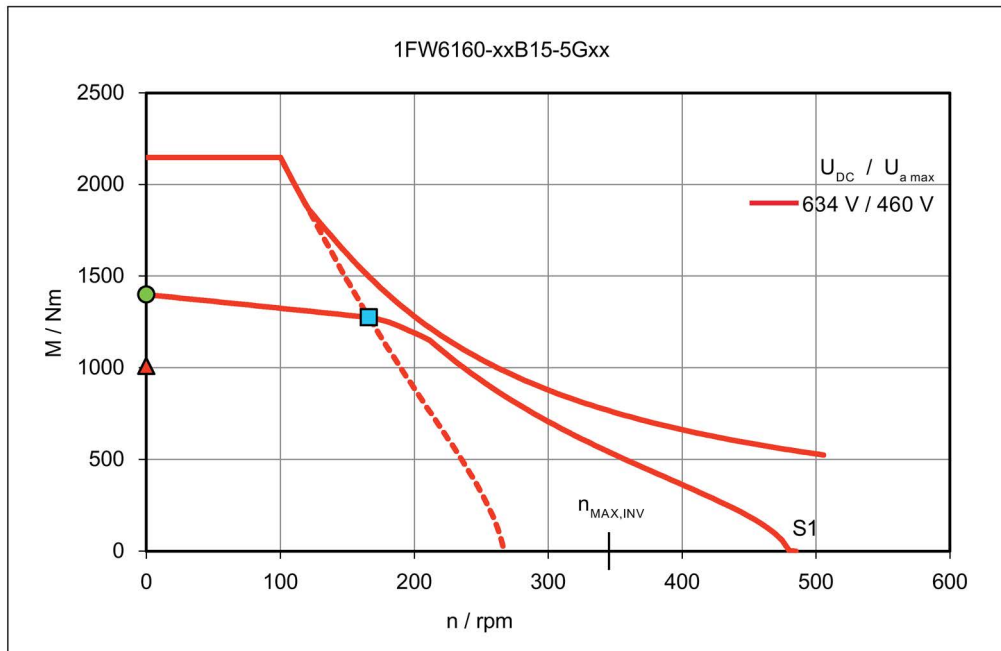

Torque M with respect to speed n

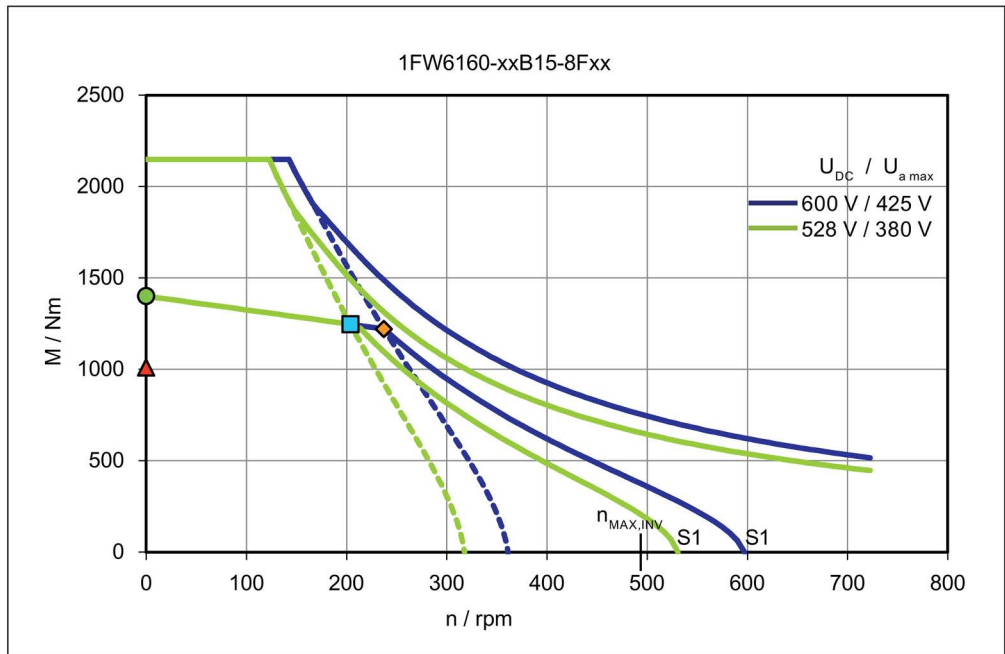

Torque M with respect to speed n

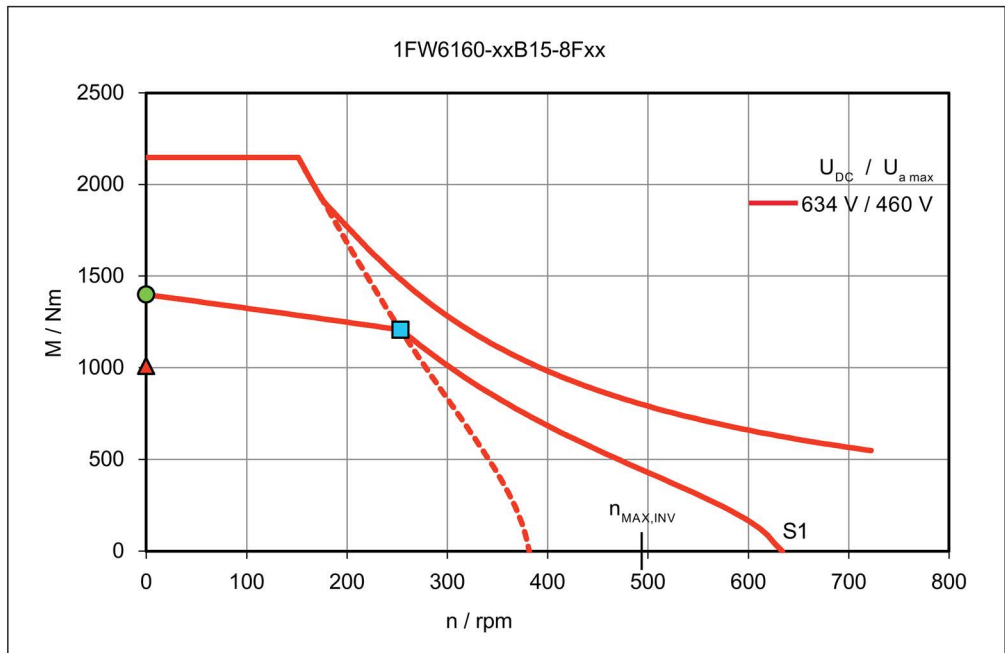

Torque M with respect to speed n

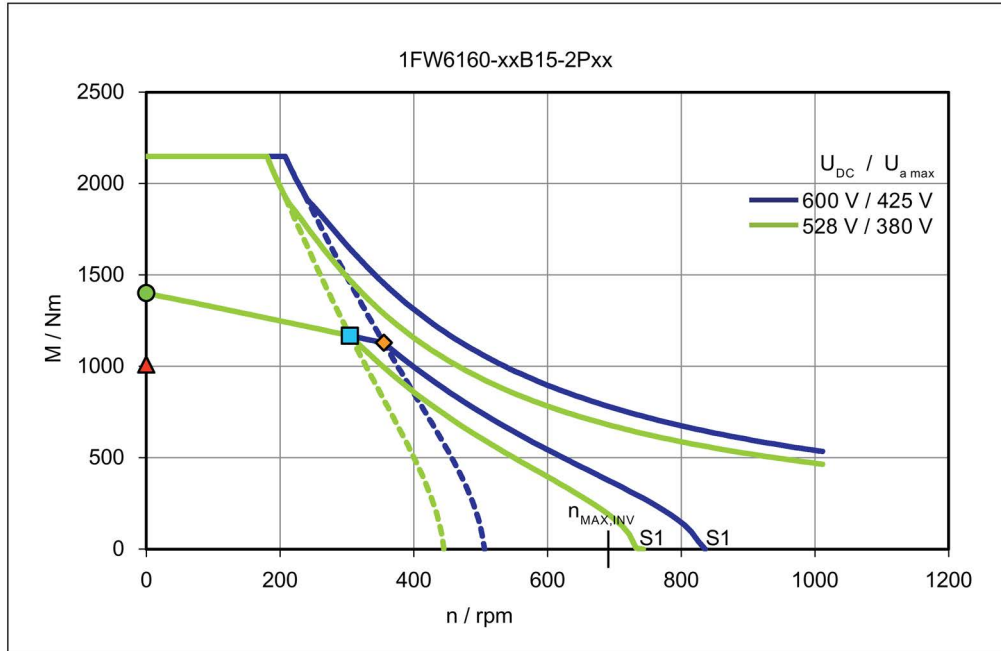

Torque M with respect to speed n

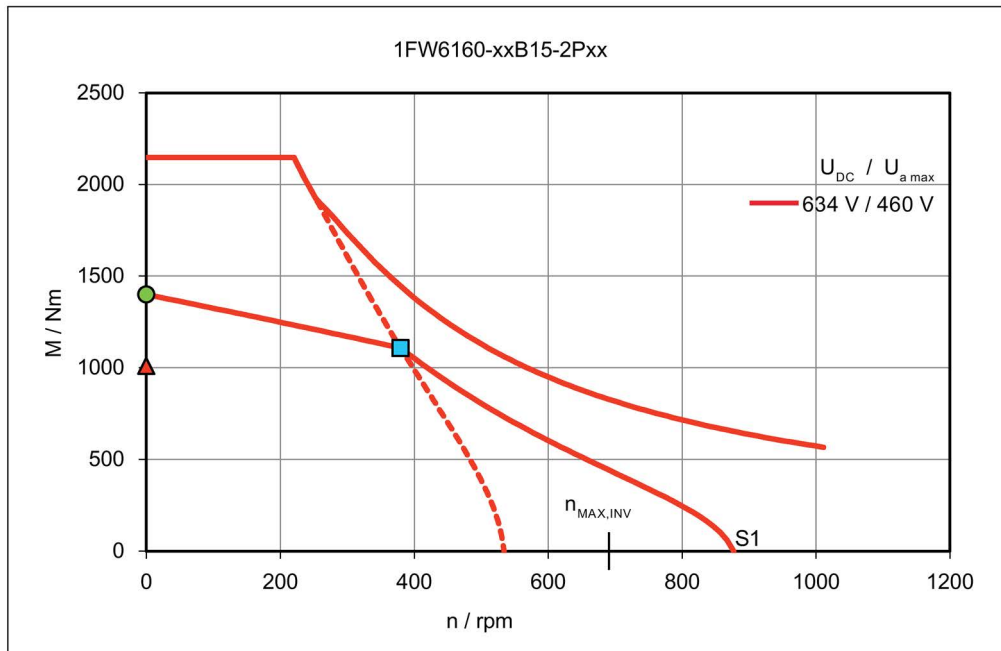

Torque M with respect to speed n

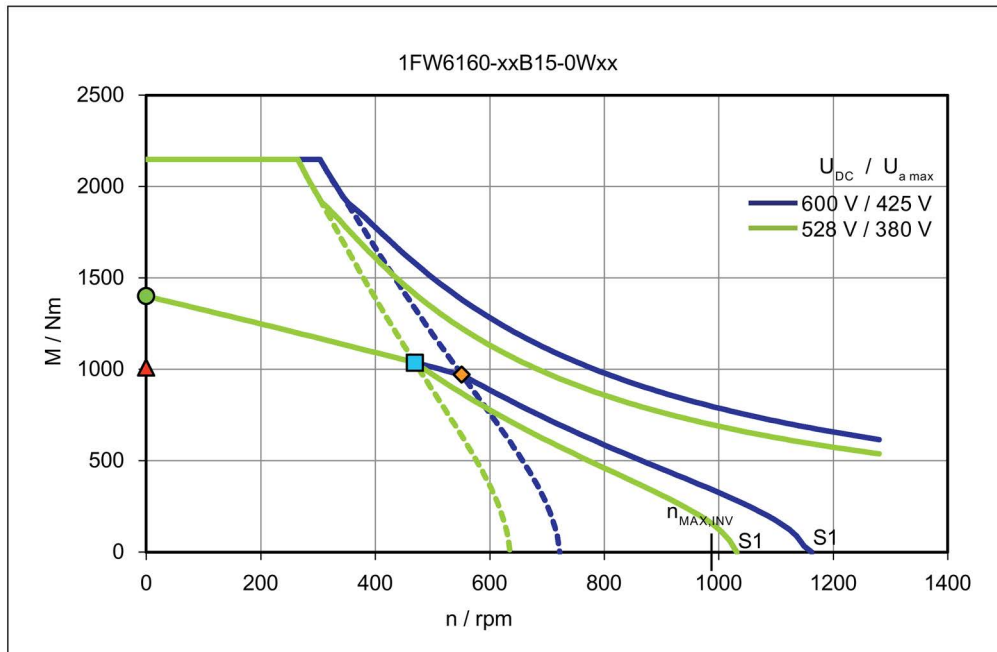

Torque M with respect to speed n

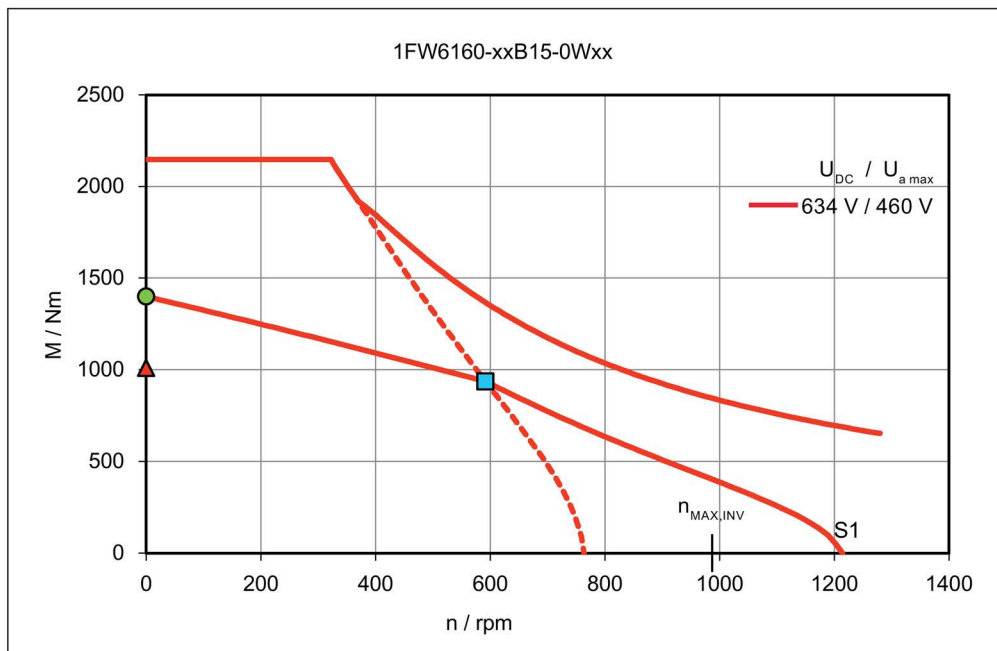

Short-circuit braking torque M_{Br} with respect to speed n

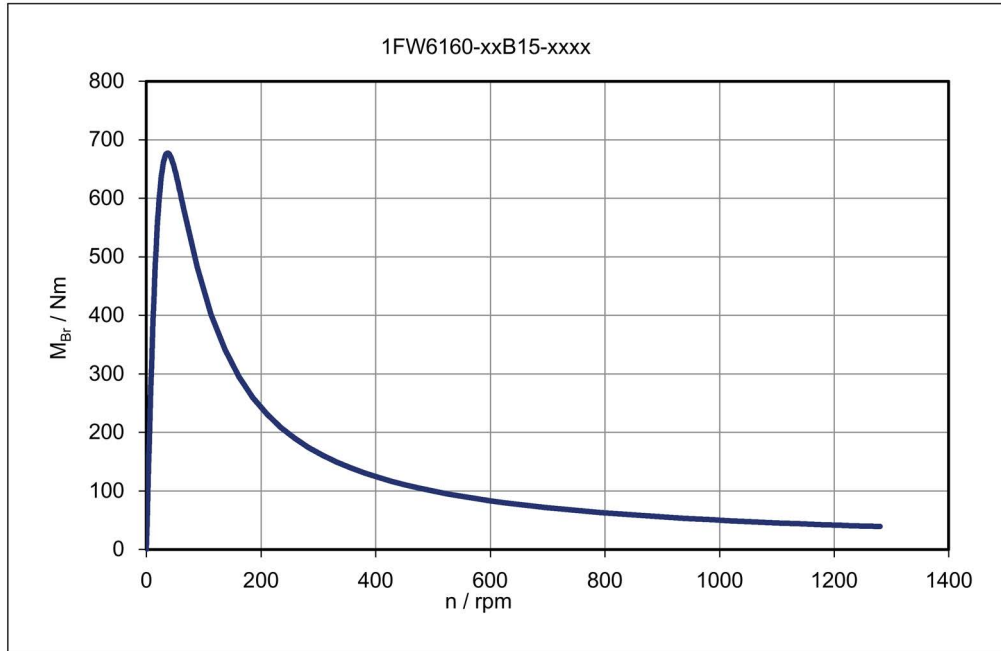

Main cooler and precision cooler - pressure losses Δp with respect to the flow rate \dot{V} (HK || PK: main cooler HK and precision cooler PK connected in parallel)

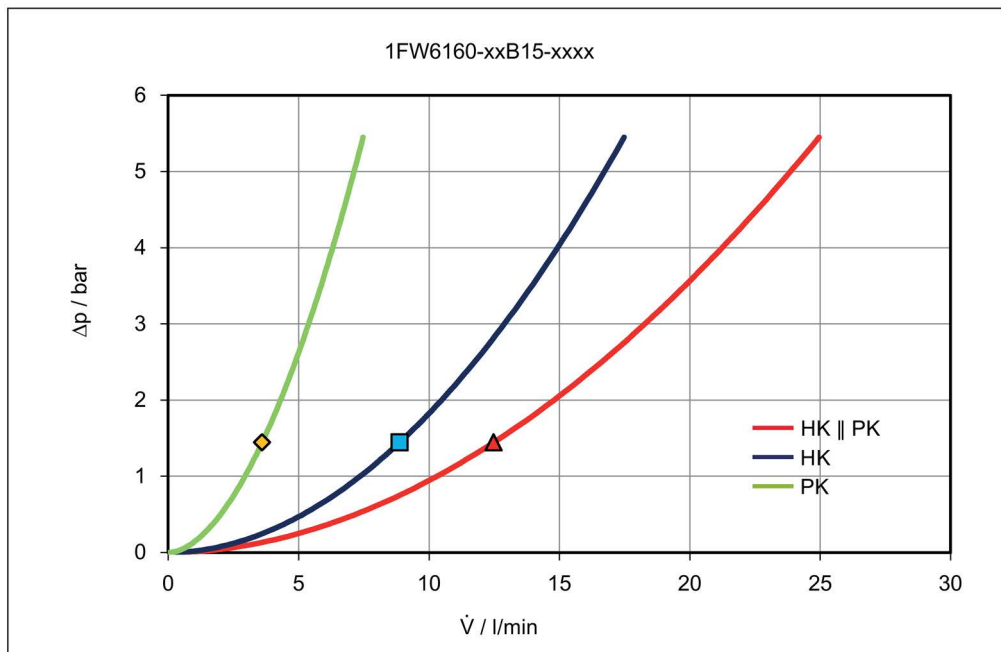

Rotor power loss P_{LV} with respect to speed n

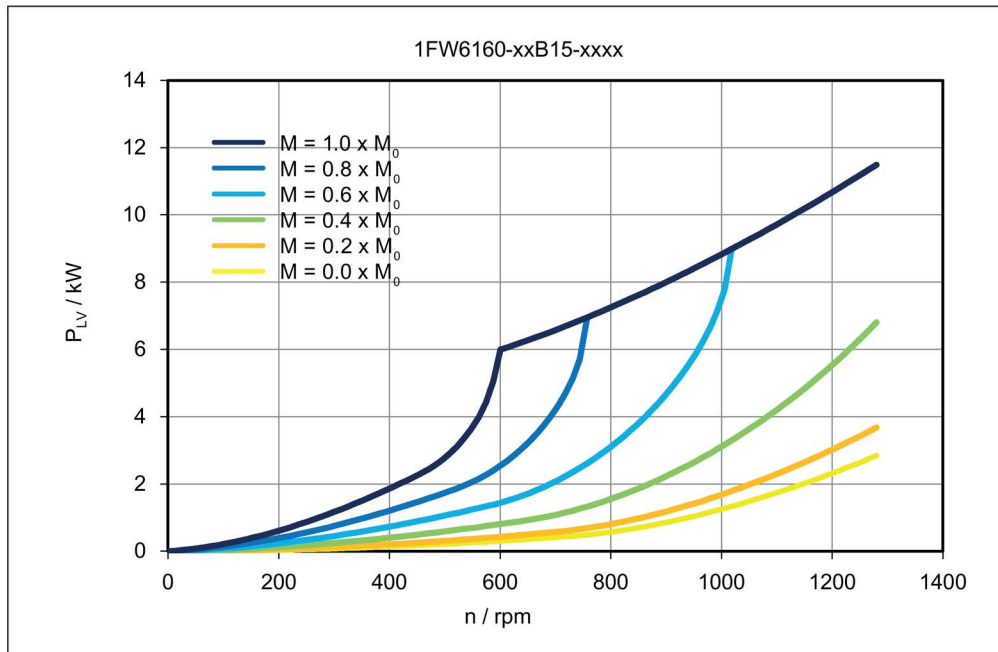

Data sheet 1FW6160-xxB20-xxxx

Table 6- 31 1FW6160-xxB20-5Gxx, 1FW6160-xxB20-8Fxx, 1FW6160-xxB20-2Pxx

Technical data	Symbol	Unit	-xxB20-5Gxx	-xxB20-8Fxx	-xxB20-2Pxx
1FW6160					
Boundary conditions					
DC link voltage	U_{DC}	V	600	600	600
Water cooling inlet temperature	T_{VORL}	°C	35	35	35
Rated temperature of winding	T_N	°C	130	130	130
Data at the rated operating point					
Rated torque	M_N	Nm	1760	1700	1610
Rated current	I_N	A	52.5	72.3	95.7
Rated speed	n_N	rpm	111	170	253
Rated power loss	$P_{V,N}$	kW	8.7	8.91	8.7
Limit data					
Maximum torque	M_{MAX}	Nm	2860	2860	2860
Maximum current	I_{MAX}	A	98.8	141	198
Electric motor power at M_{MAX}	$P_{EL,MAX}$	kW	46.6	58.4	72.6
Maximum speed	n_{MAX}	rpm	379	542	759
Maximum speed at maximum torque	$n_{MAX,MMAX}$	rpm	65.5	103	152
Max. speed without VPM	$n_{MAX,INV}$	rpm	259	370	518
No-load speed	$n_{MAX,0}$	rpm	190	271	379
Torque at $n = 1$ rpm	M_0	Nm	1870	1870	1870
Current at M_0 and $n = 1$ rpm	I_0	A	56.1	80.2	112
Thermal static torque	M_0^*	Nm	1350	1350	1350
Thermal stall current	I_0^*	A	39.7	56.7	79.4
Physical constants					
Torque constant at 20 °C	$k_{T,20}$	Nm/A	34	23.8	17
Voltage constant	k_E	V/(1000/min)	2060	1440	1030
Motor constant at 20 °C	$k_{M,20}$	Nm/(W) ^{0.5}	24.5	24.2	24.5
Thermal time constant	t_{TH}	s	180	180	180
No. of pole pairs	p	-	35	35	35
Cogging torque	M_{COG}	Nm	9.33	9.33	9.33
Stator mass	m_s	kg	90.6	90.6	90.6
Rotor mass	m_L	kg	33.7	33.7	33.7
Rotor moment of inertia	J_L	10 ⁻² kgm ²	70.1	70.1	70.1
Phase resistance of winding at 20 °C	$R_{STR, 20}$	Ω	0.642	0.322	0.161
Phase inductance of winding	L_{STR}	mH	7.2	3.53	1.8

Technical data	Symbol	Unit	-xxB20-5Gxx	-xxB20-8Fxx	-xxB20-2Pxx
1FW6160					
Data for main motor cooler *)					
Maximum dissipated thermal power	$Q_{H,MAX}$	kW	6.53	6.69	6.53
Recommended minimum volume flow	$\dot{V}_{H,MIN}$	l/min	11.4	11.4	11.4
Cooling medium temperature increase	ΔT_H	K	8.27	8.47	8.27
Pressure drop	Δp_H	bar	2.34	2.34	2.34
Data for precision motor cooler *)					
Maximum dissipated thermal power	$Q_{P,MAX}$	kW	0.705	0.722	0.705
Recommended minimum volume flow	$\dot{V}_{P,MIN}$	l/min	4.7	4.7	4.7
Cooling medium temperature increase	ΔT_P	K	2.16	2.21	2.16
Pressure drop	Δp_P	bar	2.34	2.34	2.34

*) Parallel connection of main and precision motor cooler

Table 6- 32 1FW6160-xxB20-0Wxx

Technical data	Symbol	Unit	-xxB20-0Wxx
1FW6160			
Boundary conditions			
DC link voltage	U_{DC}	V	600
Water cooling inlet temperature	T_{VORL}	°C	35
Rated temperature of winding	T_N	°C	130
Data at the rated operating point			
Rated torque	M_N	Nm	1470
Rated current	I_N	A	124
Rated speed	n_N	rpm	387
Rated power loss	$P_{V,N}$	kW	8.91
Limit data			
Maximum torque	M_{MAX}	Nm	2860
Maximum current	I_{MAX}	A	282
Electric motor power at M_{MAX}	$P_{EL,MAX}$	kW	95
Maximum speed	n_{MAX}	rpm	1080
Maximum speed at maximum torque	$n_{MAX,M_{MAX}}$	rpm	225
Max. speed without VPM	$n_{MAX,INV}$	rpm	741
No-load speed	$n_{MAX,0}$	rpm	542
Torque at $n = 1$ rpm	M_0	Nm	1870
Current at M_0 and $n = 1$ rpm	I_0	A	160
Thermal static torque	M_0^*	Nm	1350
Thermal stall current	I_0^*	A	113
Physical constants			
Torque constant at 20 °C	$k_{T,20}$	Nm/A	11.9
Voltage constant	k_E	V/(1000/min)	720
Motor constant at 20 °C	$k_{M,20}$	Nm/(W) ^{0.5}	24.2
Thermal time constant	t_{TH}	s	180
No. of pole pairs	p	-	35
Cogging torque	M_{COG}	Nm	9.33
Stator mass	m_s	kg	90.6
Rotor mass	m_L	kg	33.7
Rotor moment of inertia	J_L	10 ⁻² kgm ²	70.1
Phase resistance of winding at 20 °C	$R_{STR,20}$	Ω	0.0806
Phase inductance of winding	L_{STR}	mH	0.881
Data for main motor cooler *)			
Maximum dissipated thermal power	$Q_{H,MAX}$	kW	6.69
Recommended minimum volume flow	$\dot{V}_{H,MIN}$	l/min	11.4
Cooling medium temperature increase	ΔT_H	K	8.47
Pressure drop	Δp_H	bar	2.34

Technical data	Symbol	Unit	-xxB20-0Wxx
1FW6160			
Data for precision motor cooler *)			
Maximum dissipated thermal power	$Q_{P,MAX}$	kW	0.722
Recommended minimum volume flow	$\dot{V}_{P,MIN}$	l/min	4.7
Cooling medium temperature increase	ΔT_P	K	2.21
Pressure drop	Δp_P	bar	2.34

*) Parallel connection of main and precision motor cooler

Characteristics for 1FW6160-xxB20-xxxx

Torque M with respect to speed n

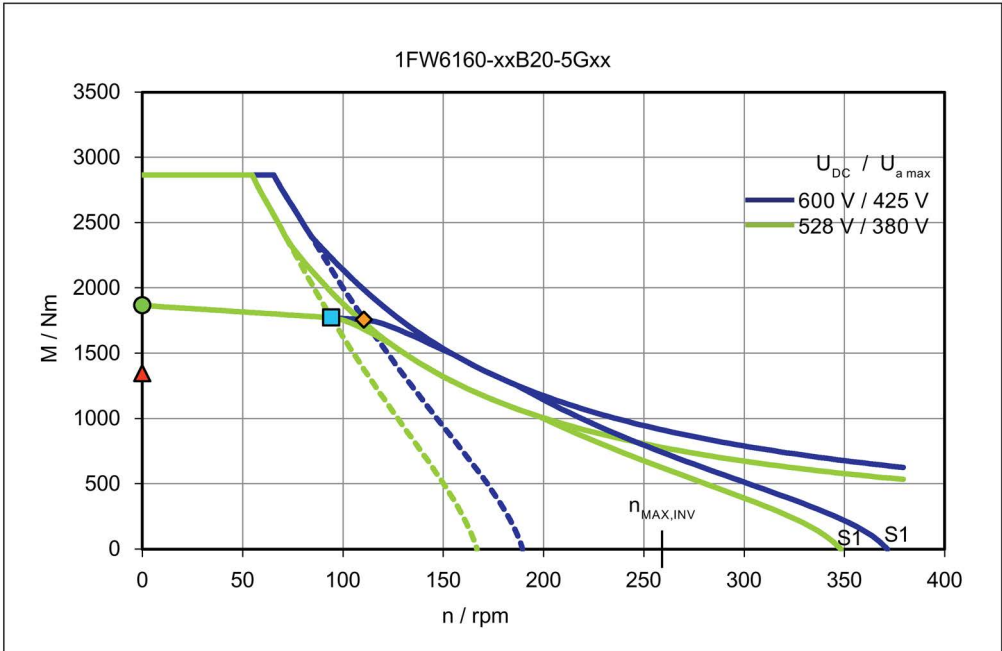

Torque M with respect to speed n

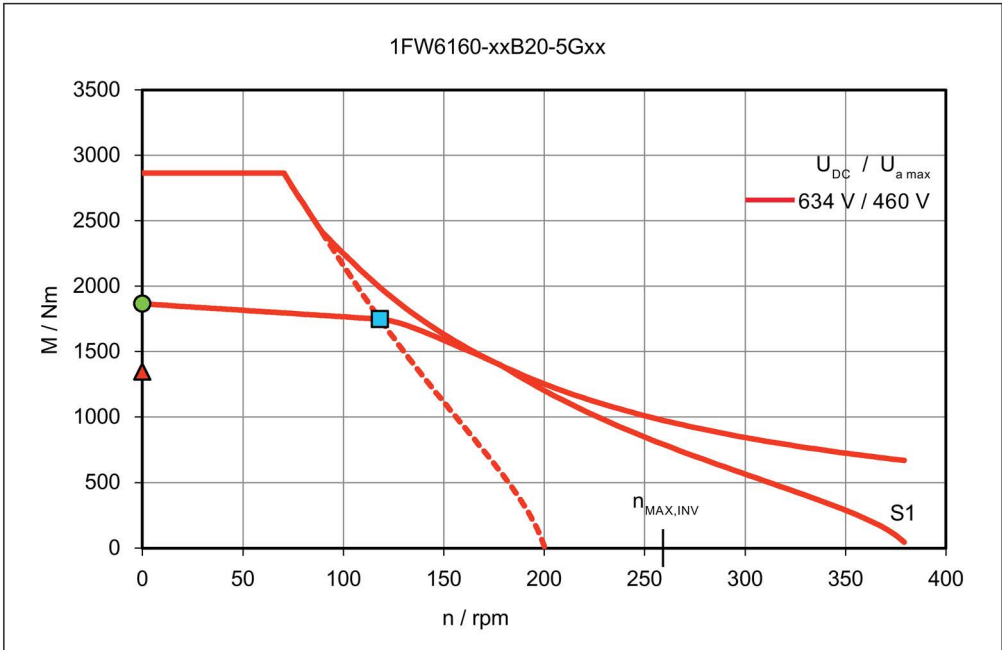

Torque M with respect to speed n

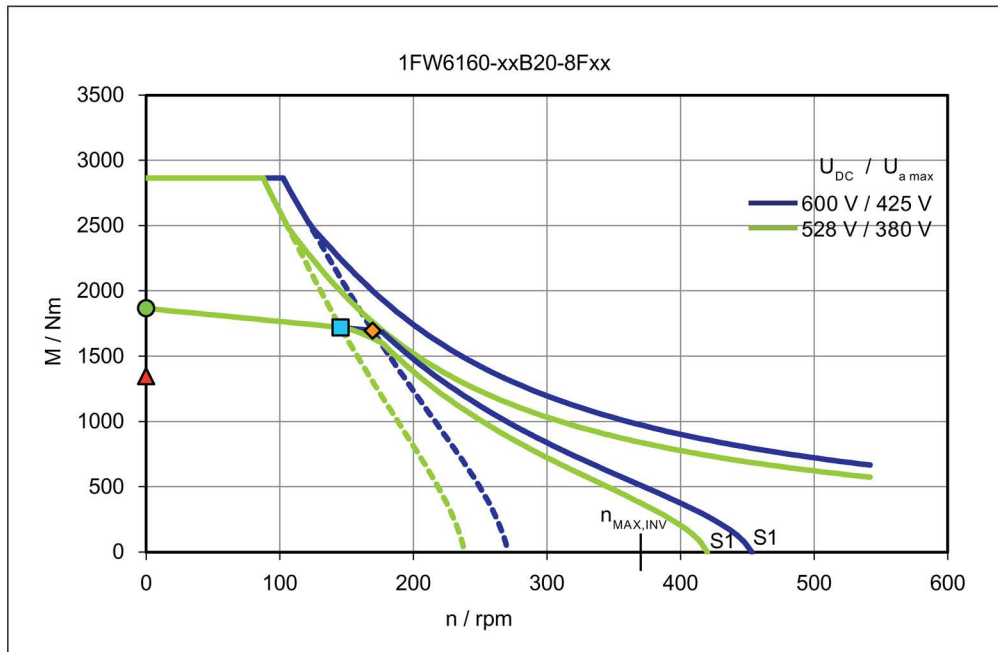

Torque M with respect to speed n

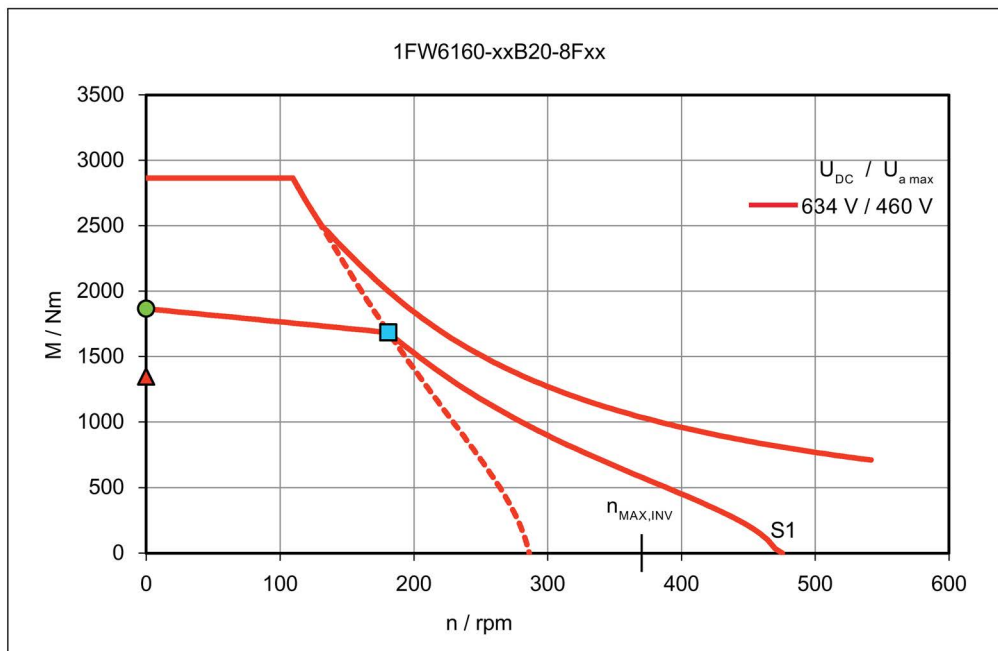

Torque M with respect to speed n

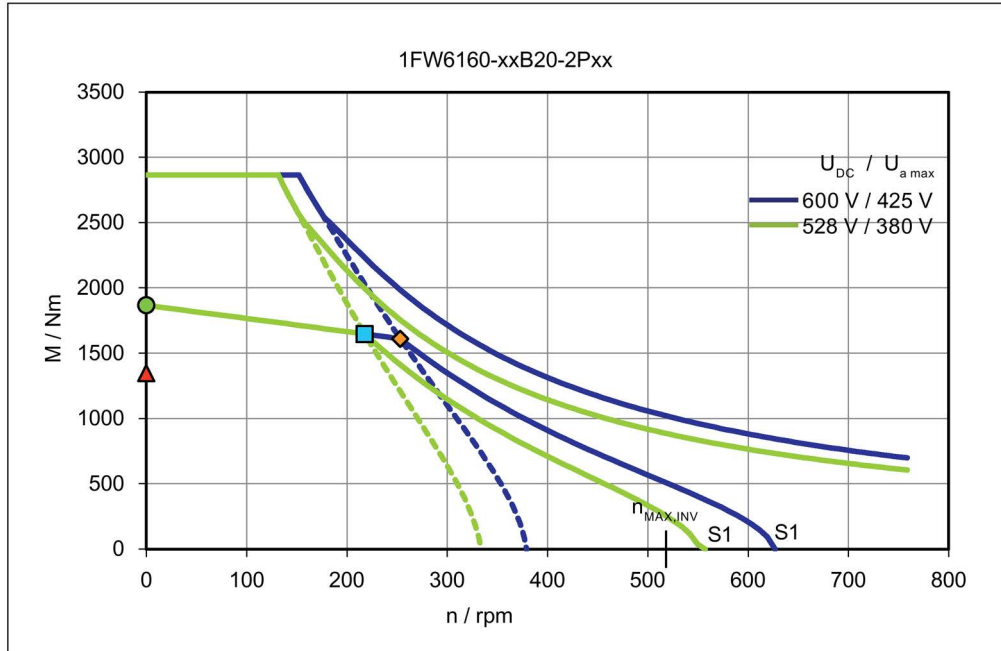

Torque M with respect to speed n

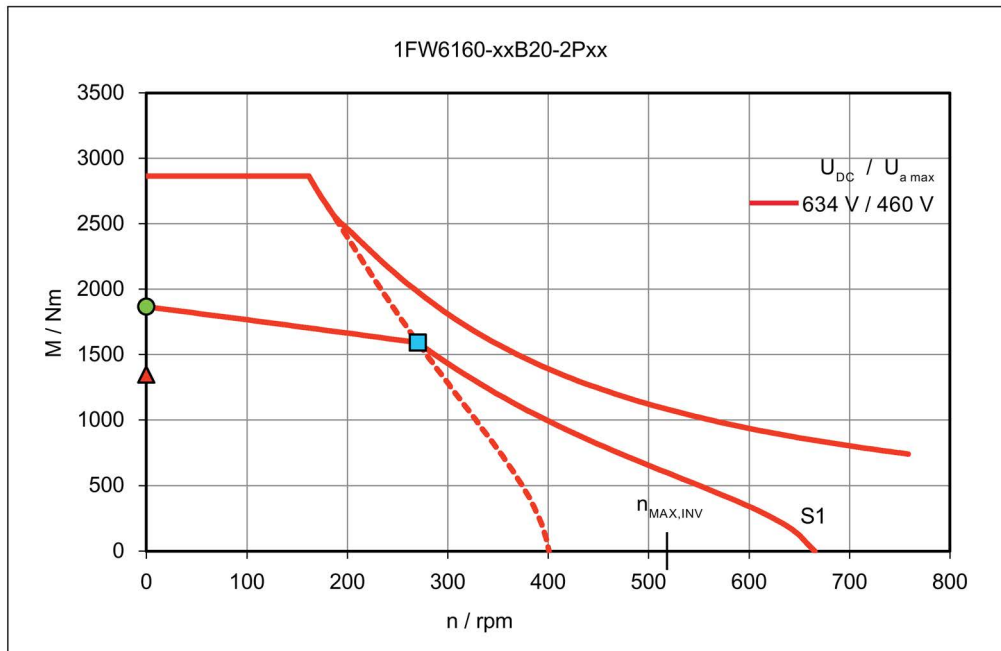

Torque M with respect to speed n

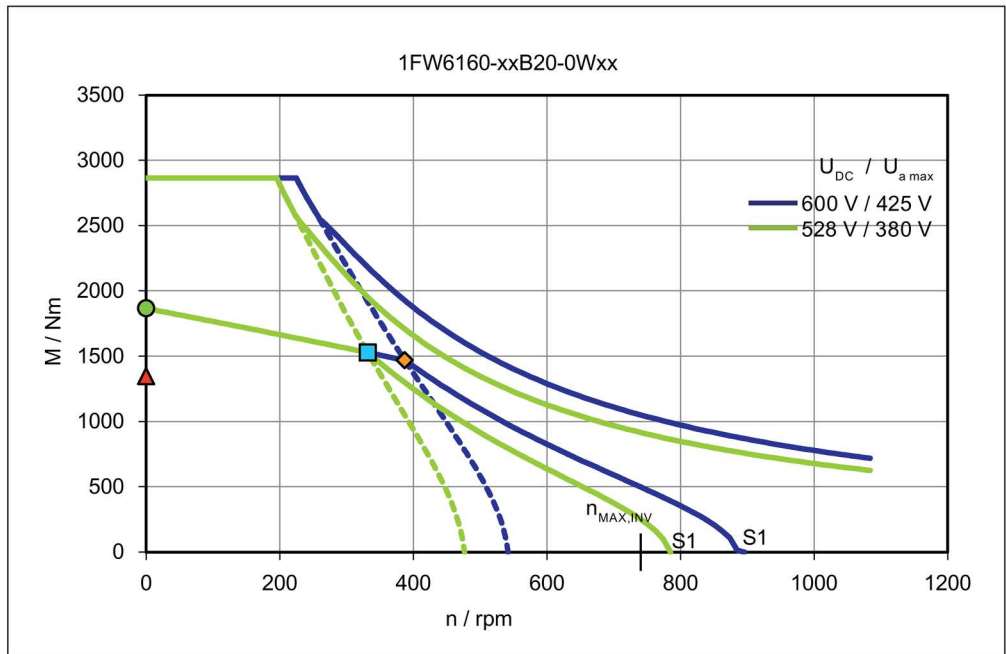

Torque M with respect to speed n

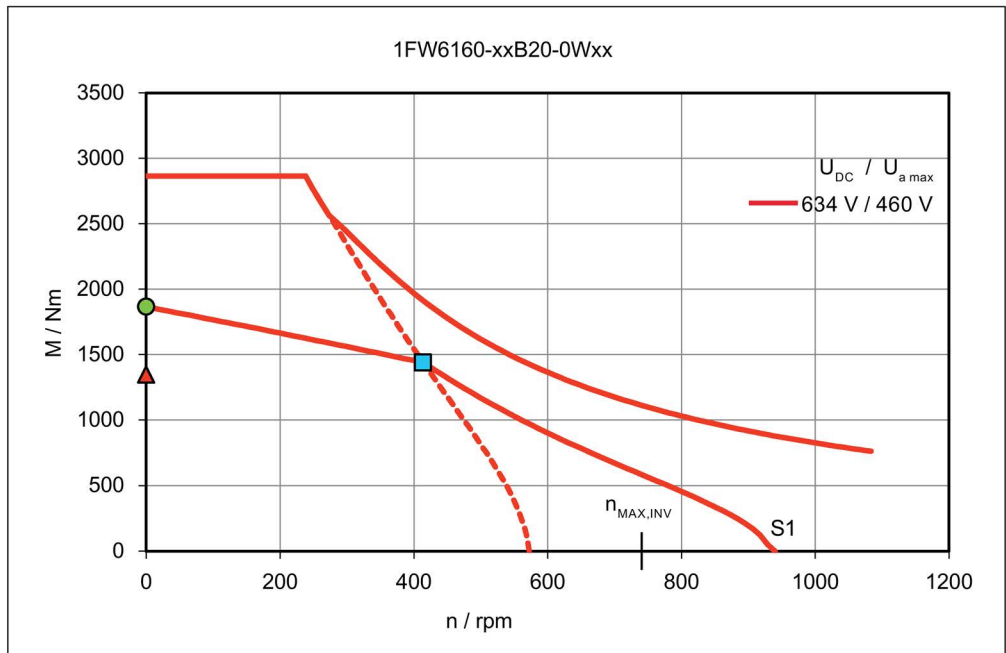

Short-circuit braking torque M_{Br} with respect to speed n

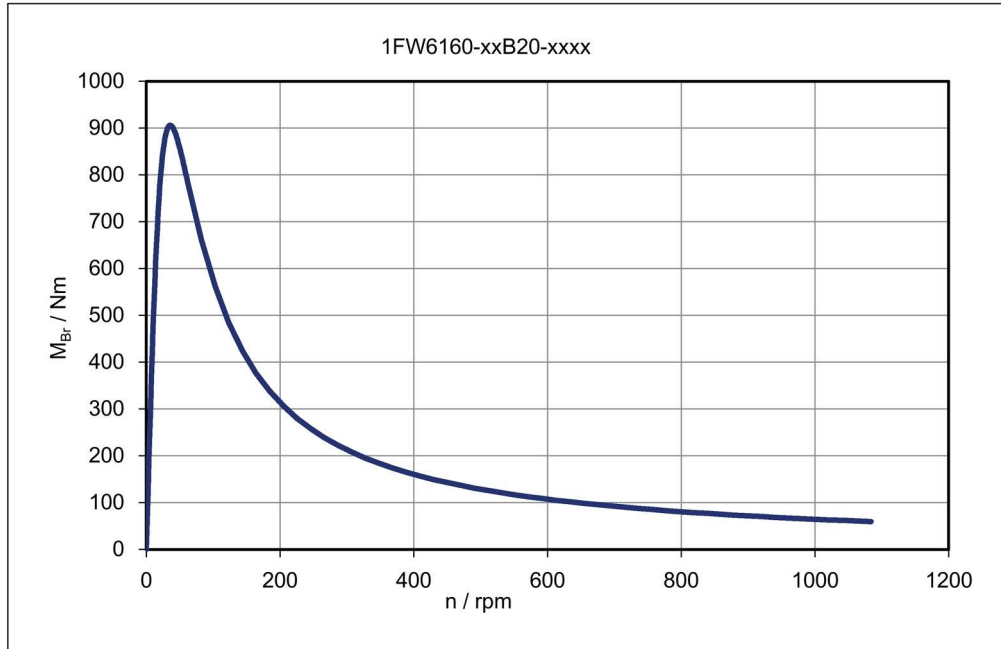

Main cooler and precision cooler - pressure losses Δp with respect to the flow rate \dot{V} (HK || PK: main cooler HK and precision cooler PK connected in parallel)

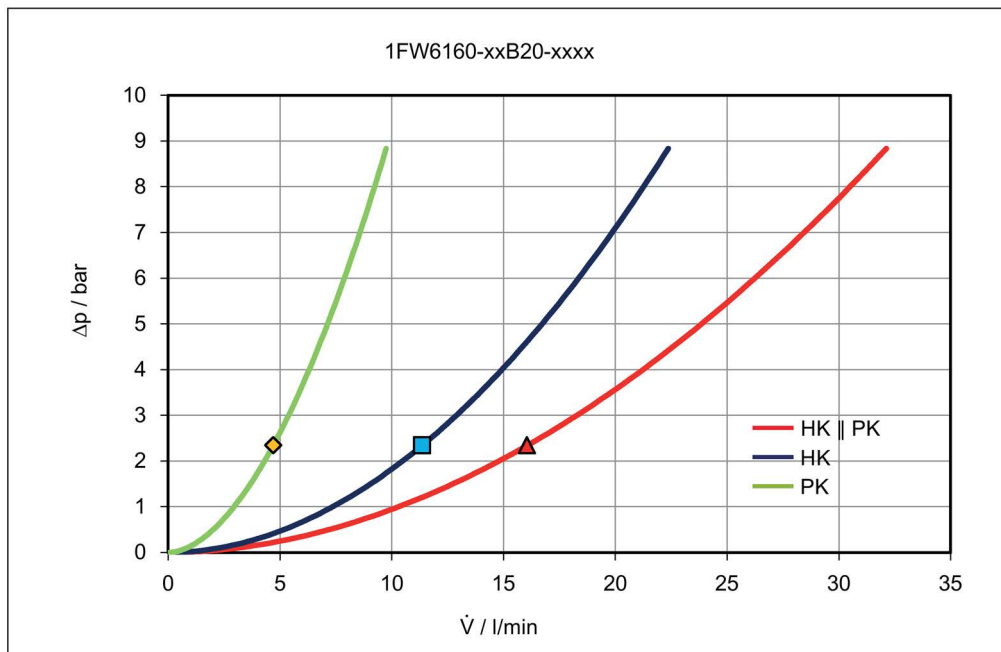

Rotor power loss P_{LV} with respect to speed n

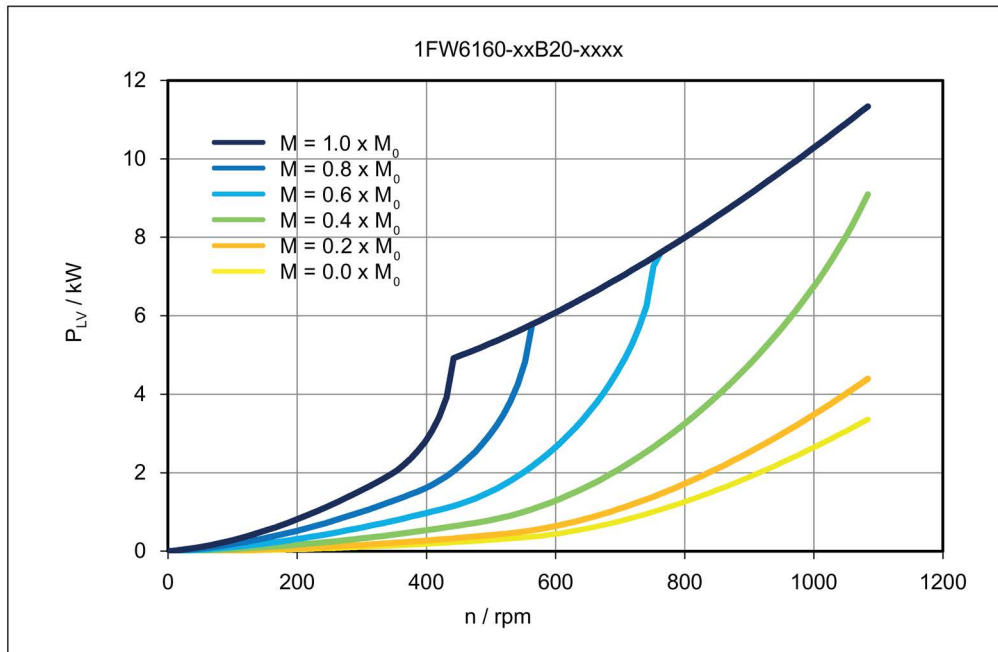

6.2.7 1FW6190-xxxxx-xxxx

Data sheet 1FW6190-xxB05-xxxx

Table 6- 33 1FW6190-xxB05-1Jxx, 1FW6190-xxB05-2Jxx, 1FW6190-xxB05-5Gxx

Technical data	Symbol	Unit	-xxB05-1Jxx	-xxB05-2Jxx	-xxB05-5Gxx
1FW6190					
Boundary conditions					
DC link voltage	U_{DC}	V	600	600	600
Water cooling inlet temperature	T_{VORL}	°C	35	35	35
Rated temperature of winding	T_N	°C	130	130	130
Data at the rated operating point					
Rated torque	M_N	Nm	634	608	516
Rated current	I_N	A	17	24.4	40.8
Rated speed	n_N	rpm	92.7	155	364
Rated power loss	$P_{V,N}$	kW	3.63	3.63	3.63
Limit data					
Maximum torque	M_{MAX}	Nm	990	990	990
Maximum current	I_{MAX}	A	31.8	47.7	95.3
Electric motor power at M_{MAX}	$P_{EL,MAX}$	kW	16.4	20.5	32.2
Maximum speed	n_{MAX}	rpm	345	517	1030
Maximum speed at maximum torque	$n_{MAX,MMAX}$	rpm	51.7	91	204
Max. speed without VPM	$n_{MAX,INV}$	rpm	236	353	707
No-load speed	$n_{MAX,0}$	rpm	172	259	517
Torque at $n = 1$ rpm	M_0	Nm	672	672	672
Current at M_0 and $n = 1$ rpm	I_0	A	18.2	27.3	54.7
Thermal static torque	M_0^*	Nm	491	491	491
Thermal stall current	I_0^*	A	12.9	19.3	38.7
Physical constants					
Torque constant at 20 °C	$k_{T,20}$	Nm/A	38.7	25.8	12.9
Voltage constant	k_E	V/(1000/min)	2340	1560	779
Motor constant at 20 °C	$k_{M,20}$	Nm/(W) ^{0.5}	14	14	14
Thermal time constant	t_{TH}	s	180	180	180
No. of pole pairs	p	-	42	42	42
Cogging torque	M_{COG}	Nm	3.36	3.36	3.36
Stator mass	m_S	kg	32.1	32.1	32.1
Rotor mass	m_L	kg	10.7	10.7	10.7
Rotor moment of inertia	J_L	10 ⁻² kgm ²	35.8	35.8	35.8
Phase resistance of winding at 20 °C	$R_{STR, 20}$	Ω	2.54	1.13	0.283
Phase inductance of winding	L_{STR}	mH	21.5	9.56	2.39

Technical data	Symbol	Unit	-xxB05-1Jxx	-xxB05-2Jxx	-xxB05-5Gxx
1FW6190					
Data for main motor cooler *)					
Maximum dissipated thermal power	$Q_{H,MAX}$	kW	2.73	2.73	2.73
Recommended minimum volume flow	$\dot{V}_{H,MIN}$	l/min	5.23	5.23	5.23
Cooling medium temperature increase	ΔT_H	K	7.51	7.51	7.51
Pressure drop	Δp_H	bar	0.495	0.495	0.495
Data for precision motor cooler *)					
Maximum dissipated thermal power	$Q_{P,MAX}$	kW	0.294	0.294	0.294
Recommended minimum volume flow	$\dot{V}_{P,MIN}$	l/min	1.78	1.78	1.78
Cooling medium temperature increase	ΔT_P	K	2.38	2.38	2.38
Pressure drop	Δp_P	bar	0.495	0.495	0.495

*) Parallel connection of main and precision motor cooler

Characteristics for 1FW6190-xxB05-xxxx

Torque M with respect to speed n

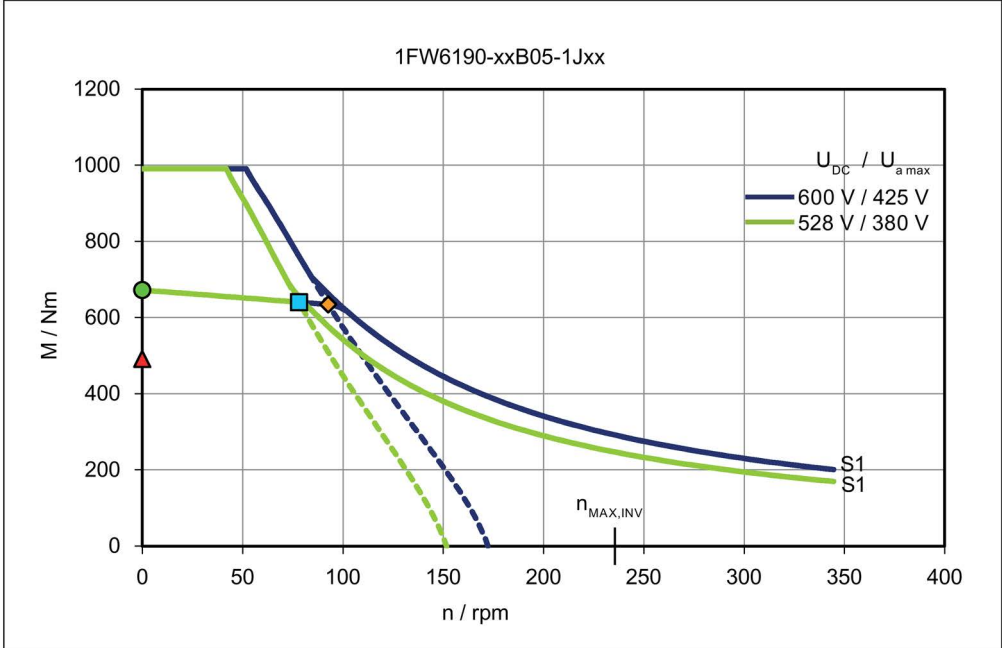

Torque M with respect to speed n

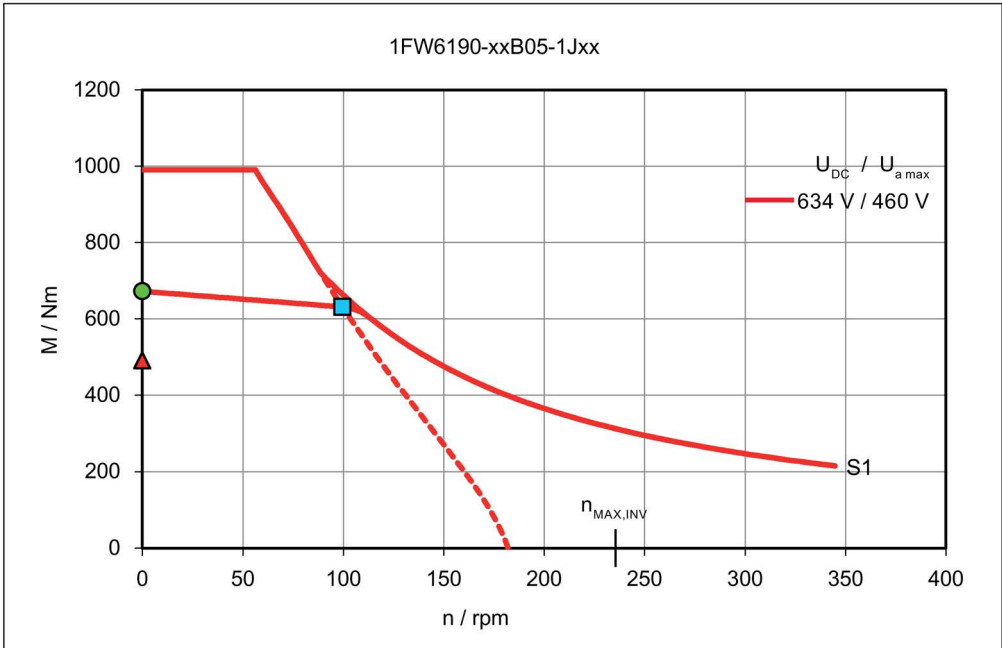

Torque M with respect to speed n

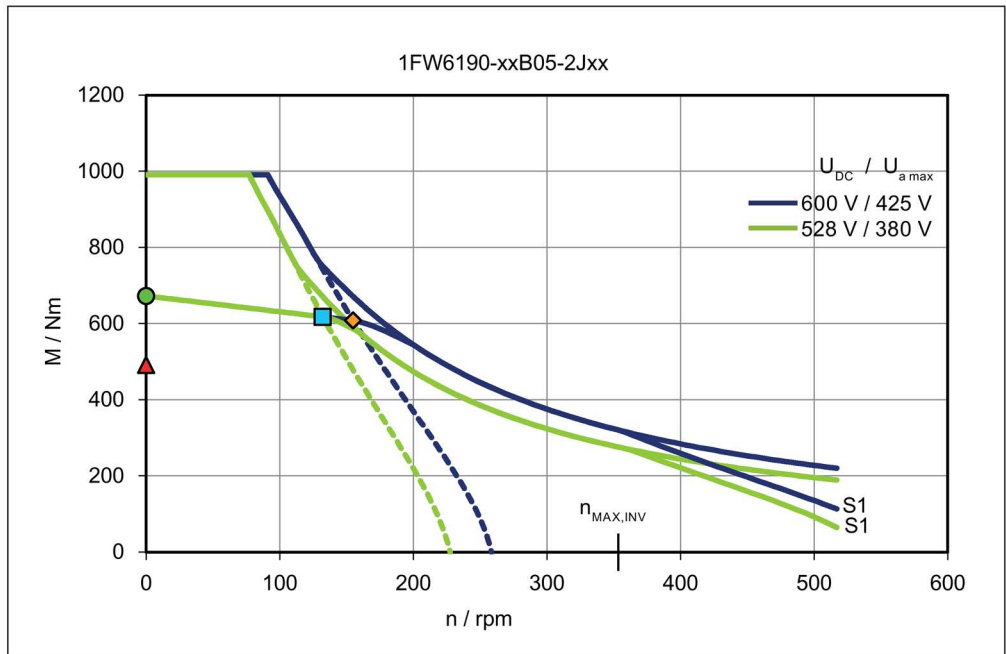

Torque M with respect to speed n

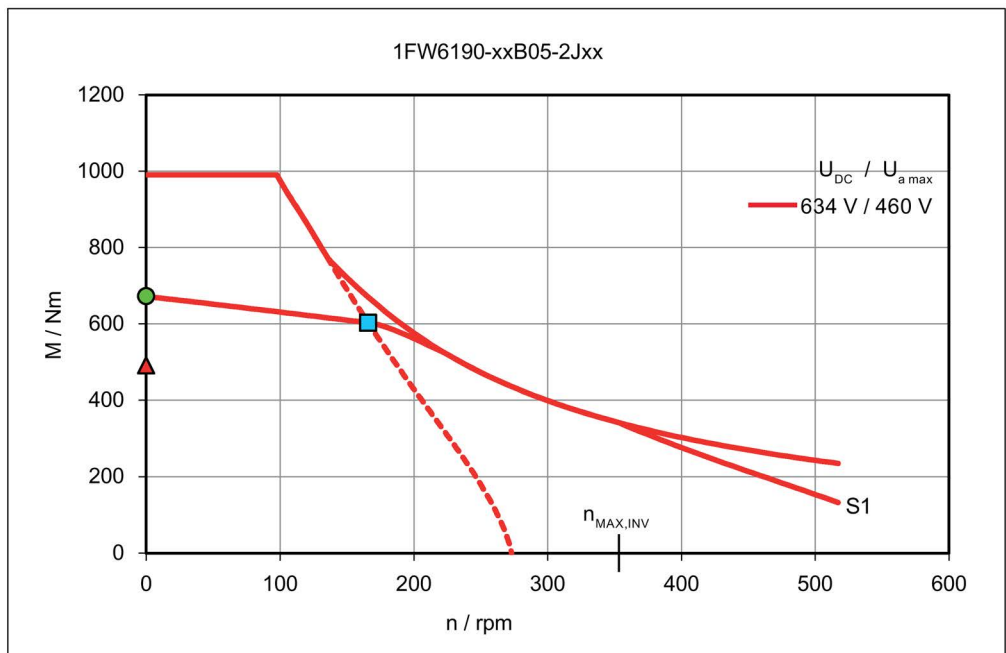

Torque M with respect to speed n

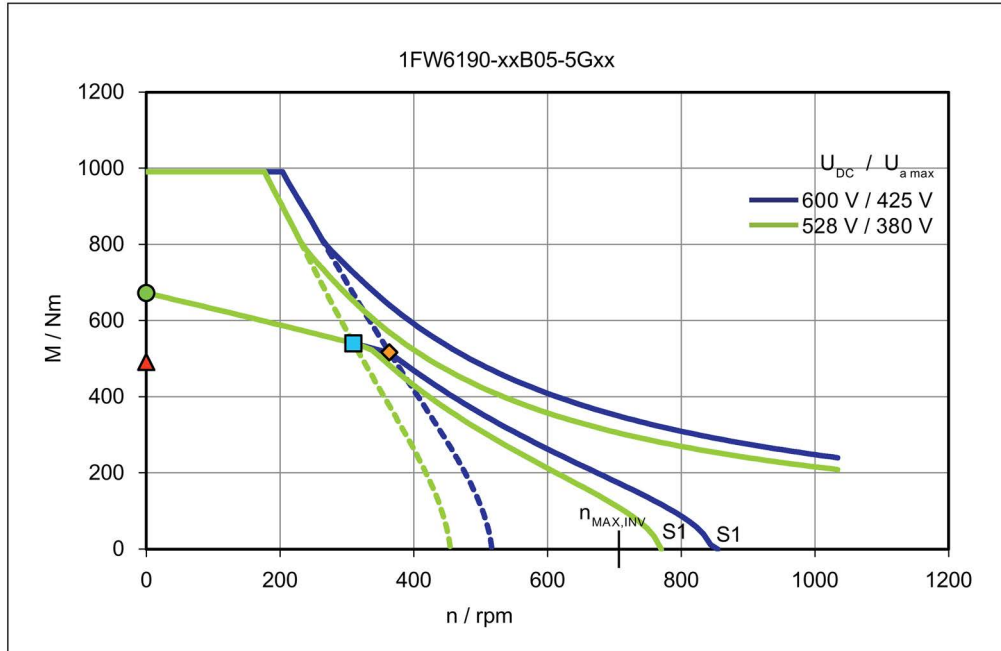

Torque M with respect to speed n

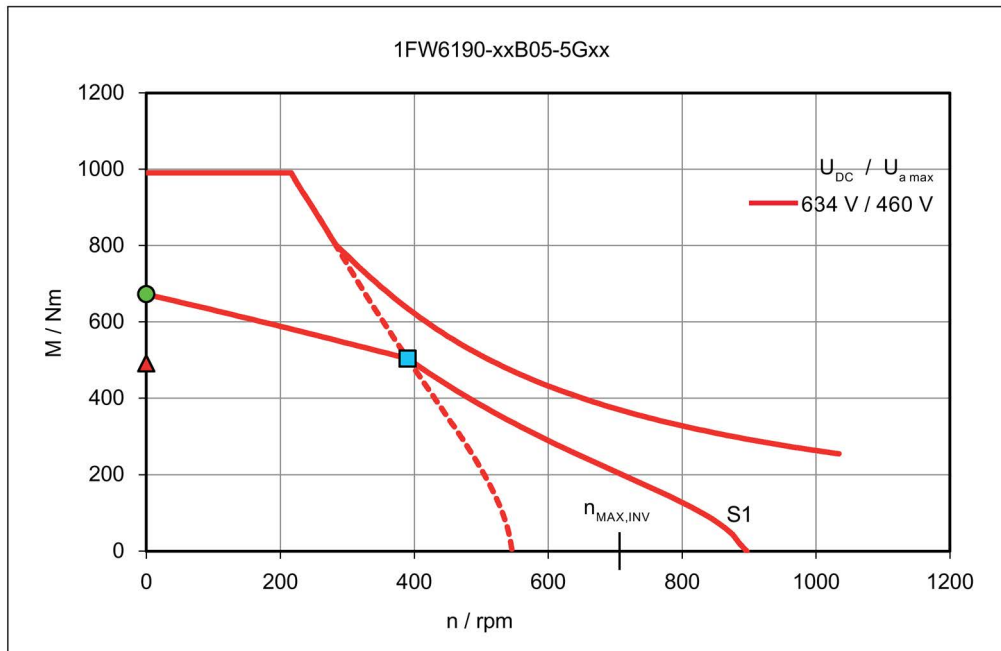

Short-circuit braking torque M_{Br} with respect to speed n

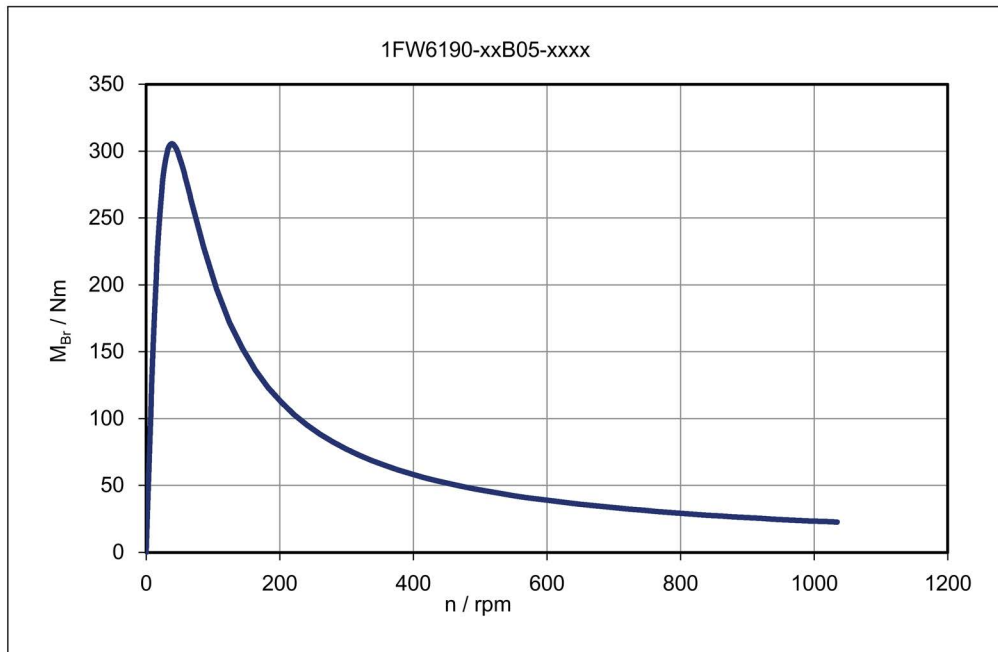

Main cooler and precision cooler - pressure losses Δp with respect to the flow rate \dot{V} (HK || PK: main cooler HK and precision cooler PK connected in parallel)

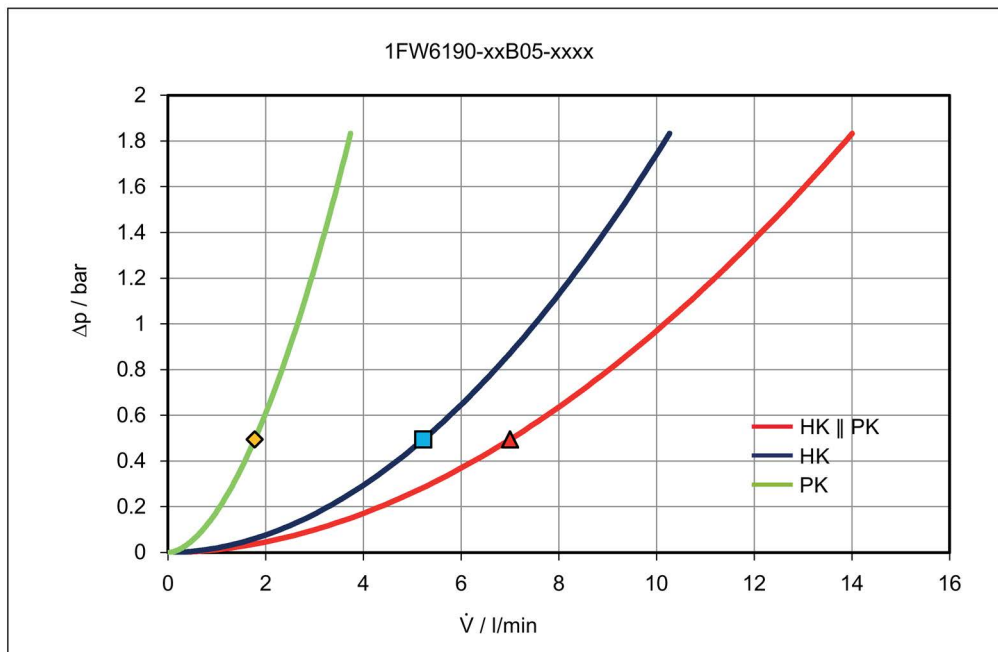

Rotor power loss P_{LV} with respect to speed n

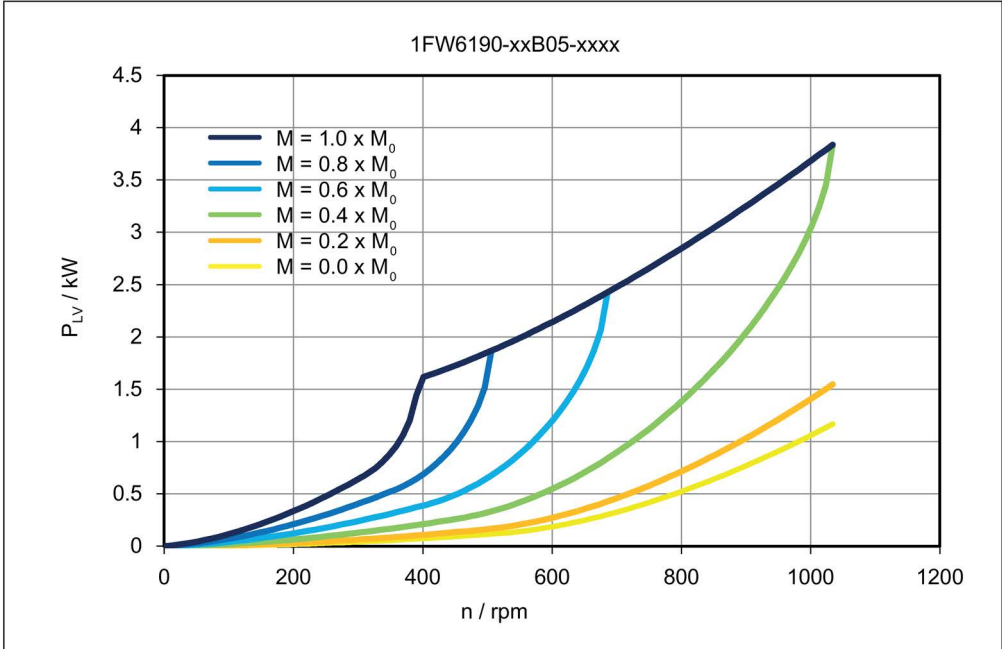

Data sheet 1FW6190-xxB07-xxxx

Table 6- 34 1FW6190-xxB07-1Jxx, 1FW6190-xxB07-2Jxx, 1FW6190-xxB07-5Gxx

Technical data	Symbol	Unit	-xxB07-1Jxx	-xxB07-2Jxx	-xxB07-5Gxx
1FW6190					
Boundary conditions					
DC link voltage	U_{DC}	V	600	600	600
Water cooling inlet temperature	T_{VORL}	°C	35	35	35
Rated temperature of winding	T_N	°C	130	130	130
Data at the rated operating point					
Rated torque	M_N	Nm	907	881	798
Rated current	I_N	A	17.5	25.3	45.4
Rated speed	n_N	rpm	61	105	244
Rated power loss	$P_{V,N}$	kW	4.56	4.56	4.56
Limit data					
Maximum torque	M_{MAX}	Nm	1390	1390	1390
Maximum current	I_{MAX}	A	31.8	47.7	95.3
Electric motor power at M_{MAX}	$P_{EL,MAX}$	kW	18.4	22.7	34.6
Maximum speed	n_{MAX}	rpm	246	369	739
Maximum speed at maximum torque	$n_{MAX,MMAX}$	rpm	31.2	60.8	143
Max. speed without VPM	$n_{MAX,INV}$	rpm	168	252	505
No-load speed	$n_{MAX,0}$	rpm	123	185	369
Torque at $n = 1$ rpm	M_0	Nm	941	941	941
Current at M_0 and $n = 1$ rpm	I_0	A	18.2	27.3	54.7
Thermal static torque	M_0^*	Nm	688	688	688
Thermal stall current	I_0^*	A	12.9	19.3	38.7
Physical constants					
Torque constant at 20 °C	$k_{T,20}$	Nm/A	54.1	36.1	18
Voltage constant	k_E	V/(1000/min)	3270	2180	1090
Motor constant at 20 °C	$k_{M,20}$	Nm/(W) ^{0.5}	17.5	17.5	17.5
Thermal time constant	t_{TH}	s	180	180	180
No. of pole pairs	p	-	42	42	42
Cogging torque	M_{COG}	Nm	4.71	4.71	4.71
Stator mass	m_S	kg	41.2	41.2	41.2
Rotor mass	m_L	kg	14.6	14.6	14.6
Rotor moment of inertia	J_L	10 ⁻² kgm ²	48.6	48.6	48.6
Phase resistance of winding at 20 °C	$R_{STR,20}$	Ω	3.19	1.42	0.355
Phase inductance of winding	L_{STR}	mH	29.8	13.2	3.31

Technical data	Symbol	Unit	-xxB07-1Jxx	-xxB07-2Jxx	-xxB07-5Gxx
1FW6190					
Data for main motor cooler *)					
Maximum dissipated thermal power	$Q_{H,MAX}$	kW	3.43	3.43	3.43
Recommended minimum volume flow	$\dot{V}_{H,MIN}$	l/min	5.95	5.95	5.95
Cooling medium temperature increase	ΔT_H	K	8.28	8.28	8.28
Pressure drop	Δp_H	bar	0.636	0.636	0.636
Data for precision motor cooler *)					
Maximum dissipated thermal power	$Q_{P,MAX}$	kW	0.37	0.37	0.37
Recommended minimum volume flow	$\dot{V}_{P,MIN}$	l/min	2.05	2.05	2.05
Cooling medium temperature increase	ΔT_P	K	2.59	2.59	2.59
Pressure drop	Δp_P	bar	0.636	0.636	0.636

*) Parallel connection of main and precision motor cooler

Table 6- 35 1FW6190-xxB07-8Fxx

Technical data	Symbol	Unit	-xxB07-8Fxx
1FW6190			
Boundary conditions			
DC link voltage	U_{DC}	V	600
Water cooling inlet temperature	T_{VORL}	°C	35
Rated temperature of winding	T_N	°C	130
Data at the rated operating point			
Rated torque	M_N	Nm	714
Rated current	I_N	A	57.5
Rated speed	n_N	rpm	377
Rated power loss	$P_{V,N}$	kW	4.71
Limit data			
Maximum torque	M_{MAX}	Nm	1390
Maximum current	I_{MAX}	A	136
Electric motor power at M_{MAX}	$P_{EL,MAX}$	kW	45
Maximum speed	n_{MAX}	rpm	1060
Maximum speed at maximum torque	$n_{MAX,MMAX}$	rpm	212
Max. speed without VPM	$n_{MAX,INV}$	rpm	721
No-load speed	$n_{MAX,0}$	rpm	528
Torque at $n = 1$ rpm	M_0	Nm	941
Current at M_0 and $n = 1$ rpm	I_0	A	78.1
Thermal static torque	M_0^*	Nm	688
Thermal stall current	I_0^*	A	55.3
Physical constants			
Torque constant at 20 °C	$k_{T,20}$	Nm/A	12.6
Voltage constant	k_E	V/(1000/min)	764
Motor constant at 20 °C	$k_{M,20}$	Nm/(W) ^{0.5}	17.2
Thermal time constant	t_{TH}	s	180
No. of pole pairs	p	-	42
Cogging torque	M_{COG}	Nm	4.71
Stator mass	m_S	kg	41.2
Rotor mass	m_L	kg	14.6
Rotor moment of inertia	J_L	10 ⁻² kgm ²	48.6
Phase resistance of winding at 20 °C	$R_{STR,20}$	Ω	0.179
Phase inductance of winding	L_{STR}	mH	1.62
Data for main motor cooler *)			
Maximum dissipated thermal power	$Q_{H,MAX}$	kW	3.53
Recommended minimum volume flow	$\dot{V}_{H,MIN}$	l/min	5.95
Cooling medium temperature increase	ΔT_H	K	8.55
Pressure drop	Δp_H	bar	0.636

Technical data	Symbol	Unit	-xxB07-8Fxx
1FW6190			
Data for precision motor cooler *)			
Maximum dissipated thermal power	$Q_{P,MAX}$	kW	0.381
Recommended minimum volume flow	$\dot{V}_{P,MIN}$	l/min	2.05
Cooling medium temperature increase	ΔT_P	K	2.68
Pressure drop	Δp_P	bar	0.636

*) Parallel connection of main and precision motor cooler

Characteristics for 1FW6190-xxB07-xxxx

Torque M with respect to speed n

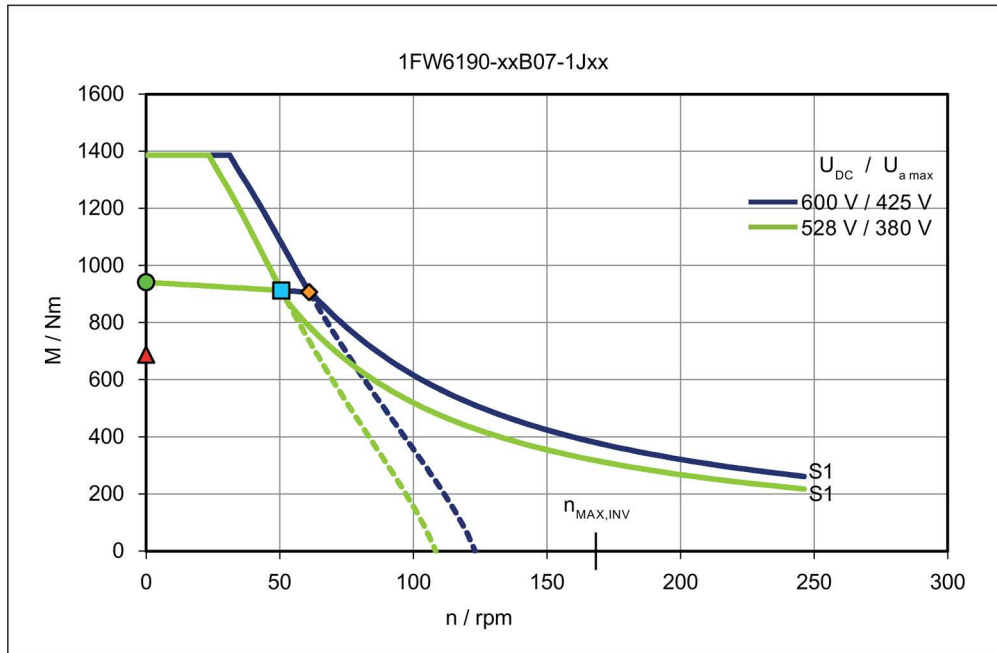

Torque M with respect to speed n

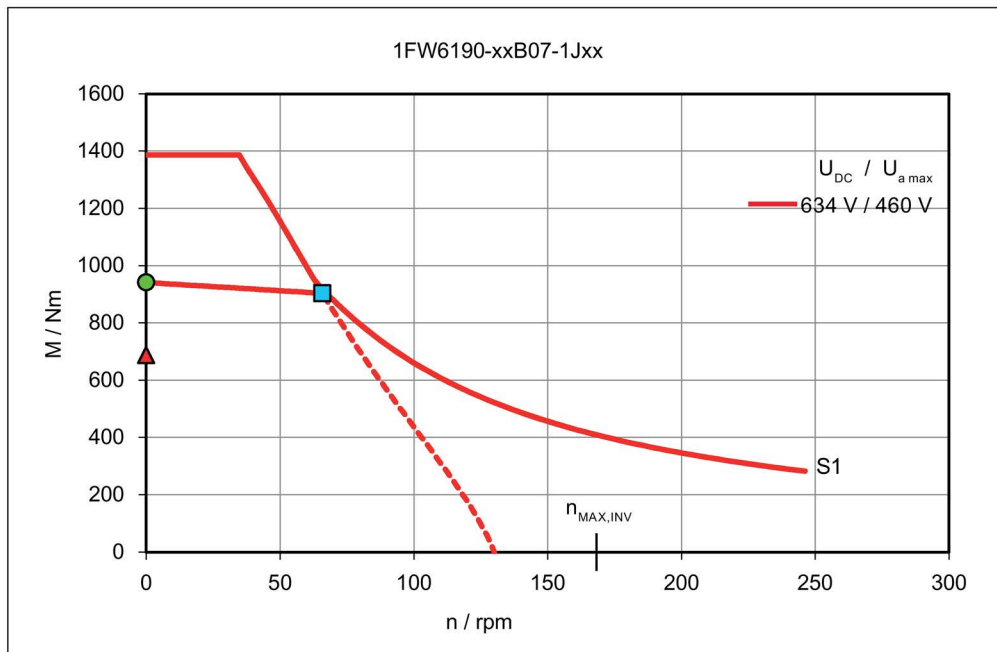

Torque M with respect to speed n

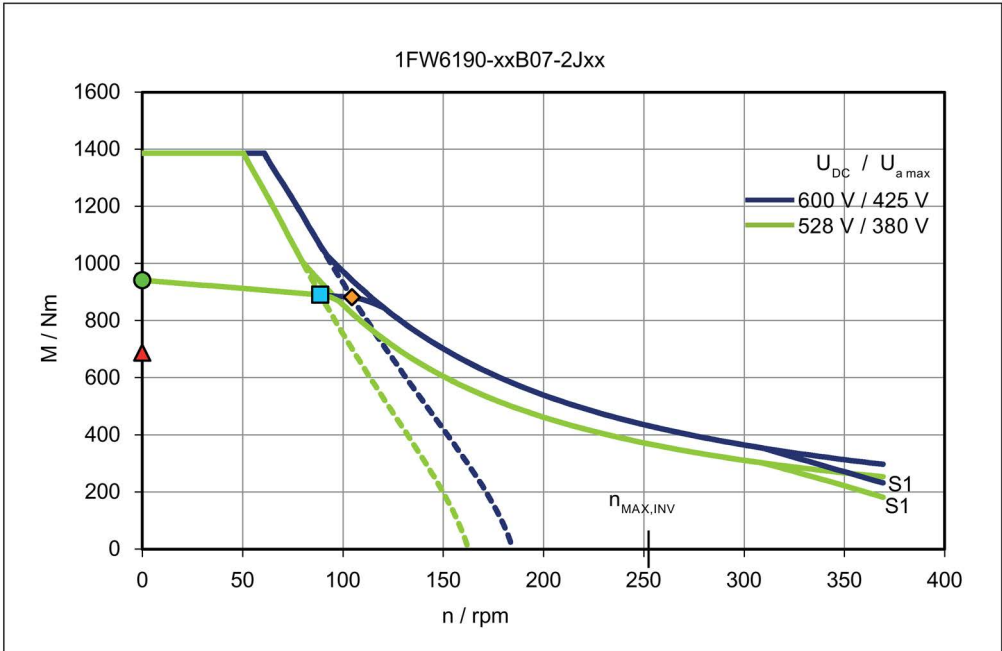

Torque M with respect to speed n

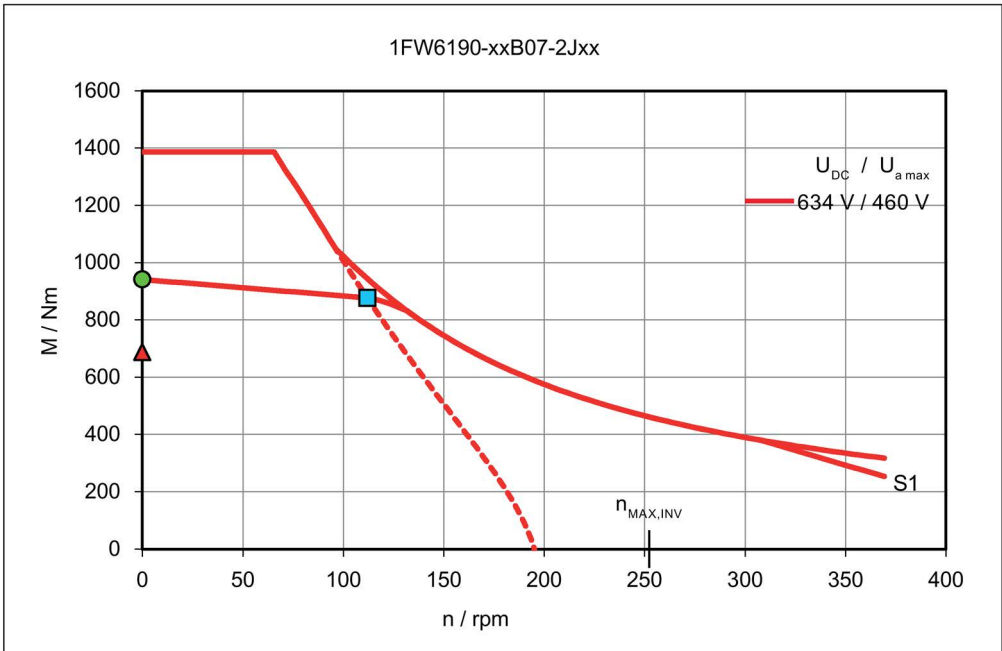

Torque M with respect to speed n

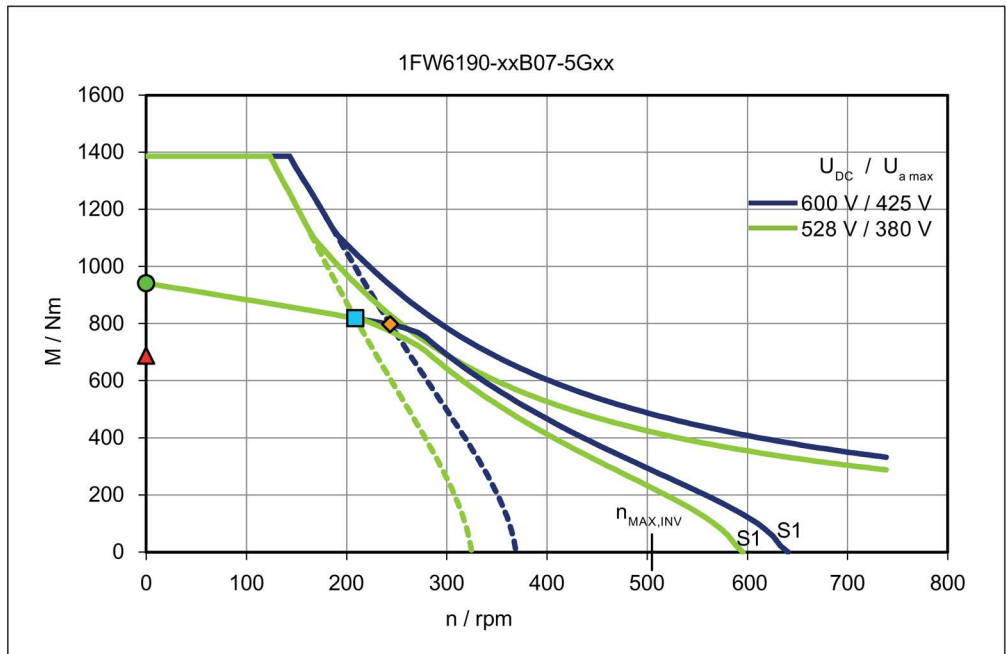

Torque M with respect to speed n

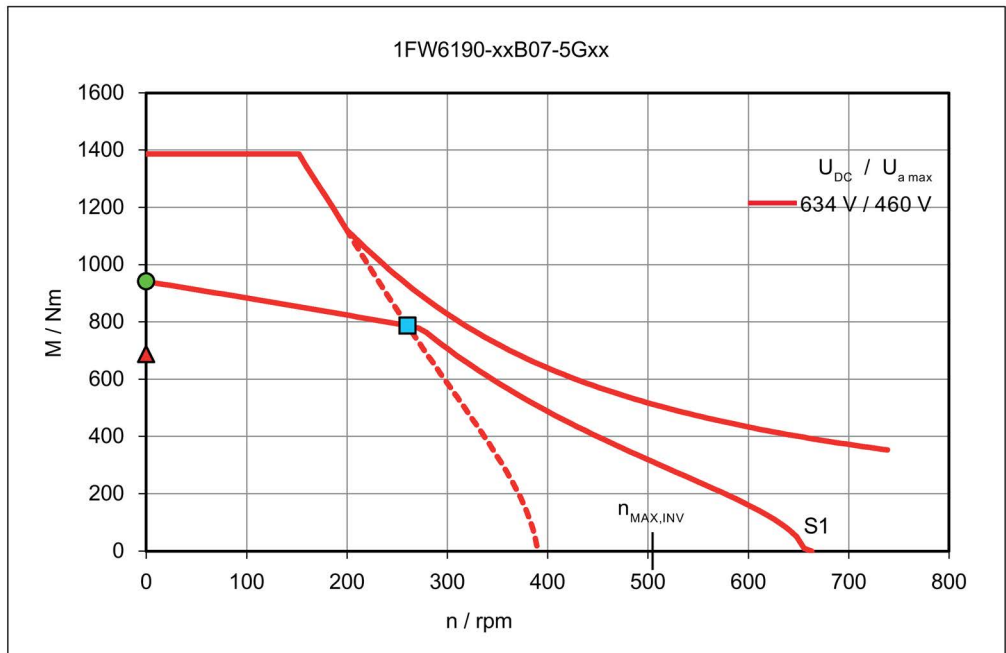

Torque M with respect to speed n

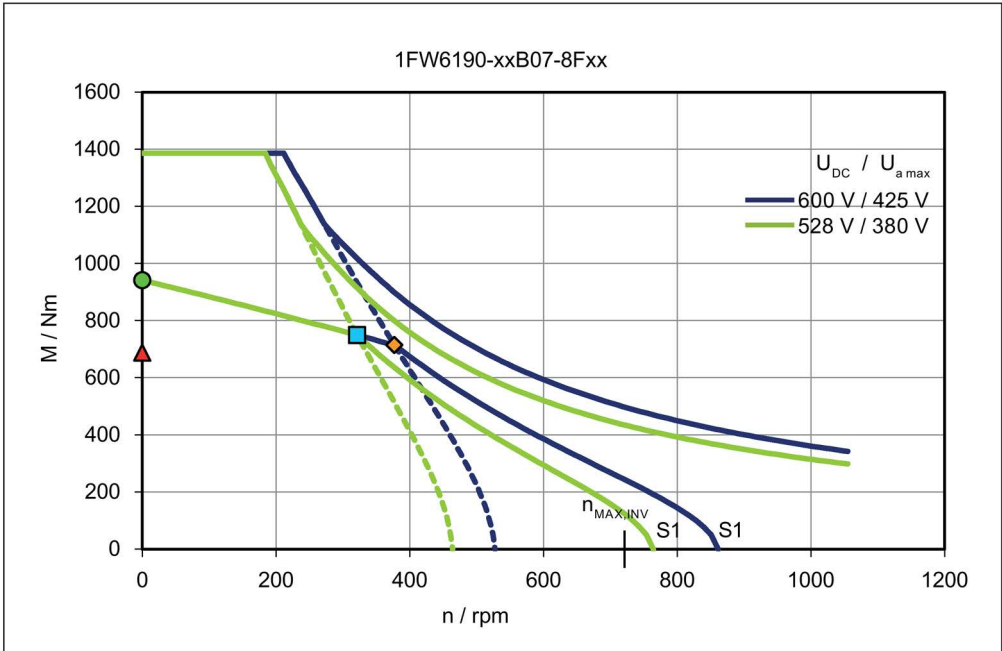

Torque M with respect to speed n

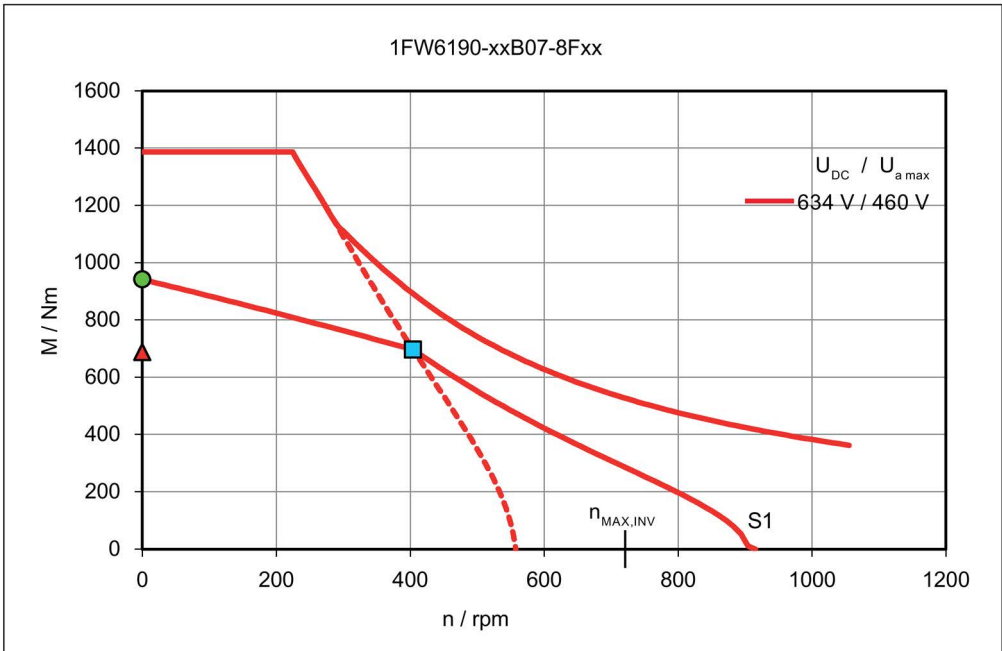

Short-circuit braking torque M_{Br} with respect to speed n

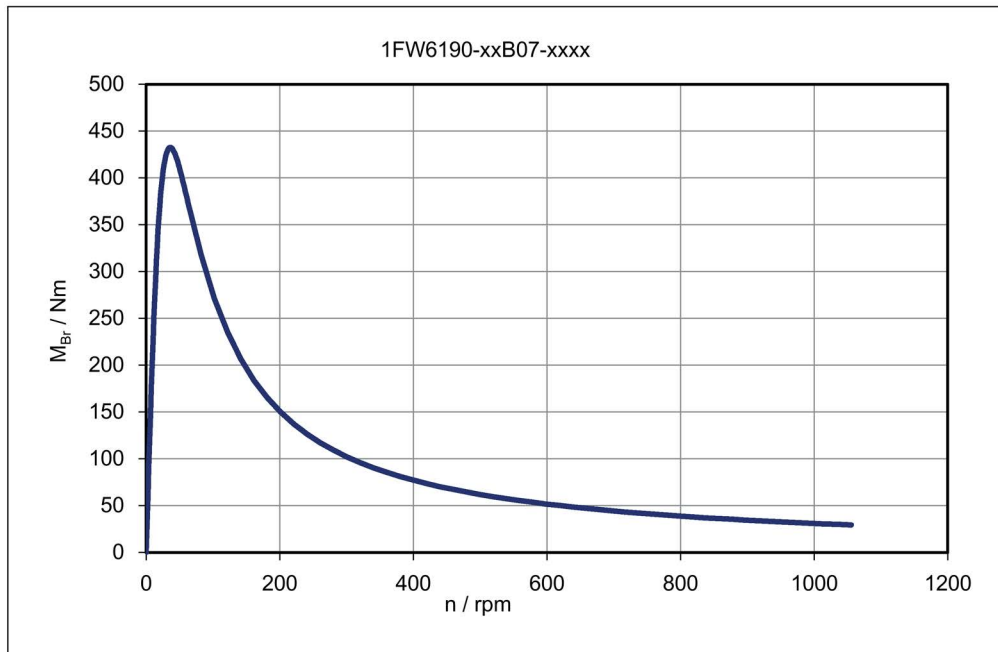

Main cooler and precision cooler - pressure losses Δp with respect to the flow rate \dot{V} (HK || PK: main cooler HK and precision cooler PK connected in parallel)

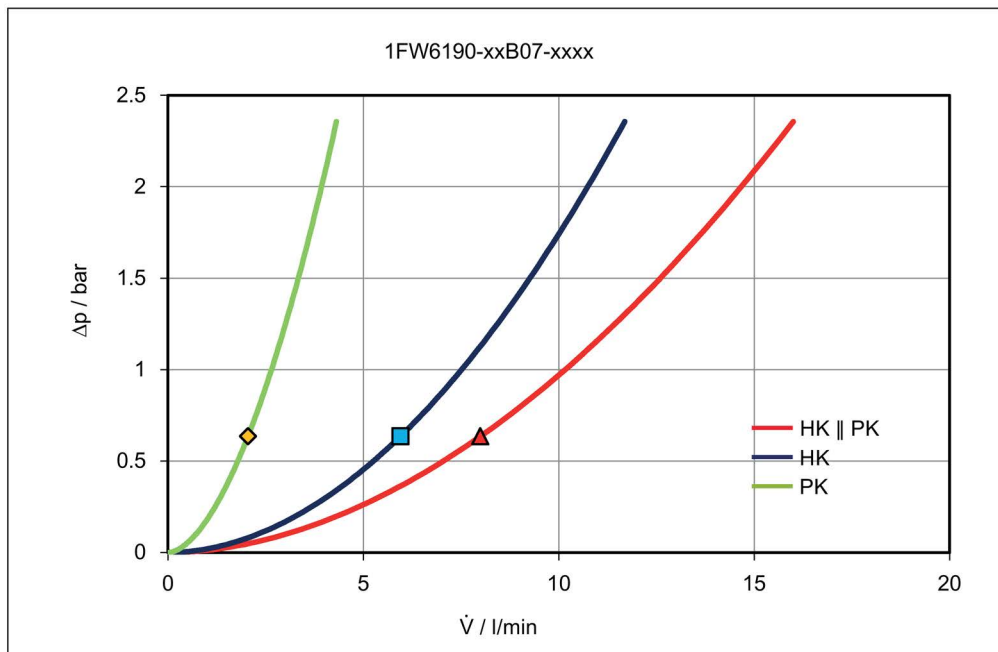

Rotor power loss P_{LV} with respect to speed n

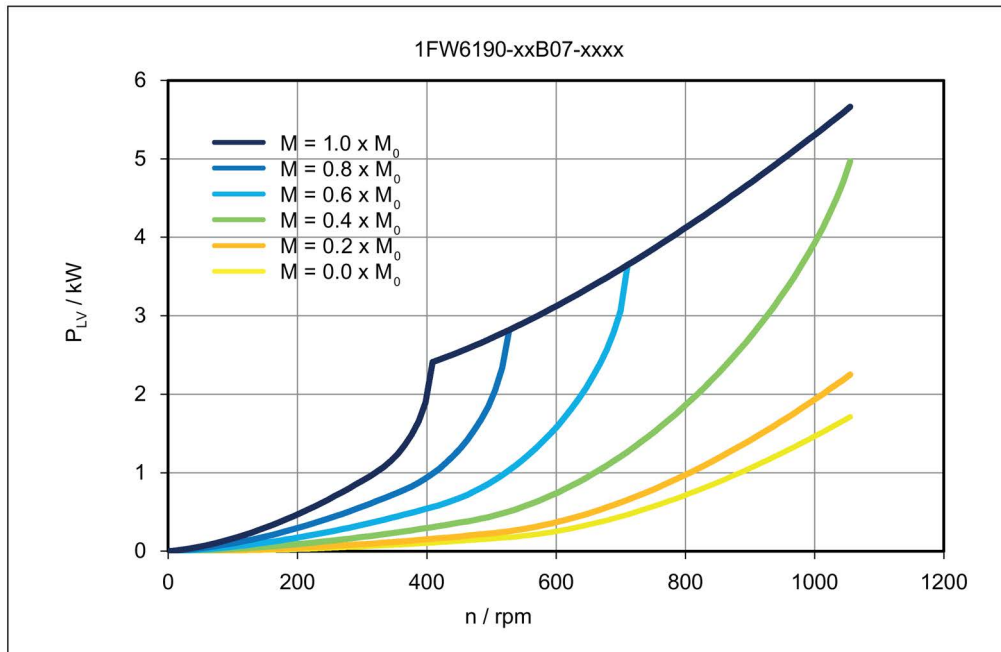

Data sheet 1FW6190-xxB10-xxxx

Table 6- 36 1FW6190-xxB10-1Jxx, 1FW6190-xxB10-2Jxx, 1FW6190-xxB10-5Gxx

Technical data	Symbol	Unit	-xxB10-1Jxx	-xxB10-2Jxx	-xxB10-5Gxx
1FW6190					
Boundary conditions					
DC link voltage	U_{DC}	V	600	600	600
Water cooling inlet temperature	T_{VORL}	°C	35	35	35
Rated temperature of winding	T_N	°C	130	130	130
Data at the rated operating point					
Rated torque	M_N	Nm	1310	1290	1210
Rated current	I_N	A	17.8	26.1	48.5
Rated speed	n_N	rpm	37.2	67.6	161
Rated power loss	$P_{V,N}$	kW	5.96	5.96	5.96
Limit data					
Maximum torque	M_{MAX}	Nm	1980	1980	1980
Maximum current	I_{MAX}	A	31.8	47.7	95.3
Electric motor power at M_{MAX}	$P_{EL,MAX}$	kW	21	25.8	38.1
Maximum speed	n_{MAX}	rpm	172	259	517
Maximum speed at maximum torque	$n_{MAX,MMAX}$	rpm	14.2	37.1	96.6
Max. speed without VPM	$n_{MAX,INV}$	rpm	118	177	353
No-load speed	$n_{MAX,0}$	rpm	86.2	129	259
Torque at $n = 1$ rpm	M_0	Nm	1340	1340	1340
Current at M_0 and $n = 1$ rpm	I_0	A	18.2	27.3	54.7
Thermal static torque	M_0^*	Nm	982	982	982
Thermal stall current	I_0^*	A	12.9	19.3	38.7
Physical constants					
Torque constant at 20 °C	$k_{T,20}$	Nm/A	77.3	51.6	25.8
Voltage constant	k_E	V/(1000/min)	4680	3120	1560
Motor constant at 20 °C	$k_{M,20}$	Nm/(W) ^{0.5}	21.9	21.9	21.9
Thermal time constant	t_{TH}	s	180	180	180
No. of pole pairs	p	-	42	42	42
Cogging torque	M_{COG}	Nm	6.72	6.72	6.72
Stator mass	m_S	kg	55.5	55.5	55.5
Rotor mass	m_L	kg	20.3	20.3	20.3
Rotor moment of inertia	J_L	10 ⁻² kgm ²	67.8	67.8	67.8
Phase resistance of winding at 20 °C	$R_{STR,20}$	Ω	4.17	1.85	0.463
Phase inductance of winding	L_{STR}	mH	42.2	18.8	4.69

Technical data	Symbol	Unit	-xxB10-1Jxx	-xxB10-2Jxx	-xxB10-5Gxx
1FW6190					
Data for main motor cooler *)					
Maximum dissipated thermal power	$Q_{H,MAX}$	kW	4.47	4.47	4.47
Recommended minimum volume flow	$\dot{V}_{H,MIN}$	l/min	6.67	6.67	6.67
Cooling medium temperature increase	ΔT_H	K	9.64	9.64	9.64
Pressure drop	Δp_H	bar	0.795	0.795	0.795
Data for precision motor cooler *)					
Maximum dissipated thermal power	$Q_{P,MAX}$	kW	0.482	0.482	0.482
Recommended minimum volume flow	$\dot{V}_{P,MIN}$	l/min	2.33	2.33	2.33
Cooling medium temperature increase	ΔT_P	K	2.98	2.98	2.98
Pressure drop	Δp_P	bar	0.795	0.795	0.795

*) Parallel connection of main and precision motor cooler

Table 6- 37 1FW6190-xxB10-8Fxx, 1FW6190-xxB10-2Pxx

Technical data	Symbol	Unit	-xxB10-8Fxx	-xxB10-2Pxx
1FW6190				
Boundary conditions				
DC link voltage	U_{DC}	V	600	600
Water cooling inlet temperature	T_{VORL}	°C	35	35
Rated temperature of winding	T_N	°C	130	130
Data at the rated operating point				
Rated torque	M_N	Nm	1140	971
Rated current	I_N	A	64.7	85.9
Rated speed	n_N	rpm	246	430
Rated power loss	$P_{V,N}$	kW	6.14	6.02
Limit data				
Maximum torque	M_{MAX}	Nm	1980	1980
Maximum current	I_{MAX}	A	136	214
Electric motor power at M_{MAX}	$P_{EL,MAX}$	kW	48.7	67.7
Maximum speed	n_{MAX}	rpm	739	1160
Maximum speed at maximum torque	$n_{MAX,MMAX}$	rpm	145	238
Max. speed without VPM	$n_{MAX,INV}$	rpm	505	794
No-load speed	$n_{MAX,0}$	rpm	369	581
Torque at $n = 1$ rpm	M_0	Nm	1340	1340
Current at M_0 and $n = 1$ rpm	I_0	A	78.1	123
Thermal static torque	M_0^*	Nm	982	982
Thermal stall current	I_0^*	A	55.3	86.9
Physical constants				
Torque constant at 20 °C	$k_{T,20}$	Nm/A	18	11.5
Voltage constant	k_E	V/(1000/min)	1090	694
Motor constant at 20 °C	$k_{M,20}$	Nm/(W) ^{0.5}	21.5	21.8
Thermal time constant	t_{TH}	s	180	180
No. of pole pairs	p	-	42	42
Cogging torque	M_{COG}	Nm	6.72	6.72
Stator mass	m_S	kg	55.5	55.5
Rotor mass	m_L	kg	20.3	20.3
Rotor moment of inertia	J_L	10 ⁻² kgm ²	67.8	67.8
Phase resistance of winding at 20 °C	$R_{STR,20}$	Ω	0.234	0.0927
Phase inductance of winding	L_{STR}	mH	2.3	0.929
Data for main motor cooler *)				
Maximum dissipated thermal power	$Q_{H,MAX}$	kW	4.61	4.52
Recommended minimum volume flow	$\dot{V}_{H,MIN}$	l/min	6.67	6.67
Cooling medium temperature increase	ΔT_H	K	9.94	9.74
Pressure drop	Δp_H	bar	0.795	0.795

Technical data	Symbol	Unit	-xxB10-8Fxx	-xxB10-2Pxx
1FW6190				
Data for precision motor cooler *)				
Maximum dissipated thermal power	$Q_{P,MAX}$	kW	0.498	0.487
Recommended minimum volume flow	$\dot{V}_{P,MIN}$	l/min	2.33	2.33
Cooling medium temperature increase	ΔT_P	K	3.08	3.01
Pressure drop	Δp_P	bar	0.795	0.795

*) Parallel connection of main and precision motor cooler

Characteristics for 1FW6190-xxB10-xxxx

Torque M with respect to speed n

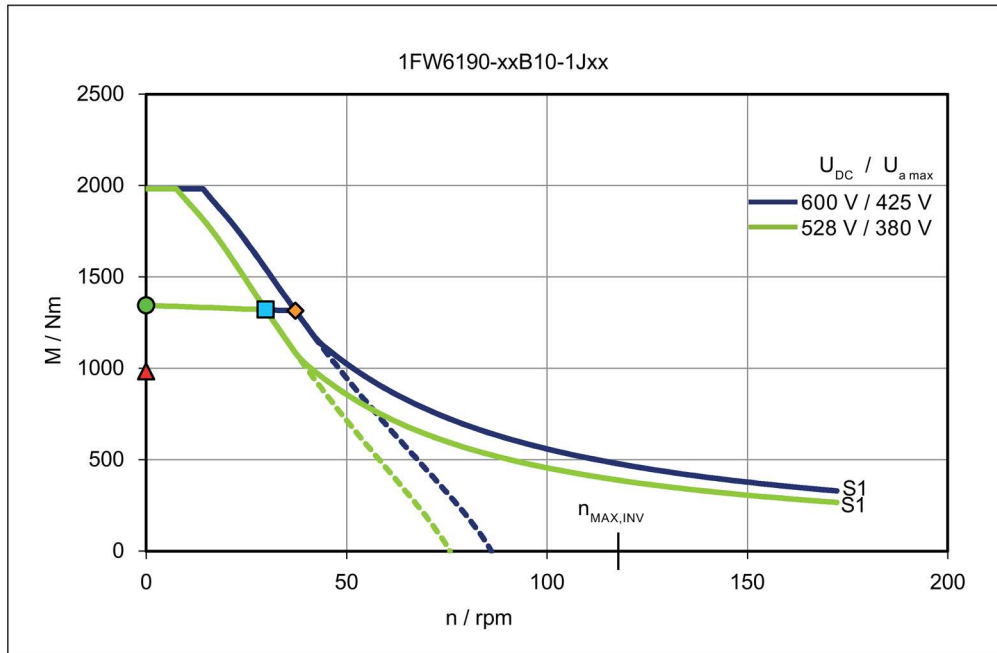

Torque M with respect to speed n

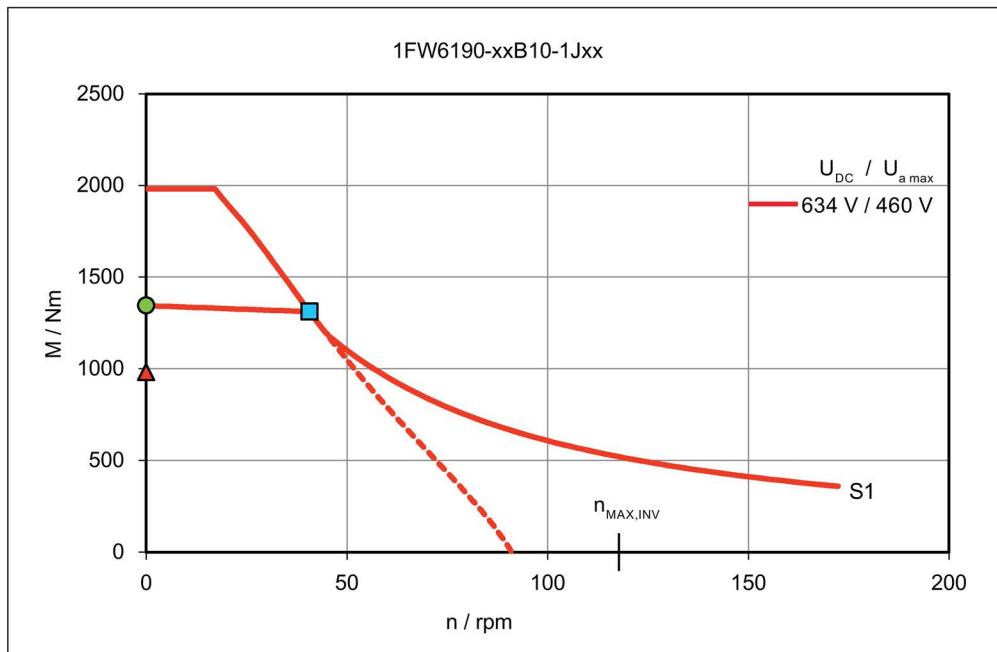

Torque M with respect to speed n

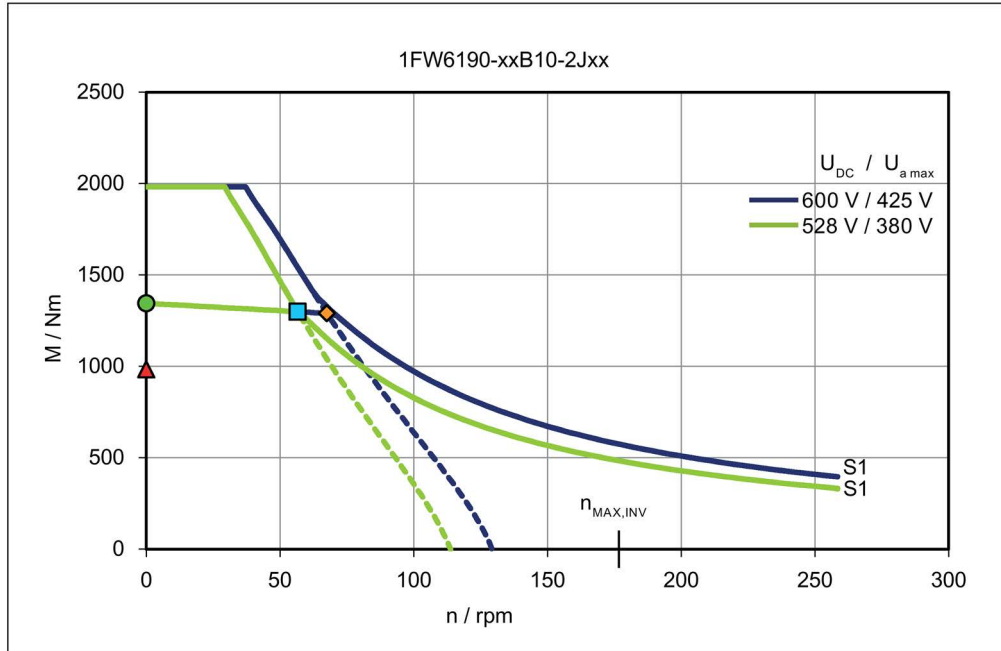

Torque M with respect to speed n

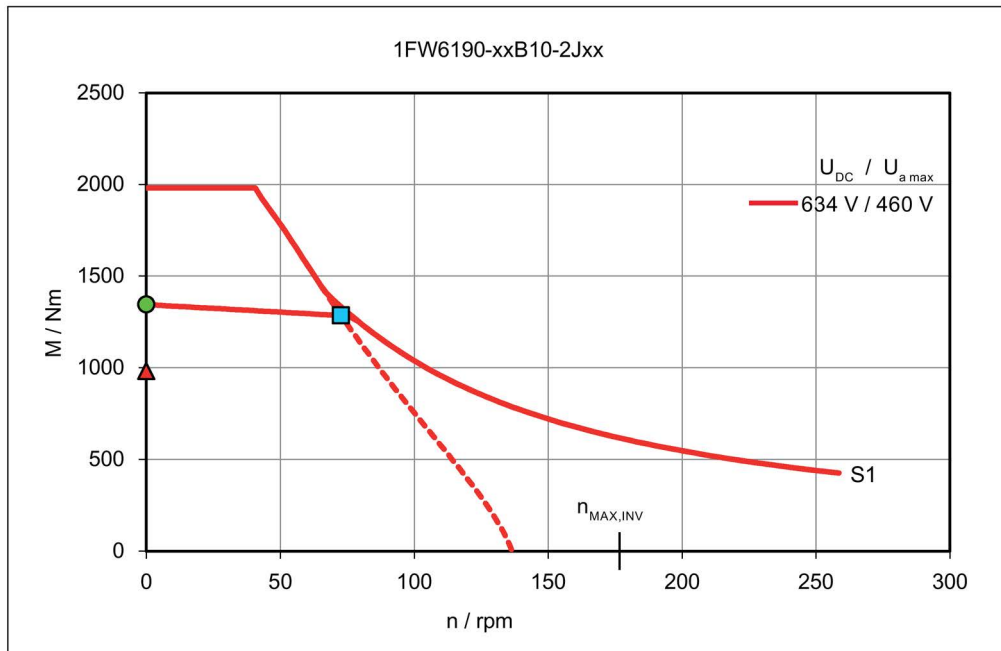

Torque M with respect to speed n

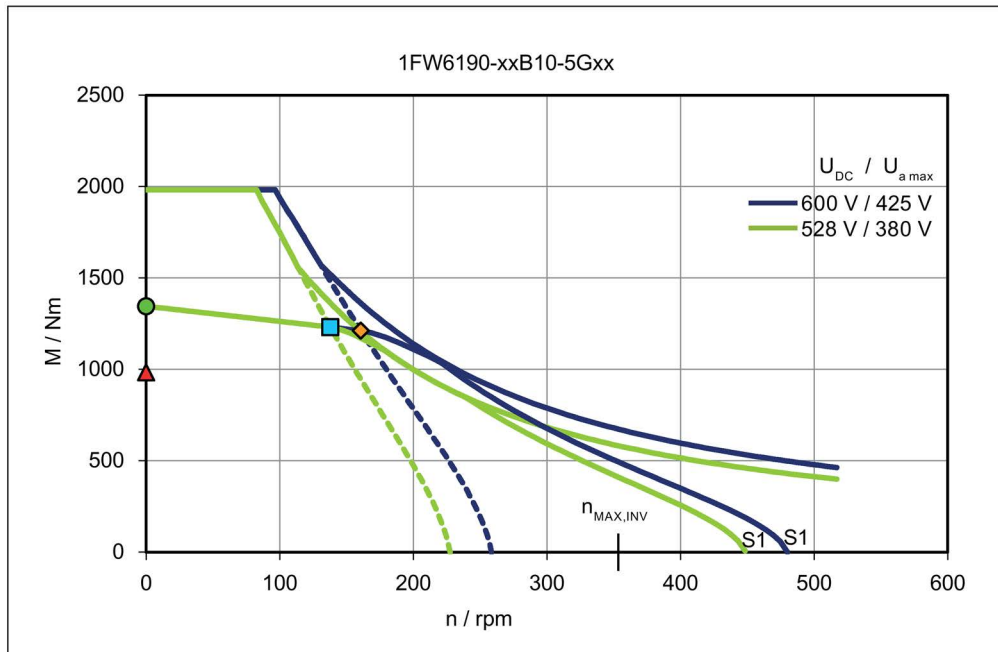

Torque M with respect to speed n

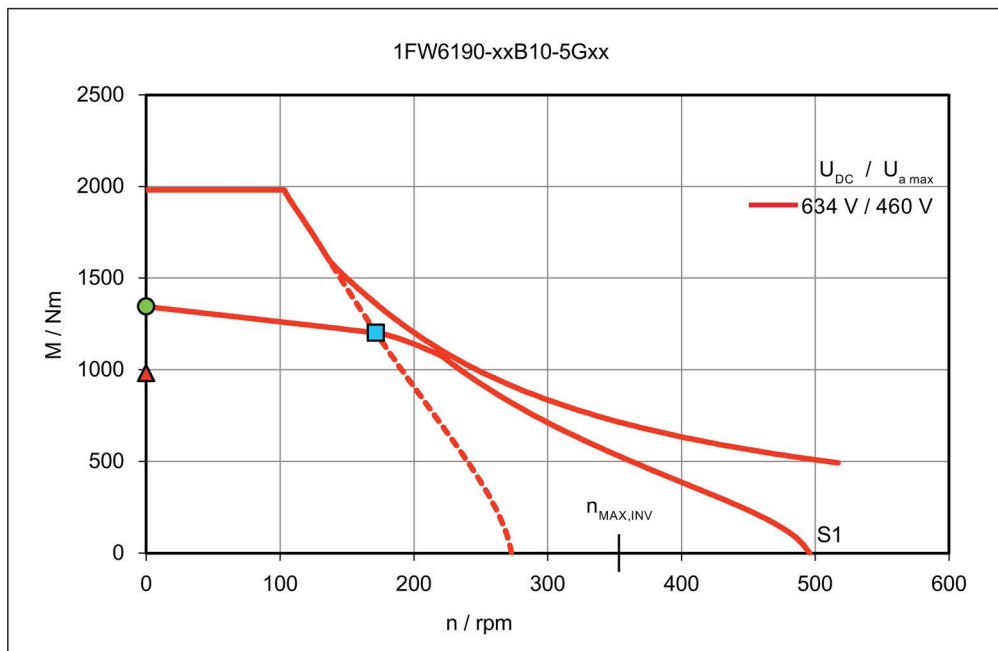

Torque M with respect to speed n

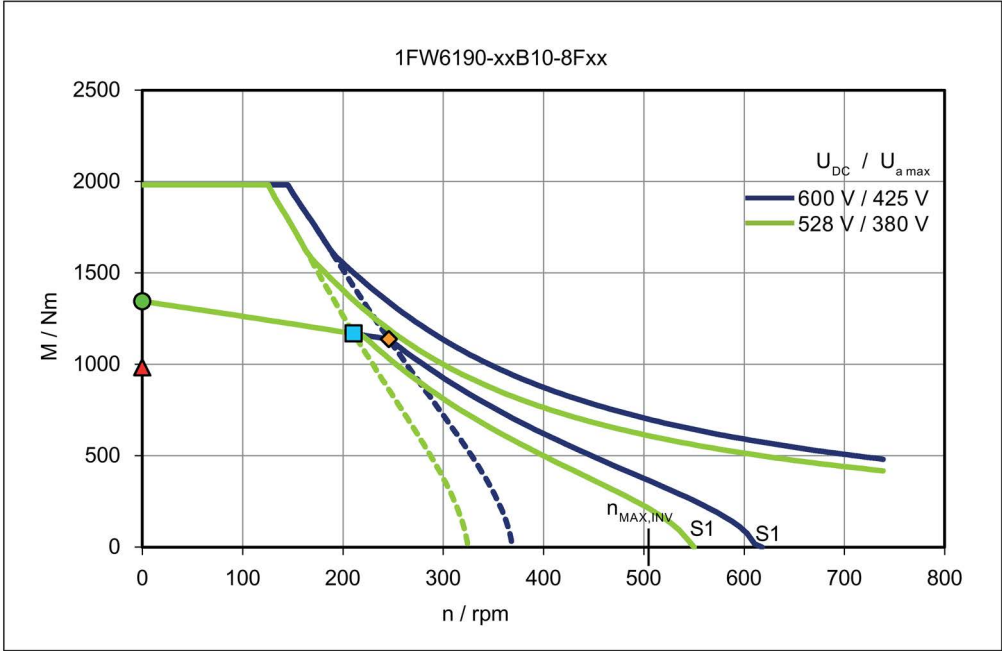

Torque M with respect to speed n

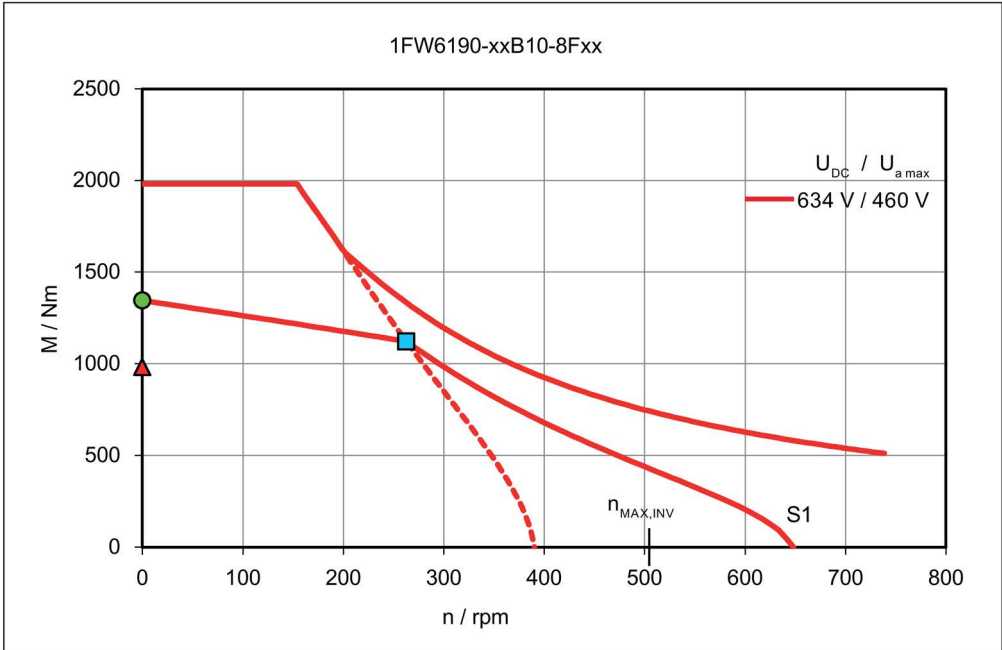

Torque M with respect to speed n

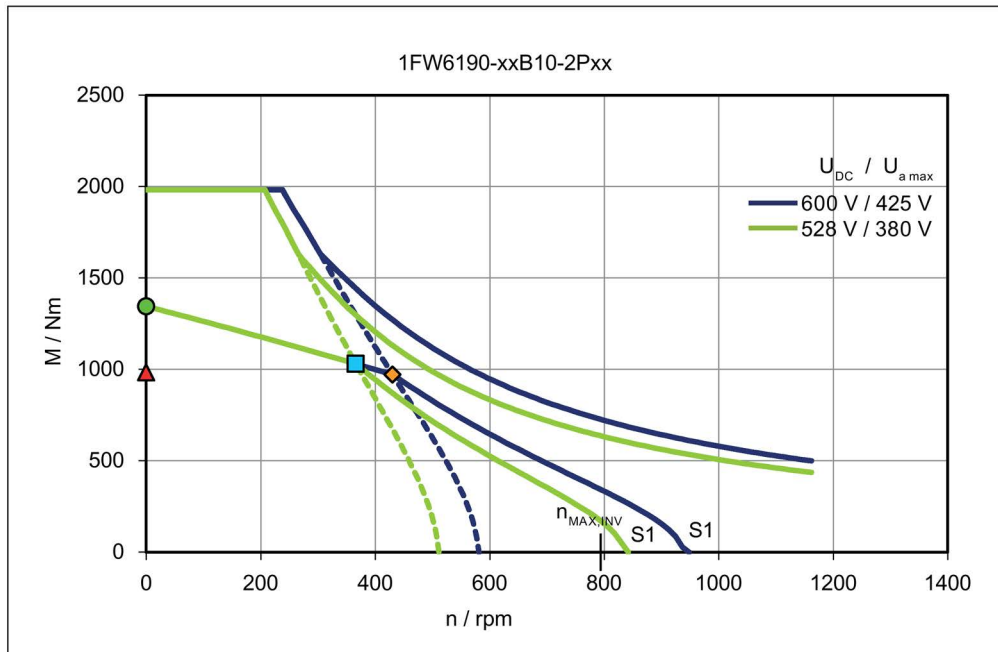

Torque M with respect to speed n

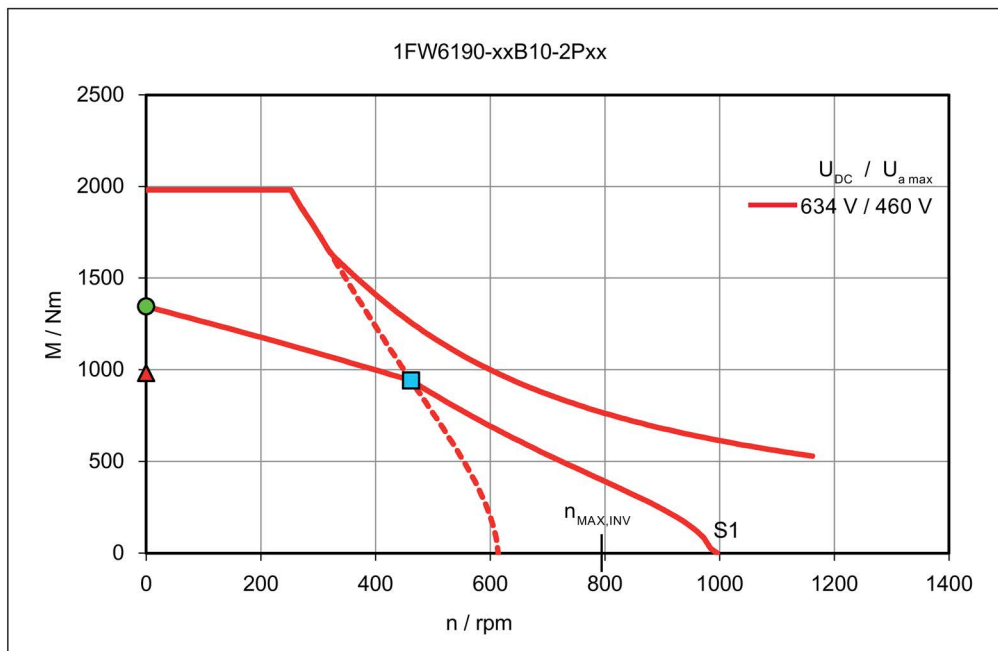

Short-circuit braking torque M_{Br} with respect to speed n

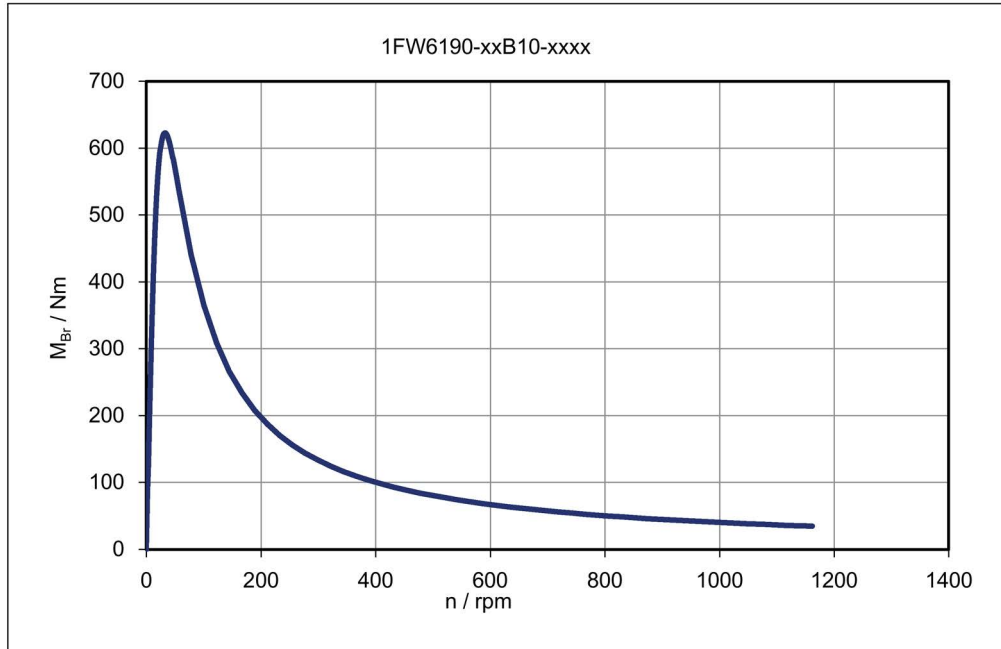

Main cooler and precision cooler - pressure losses Δp with respect to the flow rate \dot{V} (HK || PK: main cooler HK and precision cooler PK connected in parallel)

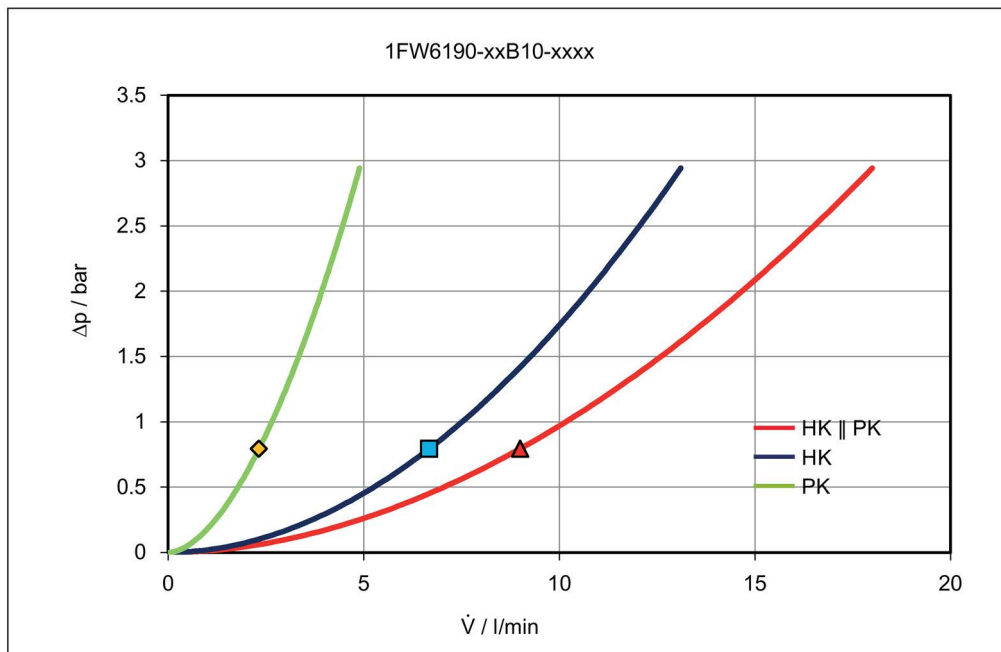

Rotor power loss P_{LV} with respect to speed n

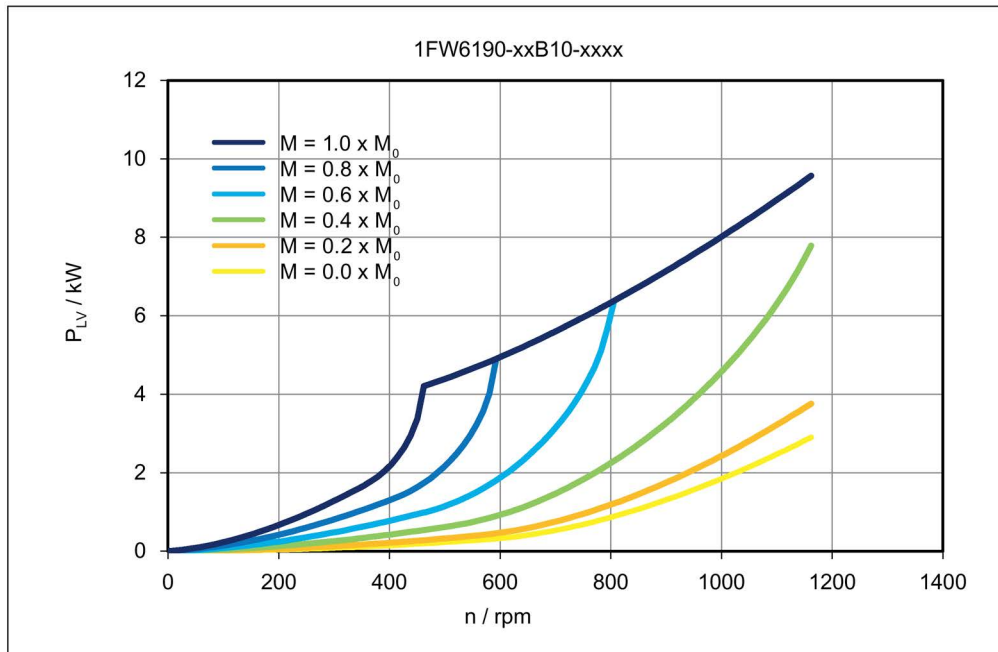

Data sheet 1FW6190-xxB15-xxxx

Table 6- 38 1FW6190-xxB15-2Jxx, 1FW6190-xxB15-5Gxx, 1FW6190-xxB15-8Fxx

Technical data	Symbol	Unit	-xxB15-2Jxx	-xxB15-5Gxx	-xxB15-8Fxx
1FW6190					
Boundary conditions					
DC link voltage	U_{DC}	V	600	600	600
Water cooling inlet temperature	T_{VORL}	°C	35	35	35
Rated temperature of winding	T_N	°C	130	130	130
Data at the rated operating point					
Rated torque	M_N	Nm	1970	1890	1830
Rated current	I_N	A	26.6	50.9	69.8
Rated speed	n_N	rpm	39	99.8	153
Rated power loss	$P_{V,N}$	kW	8.28	8.28	8.53
Limit data					
Maximum torque	M_{MAX}	Nm	2970	2970	2970
Maximum current	I_{MAX}	A	47.7	95.3	136
Electric motor power at M_{MAX}	$P_{EL,MAX}$	kW	30.4	43.6	54.6
Maximum speed	n_{MAX}	rpm	172	345	492
Maximum speed at maximum torque	$n_{MAX,MMAX}$	rpm	16.9	59.4	92.3
Max. speed without VPM	$n_{MAX,INV}$	rpm	118	236	337
No-load speed	$n_{MAX,0}$	rpm	86.2	172	246
Torque at $n = 1$ rpm	M_0	Nm	2020	2020	2020
Current at M_0 and $n = 1$ rpm	I_0	A	27.3	54.7	78.1
Thermal static torque	M_0^*	Nm	1470	1470	1470
Thermal stall current	I_0^*	A	19.3	38.7	55.3
Physical constants					
Torque constant at 20 °C	$k_{T,20}$	Nm/A	77.3	38.7	27.1
Voltage constant	k_E	V/(1000/min)	4680	2340	1640
Motor constant at 20 °C	$k_{M,20}$	Nm/(W) ^{0.5}	27.8	27.8	27.4
Thermal time constant	t_{TH}	s	180	180	180
No. of pole pairs	p	-	42	42	42
Cogging torque	M_{COG}	Nm	10.1	10.1	10.1
Stator mass	m_s	kg	77.8	77.8	77.8
Rotor mass	m_L	kg	30	30	30
Rotor moment of inertia	J_L	10 ⁻² kgm ²	99.8	99.8	99.8
Phase resistance of winding at 20 °C	$R_{STR, 20}$	Ω	2.58	0.644	0.325
Phase inductance of winding	L_{STR}	mH	28	6.99	3.43

Technical data	Symbol	Unit	-xxB15-2Jxx	-xxB15-5Gxx	-xxB15-8Fxx
1FW6190					
Data for main motor cooler *)					
Maximum dissipated thermal power	$Q_{H,MAX}$	kW	6.22	6.22	6.41
Recommended minimum volume flow	$\dot{V}_{H,MIN}$	l/min	8.85	8.85	8.85
Cooling medium temperature increase	ΔT_H	K	10.1	10.1	10.4
Pressure drop	Δp_H	bar	1.37	1.37	1.37
Data for precision motor cooler *)					
Maximum dissipated thermal power	$Q_{P,MAX}$	kW	0.671	0.671	0.691
Recommended minimum volume flow	$\dot{V}_{P,MIN}$	l/min	3.17	3.17	3.17
Cooling medium temperature increase	ΔT_P	K	3.04	3.04	3.13
Pressure drop	Δp_P	bar	1.37	1.37	1.37

*) Parallel connection of main and precision motor cooler

Table 6- 39 1FW6190-xxB15-2Pxx, 1FW6190-xxB15-0Wxx

Technical data	Symbol	Unit	-xxB15-2Pxx	-xxB15-0Wxx
1FW6190				
Boundary conditions				
DC link voltage	U_{DC}	V	600	600
Water cooling inlet temperature	T_{VORL}	°C	35	35
Rated temperature of winding	T_N	°C	130	130
Data at the rated operating point				
Rated torque	M_N	Nm	1680	1560
Rated current	I_N	A	100	118
Rated speed	n_N	rpm	263	352
Rated power loss	$P_{V,N}$	kW	8.36	8.53
Limit data				
Maximum torque	M_{MAX}	Nm	2970	2970
Maximum current	I_{MAX}	A	214	272
Electric motor power at M_{MAX}	$P_{EL,MAX}$	kW	73.7	88.5
Maximum speed	n_{MAX}	rpm	775	985
Maximum speed at maximum torque	$n_{MAX,MMAX}$	rpm	155	201
Max. speed without VPM	$n_{MAX,INV}$	rpm	529	673
No-load speed	$n_{MAX,0}$	rpm	387	492
Torque at $n = 1$ rpm	M_0	Nm	2020	2020
Current at M_0 and $n = 1$ rpm	I_0	A	123	156
Thermal static torque	M_0^*	Nm	1470	1470
Thermal stall current	I_0^*	A	86.9	111
Physical constants				
Torque constant at 20 °C	$k_{T,20}$	Nm/A	17.2	13.5
Voltage constant	k_E	V/(1000/min)	1040	818
Motor constant at 20 °C	$k_{M,20}$	Nm/(W) ^{0.5}	27.7	27.4
Thermal time constant	t_{TH}	s	180	180
No. of pole pairs	p	-	42	42
Cogging torque	M_{COG}	Nm	10.1	10.1
Stator mass	m_s	kg	77.8	77.8
Rotor mass	m_L	kg	30	30
Rotor moment of inertia	J_L	10 ⁻² kgm ²	99.8	99.8
Phase resistance of winding at 20 °C	$R_{STR, 20}$	Ω	0.129	0.0813
Phase inductance of winding	L_{STR}	mH	1.38	0.856
Data for main motor cooler *)				
Maximum dissipated thermal power	$Q_{H,MAX}$	kW	6.28	6.41
Recommended minimum volume flow	$\dot{V}_{H,MIN}$	l/min	8.85	8.85
Cooling medium temperature increase	ΔT_H	K	10.2	10.4
Pressure drop	Δp_H	bar	1.37	1.37

Technical data	Symbol	Unit	-xxB15-2Pxx	-xxB15-0Wxx
1FW6190				
Data for precision motor cooler *)				
Maximum dissipated thermal power	$Q_{P,MAX}$	kW	0.677	0.691
Recommended minimum volume flow	$\dot{V}_{P,MIN}$	l/min	3.17	3.17
Cooling medium temperature increase	ΔT_P	K	3.07	3.13
Pressure drop	Δp_P	bar	1.37	1.37

*) Parallel connection of main and precision motor cooler

Characteristics for 1FW6190-xxB15-xxxx

Torque M with respect to speed n

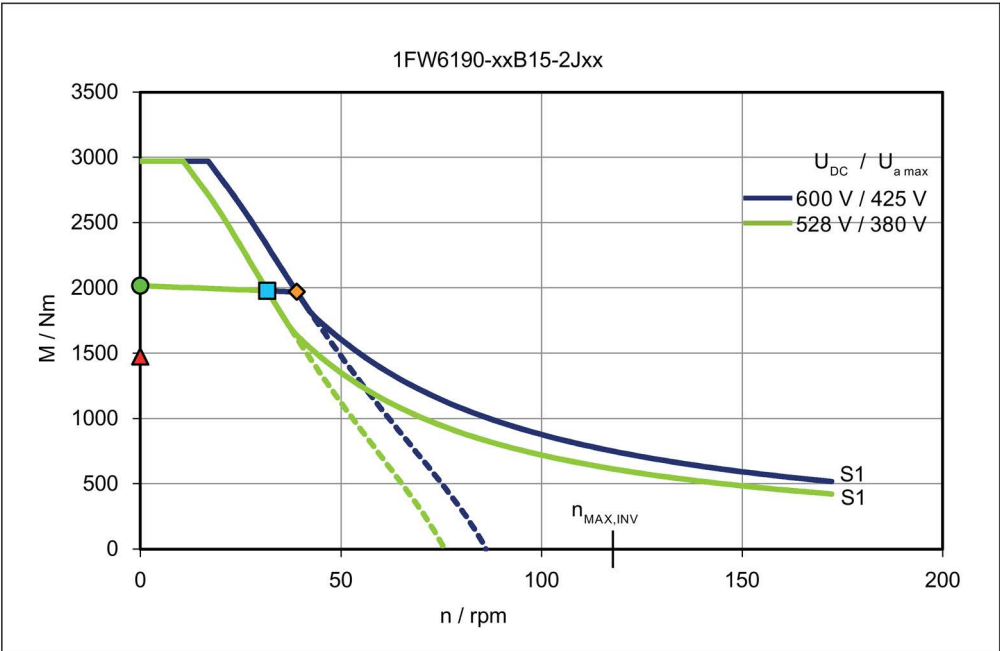

Torque M with respect to speed n

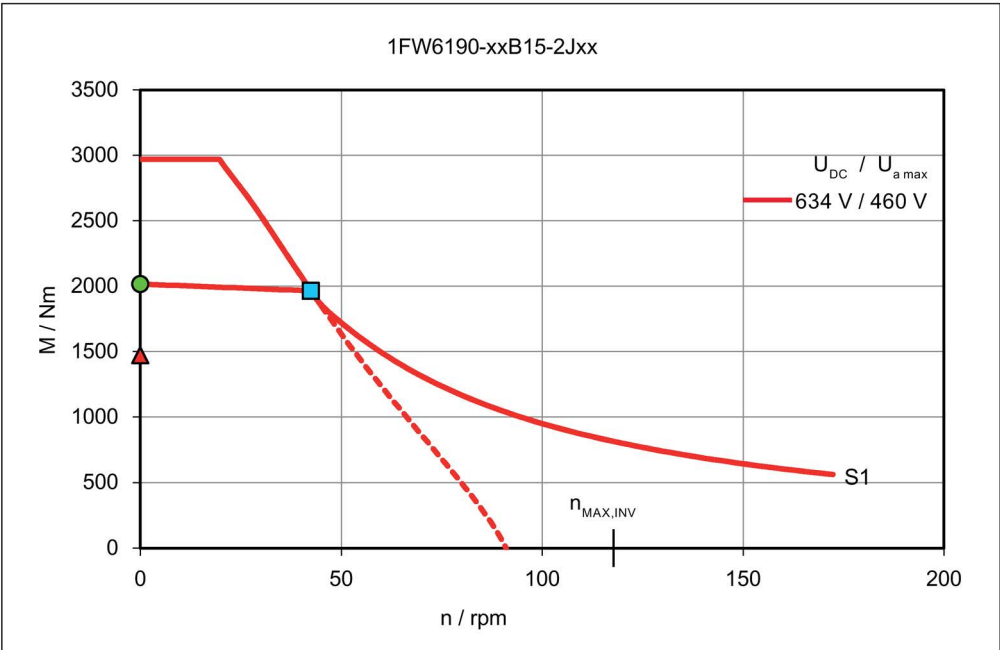

Torque M with respect to speed n

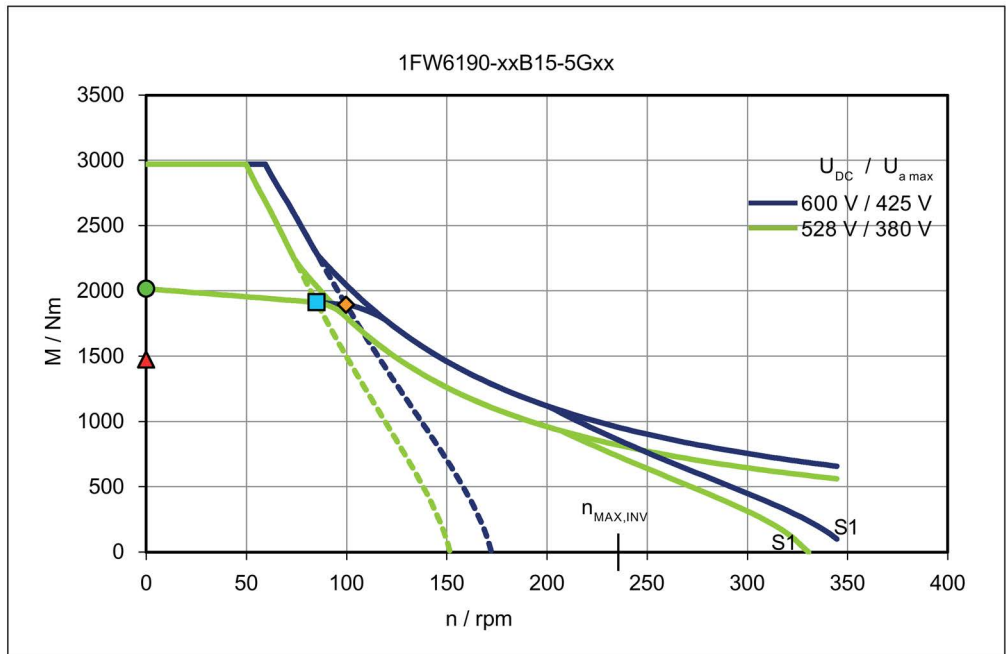

Torque M with respect to speed n

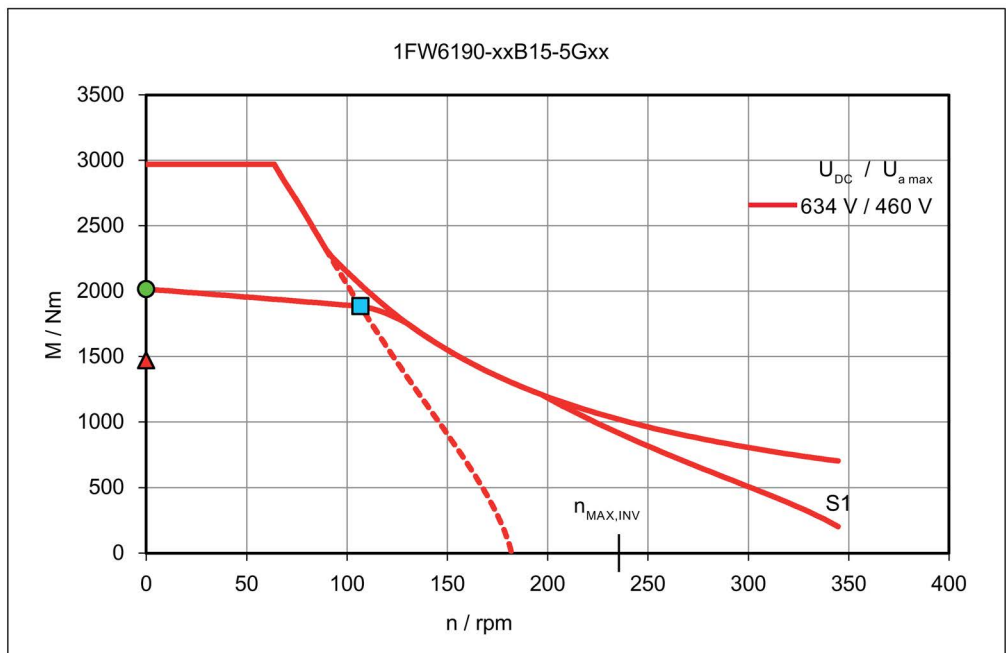

Torque M with respect to speed n

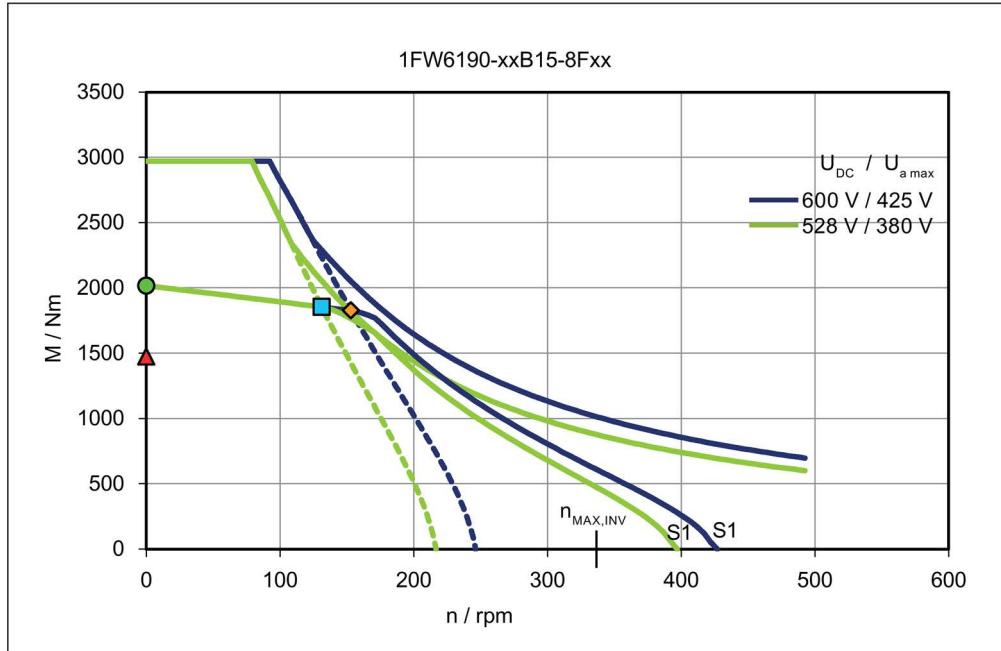

Torque M with respect to speed n

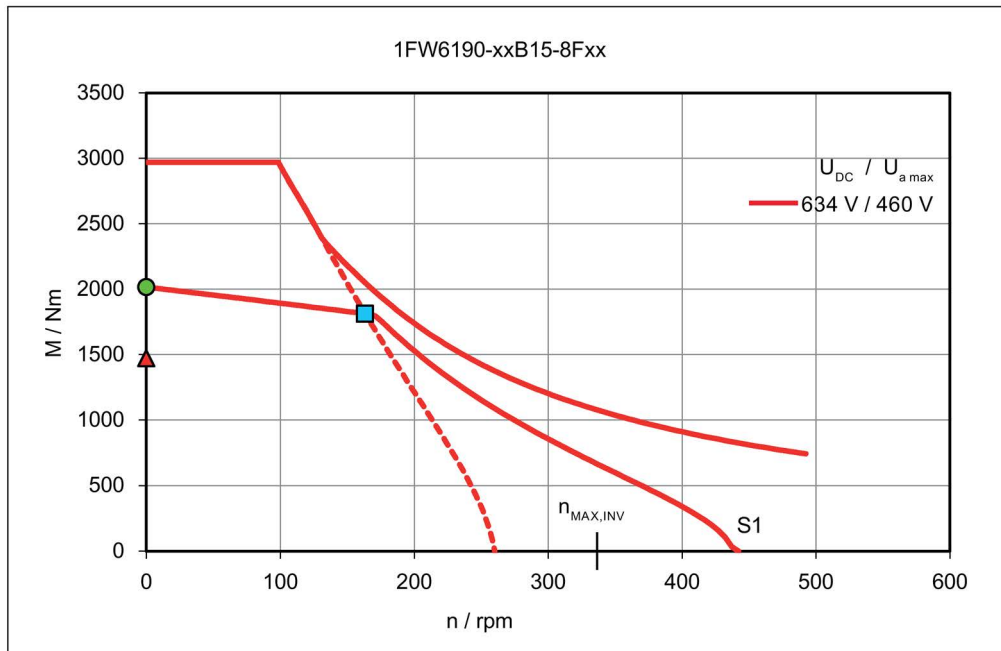

Torque M with respect to speed n

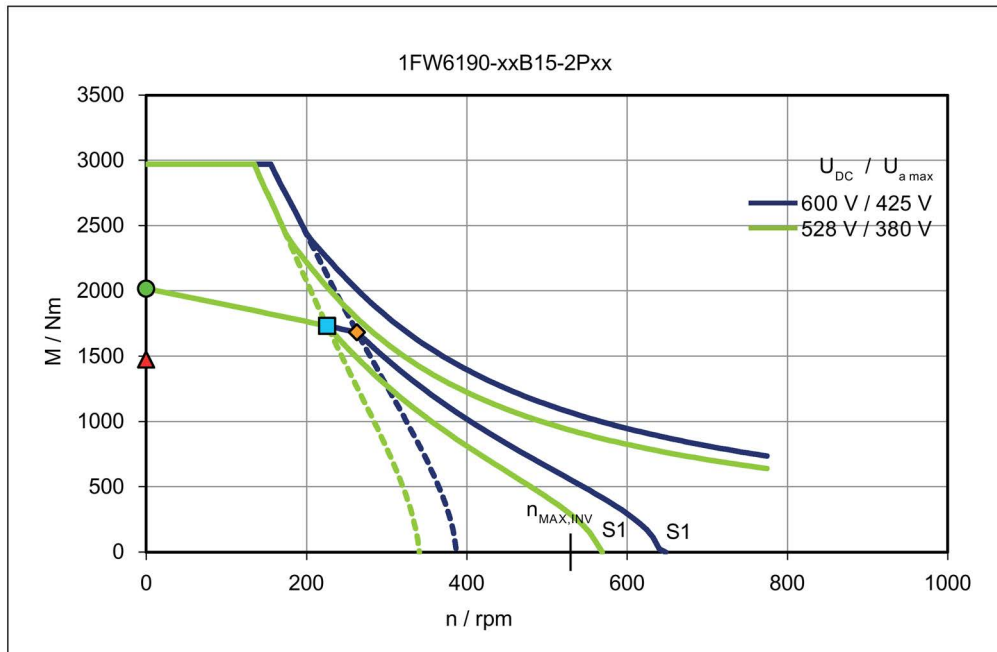

Torque M with respect to speed n

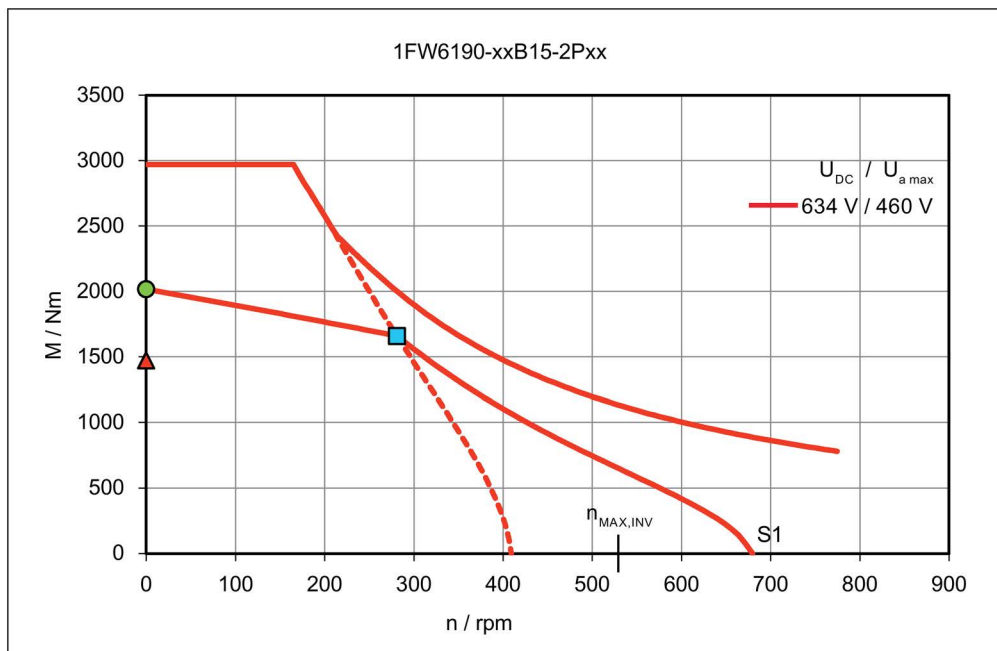

Torque M with respect to speed n

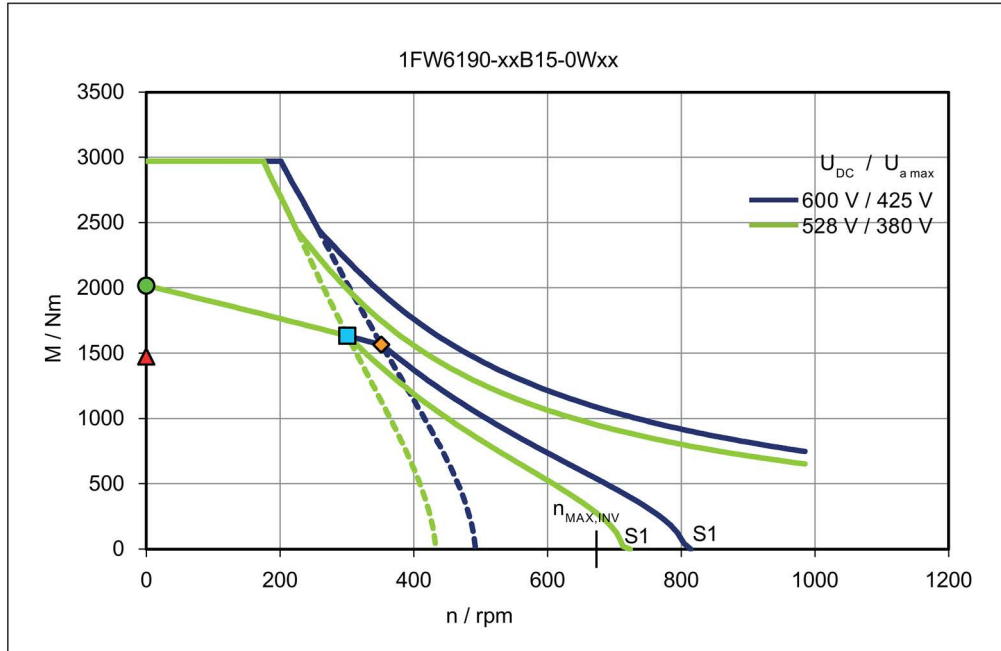

Torque M with respect to speed n

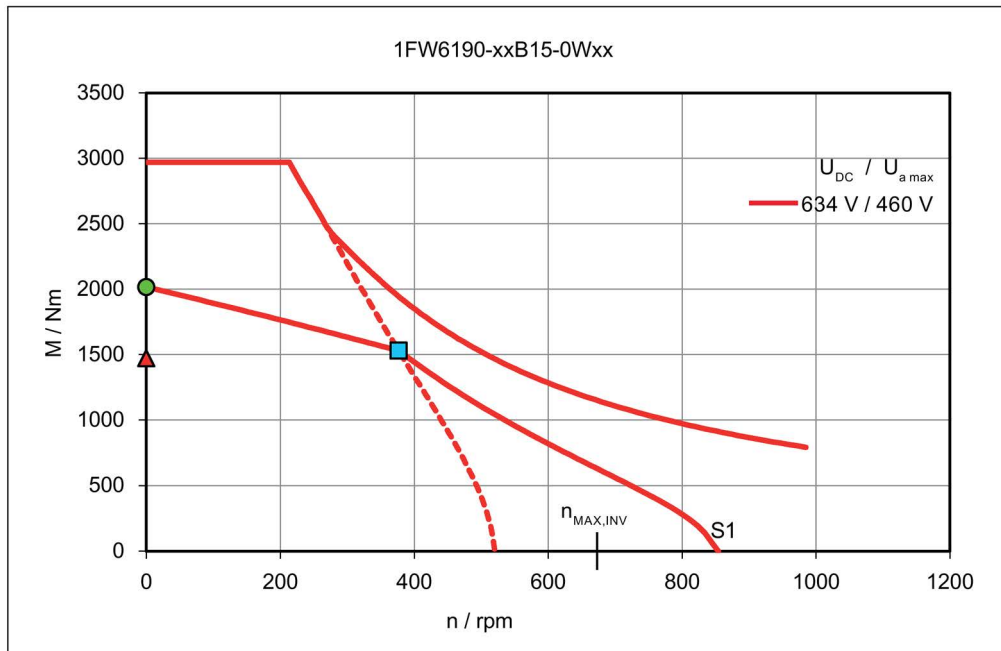

Short-circuit braking torque M_{Br} with respect to speed n

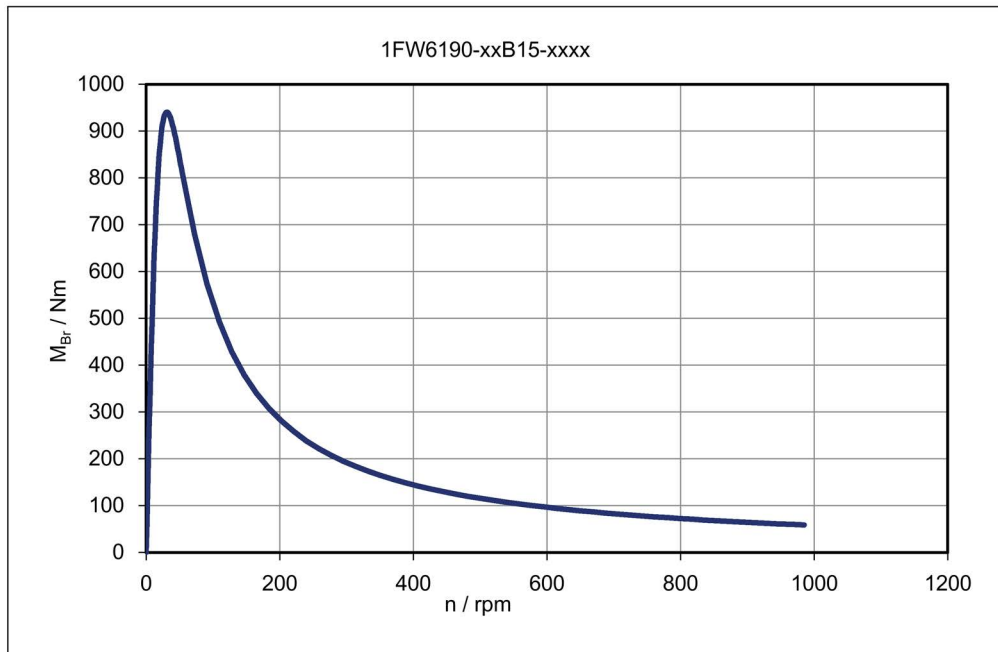

Main cooler and precision cooler - pressure losses Δp with respect to the flow rate \dot{V} (HK || PK: main cooler HK and precision cooler PK connected in parallel)

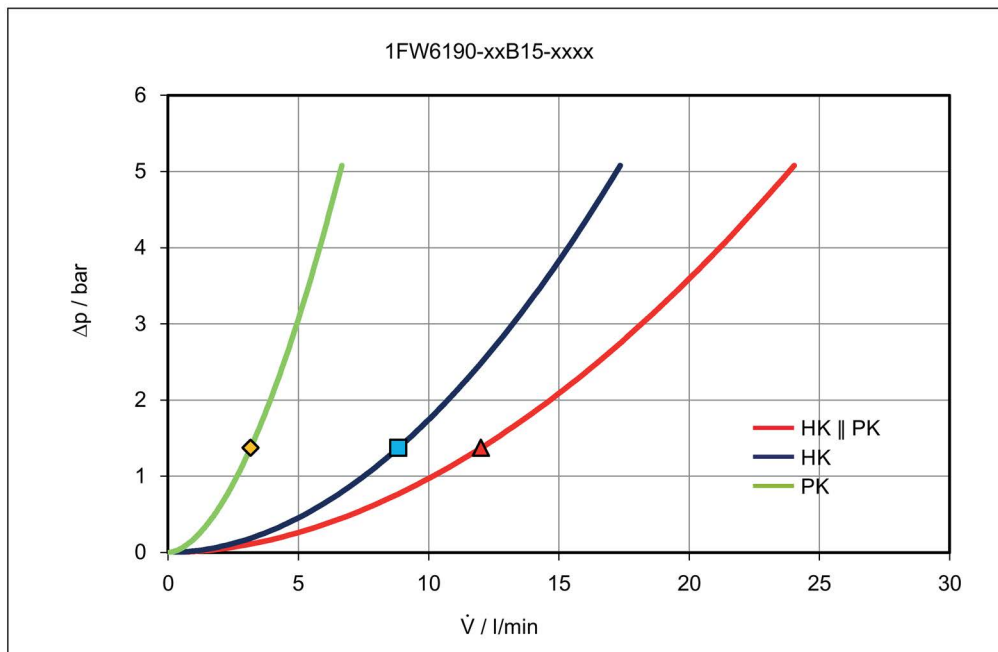

Rotor power loss P_{LV} with respect to speed n

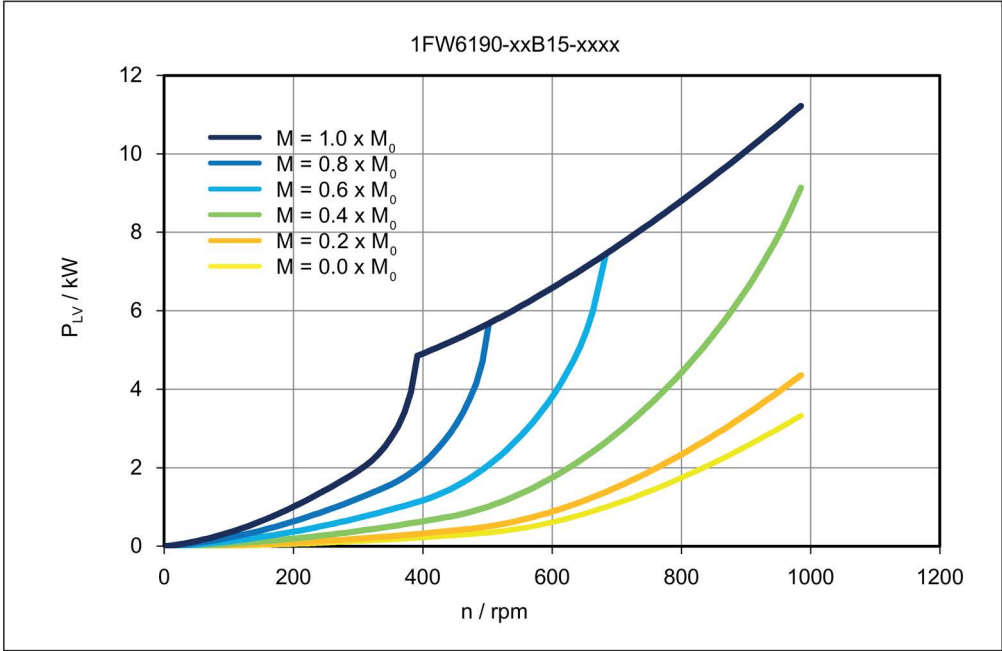

Data sheet 1FW6190-xxB20-xxxx

Table 6- 40 1FW6190-xxB20-5Gxx, 1FW6190-xxB20-8Fxx, 1FW6190-xxB20-2Pxx

Technical data	Symbol	Unit	-xxB20-5Gxx	-xxB20-8Fxx	-xxB20-2Pxx
1FW6190					
Boundary conditions					
DC link voltage	U_{DC}	V	600	600	600
Water cooling inlet temperature	T_{VORL}	°C	35	35	35
Rated temperature of winding	T_N	°C	130	130	130
Data at the rated operating point					
Rated torque	M_N	Nm	2580	2510	2380
Rated current	I_N	A	52	72.2	107
Rated speed	n_N	rpm	70.1	109	188
Rated power loss	$P_{V,N}$	kW	10.6	10.9	10.7
Limit data					
Maximum torque	M_{MAX}	Nm	3960	3960	3960
Maximum current	I_{MAX}	A	95.3	136	214
Electric motor power at M_{MAX}	$P_{EL,MAX}$	kW	48.8	60.3	79.5
Maximum speed	n_{MAX}	rpm	259	369	581
Maximum speed at maximum torque	$n_{MAX,MMAX}$	rpm	40.1	65.4	113
Max. speed without VPM	$n_{MAX,INV}$	rpm	177	252	397
No-load speed	$n_{MAX,0}$	rpm	129	185	291
Torque at $n = 1$ rpm	M_0	Nm	2690	2690	2690
Current at M_0 and $n = 1$ rpm	I_0	A	54.7	78.1	123
Thermal static torque	M_0^*	Nm	1960	1960	1960
Thermal stall current	I_0^*	A	38.7	55.3	86.9
Physical constants					
Torque constant at 20 °C	$k_{T,20}$	Nm/A	51.6	36.1	22.9
Voltage constant	k_E	V/(1000/min)	3120	2180	1390
Motor constant at 20 °C	$k_{M,20}$	Nm/(W) ^{0.5}	32.8	32.3	32.6
Thermal time constant	t_{TH}	s	180	180	180
No. of pole pairs	p	-	42	42	42
Cogging torque	M_{COG}	Nm	13.4	13.4	13.4
Stator mass	m_S	kg	96.6	96.6	96.6
Rotor mass	m_L	kg	39.6	39.6	39.6
Rotor moment of inertia	J_L	10 ⁻² kgm ²	132	132	132
Phase resistance of winding at 20 °C	$R_{STR,20}$	Ω	0.825	0.416	0.165
Phase inductance of winding	L_{STR}	mH	9.29	4.55	1.84

Technical data	Symbol	Unit	-xxB20-5Gxx	-xxB20-8Fxx	-xxB20-2Pxx
1FW6190					
Data for main motor cooler *)					
Maximum dissipated thermal power	$Q_{H,MAX}$	kW	7.96	8.21	8.04
Recommended minimum volume flow	$\dot{V}_{H,MIN}$	l/min	12.8	12.8	12.8
Cooling medium temperature increase	ΔT_H	K	8.98	9.26	9.07
Pressure drop	Δp_H	bar	2.79	2.79	2.79
Data for precision motor cooler *)					
Maximum dissipated thermal power	$Q_{P,MAX}$	kW	0.859	0.885	0.867
Recommended minimum volume flow	$\dot{V}_{P,MIN}$	l/min	4.75	4.75	4.75
Cooling medium temperature increase	ΔT_P	K	2.6	2.68	2.63
Pressure drop	Δp_P	bar	2.79	2.79	2.79

*) Parallel connection of main and precision motor cooler

Table 6- 41 1FW6190-xxB20-0Wxx

Technical data	Symbol	Unit	-xxB20-0Wxx
1FW6190			
Boundary conditions			
DC link voltage	U_{DC}	V	600
Water cooling inlet temperature	T_{VORL}	°C	35
Rated temperature of winding	T_N	°C	130
Data at the rated operating point			
Rated torque	M_N	Nm	2270
Rated current	I_N	A	129
Rated speed	n_N	rpm	249
Rated power loss	$P_{V,N}$	kW	10.9
Limit data			
Maximum torque	M_{MAX}	Nm	3960
Maximum current	I_{MAX}	A	272
Electric motor power at M_{MAX}	$P_{EL,MAX}$	kW	94.6
Maximum speed	n_{MAX}	rpm	739
Maximum speed at maximum torque	$n_{MAX,MMAX}$	rpm	148
Max. speed without VPM	$n_{MAX,INV}$	rpm	505
No-load speed	$n_{MAX,0}$	rpm	369
Torque at $n = 1$ rpm	M_0	Nm	2690
Current at M_0 and $n = 1$ rpm	I_0	A	156
Thermal static torque	M_0^*	Nm	1960
Thermal stall current	I_0^*	A	111
Physical constants			
Torque constant at 20 °C	$k_{T,20}$	Nm/A	18
Voltage constant	k_E	V/(1000/min)	1090
Motor constant at 20 °C	$k_{M,20}$	Nm/(W) ^{0.5}	32.3
Thermal time constant	t_{TH}	s	180
No. of pole pairs	p	-	42
Cogging torque	M_{COG}	Nm	13.4
Stator mass	m_S	kg	96.6
Rotor mass	m_L	kg	39.6
Rotor moment of inertia	J_L	10 ⁻² kgm ²	132
Phase resistance of winding at 20 °C	$R_{STR,20}$	Ω	0.104
Phase inductance of winding	L_{STR}	mH	1.14
Data for main motor cooler *)			
Maximum dissipated thermal power	$Q_{H,MAX}$	kW	8.21
Recommended minimum volume flow	$\dot{V}_{H,MIN}$	l/min	12.8
Cooling medium temperature increase	ΔT_H	K	9.26
Pressure drop	Δp_H	bar	2.79

Technical data	Symbol	Unit	-xxB20-0Wxx
1FW6190			
Data for precision motor cooler *)			
Maximum dissipated thermal power	$Q_{P,MAX}$	kW	0.885
Recommended minimum volume flow	$\dot{V}_{P,MIN}$	l/min	4.75
Cooling medium temperature increase	ΔT_P	K	2.68
Pressure drop	Δp_P	bar	2.79

*) Parallel connection of main and precision motor cooler

Characteristics for 1FW6190-xxB20-xxxx

Torque M with respect to speed n

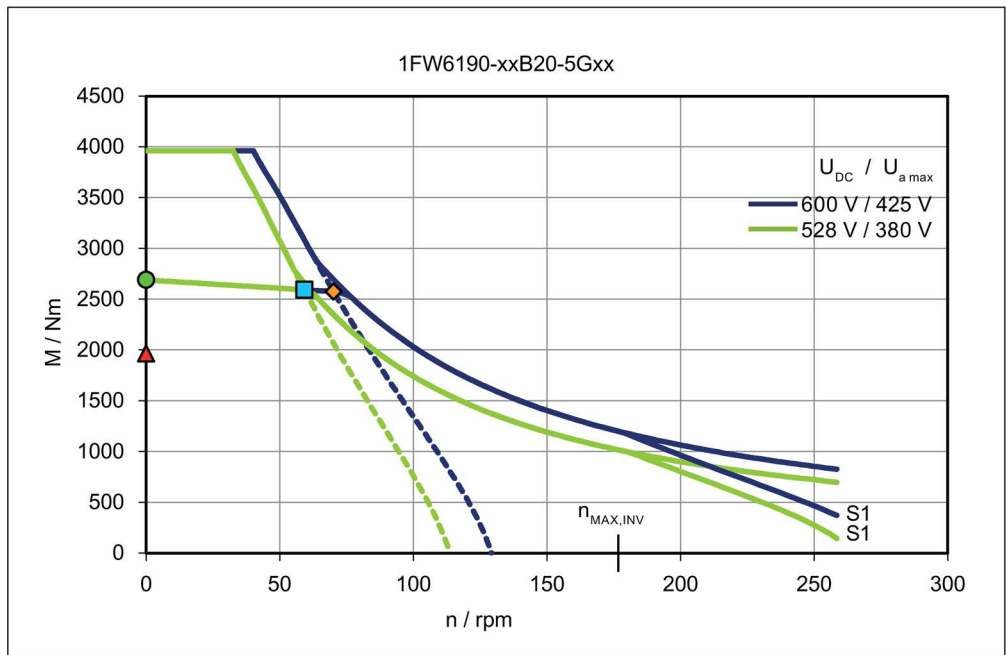

Torque M with respect to speed n

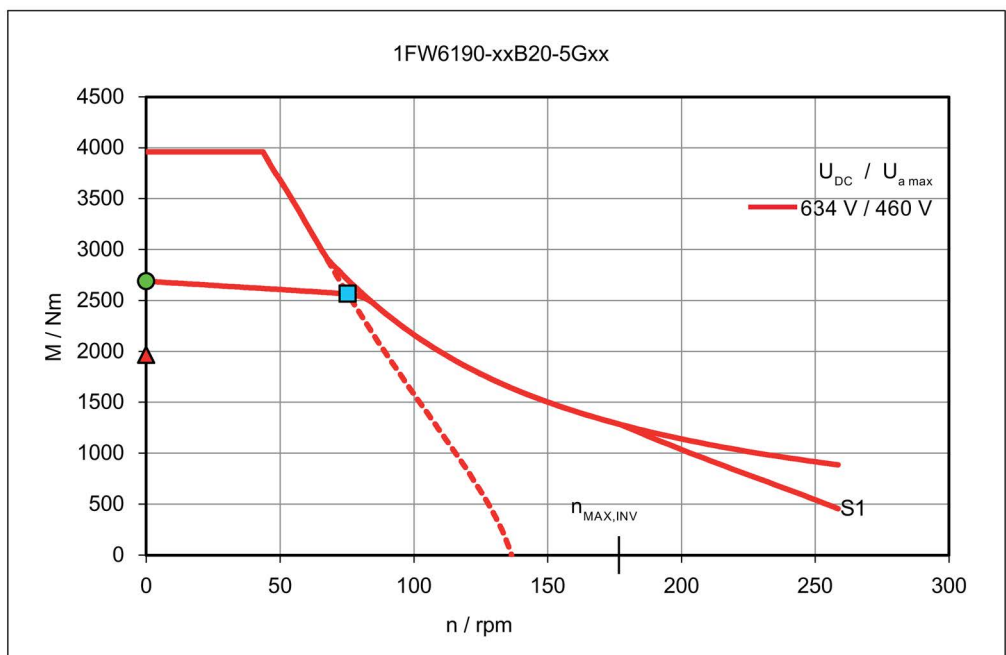

Torque M with respect to speed n

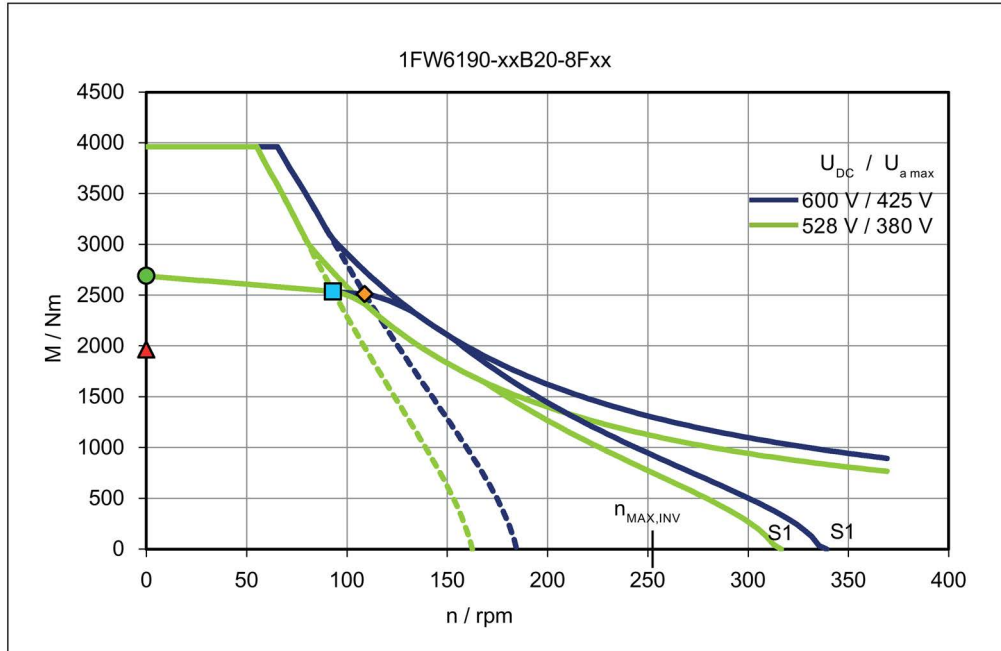

Torque M with respect to speed n

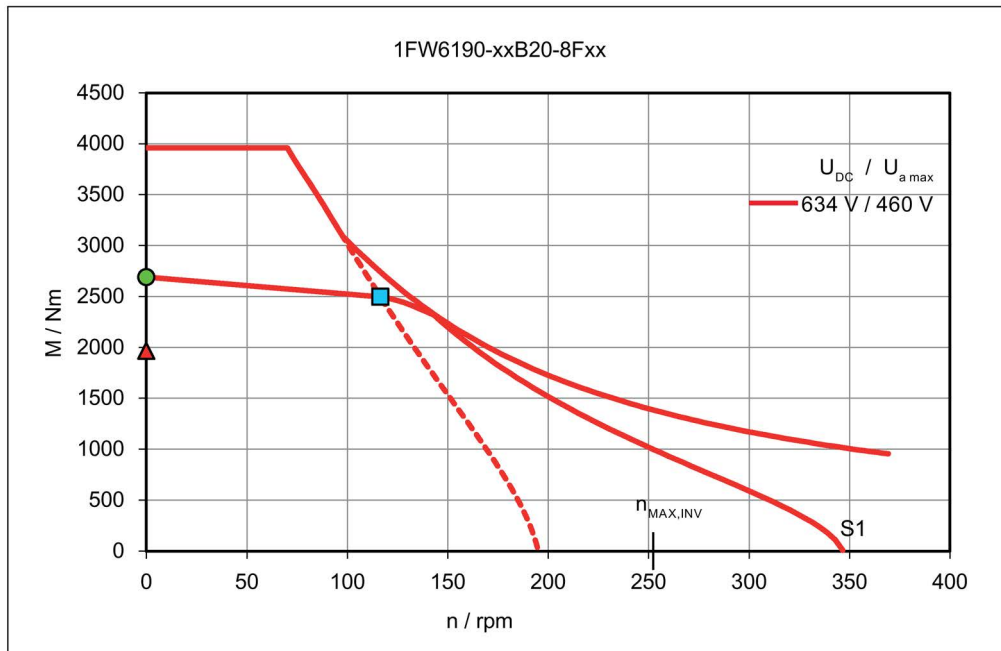

Torque M with respect to speed n

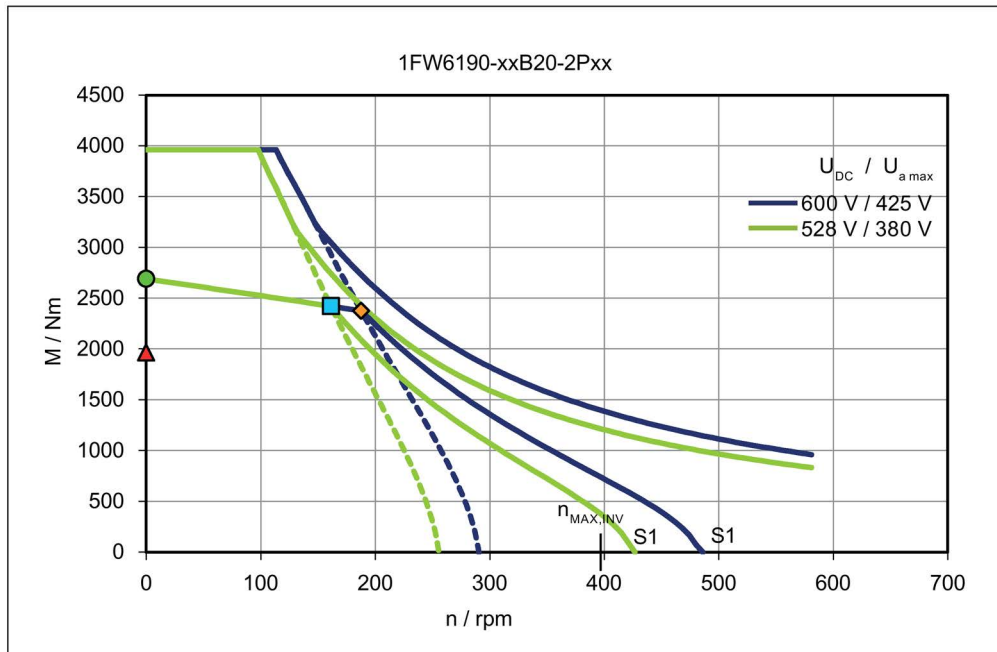

Torque M with respect to speed n

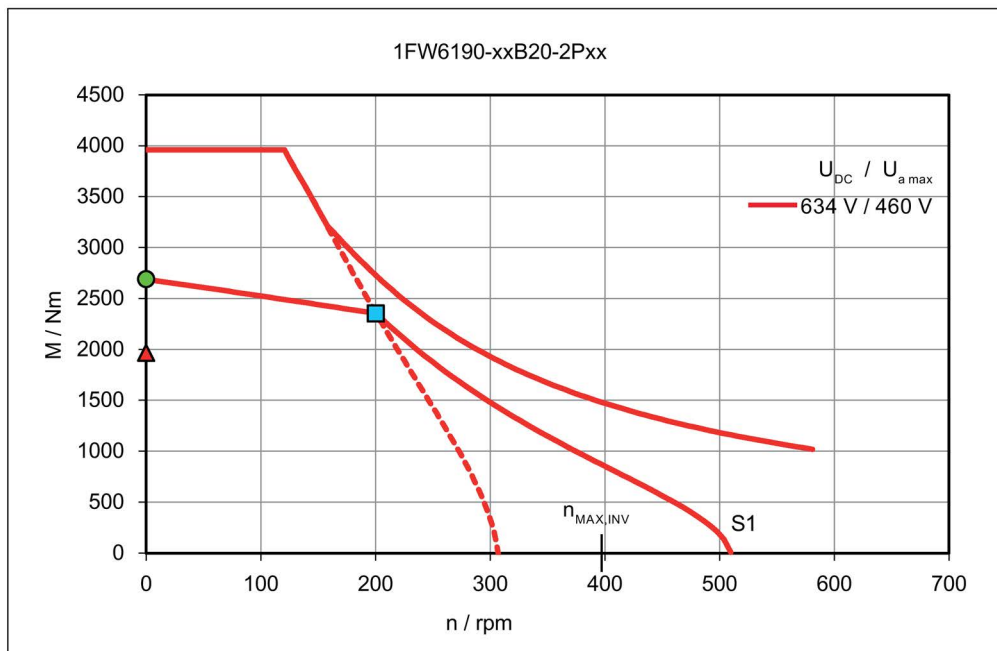

Torque M with respect to speed n

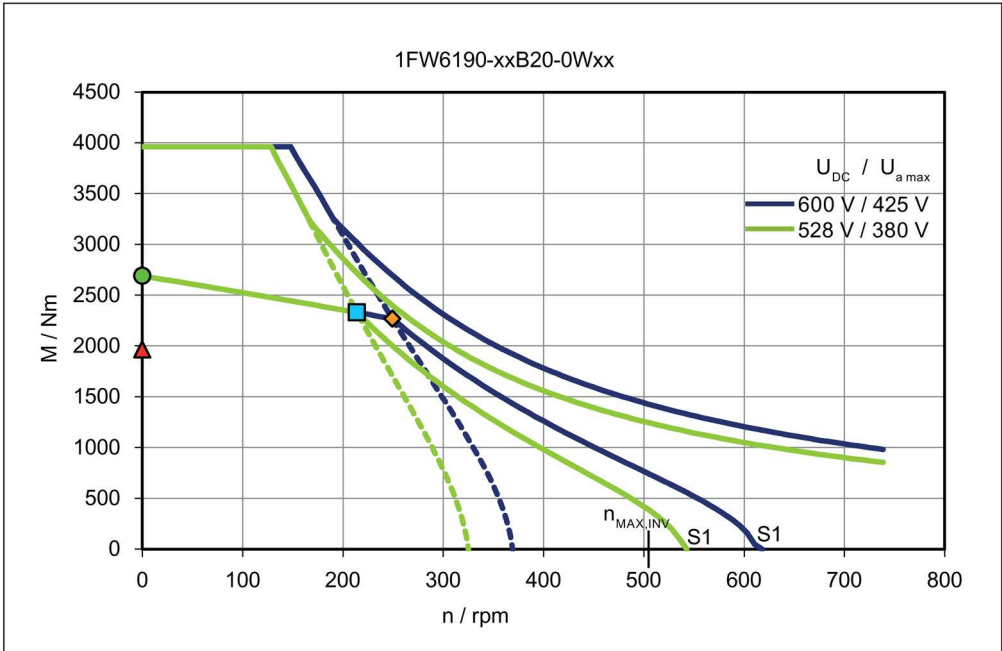

Torque M with respect to speed n

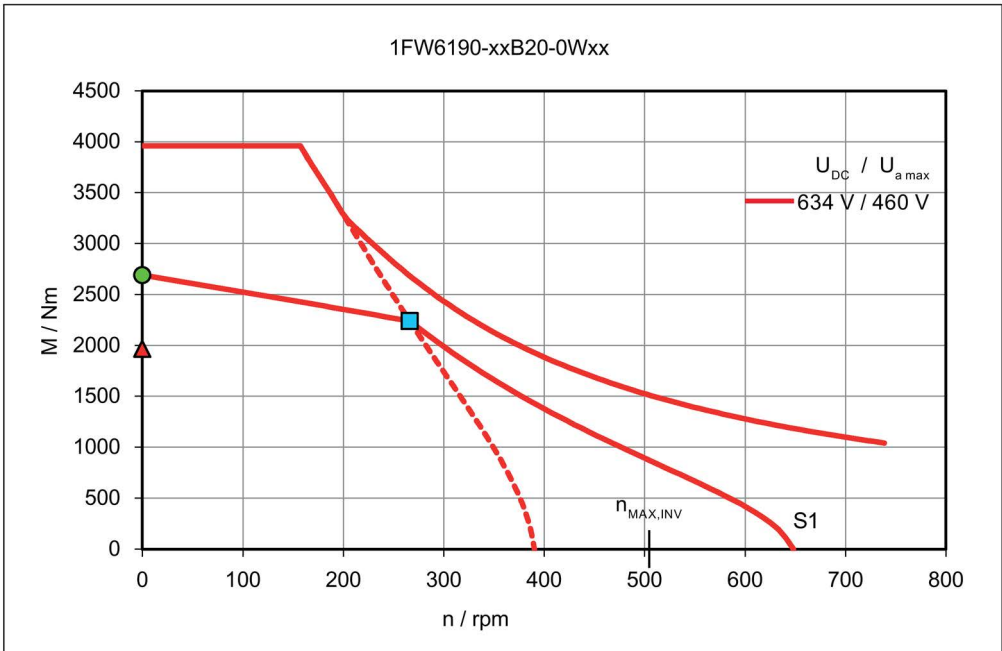

Short-circuit braking torque M_{Br} with respect to speed n

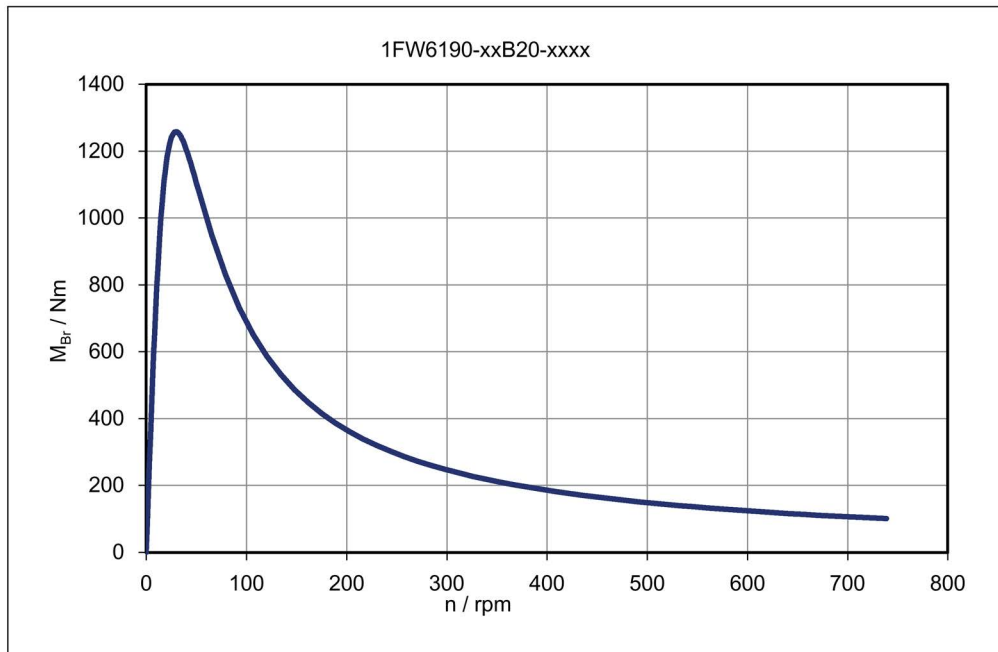

Main cooler and precision cooler - pressure losses Δp with respect to the flow rate \dot{V} (HK || PK: main cooler HK and precision cooler PK connected in parallel)

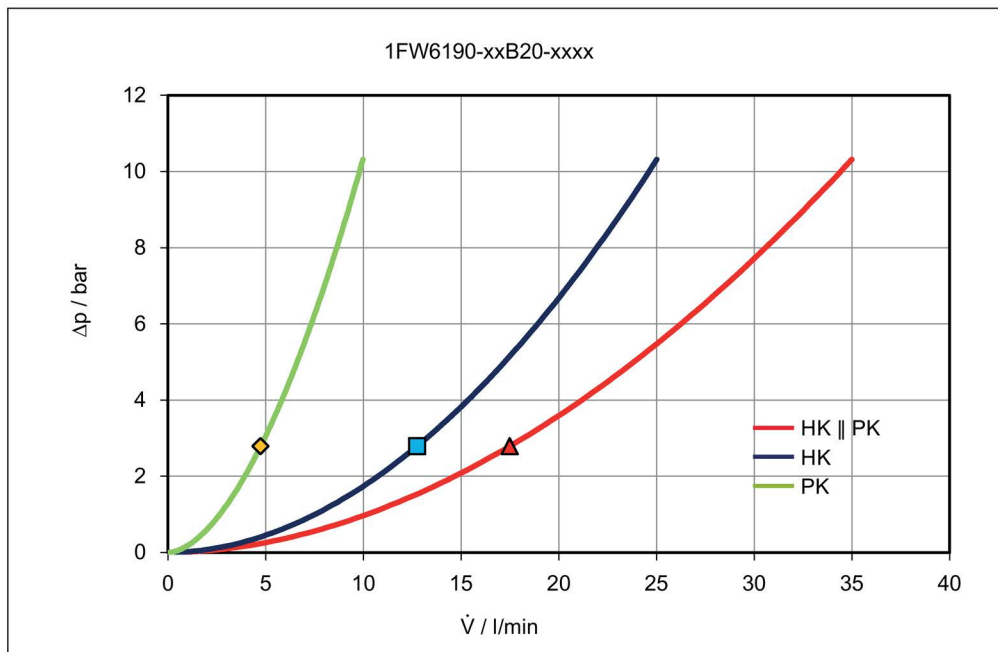

Rotor power loss P_{LV} with respect to speed n

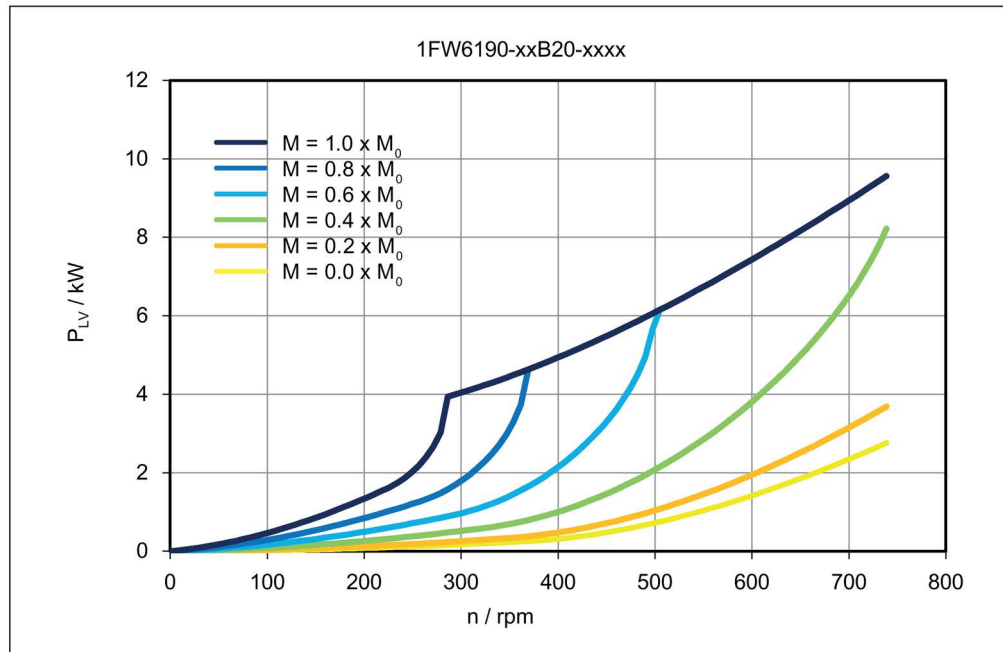

6.2.8 1FW6230-xxxxx-xxxx

Data sheet 1FW6230-xxB05-xxxx

Table 6- 42 1FW6230-xxB05-1Jxx, 1FW6230-xxB05-2Jxx, 1FW6230-xxB05-5Gxx

Technical data	Symbol	Unit	-xxB05-1Jxx	-xxB05-2Jxx	-xxB05-5Gxx
1FW6230					
Boundary conditions					
DC link voltage	U_{DC}	V	600	600	600
Water cooling inlet temperature	T_{VORL}	°C	35	35	35
Rated temperature of winding	T_N	°C	130	130	130
Data at the rated operating point					
Rated torque	M_N	Nm	801	778	669
Rated current	I_N	A	16	22.2	41.4
Rated speed	n_N	rpm	66.1	104	275
Rated power loss	$P_{V,N}$	kW	3.66	3.78	3.7
Limit data					
Maximum torque	M_{MAX}	Nm	1320	1320	1320
Maximum current	I_{MAX}	A	31.9	45.5	101
Electric motor power at M_{MAX}	$P_{EL,MAX}$	kW	17.4	21.1	33.3
Maximum speed	n_{MAX}	rpm	253	361	797
Maximum speed at maximum torque	$n_{MAX,MMAX}$	rpm	32.6	56	147
Max. speed without VPM	$n_{MAX,INV}$	rpm	173	247	545
No-load speed	$n_{MAX,0}$	rpm	126	181	399
Torque at $n = 1$ rpm	M_0	Nm	841	841	841
Current at M_0 and $n = 1$ rpm	I_0	A	17	24.2	53.4
Thermal static torque	M_0^*	Nm	614	614	614
Thermal stall current	I_0^*	A	12	17.1	37.8
Physical constants					
Torque constant at 20 °C	$k_{T,20}$	Nm/A	52.7	36.9	16.7
Voltage constant	k_E	V/(1000/min)	3190	2230	1010
Motor constant at 20 °C	$k_{M,20}$	Nm/(W) ^{0.5}	17.7	17.4	17.6
Thermal time constant	t_{TH}	s	180	180	180
No. of pole pairs	p	-	49	49	49
Cogging torque	M_{COG}	Nm	4.2	4.2	4.2
Stator mass	m_S	kg	31.9	31.9	31.9
Rotor mass	m_L	kg	12.9	12.9	12.9
Rotor moment of inertia	J_L	10 ⁻² kgm ²	62.2	62.2	62.2
Phase resistance of winding at 20 °C	$R_{STR, 20}$	Ω	2.97	1.5	0.301
Phase inductance of winding	L_{STR}	mH	26.9	13.2	2.71

Technical data	Symbol	Unit	-xxB05-1Jxx	-xxB05-2Jxx	-xxB05-5Gxx
1FW6230					
Data for main motor cooler *)					
Maximum dissipated thermal power	$Q_{H,MAX}$	kW	2.75	2.84	2.78
Recommended minimum volume flow	$\dot{V}_{H,MIN}$	l/min	4.79	4.79	4.79
Cooling medium temperature increase	ΔT_H	K	8.26	8.52	8.34
Pressure drop	Δp_H	bar	0.459	0.459	0.459
Data for precision motor cooler *)					
Maximum dissipated thermal power	$Q_{P,MAX}$	kW	0.297	0.306	0.299
Recommended minimum volume flow	$\dot{V}_{P,MIN}$	l/min	1.61	1.61	1.61
Cooling medium temperature increase	ΔT_P	K	2.65	2.73	2.67
Pressure drop	Δp_P	bar	0.459	0.459	0.459

*) Parallel connection of main and precision motor cooler

Characteristics for 1FW6230-xxB05-xxxx

Torque M with respect to speed n

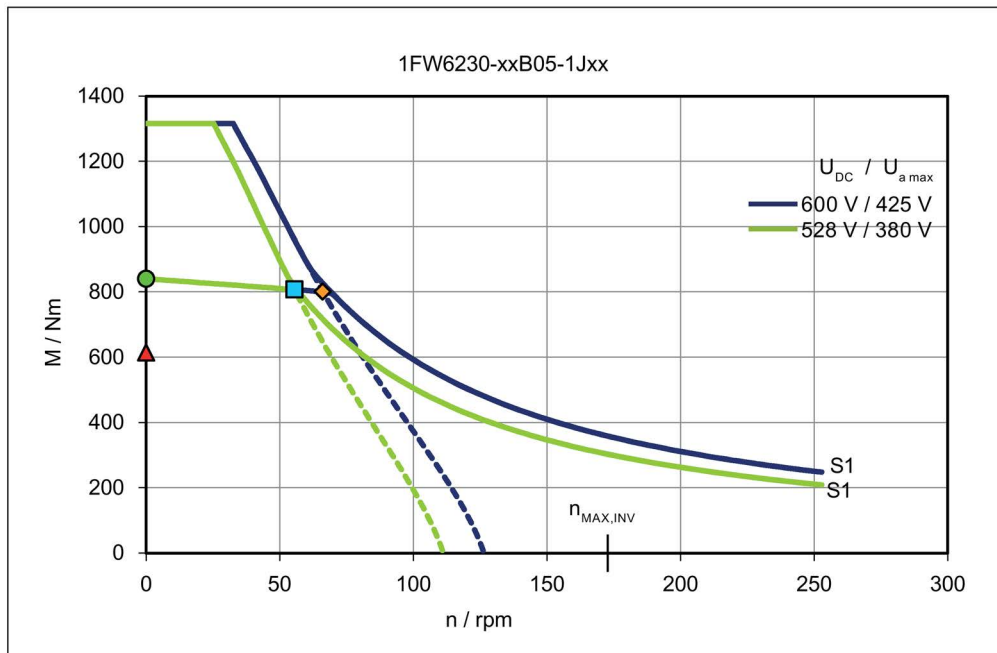

Torque M with respect to speed n

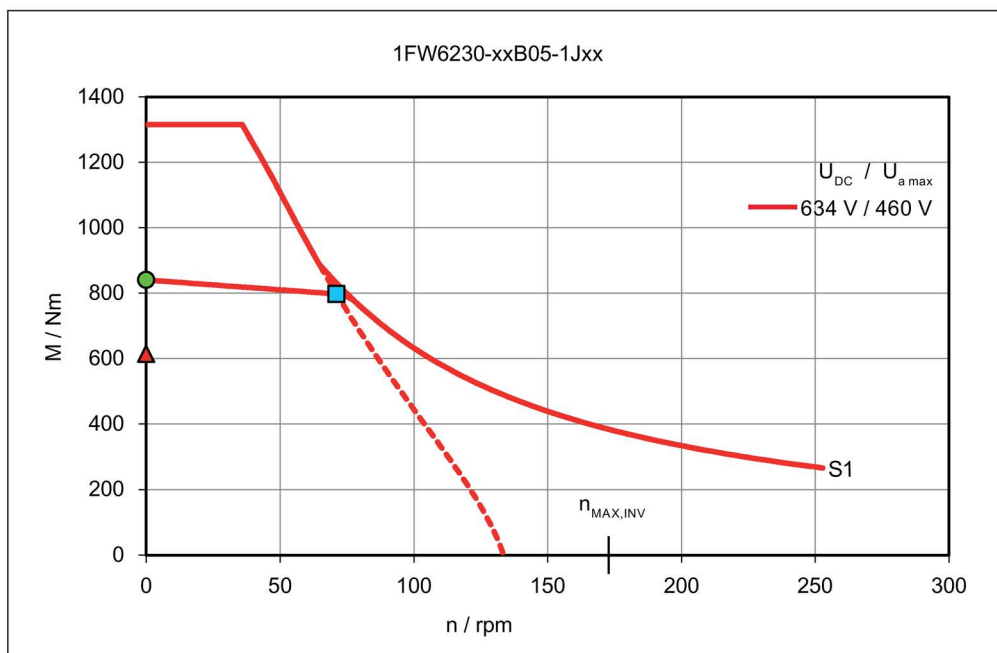

Torque M with respect to speed n

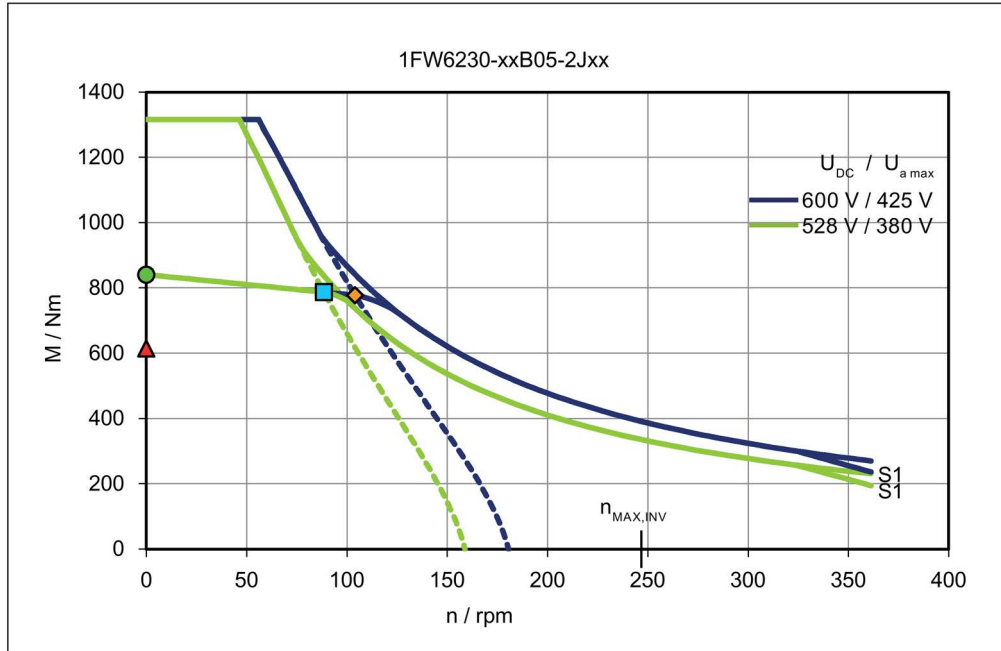

Torque M with respect to speed n

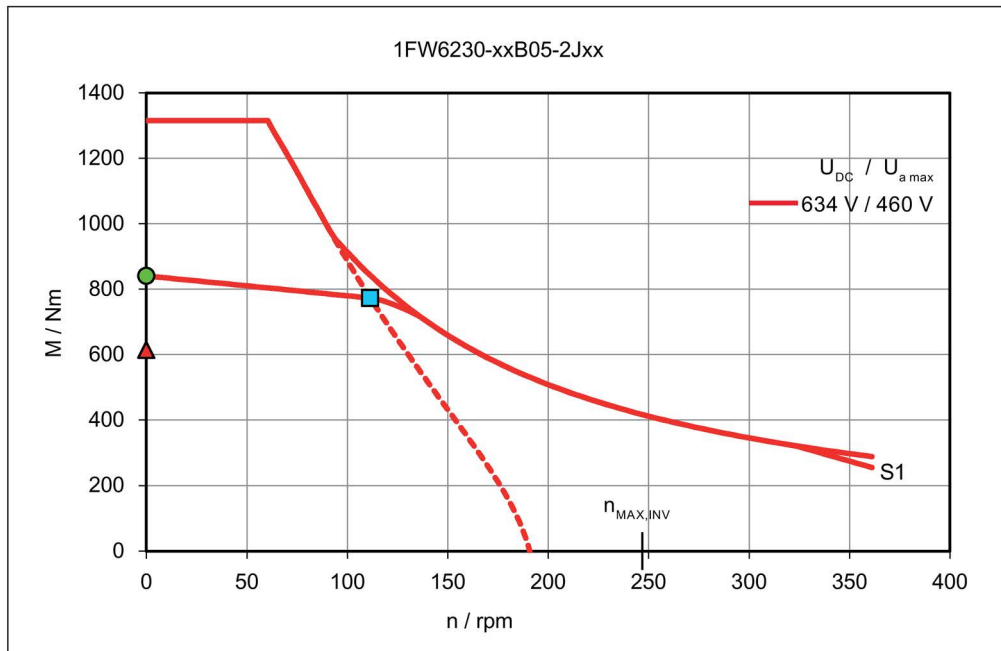

Torque M with respect to speed n

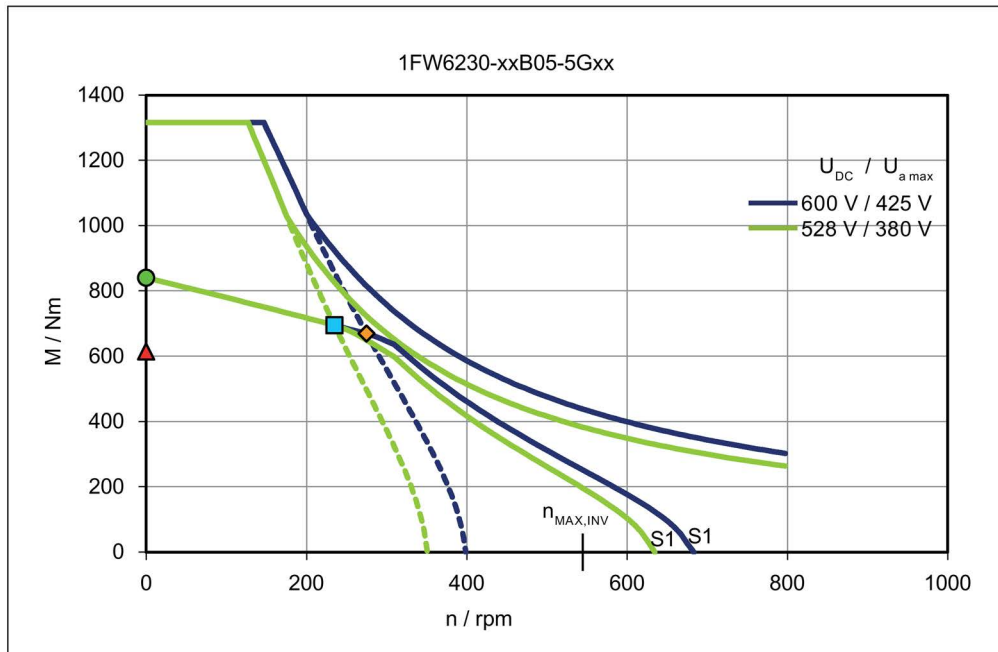

Torque M with respect to speed n

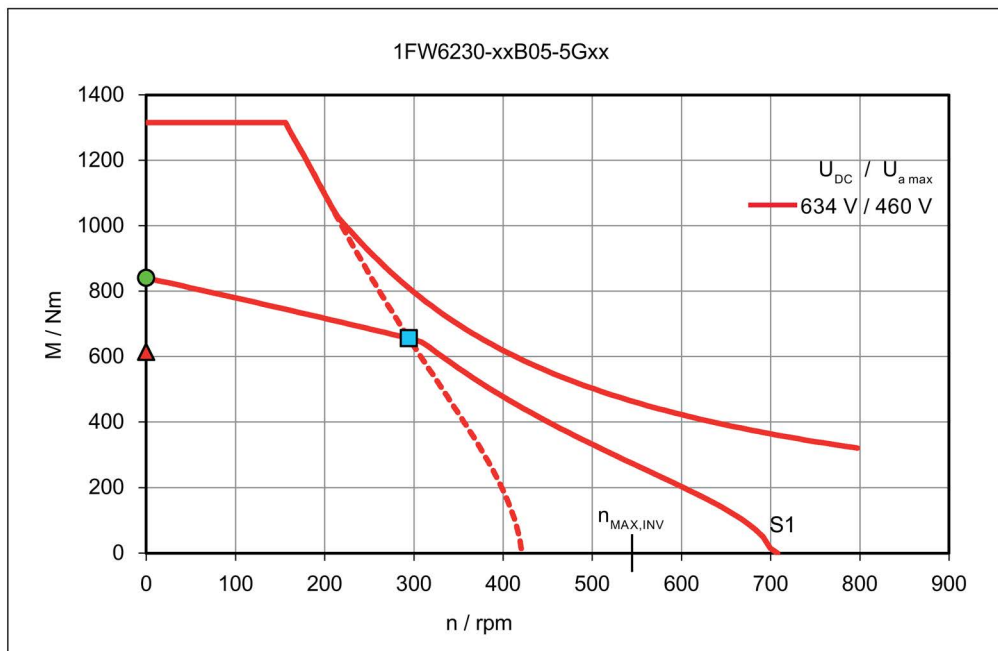

Short-circuit braking torque M_{Br} with respect to speed n

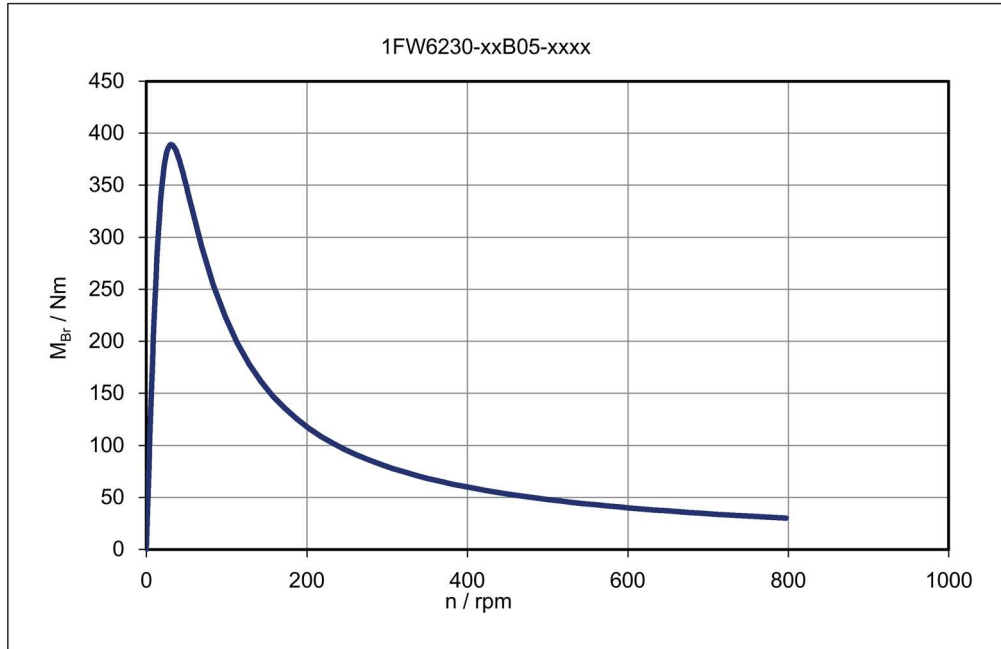

Main cooler and precision cooler - pressure losses Δp with respect to the flow rate \dot{V} (HK || PK: main cooler HK and precision cooler PK connected in parallel)

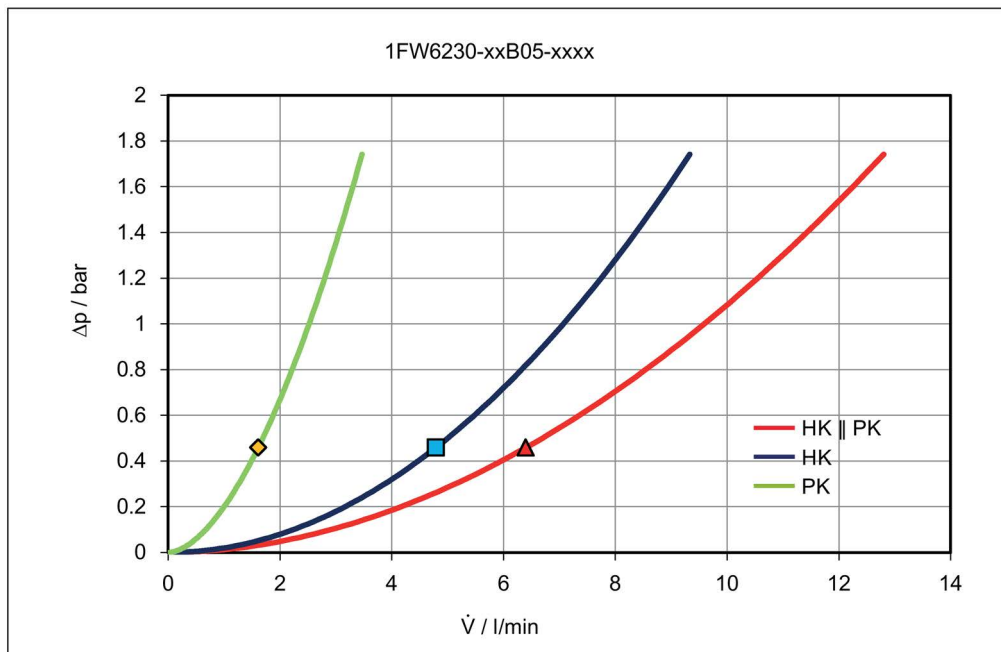

Rotor power loss P_{LV} with respect to speed n

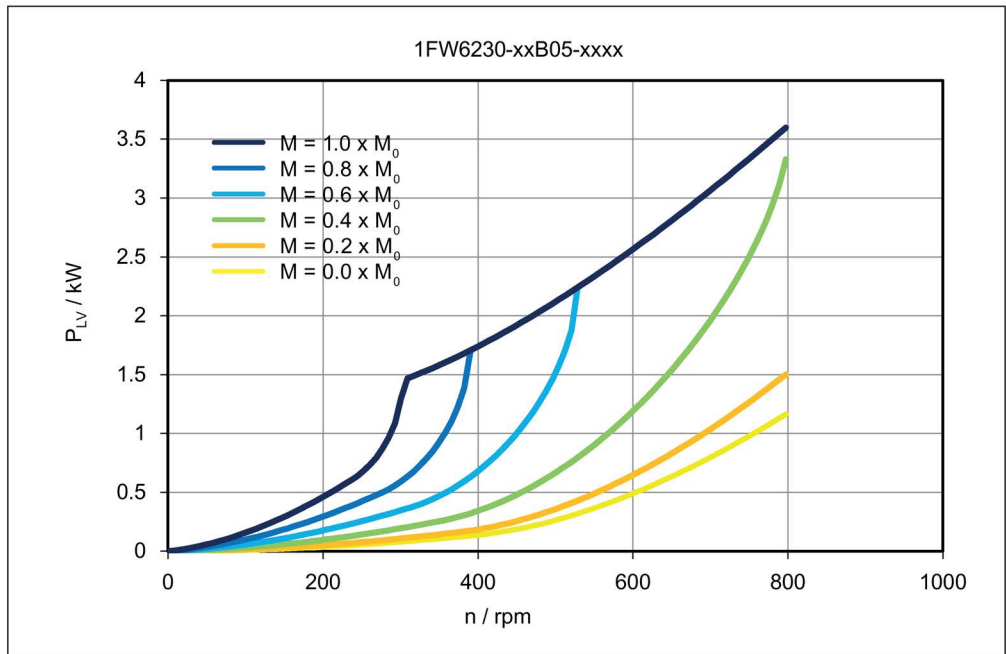

Data sheet 1FW6230-xxB07-xxxx

Table 6- 43 1FW6230-xxB07-1Jxx, 1FW6230-xxB07-2Jxx, 1FW6230-xxB07-5Gxx

Technical data	Symbol	Unit	-xxB07-1Jxx	-xxB07-2Jxx	-xxB07-5Gxx
1FW6230					
Boundary conditions					
DC link voltage	U_{DC}	V	600	600	600
Water cooling inlet temperature	T_{VORL}	°C	35	35	35
Rated temperature of winding	T_N	°C	130	130	130
Data at the rated operating point					
Rated torque	M_N	Nm	1140	1120	1020
Rated current	I_N	A	16.4	22.8	45.4
Rated speed	n_N	rpm	43.2	69.8	185
Rated power loss	$P_{V,N}$	kW	4.6	4.74	4.64
Limit data					
Maximum torque	M_{MAX}	Nm	1840	1840	1840
Maximum current	I_{MAX}	A	31.9	45.5	101
Electric motor power at M_{MAX}	$P_{EL,MAX}$	kW	19.7	23.7	36.3
Maximum speed	n_{MAX}	rpm	181	258	570
Maximum speed at maximum torque	$n_{MAX,MMAX}$	rpm	18	35.9	103
Max. speed without VPM	$n_{MAX,INV}$	rpm	123	176	389
No-load speed	$n_{MAX,0}$	rpm	90.3	129	285
Torque at $n = 1$ rpm	M_0	Nm	1180	1180	1180
Current at M_0 and $n = 1$ rpm	I_0	A	17	24.2	53.4
Thermal static torque	M_0^*	Nm	860	860	860
Thermal stall current	I_0^*	A	12	17.1	37.8
Physical constants					
Torque constant at 20 °C	$k_{T,20}$	Nm/A	73.8	51.7	23.4
Voltage constant	k_E	V/(1000/min)	4460	3120	1420
Motor constant at 20 °C	$k_{M,20}$	Nm/(W) ^{0.5}	22.1	21.7	22
Thermal time constant	t_{TH}	s	180	180	180
No. of pole pairs	p	-	49	49	49
Cogging torque	M_{COG}	Nm	5.88	5.88	5.88
Stator mass	m_s	kg	41.4	41.4	41.4
Rotor mass	m_L	kg	17.4	17.4	17.4
Rotor moment of inertia	J_L	10 ⁻² kgm ²	84.3	84.3	84.3
Phase resistance of winding at 20 °C	$R_{STR, 20}$	Ω	3.73	1.88	0.378
Phase inductance of winding	L_{STR}	mH	37.3	18.3	3.75

Technical data	Symbol	Unit	-xxB07-1Jxx	-xxB07-2Jxx	-xxB07-5Gxx
1FW6230					
Data for main motor cooler *)					
Maximum dissipated thermal power	$Q_{H,MAX}$	kW	3.45	3.56	3.49
Recommended minimum volume flow	$\dot{V}_{H,MIN}$	l/min	6.15	6.15	6.15
Cooling medium temperature increase	ΔT_H	K	8.08	8.33	8.15
Pressure drop	Δp_H	bar	0.756	0.756	0.756
Data for precision motor cooler *)					
Maximum dissipated thermal power	$Q_{P,MAX}$	kW	0.373	0.384	0.376
Recommended minimum volume flow	$\dot{V}_{P,MIN}$	l/min	2.15	2.15	2.15
Cooling medium temperature increase	ΔT_P	K	2.49	2.57	2.52
Pressure drop	Δp_P	bar	0.756	0.756	0.756

*) Parallel connection of main and precision motor cooler

Table 6- 44 1FW6230-xxB07-8Fxx

Technical data	Symbol	Unit	-xxB07-8Fxx
1FW6230			
Boundary conditions			
DC link voltage	U_{DC}	V	600
Water cooling inlet temperature	T_{VORL}	°C	35
Rated temperature of winding	T_N	°C	130
Data at the rated operating point			
Rated torque	M_N	Nm	936
Rated current	I_N	A	57.5
Rated speed	n_N	rpm	275
Rated power loss	$P_{V,N}$	kW	4.67
Limit data			
Maximum torque	M_{MAX}	Nm	1840
Maximum current	I_{MAX}	A	139
Electric motor power at M_{MAX}	$P_{EL,MAX}$	kW	45.1
Maximum speed	n_{MAX}	rpm	790
Maximum speed at maximum torque	$n_{MAX,MMAX}$	rpm	148
Max. speed without VPM	$n_{MAX,INV}$	rpm	540
No-load speed	$n_{MAX,0}$	rpm	395
Torque at $n = 1$ rpm	M_0	Nm	1180
Current at M_0 and $n = 1$ rpm	I_0	A	74.2
Thermal static torque	M_0^*	Nm	860
Thermal stall current	I_0^*	A	52.4
Physical constants			
Torque constant at 20 °C	$k_{T,20}$	Nm/A	16.9
Voltage constant	k_E	V/(1000/min)	1020
Motor constant at 20 °C	$k_{M,20}$	Nm/(W) ^{0.5}	21.9
Thermal time constant	t_{TH}	s	180
No. of pole pairs	p	-	49
Cogging torque	M_{COG}	Nm	5.88
Stator mass	m_s	kg	41.4
Rotor mass	m_L	kg	17.4
Rotor moment of inertia	J_L	10 ⁻² kgm ²	84.3
Phase resistance of winding at 20 °C	$R_{STR, 20}$	Ω	0.198
Phase inductance of winding	L_{STR}	mH	1.95
Data for main motor cooler *)			
Maximum dissipated thermal power	$Q_{H,MAX}$	kW	3.51
Recommended minimum volume flow	$\dot{V}_{H,MIN}$	l/min	6.15
Cooling medium temperature increase	ΔT_H	K	8.2
Pressure drop	Δp_H	bar	0.756

Technical data	Symbol	Unit	-xxB07-8Fxx
1FW6230			
Data for precision motor cooler *)			
Maximum dissipated thermal power	$Q_{P,MAX}$	kW	0.378
Recommended minimum volume flow	$\dot{V}_{P,MIN}$	l/min	2.15
Cooling medium temperature increase	ΔT_P	K	2.53
Pressure drop	Δp_P	bar	0.756

*) Parallel connection of main and precision motor cooler

Characteristics for 1FW6230-xxB07-xxxx

Torque M with respect to speed n

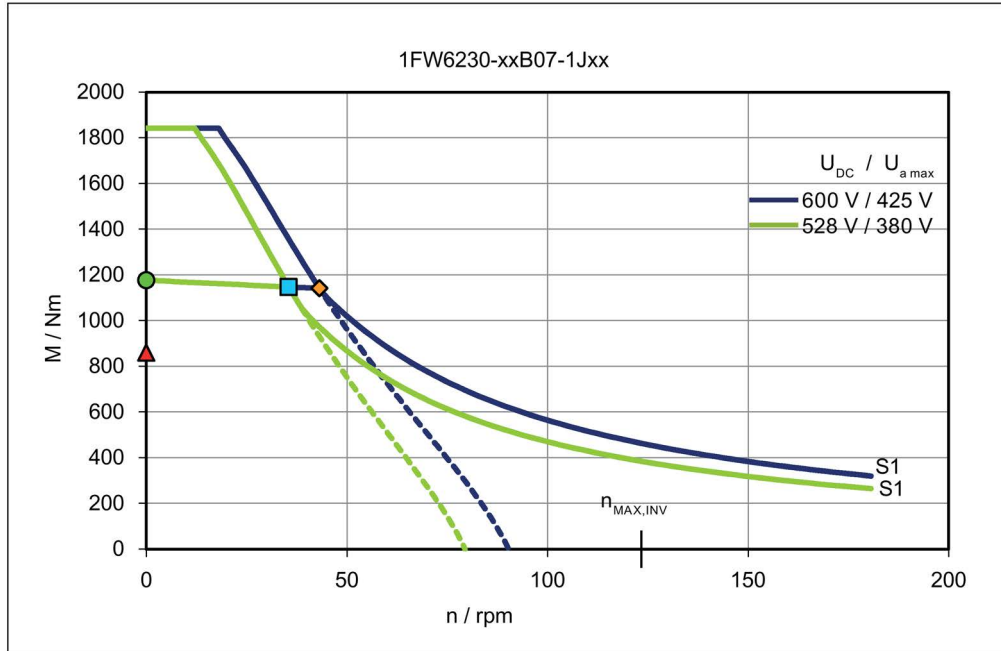

Torque M with respect to speed n

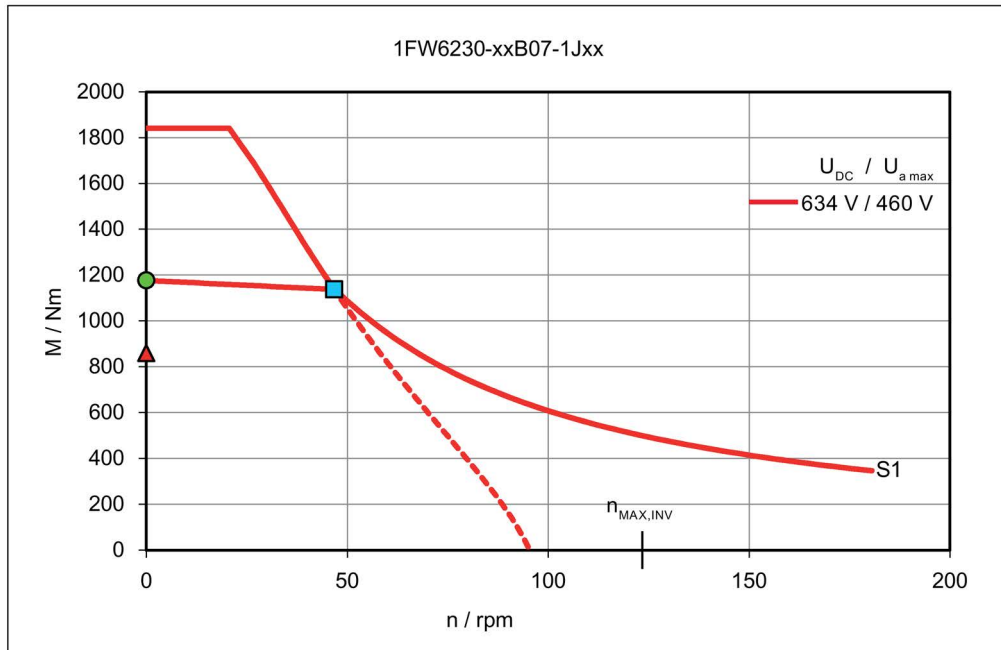

Torque M with respect to speed n

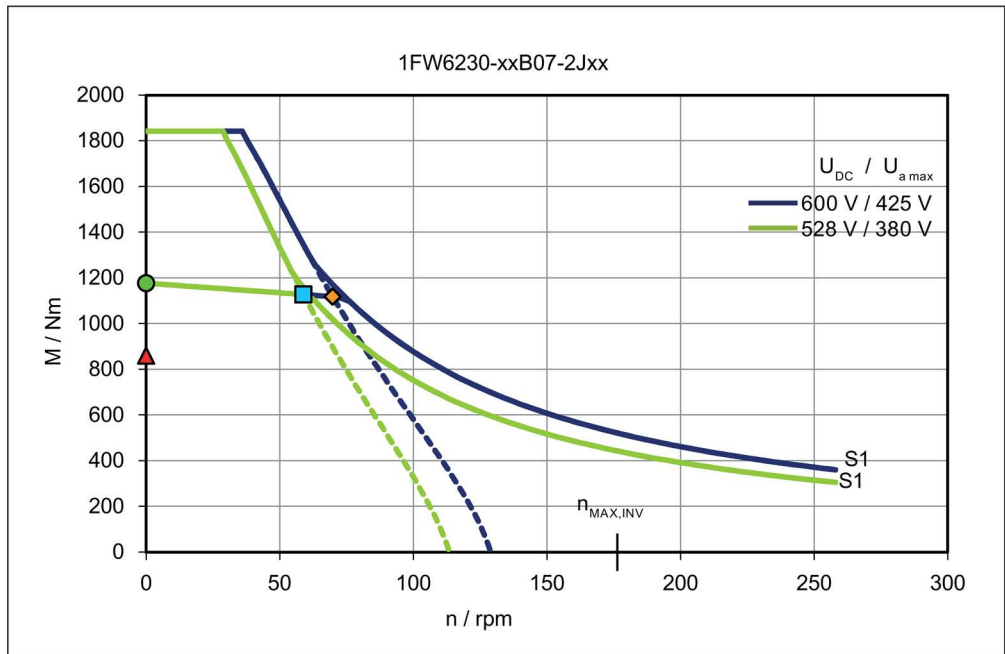

Torque M with respect to speed n

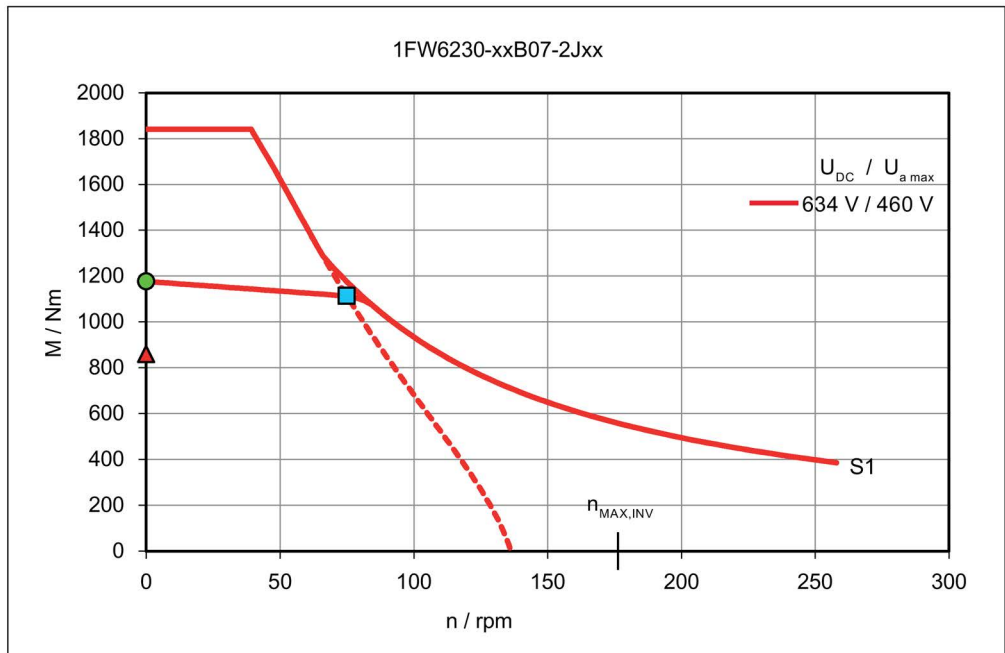

Torque M with respect to speed n

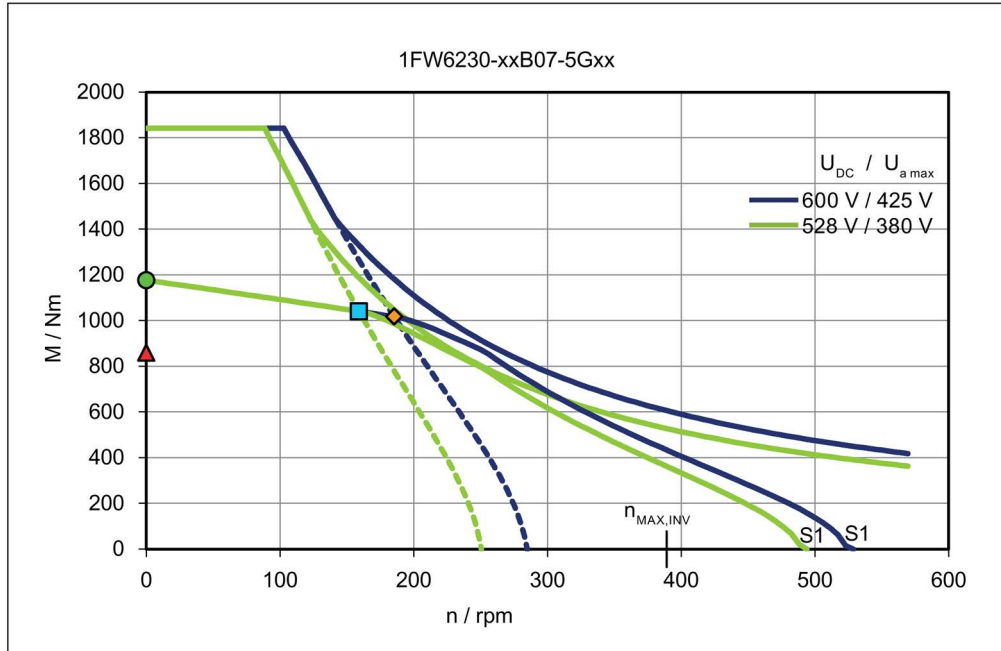

Torque M with respect to speed n

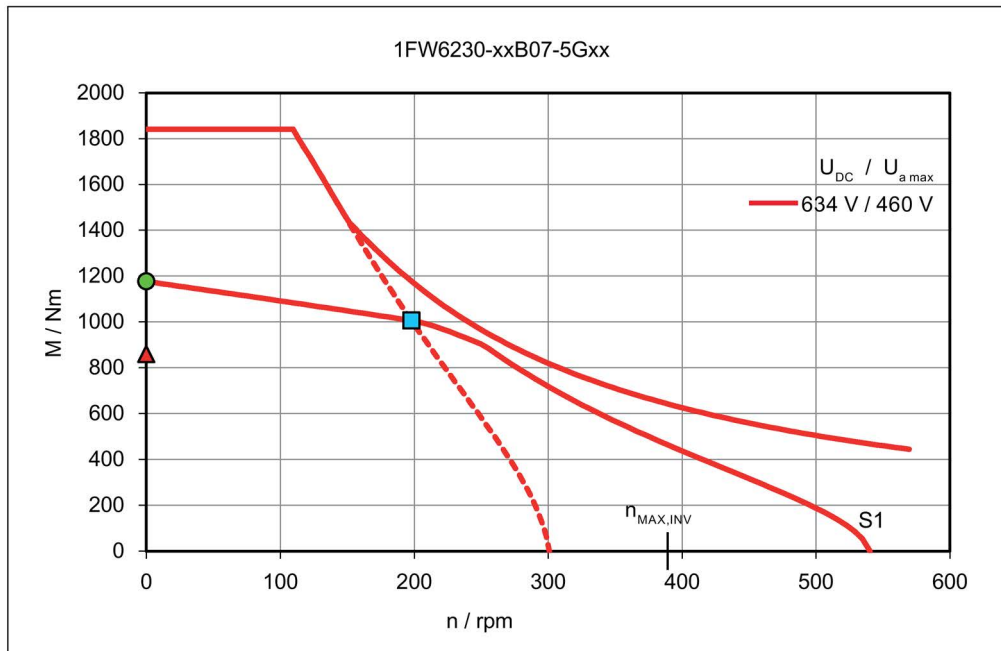

Torque M with respect to speed n

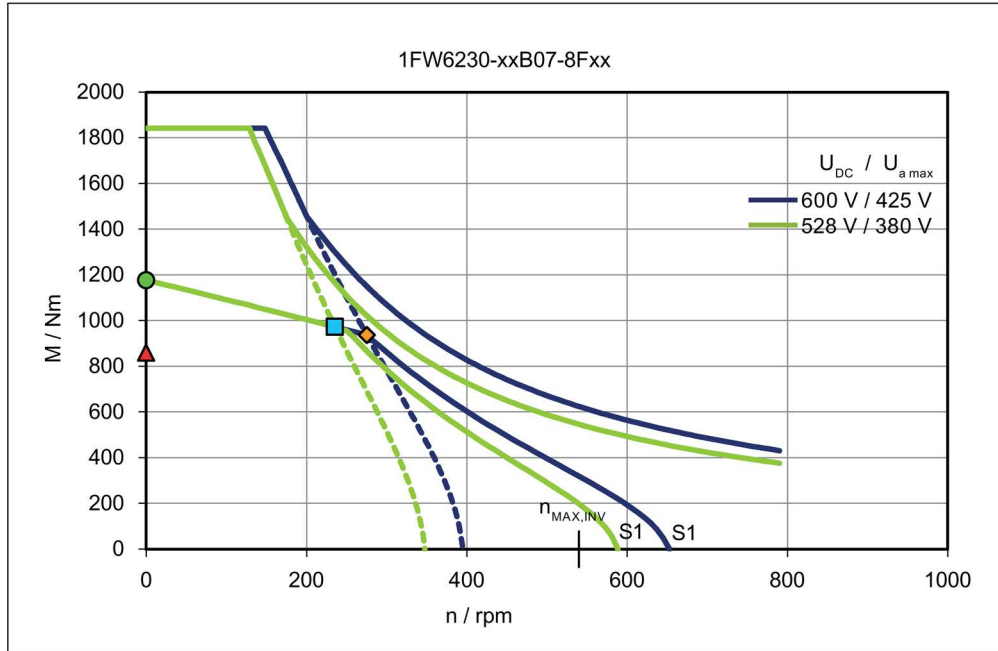

Torque M with respect to speed n

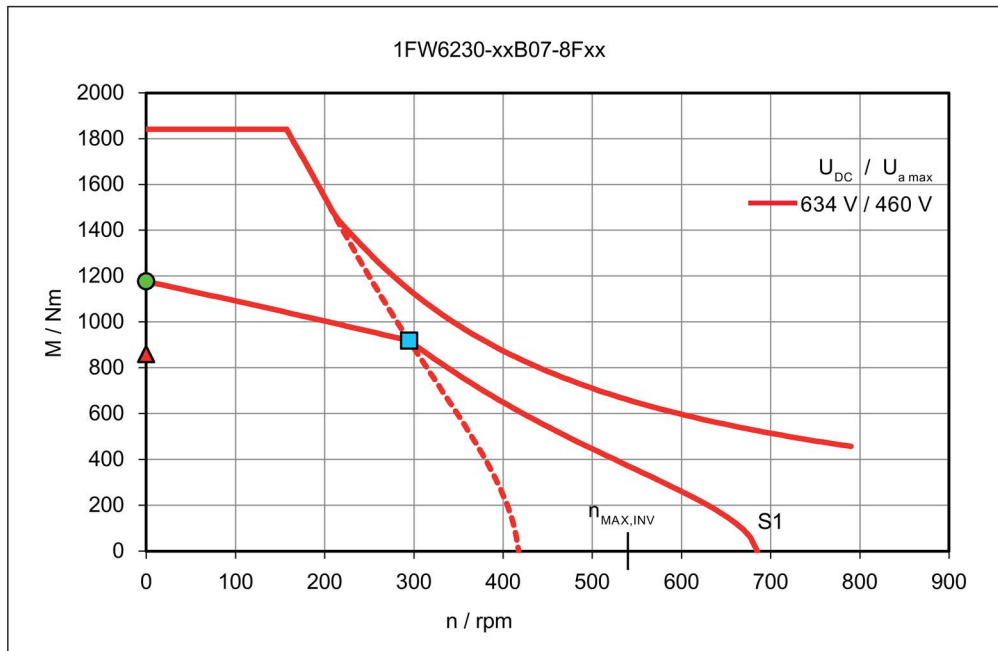

Short-circuit braking torque M_{Br} with respect to speed n

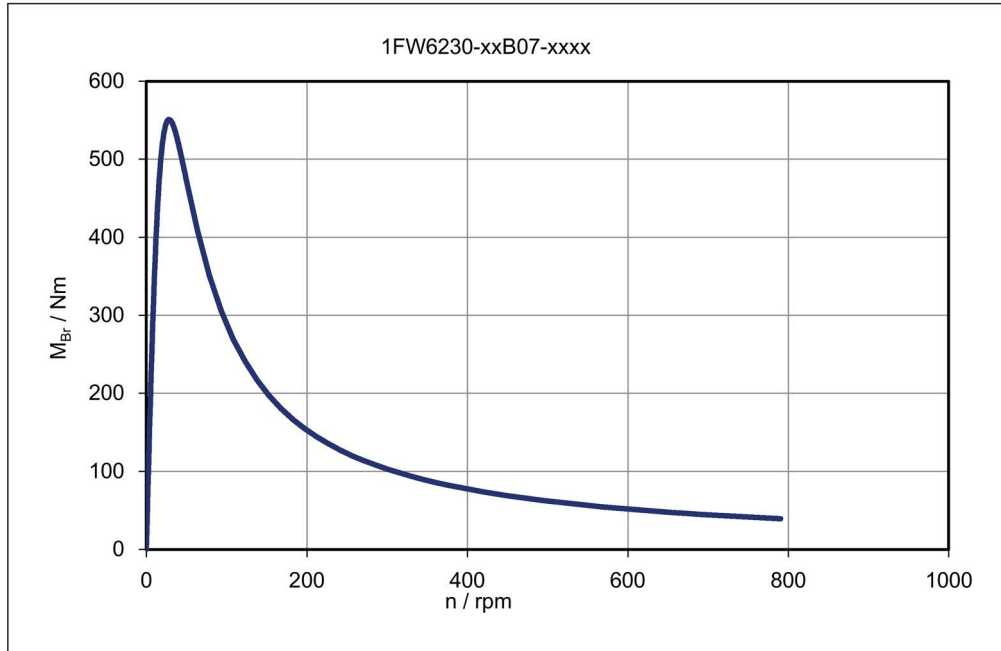

Main cooler and precision cooler - pressure losses Δp with respect to the flow rate \dot{V} (HK || PK: main cooler HK and precision cooler PK connected in parallel)

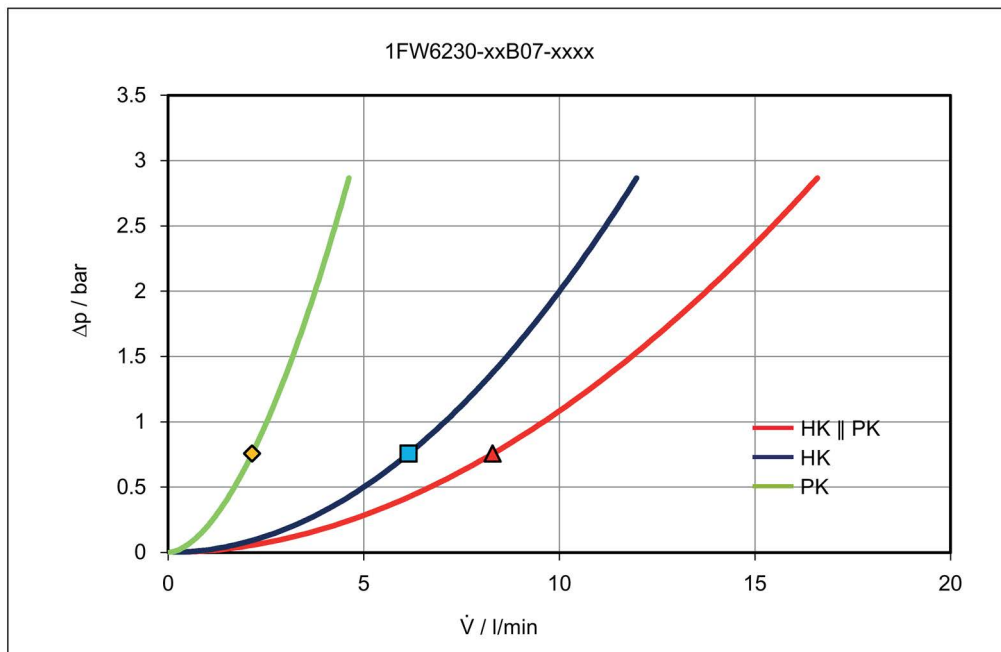

Rotor power loss P_{LV} with respect to speed n

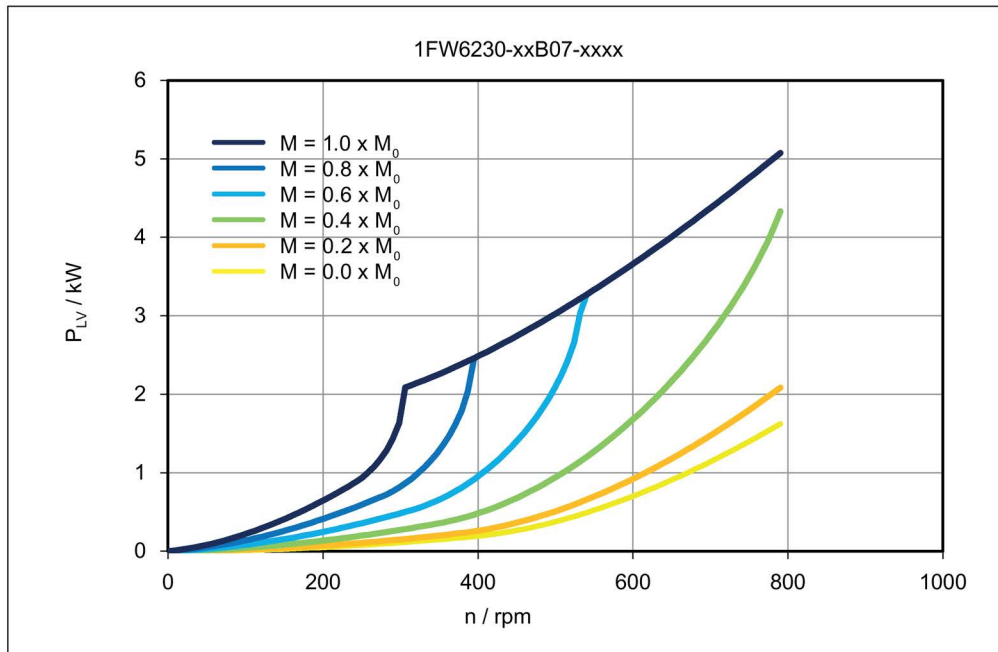

Data sheet 1FW6230-xxB10-xxxx

Table 6- 45 1FW6230-xxB10-2Jxx, 1FW6230-xxB10-5Gxx, 1FW6230-xxB10-8Fxx

Technical data	Symbol	Unit	-xxB10-2Jxx	-xxB10-5Gxx	-xxB10-8Fxx
1FW6230					
Boundary conditions					
DC link voltage	U_{DC}	V	600	600	600
Water cooling inlet temperature	T_{VORL}	°C	35	35	35
Rated temperature of winding	T_N	°C	130	130	130
Data at the rated operating point					
Rated torque	M_N	Nm	1630	1530	1460
Rated current	I_N	A	23.3	48.1	63.2
Rated speed	n_N	rpm	44.4	123	181
Rated power loss	$P_{V,N}$	kW	6.19	6.06	6.09
Limit data					
Maximum torque	M_{MAX}	Nm	2630	2630	2630
Maximum current	I_{MAX}	A	45.5	101	139
Electric motor power at M_{MAX}	$P_{EL,MAX}$	kW	27.3	40.5	49.5
Maximum speed	n_{MAX}	rpm	181	399	553
Maximum speed at maximum torque	$n_{MAX,MMAX}$	rpm	19.8	69	101
Max. speed without VPM	$n_{MAX,INV}$	rpm	123	272	378
No-load speed	$n_{MAX,0}$	rpm	90.3	199	277
Torque at $n = 1$ rpm	M_0	Nm	1680	1680	1680
Current at M_0 and $n = 1$ rpm	I_0	A	24.2	53.4	74.2
Thermal static torque	M_0^*	Nm	1230	1230	1230
Thermal stall current	I_0^*	A	17.1	37.8	52.4
Physical constants					
Torque constant at 20 °C	$k_{T,20}$	Nm/A	73.8	33.4	24.1
Voltage constant	k_E	V/(1000/min)	4460	2020	1460
Motor constant at 20 °C	$k_{M,20}$	Nm/(W) ^{0.5}	27.2	27.5	27.4
Thermal time constant	t_{TH}	s	180	180	180
No. of pole pairs	p	-	49	49	49
Cogging torque	M_{COG}	Nm	8.41	8.41	8.41
Stator mass	m_s	kg	57.5	57.5	57.5
Rotor mass	m_L	kg	24.3	24.3	24.3
Rotor moment of inertia	J_L	10 ⁻² kgm ²	118	118	118
Phase resistance of winding at 20 °C	$R_{STR, 20}$	Ω	2.46	0.494	0.258
Phase inductance of winding	L_{STR}	mH	25.9	5.31	2.76

Technical data	Symbol	Unit	-xxB10-2Jxx	-xxB10-5Gxx	-xxB10-8Fxx
1FW6230					
Data for main motor cooler *)					
Maximum dissipated thermal power	$Q_{H,MAX}$	kW	4.65	4.55	4.58
Recommended minimum volume flow	$\dot{V}_{H,MIN}$	l/min	7.98	7.98	7.98
Cooling medium temperature increase	ΔT_H	K	8.38	8.21	8.25
Pressure drop	Δp_H	bar	1.27	1.27	1.27
Data for precision motor cooler *)					
Maximum dissipated thermal power	$Q_{P,MAX}$	kW	0.502	0.491	0.494
Recommended minimum volume flow	$\dot{V}_{P,MIN}$	l/min	2.9	2.9	2.9
Cooling medium temperature increase	ΔT_P	K	2.49	2.44	2.45
Pressure drop	Δp_P	bar	1.27	1.27	1.27

*) Parallel connection of main and precision motor cooler

Table 6- 46 1FW6230-xxB10-2Pxx

Technical data	Symbol	Unit	-xxB10-2Pxx
1FW6230			
Boundary conditions			
DC link voltage	U_{DC}	V	600
Water cooling inlet temperature	T_{VORL}	°C	35
Rated temperature of winding	T_N	°C	130
Data at the rated operating point			
Rated torque	M_N	Nm	1330
Rated current	I_N	A	81.9
Rated speed	n_N	rpm	278
Rated power loss	$P_{V,N}$	kW	6.24
Limit data			
Maximum torque	M_{MAX}	Nm	2630
Maximum current	I_{MAX}	A	199
Electric motor power at M_{MAX}	$P_{EL,MAX}$	kW	63.5
Maximum speed	n_{MAX}	rpm	790
Maximum speed at maximum torque	$n_{MAX,MMAX}$	rpm	150
Max. speed without VPM	$n_{MAX,INV}$	rpm	540
No-load speed	$n_{MAX,0}$	rpm	395
Torque at $n = 1$ rpm	M_0	Nm	1680
Current at M_0 and $n = 1$ rpm	I_0	A	106
Thermal static torque	M_0^*	Nm	1230
Thermal stall current	I_0^*	A	74.9
Physical constants			
Torque constant at 20 °C	$k_{T,20}$	Nm/A	16.9
Voltage constant	k_E	V/(1000/min)	1020
Motor constant at 20 °C	$k_{M,20}$	Nm/(W) ^{0.5}	27.1
Thermal time constant	t_{TH}	s	180
No. of pole pairs	p	-	49
Cogging torque	M_{COG}	Nm	8.41
Stator mass	m_s	kg	57.5
Rotor mass	m_L	kg	24.3
Rotor moment of inertia	J_L	10 ⁻² kgm ²	118
Phase resistance of winding at 20 °C	$R_{STR, 20}$	Ω	0.129
Phase inductance of winding	L_{STR}	mH	1.35
Data for main motor cooler *)			
Maximum dissipated thermal power	$Q_{H,MAX}$	kW	4.68
Recommended minimum volume flow	$\dot{V}_{H,MIN}$	l/min	7.98
Cooling medium temperature increase	ΔT_H	K	8.44
Pressure drop	Δp_H	bar	1.27

Technical data	Symbol	Unit	-xxB10-2Pxx
1FW6230			
Data for precision motor cooler *)			
Maximum dissipated thermal power	$Q_{P,MAX}$	kW	0.505
Recommended minimum volume flow	$\dot{V}_{P,MIN}$	l/min	2.9
Cooling medium temperature increase	ΔT_P	K	2.51
Pressure drop	Δp_P	bar	1.27

*) Parallel connection of main and precision motor cooler

Characteristics for 1FW6230-xxB10-xxxx

Torque M with respect to speed n

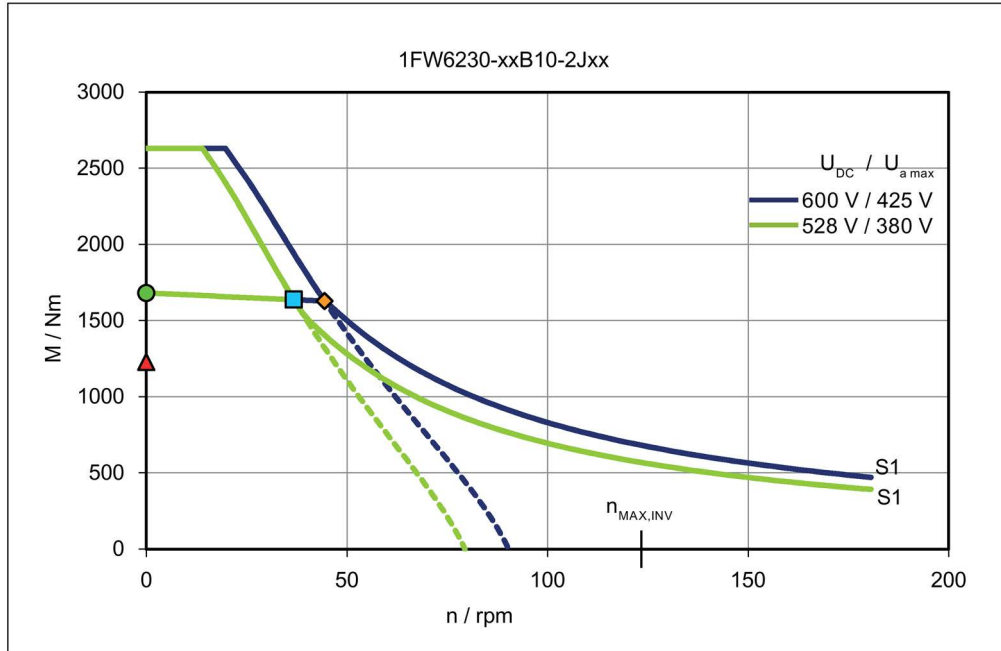

Torque M with respect to speed n

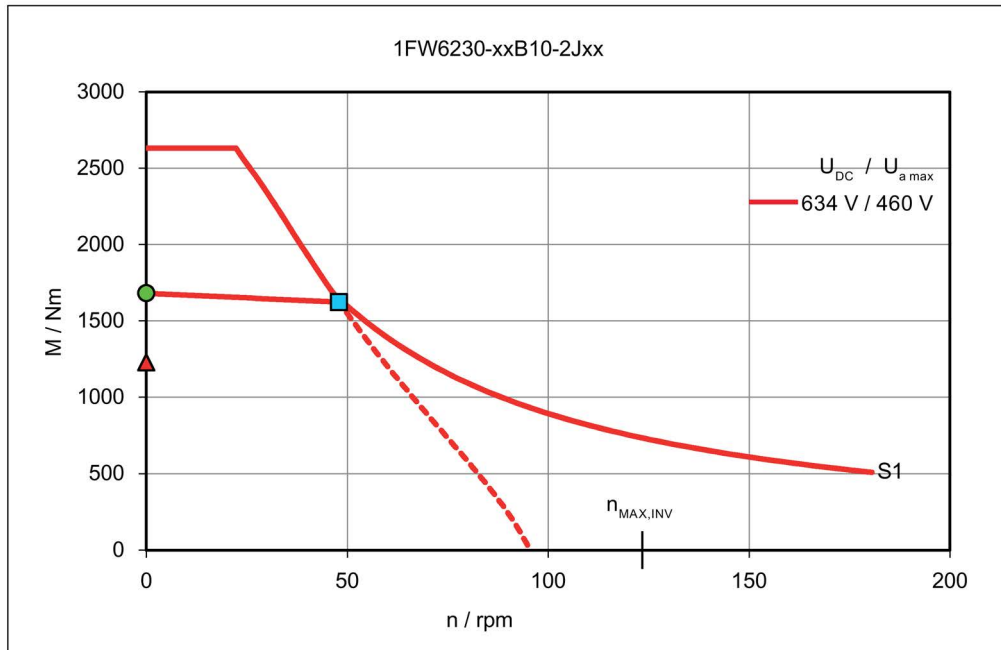

Torque M with respect to speed n

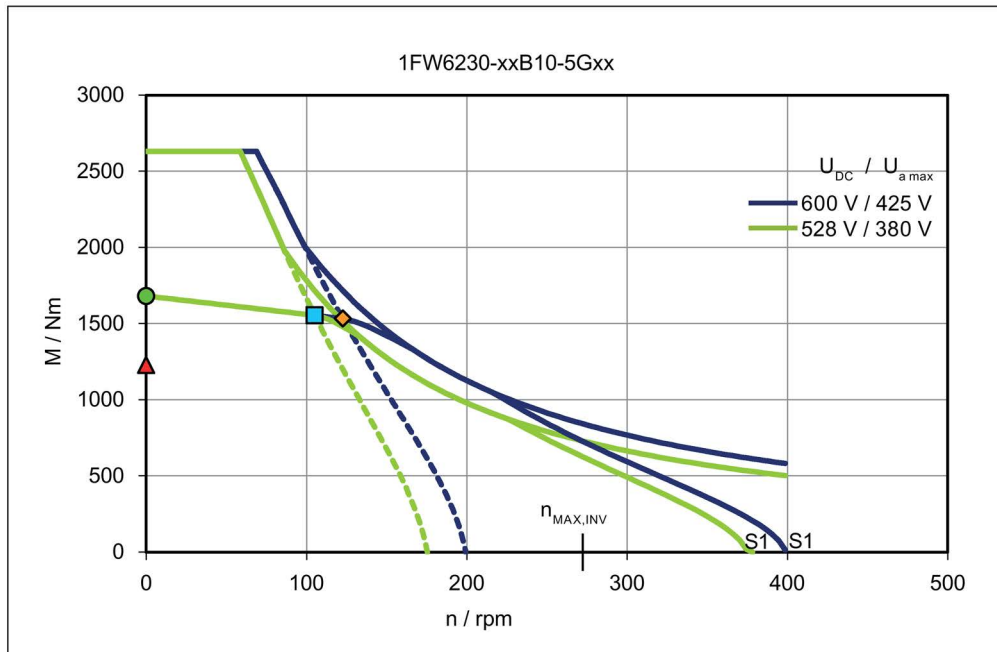

Torque M with respect to speed n

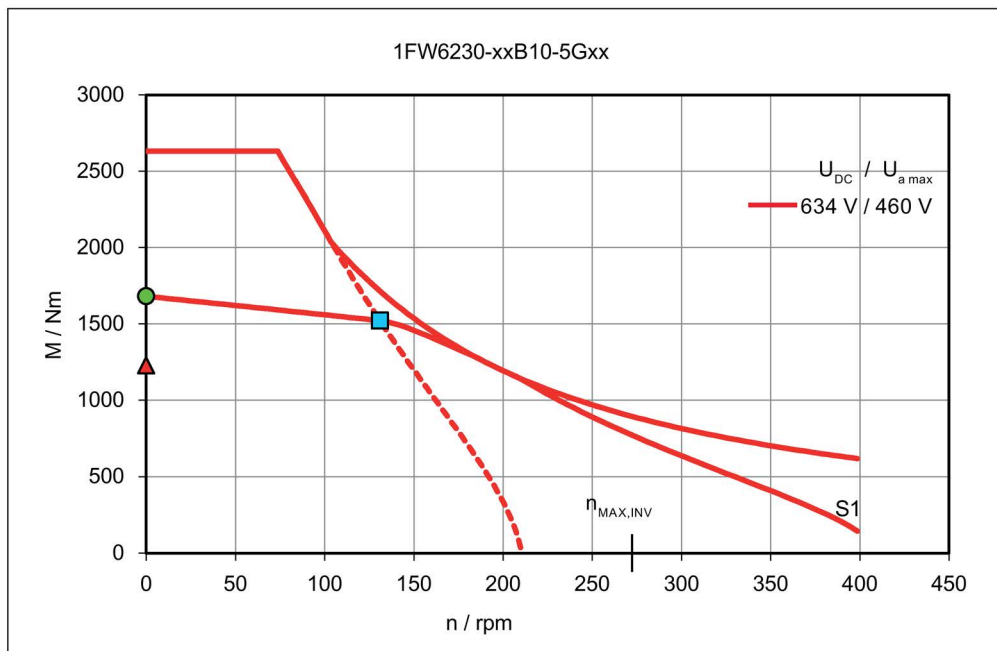

Torque M with respect to speed n

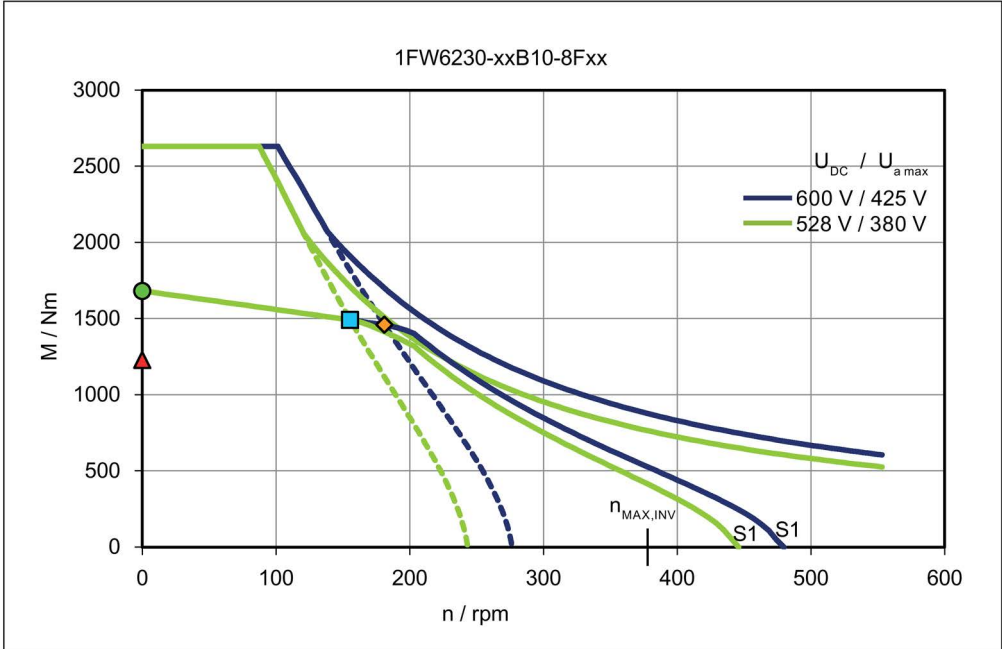

Torque M with respect to speed n

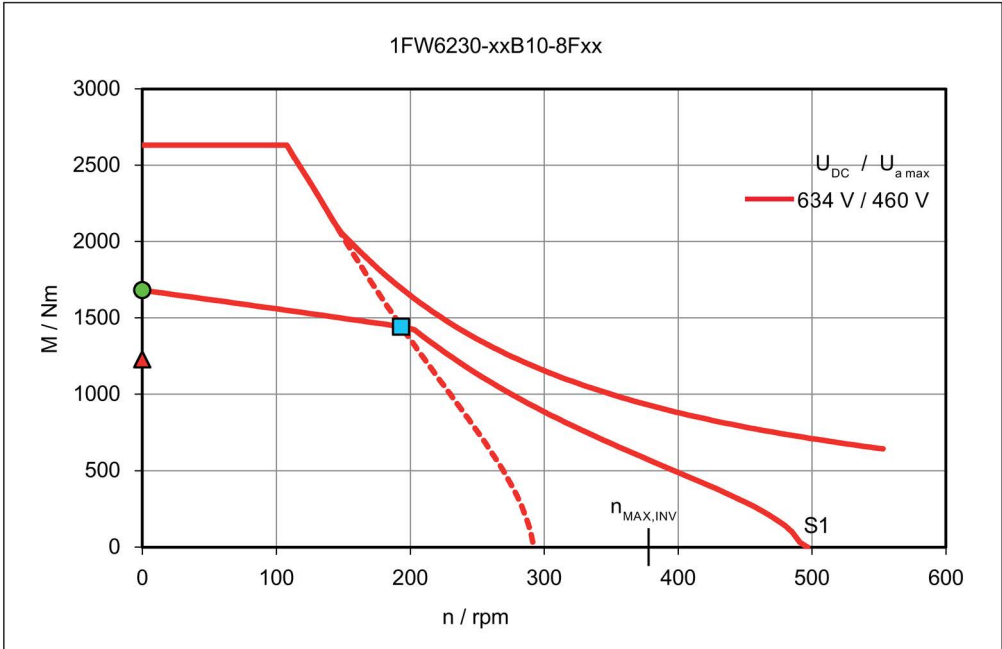

Torque M with respect to speed n

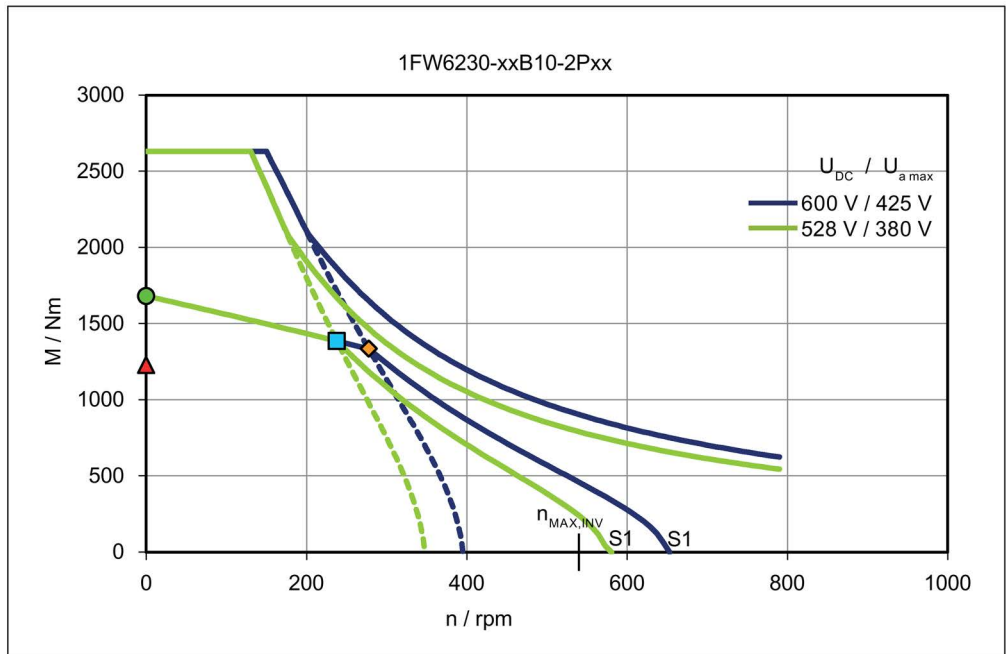

Torque M with respect to speed n

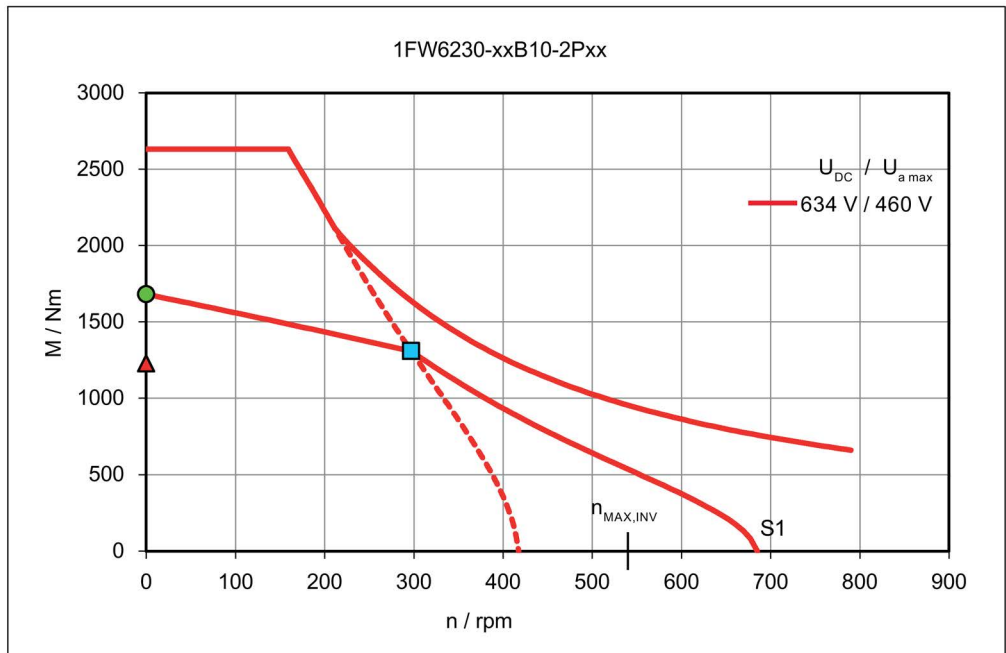

Short-circuit braking torque M_{Br} with respect to speed n

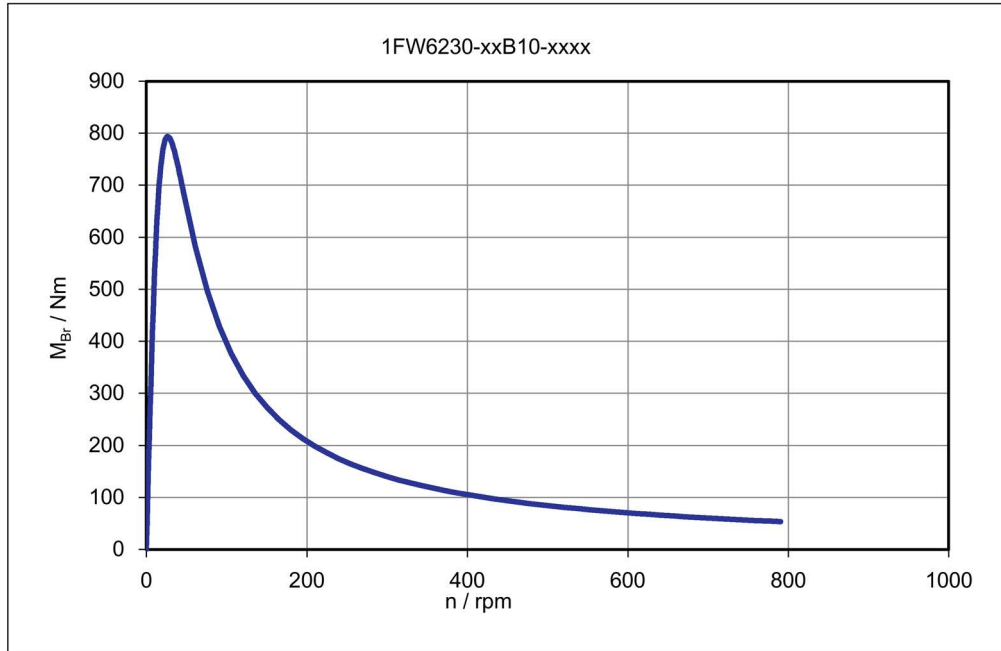

Main cooler and precision cooler - pressure losses Δp with respect to the flow rate \dot{V} (HK || PK: main cooler HK and precision cooler PK connected in parallel)

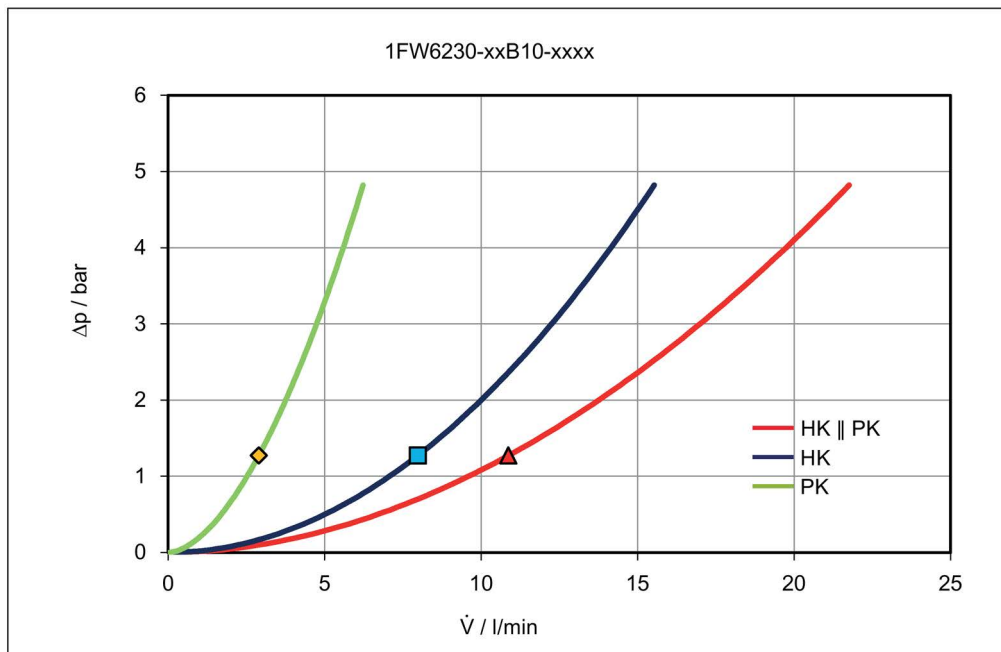

Rotor power loss P_{LV} with respect to speed n

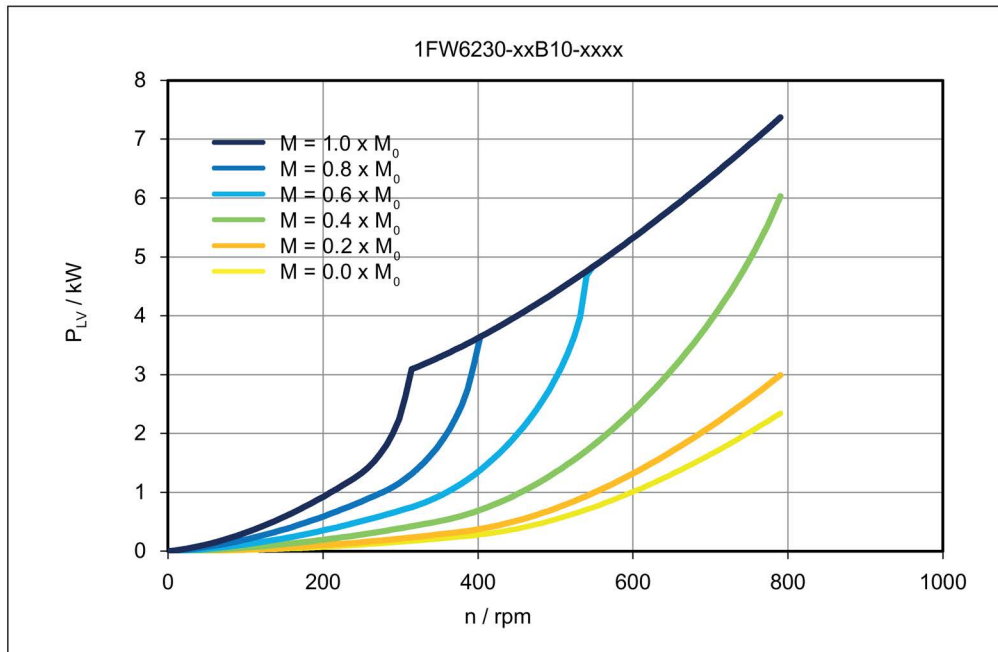

Data sheet 1FW6230-xxB15-xxxx

Table 6- 47 1FW6230-xxB15-4Cxx, 1FW6230-xxB15-5Gxx, 1FW6230-xxB15-8Fxx

Technical data	Symbol	Unit	-xxB15-4Cxx	-xxB15-5Gxx	-xxB15-8Fxx
1FW6230					
Boundary conditions					
DC link voltage	U_{DC}	V	600	600	600
Water cooling inlet temperature	T_{VORL}	°C	35	35	35
Rated temperature of winding	T_N	°C	130	130	130
Data at the rated operating point					
Rated torque	M_N	Nm	2450	2380	2320
Rated current	I_N	A	32.8	50.1	67.3
Rated speed	n_N	rpm	41.5	76.2	113
Rated power loss	$P_{V,N}$	kW	8.66	8.43	8.46
Limit data					
Maximum torque	M_{MAX}	Nm	3950	3950	3950
Maximum current	I_{MAX}	A	63.8	101	139
Electric motor power at M_{MAX}	$P_{EL,MAX}$	kW	38.3	47.1	56.4
Maximum speed	n_{MAX}	rpm	169	266	369
Maximum speed at maximum torque	$n_{MAX,M_{MAX}}$	rpm	18.5	41.8	64
Max. speed without VPM	$n_{MAX,INV}$	rpm	115	182	252
No-load speed	$n_{MAX,0}$	rpm	84.3	133	184
Torque at $n = 1$ rpm	M_0	Nm	2520	2520	2520
Current at M_0 and $n = 1$ rpm	I_0	A	33.9	53.4	74.2
Thermal static torque	M_0^*	Nm	1840	1840	1840
Thermal stall current	I_0^*	A	24	37.8	52.4
Physical constants					
Torque constant at 20 °C	$k_{T,20}$	Nm/A	79.1	50.2	36.2
Voltage constant	k_E	V/(1000/min)	4780	3030	2190
Motor constant at 20 °C	$k_{M,20}$	Nm/(W) ^{0.5}	34.5	35	34.9
Thermal time constant	t_{TH}	s	180	180	180
No. of pole pairs	p	-	49	49	49
Cogging torque	M_{COG}	Nm	12.6	12.6	12.6
Stator mass	m_s	kg	82.1	82.1	82.1
Rotor mass	m_L	kg	35.7	35.7	35.7
Rotor moment of inertia	J_L	10 ⁻² kgm ²	173	173	173
Phase resistance of winding at 20 °C	$R_{STR, 20}$	Ω	1.75	0.687	0.358
Phase inductance of winding	L_{STR}	mH	19.7	7.91	4.11
Data for main motor cooler *)					
Maximum dissipated thermal power	$Q_{H,MAX}$	kW	6.5	6.33	6.36
Recommended minimum volume flow	$\dot{V}_{H,MIN}$	l/min	10.5	10.5	10.5

6.2 Data sheets and diagrams

Technical data	Symbol	Unit	-xxB15-4Cxx	-xxB15-5Gxx	-xxB15-8Fxx
1FW6230					
Cooling medium temperature increase	ΔT_H	K	8.89	8.66	8.69
Pressure drop	Δp_H	bar	2.21	2.21	2.21
Data for precision motor cooler *)					
Maximum dissipated thermal power	$Q_{P,MAX}$	kW	0.701	0.683	0.686
Recommended minimum volume flow	$\dot{V}_{P,MIN}$	l/min	3.98	3.98	3.98
Cooling medium temperature increase	ΔT_P	K	2.53	2.47	2.48
Pressure drop	Δp_P	bar	2.21	2.21	2.21

*) Parallel connection of main and precision motor cooler

Table 6- 48 1FW6230-xxB15-2Pxx, 1FW6230-xxB15-0Wxx

Technical data	Symbol	Unit	-xxB15-2Pxx	-xxB15-0Wxx
1FW6230				
Boundary conditions				
DC link voltage	U_{DC}	V	600	600
Water cooling inlet temperature	T_{VORL}	°C	35	35
Rated temperature of winding	T_N	°C	130	130
Data at the rated operating point				
Rated torque	M_N	Nm	2210	2040
Rated current	I_N	A	91	117
Rated speed	n_N	rpm	172	258
Rated power loss	$P_{V,N}$	kW	8.67	8.46
Limit data				
Maximum torque	M_{MAX}	Nm	3950	3950
Maximum current	I_{MAX}	A	199	279
Electric motor power at M_{MAX}	$P_{EL,MAX}$	kW	70.8	88.3
Maximum speed	n_{MAX}	rpm	527	738
Maximum speed at maximum torque	$n_{MAX,MMAX}$	rpm	97.1	141
Max. speed without VPM	$n_{MAX,INV}$	rpm	360	504
No-load speed	$n_{MAX,0}$	rpm	263	369
Torque at $n = 1$ rpm	M_0	Nm	2520	2520
Current at M_0 and $n = 1$ rpm	I_0	A	106	148
Thermal static torque	M_0^*	Nm	1840	1840
Thermal stall current	I_0^*	A	74.9	105
Physical constants				
Torque constant at 20 °C	$k_{T,20}$	Nm/A	25.3	18.1
Voltage constant	k_E	V/(1000/min)	1530	1090
Motor constant at 20 °C	$k_{M,20}$	Nm/(W) ^{0.5}	34.5	34.9
Thermal time constant	t_{TH}	s	180	180
No. of pole pairs	p	-	49	49
Cogging torque	M_{COG}	Nm	12.6	12.6
Stator mass	m_s	kg	82.1	82.1
Rotor mass	m_L	kg	35.7	35.7
Rotor moment of inertia	J_L	10 ⁻² kgm ²	173	173
Phase resistance of winding at 20 °C	$R_{STR, 20}$	Ω	0.18	0.0895
Phase inductance of winding	L_{STR}	mH	2.01	1.03
Data for main motor cooler *)				
Maximum dissipated thermal power	$Q_{H,MAX}$	kW	6.51	6.36
Recommended minimum volume flow	$\dot{V}_{H,MIN}$	l/min	10.5	10.5
Cooling medium temperature increase	ΔT_H	K	8.9	8.69
Pressure drop	Δp_H	bar	2.21	2.21

Technical data	Symbol	Unit	-xxB15-2Pxx	-xxB15-0Wxx
1FW6230				
Data for precision motor cooler *)				
Maximum dissipated thermal power	$Q_{P,MAX}$	kW	0.702	0.686
Recommended minimum volume flow	$\dot{V}_{P,MIN}$	l/min	3.98	3.98
Cooling medium temperature increase	ΔT_P	K	2.54	2.48
Pressure drop	Δp_P	bar	2.21	2.21

*) Parallel connection of main and precision motor cooler

Characteristics for 1FW6230-xxB15-xxxx

Torque M with respect to speed n

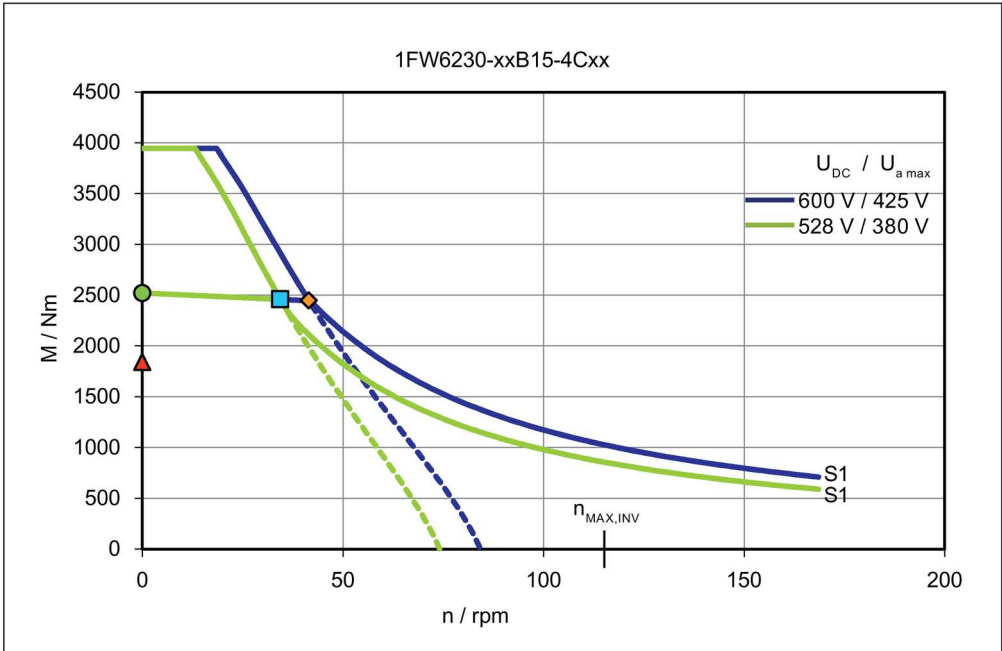

Torque M with respect to speed n

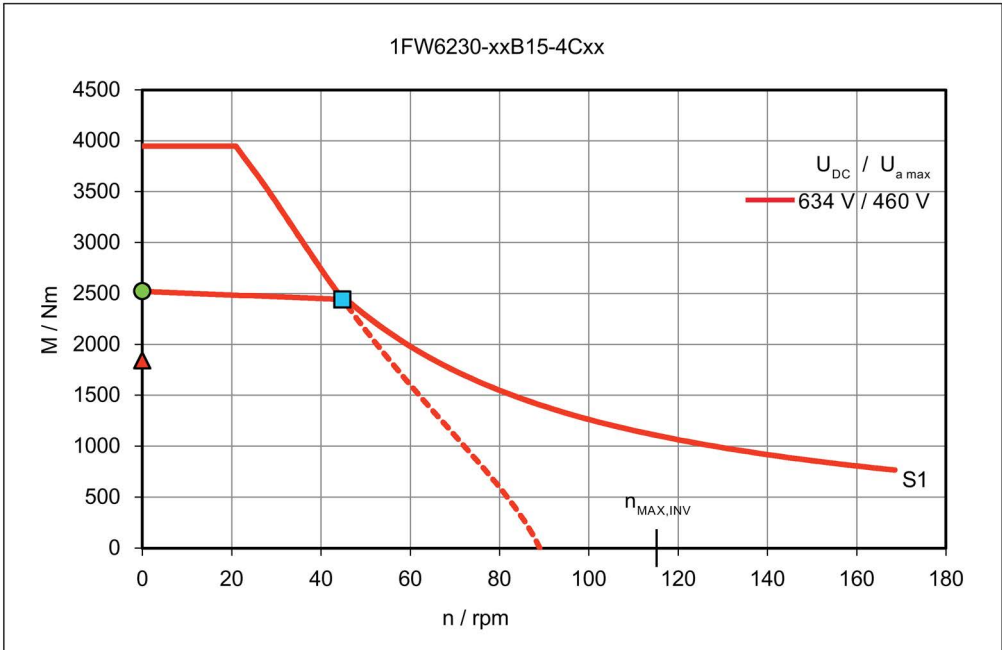

Torque M with respect to speed n

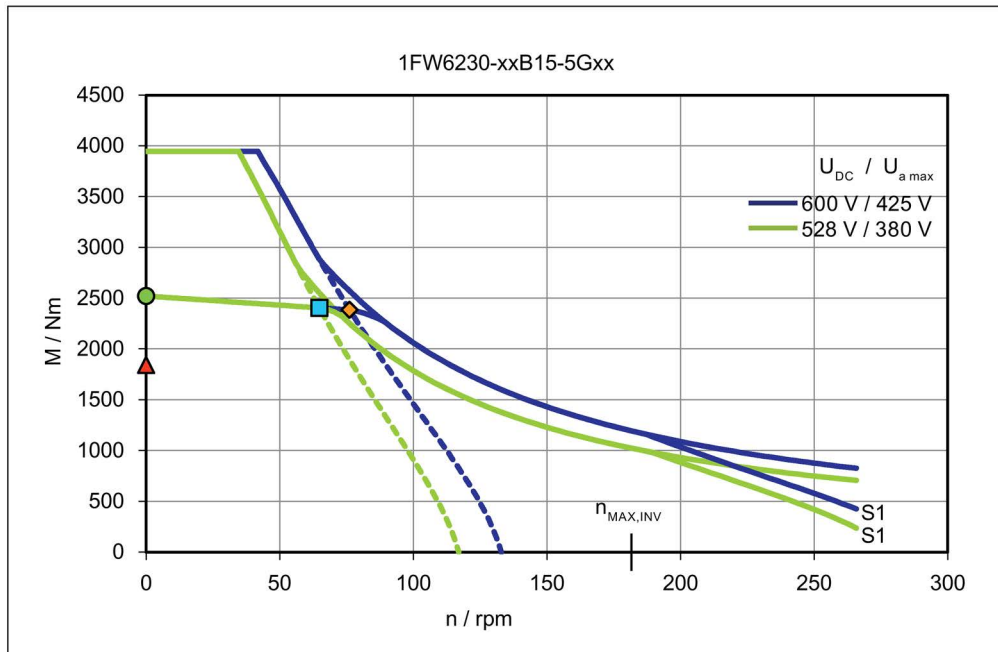

Torque M with respect to speed n

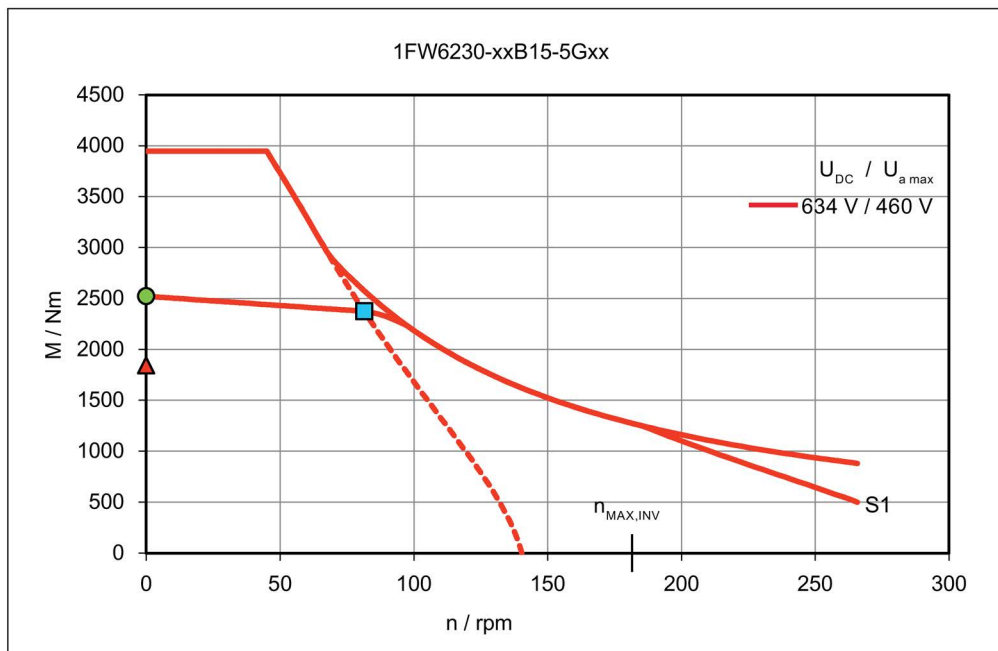

Torque M with respect to speed n

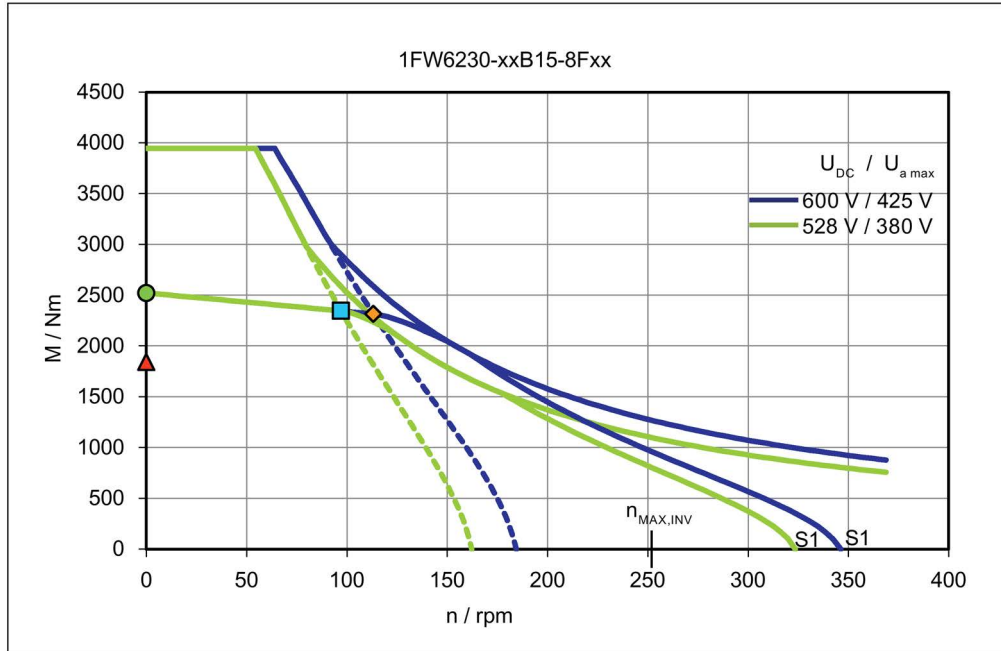

Torque M with respect to speed n

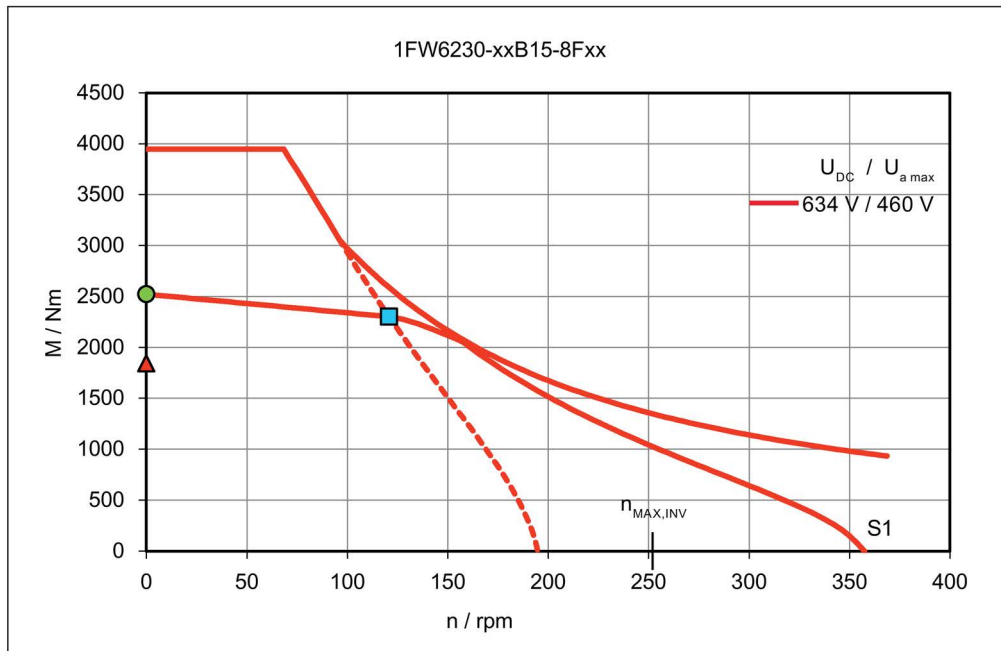

Torque M with respect to speed n

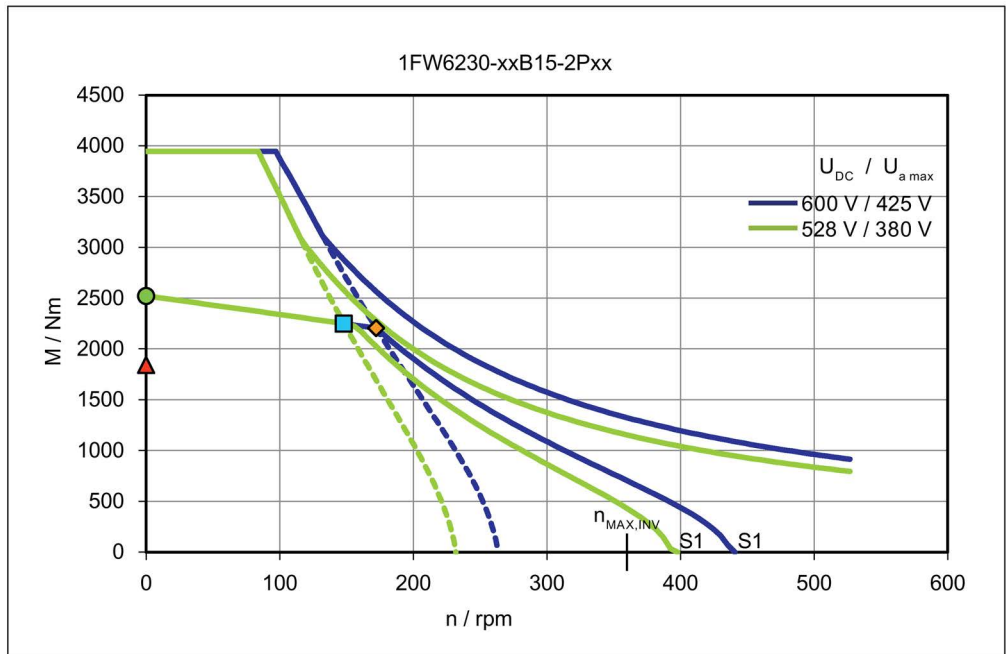

Torque M with respect to speed n

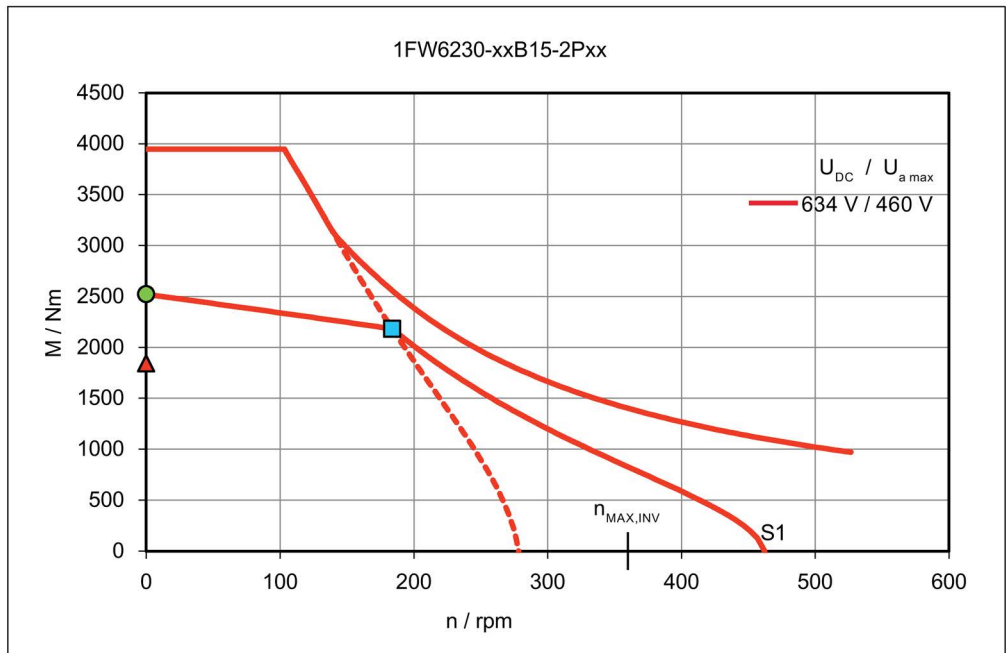

Torque M with respect to speed n

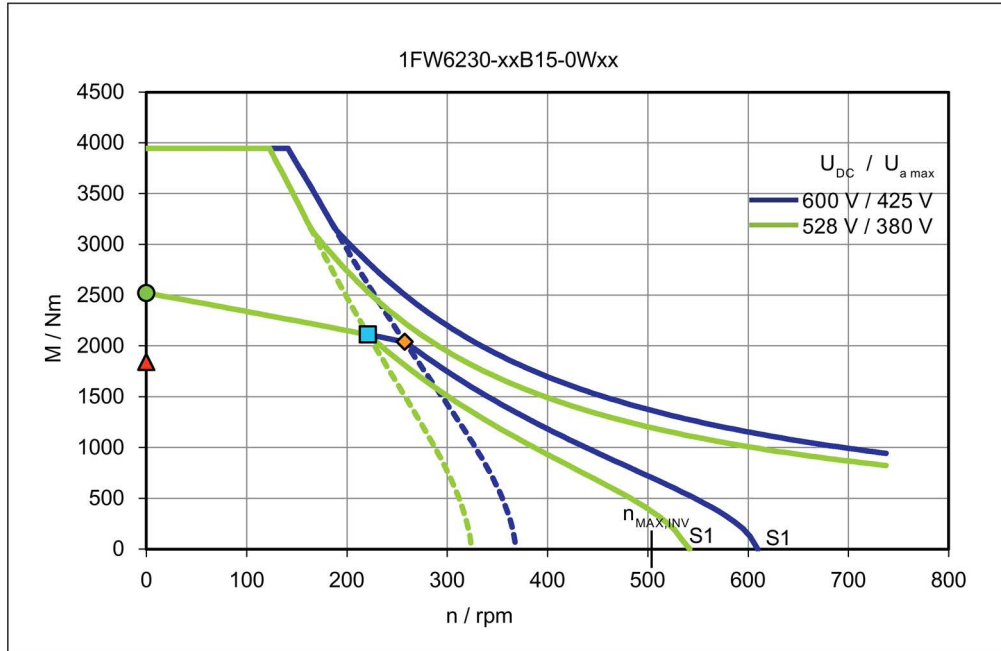

Torque M with respect to speed n

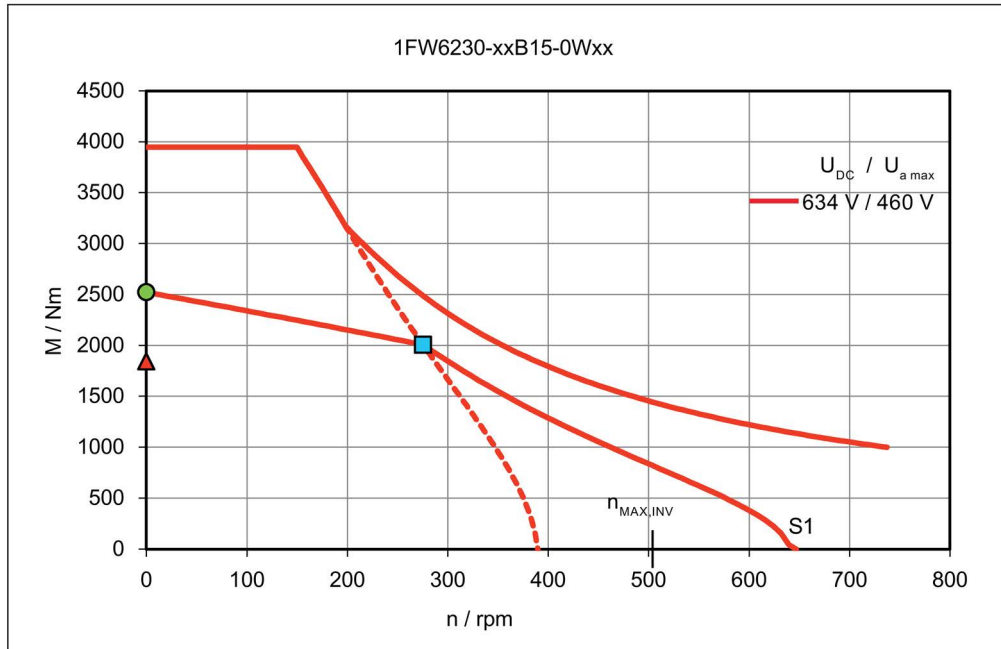

Short-circuit braking torque M_{Br} with respect to speed n

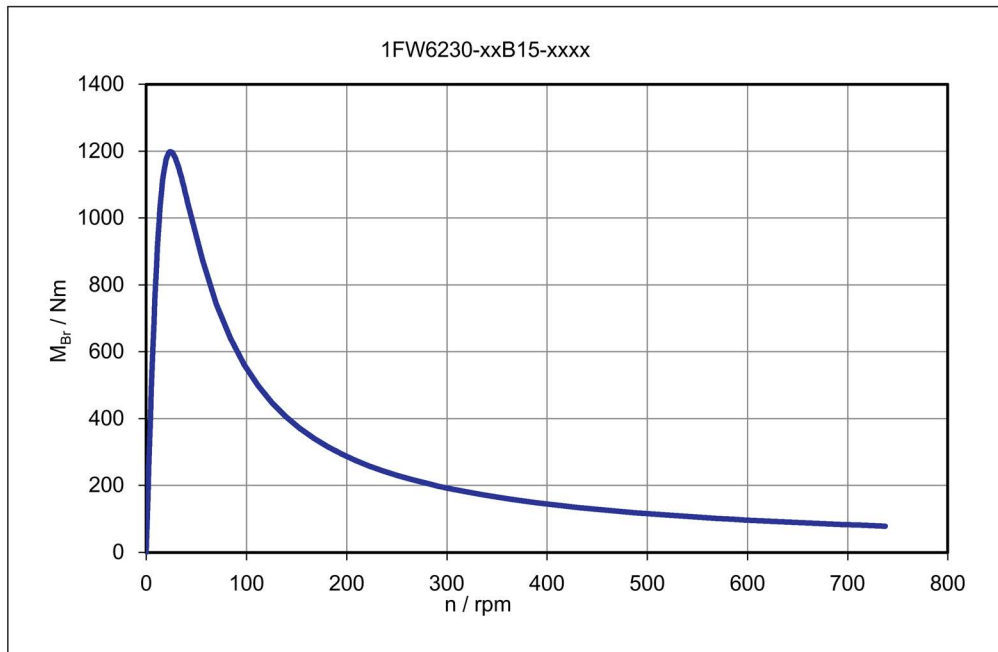

Main cooler and precision cooler - pressure losses Δp with respect to the flow rate \dot{V} (HK || PK: main cooler HK and precision cooler PK connected in parallel)

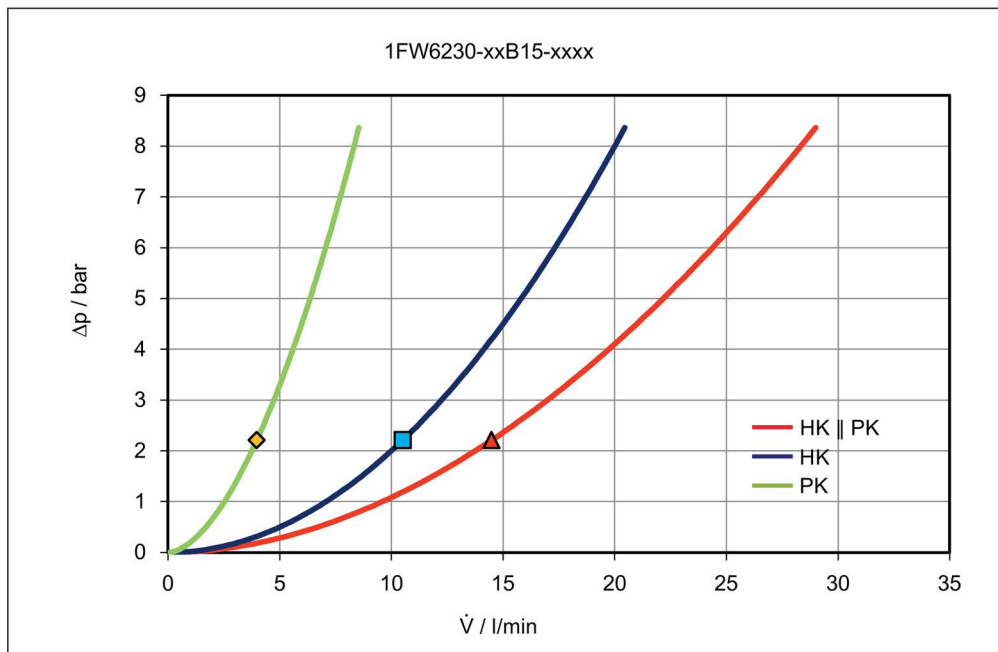

Rotor power loss P_{LV} with respect to speed n

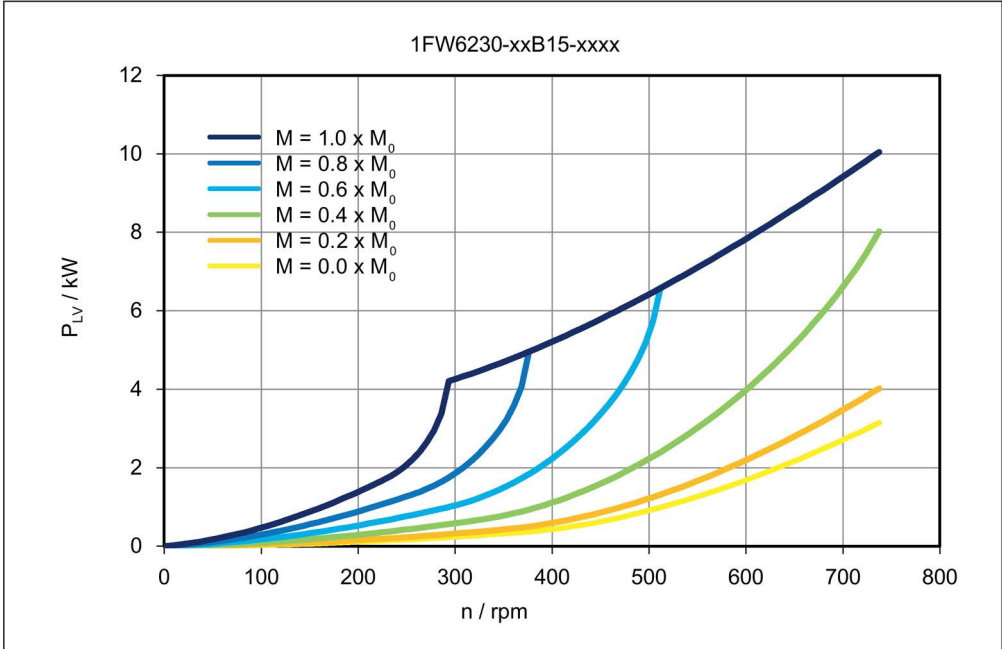

Data sheet 1FW6230-xxB20-xxxx

Table 6- 49 1FW6230-xxB20-5Gxx, 1FW6230-xxB20-8Fxx, 1FW6230-xxB20-2Pxx

Technical data	Symbol	Unit	-xxB20-5Gxx	-xxB20-8Fxx	-xxB20-2Pxx
1FW6230					
Boundary conditions					
DC link voltage	U_{DC}	V	600	600	600
Water cooling inlet temperature	T_{VORL}	°C	35	35	35
Rated temperature of winding	T_N	°C	130	130	130
Data at the rated operating point					
Rated torque	M_N	Nm	3230	3170	3060
Rated current	I_N	A	51.1	69.3	95.3
Rated speed	n_N	rpm	53.4	80.7	123
Rated power loss	$P_{V,N}$	kW	10.8	10.8	11.1
Limit data					
Maximum torque	M_{MAX}	Nm	5260	5260	5260
Maximum current	I_{MAX}	A	101	139	199
Electric motor power at M_{MAX}	$P_{EL,MAX}$	kW	53.3	63	77.9
Maximum speed	n_{MAX}	rpm	199	277	395
Maximum speed at maximum torque	$n_{MAX,MMAX}$	rpm	27.5	44.8	70
Max. speed without VPM	$n_{MAX,INV}$	rpm	136	189	270
No-load speed	$n_{MAX,0}$	rpm	99.7	138	198
Torque at $n = 1$ rpm	M_0	Nm	3360	3360	3360
Current at M_0 and $n = 1$ rpm	I_0	A	53.4	74.2	106
Thermal static torque	M_0^*	Nm	2460	2460	2460
Thermal stall current	I_0^*	A	37.8	52.4	74.9
Physical constants					
Torque constant at 20 °C	$k_{T,20}$	Nm/A	66.9	48.2	33.7
Voltage constant	k_E	V/(1000/min)	4040	2910	2040
Motor constant at 20 °C	$k_{M,20}$	Nm/(W) ^{0.5}	41.2	41.1	40.6
Thermal time constant	t_{TH}	s	180	180	180
No. of pole pairs	p	-	49	49	49
Cogging torque	M_{COG}	Nm	16.8	16.8	16.8
Stator mass	m_S	kg	107	107	107
Rotor mass	m_L	kg	47.1	47.1	47.1
Rotor moment of inertia	J_L	10 ⁻² kgm ²	228	228	228
Phase resistance of winding at 20 °C	$R_{STR, 20}$	Ω	0.879	0.459	0.23
Phase inductance of winding	L_{STR}	mH	10.5	5.46	2.68

Technical data	Symbol	Unit	-xxB20-5Gxx	-xxB20-8Fxx	-xxB20-2Pxx
1FW6230					
Data for main motor cooler *)					
Maximum dissipated thermal power	$Q_{H,MAX}$	kW	8.11	8.14	8.34
Recommended minimum volume flow	$\dot{V}_{H,MIN}$	l/min	13	13	13
Cooling medium temperature increase	ΔT_H	K	8.95	8.98	9.2
Pressure drop	Δp_H	bar	3.39	3.39	3.39
Data for precision motor cooler *)					
Maximum dissipated thermal power	$Q_{P,MAX}$	kW	0.874	0.878	0.899
Recommended minimum volume flow	$\dot{V}_{P,MIN}$	l/min	5.09	5.09	5.09
Cooling medium temperature increase	ΔT_P	K	2.47	2.48	2.54
Pressure drop	Δp_P	bar	3.39	3.39	3.39

*) Parallel connection of main and precision motor cooler

Table 6- 50 1FW6230-xxB20-0Wxx

Technical data	Symbol	Unit	-xxB20-0Wxx
1FW6230			
Boundary conditions			
DC link voltage	U_{DC}	V	600
Water cooling inlet temperature	T_{VORL}	°C	35
Rated temperature of winding	T_N	°C	130
Data at the rated operating point			
Rated torque	M_N	Nm	2910
Rated current	I_N	A	126
Rated speed	n_N	rpm	184
Rated power loss	$P_{V,N}$	kW	10.8
Limit data			
Maximum torque	M_{MAX}	Nm	5260
Maximum current	I_{MAX}	A	279
Electric motor power at M_{MAX}	$P_{EL,MAX}$	kW	95.5
Maximum speed	n_{MAX}	rpm	553
Maximum speed at maximum torque	$n_{MAX,MMAX}$	rpm	104
Max. speed without VPM	$n_{MAX,INV}$	rpm	378
No-load speed	$n_{MAX,0}$	rpm	277
Torque at $n = 1$ rpm	M_0	Nm	3360
Current at M_0 and $n = 1$ rpm	I_0	A	148
Thermal static torque	M_0^*	Nm	2460
Thermal stall current	I_0^*	A	105
Physical constants			
Torque constant at 20 °C	$k_{T,20}$	Nm/A	24.1
Voltage constant	k_E	V/(1000/min)	1460
Motor constant at 20 °C	$k_{M,20}$	Nm/(W) ^{0.5}	41.1
Thermal time constant	t_{TH}	s	180
No. of pole pairs	p	-	49
Cogging torque	M_{COG}	Nm	16.8
Stator mass	m_S	kg	107
Rotor mass	m_L	kg	47.1
Rotor moment of inertia	J_L	10 ⁻² kgm ²	228
Phase resistance of winding at 20 °C	$R_{STR,20}$	Ω	0.115
Phase inductance of winding	L_{STR}	mH	1.37
Data for main motor cooler *)			
Maximum dissipated thermal power	$Q_{H,MAX}$	kW	8.14
Recommended minimum volume flow	$\dot{V}_{H,MIN}$	l/min	13
Cooling medium temperature increase	ΔT_H	K	8.98
Pressure drop	Δp_H	bar	3.39

Technical data	Symbol	Unit	-xxB20-0Wxx
1FW6230			
Data for precision motor cooler *)			
Maximum dissipated thermal power	$Q_{P,MAX}$	kW	0.878
Recommended minimum volume flow	$\dot{V}_{P,MIN}$	l/min	5.09
Cooling medium temperature increase	ΔT_P	K	2.48
Pressure drop	Δp_P	bar	3.39

*) Parallel connection of main and precision motor cooler

Characteristics for 1FW6230-xxB20-xxxx

Torque M with respect to speed n

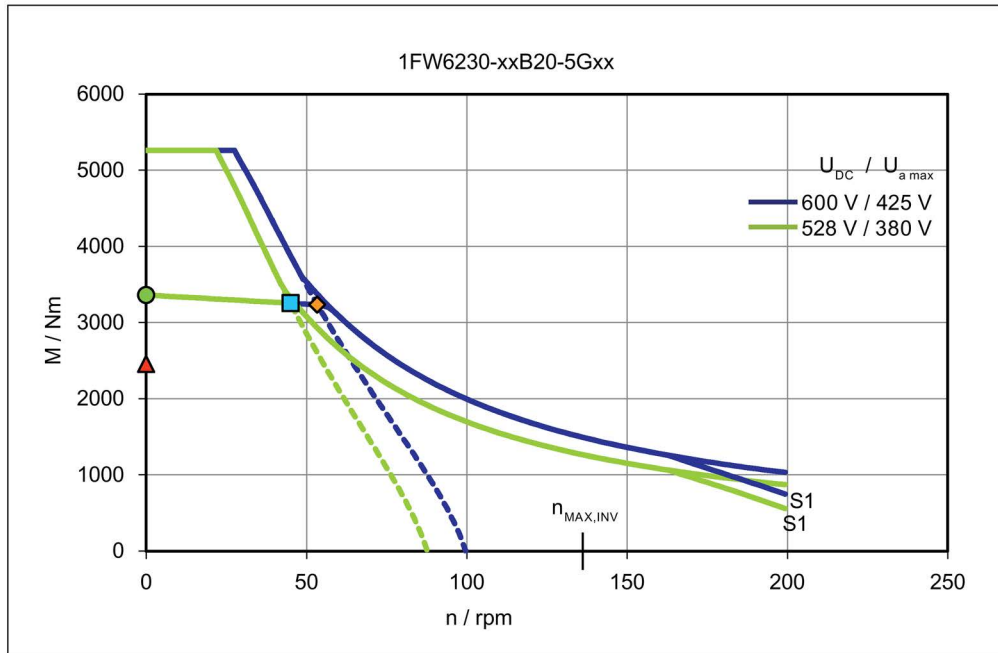

Torque M with respect to speed n

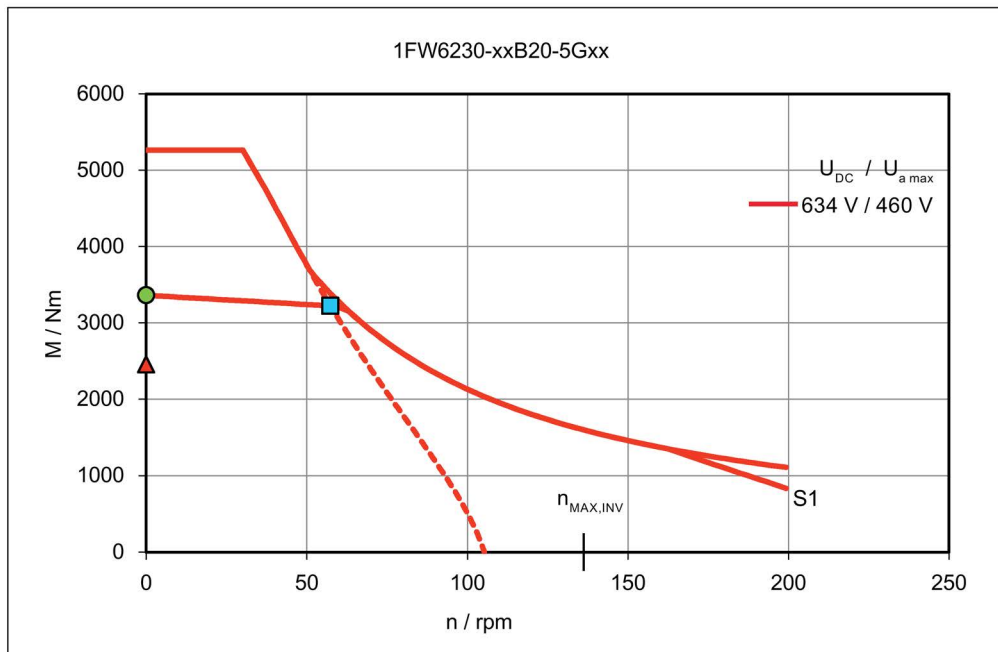

Torque M with respect to speed n

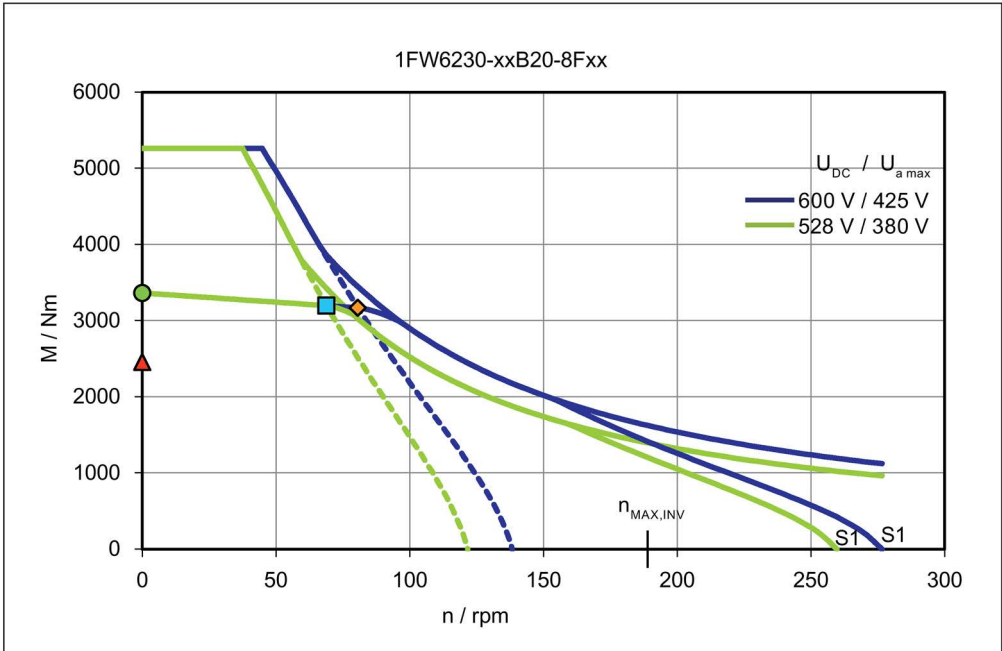

Torque M with respect to speed n

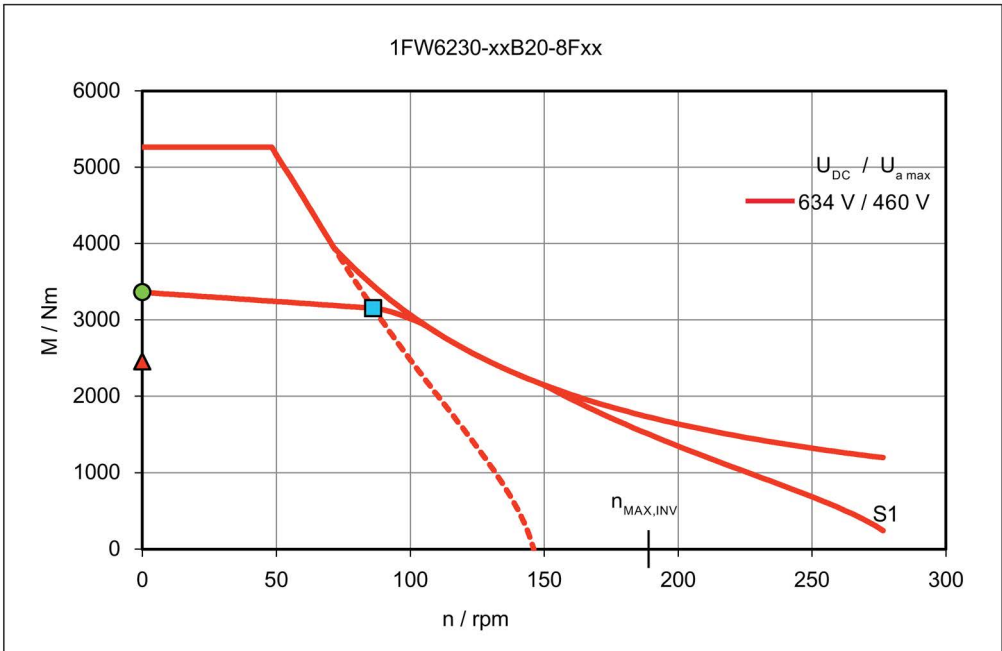

Torque M with respect to speed n

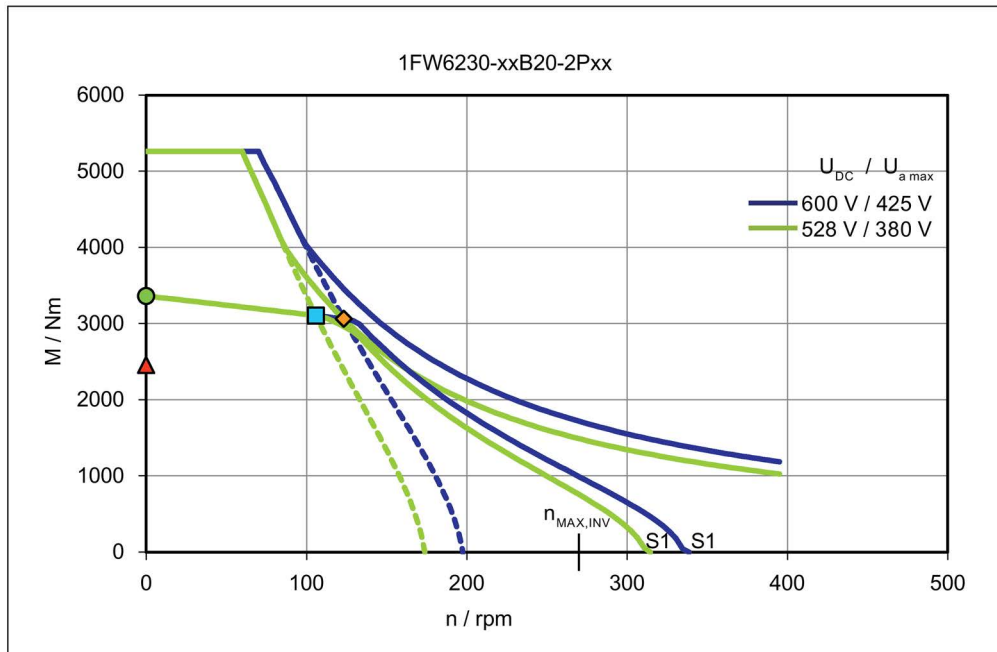

Torque M with respect to speed n

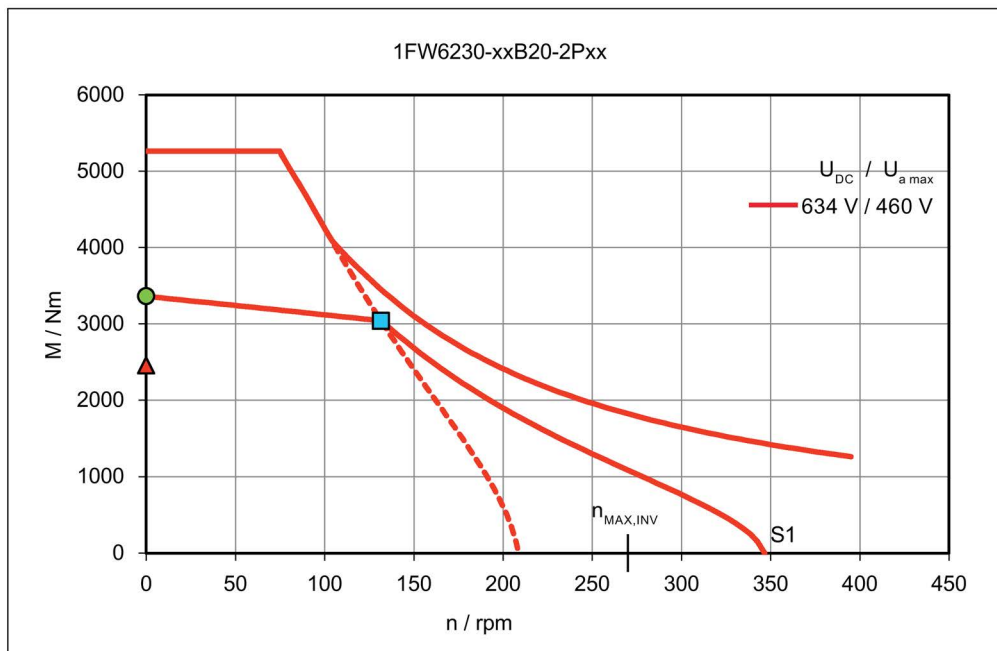

Torque M with respect to speed n

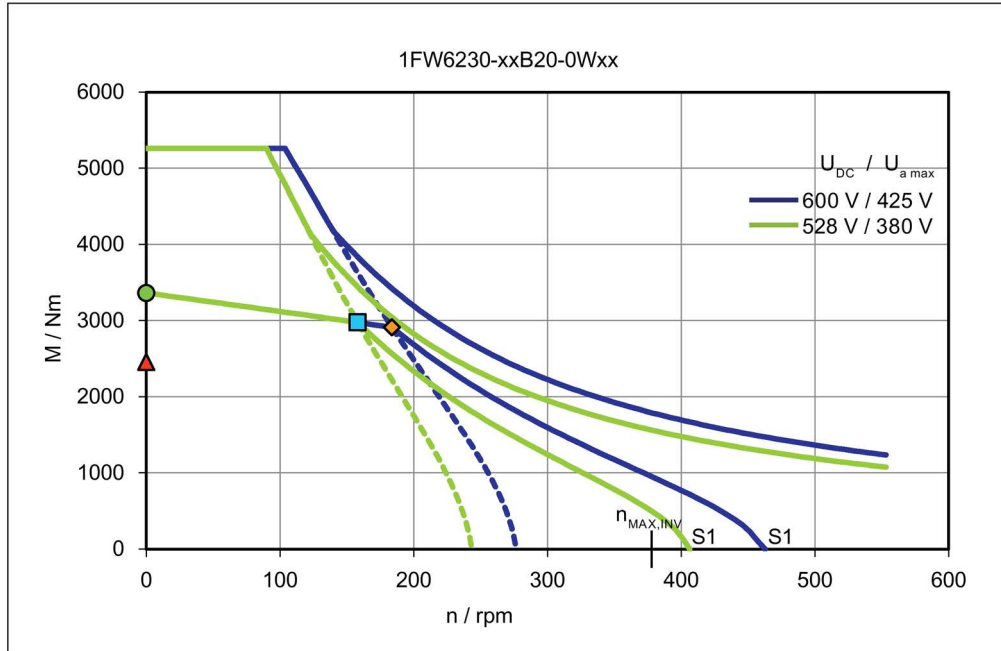

Torque M with respect to speed n

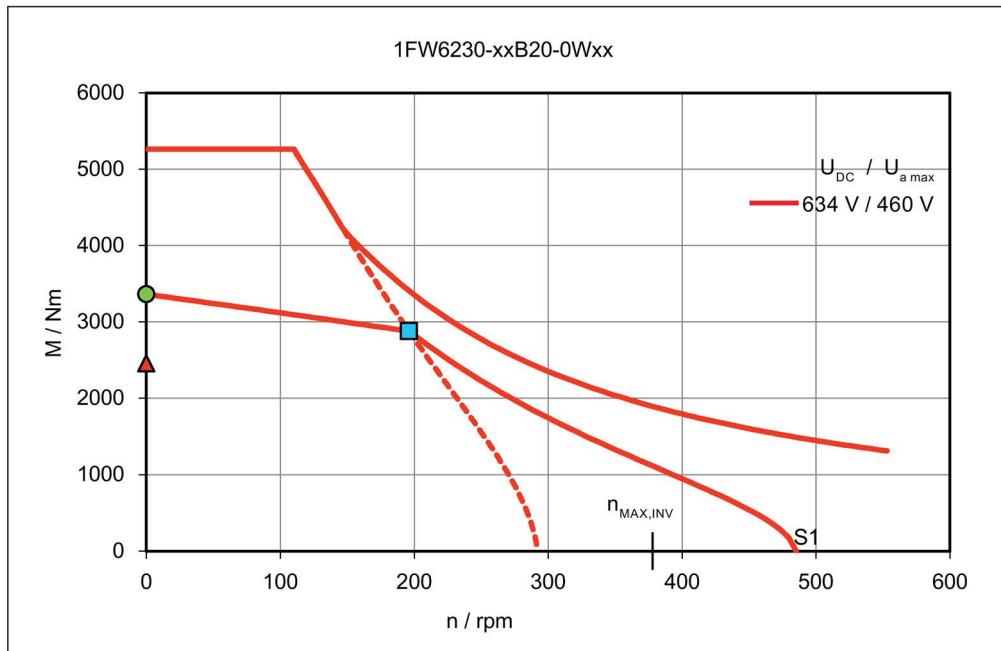

Short-circuit braking torque M_{Br} with respect to speed n

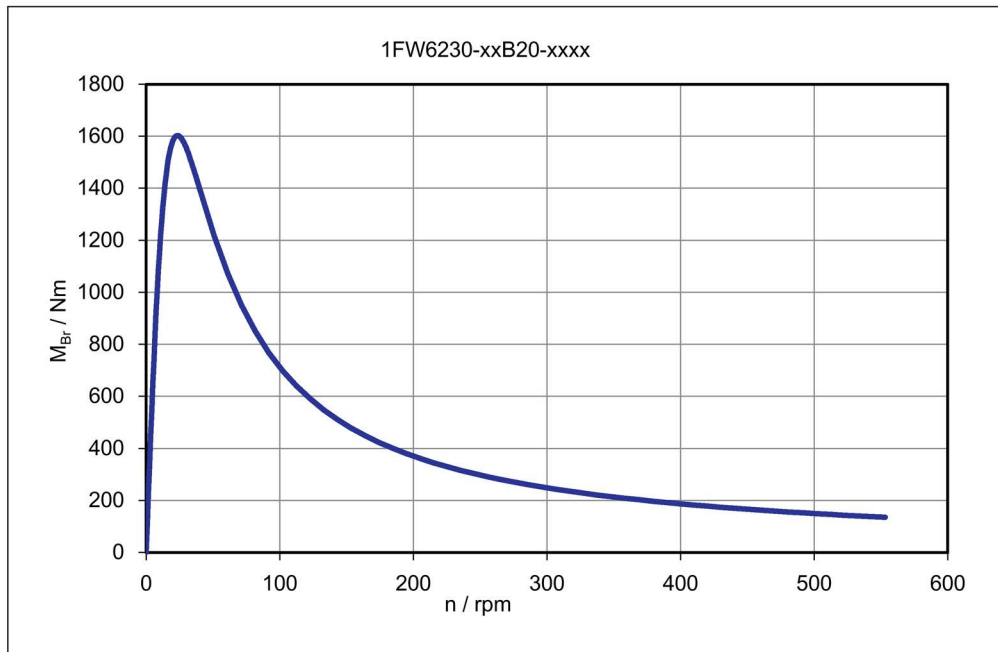

Main cooler and precision cooler - pressure losses Δp with respect to the flow rate \dot{V} (HK || PK: main cooler HK and precision cooler PK connected in parallel)

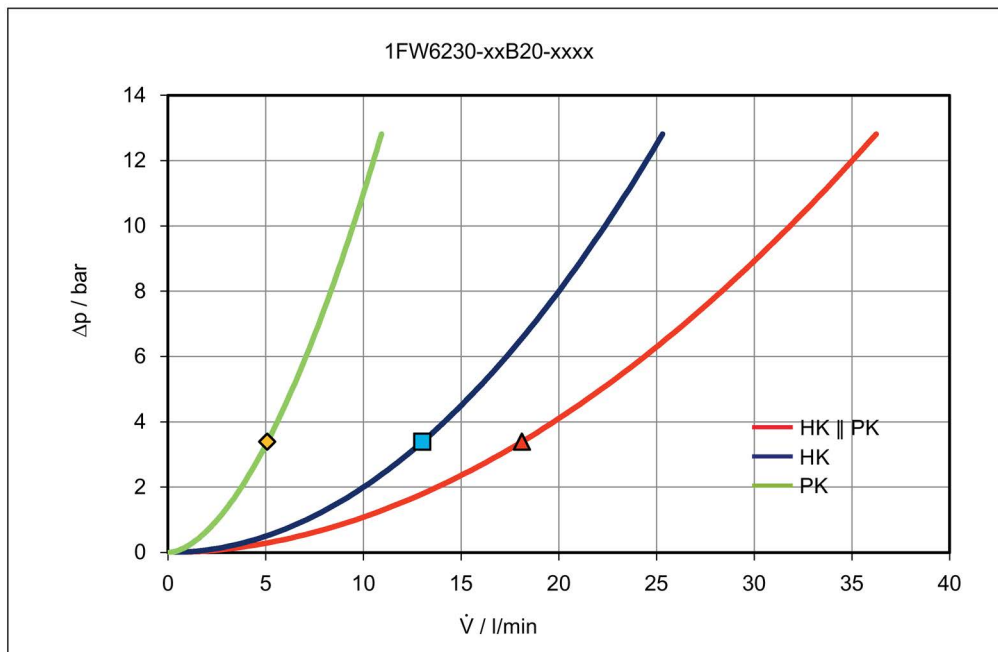

Rotor power loss P_{LV} with respect to speed n

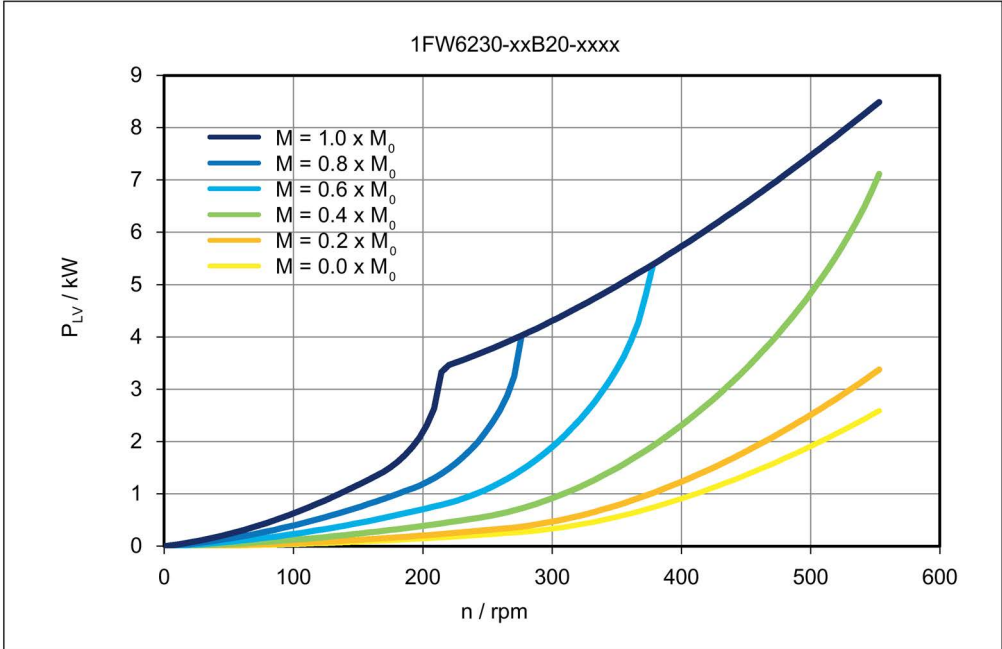

6.2.9 1FW6290-xxxxx-xxxx

Data sheet 1FW6290-xxB07-xxxx

Table 6- 51 1FW6290-xxB07-5Gxx, 1FW6290-xxB07-0Lxx, 1FW6290-xxB07-2Pxx

Technical data	Symbol	Unit	-xxB07-5Gxx	-xxB07-0Lxx	-xxB07-2Pxx
1FW6290					
Boundary conditions					
DC link voltage	U_{DC}	V	600	600	600
Water cooling inlet temperature	T_{VORL}	°C	35	35	35
Rated temperature of winding	T_N	°C	130	130	130
Data at the rated operating point					
Rated torque	M_N	Nm	2060	1920	1810
Rated current	I_N	A	52.3	86.2	105
Rated speed	n_N	rpm	106	204	272
Rated power loss	$P_{V,N}$	kW	5.15	5.14	5.18
Limit data					
Maximum torque	M_{MAX}	Nm	4000	4000	4000
Maximum current	I_{MAX}	A	119	212	272
Electric motor power at M_{MAX}	$P_{EL,MAX}$	kW	46.9	68.9	83.2
Maximum speed	n_{MAX}	rpm	325	578	741
Maximum speed at maximum torque	$n_{MAX,MMAX}$	rpm	57.5	110	144
Max. speed without VPM	$n_{MAX,INV}$	rpm	222	395	506
No-load speed	$n_{MAX,0}$	rpm	162	289	371
Torque at $n = 1$ rpm	M_0	Nm	2220	2220	2220
Current at M_0 and $n = 1$ rpm	I_0	A	56.5	101	129
Thermal static torque	M_0^*	Nm	1590	1590	1590
Thermal stall current	I_0^*	A	40	71.1	91.3
Physical constants					
Torque constant at 20 °C	$k_{T,20}$	Nm/A	39.8	22.4	17.4
Voltage constant	k_E	V/(1000/min)	2400	1350	1050
Motor constant at 20 °C	$k_{M,20}$	Nm/(W) ^{0.5}	37.5	37.6	37.4
Thermal time constant	t_{TH}	s	180	180	180
No. of pole pairs	p	-	42	42	42
Cogging torque	M_{COG}	Nm	11.1	11.1	11.1
Stator mass	m_S	kg	72.6	72.6	72.6
Rotor mass	m_L	kg	31	31	31
Rotor moment of inertia	J_L	10 ⁻² kgm ²	228	228	228
Phase resistance of winding at 20 °C	$R_{STR, 20}$	Ω	0.375	0.118	0.0724
Phase inductance of winding	L_{STR}	mH	6.42	2.03	1.23

Technical data	Symbol	Unit	-xxB07-5Gxx	-xxB07-0Lxx	-xxB07-2Pxx
1FW6290					
Data for main motor cooler *)					
Maximum dissipated thermal power	$Q_{H,MAX}$	kW	3.87	3.86	3.89
Recommended minimum volume flow	$\dot{V}_{H,MIN}$	l/min	5.78	5.78	5.78
Cooling medium temperature increase	ΔT_H	K	9.63	9.6	9.68
Pressure drop	Δp_H	bar	0.358	0.358	0.358
Data for precision motor cooler *)					
Maximum dissipated thermal power	$Q_{P,MAX}$	kW	0.417	0.416	0.42
Recommended minimum volume flow	$\dot{V}_{P,MIN}$	l/min	2.22	2.22	2.22
Cooling medium temperature increase	ΔT_P	K	2.7	2.69	2.72
Pressure drop	Δp_P	bar	0.358	0.358	0.358

*) Parallel connection of main and precision motor cooler

Characteristics for 1FW6290-xxB07-xxxx

Torque M with respect to speed n

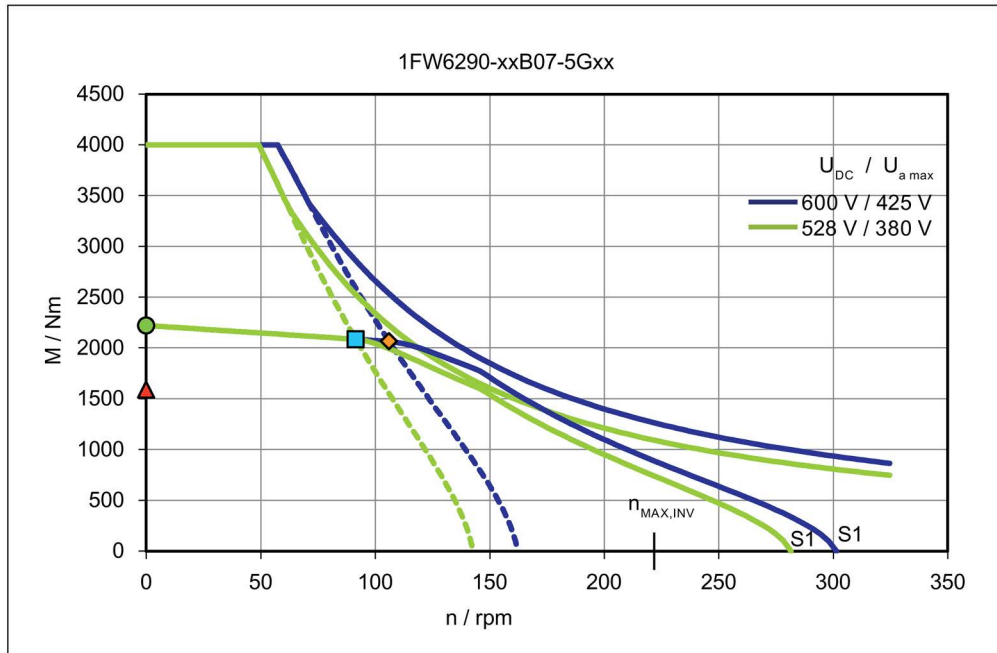

Torque M with respect to speed n

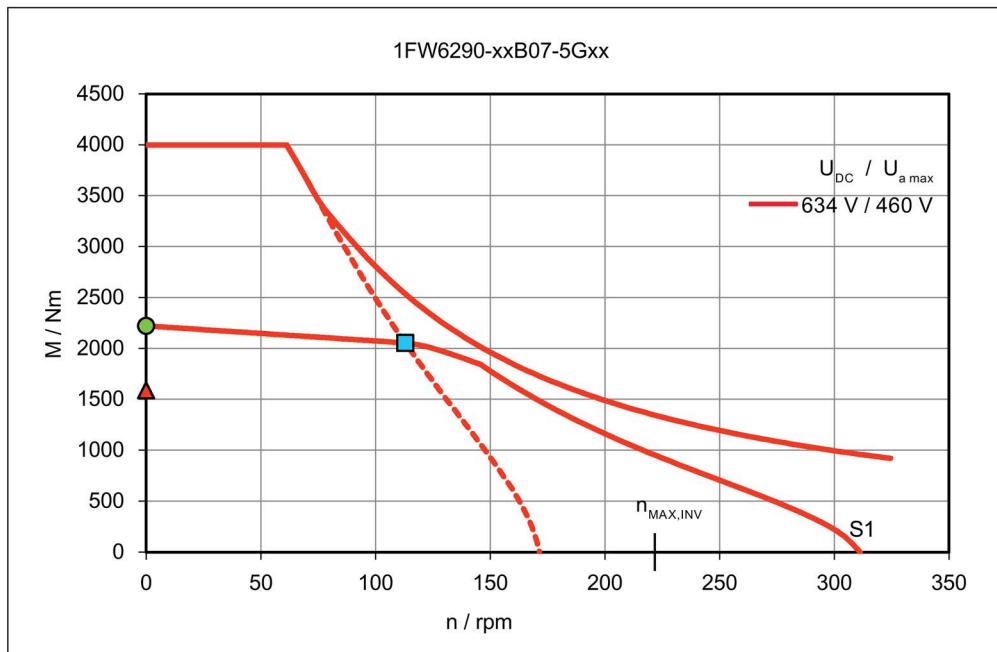

Torque M with respect to speed n

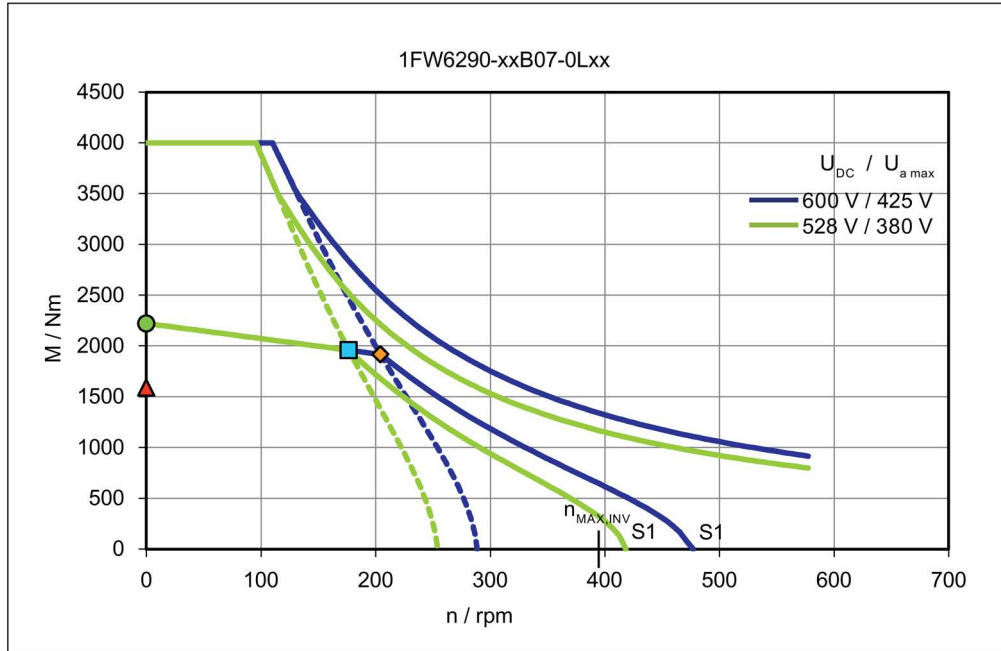

Torque M with respect to speed n

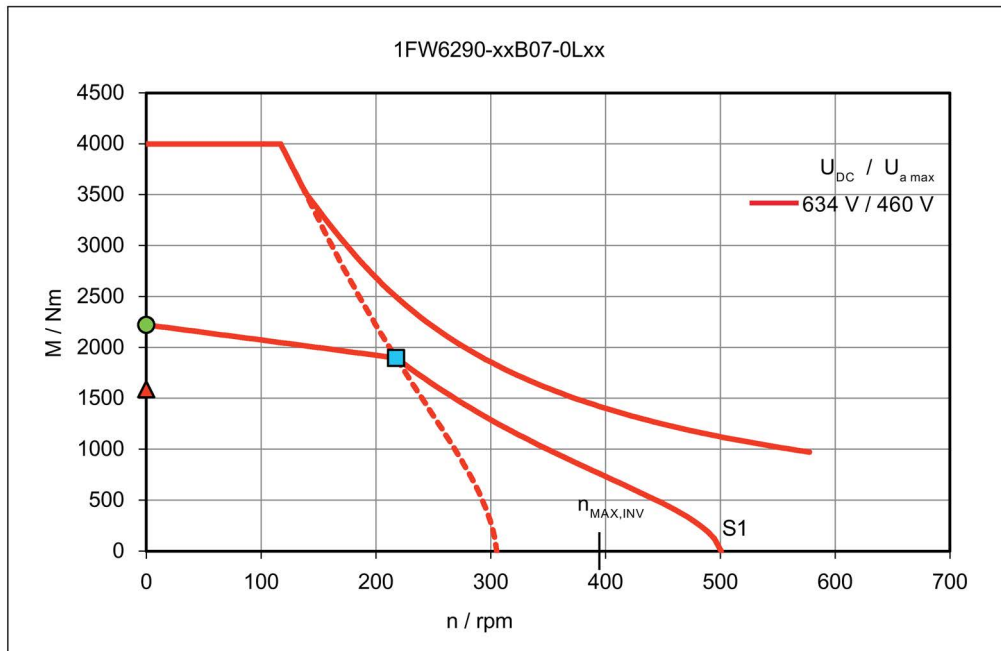

Torque M with respect to speed n

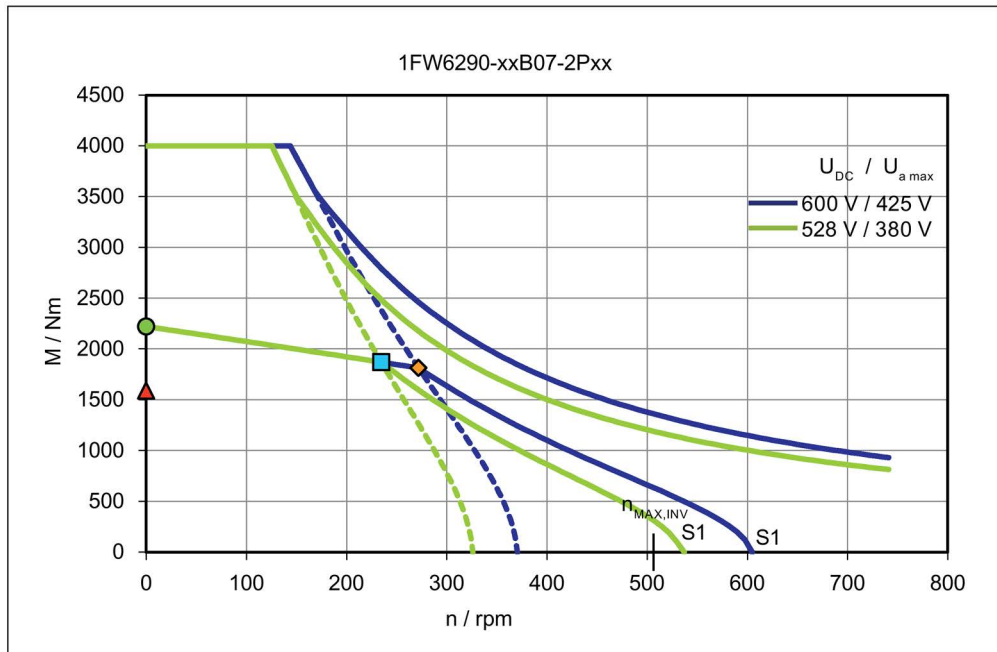

Torque M with respect to speed n

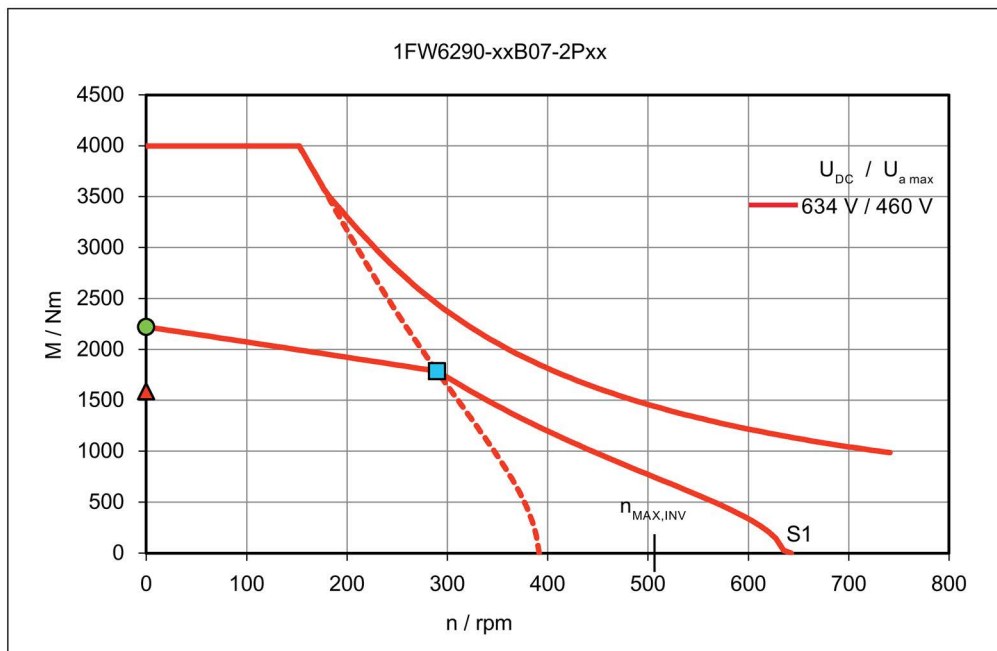

Short-circuit braking torque M_{Br} with respect to speed n

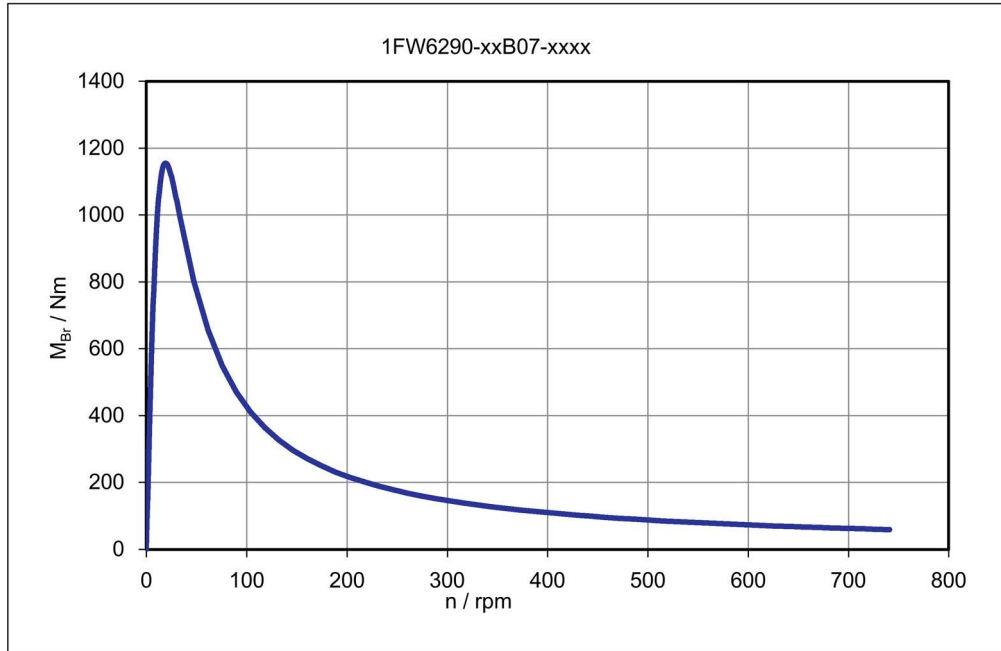

Main cooler and precision cooler - pressure losses Δp with respect to the flow rate \dot{V} (HK || PK: main cooler HK and precision cooler PK connected in parallel)

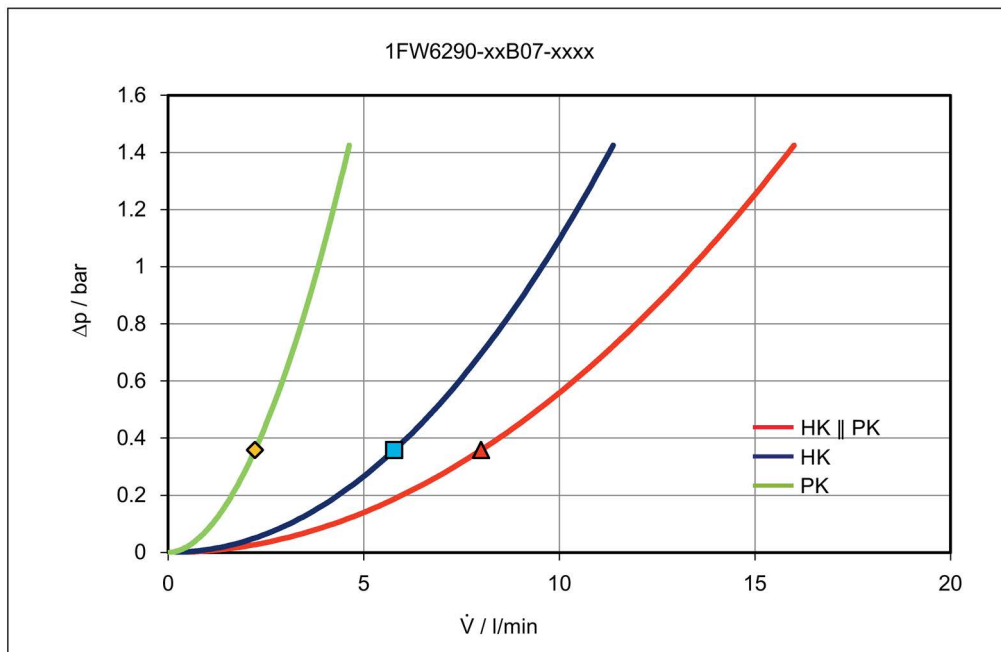

Rotor power loss P_{LV} with respect to speed n

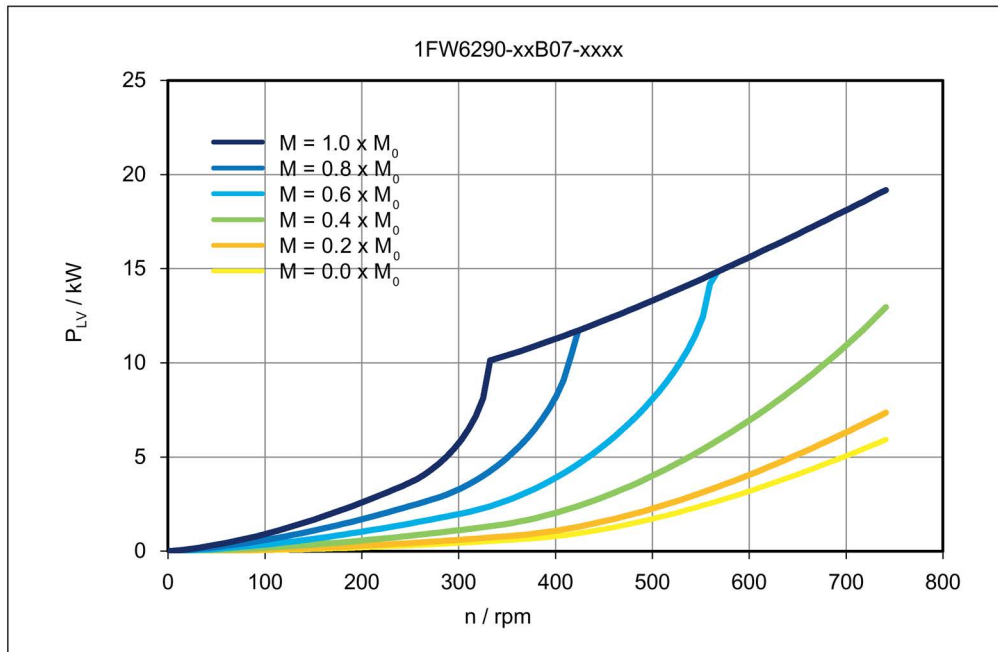

Data sheet 1FW6290-xxB11-xxxx

Table 6- 52 1FW6290-xxB11-7Axx, 1FW6290-xxB11-0Lxx, 1FW6290-xxB11-2Pxx

Technical data	Symbol	Unit	-xxB11-7Axx	-xxB11-0Lxx	-xxB11-2Pxx
1FW6290					
Boundary conditions					
DC link voltage	U_{DC}	V	600	600	600
Water cooling inlet temperature	T_{VORL}	°C	35	35	35
Rated temperature of winding	T_N	°C	130	130	130
Data at the rated operating point					
Rated torque	M_N	Nm	3320	3200	3110
Rated current	I_N	A	59.8	91.8	114
Rated speed	n_N	rpm	72.9	125	165
Rated power loss	$P_{V,N}$	kW	7.09	7.1	7.15
Limit data					
Maximum torque	M_{MAX}	Nm	6280	6280	6280
Maximum current	I_{MAX}	A	133	212	272
Electric motor power at M_{MAX}	$P_{EL,MAX}$	kW	57.3	76.6	91.2
Maximum speed	n_{MAX}	rpm	230	368	472
Maximum speed at maximum torque	$n_{MAX,MMAX}$	rpm	39.3	68.6	90.4
Max. speed without VPM	$n_{MAX,INV}$	rpm	157	251	322
No-load speed	$n_{MAX,0}$	rpm	115	184	236
Torque at $n = 1$ rpm	M_0	Nm	3490	3490	3490
Current at M_0 and $n = 1$ rpm	I_0	A	63	101	129
Thermal static torque	M_0^*	Nm	2500	2500	2500
Thermal stall current	I_0^*	A	44.5	71.1	91.3
Physical constants					
Torque constant at 20 °C	$k_{T,20}$	Nm/A	56.1	35.1	27.4
Voltage constant	k_E	V/(1000/min)	3390	2120	1660
Motor constant at 20 °C	$k_{M,20}$	Nm/(W) ^{0.5}	50.2	50.2	50
Thermal time constant	t_{TH}	s	180	180	180
No. of pole pairs	p	-	42	42	42
Cogging torque	M_{COG}	Nm	17.5	17.5	17.5
Stator mass	m_s	kg	114	114	114
Rotor mass	m_L	kg	45	45	45
Rotor moment of inertia	J_L	10 ⁻² kgm ²	334	334	334
Phase resistance of winding at 20 °C	$R_{STR, 20}$	Ω	0.416	0.163	0.0998
Phase inductance of winding	L_{STR}	mH	8	3.14	1.9

Technical data	Symbol	Unit	-xxB11-7Axx	-xxB11-0Lxx	-xxB11-2Pxx
1FW6290					
Data for main motor cooler *)					
Maximum dissipated thermal power	$Q_{H,MAX}$	kW	5.33	5.33	5.37
Recommended minimum volume flow	$\dot{V}_{H,MIN}$	l/min	12.8	12.8	12.8
Cooling medium temperature increase	ΔT_H	K	6.01	6.01	6.05
Pressure drop	Δp_H	bar	1.8	1.8	1.8
Data for precision motor cooler *)					
Maximum dissipated thermal power	$Q_{P,MAX}$	kW	0.575	0.575	0.579
Recommended minimum volume flow	$\dot{V}_{P,MIN}$	l/min	5.24	5.24	5.24
Cooling medium temperature increase	ΔT_P	K	1.58	1.58	1.59
Pressure drop	Δp_P	bar	1.8	1.8	1.8

*) Parallel connection of main and precision motor cooler

Characteristics for 1FW6290-xxB11-xxxx

Torque M with respect to speed n

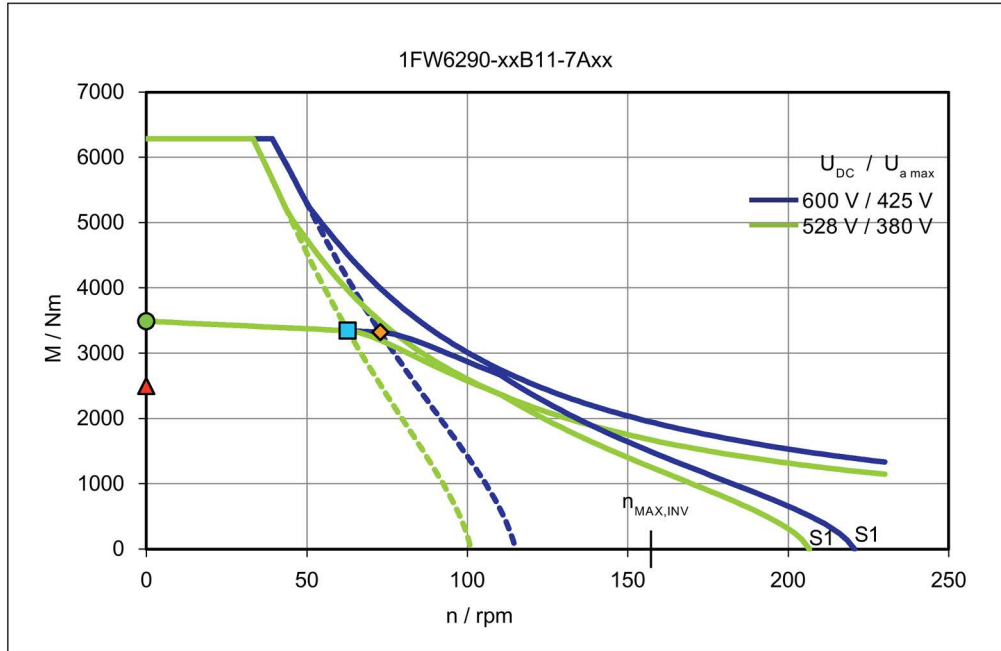

Torque M with respect to speed n

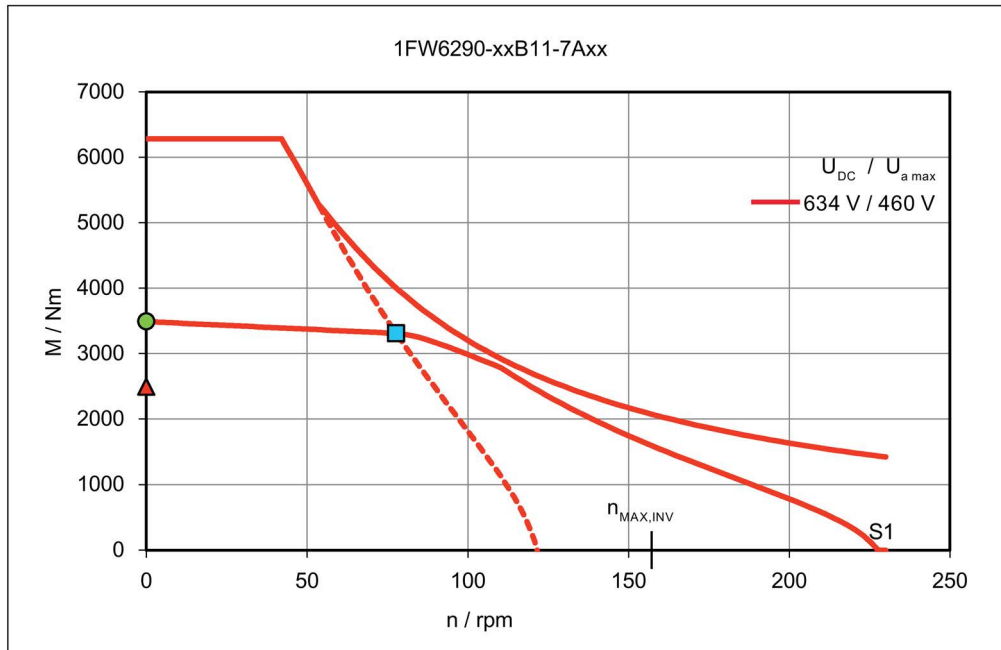

Torque M with respect to speed n

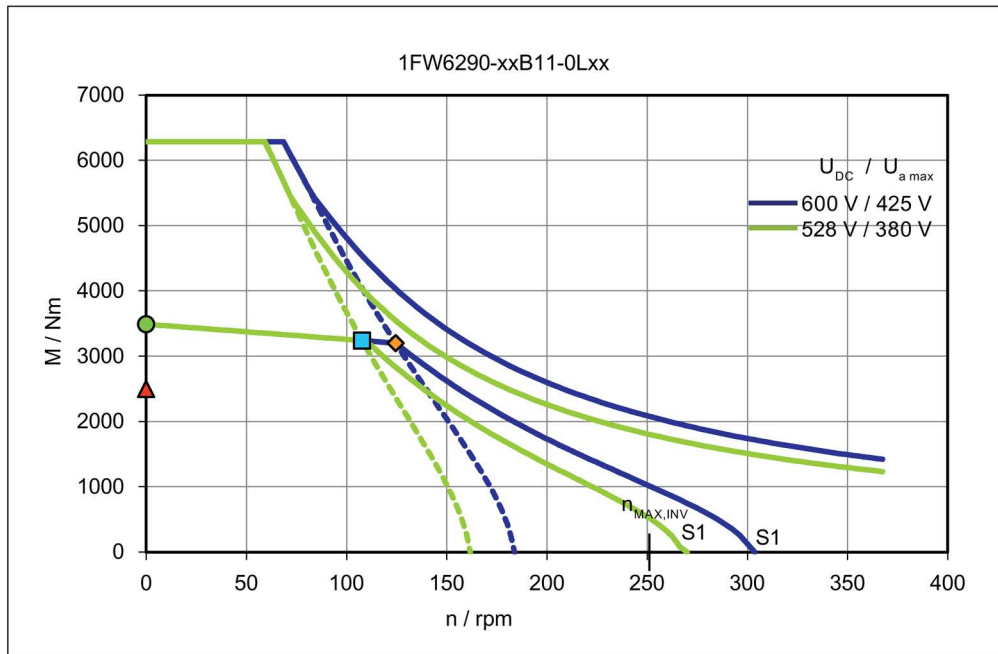

Torque M with respect to speed n

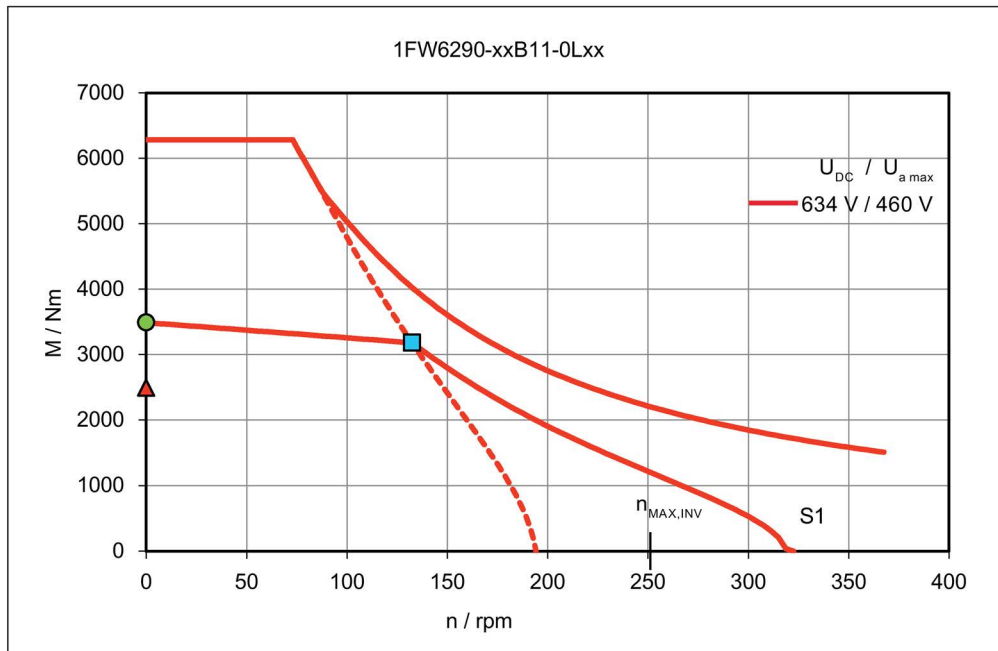

Torque M with respect to speed n

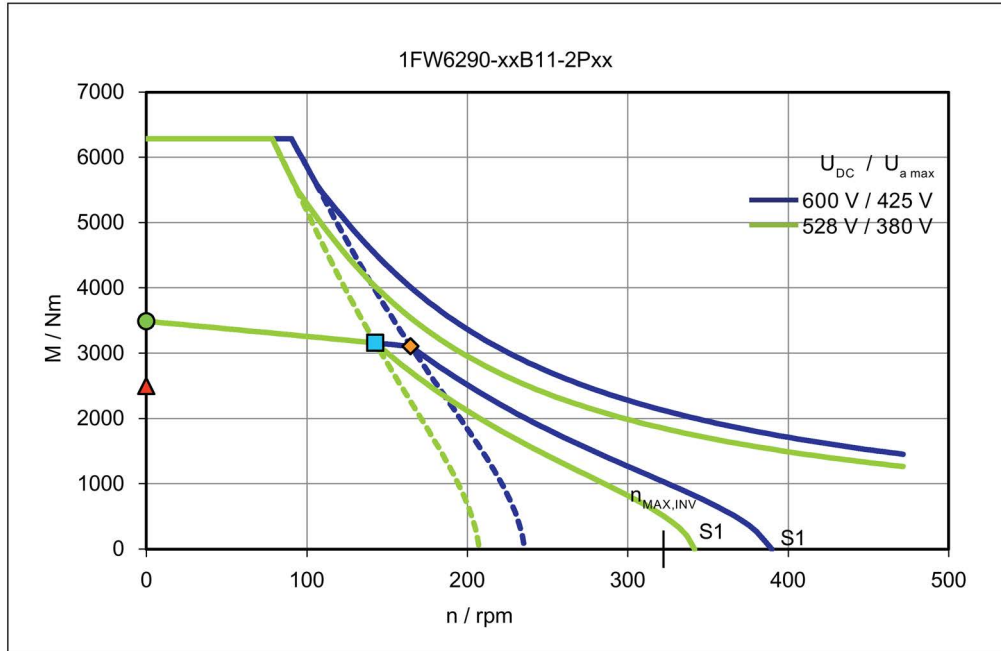

Torque M with respect to speed n

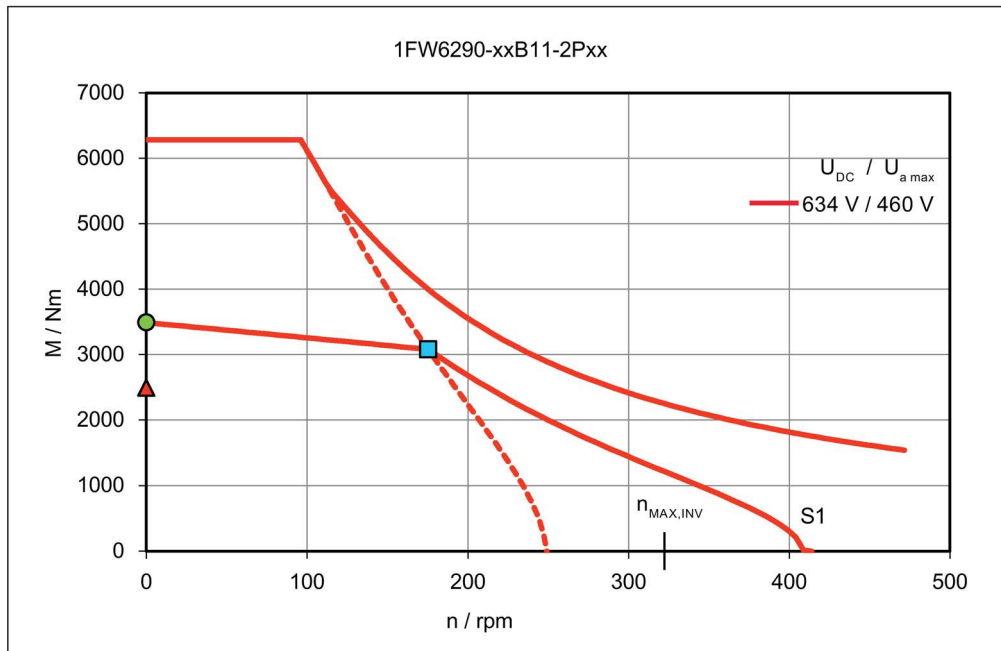

Short-circuit braking torque M_{Br} with respect to speed n

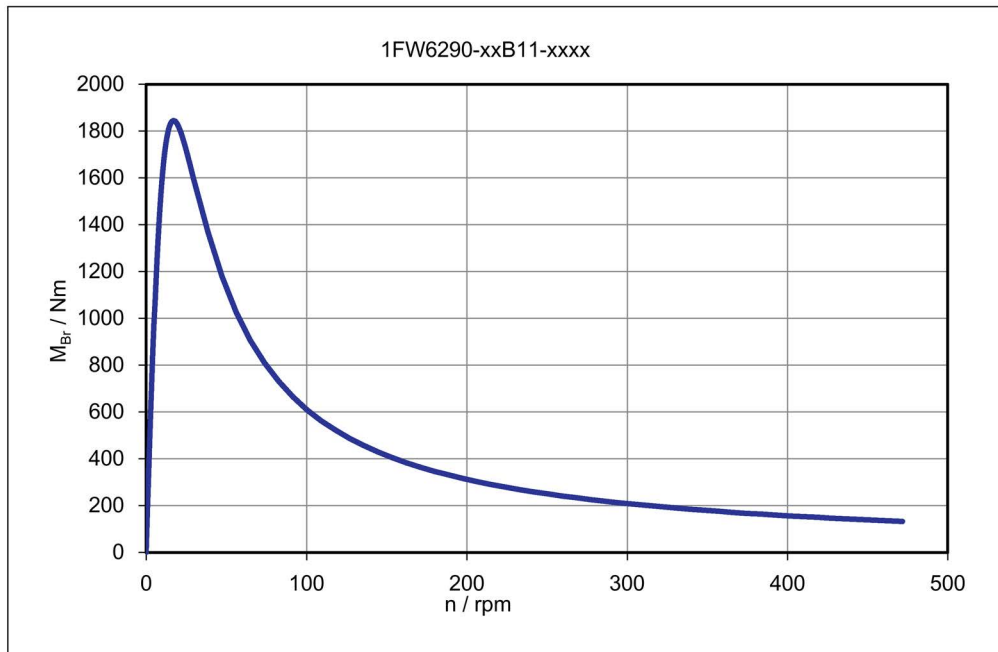

Main cooler and precision cooler - pressure losses Δp with respect to the flow rate \dot{V} (HK || PK: main cooler HK and precision cooler PK connected in parallel)

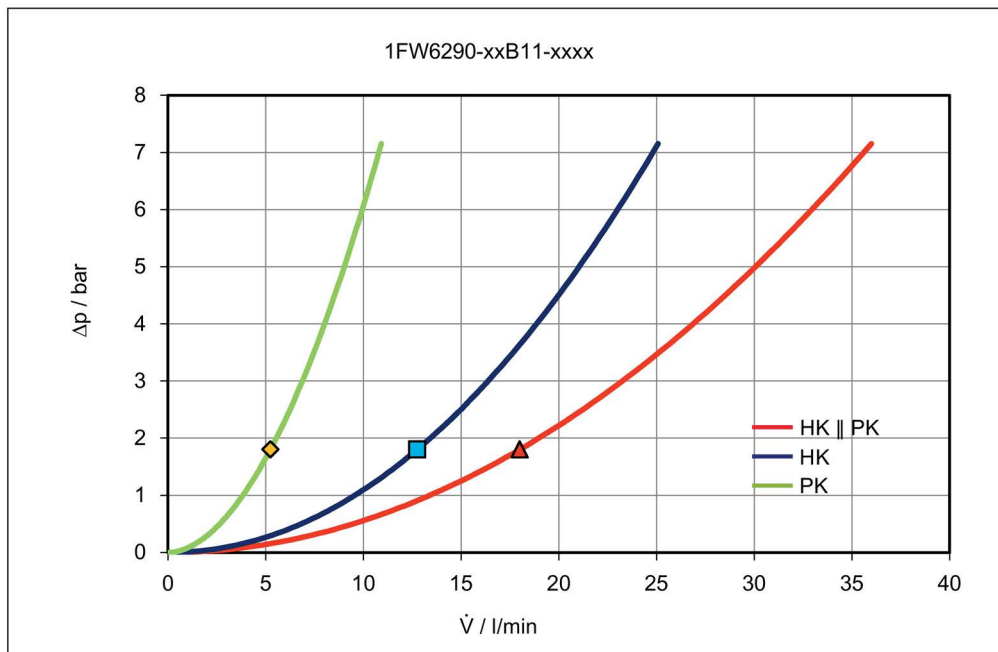

Rotor power loss P_{LV} with respect to speed n

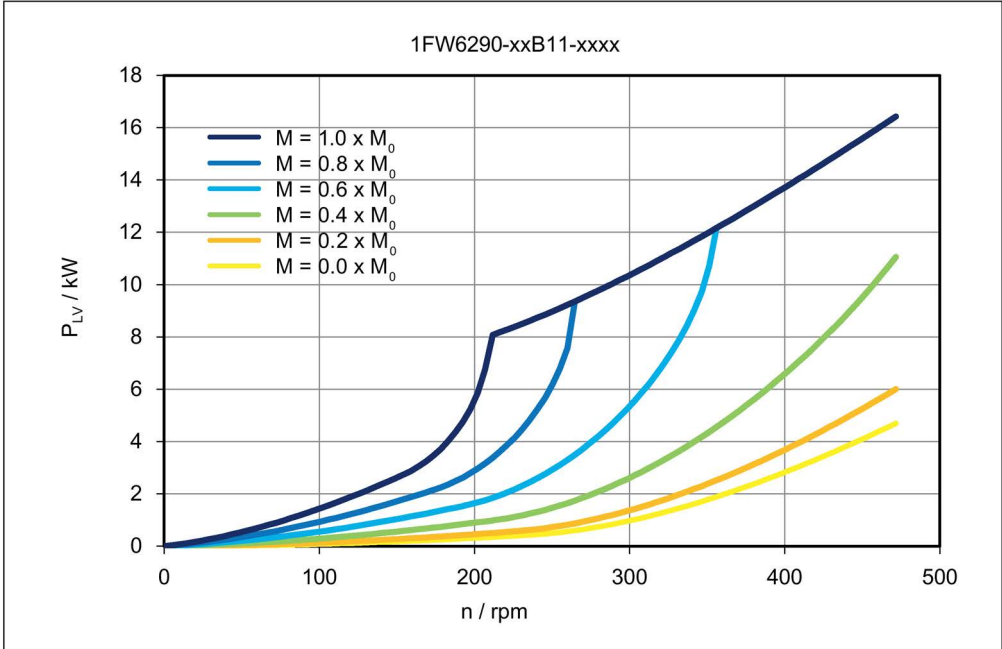

Data sheet 1FW6290-xxB15-xxxx

Table 6- 53 1FW6290-xxB15-7Axx, 1FW6290-xxB15-0Lxx, 1FW6290-xxB15-2Pxx

Technical data	Symbol	Unit	-xxB15-7Axx	-xxB15-0Lxx	-xxB15-2Pxx
1FW6290					
Boundary conditions					
DC link voltage	U_{DC}	V	600	600	600
Water cooling inlet temperature	T_{VORL}	°C	35	35	35
Rated temperature of winding	T_N	°C	130	130	130
Data at the rated operating point					
Rated torque	M_N	Nm	4600	4480	4390
Rated current	I_N	A	60.7	94.4	118
Rated speed	n_N	rpm	51.3	88.5	117
Rated power loss	$P_{V,N}$	kW	9.05	9.06	9.11
Limit data					
Maximum torque	M_{MAX}	Nm	8570	8570	8570
Maximum current	I_{MAX}	A	133	212	272
Electric motor power at M_{MAX}	$P_{EL,MAX}$	kW	64	83.8	98.6
Maximum speed	n_{MAX}	rpm	169	270	346
Maximum speed at maximum torque	$n_{MAX,MMAX}$	rpm	26.6	48.7	64.9
Max. speed without VPM	$n_{MAX,INV}$	rpm	115	184	236
No-load speed	$n_{MAX,0}$	rpm	84.4	135	173
Torque at $n = 1$ rpm	M_0	Nm	4760	4760	4760
Current at M_0 and $n = 1$ rpm	I_0	A	63	101	129
Thermal static torque	M_0^*	Nm	3400	3400	3400
Thermal stall current	I_0^*	A	44.5	71.1	91.3
Physical constants					
Torque constant at 20 °C	$k_{T,20}$	Nm/A	76.5	47.9	37.3
Voltage constant	k_E	V/(1000/min)	4630	2900	2260
Motor constant at 20 °C	$k_{M,20}$	Nm/(W) ^{0.5}	60.6	60.6	60.4
Thermal time constant	t_{TH}	s	180	180	180
No. of pole pairs	p	-	42	42	42
Cogging torque	M_{COG}	Nm	23.8	23.8	23.8
Stator mass	m_s	kg	156	156	156
Rotor mass	m_L	kg	59	59	59
Rotor moment of inertia	J_L	10 ⁻² kgm ²	440	440	440
Phase resistance of winding at 20 °C	$R_{STR,20}$	Ω	0.531	0.208	0.127
Phase inductance of winding	L_{STR}	mH	10.8	4.24	2.58

Technical data	Symbol	Unit	-xxB15-7Axx	-xxB15-0Lxx	-xxB15-2Pxx
1FW6290					
Data for main motor cooler *)					
Maximum dissipated thermal power	$Q_{H,MAX}$	kW	6.8	6.8	6.84
Recommended minimum volume flow	$\dot{V}_{H,MIN}$	l/min	8.59	8.59	8.59
Cooling medium temperature increase	ΔT_H	K	11.4	11.4	11.5
Pressure drop	Δp_H	bar	0.804	0.804	0.804
Data for precision motor cooler *)					
Maximum dissipated thermal power	$Q_{P,MAX}$	kW	0.733	0.733	0.738
Recommended minimum volume flow	$\dot{V}_{P,MIN}$	l/min	3.41	3.41	3.41
Cooling medium temperature increase	ΔT_P	K	3.09	3.09	3.11
Pressure drop	Δp_P	bar	0.804	0.804	0.804

*) Parallel connection of main and precision motor cooler

Characteristics for 1FW6290-xxB15-xxxx

Torque M with respect to speed n

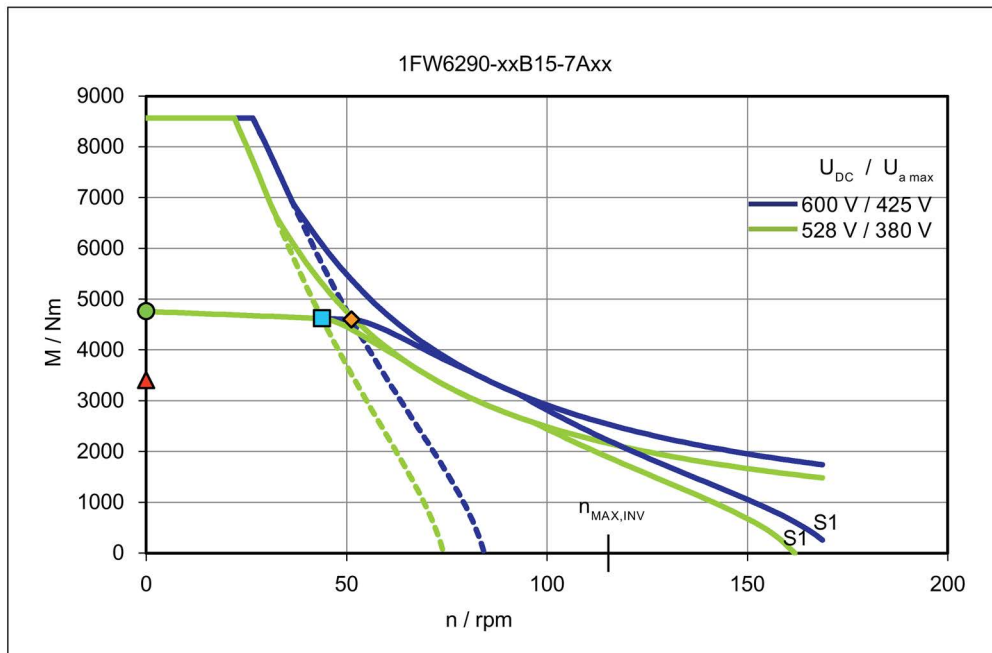

Torque M with respect to speed n

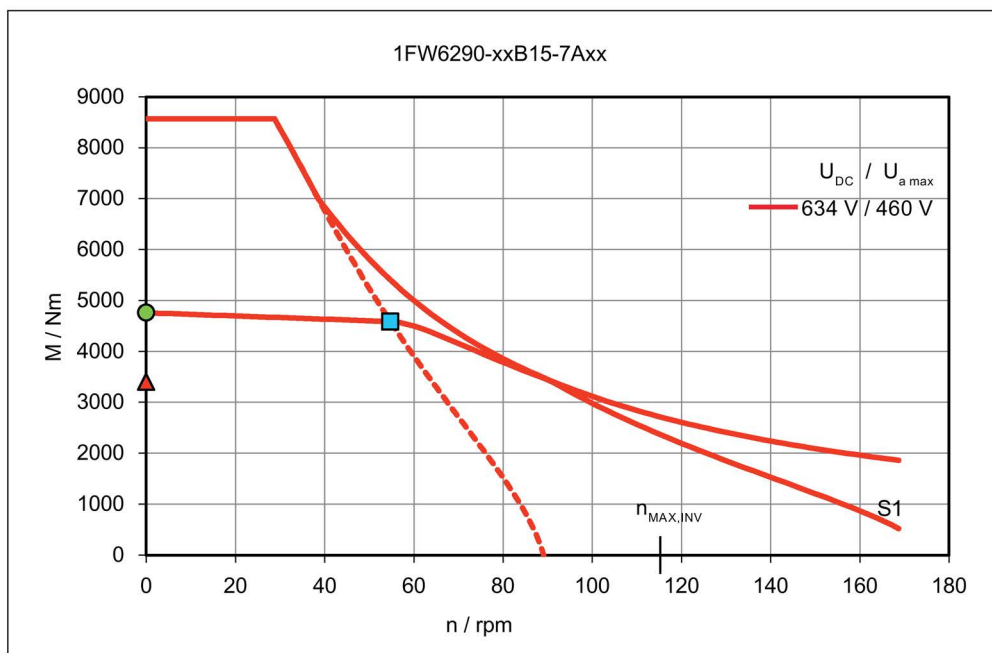

Torque M with respect to speed n

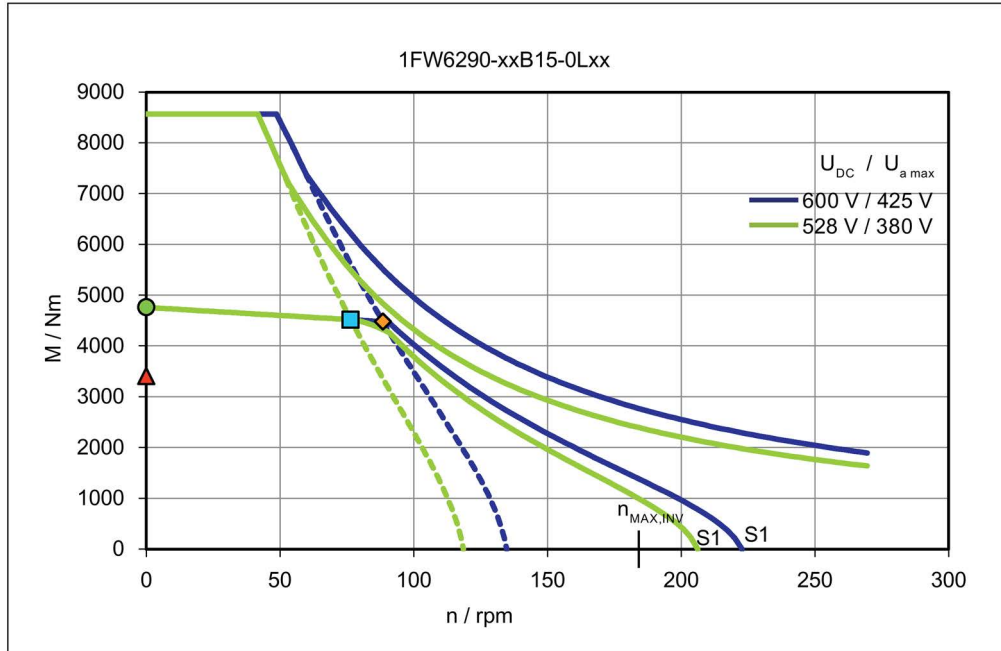

Torque M with respect to speed n

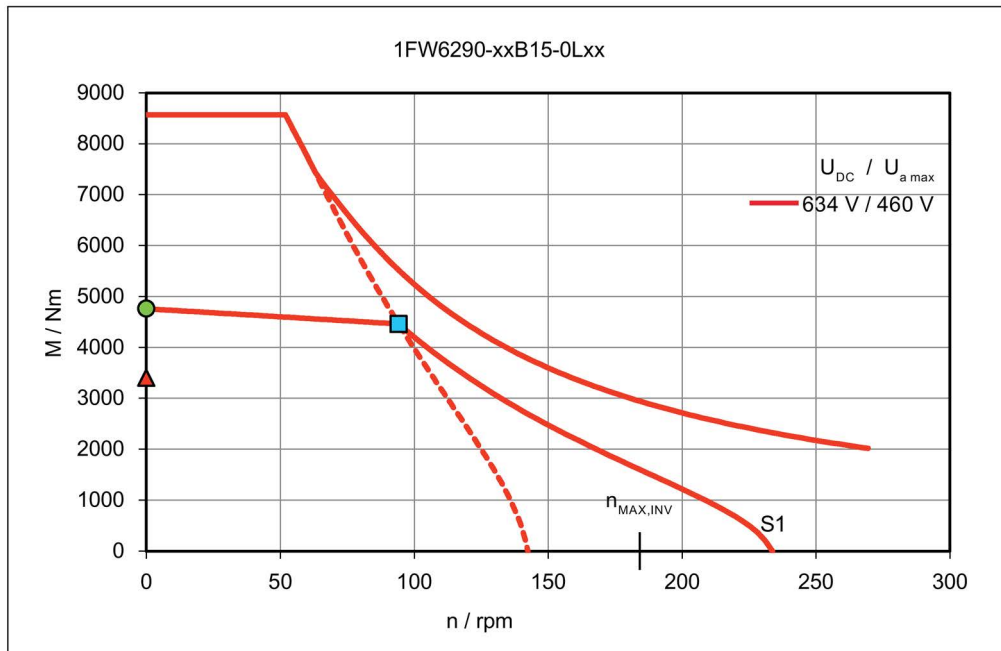

Torque M with respect to speed n

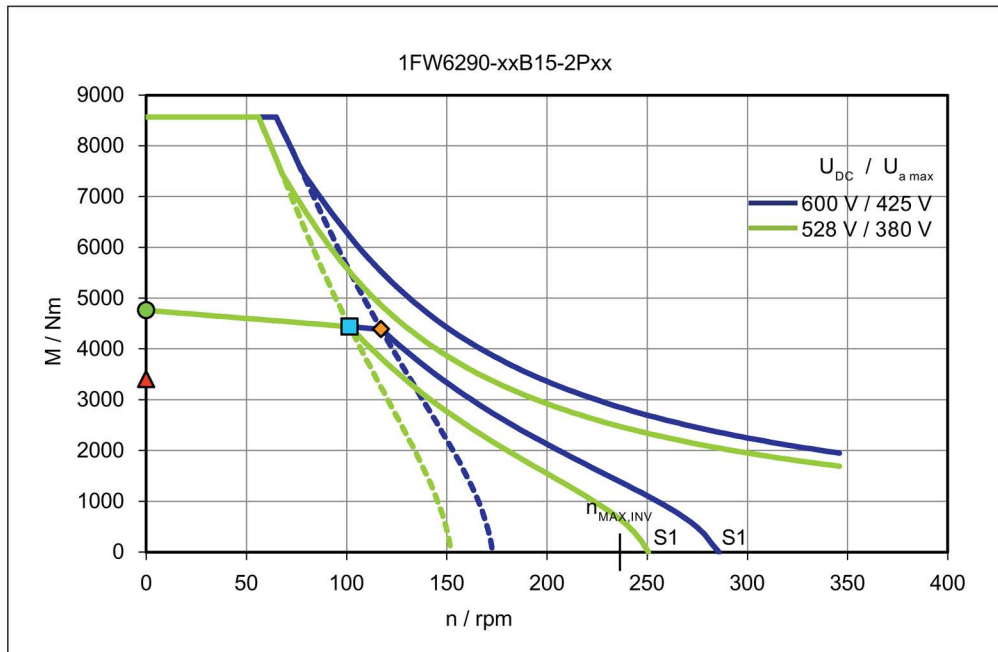

Torque M with respect to speed n

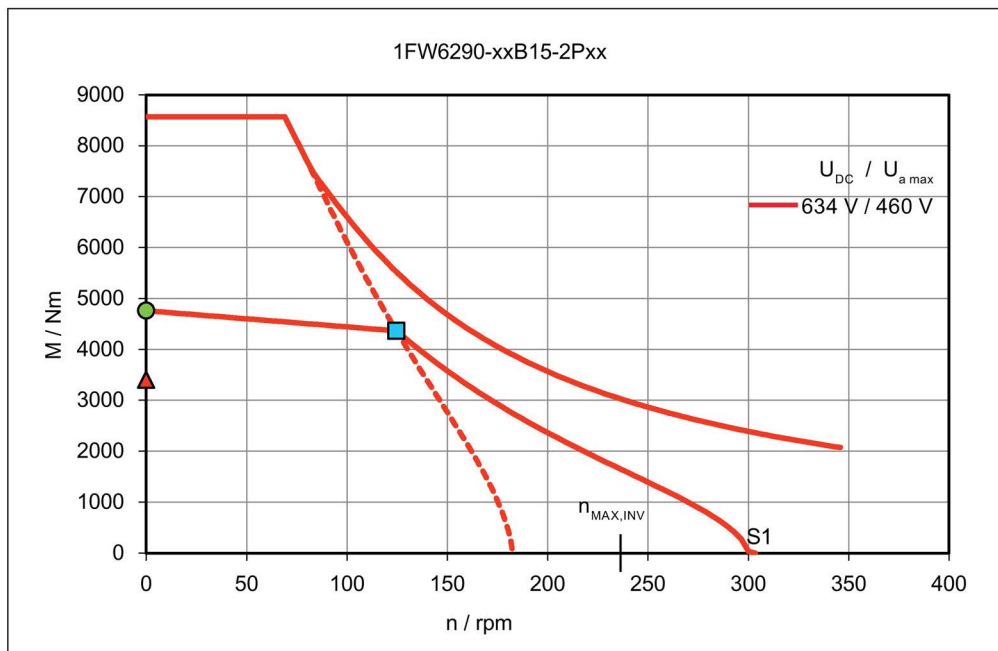

Short-circuit braking torque M_{Br} with respect to speed n

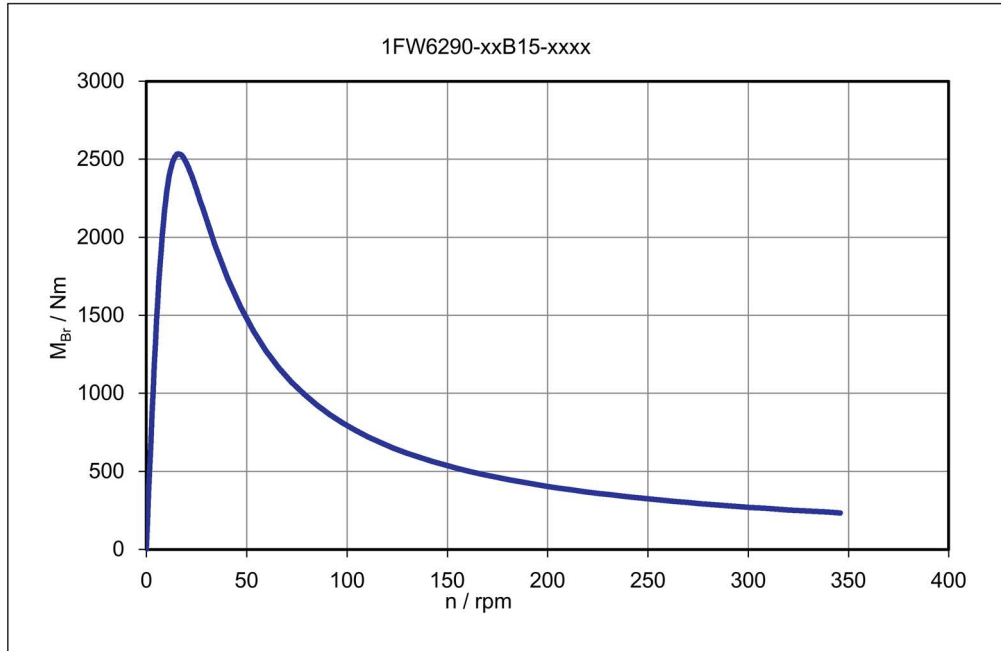

Main cooler and precision cooler - pressure losses Δp with respect to the flow rate \dot{V} (HK || PK: main cooler HK and precision cooler PK connected in parallel)

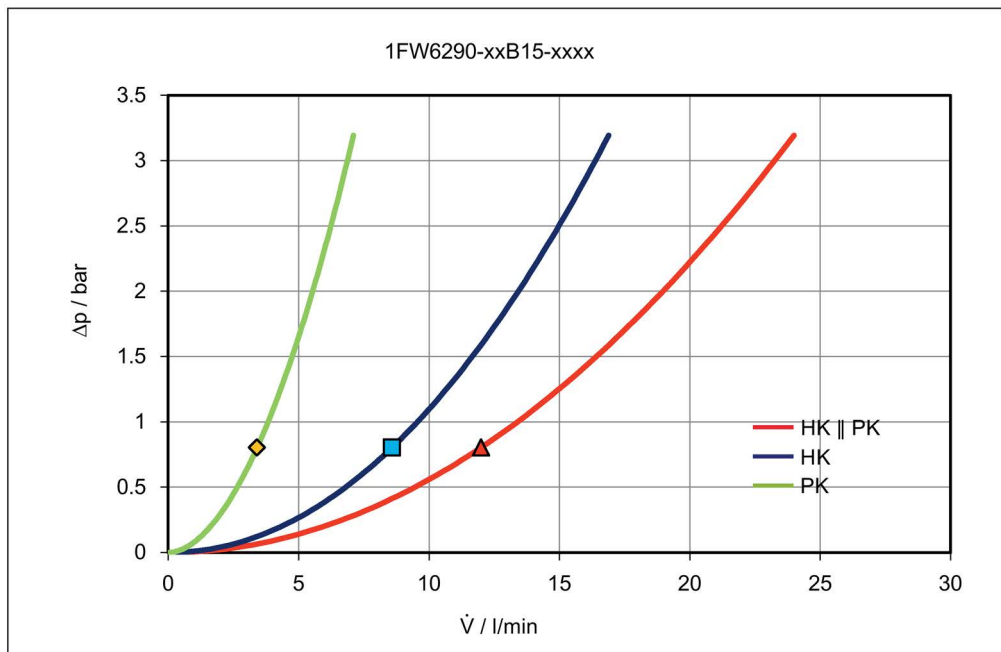

Rotor power loss P_{LV} with respect to speed n

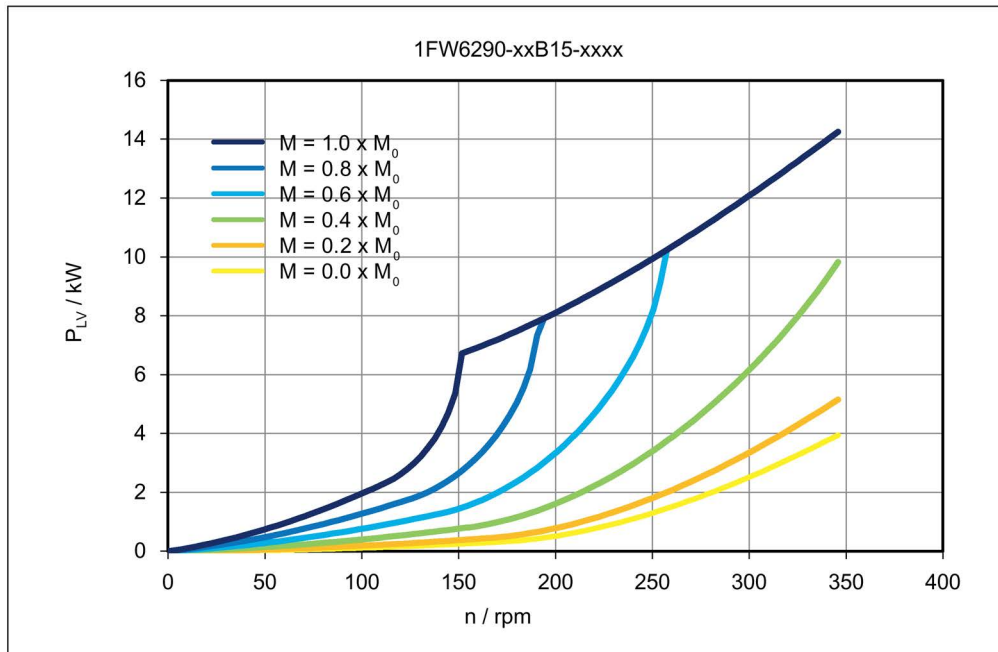

Data sheet 1FW6290-xxB20-xxxx

Table 6- 54 1FW6290-xxB20-0Lxx, 1FW6290-xxB20-2Pxx

Technical data	Symbol	Unit	-xxB20-0Lxx	-xxB20-2Pxx
1FW6290				
Boundary conditions				
DC link voltage	U_{DC}	V	600	600
Water cooling inlet temperature	T_{VORL}	°C	35	35
Rated temperature of winding	T_N	°C	130	130
Data at the rated operating point				
Rated torque	M_N	Nm	5760	5670
Rated current	I_N	A	95.8	121
Rated speed	n_N	rpm	67.9	90.3
Rated power loss	$P_{V,N}$	kW	11	11.1
Limit data				
Maximum torque	M_{MAX}	Nm	10900	10900
Maximum current	I_{MAX}	A	212	272
Electric motor power at M_{MAX}	$P_{EL,MAX}$	kW	90.8	106
Maximum speed	n_{MAX}	rpm	213	273
Maximum speed at maximum torque	$n_{MAX,MMAX}$	rpm	36.9	49.9
Max. speed without VPM	$n_{MAX,INV}$	rpm	145	187
No-load speed	$n_{MAX,0}$	rpm	106	137
Torque at $n = 1$ rpm	M_0	Nm	6030	6030
Current at M_0 and $n = 1$ rpm	I_0	A	101	129
Thermal static torque	M_0^*	Nm	4310	4310
Thermal stall current	I_0^*	A	71.1	91.3
Physical constants				
Torque constant at 20 °C	$k_{T,20}$	Nm/A	60.7	47.3
Voltage constant	k_E	V/(1000/min)	3670	2860
Motor constant at 20 °C	$k_{M,20}$	Nm/(W) ^{0.5}	69.6	69.4
Thermal time constant	t_{TH}	s	180	180
No. of pole pairs	p	-	42	42
Cogging torque	M_{COG}	Nm	30.2	30.2
Stator mass	m_s	kg	188	188
Rotor mass	m_L	kg	73	73
Rotor moment of inertia	J_L	10 ⁻² kgm ²	546	546
Phase resistance of winding at 20 °C	$R_{STR, 20}$	Ω	0.253	0.155
Phase inductance of winding	L_{STR}	mH	5.35	3.25

Technical data	Symbol	Unit	-xxB20-0Lxx	-xxB20-2Pxx
1FW6290				
Data for main motor cooler *)				
Maximum dissipated thermal power	$Q_{H,MAX}$	kW	8.27	8.32
Recommended minimum volume flow	$\dot{V}_{H,MIN}$	l/min	14.1	14.1
Cooling medium temperature increase	ΔT_H	K	8.41	8.46
Pressure drop	Δp_H	bar	2.22	2.22
Data for precision motor cooler *)				
Maximum dissipated thermal power	$Q_{P,MAX}$	kW	0.892	0.897
Recommended minimum volume flow	$\dot{V}_{P,MIN}$	l/min	5.86	5.86
Cooling medium temperature increase	ΔT_P	K	2.19	2.2
Pressure drop	Δp_P	bar	2.22	2.22

*) Parallel connection of main and precision motor cooler

Characteristics for 1FW6290-xxB20-xxxx

Torque M with respect to speed n

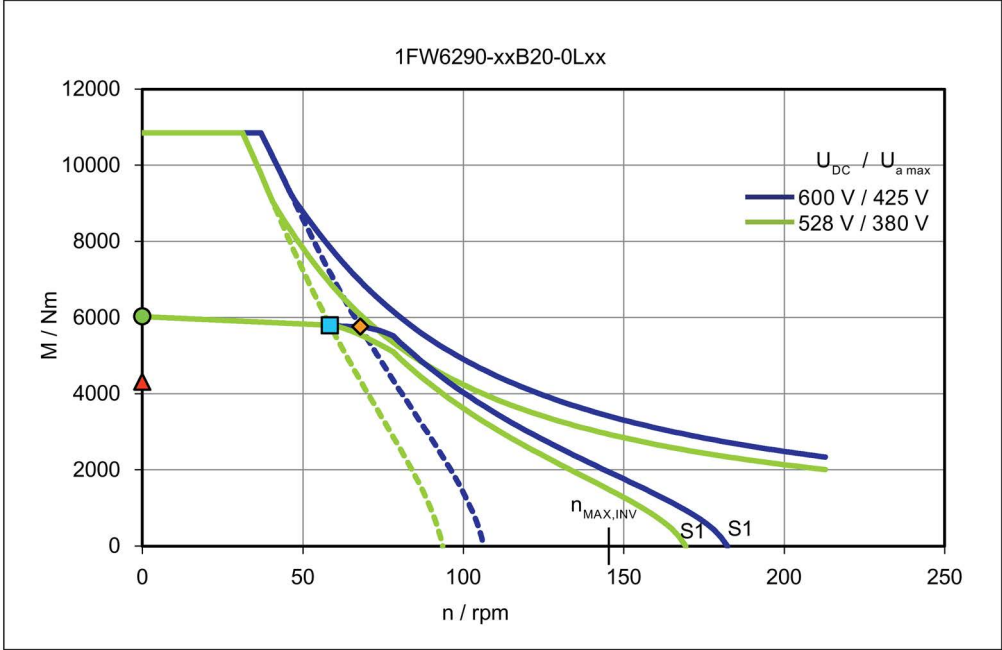

Torque M with respect to speed n

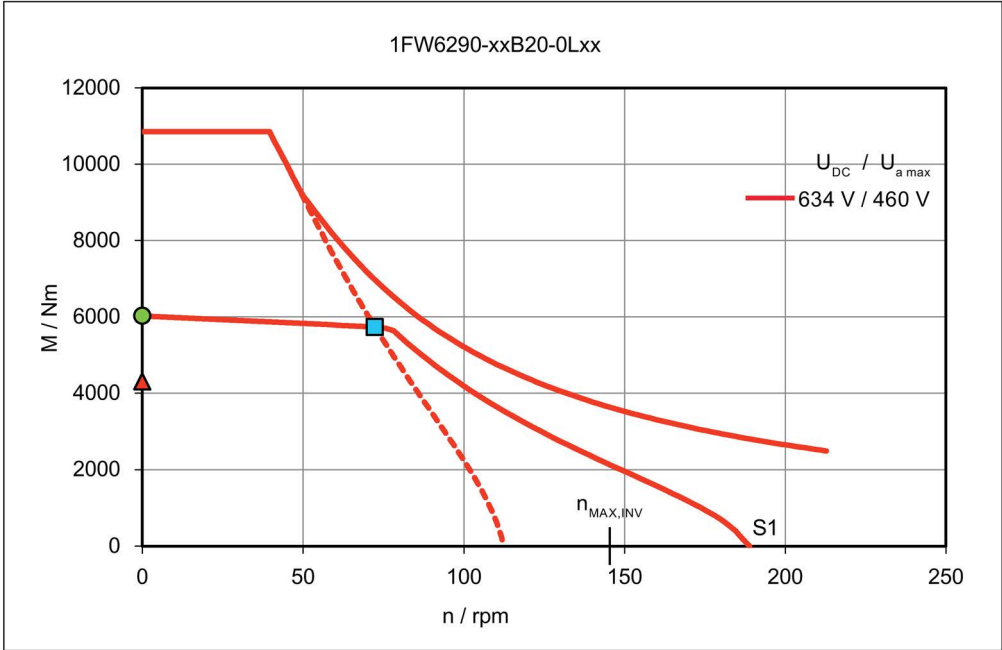

Torque M with respect to speed n

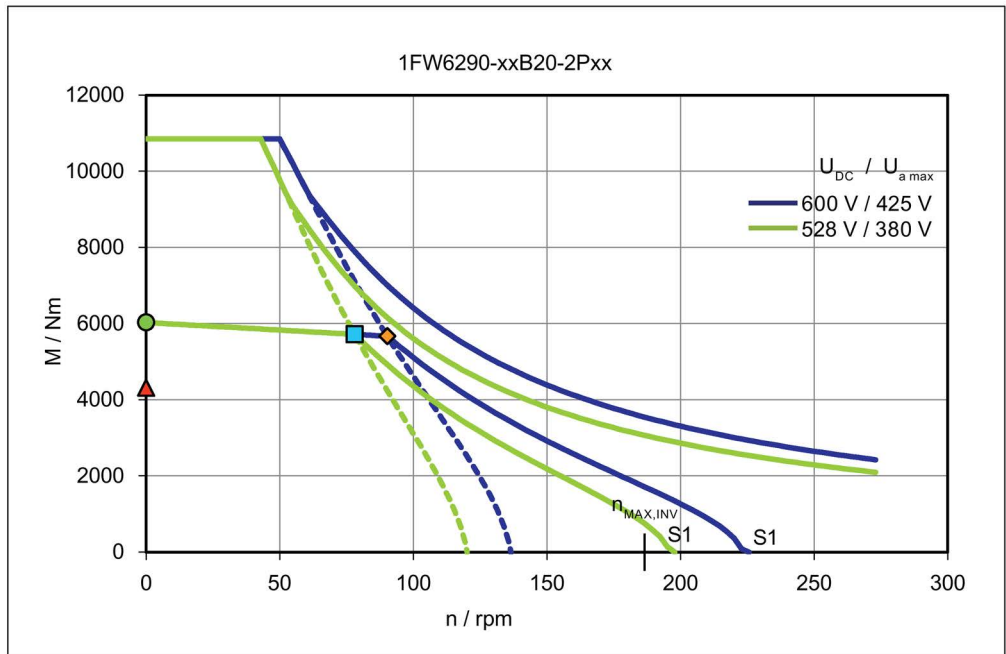

Torque M with respect to speed n

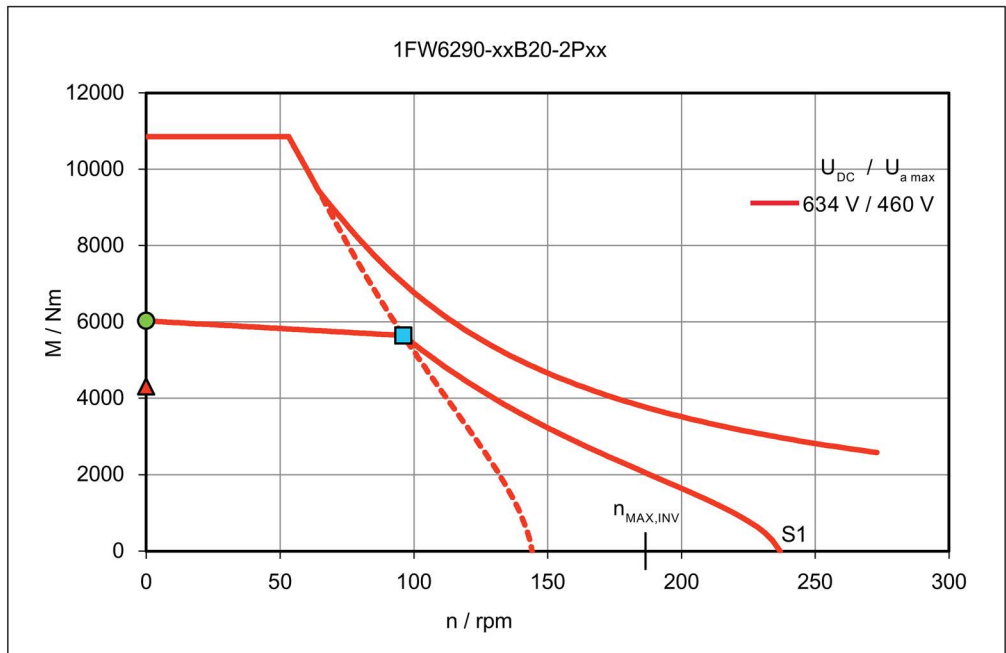

Short-circuit braking torque M_{Br} with respect to speed n

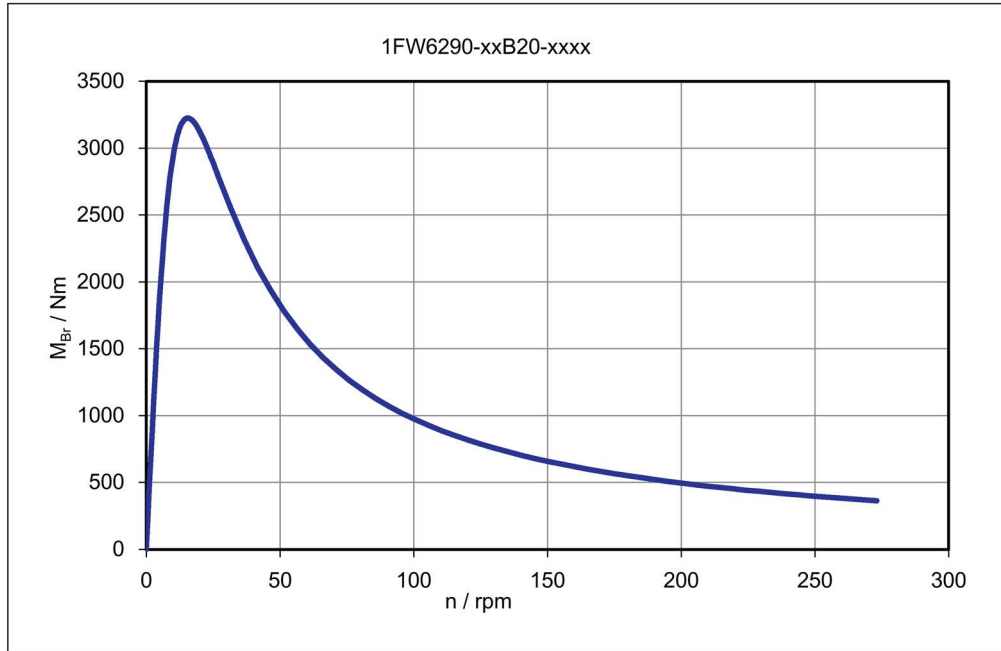

Main cooler and precision cooler - pressure losses Δp with respect to the flow rate \dot{V} (HK || PK: main cooler HK and precision cooler PK connected in parallel)

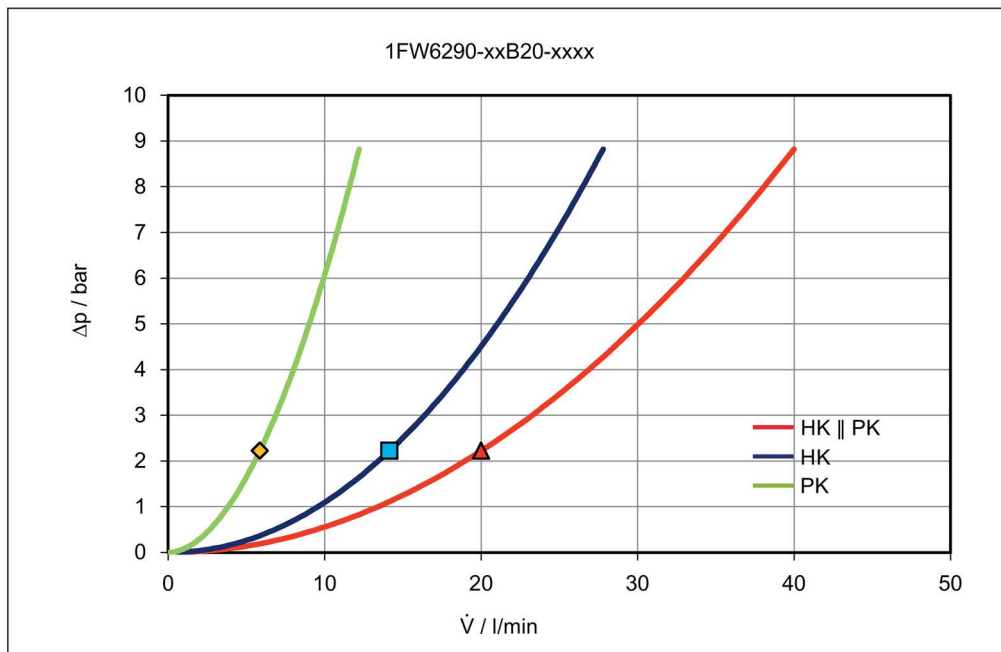

Rotor power loss P_{LV} with respect to speed n

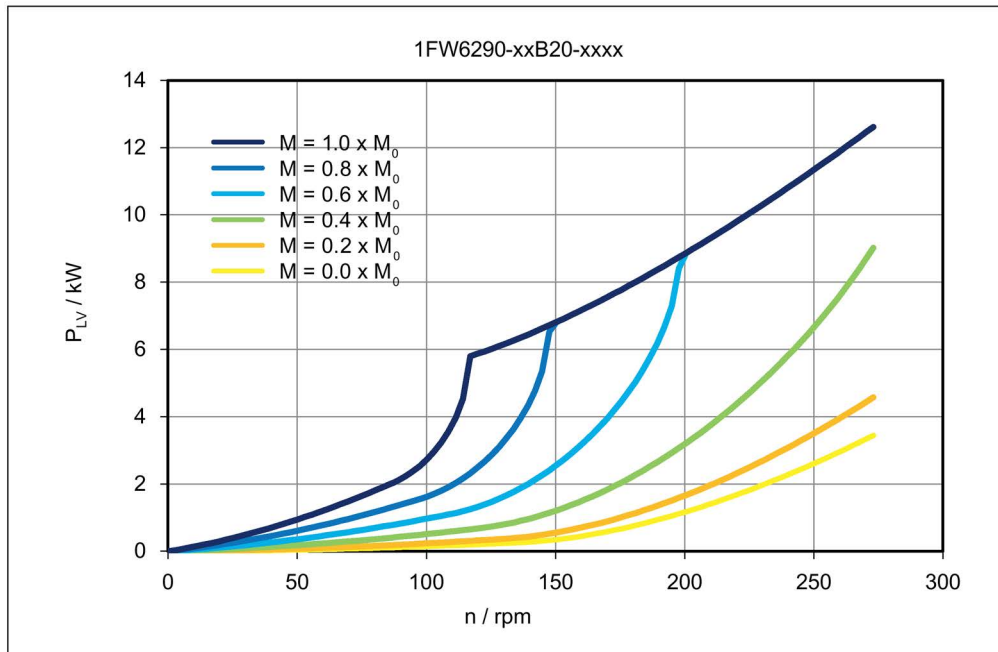

Preparation for use

**⚠ WARNING****Risk of death and crushing as a result of permanent magnet fields**

Severe injury and material damage can result if you do not take into consideration the safety instructions relating to permanent magnet fields.

- Observe the information in Chapter "Danger from strong magnetic fields (Page 29)".

The rotor is secured in the stator by means of transport locks, and is protected by spacer film. The original packaging for the built-in torque motor and the transport locks (incl. the screws) are required for storage/transport purposes and should, therefore, be kept in a safe place.

⚠ WARNING**Risk of toppling over**

Motors, stators, and rotors must not be stacked too high – risk of death, personal injury and/or material damage.

- Never stack packed or unpacked motors, stators or rotors on top of one another.
- Only transport and store motors, stators and rotors in the horizontal position.
- Observe the safety instructions and handling on the packaging.

<p>⚠ WARNING</p> <p>Incorrect packaging, storage and/or incorrect transport</p> <p>Risk of death, injury and/or material damage can occur if the devices are packed, stored, or transported incorrectly.</p> <ul style="list-style-type: none">• Always follow the safety instructions for storage and transport.• Before transporting or lifting machines or parts machines, lock the rotary axes so the they cannot accidentally rotate. This is necessary, as the axes are not self locking.• Always correctly and carefully carry out storage, transport and lifting operations.• Only use suitable devices and equipment that are in perfect condition.• Only use lifting devices, transport equipment and suspension equipment that comply with the appropriate regulations.• IATA regulations must be observed when components are transported by air.• Mark locations where rotors are stored with warning and prohibit signs according to the tables in Chapter "Supplied pictograms"• Observe the warning instructions on the packaging.• Always wear safety shoes and safety gloves.• Take into account the maximum loads that personnel can lift and carry. The motors and their components can weigh more than 13 kg.• Torque motors and rotors must always be transported and stored in the packaged condition.<ul style="list-style-type: none">– Replace any defective packaging. Correct packaging offers protection against sudden forces of attraction that can occur in their immediate vicinity. Further, when correctly packaged you are protected against hazardous motion when storing and moving rotors.– Only use undamaged original packaging.
--

Note

Original packaging

Keep the packaging of components with permanent magnets where possible!

When reusing the original packaging do not cover safety instructions that are possibly attached. When required, use transparent adhesive tape for the packaging.

7.1 Transporting

Note

UN number for permanent magnets

UN number 2807 is allocated to permit magnets as hazardous item.

When shipping products that contain permanent magnets by sea or road, no additional packaging measures are required for protection against magnetic fields.

7.1.1 Ambient conditions for transportation

Based on EN 60721-3-2 (for transportation)

Table 7- 1 Climatic ambient conditions

Lower air temperature limit:	- 5° C (deviates from 3K3)
Upper air temperature limit:	+ 40° C
Lower relative humidity limit:	5 %
Upper relative humidity limit:	85 %
Rate of temperature fluctuations:	Max. 0.5 K/min
Condensation:	Not permissible
Formation of ice:	Not permissible
Transportation:	Class 2K2

Transport is only permissible in locations that are fully protected against the weather (in halls or rooms).

Table 7- 2 Biological ambient conditions

Transportation:	Class 2B1
-----------------	-----------

Table 7- 3 Chemical ambient conditions

Transportation:	Class 2C1
-----------------	-----------

Table 7- 4 Mechanically active ambient conditions

Transportation:	Class 2S2
-----------------	-----------

Table 7- 5 Mechanical ambient conditions

Transportation:	Class 2M2
-----------------	-----------

7.1.2 Packaging specifications for transport by air

When transporting products containing permanent magnets by air, the maximum permissible magnetic field strengths specified by the appropriate IATA Packing Instruction must not be exceeded. Special measures may be required so that these products can be shipped. Above a certain magnetic field strength, shipping requires that you notify the relevant authorities and appropriately label the products.

Note

The magnetic field strengths listed in the following always refer to values for the DC magnetic field specified in the IATA packaging instruction 953. If the values change, then we will take this into account in the next edition.

Products whose highest field strength exceeds 0.418 A/m, as determined at a distance of 4.6 m from the product, require shipping authorization. This product will only be shipped with previous authorization from the responsible national body of the country from where the product is being shipped (country of origin) and the country where the airfreight company is based. Special measures need to be taken to enable the product to be shipped.

When shipping products whose highest field strength is equal to or greater than 0.418 A/m, as determined at a distance of 2.1 m from the product, you have a duty to notify the relevant authorities and appropriately label the product.

When shipping products whose highest field strength is less than 0.418 A/m, as determined at a distance of 2.1 m from the product, you do not have to notify the relevant authorities and you do not have to label the product.

Shipping originally packed motor components neither has to be disclosed nor marked.

7.1.3 Lifting rotors

NOTICE
Damage to the motor when incorrectly lifted
Improper use of lifting devices can cause plastic deformation of the motor.
<ul style="list-style-type: none">• To lift the motor (or stator/rotor), at least three lifting eyebolts are required.• Screw the lifting eyebolts symmetrically into the tapped holes on the flat motor (or stator/rotor).• Only lift motors (or stators/rotors) when they are in a horizontal position.• The lifting ropes must be the same length. The tightened lifting ropes must form an angle of at least 50° between the lifting rope and motor (or stator/rotor).

7.2 Storage

7.2.1 Ambient conditions for long-term storage

Based on EN 60721-3-1 (for long-term storage)

Table 7- 6 Climatic ambient conditions

Lower air temperature limit:	- 5° C (deviates from 3K3)
Upper air temperature limit:	+ 40° C
Lower relative humidity limit:	5 %
Upper relative humidity limit:	85 %
Rate of temperature fluctuations:	Max. 0.5 K/min
Condensation:	Not permissible
Formation of ice:	Not permissible
Long-term storage:	Class 1K3 and class 1Z1 have a different upper relative humidity

Storage is only permissible in locations that are fully protected against the weather (in halls or rooms).

Table 7- 7 Biological ambient conditions

Long-term storage:	Class 1B1
--------------------	-----------

Table 7- 8 Chemical ambient conditions

Long-term storage:	Class 1C1
--------------------	-----------

Table 7- 9 Mechanically active ambient conditions

Long-term storage:	Class 1S2
--------------------	-----------

Table 7- 10 Mechanical ambient conditions

Long-term storage:	Class 1M2
--------------------	-----------

7.2.2 Storage in rooms and protection against humidity

The motors can be stored for up to two years under the following conditions:

Storing indoors

- Apply a preservation agent (e.g. Tectyl) to bare external components if this has not already been carried out in the factory.
- Store the motors as described in Section "Ambient conditions for long-term storage". The storage room/area must satisfy the following conditions:
 - Dry
 - Dust-free
 - Free of any vibration
 - Well ventilated
 - Protected against extreme weather conditions
 - The air inside the room or space must be free of any aggressive gases
- Protect the motor against shocks and humidity.
- Make sure that the motor is covered properly.

Protection against humidity

If a dry storage area is not available, then take the following precautions:

- Wrap the motor in humidity-absorbent material. Then wrap it in foil so that it is air tight.
- Include several bags of desiccant in the sealed packaging. Check the desiccant and replace it as required.
- Place a humidity meter in the sealed packaging to indicate the level of air humidity inside it.
- Inspect the motor on a regular basis.

Protecting the cooling system for motors with integrated cooling

Before you store the motor after use, perform the following actions:

- Empty the cooling channels.
- Blow out the cooling ducts with dry, compressed air so that the cooling ducts are completely empty.
- Seal the connections of the cooling system.

NOTICE

Destruction of the motor if it is directly connected to the three-phase line supply

The motor will be destroyed if it is directly connected to the three-phase line supply.

- Only operate the motors with the appropriately configured converters.



! WARNING

Risk of electric shock

If you connect the voltage to the stator as individual component, then there is a risk of electric shock as there is no touch protection.

- Only connect a voltage if the motor component is installed in the assembled state in the machine.



! WARNING

Risk of electric shock due to incorrect connection

If you incorrectly connect the motor this can result in death, serious injury, or extensive material damage. The motors require an impressed sinusoidal current.

- Connect the motor in accordance with the circuit diagram provided in this documentation.
- Refer also to the documentation for the drive system used.



⚠ WARNING
Electrical shock hazard
Every movement of the rotor compared with the stator and vice versa induces a voltage at the stator power connections.
When the motor is switched on, the stator power connections are also at a specific voltage.
If you use defective cable ports, you could suffer an electric shock.
<ul style="list-style-type: none">• Only mount and remove the electrical components if you are qualified to do so.• Any work carried out at the motor must always be done with the system in a no-voltage condition.• Do not touch the cable ports. Correctly connect the stator power connections, or insulate them properly.• Do not disconnect the power connections when the stator is under voltage (live).• Only use the specific power cables intended for the purpose.• First connect the protective conductor (PE).• Connect the cable shield through a wide area.• First connect the power cable to the stator before you connect the power cable to the inverter.• First disconnect the connection to the inverter before you disconnect the power connection to the stator.• Disconnect the protective conductor PE last.

NOTICE
Destruction of the motor
Removing the connection block for the motor feeder cables at the motor can destroy the motor.
<ul style="list-style-type: none">• Never remove the connection block on the motor for the motor feeder cables (power and signal cables).

The cables for the power connection are brought out at the front of the stator (B flange). The open cable ends must be connected in a terminal box, which must be provided by the machine manufacturer. Sufficient installation space must be provided in the axes construction. Refer to the Chapter "Shielding, grounding and equipotential bonding". Standard MOTION-CONNECT cables, which are available with the standard range of accessories for the drive system, can be used from this EMC-compliant terminal box (minimum degree of protection: IP54).

⚠ WARNING
Electric shock caused by high leakage currents

When touching conductive parts of the machine, high leakage currents can result in an electric shock.

- For high leakage currents, observe the increased requirements placed on the protective conductor. The requirements are laid down in standards EN 61800-5-1 and EN 60204-1.
- For high leakage currents, attach warning symbols to Power Drive System .

⚠ WARNING
Risk of electric shock as a result of residual voltages

There is a risk of electric shock if hazardous residual voltages are present at the motor connections. Even after switching off the power supply, active motor parts can have a charge exceeding 60 μC . In addition, even after withdrawing the connector 1 s after switching off the voltage, more than 60 V can be present at the free cable ends.

- Wait for the discharge time to elapse.

8.1 Permissible line system types

Permissible line system types and voltages

The following table shows the permissible line voltages of TN line supply systems for the motors.

Table 8- 1 Permissible line voltages of TN line supply systems, resulting DC link voltages and converter output voltages

Permissible line supply voltage	Resulting DC link voltage U_{dc}	Converter output voltage (rms value) $U_{a \max}$
400 V	600 V (controlled)	425 V (controlled)
	528 V (uncontrolled)	380 V (uncontrolled)
480 V	634 V (uncontrolled)	460 V (uncontrolled)

When using the SINAMICS S120 drive system, the motors are always approved for operation on the following line supplies:

- TN line systems with grounded neutral point
- TT line systems with grounded neutral point
- IT line systems

When operated on IT line systems, a protective device should be provided that switches off the drive system in the case of a ground fault.

In operation with a grounded external conductor, an isolating transformer with grounded neutral (secondary side) must be connected between the line supply and the drive system. This protects the winding insulation from excessive stress.

8.2 Motor circuit diagram

The circuit diagram of a stator looks like this:

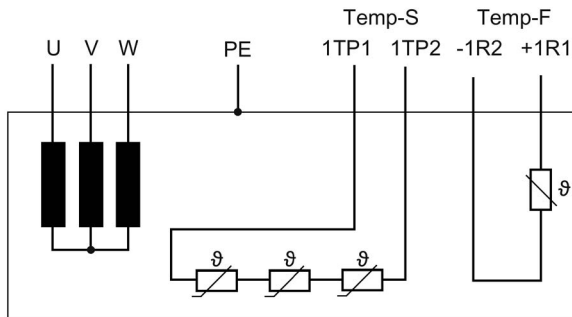

Figure 8-1 Circuit diagram of a stator

Note

Additional temperature monitoring circuit Temp-S

1FW6090-xxxxx-xxx2 to 1FW6290-xxxxx-xxx2 motors are equipped with an additional temperature monitoring circuit Temp-S. The associated interface designations are 2TP1 and 2TP2.

8.3 System integration

8.3.1 Drive system

Components

The drive system that feeds a motor comprises an infeed module, a power module and a control module. For the SINAMICS S120 drive system, these modules are called "Line Modules", "Motor Modules" and "Control Units". Line Modules can be regulated with feedback (ALM, Active Line Module), unregulated with feedback (SLM, Smart Line Module), or unregulated without feedback (BLM, Basic Line Module).

To operate several motors simultaneously on a single drive system, either one Motor Module per motor or one Motor Module for several motors can be provided, depending on the application. The appropriate choice of Line Module is primarily determined by the power consumption of the motors used. Other important related factors are the line voltage, regenerative feedback, and the DC-link voltage.

Note

The order designations for the power cables in the figures below do not apply to motors with single cores.

The following diagram shows an example of a motor integrated into a system with the connection of Temp-S, Temp-F and an absolute encoder (EnDat with 1 V_{PP}, order designation EnDat01 or EnDat02, or SSI with 1 V_{PP}) via SME125.

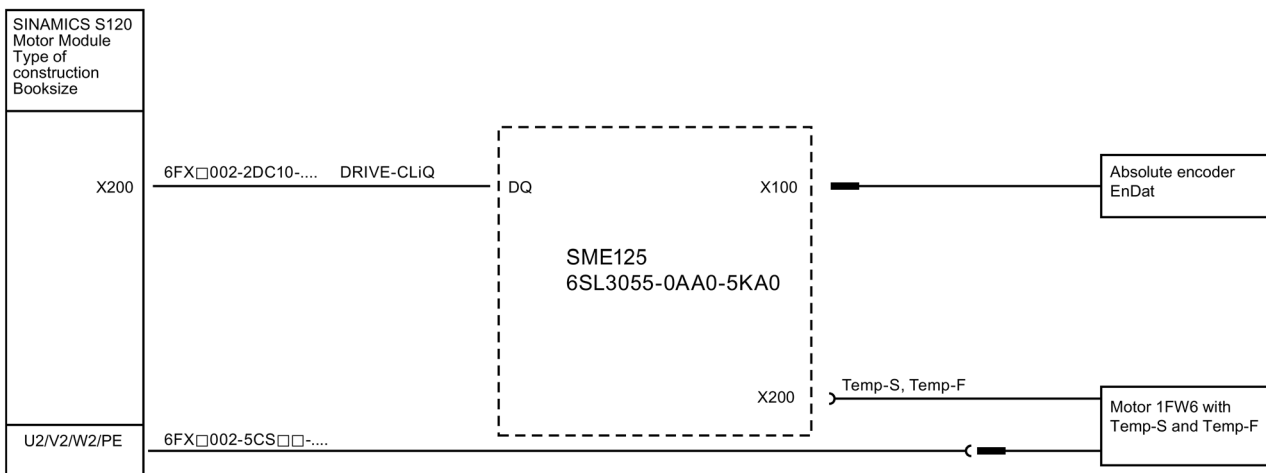

Figure 8-2 System integration with SME125 (example)

The following diagram shows an example of a motor integrated into a system with the connection of Temp-S, Temp-F and an incremental encoder (sin/cos 1 V_{PP}) via SME120.

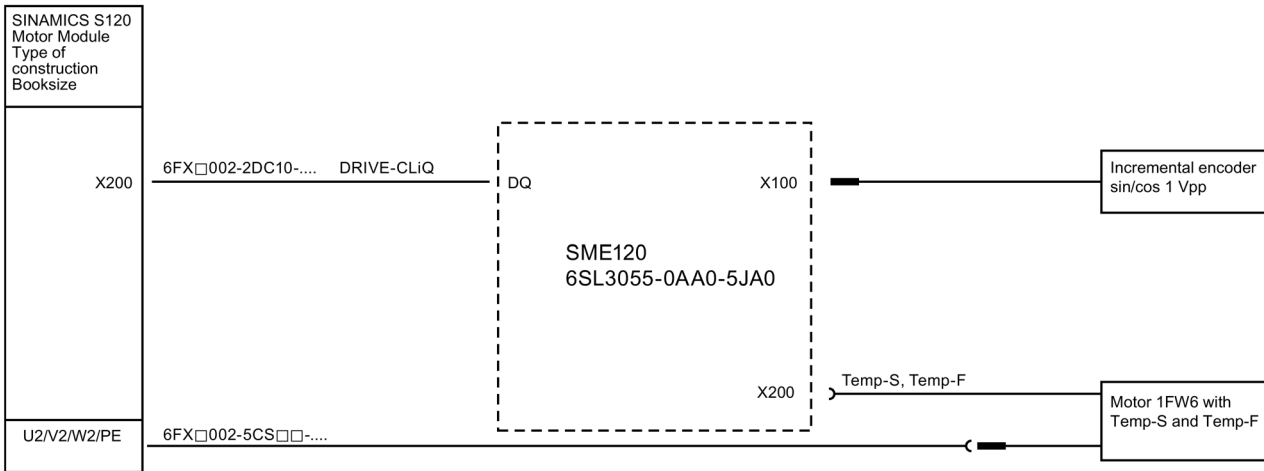

Figure 8-3 System integration with SME120 (example)

Note

Connector sizes, see Chapter "Data for the power cable at the stator (Page 506)".

The following diagram shows an example of a motor integrated into a system with the connection of Temp-S and Temp-F via TM120. An incremental encoder (sin/cos 1 V_{PP}) or absolute encoder (EnDat with 1 V_{PP}, order designation EnDat01 or EnDat02, or SSI with 1 V_{PP}) is connected via SMC20.

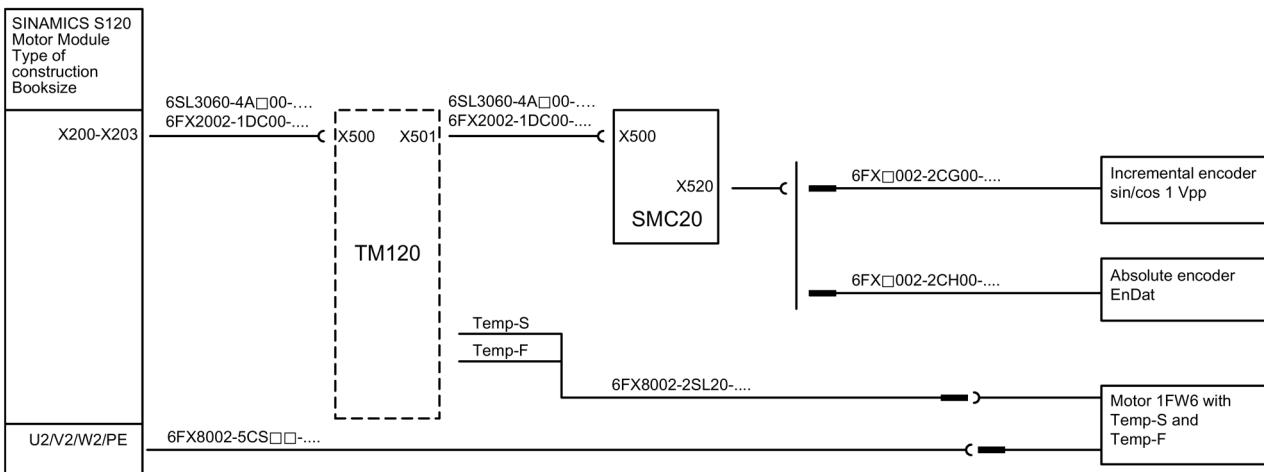

Figure 8-4 System integration with TM120 (example)

Signal connection

Only fully-threaded plug connectors can be used to connect signals. SPEED CONNECT connections are not compatible.

Power connection

Prefabricated cables with full thread plug connectors or SPEED-CONNECT plug connectors can be used as follows to connect the power:

Table 8- 2 Compatibility

Cable at the motor with	Connecting cable with	Compatible
SPEED-CONNECT plug connectors	SPEED-CONNECT plug connectors	Yes
SPEED-CONNECT plug connectors	Fully-threaded plug connectors	Yes

For suitable cables, see Catalog.

Note

Remove the O-ring from the SPEED CONNECT plug connector before connecting it to a SPEED CONNECT mating plug connector.

For plug connections comprising SPEED CONNECT and full thread plug connectors, the O-ring is required to ensure that the connection is tight and resistant to vibration. Do not remove the O-ring if this combination is used.

Even if a SPEED CONNECT plug connector has been correctly connected to a full thread plug connector, a gap will remain between the connector and mating connector. Do not try to eliminate this gap by tightening the connectors further. This could damage the plug connector.

Requirements

- The power unit is selected depending on the motor current at torque M_0 or according to the maximum motor current.
- The encoder system used must be harmonized with the particular application.

Note

Read the corresponding documentation about open-loop and closed-loop control systems.



NOTICE

Damaged main insulation

In systems where direct drives are used on controlled infeeds, electrical oscillations can occur with respect to ground potential. These oscillations are, among other things, influenced by:

- The lengths of the cables
- The rating of the infeed/regenerative feedback module
- The type of infeed/regenerative feedback module (particularly when an HFD commutating reactor is already present)
- The number of axes
- The size of the motor
- The winding design of the motor
- The type of line supply
- The place of installation

The oscillations lead to increased voltage loads and may damage the main insulation!

- To dampen the oscillations we recommend the use of the associated Active Interface Module or an HFD reactor with damping resistor. For specific details, refer to the documentation of the drive system being used or contact your local Siemens office.

Note

The corresponding Active Interface Module or the appropriate HFD line reactor must be used to operate the Active Line Module controlled infeed unit.

8.3.2 Sensor Module SME12x

Sensor Module External SME12x is a module to evaluate:

- Incremental encoders with sin/cos 1 V_{PP} interface (SME120)
- Absolute encoders with EnDat interface (SME125)
- Temperature sensors

The temperature sensors in the motor do not have safe electrical separation in order to achieve better thermal contact to the motor winding.

The SME12x evaluates the temperature sensors with safe electrical separation.

Information about the SME12x is provided in the "SINAMICS S120 Control Units and Additional System Components" Equipment Manual.

8.3.3 TM120 Terminal Module

The TM120 Terminal Module is a module for evaluating temperature signals.

The temperature sensors in the motor do not have safe electrical separation in order to achieve better thermal contact to the motor winding.

Terminal Module TM120 evaluates the temperature sensors with safe electrical separation.

Information about the TM120 is provided in the Equipment Manual "SINAMICS S120 Control Units and Additional System Components".

8.3.4 SMC20 Sensor Module

The Sensor Module Cabinet-Mounted SMC20 is a module to evaluate:

- Incremental encoders with sin/cos 1 V_{PP} interface
- Absolute encoders with EnDat interface

Information about the SMC20 is provided in the "SINAMICS S120 Control Units and Additional System Components" Equipment Manual.

8.3.5 Electrical connection components

Table 8- 3 Overview of available motor types with respect to the position of the electrical connection

Order designation	Outgoing feeder	Strain relief
1FW6050-0WBxx-xxxx	Axial	Sleeve
1FW6050-0TBxx-xxxx	Tangential	Sleeve
1FW6060-0WBxx-xxxx	Axial	Sleeve
1FW6060-0TBxx-xxxx	Tangential	Sleeve
1FW6090-0PBxx-xxxx	Axial	Sleeve
1FW6090-0QBxx-xxxx	Radial (outward)	Sleeve
1FW6090-0NBxx-xxxx	Tangential	Sleeve
1FW6130-0PBxx-xxxx	Axial	Sleeve
1FW6130-0QBxx-xxxx	Radial (outward)	Sleeve
1FW6130-0NBxx-xxxx	Tangential	Sleeve
1FW6150-0PBxx-xxxx	Axial	Sleeve
1FW6150-0QBxx-xxxx	Radial (outward)	Sleeve
1FW6150-0NBxx-xxxx	Tangential	Sleeve
1FW6160-0WBxx-xxxx	Axial	Sleeve
1FW6160-0VBxx-xxxx	Radial (outward)	Sleeve
1FW6160-0TBxx-xxxx	Tangential	Sleeve
1FW6190-0WBxx-xxxx	Axial	Sleeve
1FW6190-0VBxx-xxxx	Radial (outward)	Sleeve
1FW6190-0TBxx-xxxx	Tangential	Sleeve
1FW6230-0WBxx-xxxx	Axial	Sleeve
1FW6230-0VBxx-xxxx	Radial (outward)	Sleeve
1FW6230-0TBxx-xxxx	Tangential	Sleeve
1FW6290-0WBxx-xxxx	Axial	Sleeve
1FW6290-0VBxx-xxxx	Radial (outward)	Sleeve
1FW6290-0TBxx-xxxx	Tangential	Sleeve

Dimensions of the electrical connections

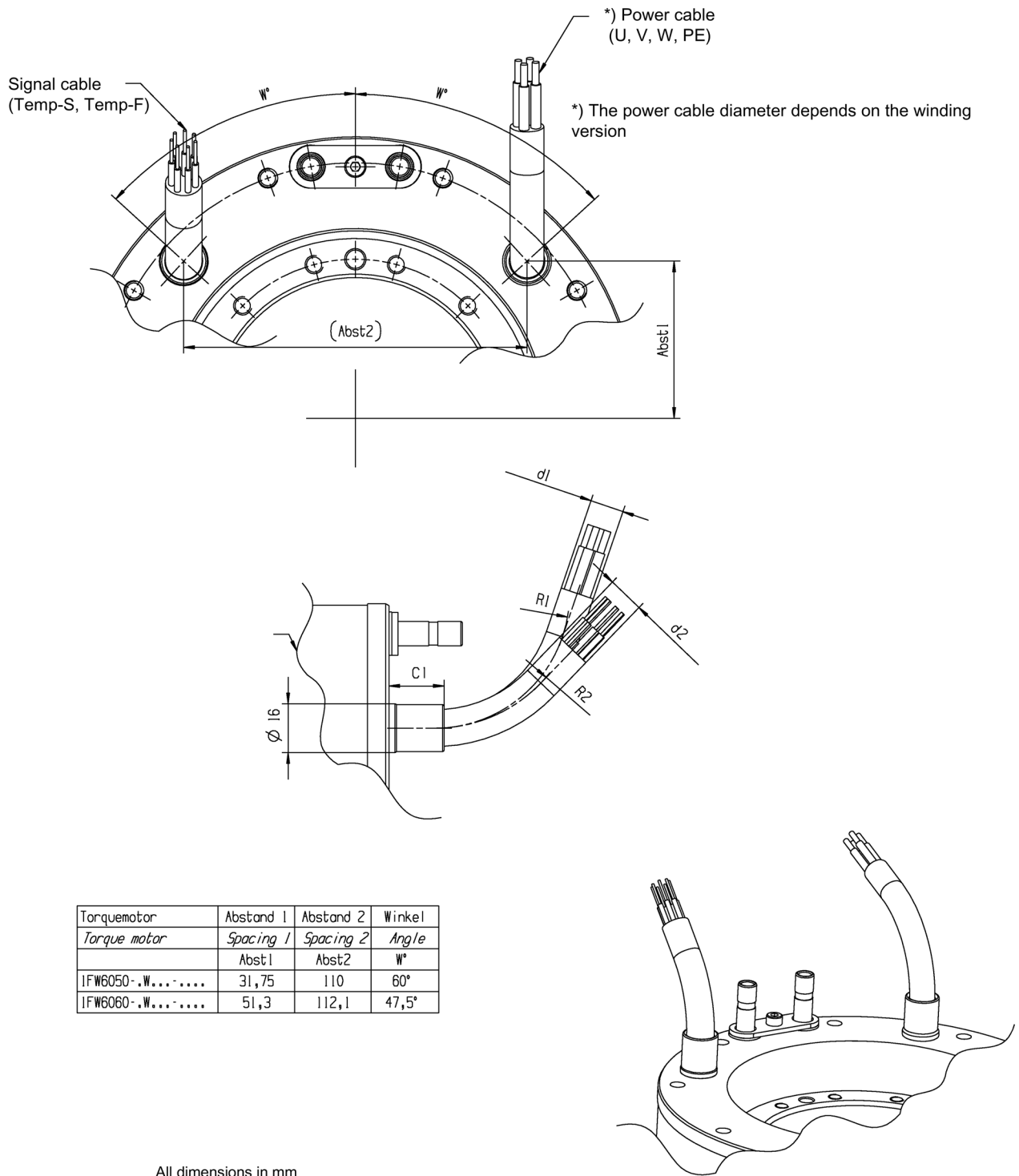

Figure 8-5 Electrical connection axial with sleeve for 1FW605 and 1FW606

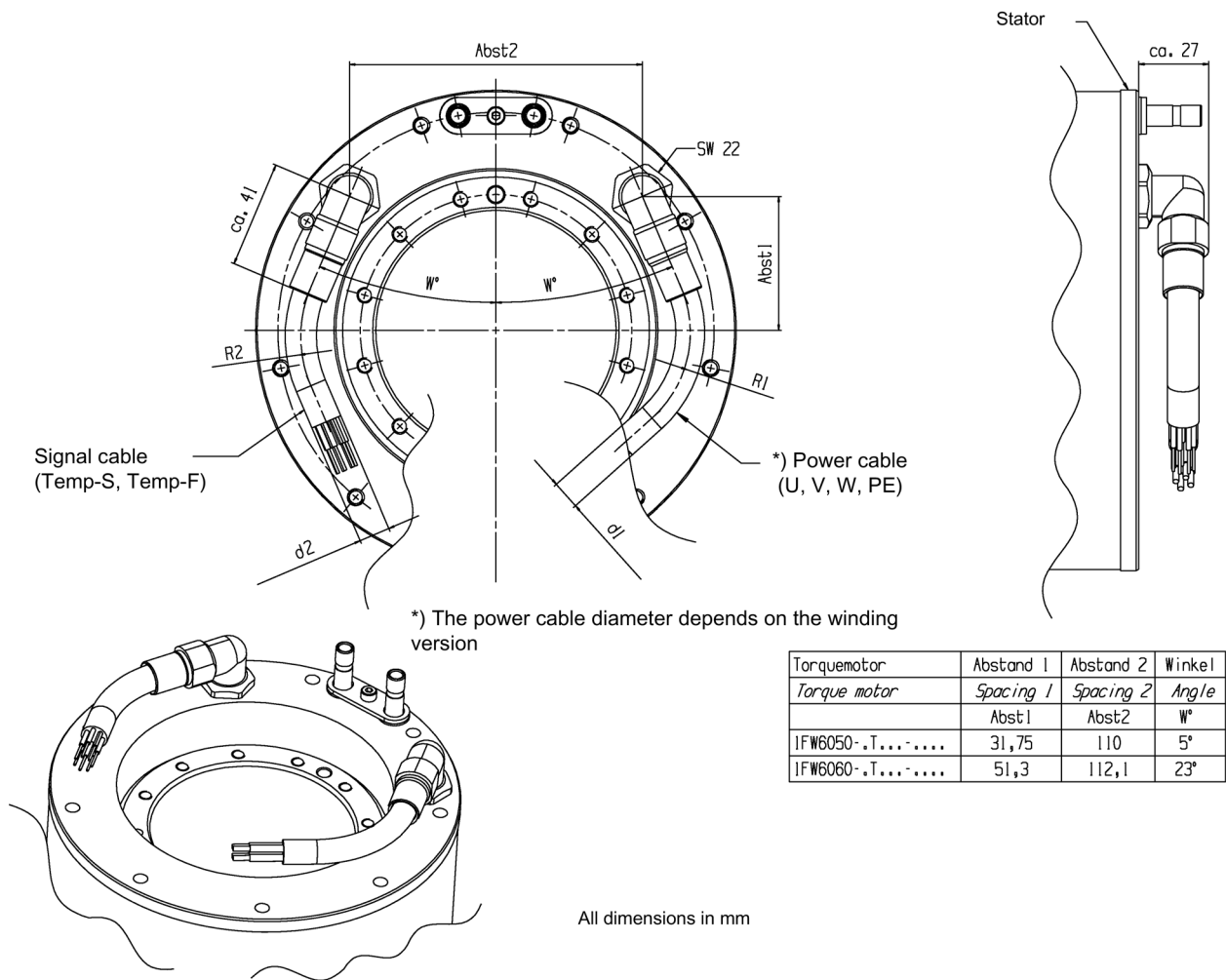
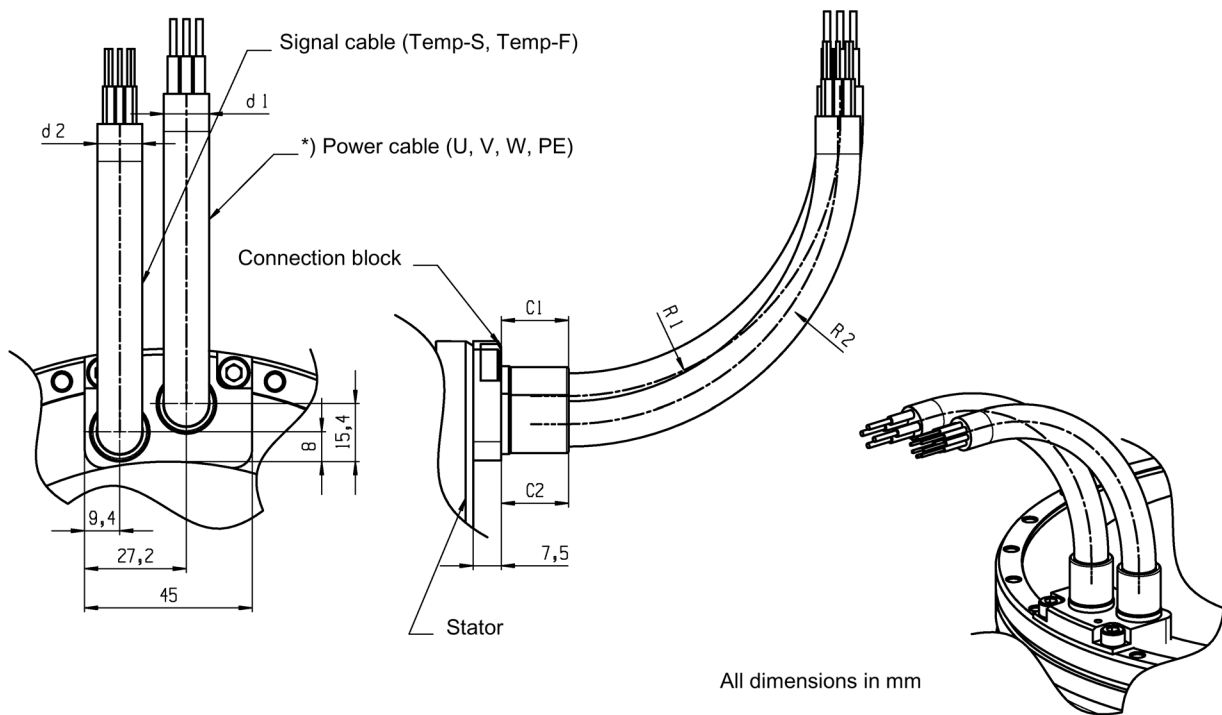

Figure 8-6 Electrical connection tangential with sleeve for 1FW605 and 1FW606



*) The power cable diameter depends on the winding version

Figure 8-7 Electrical connection (axial) with sleeve for 1FW609

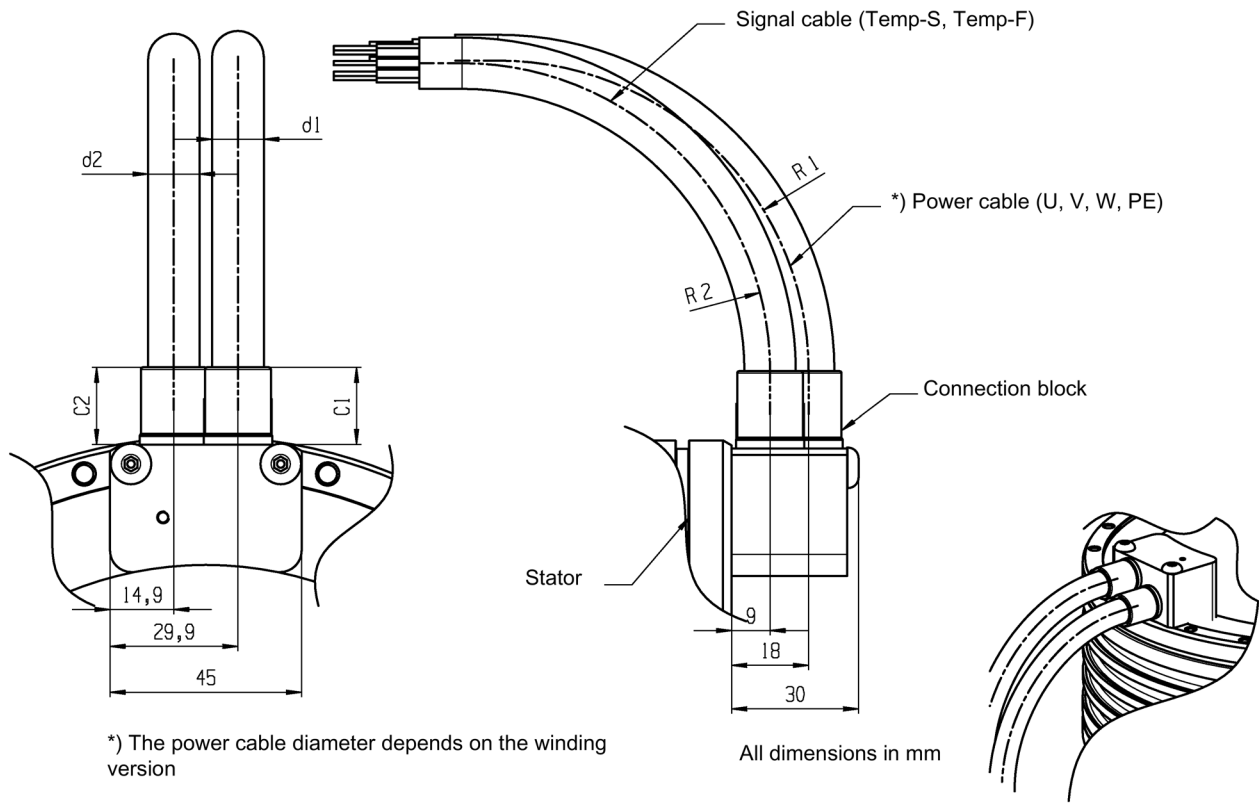

Figure 8-8 Electrical connection (radial, outward) with sleeve for 1FW609

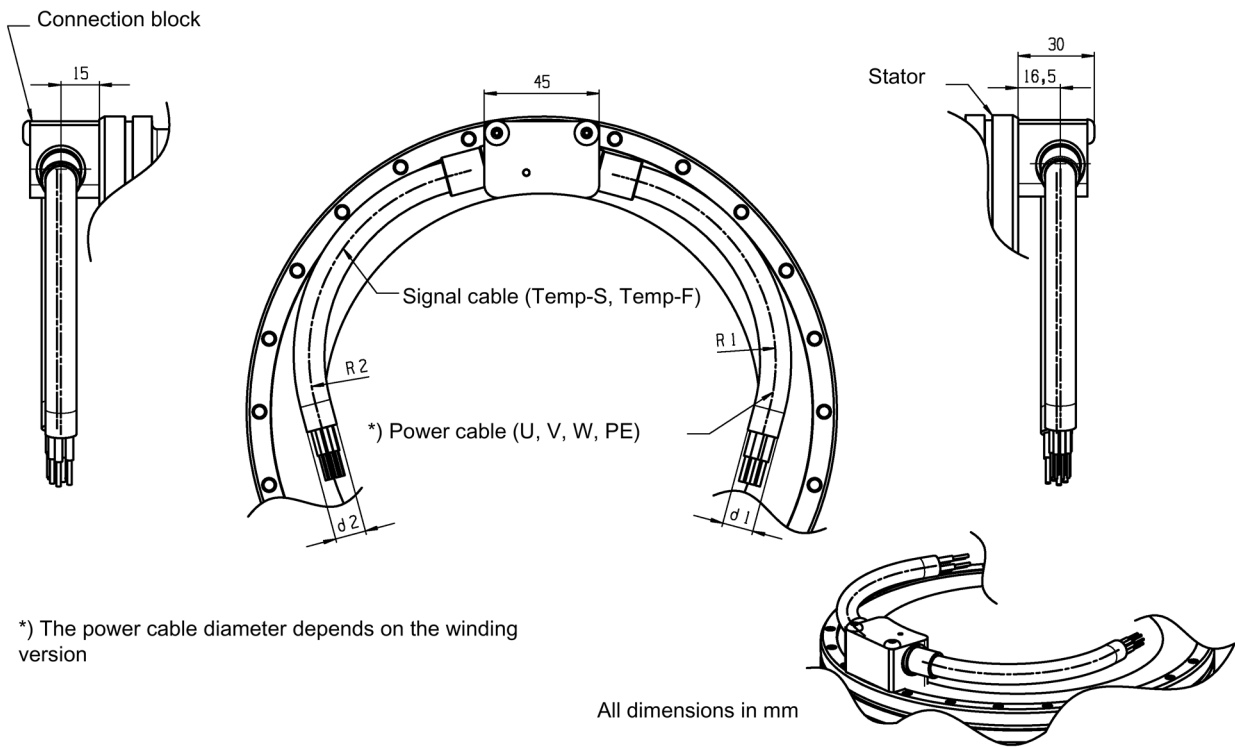

Figure 8-9 Electrical connection (tangential) with sleeve for 1FW609

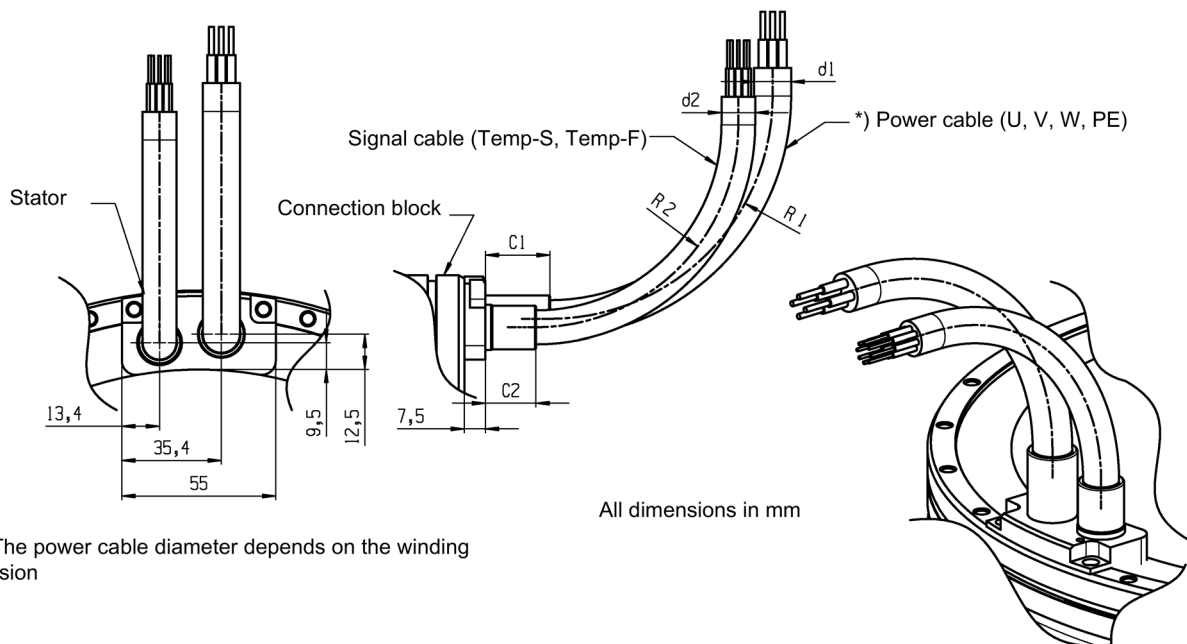

Figure 8-10 Electrical connection (axial) with sleeve for 1FW613

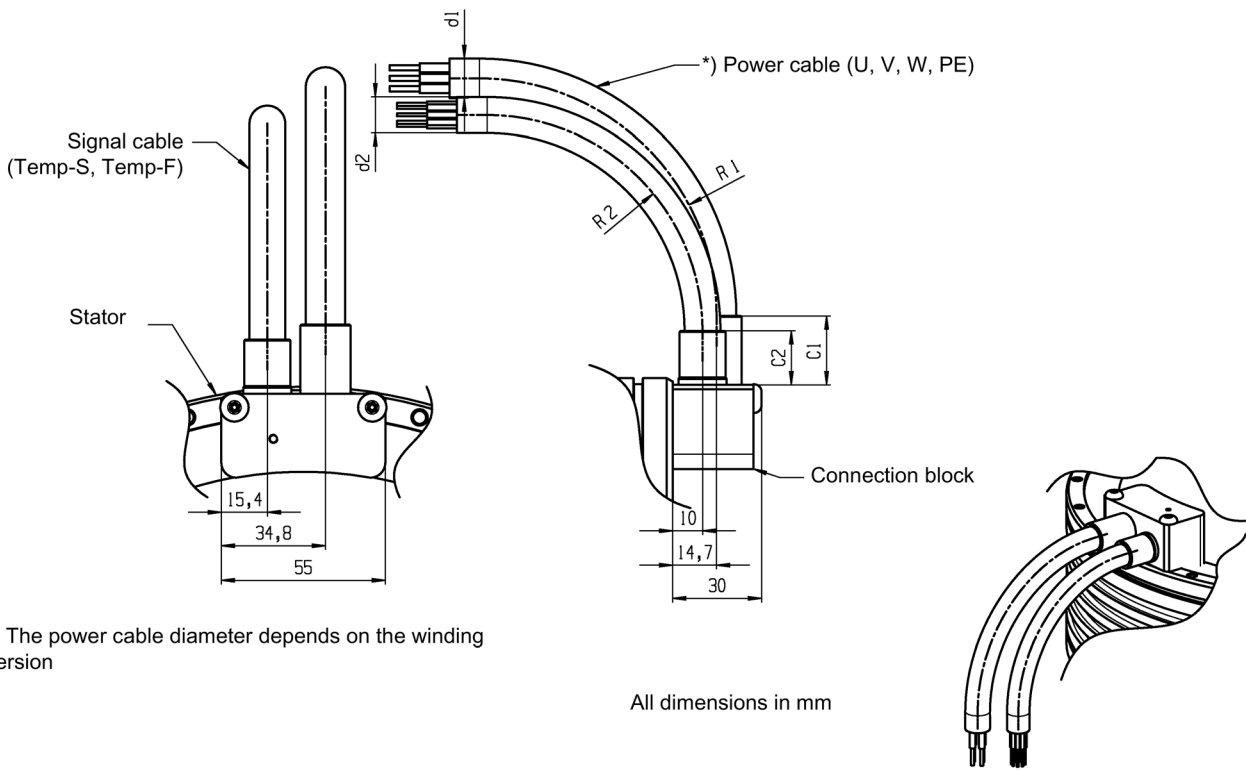

Figure 8-11 Electrical connection (radial, outward) with sleeve for 1FW613

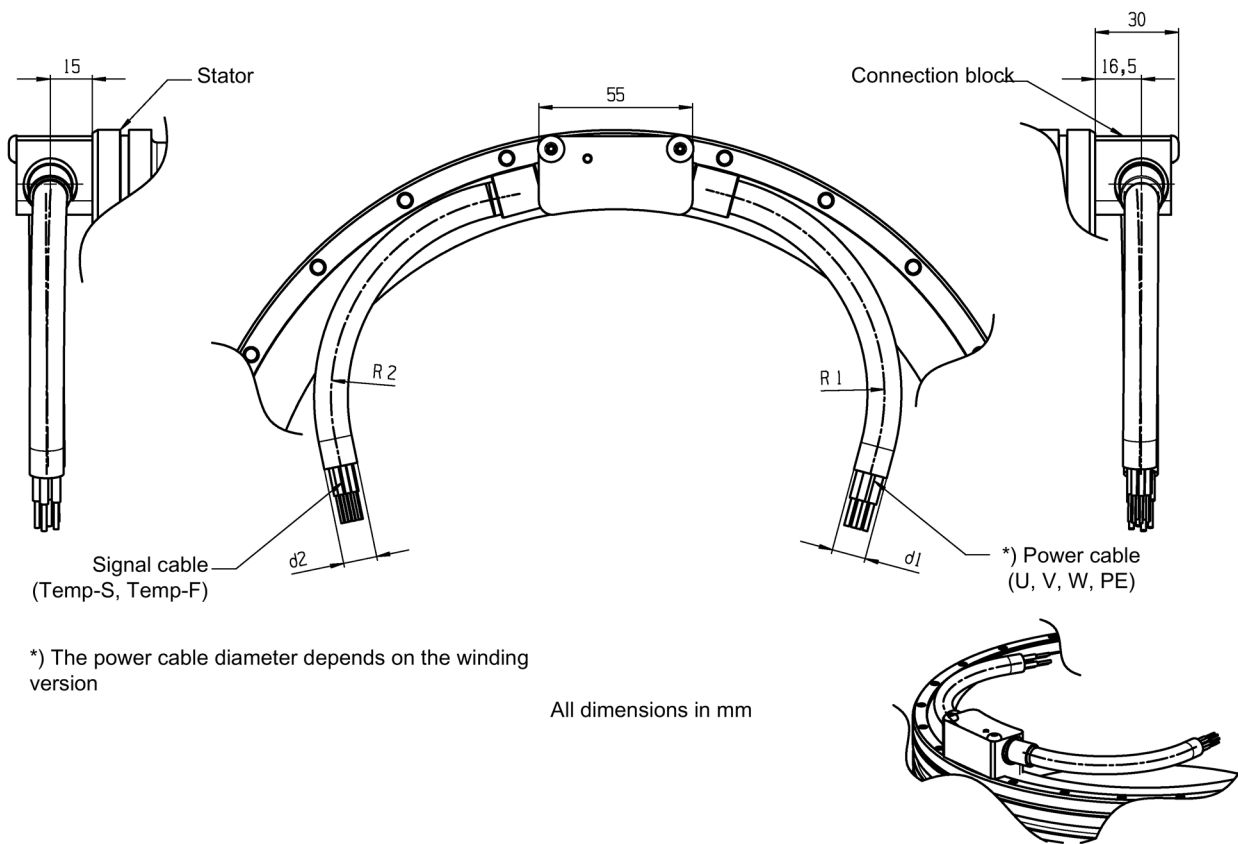

Figure 8-12 Electrical connection (tangential) with sleeve for 1FW613

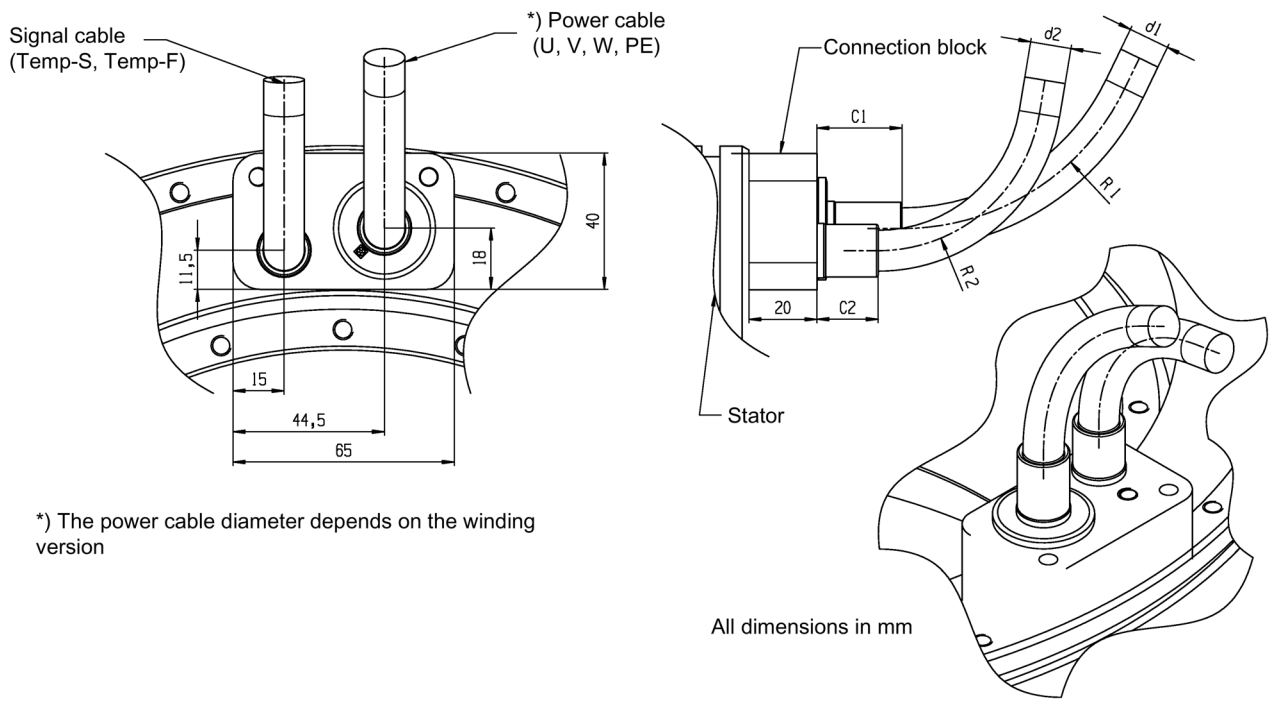

Figure 8-13 Electrical connection (axial) with sleeve for 1FW615

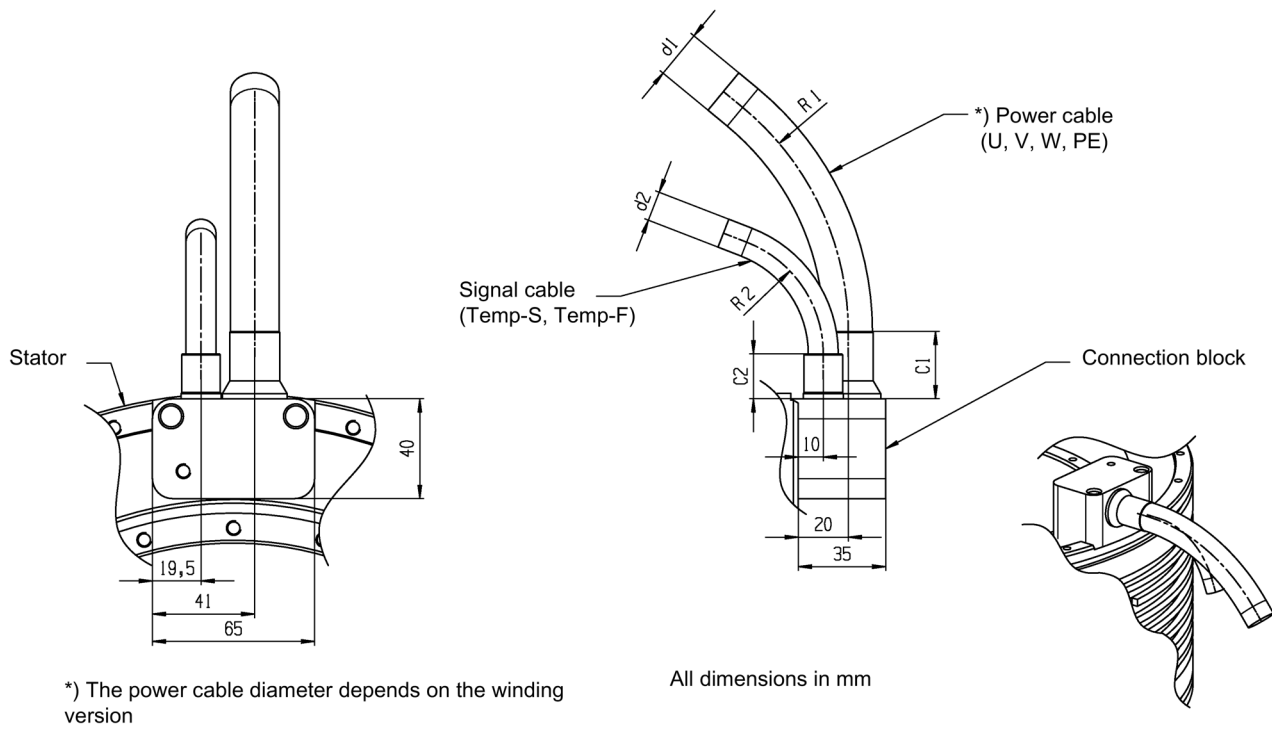

Figure 8-14 Electrical connection (radial, outward) with sleeve for 1FW615

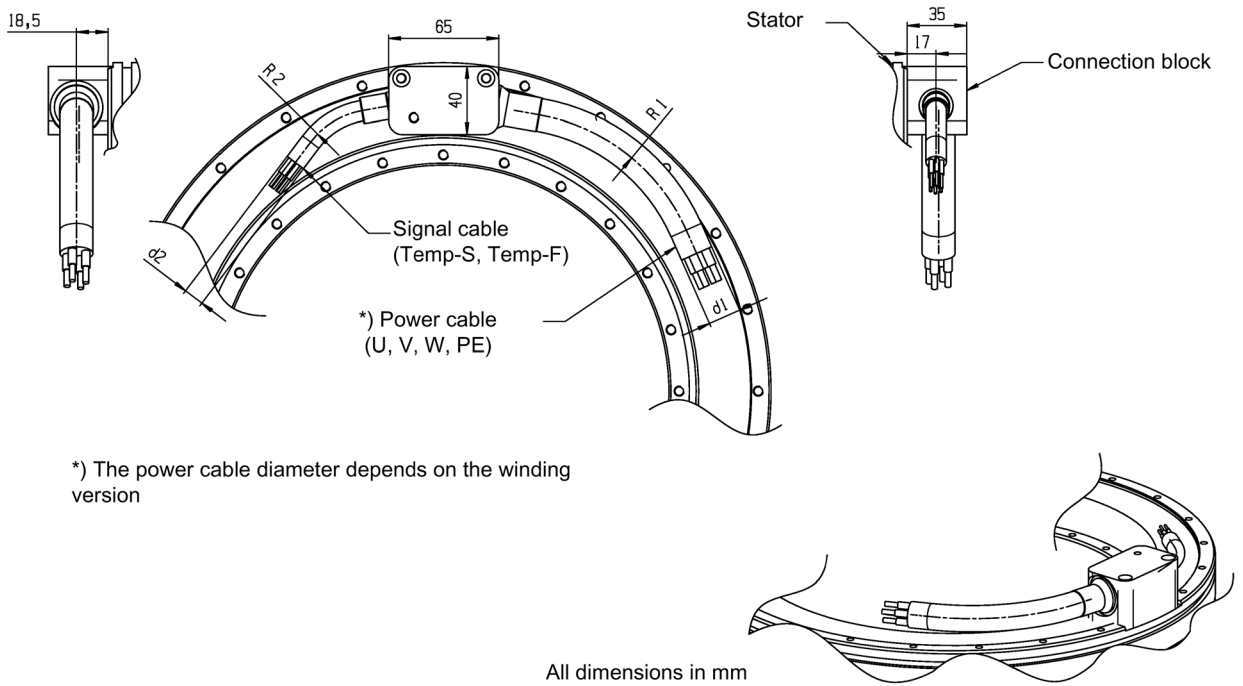

Figure 8-15 Electrical connection (tangential) with sleeve for 1FW615

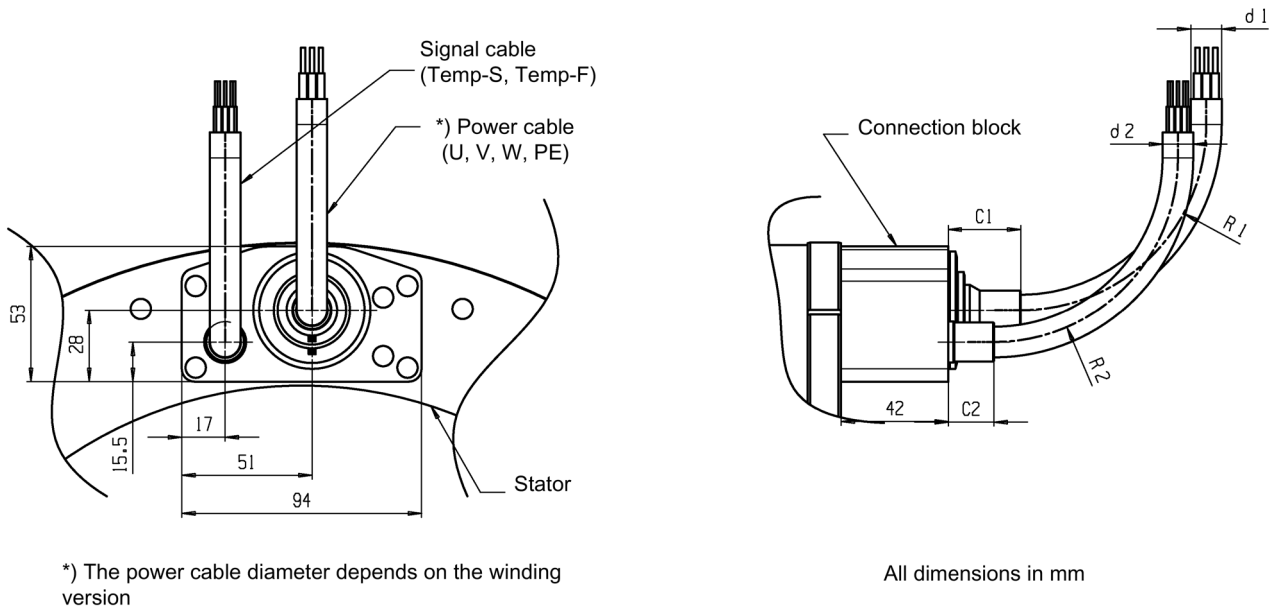

Figure 8-16 Electrical connection (axial) with sleeve for 1FW616, 1FW619, and 1FW623

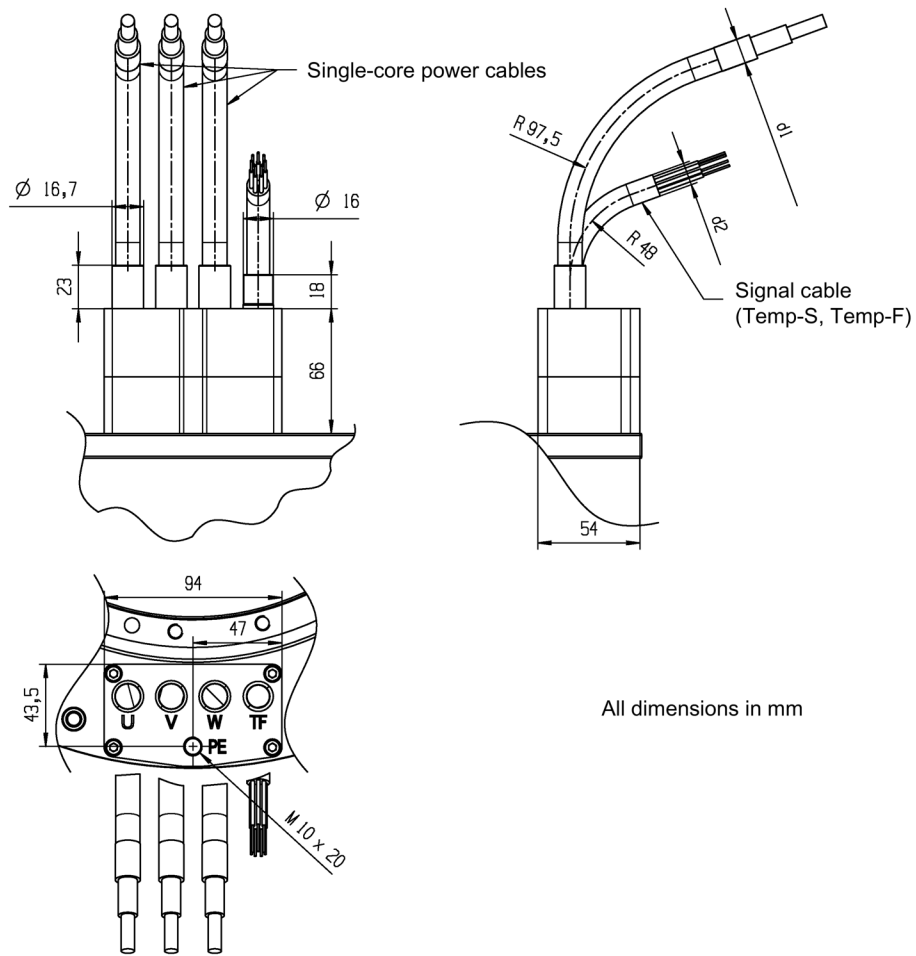

Figure 8-17 Electrical connection (axial) with sleeve and single core for 1FW616, 1FW619, and 1FW623, 25 mm² core cross-section

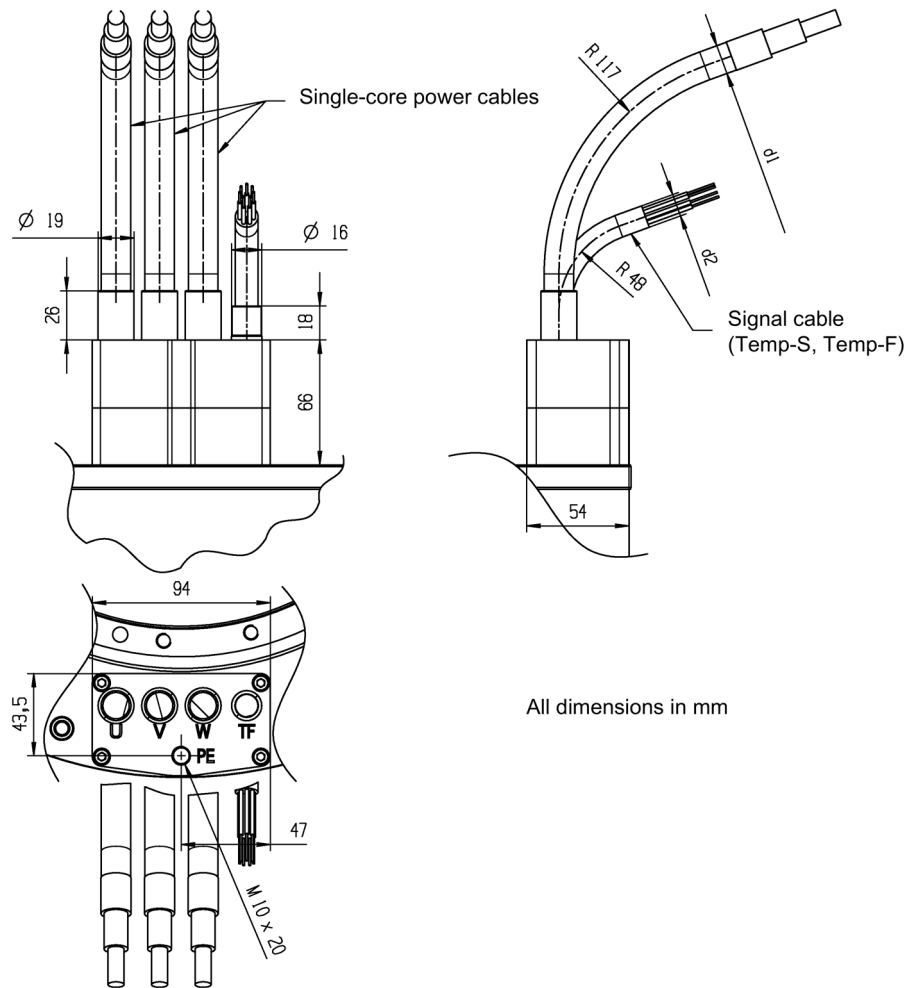

Figure 8-18 Electrical connection (axial) with sleeve and single core for 1FW623, 35 mm² core cross-section

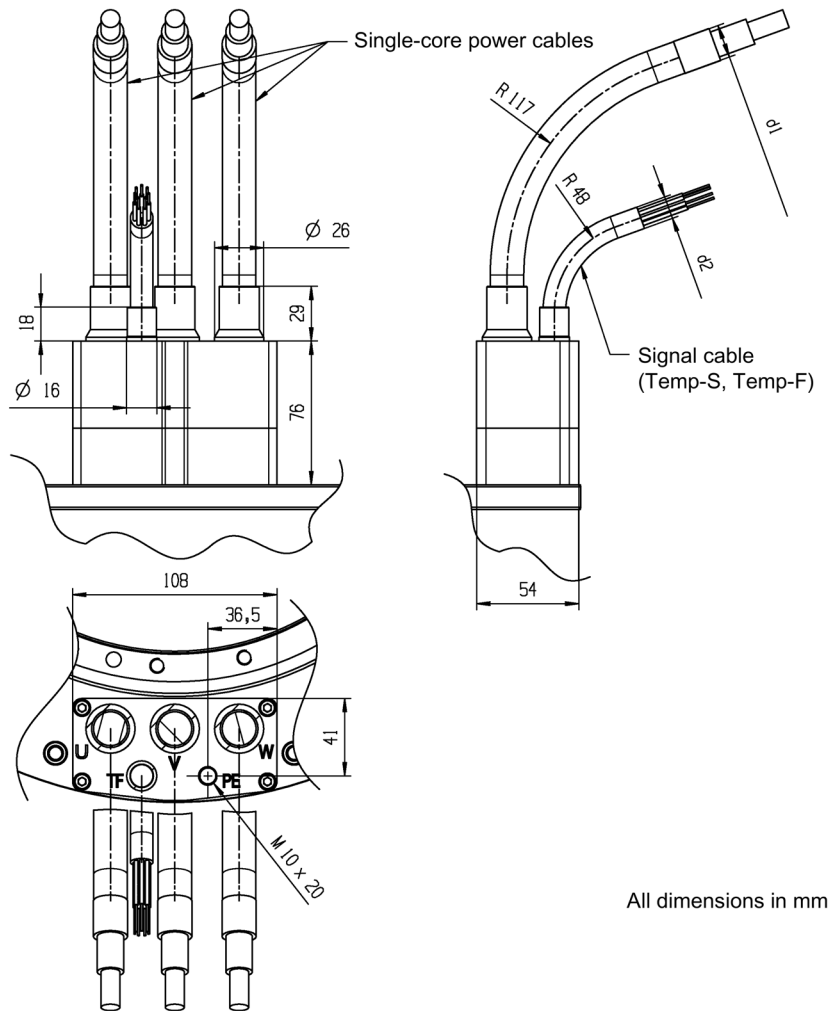

Figure 8-19 Electrical connection (axial) with sleeve and single core for 1FW616 and 1FW619, 50 mm² core cross-section

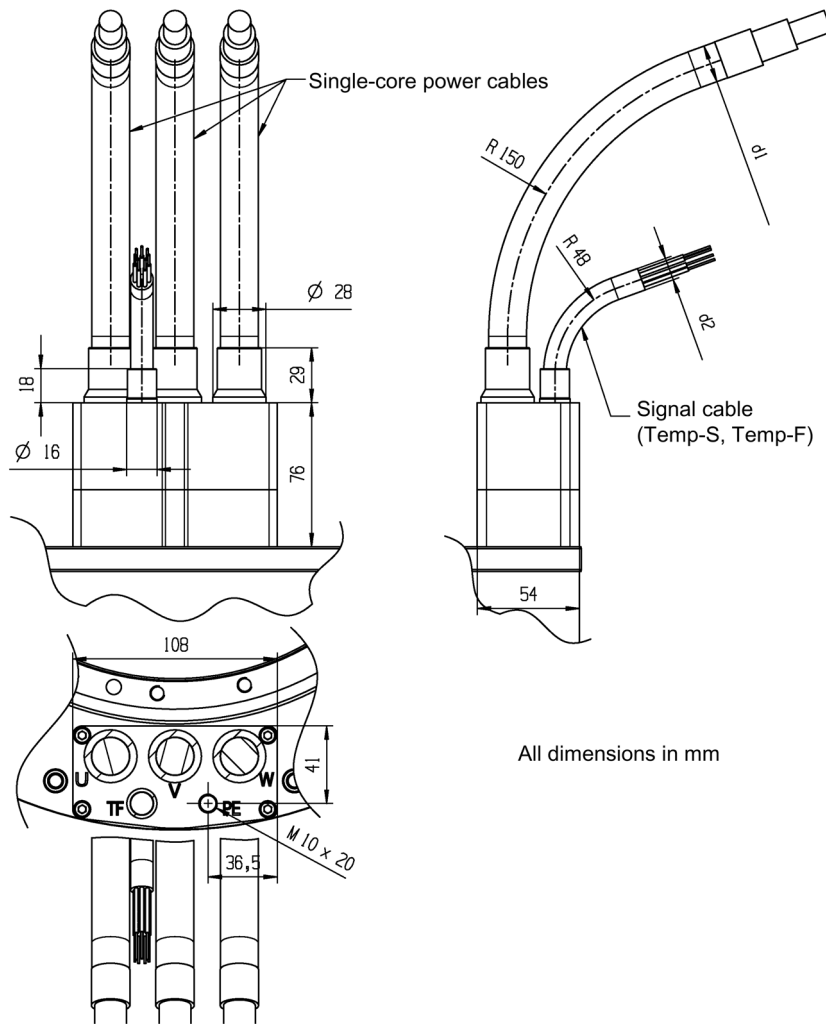

Figure 8-20 Electrical connection (axial) with sleeve and single core for 1FW616, 1FW619, and 1FW623, 70 mm² core cross-section

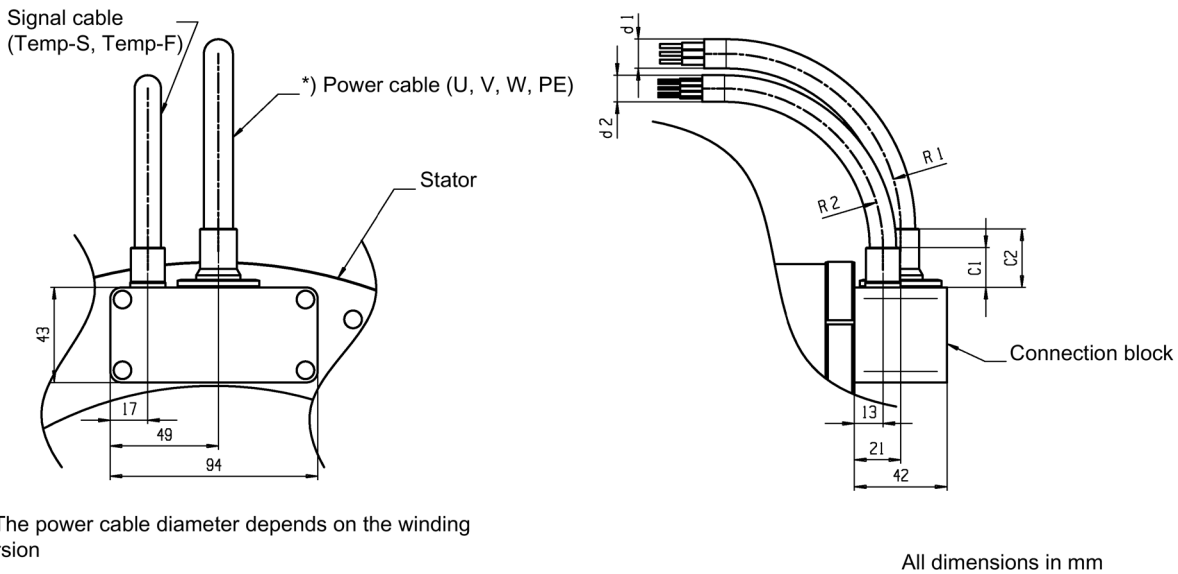

Figure 8-21 Electrical connection (radial, outward) with sleeve for 1FW616, 1FW619, and 1FW623 up to 6 mm² core cross-section

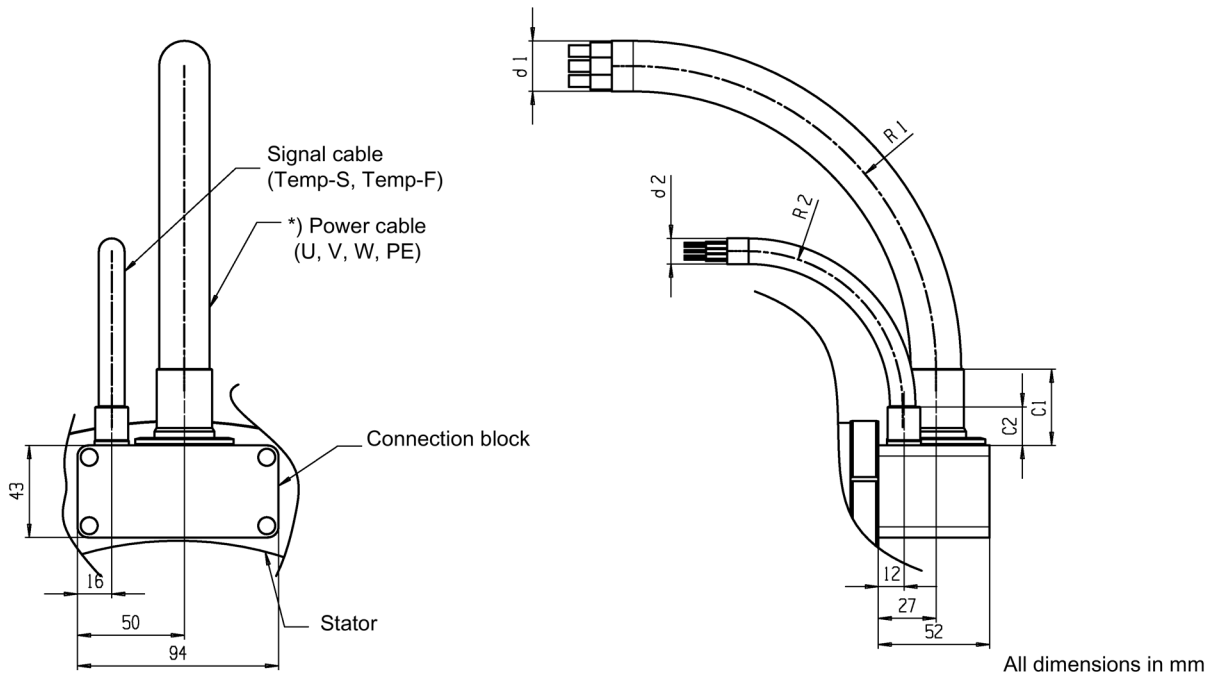

Figure 8-22 Electrical connection (radial, outward) with sleeve for 1FW616, 1FW619, and 1FW623 as of 10 mm² core cross-section

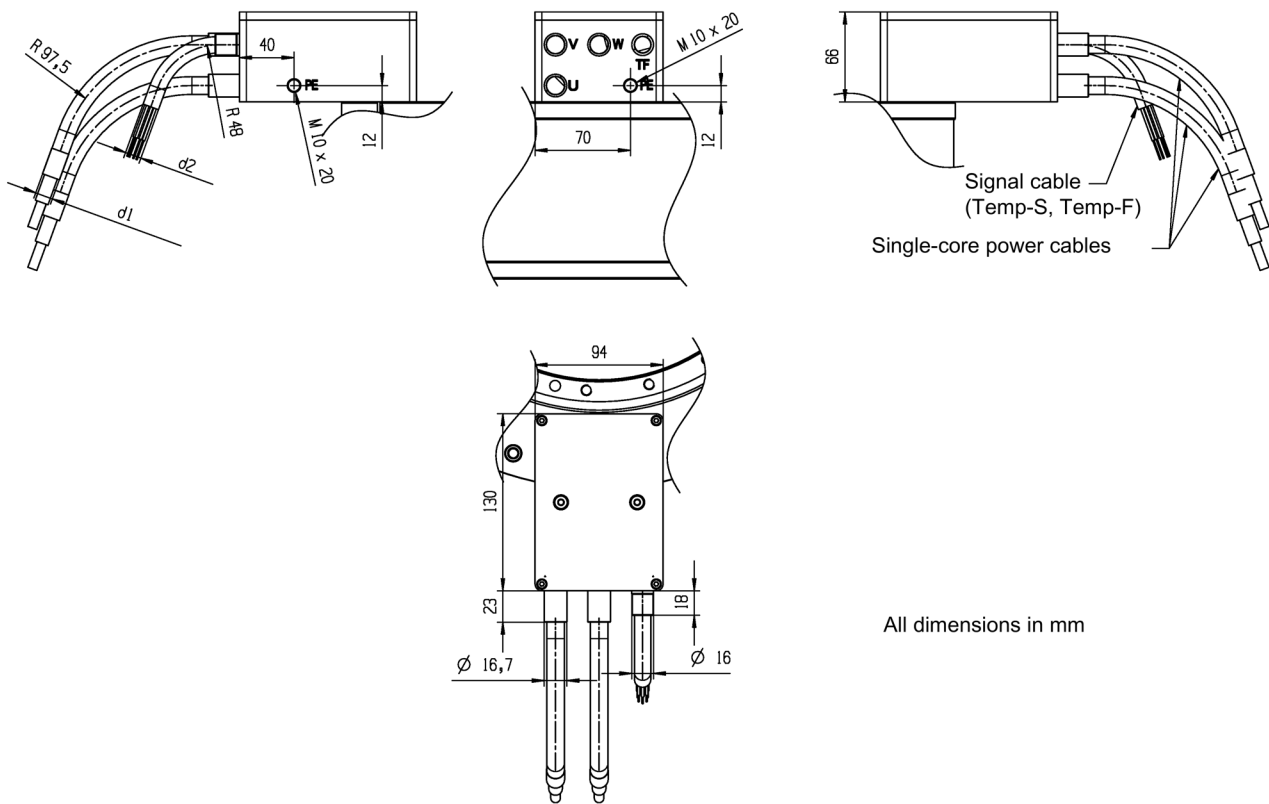

Figure 8-23 Electrical connection (radial, outward) with sleeve and single core for 1FW616, 1FW619, and 1FW623, 25 mm² core cross-section

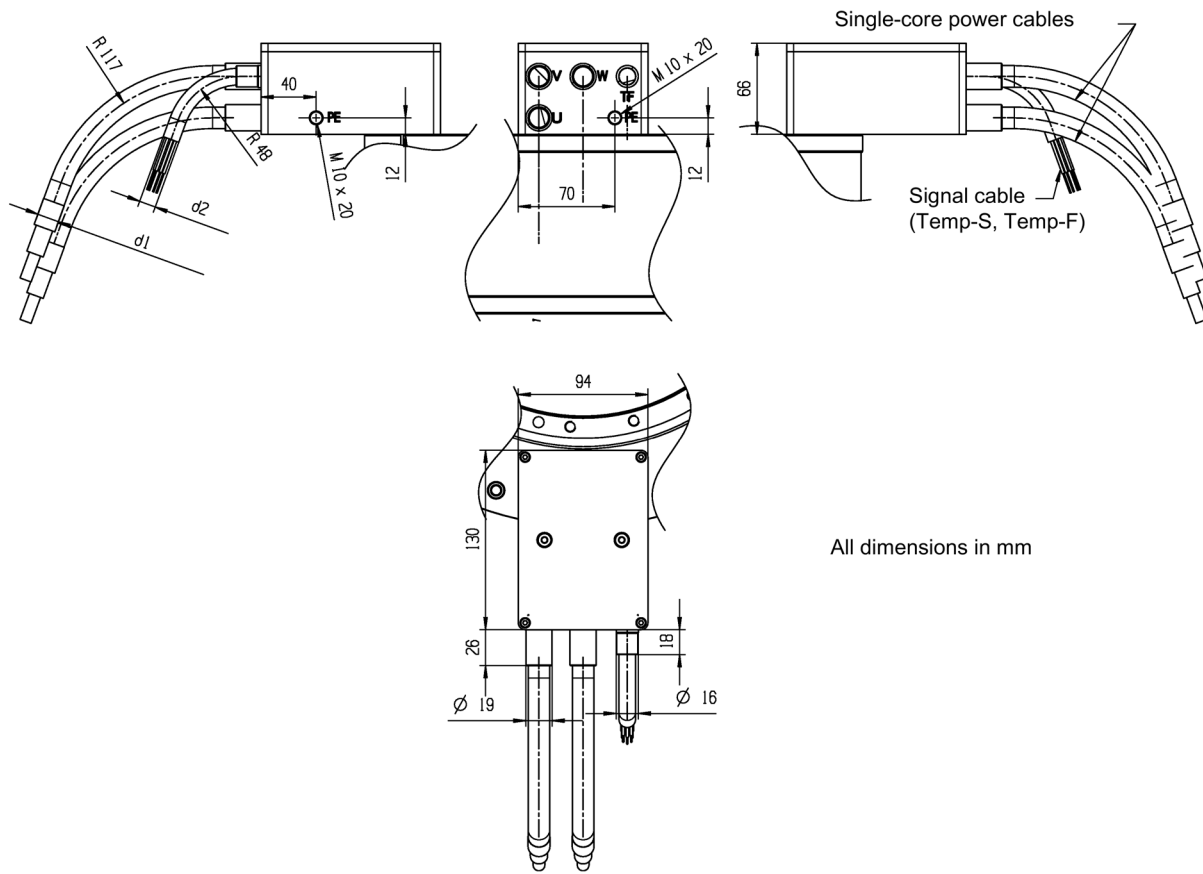

Figure 8-24 Electrical connection (radial, outward) with sleeve and single core for 1FW623, 35 mm² core cross-section

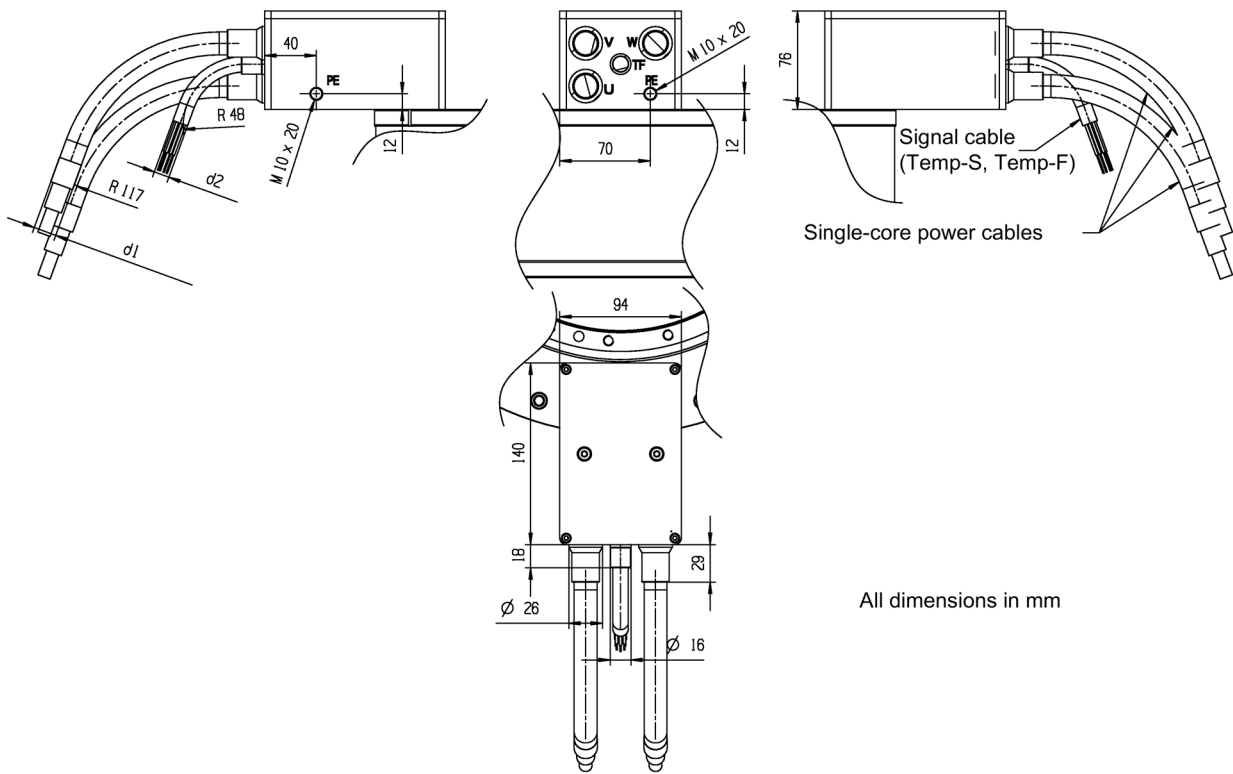

Figure 8-25 Electrical connection (radial, outward) with sleeve and single core for 1FW616 and 1FW619, 50 mm² core cross-section

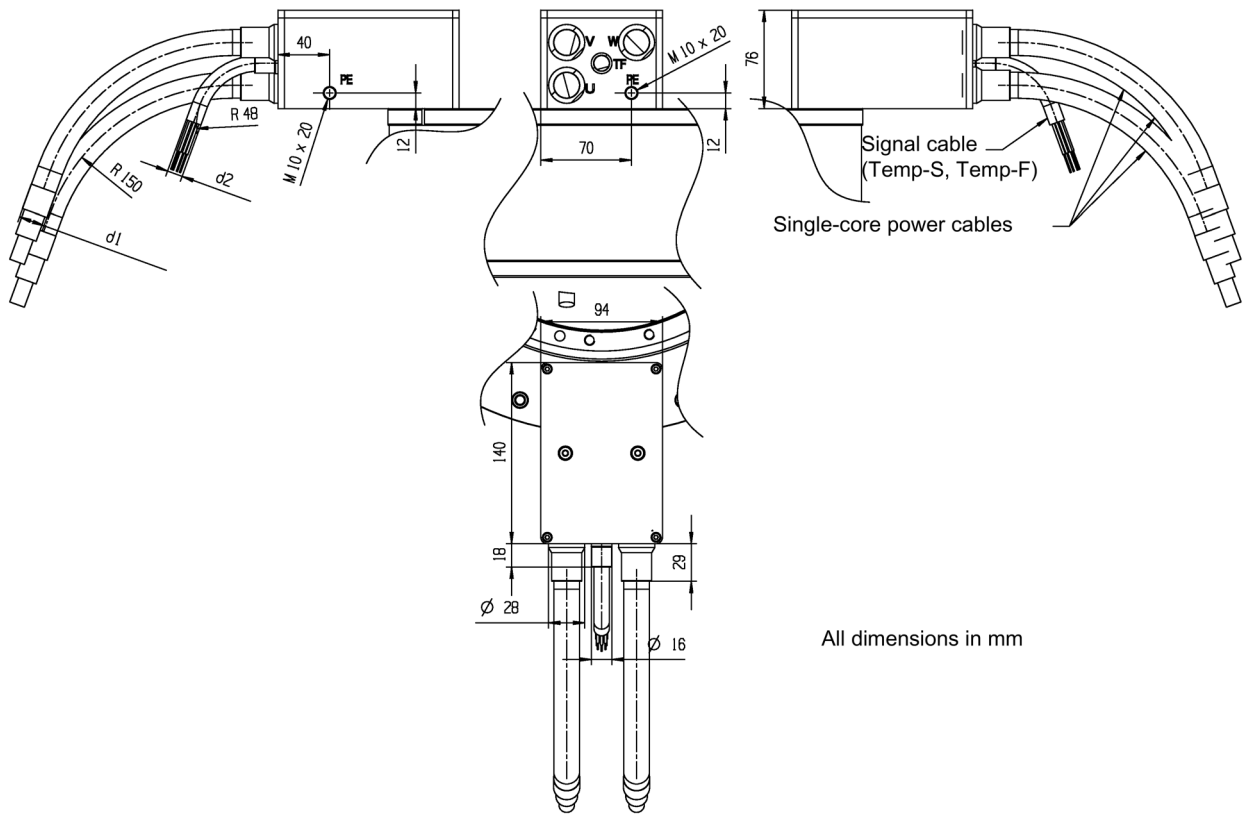

Figure 8-26 Electrical connection (radial, outward) with sleeve and single core for 1FW616, 1FW619, and 1FW623, 70 mm² core cross-section

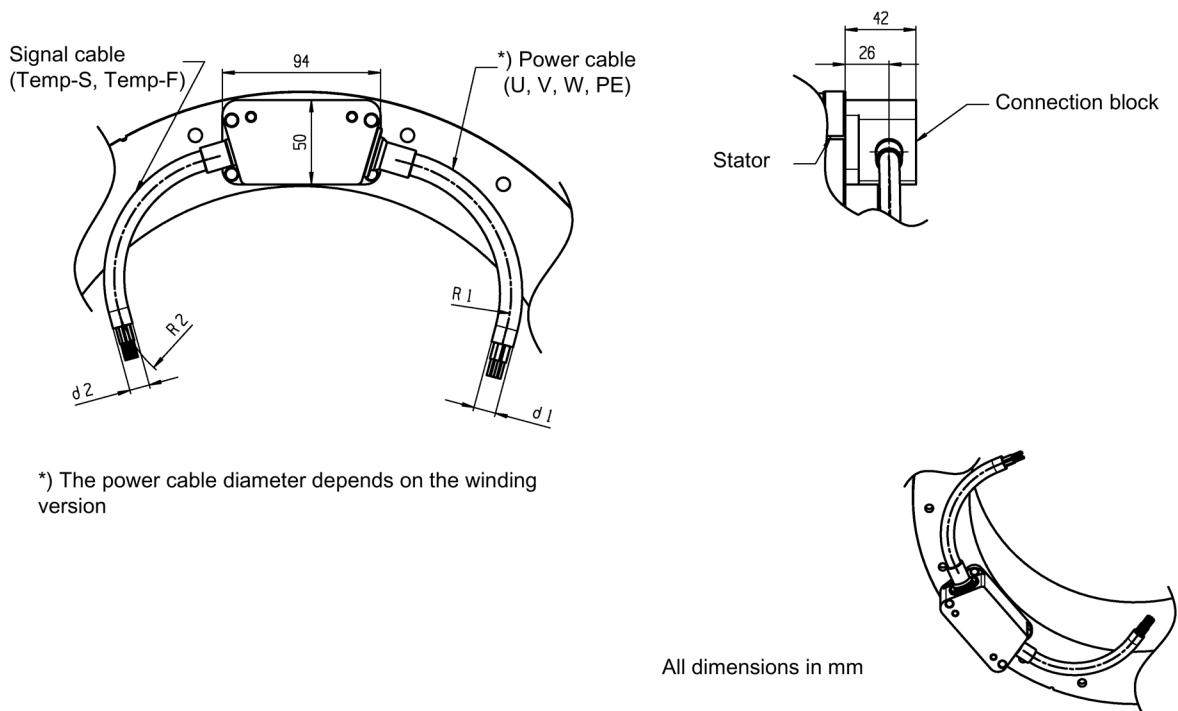

Figure 8-27 Electrical connection (tangential) with sleeve for 1FW616, 1FW619, and 1FW623

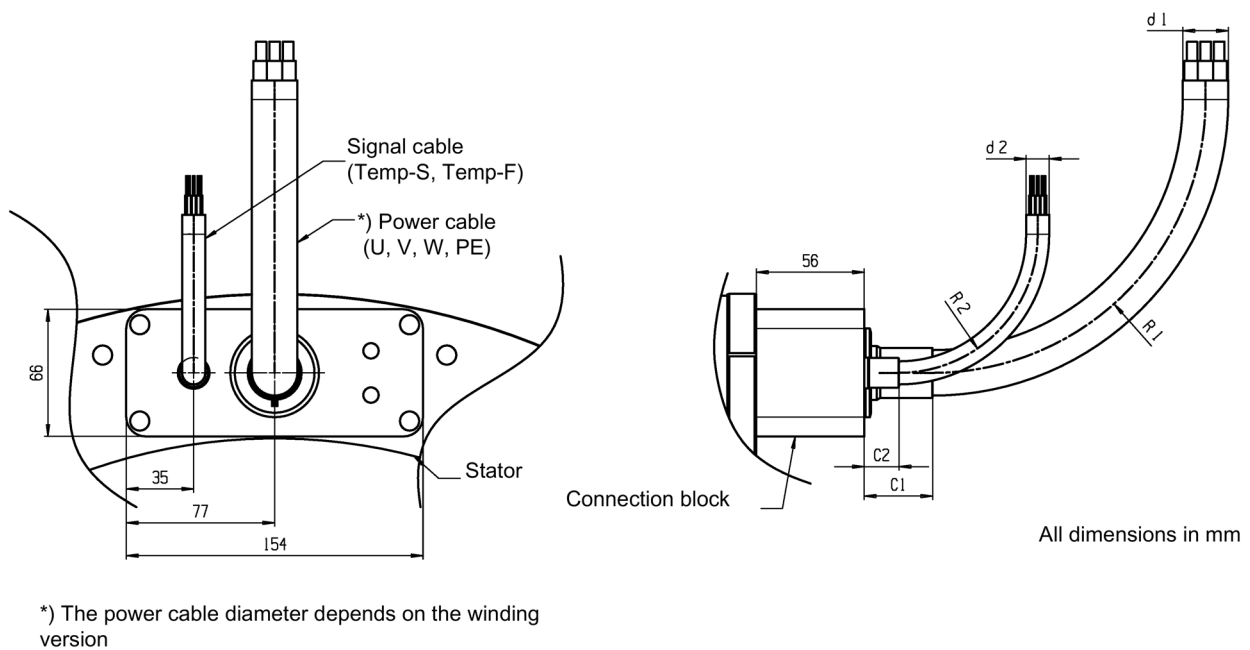
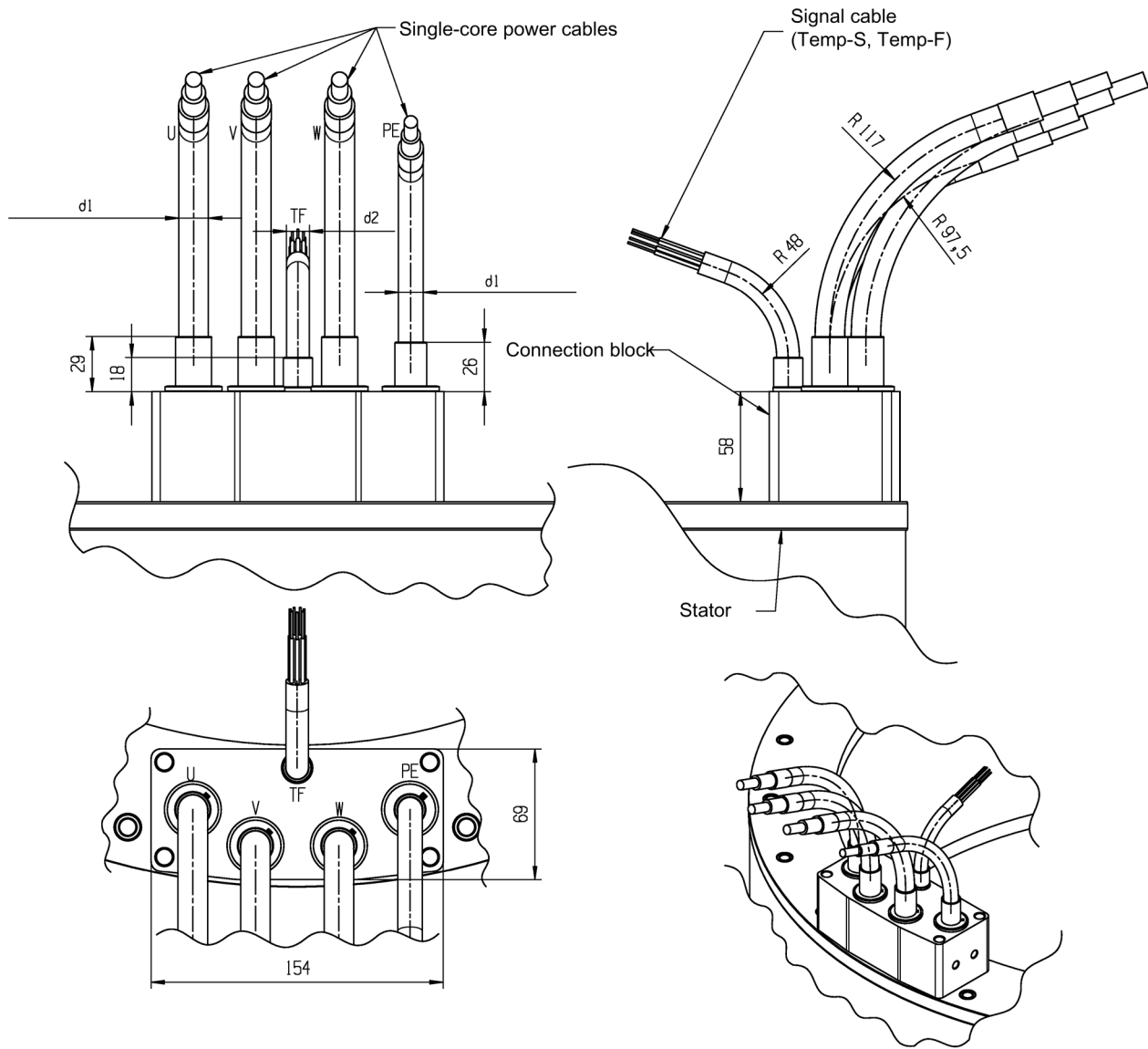

Figure 8-28 Electrical connection (axial) with sleeve for 1FW629



All dimensions in mm

Figure 8-29 Electrical connection (axial) with sleeve and single core for 1FW629, 35 mm² core cross-section

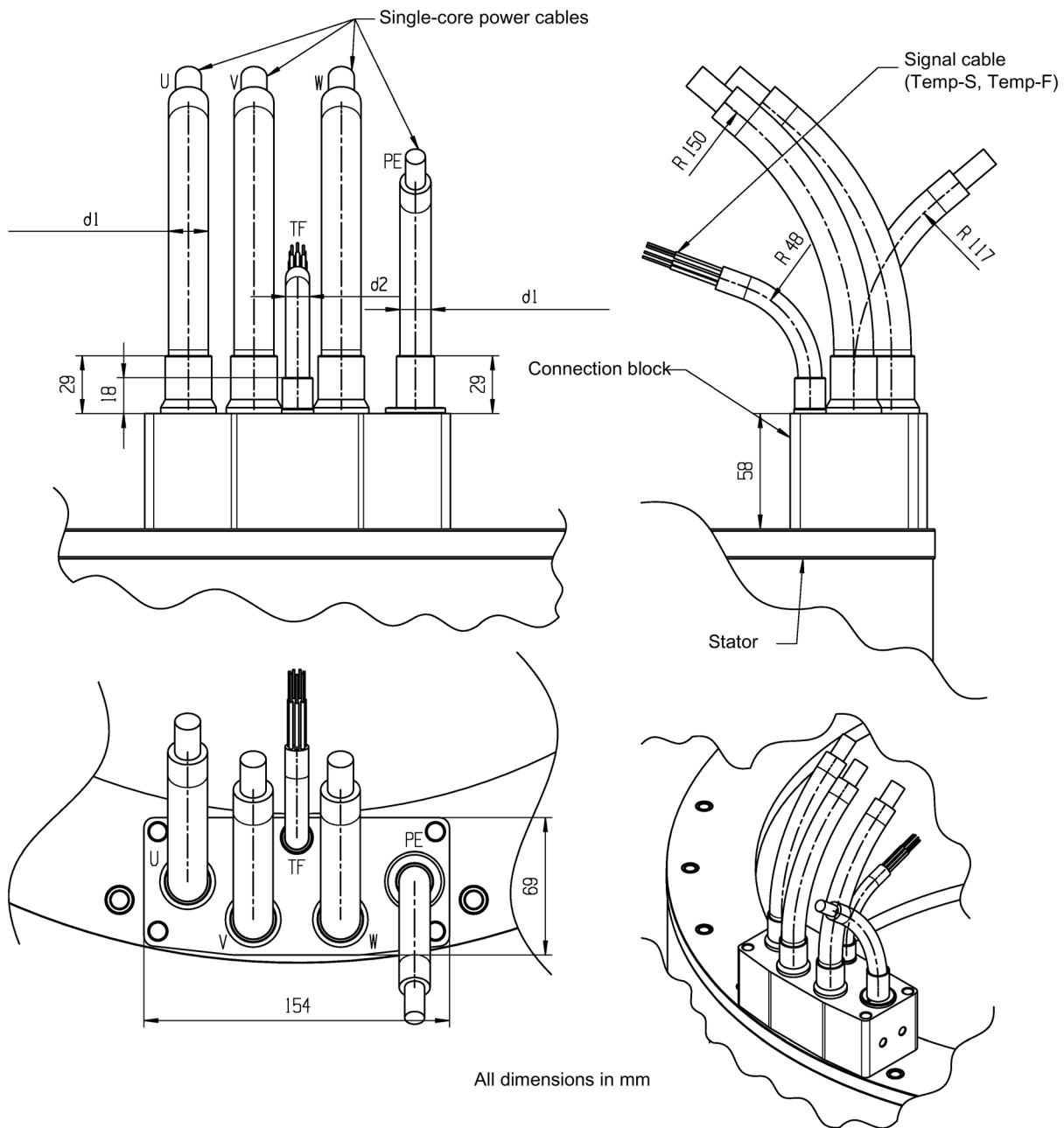
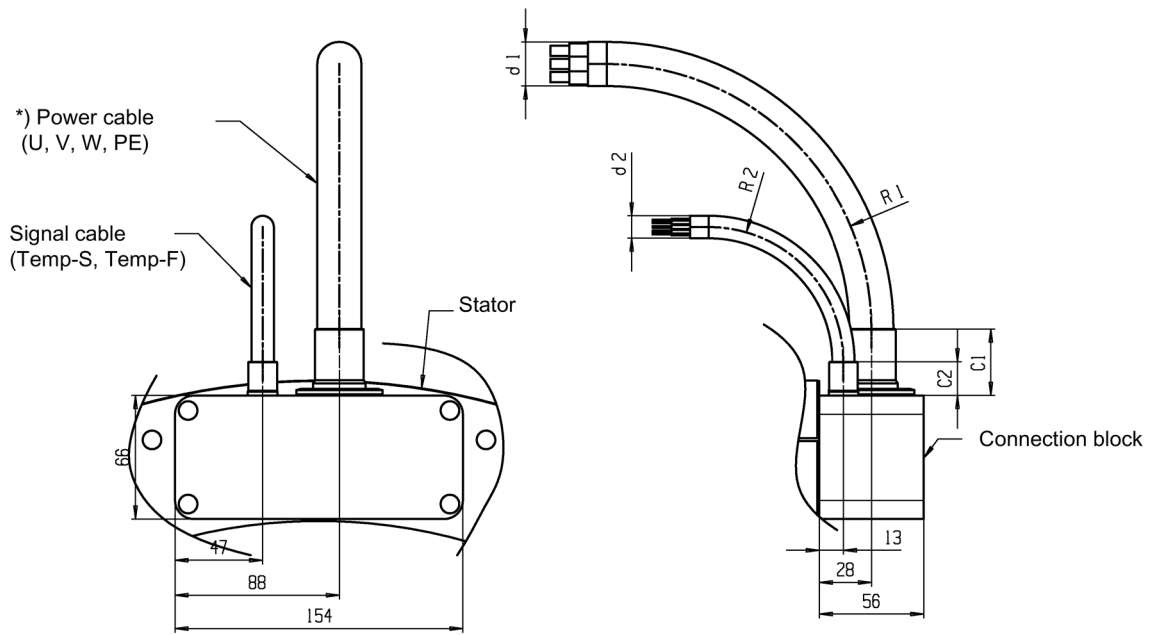

Figure 8-30 Electrical connection (axial) with sleeve and single core for 1FW629, 70 mm² core cross-section



*) The power cable diameter depends on the winding version

All dimensions in mm

Figure 8-31 Electrical connection (radial, outward) with sleeve for 1FW629

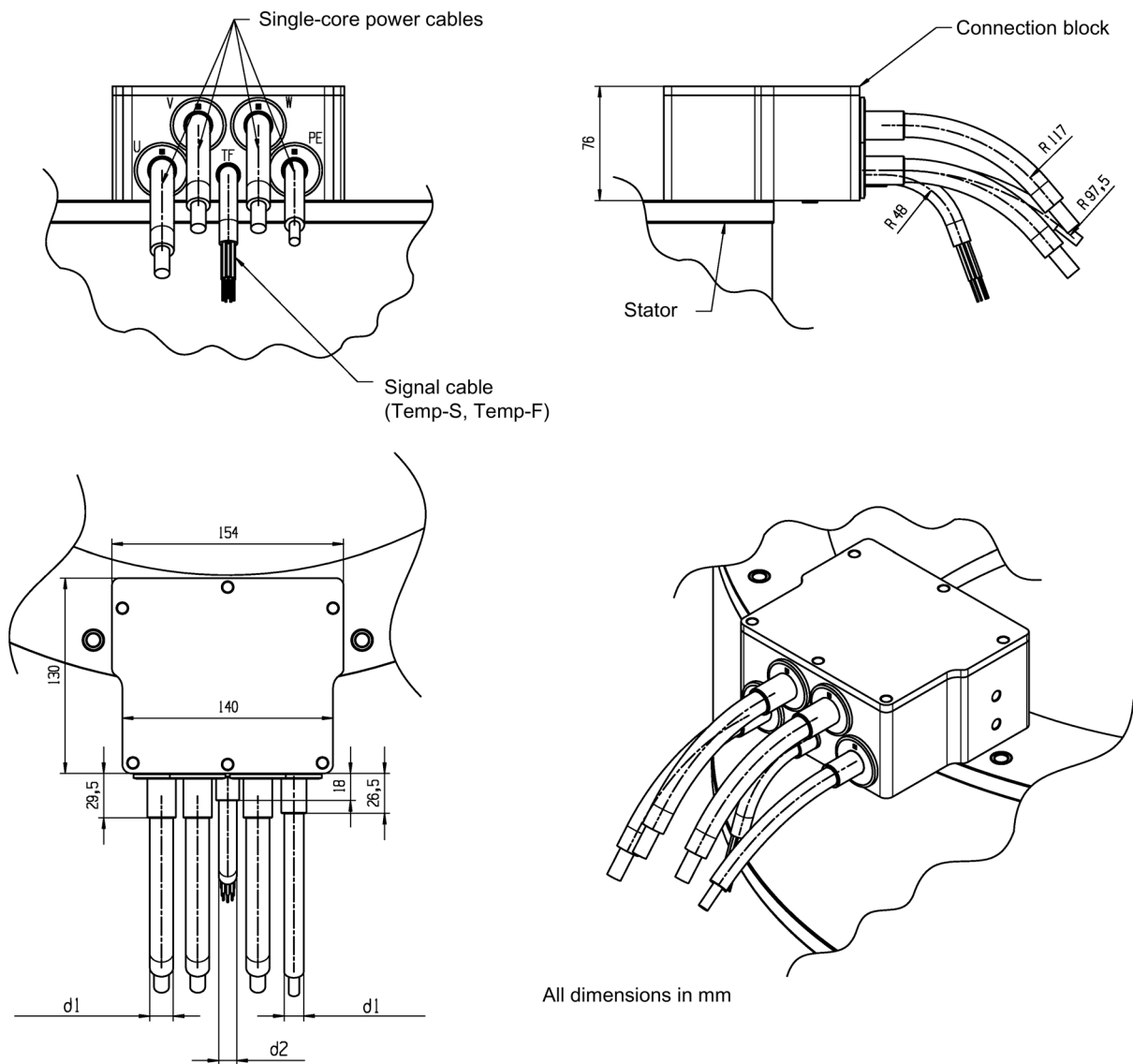

Figure 8-32 Electrical connection (radial, outward) with sleeve and single core for 1FW629, 35 mm² core cross-section

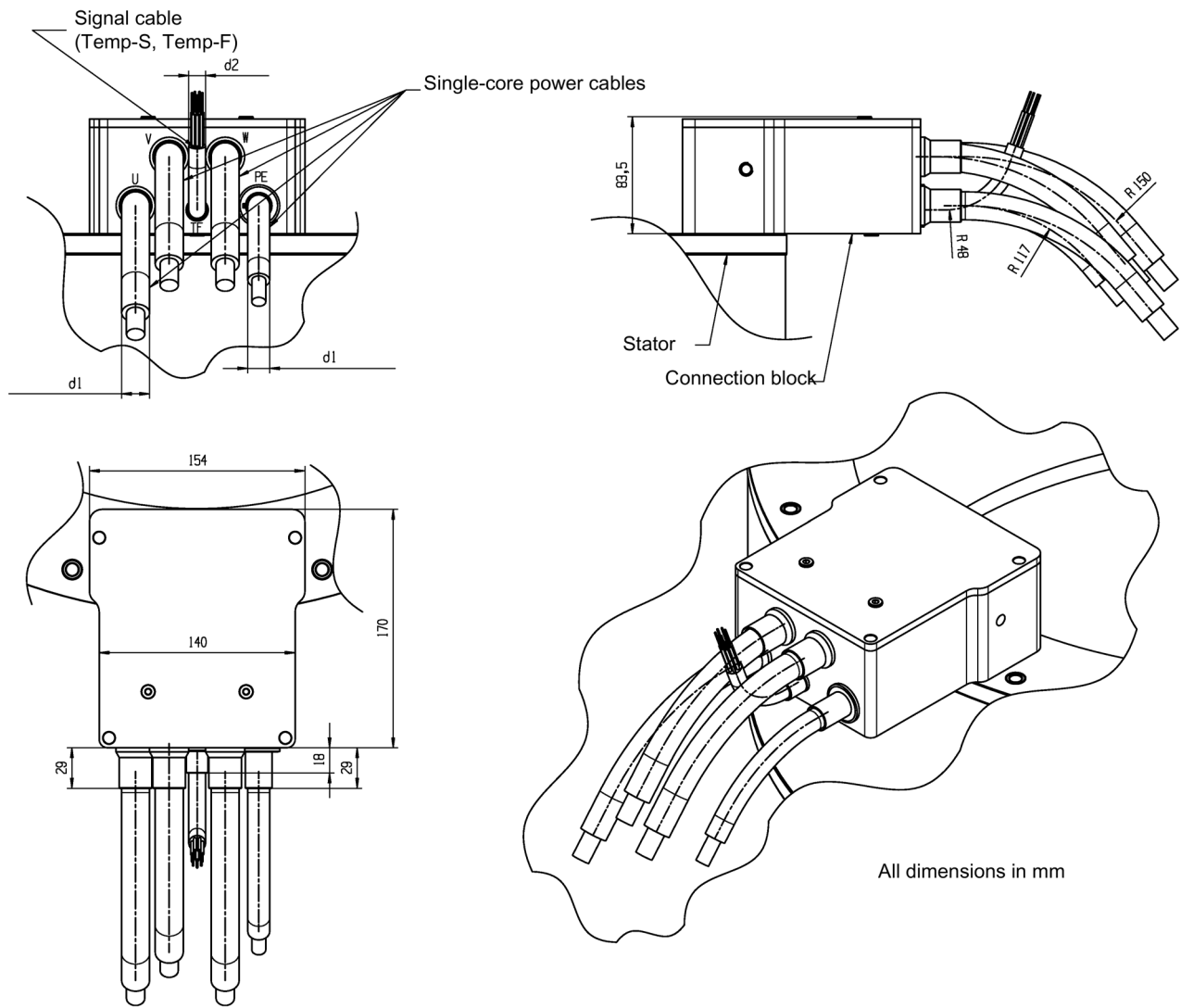

Figure 8-33 Electrical connection (radial, outward) with sleeve and single core for 1FW629, 70 mm² core cross-section

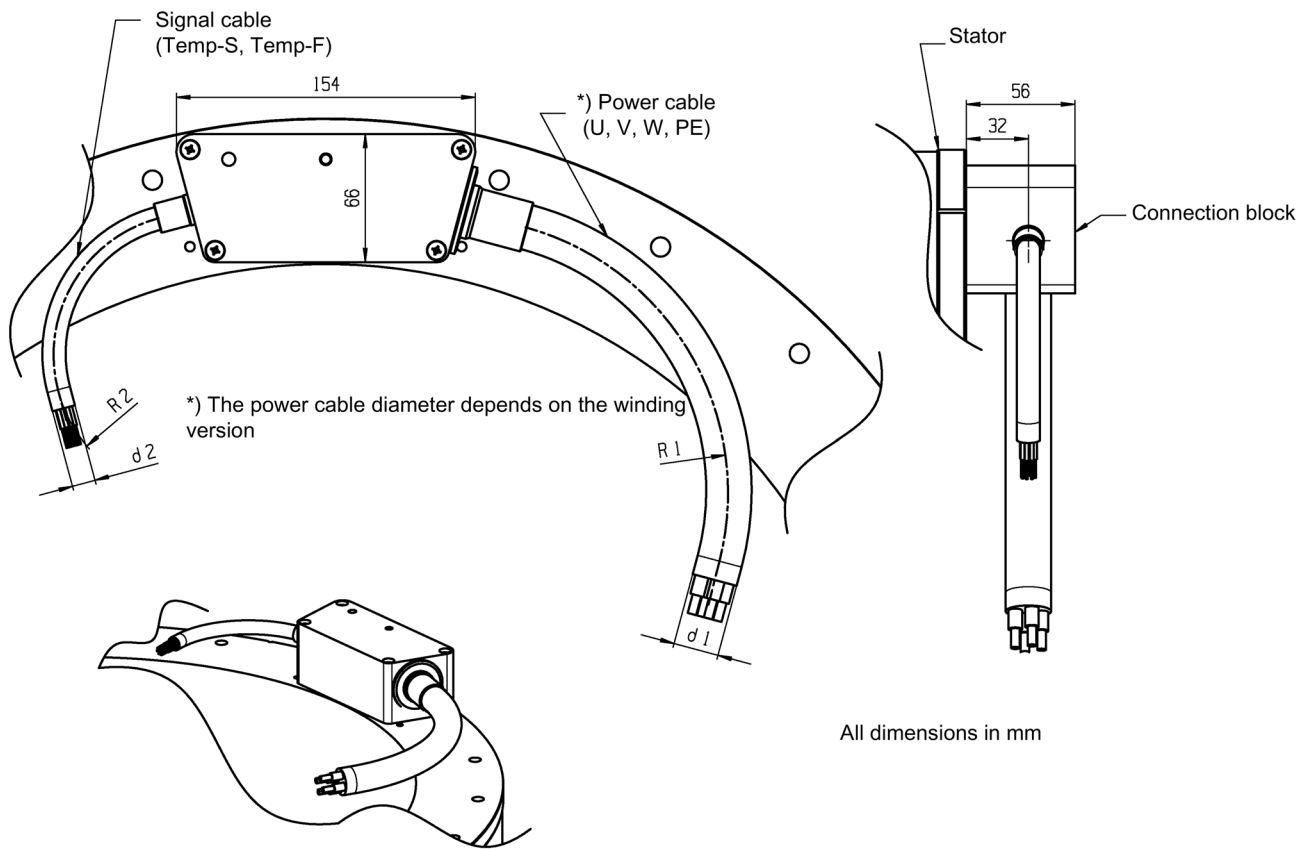

Figure 8-34 Electrical connection (tangential) with sleeve for 1FW629

8.3.6 Data for the power cable at the stator

Table 8- 4 Data for the power cable at the stator

Motor type	Max. diameter "d1" in mm ¹⁾	No. of cores x cross- section in mm ²	Min. bending radius "R1" in mm ¹⁾	Max. height of sleeve "C1" in mm	Connector size ²⁾
1FW6050-xxB03-0Fxx	11	4x2.5	44	18	1
1FW6050-xxB05-0Fxx	11	4x2.5	44	18	1
1FW6050-xxB07-0Fxx	11	4x2.5	44	18	1
1FW6050-xxB07-0Kxx	11	4x2.5	44	18	1
1FW6050-xxB10-0Kxx	11	4x2.5	44	18	1
1FW6050-xxB15-0Kxx	11	4x2.5	44	18	1
1FW6050-xxB15-1Jxx	11	4x2.5	44	18	1
1FW6060-xxB03-0Fxx	11	4x2.5	44	18	1
1FW6060-xxB05-0Fxx	11	4x2.5	44	18	1
1FW6060-xxB05-0Kxx	11	4x2.5	44	18	1
1FW6060-xxB07-0Fxx	11	4x2.5	44	18	1
1FW6060-xxB07-0Kxx	11	4x2.5	44	18	1
1FW6060-xxB10-0Kxx	11	4x2.5	44	18	1
1FW6060-xxB10-1Jxx	11	4x2.5	44	18	1
1FW6060-xxB15-0Kxx	11	4x2.5	44	18	1
1FW6060-xxB15-1Jxx	11	4x2.5	44	18	1
1FW6090-xxB05-0Fxx	11	4x2.5	44	18	1
1FW6090-xxB05-0Kxx	11	4x2.5	44	18	1
1FW6090-xxB07-0Kxx	11	4x2.5	44	18	1
1FW6090-xxB07-1Jxx	11	4x2.5	44	18	1
1FW6090-xxB10-0Kxx	11	4x2.5	44	18	1
1FW6090-xxB10-1Jxx	11	4x2.5	44	18	1
1FW6090-xxB15-1Jxx	11	4x2.5	44	18	1
1FW6090-xxB15-2Jxx	12.3	4x4.0	49.2	23	1.5
1FW6130-xxB05-0Kxx	11	4x2.5	44	18	1
1FW6130-xxB05-1Jxx	11	4x2.5	44	18	1
1FW6130-xxB07-0Kxx	11	4x2.5	44	18	1
1FW6130-xxB07-1Jxx	11	4x2.5	44	18	1
1FW6130-xxB10-1Jxx	11	4x2.5	44	18	1
1FW6130-xxB10-2Jxx	12.3	4x4.0	49.2	23	1.5
1FW6130-xxB15-1Jxx	11	4x2.5	44	18	1
1FW6130-xxB15-2Jxx	12.3	4x4.0	49.2	23	1.5
1FW6150-xxB05-1Jxx	11	4x2.5	44	18	1
1FW6150-xxB05-4Fxx	18.2	4x10.0	72.8	29	1.5
1FW6150-xxB07-2Jxx	12.3	4x4.0	49.2	23	1.5
1FW6150-xxB07-4Fxx	18.2	4x10.0	72.8	29	1.5

Motor type	Max. diameter "d1" in mm ¹⁾	No. of cores x cross- section in mm ²	Min. bending radius "R1" in mm ¹⁾	Max. height of sleeve "C1" in mm	Connector size ²⁾
1FW6150-xxB10-2Jxx	12.3	4x4.0	49.2	23	1.5
1FW6150-xxB10-4Fxx	18.2	4x10.0	72.8	29	1.5
1FW6150-xxB15-2Jxx	18.2	4x10.0	72.8	29	1.5
1FW6150-xxB15-4Fxx	18.2	4x10.0	72.8	29	1.5
1FW6160-xxB05-1Jxx	11	4x2.5	44	18	1
1FW6160-xxB05-2Jxx	12.3	4x4.0	49.2	23	1.5
1FW6160-xxB05-5Gxx	22.3	4x16.0	89.2	35.5	1.5
1FW6160-xxB07-1Jxx	11	4x2.5	44	18	1
1FW6160-xxB07-2Jxx	12.3	4x4.0	49.2	23	1.5
1FW6160-xxB07-5Gxx	22.3	4x16.0	89.2	35.5	1.5
1FW6160-xxB07-8Fxx	13.5	3x(1x25) + M10 f. PE (1x25)*	40.5	23	-
1FW6160-xxB10-1Jxx	11	4x2.5	44	18	1
1FW6160-xxB10-2Jxx	12.3	4x4.0	49.2	23	1.5
1FW6160-xxB10-5Gxx	22.3	4x16.0	89.2	35.5	1.5
1FW6160-xxB10-8Fxx	13.5	3x(1x25) + M10 f. PE (1x25)*	40.5	23	-
1FW6160-xxB10-2Pxx	18.2	3x(1x50) + M10 f. PE (1x25)*	54.6	29	-
1FW6160-xxB15-2Jxx	12.3	4x4.0	49.2	23	1.5
1FW6160-xxB15-5Gxx	22.3	4x16.0	89.2	35.5	1.5
1FW6160-xxB15-8Fxx	13.5	3x(1x25) + M10 f. PE (1x25)*	40.5	23	-
1FW6160-xxB15-2Pxx	18.2	3x(1x50) + M10 f. PE (1x25)*	54.6	29	-
1FW6160-xxB15-0Wxx	20.5	3x(1x70) + M10 f. PE (1x35)*	61.5	29	-
1FW6160-xxB20-5Gxx	22.3	4x16.0	89.2	35.5	1.5
1FW6160-xxB20-8Fxx	13.5	3x(1x25) + M10 f. PE (1x25)*	40.5	23	-
1FW6160-xxB20-2Pxx	18.2	3x(1x50) + M10 f. PE (1x25)*	54.6	29	-
1FW6160-xxB20-0Wxx	20.5	3x(1x70) + M10 f. PE (1x35)*	61.5	29	-
1FW6190-xxB05-1Jxx	11	4x2.5	44	18	1
1FW6190-xxB05-2Jxx	12.3	4x4.0	49.2	23	1.5
1FW6190-xxB05-5Gxx	22.3	4x16.0	89.2	35.5	1.5
1FW6190-xxB07-1Jxx	11	4x2.5	44	18	1
1FW6190-xxB07-2Jxx	12.3	4x4.0	49.2	23	1.5
1FW6190-xxB07-5Gxx	22.3	4x16.0	89.2	35.5	1.5
1FW6190-xxB07-8Fxx	13.5	3x(1x25) + M10 f. PE (1x25)*	40.5	23	-

8.3 System integration

Motor type	Max. diameter "d1" in mm 1)	No. of cores x cross-section in mm ²	Min. bending radius "R1" in mm 1)	Max. height of sleeve "C1" in mm	Connector size 2)
1FW6190-xxB10-1Jxx	11	4x2.5	44	18	1
1FW6190-xxB10-2Jxx	12.3	4x4.0	49.2	23	1.5
1FW6190-xxB10-5Gxx	22.3	4x16.0	89.2	35.5	1.5
1FW6190-xxB10-8Fxx	13.5	3x(1x25) + M10 f. PE (1x25)*	40.5	23	-
1FW6190-xxB10-2Pxx	18.2	3x(1x50) + M10 f. PE (1x25)*	54.6	29	-
1FW6190-xxB15-2Jxx	12.3	4x4.0	49.2	23	1.5
1FW6190-xxB15-5Gxx	22.3	4x16.0	89.2	35.5	1.5
1FW6190-xxB15-8Fxx	13.5	3x(1x25) + M10 f. PE (1x25)*	40.5	23	-
1FW6190-xxB15-2Pxx	18.2	3x(1x50) + M10 f. PE (1x25)*	54.6	29	-
1FW6190-xxB15-0Wxx	20.5	3x(1x70) + M10 f. PE (1x35)*	61.5	29	-
1FW6190-xxB20-5Gxx	22.3	4x16.0	89.2	35.5	1.5
1FW6190-xxB20-8Fxx	13.5	3x(1x25) + M10 f. PE (1x25)*	40.5	23	-
1FW6190-xxB20-2Pxx	18.2	3x(1x50) + M10 f. PE (1x25)*	54.6	29	-
1FW6190-xxB20-0Wxx	20.5	3x(1x70) + M10 f. PE (1x35)*	61.5	29	-
1FW6230-xxB05-1Jxx	11	4x2.5	44	18	1
1FW6230-xxB05-2Jxx	12.3	4x4.0	49.2	23	1.5
1FW6230-xxB05-5Gxx	22.3	4x16.0	89.2	35.5	1.5
1FW6230-xxB07-1Jxx	11	4x2.5	44	18	1
1FW6230-xxB07-2Jxx	12.3	4x4.0	49.2	23	1.5
1FW6230-xxB07-5Gxx	22.3	4x16.0	89.2	35.5	1.5
1FW6230-xxB07-8Fxx	13.5	3x(1x25) + M10 f. PE (1x25)*	40.5	23	-
1FW6230-xxB10-2Jxx	12.3	4x4.0	49.2	23	1.5
1FW6230-xxB10-5Gxx	22.3	4x16.0	89.2	35.5	1.5
1FW6230-xxB10-8Fxx	13.5	3x(1x25) + M10 f. PE (1x25)*	40.5	23	-
1FW6230-xxB10-2Pxx	16.1	3x(1x35) + M10 f. PE (1x25)*	48.3	26	-
1FW6230-xxB15-4Cxx	14.9	4x6.0	59.6	31.5	1.5
1FW6230-xxB15-5Gxx	22.3	4x16.0	89.2	35.5	1.5
1FW6230-xxB15-8Fxx	13.5	3x(1x25) + M10 f. PE (1x25)*	40.5	23	-
1FW6230-xxB15-2Pxx	16.1	3x(1x35) + M10 f. PE (1x25)*	48.3	26	-

Motor type	Max. diameter "d1" in mm ¹⁾	No. of cores x cross- section in mm ²	Min. bending radius "R1" in mm ¹⁾	Max. height of sleeve "C1" in mm	Connector size ²⁾
1FW6230-xxB15-0Wxx	20.5	3x(1x70) + M10 f. PE (1x35)*	61.5	29	-
1FW6230-xxB20-5Gxx	22.3	4x16.0	89.2	35.5	1.5
1FW6230-xxB20-8Fxx	13.5	3x(1x25) + M10 f. PE (1x25)*	40.5	23	-
1FW6230-xxB20-2Pxx	16.1	3x(1x35) + M10 f. PE (1x25)*	48.3	26	-
1FW6230-xxB20-0Wxx	20.5	3x(1x70) + M10 f. PE (1x35)*	61.5	29	-
1FW6290-xxB07-5Gxx	22.3	4x16.0	89.2	35.5	1.5
1FW6290-xxB07-0Lxx	d(35) = 16.1 d(25) = 13.5	3x(1x35)+1x25	R(35) = 48.3 R(25) = 40.5	26	-
1FW6290-xxB07-2Pxx	d(70) = 20.5 d(35) = 16.1	3x(1x70)+1x35	R(70) = 61.5 R(35) = 48.3	29	-
1FW6290-xxB11-7Axx	22.3	4x16.0	89.2	35.5	1.5
1FW6290-xxB11-0Lxx	d(35) = 16.1 d(25) = 13.5	3x(1x35)+1x25	R(35) = 48.3 R(25) = 40.5	26	-
1FW6290-xxB11-2Pxx	d(70) = 20.5 d(35) = 16.1	3x(1x70)+1x35	R(70) = 61.5 R(35) = 48.3	29	-
1FW6290-xxB15-7Axx	22.3	4x16.0	89.2	35.5	1.5
1FW6290-xxB15-0Lxx	d(35) = 16.1 d(25) = 13.5	3x(1x35)+1x25	R(35) = 48.3 R(25) = 40.5	26	-
1FW6290-xxB15-2Pxx	d(70) = 20.5 d(35) = 16.1	3x(1x70)+1x35	R(70) = 61.5 R(35) = 48.3	29	-
1FW6290-xxB20-0Lxx	d(35) = 16.1 d(25) = 13.5	3x(1x35)+1x25	R(35) = 48.3 R(25) = 40.5	26	-
1FW6290-xxB20-2Pxx	d(70) = 20.5 d(35) = 16.1	3x(1x70)+1x35	R(70) = 61.5 R(35) = 48.3	29	-

¹⁾ Power cable fixed; ²⁾ Applies to motors with connector

*) PE cable to be connected separately; not included in scope of delivery

Table 8- 5 Specifications for the signal cable on the stator

Motor type	Max. diameter "d2" in mm ¹⁾	No. of cores (signal cores) x crosssection + no. of cores (PE) x cross-section in mm ²	Min. bending radius "R2" in mm ¹⁾	Height of sleeve "C2" in mm	Connector size ²⁾
1FW6xxx-xxxxx-xxxx	11	6 x 0.5 + 1 x 1.0	50	18	M17

1) Signal cable fixed; 2) Applies to motors with connector

8.3.7 PIN assignments for plug connectors

The pin configurations of the plug connectors are subsequently shown. The view is from the plug-in side.

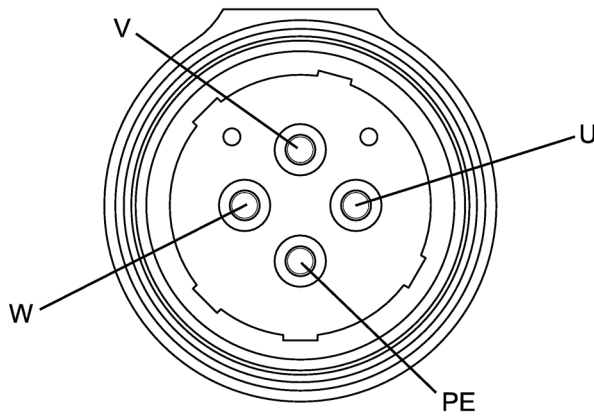

Figure 8-35 Pin configuration, Size 1.5 power connector

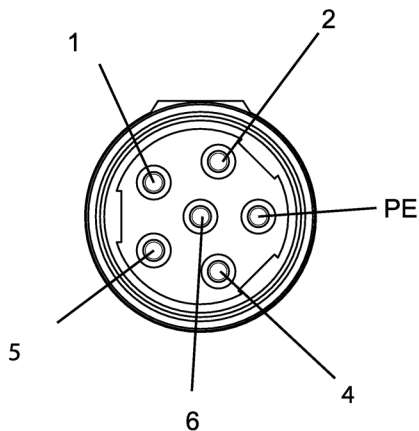

Figure 8-36 Pin configuration, Size 1.0 power connector

Table 8- 6 Pin assignment, Size 1.0 power connector

PIN	Interface
1	U
2	V
PE	PE
4	-
5	-
6	W

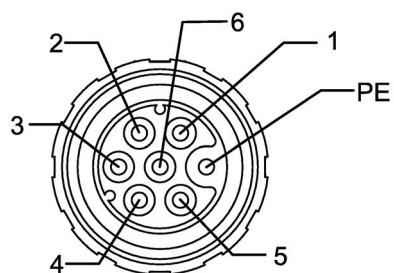

Figure 8-37 Pin configuration, M17 signal connector

Table 8- 7 PIN assignment, M17 signal connector

PIN	Interface
1	-1R2: -KTY or Pt1000
2	+1R1: +KTY or Pt1000
3	1TP1: PTC 130 °C
4	1TP2: PTC 130 °C
5	2TP1: PTC 150 °C *)
6	2TP2: PTC 150 °C *)
⊕	PE

*) PTC 150 °C, optional in conjunction with KTY 84

8.3.8 Power connection

Connection assignment

Table 8- 8 Power connection for torque motor

Converter	Torque motor/stator
U2	U
V2	V
W2	W

For information on connecting the power, also refer to the diagrams relating to "System integration". The rotor rotates clockwise if the torque motor is connected to phase sequence U, V, W. See "Defining the direction of rotation (Page 36)".

8.3.9 Signal connection

No direct connection of the temperature monitoring circuits



! WARNING

Risk of electric shock when incorrectly connecting the temperature monitoring circuit

In the case of a fault, circuits Temp-S and Temp-F do not provide safe electrical separation with respect to the power components.

- Use, for example, the TM120 or the SME12x to connect the Temp-S and Temp-F temperature monitoring circuits. You therefore comply with the directives for safe electrical separation according to EN 61800-5-1 (previously safe electrical separation according to EN 50178).

Correctly connecting temperature sensors

NOTICE

Motor destroyed as a result of overtemperature

The motor can be destroyed as a result of overtemperature if you do not correctly connect the temperature sensors.

- When connecting temperature sensor cables with open conductor ends, pay attention to the correct assignment of conductor colors.

Note

Observe the polarity

Carefully note the polarity when connecting the KTY.

Temperature sensor connection - standard

Connect the signal cable as follows:

- Using a plug connector at the SME12x (Sensor Module External)
- With open cable ends at the TM120

The SME12x or the TM120 is connected to the converter via DRIVE-CLiQ. Refer to the diagrams for "System integration (Page 475)" and the following connection overviews.

Note

Checking the shutdown circuit

Before commissioning and switching on for the first time, carefully check that the Temp-S temperature monitoring circuit correctly shuts down the system when it responds via the SME12x or the TM120.

Typical characteristic $R(\vartheta)$ of a PTC temperature sensor according to DIN 44081 is provided in Chapter "Technical features of temperature sensors (Page 78)".

The following diagram shows a connection overview for frame sizes 1FW605 and 1FW606 with a PTC 130 °C connected via SME12x or TM120.

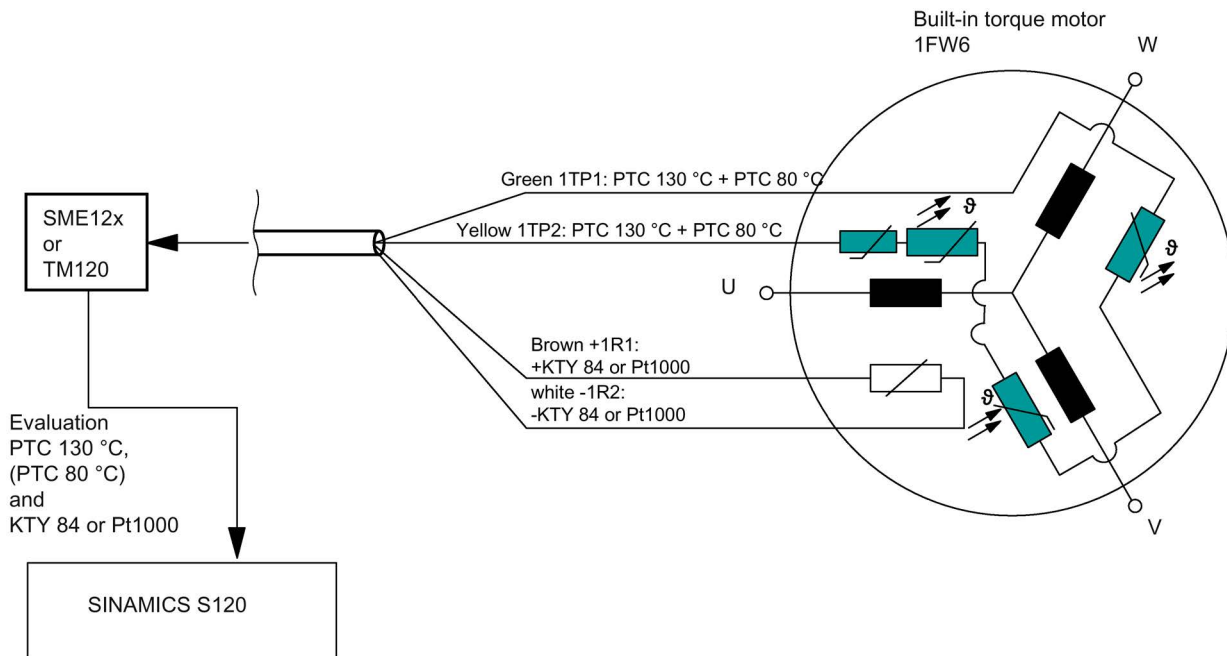

Figure 8-38 Connection overview for 1FW6050xxxxx-xxx1, 1FW6050xxxxx-xxx3, 1FW6060xxxxx-xxx1, 1FW6060xxxxx-xxx3

The following diagram shows a connection overview for frame sizes 1FW609 to 1FW629 with connection of the PTC 130 °C and PTC 150 °C via SME12x or TM120.

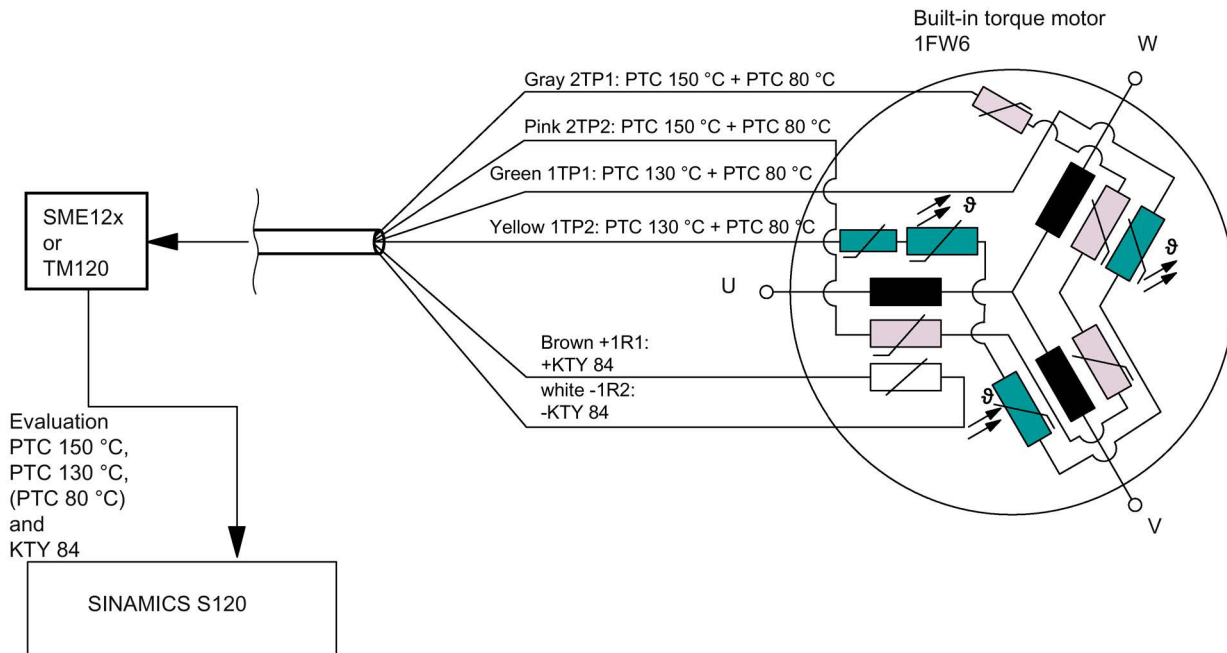

Figure 8-39 Connection overview for 1FW6090-xxxxx-xxx2 to 1FW6290-xxxxx-xxx2

8.3.10 Shielding, grounding, and equipotential bonding

Important notes regarding shielding, grounding and equipotential bonding

The correct installation and connection of the cable shields and protective conductors is of crucial importance, not only for personal safety but also for noise emission and noise immunity.



⚠ WARNING

Risk of electric shock!

Hazardous touch voltages can be present at unused cores and shields if they have not been grounded or insulated.

- Connect the cable shields to the respective housings through the largest possible surface area. Use suitable clips, clamps or screw couplings to do this.
- Connect unused conductors of shielded or unshielded cables and their associated shields to the grounded enclosure potential at one end as minimum.
Alternatively:
Insulate conductors and their associated shields that are not used. The insulation must be able to withstand the rated voltage.

Further, unshielded or incorrectly shielded cables can lead to faults in the drive – particularly the encoder – or in external devices, for example.

Electrical charges that are the result of capacitive cross coupling are discharged by connecting the cores and shields.

NOTICE

Device damage as a result of leakage currents for incorrectly connected protective conductor

High leakage currents may damage other devices if the motor protective conductor is not directly connected to the power module.

- Connect the motor protective conductor (PE) directly at the power unit.

NOTICE

Device damage as a result of leakage currents for incorrect shielding

High leakage currents may damage other devices if the motor power cable shield is not directly connected to the power module.

- Connect the power cable shield at the shield connection of the power module.

Note

Apply the EMC installation guideline of the converter manufacturer. For Siemens converters, this is available under document order No. 6FC5297-□AD30-0□P□.

Note

Single-core power cables without protective earth

With 1FW6 built-in torque motors featuring single-core power cables without a PE cable, a connection point is provided for the PE.

Connect a separate protective conductor cable to this connection point. Pay attention to the specified cross section for direct connection to the power unit. For data on cross-sections, refer to the Chapter "Data of the power cable at the stator".

8.3.11 Requirements for the motor supply cables

The cables must be appropriately selected corresponding to the mechanical forces caused by high rates of acceleration and speeds. Further, they must be suitable for the bending stresses that occur.

Permissible motor feeder cable lengths

The permissible length of the power cable between the motor and the infeed unit depends on the rated power or the rated output current of the infeed unit.

Example, Motor Module, shielded cable:

up to 50 m power cable length at the rated output current $I_n \leq 9 \text{ A}$,

up to 70 m power cable length at the rated output current $9 \text{ A} < I_n \leq 18 \text{ A}$,

up to 100 m power cable length from a rated output current $I_n \geq 30 \text{ A}$

The permissible signal cable length from the motor to the Control Unit depends on the type of signal cable being used.

As a result of EMC effects for drive systems, we always recommend that shielded cables are used.

NOTICE
Damage to cables
Cables subject to high acceleration rates can wear more quickly. The cables permanently connected to the motor cannot be replaced if they are damaged.
<ul style="list-style-type: none">• Observe the permissible acceleration rates for the cables.• Do not use a drag chain for the cables permanently attached to the motor.

Also refer to the Chapter "System integration". Data on the motor feeder cables, see Chapter "Data of the power cable at the stator" and catalog.

MOTION-CONNECT cables from the terminal box provided by the customer or extensions for the power and signal connection, see catalog.

Specification of the motor feeder cables

The built-in torque motors are supplied with MOTION-CONNECT cables according to the catalog from which you can take the technical data:

Power cable: MOTION-CONNECT 800PLUS, type 6FX8

Signal cable: MOTION-CONNECT 800PLUS, type 6FX8

Installation drawings/Dimension drawings

9.1 Installation situation for motors with a cooling jacket

Design information for installation hole and O ring

- Provide insertion inclines: Minimum length Z at 15° : 3 mm, at 20° : 2 mm, edges rounded and polished
Debur and round inside holes (cooling water connections)
- Surface quality of the opposite sealing surfaces: $R_{\max} \leq 16 \mu\text{m}$, $R_z \leq 10 \mu\text{m}$, $R_a \leq 1.6 \mu\text{m}$
- Note the installation hole fit (H8). If the play is too great, the O-ring does not provide sufficient sealing or the permissible gap is too large.

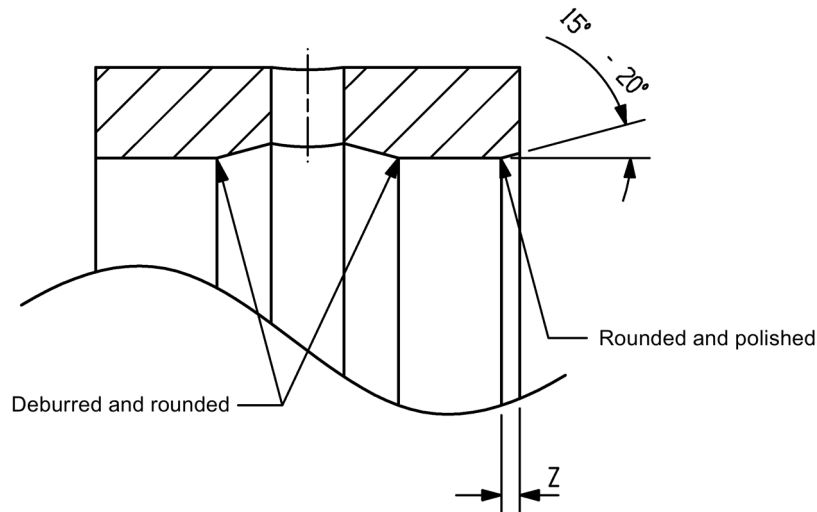

Figure 9-1 Design information for installation hole and O ring

9.2 Information on the installation drawings

Note

Please note that certain motors can only be mounted at the A flange as a result of their design, refer to the Table "Mounting at the A flange" in Chapter "Specifications relating to the mounting side (Page 125)".

Installation dimensions

For the design, pay special attention to the following dimensions.

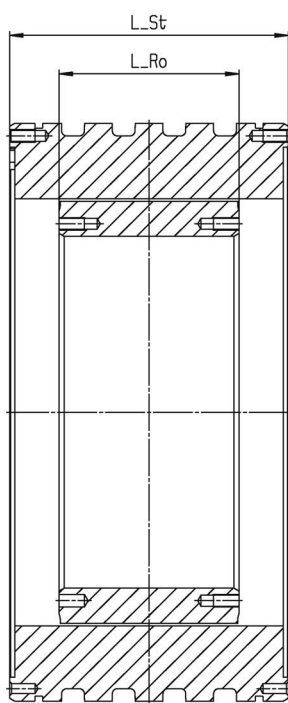

1FW609, 1FW613, 1FW615

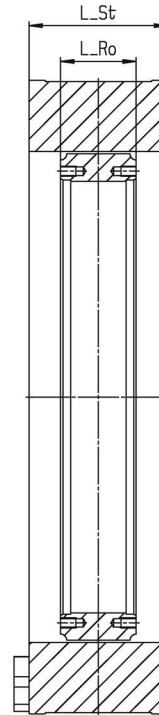

1FW605, 1FW606, 1FW616, 1FW619, 1FW623, 1FW629

L_St Stator length

L_Ro Rotor length

Figure 9-2 Stator length and rotor length of 1FW6 built-in torque motors

Note

Motor dimensions

Siemens reserves the right to change the motor dimensions as part of design improvements without prior notification. The dimension drawings provided in this documentation, therefore, may not necessarily be up to date.

You can request up-to-date dimension drawings at no charge.

Fastening holes

The schematic representation below shows the position tolerance for fastening holes according to DIN EN ISO 1101:2008-08. The diameter "d" of the circular tolerance zone indicates the tolerance.

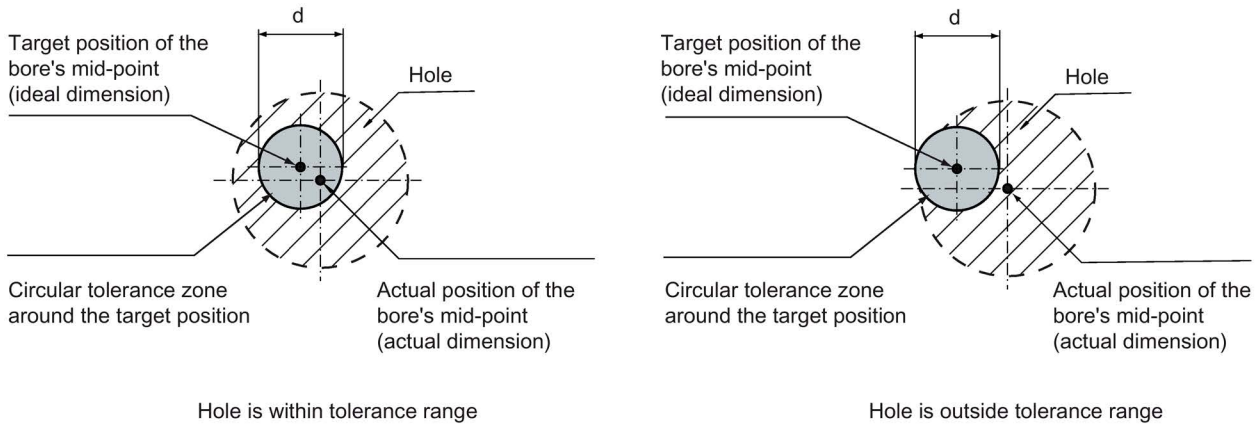

Figure 9-3 Position tolerance for fastening holes

The actual position of the hole's mid-point (actual dimension) must lie within the circular tolerance zone to enable the motor components to be attached without any problems. If no specific value has been stated, the standard tolerance of $d = 0.2 \text{ mm}$ (as used by the machine tool industry) applies.

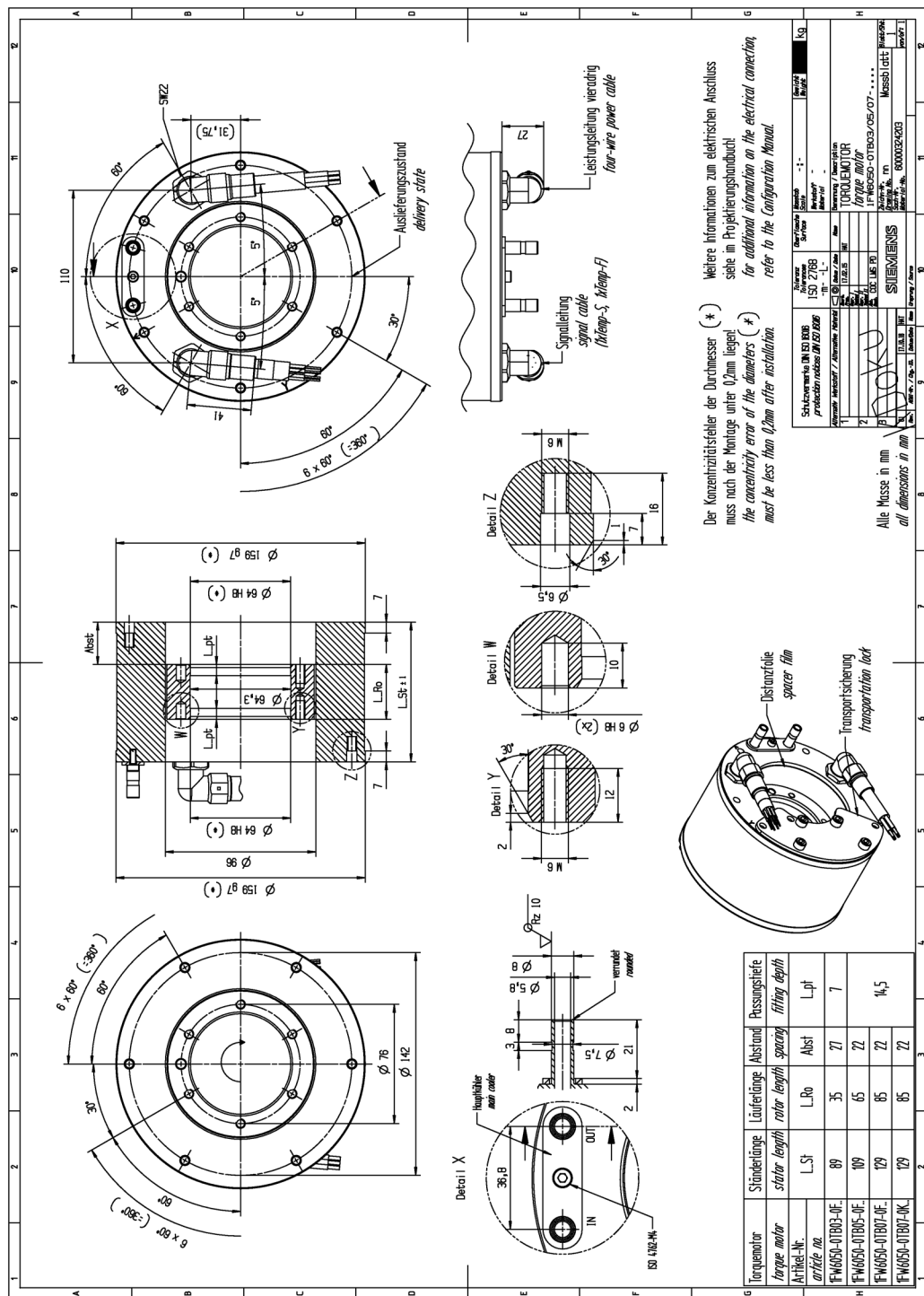

Figure 9-6 1FW6050-xxB (active part length 03, 05 and 07, tangential electrical connection with sleeve)

9.6 Installation drawing/dimension drawing 1FW6130-xxB

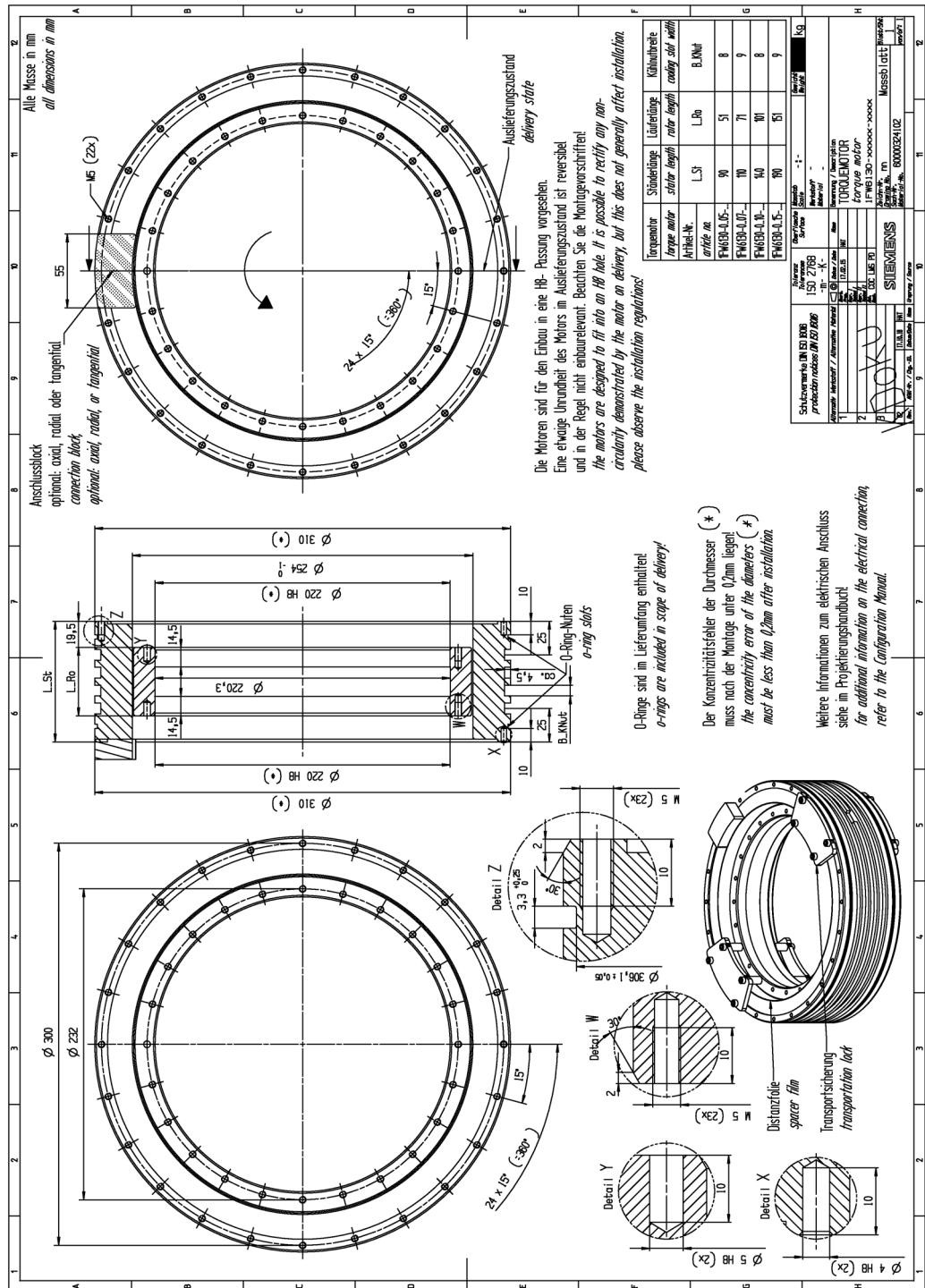

Figure 9-13 1FW6130-xxB

9.9 Installation drawing/dimension drawing 1FW6190-xxB

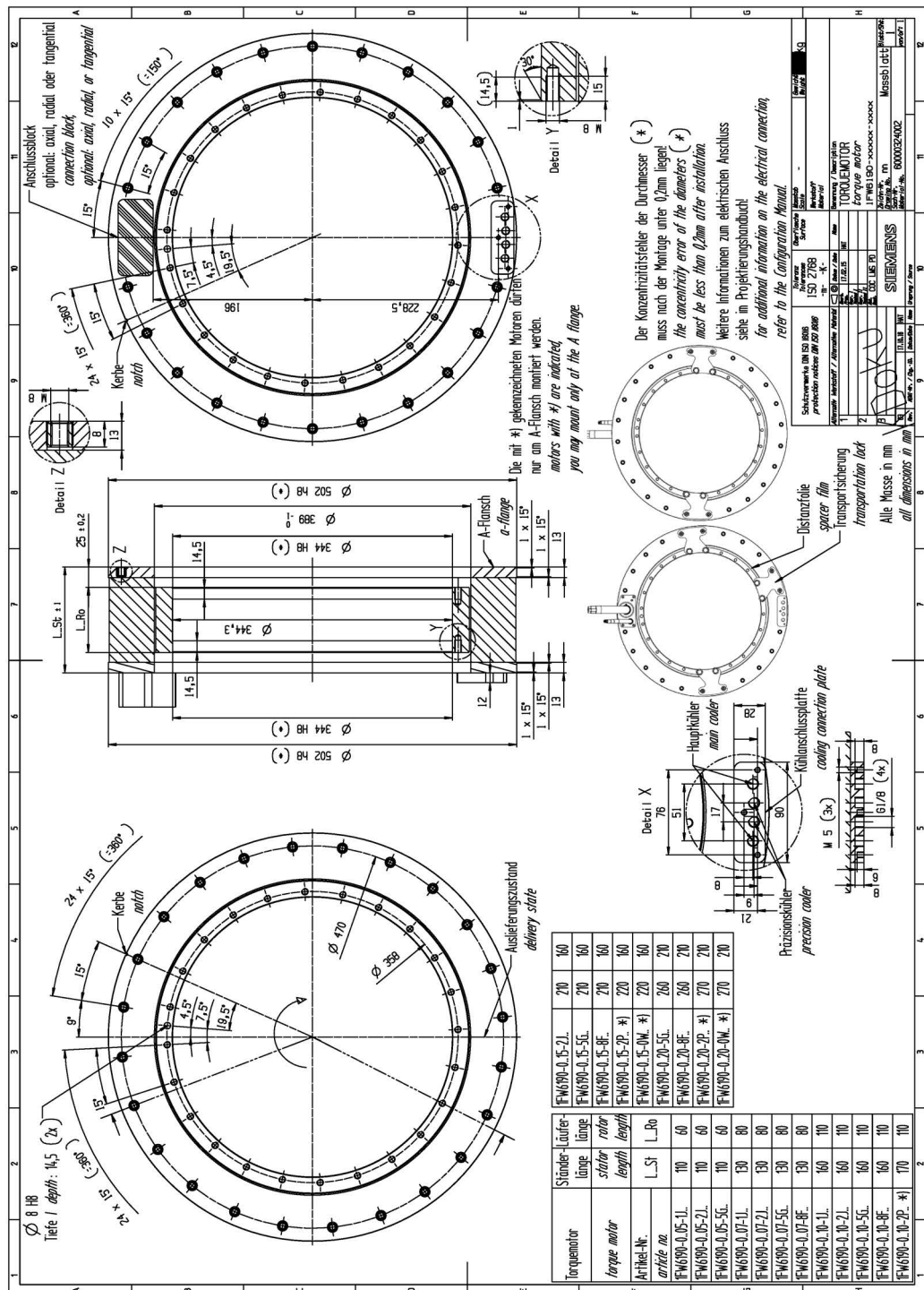

Figure 9-17 1FW6190-xxB

9.10 Installation drawing/dimension drawing 1FW6230-xxB

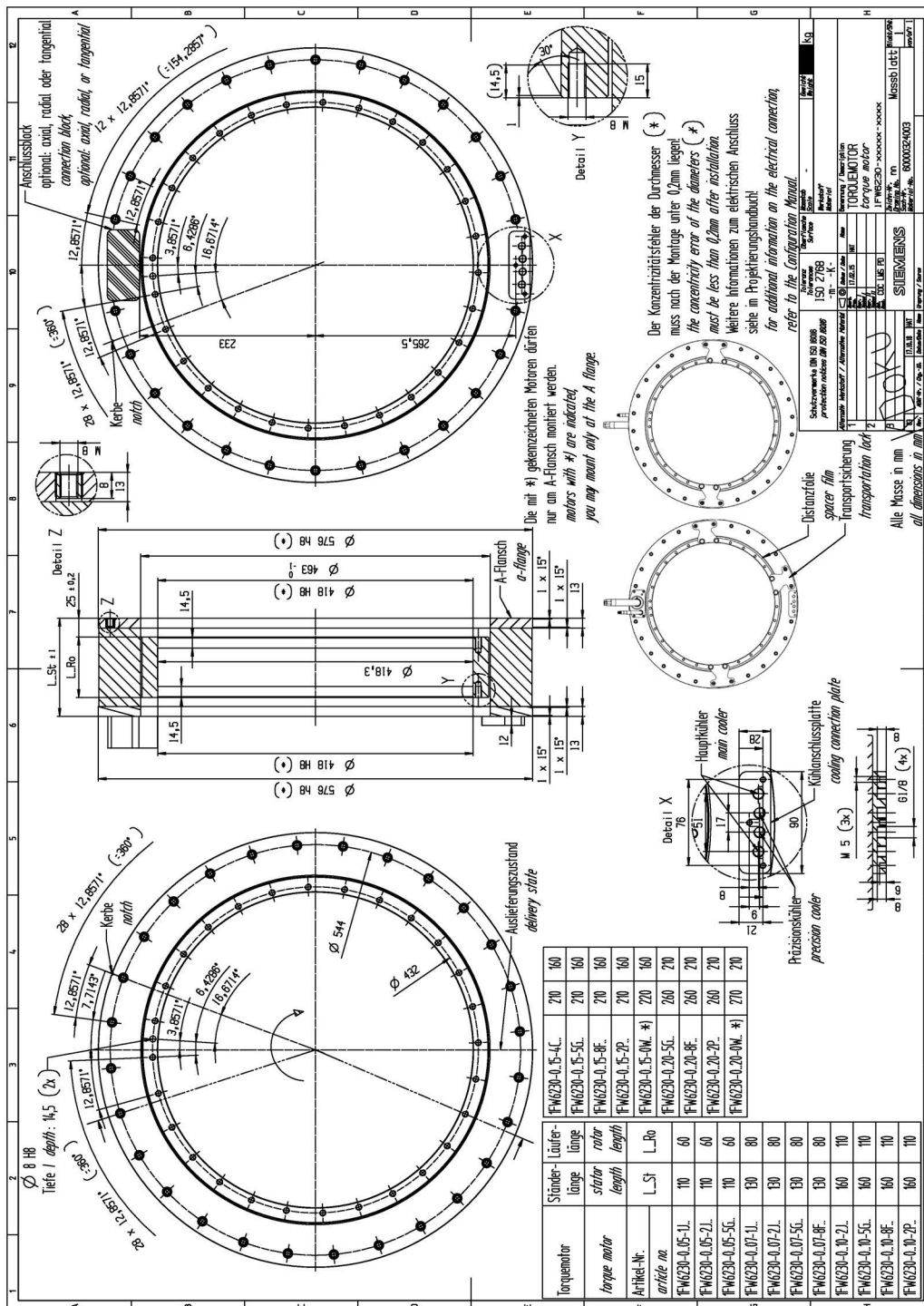

Figure 9-18 1FW6230-xxB

Coupled motors

10.1 Operating motors connected to an axis in parallel

When the torque of an individual motor is not sufficient for the drive application, then it is possible to distribute the required torque over two or more motors.

Mount the motors on the same axis. The motors are then mechanically coupled.

You have two options for supplying the individual motors:

- Each motor is operated on its own Motor Module with its own encoder. This operation does not represent an electrical parallel connection. The motors only operate together mechanically. This version is not discussed in this manual.
- All of the motors are connected to the same Motor Modules. In this case, the article numbers of all of the motors involved must be the same. The motors are then electrically connected in parallel, and operate in the parallel mode.

Note

Country-specific safety requirements for parallel operation

Country-specific safety requirements and regulations apply when connecting motors in parallel at a Motor Module.

For example, in the US, for special motor protection, carefully comply with the requirements laid down in standards NFPA 70 and NFPA 79.

Notes for parallel operation

The motor power cables must be the same length in order to ensure uniform current distribution.

When operating several motors in parallel, you must accommodate additional motors and cables. Plan the additional installation space required.

Add the rotor moment of inertia of each motor involved to the overall moment of inertia of the axis.

10.2 Master and stoker

The first motor in an axis is called the "master". The master defines the positive direction of rotation of the axis. The second and each additional motor are called "stokers".

The following definitions also apply to each additional stoker.

Whether tandem or Janus arrangement is the better solution, depends on the space requirement and the cable routing.

A stoker can be arranged on the axis with respect to the master in two ways:

Tandem arrangement

The stoker has the same cable outlet direction as the master. All power connection phases must be connected to the Motor Module phases with the same names. The stoker has the same direction of rotation as the master.

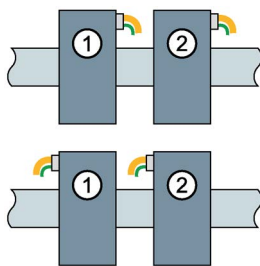

- 1 Master
- 2 Stoker

Janus arrangement

The stoker has the opposite cable outlet direction as the master. For the stoker power connections, interchange phases V and W so that the stoker has the same direction of rotation as the master.

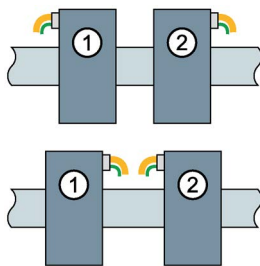

- 1 Master
- 2 Stoker

Power connection

Table 10- 1 Power connection when two torque motors are operated in parallel

Motor Module	Master	Stoker Tandem arrangement	Stoker Janus arrangement
U2	U	U	U
V2	V	V	W
W2	W	W	V

10.3 Machine design and adjustment of the phase angle

Each rotation of the mounted rotor induces the 3-phase EMF of the motor in the stator phase windings. When the master and stoker operate in parallel, the phase angle of each stoker EMF must match the phase angle of the master EMF.

To adjust the phase angle, the stator and rotor each have a reference mark on their face sides. The reference marks of the motors are shown in Chapter "Installation drawings/Dimension drawings (Page 519)".

- The reference mark in the stator depends on the motor article number.
 - 1FW6050-xxBxx-0Fxx, 1FW6060-xxBxx-0Kxx:
engraved with the letter V
 - 1FW6050-xxBxx-0Kxx, 1FW6050-xxBxx-1Jxx, 1FW6060-xxBxx-1Jxx:
Engraved with the letter Y
 - 1FW6090-xxBxx-xxxx to 1FW6150-xxBxx-xxxx:
centering bore
 - 1FW6160-xxBxx-xxxx to 1FW6290-xxBxx-xxxx:
Notch
- The reference mark in the rotor is a centering bore without thread.

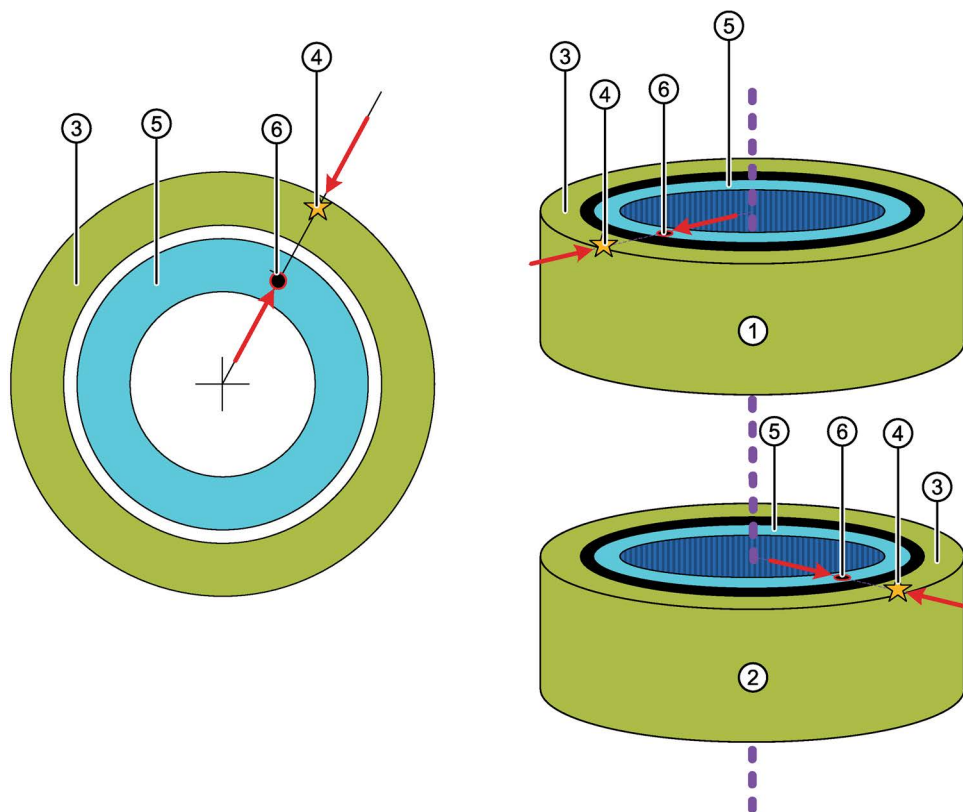

- 1 Master
- 2 Stoker
- 3 Stator
- 4 Reference mark at the stator (various forms depending on the motor)
- 5 Rotor
- 6 Reference mark at the rotor

Figure 10-1 Reference marks for 1FW6 built-in torque motors (schematic)

The phase angles have been correctly adjusted if the following state is reached while the axis is rotating in operation:

The reference marks of all rotors are always aligned at the same point in time with the reference mark of the associated stator.

The machine design must ensure that this applies. You can achieve the required mechanical adjustability of the mounting position, e.g. using an intermediate flange with elongated holes. The angular tolerance is $\pm 1^\circ$ mechanical.

The stator reference marks do not have to align with one another.

The rotor reference marks do not have to align with one another.

⚠ CAUTION**Thermal overload as a result of poor phase angle adjustment**

In parallel operation at rated load, a poorly adjusted phase angle results in a thermal overload of the motors involved. In this case, the motor does not achieve its rated torque M_N in continuous operation.

- Adjust the phase angle as specified.

If you have any questions in this regard, then contact your local Siemens office. For example, you can obtain information about optimally engineering or dimensioning drive systems with torque motors operating in parallel.

10.4 Connection examples for parallel operation

**⚠ WARNING****Risk of electric shock!**

Hazardous touch voltages can be present at unused cores and shields if they have not been grounded or insulated.

- Refer to the Chapter "Shielding, grounding and equipotential bonding".

The following connection diagrams show, as example, the power and signal connection of two torque motors electrically connected in parallel in a tandem arrangement.

If a PTC 150 °C does not exist, then diagrams "Connecting the PTC 130 °C via SME12x" and "Connecting the PTC 130 °C via TM120" apply.

Table 10- 2 Power connection when operating two torque motors in a tandem arrangement in parallel

Motor Module	Master	Stoker Tandem arrangement
U2	U	U
V2	V	V
W2	W	W

10.4 Connection examples for parallel operation

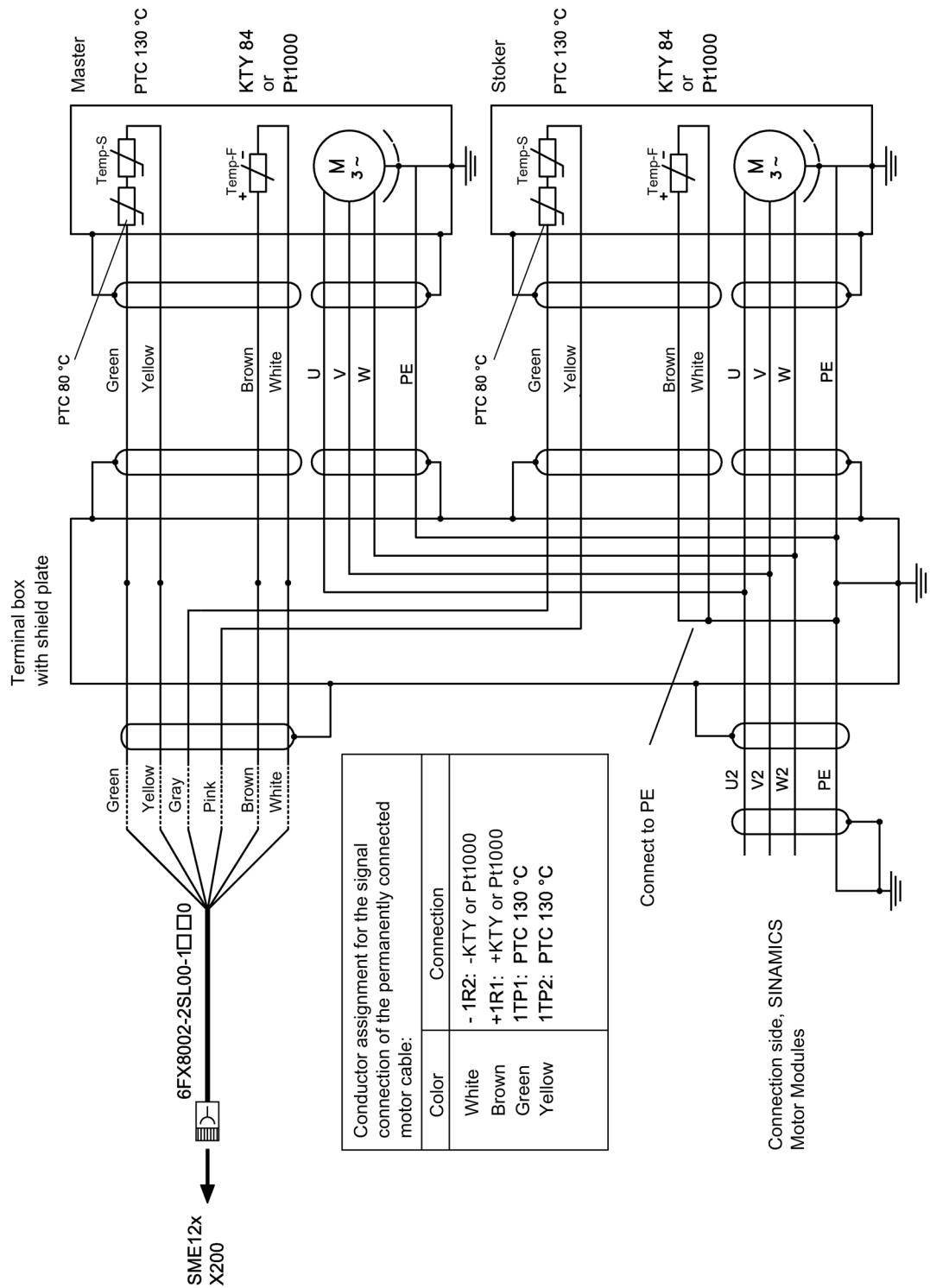

Figure 10-2 Connecting the PTC 130 °C via SME12x

10.4 Connection examples for parallel operation

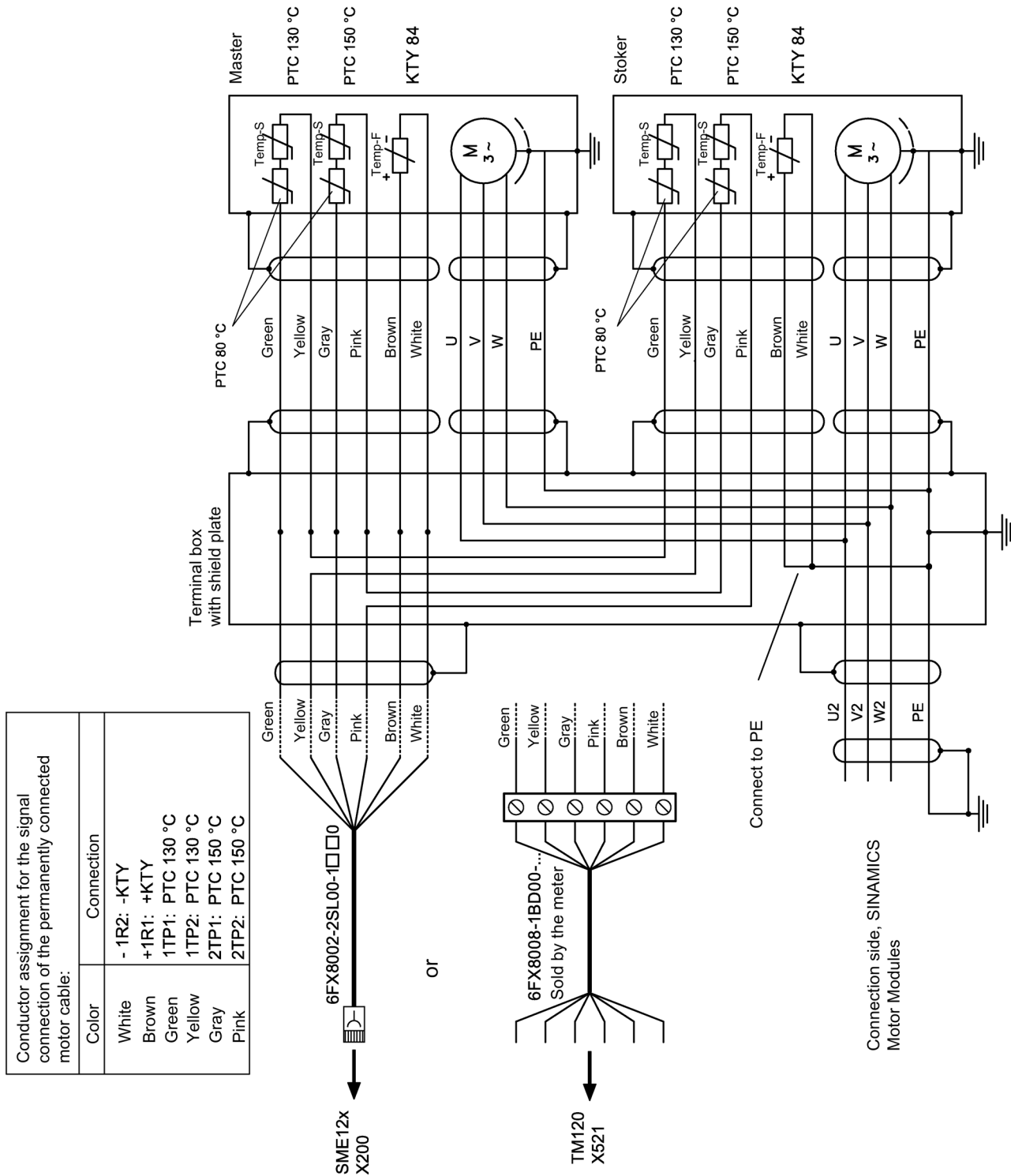

Figure 10-4 Connecting the PTC 130 °C and PTC 150 °C via SME12x or TM120

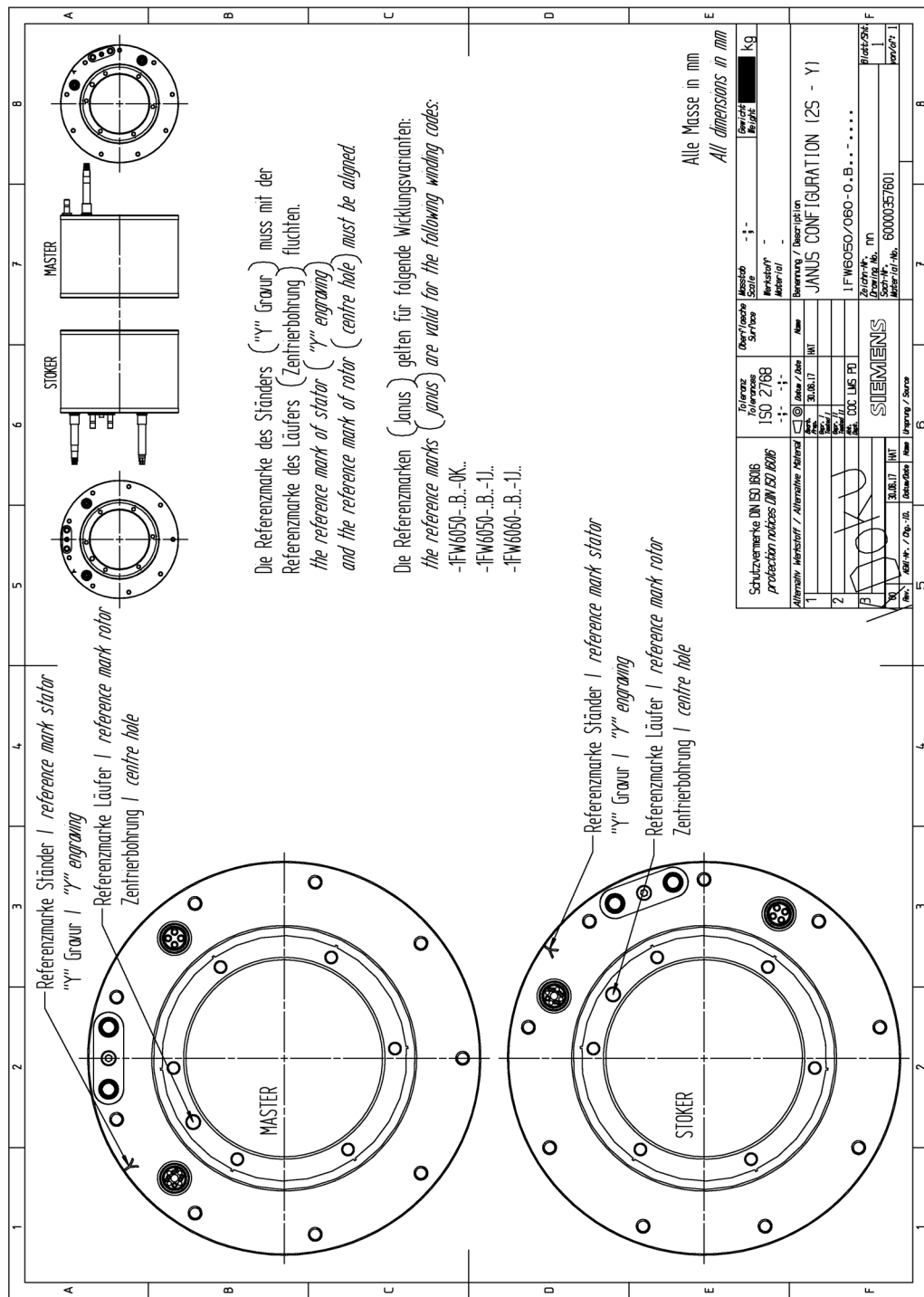

Figure 10-6 Janus arrangement 1FW6050-xxBxx-0Kxx, 1FW6050-xxBxx-1Jxx, 1FW6060-xxBxx-1Jxx

Appendix

A.1 Recommended manufacturers

Information regarding third-party products

Note

Recommendation relating to third-party products

This document contains recommendations relating to third-party products. Siemens accepts the fundamental suitability of these third-party products.

You can use equivalent products from other manufacturers.

Siemens does not accept any warranty for the properties of third-party products.

A.1.1 Supply sources for connection components and accessories for heat-exchanger units

Rectus GmbH	
	www.rectus.de
Festo AG & Co. KG	
	www.festo.com
Serto GmbH	
	www.serto.de
AVS Ing. J. C. Römer GmbH	
	www.avs-roemer.de

A.1.2 Supply sources for cooling systems

Pfannenberg GmbH	
	www.pfannenberg.com
BKW Kälte-Wärme-Versorgungstechnik GmbH	
	www.bkw-kuema.de
Helmut Schimpke Industriekühlanlagen GmbH + Co. KG	
	www.schimpke.de
Hydac International GmbH	
	www.hydac.com
Rittal GmbH & Co. KG	
	www.rittal.de

A.1.3 Supply sources for anti-corrosion agents

TYFOROP CHEMIE GmbH	
Anti-corrosion protection: Tyfocor	www.tyfo.de
Clariant Produkte (Deutschland) GmbH	
Anti-corrosion protection: Antifrogen N	www.clariant.de

A.1.4 Supply sources for braking elements

HEMA Maschinen und Apparateschutz GmbH	
	www.hema-schutz.de
Chr. Mayr GmbH + Co. KG	
	www.mayr.de

A.2 List of abbreviations

BGV	Binding national health and safety at work regulations (in Germany)
CE	Communauté Européenne
DIN	Deutsches Institut für Normung (German standards organization)
DQ	DRIVE-CLiQ
EMC	Electromagnetic compatibility
EMF	Electromotive force
EN	Europäische Norm (European standard)
EU	European Union
HFD	High-frequency damping
HW	Hardware
IATA	International Air Transport Association
IEC	International Electrotechnical Commission
IP	International Protection
KTY	Temperature sensor with progressive, almost linear characteristic
LI	Line infeed
NC	Numerical control
NCK	Numerical control kernel: NC kernel with block preparation, travel range, etc.
PDS	Power drive system
PE	Protective earth
PELV	Protective extra low voltage
ph value	Concentration of hydrogen ions in a liquid
Pt	Platinum
PTC	Temperature sensor with positive temperature coefficients and "quasi-switching" characteristic
RoHS	Restriction of (the use of certain) Hazardous Substances
S1	"Continuous operation" mode
S2	"Short-time operation" mode
S3	"Intermittent operation" mode
SMC	Sensor Module Cabinet
SME	Sensor Module External
SW	Software
Temp-F	Circuit for monitoring the temperature the motor winding
Temp-S	Temperature monitoring circuit for shutting down the drive in the event of over-temperature
TM	Terminal Module
TN	Terre Neutral
VDE	Association of Electrical Engineering, Electronics and Information Technology (in Germany)

A.3 Environmental compatibility

A.3.1 Environmental compatibility during production

- The packaging material is made primarily from cardboard.
- Energy consumption during production was optimized.
- Production has low emission levels.

A.3.2 Disposal

The product must be disposed of in the normal recycling process in compliance with national and local regulations.

A.3.2.1 Guidelines for disposal

 **WARNING**

Injury or material damage if not correctly disposed of

If you do not correctly dispose of direct drives or their components (especially components with permanent magnets), then this can result in death, severe injury and/or material damage.

- Ensure that direct drives and their associated components are correctly disposed of.

Main constituents of a proper disposal procedure

- Complete demagnetization of the components that contain permanent magnets
- Components that are to be recycled should be separated into:
 - Electronics scrap (e.g. encoder electronics, Sensor Modules)
 - Electrical scrap (e.g. motor windings, cables)
 - Scrap iron (e.g. laminated cores)
 - Aluminum
 - Insulating materials
- No mixing with solvents, cold cleaning agents, or residue of paint, for example

A.3.2.2 Disposing of 1FW6 rotors



⚠ WARNING

Risk of death and crushing as a result of permanent magnet fields

Severe injury and material damage can result if you do not take into consideration the safety instructions relating to permanent magnet fields.

- Observe the information in Chapter "Danger from strong magnetic fields (Page 29)".

Disposing of and demagnetizing 1FW6 rotors

The magnetized rotors must be subject to a special thermal disposal procedure so that they do not pose any risk during or after disposal. For this reason, they must be disposed of by a specialist disposal company.

Once the motor has been dismantled, the rotors must be packaged individually in the undamaged original packaging in accordance with the relevant guidelines.

Demagnetizing the rotors

Disposal companies who specialize in demagnetization use special disposal furnaces. The interior of the disposal furnace is made of non-magnetic material.

The secondary sections are placed inside a solid, heat-resistant container (such as a skeleton container), which is made of non-magnetic material and left in the furnace during the entire demagnetization procedure. The temperature in the furnace must be at least 300°C over a holding time of at least 30 minutes.

Escaping gases must be collected and decontaminated without damaging the environment.

A.3.2.3 Disposal of packaging

Packaging materials and disposal

The packaging and packing aids we use contain no problematic materials. With the exception of wooden materials, they can all be recycled and should always be disposed of for reuse. Wooden materials should be burned.

Only recyclable plastics are used as packing aids:

- Code 02 PE-HD (polyethylene)
- Code 04 PE-LD (polyethylene)
- Code 05 PP (polypropylene)
- Code 04 PS (polystyrene)

Index

A

- Accidents
 - First aid, 33
- Accuracy, 24
- Ambient conditions, 36
- Anti-corrosion protection, 59
- Area of application, 27
- Axial forces, 121

B

- Bearings, 87
- Braking, 88, 88
- Braking and emergency stop concepts, 89

C

- Certificates
 - EAC, 29
 - EC Declaration of Conformity, 29
 - UL and cUL, 29
- Characteristics for 1FW6050-xxB03-xxxx, 166
- Characteristics for 1FW6050-xxB05-xxxx, 171
- Characteristics for 1FW6050-xxB07-xxxx, 176
- Characteristics for 1FW6050-xxB10-xxxx, 182
- Characteristics for 1FW6050-xxB15-xxxx, 187
- Characteristics for 1FW6060-xxB03-xxxx, 193
- Characteristics for 1FW6060-xxB05-xxxx, 198
- Characteristics for 1FW6060-xxB07-xxxx, 204
- Characteristics for 1FW6060-xxB10-xxxx, 210
- Characteristics for 1FW6060-xxB15-xxxx, 216
- Characteristics for 1FW6090-xxB05-xxxx, 222
- Characteristics for 1FW6090-xxB07-xxxx, 228
- Characteristics for 1FW6090-xxB10-xxxx, 234
- Characteristics for 1FW6090-xxB15-xxxx, 240
- Characteristics for 1FW6130-xxB05-xxxx, 246
- Characteristics for 1FW6130-xxB07-xxxx, 252
- Characteristics for 1FW6130-xxB10-xxxx, 258
- Characteristics for 1FW6130-xxB15-xxxx, 264
- Characteristics for 1FW6150-xxB05-xxxx, 270
- Characteristics for 1FW6150-xxB07-xxxx, 276
- Characteristics for 1FW6150-xxB10-xxxx, 282
- Characteristics for 1FW6150-xxB15-xxxx, 288
- Characteristics for 1FW6160-xxB05-xxxx, 294
- Characteristics for 1FW6160-xxB07-xxxx, 303

- Characteristics for 1FW6160-xxB10-xxxx, 313
- Characteristics for 1FW6160-xxB15-xxxx, 324
- Characteristics for 1FW6160-xxB20-xxxx, 335
- Characteristics for 1FW6190-xxB05-xxxx, 343
- Characteristics for 1FW6190-xxB07-xxxx, 352
- Characteristics for 1FW6190-xxB10-xxxx, 362
- Characteristics for 1FW6190-xxB15-xxxx, 373
- Characteristics for 1FW6190-xxB20-xxxx, 384
- Characteristics for 1FW6230-xxB05-xxxx, 392
- Characteristics for 1FW6230-xxB07-xxxx, 401
- Characteristics for 1FW6230-xxB10-xxxx, 411
- Characteristics for 1FW6230-xxB15-xxxx, 421
- Characteristics for 1FW6230-xxB20-xxxx, 432
- Characteristics for 1FW6290-xxB07-xxxx, 440
- Characteristics for 1FW6290-xxB11-xxxx, 447
- Characteristics for 1FW6290-xxB15-xxxx, 454
- Characteristics for 1FW6290-xxB20-xxxx, 461
- Circuit diagram of a stator, 474
- Control quality, 25
- Coolant
 - Provision, 58
 - Water properties, 59
- Cooler connection method, 130
- Cooling, 34, 53
- Cooling circuits, 54
 - Maintenance, 69
- Cooling medium
 - Anti-corrosion agent properties, 59
 - General properties, 59
- Cooling method, 34

D

- Degree of protection, 34, 60
- Design, 34
- Dimension drawing 1FW6050-xxB, 522
- Dimension drawing 1FW6060-xxB, 526
- Dimension drawing 1FW6090-xxB (general), 530
- Dimension drawing 1FW6130-xxB (general), 531
- Dimension drawing 1FW6150-xxB (general), 532
- Dimension drawing 1FW6160-xxB (general), 534
- Dimension drawing 1FW6190-xxB (general), 535
- Dimension drawing 1FW6230-xxB (general), 536
- Dimension drawing 1FW6290-xxB (general), 537
- Direction of rotation, 36, 36
- Disposal, 552

E

Encoder system, 82
Environmental compatibility, 552
Evaluation
 Temp-F, Temp-S, 74

F

Fastening hole, 521
Field weakening, 161
Formula abbreviations, 155

G

Grounding, 515

H

Heat-exchanger unit, 57
Hoses for the cooling system, 142
Hotline, 5

I

IATA, 468
Inlet temperature, 56
Insulation resistance, 68
Intermittent duty, 98

J

Janus arrangement, 540, 547

M

Magnetic fields
 First aid in the case of accidents, 33
 Occurrence, 29
 Strength, 32, 62, 116
Malfunctions
 Braking, 88
Master, 540
Motor
 Disposal, 552
Motor installation, 115
 Precautions, 115

Motor mounting
 Mounting system, 126
 Screw material, 127
 Tightening torques, 127
Motor type, 34
Mounting system, 126

N

Noise emission, 61

O

Operating mode
 Intermittent duty, 98
 Short-time duty, 97
 Uninterrupted duty, 97
Order numbers, 40

P

Packaging, 466, 467, 553
Parallel operation, 539
Permissible mounting side, 125
Power connection, 512
PTC temperature sensor, 75

R

Radial forces, 120
Rating plate, 52
RoHS, 29

S

Safety instructions
 Disassembly, 65
 Disposal, 552
 Electrical connection, 471, 471
 Maintenance, 61
 Motor installation, 115
 Packaging, 466
 Storage, 466
 Transport, 466
Sensor Module External SME12x, 478
Shielding, 515
Short-time duty, 97

Siemens Service Center, 5
SMC20 Sensor Module Cabinet-Mounted, 479
STARTER, 94
Stoker, 540
Storage, 466
System integration, 475

T

Tandem arrangement, 540
Technical data
 1FW605, 164
 1FW606, 191
 1FW609, 220
 1FW613, 244
 1FW615, 268
 1FW616, 292
 1FW619, 341
 1FW623, 390
 1FW629, 438
Technical Support, 5
Temperature monitoring, 34
Temperature sensors, 74
Thermal class, 35
Thermal motor protection, 34
Third-party products, 7, 549
Tightening torques, 127
TM120 Terminal Module, 479
Torque ripple, 35
Training, 5
Transport, 466

U

Uninterrupted duty, 97
Use for the intended purpose, 26

V

Vibration response, 60
Voltage Protection Module VPM, 109

W

Winding insulation, 35

Siemens AG
Digital Factory
Motion Control
Postfach 31 80
91050 ERLANGEN
Germany

Scan the QR code for
additional informati-
on about SIMOTICS.

