

Manual

Language **English**
Translation
Document No. 5.05022.05
Part No. 391349
Edition 23-Jul-2015

be in motion **be in motion**



BAUMÜLLER

b maXX

BM4500

| | |
|----------|------------|
| E | 5.05022.05 |
|----------|------------|

Read the Instruction handbook before starting any work!

Copyright These Manual may be copied by the owner in any quantity, but only for internal use. This Manual may not be copied or reproduced, in whole or in part, for any other purposes. The use and disclosure of information contained in these Manual are not permitted. Designations and company marks contained in these Manual could be trademarks, the use of which by third parties for their own purposes could violate the rights of the rights holder.

Preliminary information

Warning Insofar as this document is identified as being preliminary information, the following applies:

this version is regarded as providing advance technical information to users of the described devices and their functions at an early enough time in order to adapt to any possible changes or expanded functionality.

This information must be regarded as being preliminary, as it has not yet passed through Baumüller's internal review process. In particular, this information is still subject to changes, thus no legal liability can be derived from this preliminary information. Baumüller assumes no liability for damages that might arise from this possibly faulty or incomplete version.

If you detect or suspect any content errors and/or major form errors in this preliminary information, we request that you notify the Baumüller support specialist responsible for you. Please provide us, via this employee, with your insights and comments so that we can take them into account and include them when transitioning from the preliminary information to the final information (as reviewed by Baumüller).

The conditions stipulated in the following section under "Obligatory" are invalid in case of preliminary information.

Obligatory

These Manual are a part of the equipment/machine. These Manual must be available to the operator at all times and must be in legible condition. If the equipment/machine is sold or moved another location, these Manual must be passed on by the owner together with the equipment/machine.

After any sale of the equipment/machine, this original and all copies must be handed over to the buyer. After disposal or any other end use, this original and all copies must be destroyed.

When the present Manual are handed over, corresponding sets of instruction handbooks of a previous version are automatically invalidated.

Please note that the specifications/data/information **are current values according to the printing date**. These statements are **not legally binding** with regard to measurements, computation or calculations.

Baumüller Nürnberg GmbH reserves the right, in developing its products further, to change the technical specifications and handling of its products concerned without prior notice.

No liability can be accepted concerning the correctness of these Manual unless otherwise specified in the General Conditions of Sale and Delivery.

© **Baumüller Nürnberg GmbH**

Ostendstr. 80 - 90
90482 Nuremberg
Germany

Tel. +49 9 11 54 32 - 0
Fax: +49 9 11 54 32 - 1 30

Email : mail@baumueller.de
Internet: www.baumueller.de



Table of contents

| | | |
|----------|--|-----------|
| 1 | Introduction | 7 |
| 1.1 | Survey of the appliance series b maXX 4500 | 7 |
| 1.2 | First steps | 7 |
| 1.3 | Used terms | 8 |
| 1.4 | Copyright and trade mark | 8 |
| 2 | Fundamental safety instructions | 9 |
| 2.1 | General notes | 9 |
| 2.2 | Legal instructions | 10 |
| 2.3 | Appropriate use | 10 |
| 2.4 | Inappropriate use | 11 |
| 2.5 | Hazard information and commands | 11 |
| 2.5.1 | Hazard information structure | 12 |
| 2.5.2 | Form of the hazard sign (triangular or round) | 12 |
| 2.5.2.1 | Hazard information on personal injury | 13 |
| 2.5.2.2 | Hazard information on property damage | 18 |
| 2.5.2.3 | Command signs used | 18 |
| 2.6 | Information sign | 19 |
| 2.7 | Safety equipment | 19 |
| 2.8 | Training of the personnel | 20 |
| 2.9 | Safety precautions in normal operation | 20 |
| 2.10 | Dangers due to residual energy | 20 |
| 2.11 | Disposal of the device | 21 |
| 2.12 | Fire fighting | 21 |
| 2.13 | Responsibility and liability | 22 |
| 2.13.1 | Observing the safety notes and safety instructions | 22 |
| 2.13.2 | Dangers when handling this device | 22 |
| 2.13.3 | Warranty and Liability | 22 |
| 3 | Transportation and packing | 23 |
| 3.1 | To be considered by transportation | 23 |
| 3.2 | Unpacking | 23 |
| 3.3 | Dispose packing | 24 |
| 4 | Description of the devices | 25 |
| 4.1 | Structure | 25 |
| 4.2 | Interconnect the devices | 26 |
| 4.3 | Variants | 26 |
| 4.3.1 | Basic types/types with Safe Torque Off (STO) | 26 |
| 4.4 | Overview of dangerous areas | 27 |
| 4.5 | Marking of the device - type code | 28 |
| 4.6 | UL-notes | 30 |
| 4.6.1 | cUL-notes | 30 |



Table of contents

| | | |
|----------|--|-----------|
| 5 | Mounting | 31 |
| 5.1 | General safety instructions | 31 |
| 5.2 | Requirements to the executing personnel | 32 |
| 5.3 | Prepare mounting | 33 |
| 5.4 | Installation space | 33 |
| 5.5 | Drilling patterns | 34 |
| 5.6 | Mounting instructions | 34 |
| 6 | Installation | 37 |
| 6.1 | General safety instructions | 37 |
| 6.2 | Requirements to the executing personnel | 38 |
| 6.3 | Requirements to the electrical mains | 38 |
| 6.4 | Requirements to the connecting cables | 39 |
| 6.5 | Protection of the device and of the cable respectively | 39 |
| 6.6 | PE connection and RCD compatibility | 39 |
| 6.7 | Requirements on the laying (EMC notes device) | 40 |
| 6.8 | Operating sequence of installation | 41 |
| 6.9 | Power connections | 42 |
| 6.10 | Connection diagram | 43 |
| 6.10.1 | Connection data of the power connections | 44 |
| 6.10.2 | Connection data of control connections | 45 |
| 6.10.2.1 | Control connection X99A | 45 |
| 6.10.2.2 | Control connection X99AB | 46 |
| 6.10.2.3 | Safety relay X68 | 48 |
| 7 | Operation | 51 |
| 7.1 | Safety instructions | 51 |
| 7.2 | Requirements to the executing personnel | 52 |
| 7.3 | Monitoring functions and its messages | 52 |
| 7.3.1 | Monitoring functions supply unit | 53 |
| 7.3.2 | Monitoring functions motor-sided power unit | 53 |
| 7.4 | Ready-to-operate | 54 |
| 7.5 | Monitoring functions | 56 |
| 7.5.1 | Monitoring functions of the supply unit | 57 |
| 7.5.2 | Monitoring functions motor-sided power unit | 58 |
| 7.5.3 | Messages via relay contacts | 60 |
| 7.6 | Maintenance | 60 |
| 8 | Maintenance | 61 |
| 8.1 | Safety instructions | 61 |
| 8.2 | Environmental conditions | 62 |
| 8.3 | Inspection intervals - maintenance notes | 62 |



| | | |
|-----------|--|-----------|
| 9 | Repair | 65 |
| 10 | Shutdown, storage | 67 |
| 10.1 | Safety instructions | 67 |
| 10.2 | Requirements to the executing personnel | 67 |
| 10.3 | Put out of operation | 68 |
| 10.4 | Demounting | 68 |
| 10.5 | Storage conditions | 69 |
| 10.6 | Recommissioning | 69 |
| 11 | Disposal | 71 |
| 11.1 | Safety instructions | 71 |
| 11.2 | Requirements to the executing personnel | 73 |
| 11.3 | Disposal instructions | 73 |
| 11.3.1 | Modules | 73 |
| 11.4 | Recycling plants/offices | 74 |
| | Appendix A - Abbreviations | 75 |
| | Appendix B - Spare parts and accessories | 77 |
| B.1 | Interface cable | 77 |
| B.2 | Plugs | 78 |
| | Appendix C - Declaration of Conformity | 79 |
| C.1 | Declaration of Conformity | 79 |
| | Appendix D - Technical data | 83 |
| D.1 | Requirements on the power supply | 84 |
| D.2 | Requirements to the motor | 85 |
| D.3 | Required environmental conditions | 86 |
| D.4 | Cooling | 87 |
| D.5 | Non-electrical data | 87 |
| D.6 | Electrical data - BM454X | 88 |
| D.7 | Fuse protection | 90 |
| D.7.1 | Cable protection | 91 |
| D.7.2 | Device protection | 91 |
| D.7.3 | Cable protection + device protection | 92 |
| D.7.4 | Full-range fuses gR, gRL, gR/gS, gGR (device and cable) BM454X, type NH | 92 |
| D.7.5 | Semiconductors aR (device) BM454X, type NH | 93 |
| D.8 | 24V extra-low voltage protection | 93 |
| D.9 | Cable mains - device | 94 |
| D.10 | Cable device-motor | 94 |
| D.11 | Cable control voltage supply/signals | 94 |
| D.12 | Type of protection | 95 |
| D.13 | Fire fighting appliances | 95 |
| D.14 | Mains filter | 95 |
| D.15 | Mains chokes | 96 |



Table of contents

- Appendix E - STO (Safe Torque Off) 97**
- E.1 General: Methods to avoid an unexpected starting 97
- E.2 Safety categories according to EN ISO 13849-1. 100
- E.3 The safety relay. 100
- E.4 Application example for machine of category 3 according to EN ISO 13849-1. 102
- E.5 Application example for machine of category 4 according to EN ISO 13849-1. 104
- E.6 Operating lifetime 105
- E.7 Classification of safety and instructions 106

- Table of figures 109**
- Index 111**
- Revision survey 113**

INTRODUCTION

This manual is an important part of your **b maXX 4500** appliance; Please, therefore completely read this manual, before starting operation, last but not least on behalf of your own security.

In this chapter we describe the first steps, which have to be done after you have received the device. Terms are defined, which are continuously used in this manual. We will inform you about duties, which must be considered when using this device.

1.1 Survey of the appliance series b maXX 4500

An appliance of the series **b maXX** exists of a power unit and a controller cartridge, which are in a common cabinet. The appliances are available in graded construction- and capacity sizes.

In this manual we will describe the Baumüller device series „**b maXX 4500**“, the connection and the commissioning.

WARNING



The following **can occur**, if you disregard this safety note:

- serious personal injury
- death

All persons, who work on and with devices of the series **b maXX 4500**, must have this manual available at their work place and must follow the instructions and notes contained therein - especially the safety instructions.

1.2 First steps

- ▶ Check delivery, see ▶ [Transportation and packing](#)◀ from page 23.
- ▶ Provide for qualified personnel for the mounting, installation and commissioning.
- ▶ Hand over this manual to the personnel for mounting, installation and commissioning. Assure that especially the safety instructions are understood and followed.

1.3 Used terms

In this manual we will also use the term „device“ or the identification „**BM4500**“ for the Baumüller product „**b maXX 4500**“. A list of the abbreviations which are used are to be found in [▶Appendix A - Abbreviations◀](#) from page 75.

1.4 Copyright and trade mark

b maXX[®] is a registered trade mark of Baumüller Nürnberg GmbH

Hiperface[®] is a registered trade mark of SICK/Stegmann

2

FUNDAMENTAL SAFETY INSTRUCTIONS

2.1 General notes

In this chapter dangers are described, arising when working with the Baumüller-device. Dangers are pointed up with symbols (icons). All symbols that are used in this manual are listed and explained.

How you can protect yourself against the single dangers in the concrete case, we will not explain in this chapter. This chapter contains only general protective measures. The concrete protective measures we will always give directly after the note to the danger.



WARNING

The following **may occur**, if you do not observe this warning information:

- serious personal injury
- death

The hazard information is showing you the hazards which can lead to injury or even to death.

Always observe the hazard information given in this documentation.

2.2 Legal instructions

This documentation is addressed to technical qualified personnel, who is specifically skilled and who is thoroughly familiar with all warnings and maintenance procedures.

The devices are made according to the state-of-the-art technology and are fail-safe. They can be installed safe, can be put into operation and they function without problems, if it is assured, that the instructions of the documentation are followed.

The user is responsible for the execution of service and commissioning according to the safety instructions of the prevailing standards and other relevant national and local instructions concerning conductor dimensioning and protection, earthing, disconnector, overcurrent protection and so on.

For damages, which result from the mounting or from the connection, the one is liable, who has carried out the mounting or the installation.

2.3 Appropriate use

Always use the device according to the terms. Stated below we have carried a few important notes together. The notes stated below shall give you a feeling for the according to the terms usage of the device. We do not raise any claim for the completion of the notes stated below - follow all instructions given in this operating instruction.

- project the application in such a way, that you always operate the device within its specification.
- use this device only as converter for three-phase drives.
- make sure, that only qualified personnel work with/at this device.
- install this device only on an adequate carrying wall.
- install this device in the way as it is described in the documentation.
- make sure, that the mains/power supply unit always applies to the predetermined specifications.
- only operate the device, if it is technical faultlessly.
- operate this device only in combination with released components of the company Baumüller Nürnberg GmbH.
- always operate the device in an area as it is instructed in the "Technical data".
- operate the device only on low voltage supply systems, that are not used for the supply of buildings in residential areas (according to EN 61800-3, chapter 3.4, 2. environment).
- always operate the device in serialized condition.
Due to safety reasons you must not rebuild the device.
- consider all instructions referring to this, if you intend to store the device.

You are using the device according to the terms, as soon as you regard all notes and information in this operating manual.

2.4 Inappropriate use

In the following we are listing a few examples of faulty usage. The notes mentioned below shall give you a feeling, what a faulty usage of the plug-in module is. However, we cannot list all faulty usages, that could be thought of. All usages, in which the instructions of this documentation are disregarded are faulty and therewith forbidden, especially in the following cases:

2.5 Hazard information and commands

Each hazard is classified in one of three different hazard classes. Every hazard class has one of the following characteristic signal words:

DANGER

- serious property damage
- serious personal injury
- death - **will** occur

WARNING

- serious property damage
- serious personal injury
- death - **may** occur

CAUTION

- minor to medium personal injury or
- environmental pollution or
- property damage - **may** occur

2.5 Hazard information and commands

2.5.1 Hazard information structure

The following two examples show you how the hazard informations are constructed. The triangle is used when indicating a hazard for human beings. When there is a circle instead of the triangle, the hazard information is only for possible property damage.



A triangle indicates hazard for human beings.
The shade of grey of the outline reflects the severity of the hazard - darker grey means rising hazard.



The icon within the square illustrates the hazard.
The outline's shade of grey reflects the severity of the hazard - darker grey means rising hazard. (Not every hazard information has a square representing the hazard, so we have shown it as draft here)



The icon in the circle represents a command.
(Not every hazard information has a circle representing the hazard, so we have shown it as draft here)



The circle indicates hazard for property.



The icon within the square illustrates the hazard.
The outline's shade of grey reflects the severity of the hazard - darker grey means rising hazard. (Not every hazard information has a square representing the hazard, so we have shown it as draft here)

The text beneath the icons is constructed as follows:

HERE STANDS THE SIGNAL WORD WHICH INDICATES THE DEGREE OF THE HAZARD



Here we tell if one or more of the consequences described lower will occur if this hazard information is not observed.

- here we describe the possible consequences. The worst consequence stands on the right side.

Here we describe the hazard.

Here we describe what you can do to avoid this hazard.

2.5.2 Form of the hazard sign (triangular or round)

If there is a triangle like  or  or  in front of the signal word, the hazard information is referring to personal damage.

If there is a round hazard signal like  in front of the signal word, the hazard information is referring to property damage.

2.5.2.1 Hazard information on personal injury

To distinguish each class of hazard information, we use a characteristic outline for both the triangular hazard signs and the square-form icons

For the hazard class **DANGER** the  danger sign is used. The hazard information of this hazard class used in this documentation is listed below:

DANGER



The following **will occur**, if you do not observe this danger information:

- serious personal injury
- death



*The hazard is: **electricity**. Here the hazard may be described in detail.*

Here is described what you can do to avoid the hazard.

DANGER



The following **will occur**, if you do not observe this danger information:

- serious personal injury
- death



*The hazard is: **mechanical influence**. Here the hazard may be described in detail.*

Here is described what you can do to avoid the hazard.

2.5 Hazard information and commands

For the hazard class **WARNING** the warning sign  is used. The following hazard information of this hazard class is used in this documentation.



WARNING

The following **may occur**, if you do not observe this warning information:

- serious personal injury
- death

*The hazard is: **electricity**. Here the hazard may be described in detail.*

Here is described what you can do to avoid the hazard.



WARNING

The following **may occur**, if you do not observe this warning information:

- serious personal injury
- death

*The hazard is: **mechanical influence**. Here the hazard may be described in detail.*

Here is described what you can do to avoid the hazard.



WARNING

The following **may occur**, if you do not observe this warning information:

- serious personal injury
- death

*The hazard is: **electro-conductive liquid together with electricity**. Here the hazard may be described in detail.*

Here is described what you can do to avoid the hazard.



WARNING

The following **may occur**, if you do not observe this warning information:

- serious personal injury
- death

*The hazard is: **electro-magnetic radiation**. Here the hazard may be described in detail.*

Here is described what you can do to avoid the hazard.





WARNING

The following **may occur**, if you do not observe this warning information:

- serious personal injury
- death



*The hazard is: **liquid coolant**. Here the hazard may be described in detail.*

Here is described what you can do to avoid the hazard.

2.5 Hazard information and commands

For the hazard class **CAUTION** the caution sign  is used when there is hazard for persons or of environmental pollution. The following hazard information of this hazard class is used in this documentation.



CAUTION

The following **may occur**, if you do not observe this caution information:

- minor to medium personal injury.

*The hazard is: **hot surface**. Here the hazard may be described in detail.*

Here is described what you can do to avoid the hazard.



CAUTION

The following **may occur**, if you do not observe this caution information:

- minor to medium personal injury.

*The hazard is: **sharp edges**. Here the hazard may be described in detail.*

Here is described what you can do to avoid the hazard.



CAUTION

The following **may occur**, if you do not observe this caution information:

- minor to medium personal injury.

*The hazard is: **rotating parts**. Here the hazard may be described in detail.*

Here is described what you can do to avoid the hazard.



CAUTION

The following **may occur**, if you do not observe this caution information:

- minor to medium personal injury.

*The hazard is: **injury of the eye caused by ricocheting particles**. Here the hazard may be described in detail.*

Here is described what you can do to avoid the hazard.

**CAUTION**

The following **may occur**, if you do not observe this caution information:

- minor to medium personal injury.

*The hazard is: **noise**. Here the hazard may be described in detail.*

Here is described what you can do to avoid the hazard.

**CAUTION**

The following **may occur**, if you do not observe this caution information:

- minor to medium personal injury.

*The hazard is: **hazard of sliding caused by liquid**. Here the hazard may be described in detail.*

Here is described what you can do to avoid the hazard.

**CAUTION**

The following **may occur**, if you do not observe this danger information:

- environmental pollution.

*The hazard is: **unadequate disposal**. Here the hazard may be described in detail.*

Here is described what you can do to avoid the hazard.



2.5 Hazard information and commands

2.5.2.2 Hazard information on property damage

If there is a round caution sign  in front of the signal word, the safety information refers to property damage.



CAUTION

The following **may occur**, if you do not observe this caution information:

- property damage.

*The hazard is: **electro-static discharge**. Here the hazard may be described in detail.*

Here is described what you can do to avoid the hazard.



CAUTION

The following **may occur**, if you do not observe this caution information:

- property damage.

*The hazard is: **damage of the coolant hose**. Here the hazard may be described in detail.*

Here is described what you can do to avoid the hazard.



2.5.2.3 Command signs used



wear safety gloves



wear safety shoes



wear eye protection



wear ear protection



Use this fire extinguishing agent:
„fire extinguishing agent“

2.6 Information sign



NOTE

This note is a very important information.

- You ignored notes in this manual.
- The device has not been specifically applied as a converter in order to control a motor.
- The device has been
 - mounted incorrectly,
 - connected incorrectly,
 - commissioned incorrectly,
 - operated incorrectly,
 - mounted, connected, commissioned, operated and/or maintained by not qualified or inadequately qualified personnel,
 - inappropriately or not maintained (also consider the descriptions of the components),
 - overloaded it,
- operated it
 - with defective safety devices,
 - with incorrectly mounted safety devices or without safety devices,
 - with incorrectly working safety- and protection devices,
 - outside the specified environmental conditions.
- You have modified the device.
- You have insufficiently monitored the parts, which are subject to a wearing.
- You have improperly carried out a repair.
- You have combined the device with improper products, which are not enabled for b maXX devices.
- You have combined the device with faulty and/or faulty documented products of other manufacturers.
- The device has been operated in an explosive environment.

2.7 Safety equipment

The devices BM454X fulfill the protective system . By mounting the device into a control cabinet you can raise the protective system.

2.8 Training of the personnel



WARNING

The following **may occur**, if you do not observe this warning information:

- serious personal injury
- death

Devices of the company Baumüller Nürnberg GmbH may only be assembled, installed, operated and maintained by qualified personnel.

Qualified personnel (professionals) is defined below:

Qualified personnel

Authorized electronic engineers and skilled persons of the customer or third persons, who have learned the installation and commissioning of Baumüller drive systems and who are authorized, to put circuits and devices into operation according to the standards of the safety technology, to ground and to label.

Qualified personnel has a training or an instruction due to the local valid standards of the safety technique in maintenance and usage of an adequate safety equipment.

Requirements to the operating personnel

The operating of the drive system must only be executed by persons, who have had a training, who have been instructed and who have been authorized for this.

Fault clearance, servicing, cleaning, maintenance and exchange must only be carried out by skilled or instructed personnel. These persons must know the operating manual and must act according to this.

The commissioning as well as the instruction must only be carried out by qualified personnel.

2.9 Safety precautions in normal operation

- at the location of your appliance regard the safety regulations for the plant, into which the appliance has been built in.
- if safety regulations require additional monitoring or safety devices supply your appliance with them.

2.10 Dangers due to residual energy

Electrical residual energy

After separation of the device from the mains parts under voltage as e. g. power connections may be only then touched if the capacitors in the device are discharged (see „discharging time“ in [▶Electrical data - BM454X◀](#) on page 88). Also pay regard to the instructions on the device. If you have additional capacitors connected to the DC-link, the DC-link discharging also can last much longer. In this case you must determine the necessary waiting time on yourself or measure whether the device is off-circuit.

Mechanical residual energy

The mechanical residual energy is dependent upon the application. As we don't know the application, we cannot make any exact statements. Driven parts also rotate/move after disconnection of the mains supply for a certain time. Please, provide adequate safety arrangements.

2.11 Disposal of the device

The accurate disposal of the device is described in [►Disposal◄](#) from page 71.

2.12 Fire fighting



WARNING

The following **may occur**, if you do not observe this warning information:

- serious personal injury
- death



*The danger is: **Electricity when using a conductive fire fighting appliance.***



Use this fire extinguishing agent:
ABC powder / CO₂

2.13 Responsibility and liability

To be able to work as safe as possible with this device, you must know and follow the danger notes as well as the safety instructions.

2.13.1 Observing the safety notes and safety instructions

In this manual we use visually unified safety instructions, which are intended to prevent from personal injury or damage to property.



WARNING

The following **may occur**, if you do not observe this warning information:

- serious personal injury
- death

All persons, who work with this device, must know and regard the safety notes and the safety instructions in this manual.

Apart from this, any and all persons who work on this device must additionally know and regard to all regulations and instructions, that are valid at the location.

2.13.2 Dangers when handling this device

The device „**b maXX**“ was developed and manufactured according to the state-of-the-art technology and in compliance with the valid regulations and standards. It is still possible that dangers can arise during use. An overview of possible dangers is to be found in chapter [►Fundamental safety instructions◄](#) from page 9.

We warn you against the acute danger at the respective places in this manual.

2.13.3 Warranty and Liability

All information in this manual is non-binding customer information; it is subject to ongoing further development and is updated on a continuous basis by our revision service.

Warranty- and liability claims against Baumüller Nürnberg GmbH are excluded if in particular one or more of the causes listed in [►Inappropriate use◄](#) from page 11 has/have caused the damage.

3

TRANSPORTATION AND PACKING

In this chapter we describe, which conditions have to be adhered to at transportation, how you check the device after receipt and what you should have to consider, if you dispose the packing.

3.1 To be considered by transportation

For the first transportation of the device, the device was packed in the manufacturer company. In case you transport the device, assure, that the following conditions are fulfilled during the whole transportation:

- 2 K 3 (climatic category) ¹⁾
- - 25 °C to + 70 °C (temperature range)
- rel. humidity 95 % at +40 °C
- max. 1 g (vibration, shock, repetitive shock)

¹⁾ EN 50178, table 7

3.2 Unpacking

After receipt of the device, which is still packed:

- ▶ Avoid strong transportation vibrations and severe hits, e.g. when setting down.
- ▶ Check, if transportation damages are visible!

If so:

- ▶ Immediately complain to the deliverer. Let the claim be confirmed in writing and immediately contact the substitution of Baumüller Nürnberg GmbH, which is in charge for your company.

3.3 Dispose packing



WARNING

The following **may occur**, if you do not observe this warning information:

- serious personal injury
- death



*The danger is: **electricity**.*

Do not operate the device, if you have recognized a transportation damage or if you assume this. In this case immediately contact Baumüller Nürnberg GmbH

If there is no transportation damage recognizable:

- ▶ Open the packing of the device.
- ▶ Check the scope of supply on basis of the delivery note.

The minimum scope of supply is:

- **b maXX 4500**
- This manual inclusively the copy of the declaration of conformity/declaration of manufacturer
- ▶ Claim at the Baumüller substitution, which is in charge, in case the delivery is not complete.

3.3 Dispose packing

The packing is made of cardboard, plastics, metal parts, corrugated cardboard and/or wood.

- ▶ Regard the local disposal instructions, in case you dispose the packing.

DESCRIPTION OF THE DEVICES

In this chapter the basic construction of the devices **b maXX 4500** and the slots of the controller cartridge are described and the type key on the devices is explained.



NOTE

The devices of the **b maXX 4500**-series are provided for the operation in the „second environment“ (industrial environment) according to EN 61800-3. In case you operate the device in the „first environment“ (residential area), you perhaps must carry out additional interference procedures.

4.1 Structure

The devices of the **b maXX** series are servo converters of Baumüller Nürnberg GmbH. The devices consist of a power unit with an integrated slot for the controller cartridge. For this control only plug-in controllers of Baumüller Nürnberg GmbH must be used.

- V-Controller
- M-Drive

There is a separate description for the controller.

A device of the series **b maXX 4500** consists of the following parts:

A: Power unit
(converter)

This part is a power semiconductor converter combination which is build up with power semiconductor components. The present alternating voltage at the three-phase system is converted into direct voltage by the input sided rectifier. The DC link capacitors smooth this DC link direct voltage. The output sided inverter generates a three-phase alternating current system from the direct voltage with variable frequency and voltage for the supply of the connected motor.

Alternatively you can supply other devices with d. c. via the DC link connections.

B: Controller unit

The controller unit controls the power unit. You can operate the controller part either with the operating software WinBASS II (PC) or via a PLC or via a field bus and PLC.

4.2 Interconnect the devices

The device is part of the Baumüller series **BM4500** and can be connected together with other Baumüller devices.

4.3 Variants

The Baumüller device series **BM4500** is in several capacities

- BM4543
- BM4544
- BM4545

available.

Furthermore it is differed between the version of cooling:

- Control cabinet device **S** (ventilation within the control cabinet)

4.3.1 Basic types/types with Safe Torque Off (STO)

Beside of the basic types there are device types, which fulfill in combination with specially designed controllers the demands of the safety function STO (Safe Torque Off) according DIN EN ISO 13849-1, EN 62061 and EN 61800-5-2.

This type codes of this power units

- BM45XX-SI1-XXXXS01

For the STO function following controllers are admitted:

- M-Drive with type code: BUS6-MC-XXX-XXXX-XXXX-SIXX-...

or

- V controller with type code: BUS6-S1-VC-...

4.5 Marking of the device - type code

4.5 Marking of the device - type code

On the type plate (label) you will find, besides others, the type key of the device.

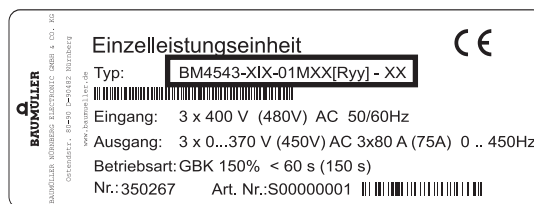
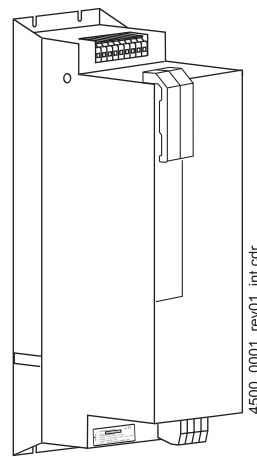

Figure 2: Position of type key label

The type key has the form: **BM45XX - XXX - XXXXX[Ryy] - XX**. Directly behind the type key is the design code (-XXXX - X - XXX - XXX). The design code contains information, which only is important to Baumüller Nürnberg GmbH. That's why in the following table only the type key is explained.

- BM4**XXX - XXX - XXXXX[Ryy] - XX Device generation
- BM4**5**XX - XXX - XXXXX[Ryy] - XX Controller type
 - 5: M-Drive or V-Controller
- BM4X**4**X - XXX - XXXXX[Ryy] - XX Size of cabinet
- BM4XX**X** - XXX - XXXXX[Ryy] - XX Current grading (output rated current)
 - 3 to 5 (current value is dependent on the cabinet size), see [►Appendix D - Technical data◄](#) from page 83.
- BM4XXX - **X**XX - XXXXX[Ryy] - XX Cooling type
 - S: air-cooled with air supply and with air outlet in the control cabinet
 - A: air-cooled with air supply and with air outlet outside the control cabinet
 - Z: water-cooled with water cooler in the control cabinet
 - F: water-cooled with water cooler outside the control cabinet
 - C: (cold plate) cooling via mounting wall of the control cabinet

| | |
|--|---|
| BM4XXX - <u>XX</u> X - XXXXX[Ryy] - XX | Mains type T: TN- or TT-mains I: IT-mains and „grounded delta“ |
| BM4XXX - <u>XXX</u> - XXXXX[Ryy] - XX | Safety relay 0: no module 1: module with one relay and high power current contacts 2: module with two relays and high power current contacts 3: module with one relay and low current contacts 4: module with two relays and low current contacts |
| BM4XXX - XXX - <u>XXXXX</u> [Ryy] - XX | Hardware type/power unit type 0: rectifier and inverter with chopper resistor transistor $U_{DC} = 540\text{ V}$ |
| BM4XXX - XXX - <u>XXXXX</u> [Ryy] - XX | Controller 1M: device for V-Controller or M-Drive cartridge |
| BM4XXX - XXX - XXXXX[Ryy] - XX | optional chopper resistor R16: chopper resistor with 16 Ω R10: chopper resistor with 10 Ω R05: chopper resistor with 5 Ω R03: chopper resistor with 3 Ω |
| BM4XXX - XXX - XXXXX[Ryy] - <u>XX</u> | State of software controller (firmware) |

**NOTE**

This type code is valid only for the (basic) unit, the controller has an own type key.

**NOTE**

A device with safety relay, whose part number does **not** start with „06“, does not apply as a safety device as defined by the PL classification according to ISO 13849 or SIL according to EN 61800.

This device is not certificated for safety functions

Only a device which is affixed with the test mark of the TÜEV Rheinland and the Safety label has a certificated safety function as defined by the PL classification according to ISO 13849 or SIL according to EN 61800.



Functional
Safety
Type
Approved

www.tuv.com
ID 060000000

new marking



former marking

4.6 UL-notes

The notes below must be observed at a cc - conformity drive.

In case you consider UL 508 C observe the notes below also:

- [▶Parameter Manual b maXX BM4400, BM4600, BM4700◀](#)
 - Adjustment for motor overload monitoring
- [▶Requirements to the connecting cables◀](#) from page 39
 - Use 60 °C/75 °C copper wire only for all devices
 - Use Class 1 wire only.
- [▶Connection data of the power connections◀](#) from page 44
 - Note tightening torque for field wiring terminals
- Only for water-cooled devices:
 - In order to avoid internal condensation: Temperature of cooling water shall be specified to be at least equal to the specified surrounding air temperature.
 - Maximum cooling water temperature 60°C.
 - Maximum water pressure 3 bar / 300 kPa in the cooling circuit.
- [▶D.3 Required environmental conditions◀](#) on page 86
 - Use the device only in a pollution degree 2 environment
 - Observe the maximum ambient temperature and the derating
- [▶D.1 Requirements on the power supply◀](#) on page 84
 - Observe the short circuit current capability. The device is rated for Short Circuit Current Rating (SCCR) of 65 kA, 480 V AC max.
 - 24 V supply must not reach more than 30 V DC. Additional fuse protection with max. 4 A fuse.
- [▶D.7 Fuse protection◀](#) on page 90
 - Converters may be used with listed fuses or listed circuit breakers DIVQ as overcurrent protection.
- [▶Manual V controller◀](#)
 - Observe the connecting data of the motor temperature sensor, see paragraph „Motor Temperature“ in chapter „Connector Pin Assignment“ .

4.6.1 cUL-notes

Additional only for Canada:



NOTE

Overvoltage Protection Device have to be installed in front of the input circuitry of the device to limit the maximum overvoltage peak to 2.5 kV.

5

MOUNTING

In this chapter we describe the mechanical mounting of the device into a control cabinet. Information about the installation space is also to be found in this manual (see [►Installation space◄](#) from page 33).

Mounting consists of the following steps:

- 1 Prepare mounting (drill holes/cut-out segments)
- 2 Install device

5.1 General safety instructions



CAUTION

The following **can occur**, if you disregard this safety note:

- damage to property



*The danger is: **electrostatic discharge**. Connections of the device sometimes are dangerous to ESD.*

Regard the corresponding notes.

-
- Please regard to the information in chapter [►Fundamental safety instructions◄](#) from page 9.

5.2 Requirements to the executing personnel

- ▶ Pay attention to all areas at the device, which could be dangerous for you while mounting. Use this survey only for the mechanical mounting. Dangers, which, for example, result from electricity are not shown here.

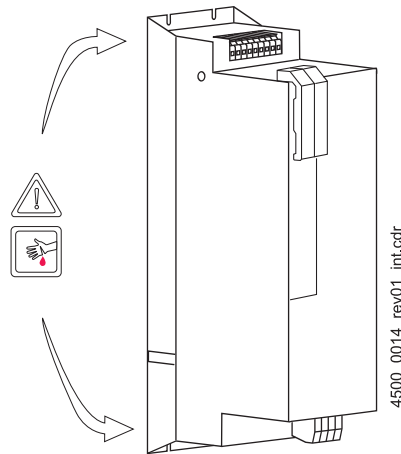

Figure 3: Danger areas at the mechanic mounting

5.2 Requirements to the executing personnel



CAUTION

The following **may occur**, if you do not observe this safety information:

- minor to medium personal injury.

*The danger is: **sharp edges**. In case, while installing, you lift a device with unprotected hands, fingers/palm can be cut. If the device falls off, your feet can be cut up.*

Assure, that only qualified personnel, who is familiar with the safety as well as with the mounting instructions, mount this device.



wear safety gloves



wear safety shoes

Qualified personnel are persons, who have been instructed by the responsible person, based on their training, experience, the instructions they were given as well as their knowledge about relevant standards and instructions, knowledge of the accident prevention instructions and of the company, to carry out the necessary operations and thereby are able to recognize and avoid the dangers which could happen. The required qualifications for the work with this unit are for example:

- Training or instruction due to the standards of the safety engineering in maintenance and use of appropriate safety equipment.

5.3 Prepare mounting

You can prepare the mounting with the configuring manual for your installation. With the project manual and the drill figures (see [▶Drilling patterns◀](#) from page 34) you can determine the dimensions for the cut-outs and for the fastening drills.

CAUTION

The following **may occur**, if you do not observe this safety information:

- minor to medium personal injury.

*The danger is: **Eye injury due to catapulting particles.** While executing the drillings and the cut-out metal particles are catapulted.*



wear eye protection

- ▶ Carry out the drillings and if necessary the cut-outs.

5.4 Installation space

The following drawings show the main dimensions of the devices in mm. Use these drawings, in order to determine the required space in the control cabinet. For the construction of the necessary drillings/cut-outs use the drawings in [▶Drilling patterns◀](#) on page 34.

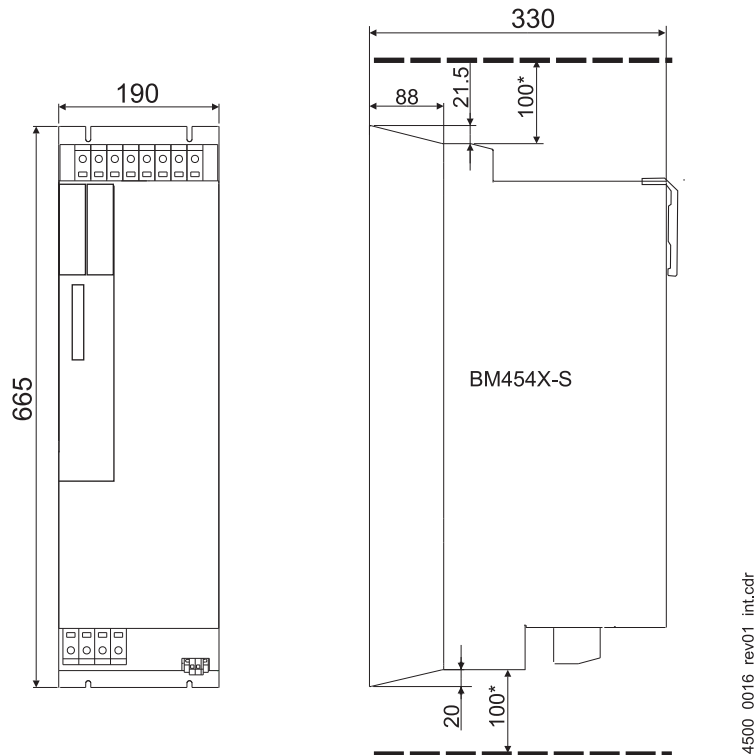

Figure 4: Installation space BM454X-S/Z

*: min. Expansion space, also consider [▶Cooling◀](#) on page 87

5.5 Drilling patterns

The following drawing shows the drilling pattern. Use this drawing to prepare the necessary drillings/cut-outs. Use the drawings under [► Installation space ◄](#) from page 33, to determine the required space in the control cabinet.

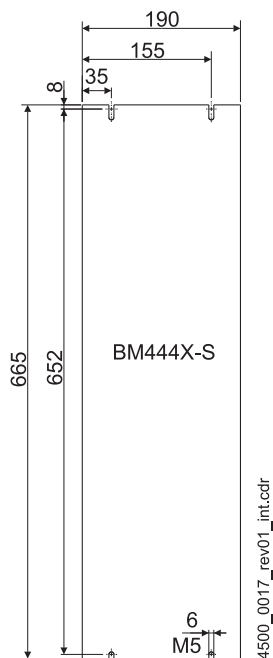

Figure 5: Drilling pattern BM454X

5.6 Mounting instructions

There are different mounting technics. Every mounting procedure is shown as a chart (see [► Abbildung 6 ◄](#) auf Seite 36). Below the chart is the list of the devices, for which the particular instruction is to be used. Which screws and washers you need for the particular mounting, is also to be found below the particular chart.

WARNING

The following **can occur**, if you disregard this safety note:

- serious personal injury
- death

*The danger is: **mechanical effects**. A device of size 454X weighs about 30.0 kg and may seriously injure you, if it falls off.*

Transport the device in a way, so that it cannot fall down. Use a suitable lifting means when mounting it.



**CAUTION**

The following **can occur**, if you disregard this safety note:

- minor to medium personal injury.

*The danger is: **sharp edges**. In case, while installing, you lift a device with unprotected hands, fingers/palm can be cut. If the device falls off, the feet can be cut.*



wear safety gloves



wear safety shoes

Complete the mounting in the following way:

- 1 Provide, if necessary, a suitable transportation-/lift equipment
- 2 Provide suitable mounting accessories
- 3 Mount the device.

5.6 Mounting instructions

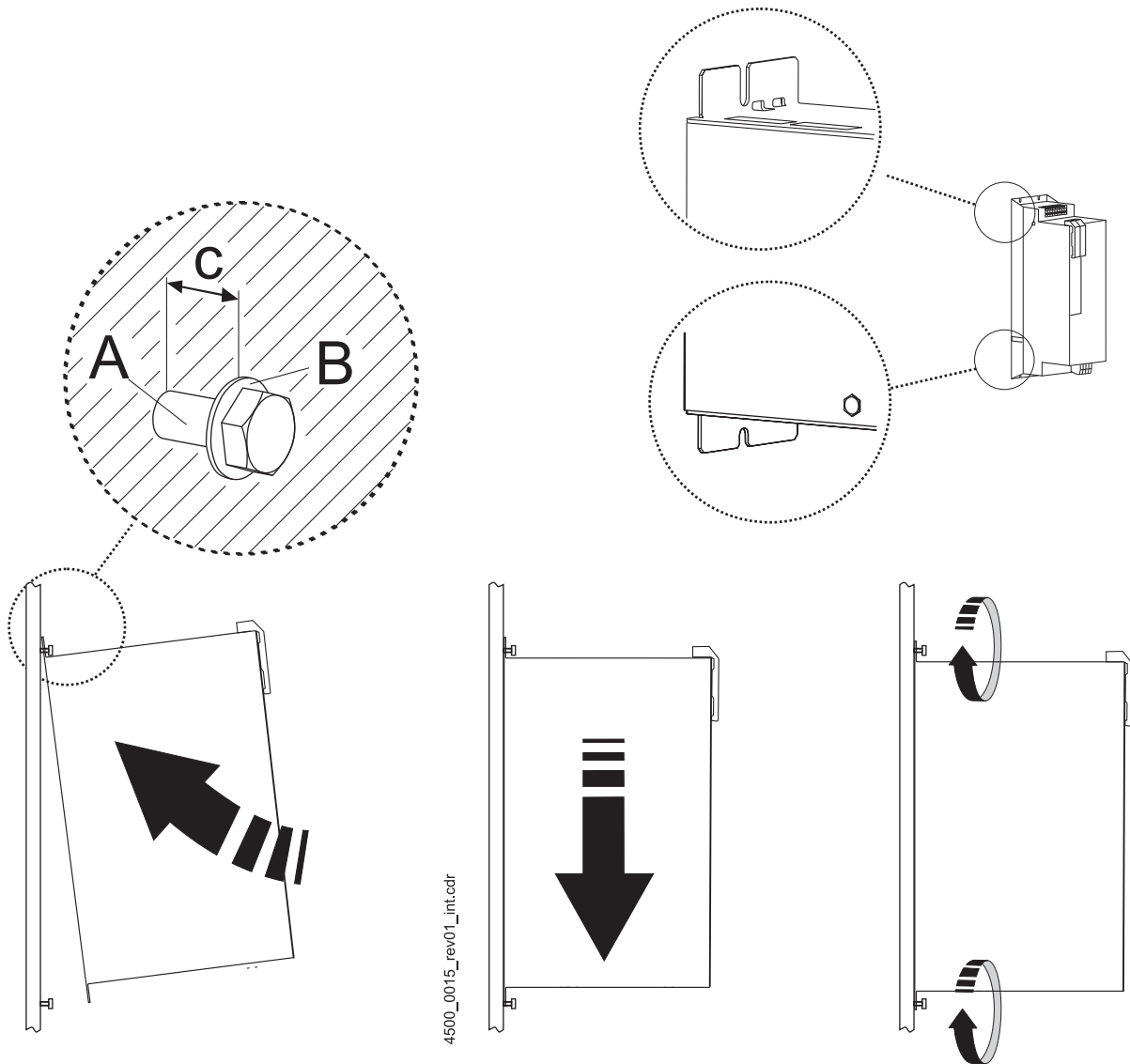

Figure 6: Mounting instruction BM 454X-S

| Device | BM454X-S/Z |
|-------------------|-------------------|
| A - screws | 4 x M5 |
| B - washers | 4 x (5.3 x 15) |
| c - mount spacing | c = 5 mm |

6

INSTALLATION

In this chapter we describe the electric installation of the device. The mechanical installation is described in [▶Mounting◀](#) from page 31.

Before installing assure that the technical preconditions are fulfilled:

- 1 Check the requirements to the electrical mains and check if the existing mains is suitable.
- 2 Check the requirements to the electrical cables and provide the according cables.
- 3 Check the characteristics of the terminals and configure the connections accordingly.

6.1 General safety instructions

- ▶ Pay attention to the information in the chapters [▶Fundamental safety instructions◀](#) from page 9.
- ▶ Pay attention to all areas at the device, which could be dangerous for you during the electrical installation.

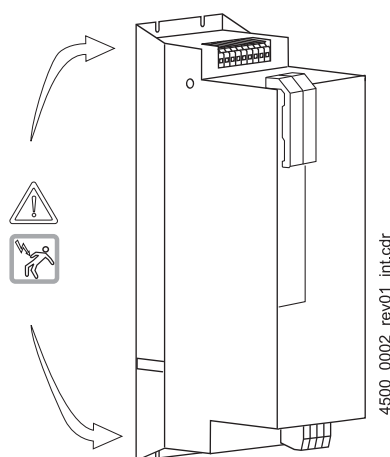

Figure 7: Danger areas at the electrical installation

6.2 Requirements to the executing personnel



WARNING

The following **can occur**, if you disregard this safety note:

- serious personal injury
- death



*The danger is: **electricity**. When operating with this electrical unit, inevitably certain parts of this unit are under dangerous voltage.*

Make sure, that only qualified personnel, who are familiar with the safety- as well as with mounting-, operating- and maintenance instructions, work on this unit.

At each case qualified personnel are persons, who are authorized by the responsible persons, to carry out necessary actions and who recognize the possible dangers and who are able to avoid these dangers. They have had the training, the experience, they were given instructions as well as knowledge about the relevant standards and instructions, they have knowledge of the accident prevention regulations and of the operating environments. The required qualifications for the work with this unit are for example:

- Education or instruction or to have the authorization to put into operation, ground and label circuits and devices according to the standards of safety engineering.
- Training or instruction due to the standards of the safety engineering in maintenance and use of appropriate safety equipment.

6.3 Requirements to the electrical mains

All important data is to be found in [▷D.1 Requirements on the power supply◁](#) on page 84. Small deviations of the electrical mains from the requirements can lead to malfunctions of the device. In case the mains deviates strongly from the requirements, the device can be destroyed. **b maXX 4500**-devices must not be operated in low-voltage mains in order to supply buildings in residential areas. The destruction of the device can cause personnel injury.



WARNING

The following **can occur**, if you disregard this safety note:

- serious personal injury
- death



*The danger is: **electricity**. In case you do not ensure the requirements to the electrical mains, the device can be damaged/destroyed and can thereby endanger persons severely.*

Assure before installation, that the requirements of the electrical mains are fulfilled.

6.4 Requirements to the connecting cables

- ▶ When selecting connection cables, you have to consider the IEC/EN 60204-1, chapter 13.
- ▶ The protective conductor cross section of the cable must be executed accordant to IEC/EN 60204-1, section 5.2, tab. 1.
- ▶ The connection of the protective conductor is imperatively prescribed for the operation of the device.
- ▶ Use a copper cable for at least 60°C (drives < 3 x 100 A) or 75°C (drives ≥ 3 x 100 A) incase you consider UL 508 C.

Further specifications (e.g. maximum permissible length) are to be found in [▶D.9 Cable mains - device◀](#) from page 94 to [▶D.10 Cable device-motor◀](#) from page 94.

6.5 Protection of the device and of the cable respectively

In order to protect the device or the cables against damage/destruction by the mains, you must install fuses. Data of the necessary fuses are to be found in [▶D.7 Fuse protection◀](#) from page 90.

6.6 PE connection and RCD compatibility

Caused by the operating principle via the protective conductor, leakage currents > 3.5 mA_{AC} or > 10 mA_{DC} can flow. Because of this a stationary protective conductor connection is prescribed.

WARNING



The following **can occur**, if you disregard this safety note:

- serious personal injury
- death

This product can cause direct current in the protective conductor. If, considering protection, a differential current device (RCD) is used in case of direct or indirect touching, only a RCD of type B is permissible on the current supply side of this product. On the other hand, another protective measure must be used, as e. g. separation from the environment by double or amplified isolation or the separation from the supply mains with an isolating transformer.

Due to high leakage currents, which arise due to the operating principle of the device, can result in an early enabling of the RCD or generally can avoid an enable.

6.7 Requirements on the laying (EMC notes device)



NOTE

The emission of radio interferences is to a high level dependent on the wiring, the volume expansion and the arrangement of the components in the installation. That is why the assurance of the electromagnetic compatibility according to the public rules only is possible on the completed installation and therefore is in the responsibility range of the manufacturer of the installation or of the operating authority (EMVG § 6, sec. 9).



NOTE

In this Manual you will find the most important information according to an EMC-compatible installation. Further notes, which necessarily have to be considered in order to erect a CE-conform installation are to be found in the manual „filters for mains applications“.

- Use Baumüller motor lines and Baumüller components.
- Use a suitable mains filter of Baumüller Nürnberg GmbH
- Mount all components to a single mounting board with well electroconductive surface (e. g. galvanized steel plate).
- Carry out the ground connection converter/ground plane as short as possible (< 30 cm) with fine-wired cables and a big cross section (> 10 mm²).
- When installing, attend to the correct order:
Mains - fuse - filter - choke - (ferrite core) - **BM4500** - motor.
- Assure, that the motor cables always consist of one piece.
Do not interrupt motor cables by e. g. terminals, contactors fuses etc.
- Run the cables directly on the surface of the grounded mounting board.
(smallest possible effective aerial height).
- Keep a minimum clearance of 20 cm between signal and control wires towards electric power cables at parallel laying.
- Cross cables with different EMC categories (signal cables - mains cables or motor cables) only in a 90° angle.
- Contact the external cable screens when passing through walls, which separate different EMC ranges.
- Connect the shield of the cables of the **b maXX**-devices plane on both ends and highly conductive with ground.

6.8 Operating sequence of installation



WARNING

The following **can occur**, if you disregard this safety note:

- serious personal injury
- death

*The danger is: **electricity**. Parts, which are under tension are perilous.*

Assure, that during the entire mounting, the parts, which are to be mounted (e. g. supply cables) and the mounting range are off-circuit.

Installation exists of the following steps:

- 1 Lay all cables EMC-compatible.
- 2 Connect cables (see [▶Connection diagram◀](#) from page 43).
 - Connect the motor with terminals 1U2, 1V2, 1W2, PE. Attend to the in-phase connection (rotational direction).
(in case you consider UL 508 C: refer to the permissible torque)
 - Connect the fuses (S1).
(in case you consider UL 508 C: use the semiconductor- or total-range-fuses, which are UL-listed in chapter [▶D.7 Fuse protection◀](#) from page 90.)
 - Connect the mains filter (L2).
 - Connect the choke (L1) to the mains filter output.
 - Place the optional ferrite core above the mains cable between choke and device (preferably directly at **BM4500**)
 - Connect the device via the mains input terminals 1U1, 1V1 and 1W1 at the mains choke output.
 - Connect the protective conductor at the terminal PE (a permanent PE connection is imperatively required).
 - Connect the 24 V supply via terminals X99A-1/2 and X99A-3/4.
(in case you consider UL 508 C: limit the current to 4 A).
 - Connect the controller (pulse enable, temperature sensor motor, quickstop and so on), see description of controller.
 - Perhaps connect (dependent on the application) a chopper resistor (R_B) via terminals Ba+, Ba-.
 - Connect the safety relay (if existing) via X68.

6.9 Power connections



Abbildung 8: Terminal connection diagram of power connections

* only for BM454X cooling variants -S and -A.

** The following is valid for all 24 V supply- and control voltage connections:
In case you consider UL 508 C, limit the power in such a way, that each terminal with max. 100 W is loaded. For this you can either use a 24 V power supply with max. 100 W output power, or in greater systems to make a division of several current circuits and thereby protect by a 4 A-fuse each of these current circuits.

Ba-... 1D1 Connections for chopper resistor and DC link, see ▶Figure ◀ on page 43

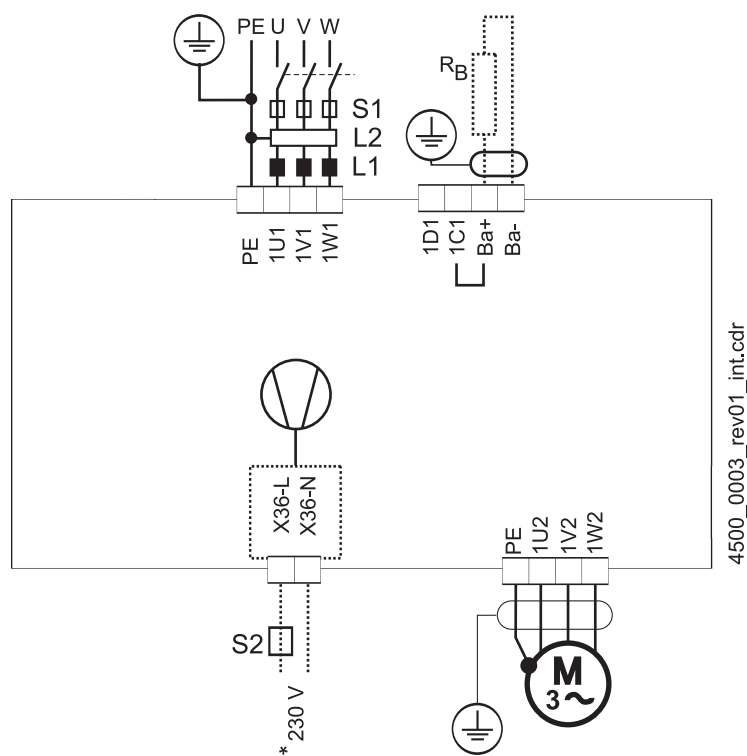
R_B Chopper resistor

PE....1W1 Mains connection, see ▶Figure ◀ on page 43 ff.

S1 Fuses (circuit cable + device)

S2 Fuse (fan) *)

L1 Mains choke

L2 Mains filter

X36 Connections for fan (only BM454X-S/-A)

PE....1W2 Connections for motor, see ▶Figure ◀ on page 43 ff.

6.10 Connection diagram

The connections for the device **BM454X** are shown in the following figure:

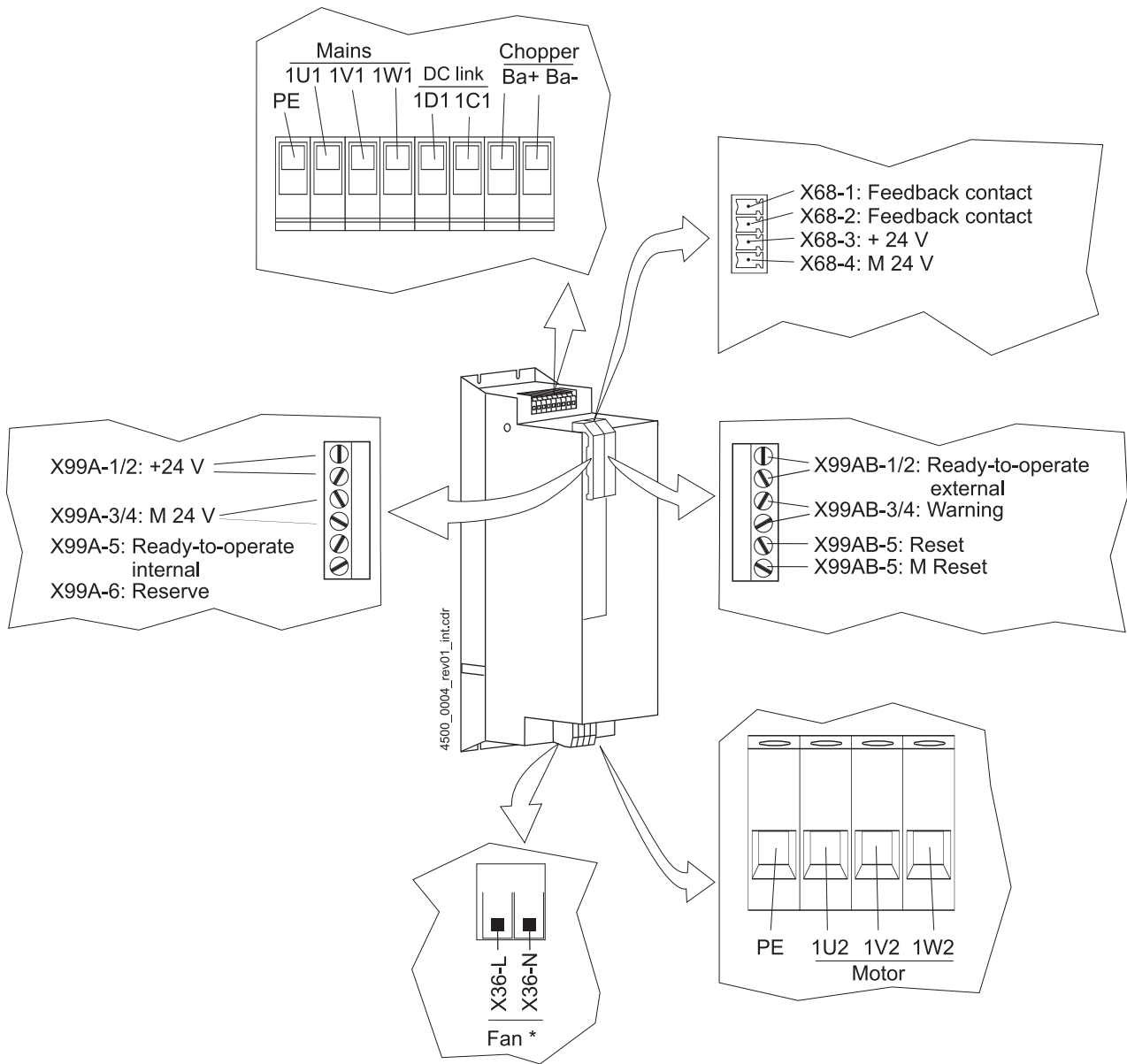

*) nur BM454X-S/-A

Figure 9: Electrical connections

6.10 Connection diagram

6.10.1 Connection data of the power connections

| Mains 1U1, 1V1, 1W1, PE | Max. connection cross-section | Connection technology | Torque | Load capacity |
|----------------------------|-------------------------------|-----------------------|--------|---|
| BM454X | 50 mm ² | screw terminals | 8 Nm | see ▶D.7 Fuse protection◀ from page 90 |

| DC link 1C1 and 1D1 ²⁾ Chopper resistor Ba+ and Ba- ¹⁾ | Max. connection cross-section | Connection technology | Torque | Load capacity 1C1 and 1D1 ¹⁾ Ba+ and Ba- ²⁾ |
|---|-------------------------------|-----------------------|--------|---|
| BM454X | 50 mm ² | screw terminals | 8 Nm | also see ▶D.6 Electrical data - BM454X◀ on page 88 |

¹⁾ Not short-circuit-proof, consider maximum load! See „connected load DC link“ in chapter ▶Technical data◀ from page 83.

²⁾ See „permissible chopper resistor continuous power“ in chapter ▶Technical data◀ from page 83.

| Motor 1U2, 1V2, 1W2, PE | Max. connection cross-section | Connection technology | Torque | Load capacity |
|----------------------------|-------------------------------|-----------------------|--------|--|
| BM454X | 50 mm ² | screw terminals | 8 Nm | is limited by the device Also see ▶Appendix D - Technical data◀ from page 83. |

| Fan X36 | Max. connection cross-section | Connection technology | Loading |
|-------------|-------------------------------|-----------------------|--------------------------|
| BM454X-S/-A | 4.0 mm ² | spring clip | max. 1.0 A ¹⁾ |

¹⁾ For fuse protection a fuse with the tripping characteristic „delayed“ must be used.

6.10.2 Connection data of control connections

WARNING



The following **may occur**, if you do not observe this safety information:

- serious personal injury
- death



*The danger is: **electricity**.*

Avoid to overload the control connections. The permissible maximum current of 10 A per terminal may not be exceeded.

Assure that all control voltages meet the PELV or SELV.

6.10.2.1 Control connection X99A

Use the plug-in terminals, which are attached in order to connect X99A. In case you require further plug-in terminals, contact Baumüller Nürnberg GmbH or directly at the manufacturers' (see [▶B.2 Plugs◀](#) on page 78).

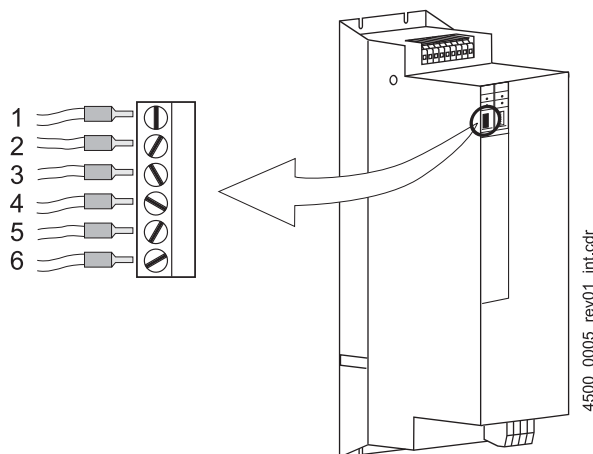



Figure 10: Control connection X99A

6.10 Connection diagram

| Terminal | Pos. 1) | Description | Max. connection cross-section | U _{Range} * | I _{Range} ** |
|--------------------|------------|--|--|--|--|
| +24 V | 1 | + 24 V (PELV) ²⁾ Terminals 1 and 2 internally bridged. | 0.2 to 2.5 mm ² AWG 24 to 12 | 21.6 V (U _{DC}) to 28.8 V (U _{DC}) | 0 A (I _{eff}) to 10 A (I _{eff}) |
| +24 V | 2 | | | | |
| M 24 V | 3 | Ground 24 V (PELV) Terminals 3 and 4 internally bridged. | | 0 V (U _{DC}) | |
| M 24 V | 4 | | | | |
| BB _{int.} | 5 | Message „ready-to operate internal“ ³⁾ (PELV) 0 V: supply unit not ready-to-operate 24 V: supply unit is ready-to-operate  Figure 11: Ready-to-operate internal | | 0 V (U _{DC}) or 28.8 V (U _{DC}) (PLC level) | 0 A (I _{eff}) to 0.2 A (I _{eff}) |
| ZUS. | 6 | Reserved (PELV) | | - | - |

*: Voltages, which can occur at the terminals

** : Currents, which can flow via the terminals

1) Position, see [►Figure 10◄](#) on page 45.

2)

NOTE



The power supply has capacitors at the input (2000µF), so that when switching the 24 V supply, greater charging currents can occur.

3) This message is only related to the basic unit BM4500 (also see [►„Ready-to-operate BB supply unit“◄](#) on page 55).

6.10.2.2 Control connection X99AB

Use the plug-in terminals, which are attached in order to connect X99AB. In case you require further plug-in terminals, contact Baumüller Nürnberg GmbH or directly at the manufacturers' (see [►B.2 Plugs◄](#) on page 78).

WARNING

The following **may occur**, if you do not observe this safety information:

- severe injury

*The danger is: **electricity**.*

Assure that at higher current requirements it is supplied separate.



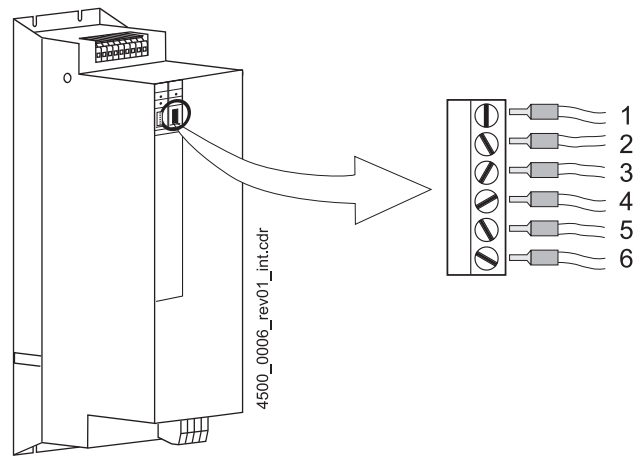
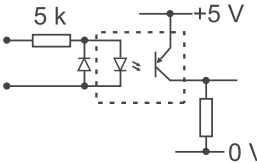

Figure 12: Control connection X99AB

| Terminal | Pos. 1) | Description | Max. connection cross-section | U _{Range} * or 28.8 V (U _{DC}) (SPS level) | I _{Range} ** to 0.5 A (I _{DC}) |
|-----------------------|------------|--|-------------------------------|--|--|
| } BB _(ext) | 1 | Message „ ready-to-operate external “ (PELV) Open contacts: Supply unit not ready-to-operate | 0.2 to 2.5 mm ² | 0 V (U _{DC}) or 28.8 V (U _{DC}) (SPS level) | 0 A (I _{DC}) to 0.5 A (I _{DC}) |
| | 2 | Closed contacts: Supply unit ready-to-operate | | | |
| } Vorw. Stör. | 3 | Message „ warning “ (PELV) Closed contacts: Supply unit - no warning | | | |
| | 4 | Open contacts: Supply unit - warning | | | |
| +Reset | 5 | isolated optocoupler input in order to Reset of error messages: PHASE ERR, POWER ERR, and BRAKE OVERL (PELV).  | | 0 V (U _{DC}) or 28.8 V (U _{DC}) (PLC level) | 10 mA (I _{DC}) to 25 mA (I _{DC}) |
| M Reset | 6 | Specified point for input +Reset (PELV) | | 0 V | - |

*: Voltages, which can occur at the terminals

** : Currents, which can flow via the terminals

1) Position, see >Figure 12< on page 47.

6.10.2.3 Safety relay X68

The safety relay inhibits the generation of a rotating field at the drive's output.

WARNING



The following **may occur**, if you do not observe this safety information:

- serious personal injury
- death



*The danger is: **mechanical influence** by failure of safety relay.*

Assure that the minimum current of the contacts 1 and 2 are not less than 10 mA during operation. Operate the safety relay within its specifications. You should monitor the feedback contact

| Coil side | |
|-------------------|--|
| Rated voltage | 24 V (PELV) |
| Operating voltage | 19 V to 37 V at $T_{\text{ambient}} = 20\text{ °C}$ (PELV) |
| Coil resistance | 660 Ω to 905 Ω |

| Contact side | |
|-----------------------------|-------------------------|
| Switching voltage U_{AC} | max. 25 V_{AC} (PELV) |
| Switching voltage U_{DC} | max. 60 V (PELV) |
| Switching current | max. 5 A |
| Continuous current | min. 10 mA - max. 6 A |
| Switching capacity P_{AC} | max. 150 VA |
| Switching capacity P_{DC} | max. 30 W |

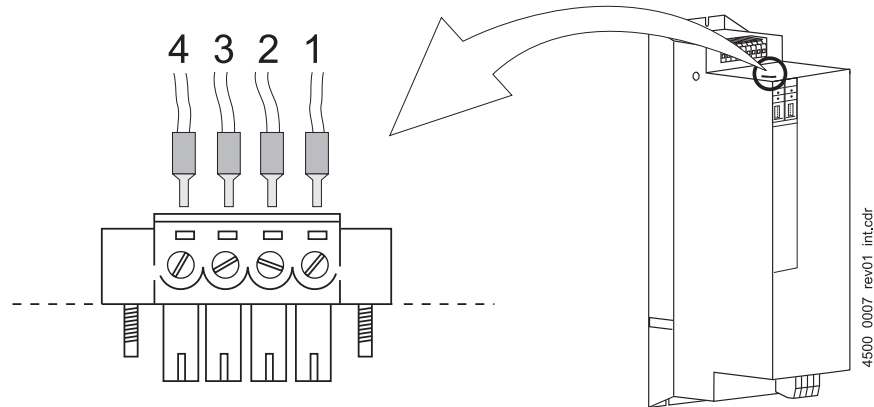



Figure 14: Safety relay X68

| Terminal | Pos. ¹⁾ | Description | max. Connection cross-section | Load capacity |
|---|--------------------|--|-------------------------------|---|
|  | 1 | Status signal (NC contact), if safety relay is active (PELV) | 1.5 mm ² | see ▶Electrical data - BM454X◀ from page 88 |
| | 2 | | | |
| +24 V | 3 | +24 V connection to deactivate safety relay (PELV) | 1.5 mm ² | |
| M 24 V | 4 | Specified point to input +24 V (PELV) | | |

*: Voltages, which can occur at the terminals

** : Currents, which can flow via the terminals

¹⁾ Position see [▶Figure 14◀](#) on page 49.



NOTE

When operating the motor, terminal 3 must be connected to +24 V (U_{DC}) and 4 with 0 V (U_{DC}).

„Safety relay off“ is stored as a message and must be reset by the use of the controller.

A detailed description of the safety relay is to be found in [▶Appendix E - STO \(Safe Torque Off\)◀](#) from page 97.

OPERATION

The device is operated only via the controller (see controller description). The only exception is the resetting (acknowledge) of errors via the opto-coupler input „Reset“ of plug-in terminal X99AB.

In this chapter we do not describe the operation but the monitoring and display elements on the device, which are important for the operation.

7.1 Safety instructions

- Refer to the safety instructions from the chapter [Fundamental safety instructions](#) from page 9.



CAUTION

The following **can occur**, if you disregard this safety note:

- damage to property

*The danger is: **Environmental conditions, that do not refer to the demands.***

Assure, that the environmental conditions are referred to during operation (see [D.3 Required environmental conditions](#) on page 86).



WARNING

The following **can occur**, if you disregard this safety note:

- serious personal injury
- death

*The danger is: **electricity.** The control cabinet, in which the device is built in, shall protect against contacts with parts which are under voltage.*

Assure, that during operation all doors of the control cabinet are closed.

Assure, that during operation all safety devices work.

7.2 Requirements to the executing personnel



WARNING

The following **can occur**, if you disregard this safety note:

- serious personal injury
- death



*The danger is: **electricity**. When operating with this electrical unit, inevitably certain parts of this unit are under dangerous voltage.*

Assure, that only qualified personnel work on this unit.

At each case qualified personnel are persons, who are authorized by the responsible persons, to carry out necessary actions and who recognize the possible dangers and who are able to avoid these dangers. They have had the training, the experience, they were given instructions as well as knowledge about the relevant standards and instructions, they have knowledge of the accident prevention regulations and of the operating environments. The required qualifications for the work with this unit are for example:

- Education or instruction or to have the authorization to put into operation, ground and label circuits and devices according to the standards of safety engineering.
- Training or instruction due to the standards of the safety engineering in maintenance and use of appropriate safety equipment.

7.3 Monitoring functions and its messages



NOTE

The monitoring functions are only active, if the +24V-supply voltage (X99A) is present.

The monitoring functions of the unit are divided into two groups. The first group is „Monitoring functions supply unit“. The second group is „Monitoring functions motor-sided power unit“. This division corresponds to the internal construction of the unit.

7.3.1 Monitoring functions supply unit

The messages, which were generated from the „Monitoring functions supply unit“ are indicated via relay contacts. The messages are transferred simultaneously to the controller and processed.

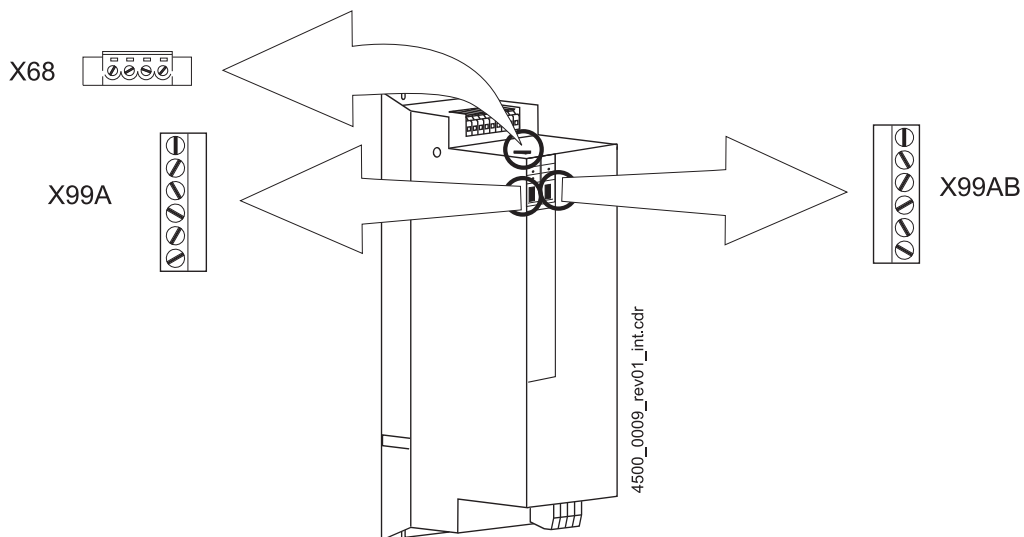

Figure 15: Position of relay contacts

Further information according messages and the involved relay contacts are to be found in [▶Messages via relay contacts◀](#) on page 60.

7.3.2 Monitoring functions motor-sided power unit

The messages, which were generated by „monitoring functions motor-sided power unit“ are exclusively transmitted to the controller and processed there. Further information is to be found in [▶Monitoring functions◀](#) from page 56.

7.4 Ready-to-operate

The message „Ready-to-operate BB“ is the most important message to know. If a monitoring function generates a message, which resets the message „Ready-to-operate BB“ the drive is stopped.

There is not only one single message „Ready-to-operate“. If, for example, a V-controller is in **b maXX 4500**, there are four different messages „Ready-to-operate BB“ in one drive.

- „Ready-to-operate supply unit“ (in **b maXX 4500** existent and visible)
= „Ready-to-operate BB internal“(digital output X99A - 5)
= „Ready-to-operate BB external“(relay contacts X99AB - 1.2)
- „Ready-to-operate BB power unit“ (in **b maXX 4500**-existent and **not** visible)
- „Ready-to-operate BB controller“ (existent in the controller)
- „Ready-to-operate BB total“ (in the controller)

The message „ready-to-operate total“ is dependent on the three other ready-to-operate messages. Not until the messages „ready-to-operate supply unit“, „ready-to-operate power unit“ and „ready-to-operate BB controller“ are available, the message „ready-to-operate BB total“ is displayed (see figure [Abbildung 16](#) auf Seite 54).

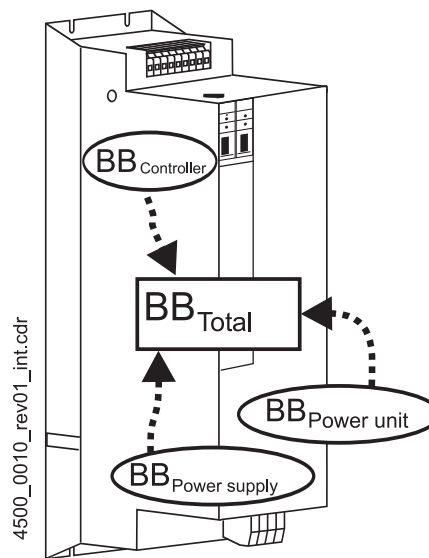

BB: Ready-to-operate

Figure 16: „Ready-to-operate“



NOTE

After applying the +24V-supply voltage and the mains voltage, the device is ready-to-operate BB after approximately five seconds.

„Ready-to-operate BB power unit“ after approx. 0.5 s, „Ready-to-operate BB supply unit“ after approx. 2 s, „Ready-to-operate BB controller“ after approx. 4.5 s

In the following section you will receive further information according the different „Ready-to-operate“ messages.

„Ready-to-operate BB supply unit“ If the „monitoring function supply unit“ does not detect errors, the monitoring function generates the message ready-to-operate BB supply unit“.

- If the message „ready-to-operate BB **supply unit**“ is reset by the monitoring function, the drive is switched to a torque-free status **b maXX 4500**, i. e. the unit does not supply power anymore.

The **b maXX 4500** simultaneously applies the message to relay contacts. Further information is to be found in [►Monitoring functions◄](#) on page 56 and [►Messages via relay contacts◄](#) on page 60.

The „ready-to-operate supply unit“ is also designated „Ready-to-operate internal“ (terminal marking BB int) or „Ready-to-operate BB external“ (terminal marking BB ext).

The differentiation is due to the internal structure of the unit.

At the output of the supply unit the „Ready-to-operate BB supply unit“ is also designated „Ready-to-operate BB internal“. After the message within the unit has been transferred to the power unit, the message „Ready-to-operate BB supply unit“ is designated „Ready-to-operate BB external“.

„Ready-to-operate BB motor-sided power unit“ If the „monitoring function motor-sided power unit“ doesn't locate an error, the monitoring function generates the message „ready-to-operate BB motor-sided power unit“.

If the message „ready-to-operate BB supply unit“ of monitoring function is reset, the **b maXX 4500** changes the drive to torque-free, e. g. the unit doesn't supply power anymore.

„Ready-to-operate BB controller“ In the documentation for the controller, which is used, you will find information, if the message „Ready-to-operate BB controller“ is existent and if so, how to process message „Ready-to-operate BB controller“.

„Ready-to-operate BB total“ In the documentation for the controller, which is used, you will find information, if the message „Ready-to-operate BB total“ is there and if so, how to process message „Ready-to-operate total“.

7.5 Monitoring functions

The following table is listing all of the monitoring functions of the power unit. A declaration of every single monitoring function is to be found on the following pages.

| Monitoring function | | Relay | V-Con-troller | Reset |
|------------------------|---|-------------------------|----------------------|----------------------------------|
| Supply unit | Phase failure | X99AB; 3.4 | F 0110 ¹⁾ | 24 V _{DC} ²⁾ |
| | Power failure | X99AB; 3.4 | F 0110 ¹⁾ | 24 V _{DC} ²⁾ |
| Motor-sided power unit | Overcurrent (motor) e. g. short-circuit | - | F 0202 | Controller ³⁾ |
| | Ground current (motor), e. g. ground fault | - | F 0203 | Controller ³⁾ |
| | Overcurrent | - | F 0201 | Controller ³⁾ |
| | Overtemperature heat sink | - | F 0205 | Controller ³⁾ |
| | Internal auxiliary supply | - | F 0204 | Controller ³⁾ |
| | Safety relay | X 68; 1.2 ⁴⁾ | F 0206 | Controller ^{3) 4)} |

¹⁾ The controller always displays this group error signal if an error appears in the supply unit.

²⁾ Activate reset-input (apply +24V and M24V at X99AB, opto-coupler input).

or

switch off +24V supply voltage.

Thus **all** messages of the supply unit are reset!

Considering the message WARNING, you have the possibility to bring the drive into a defined operational status, before the power unit resets the message „Ready-to-operate BB supply unit“ and turns to a current-free state.

³⁾ The message must be deleted by a reset of the controller.

Display and reset of the message is described in the manual of the controller.

⁴⁾ A message only then appears, if the safety relay is switched off. The safety relay is switched off then, if the +24V-supply voltage for the relay is inexistent.

Before you are able to delete the message by a reset of the controller, you must switch on the +24V supply voltage again.



NOTE

Reset: In case the message is not reset, it is in all probability, that the cause of the error still is existent.

7.5.1 Monitoring functions of the supply unit

- **Monitoring function phase failure**

The voltage of all phase conductors is monitored. If voltage is missing at a phase conductor, this generates **b maXX 4500** the message WARNING. If voltage recovers within ten seconds, the message WARNING automatically is reset. If phase conductor voltage is missing for more than ten seconds, the message WARNING remains and the message „Ready-to-operate BB supply unit“ is reset.



NOTE

If the **b maXX 4500** is operated during phase failure with high motor powers, the input rectifier may be overloaded.

- **Monitoring function mains failure**

The voltage of all phase conductors is monitored. If the mains voltage at two or three phase conductors is missing, immediately the message WARNING is set. If the mains voltage recovers, while the DC link voltage is above 300 V, the DC link voltage is charged anew and the message WARNING is reset.

If the DC link voltage drops below 300 V after mains failure or supply-system voltage dips, the message „Ready-to-operate supply unit“ is reset. If mains voltage recovers again, the circuit of input X99AB-5/6 determines the further behavior:

- Shortly connect (>1ms) 24 V, the DC link is charged again, the message warning is reset and the message ready-to-operate is set again.
- If you have connected input with permanently 24 V, then automatically after recovering of mains the DC link is charged again, the message warning is reset and the message ready-to-operate is set again.

(Precondition for this is that the mains failure time >0 seconds is set. Hereby see „Mains failure time“ in the description of controller).

WARNING

The following **may occur**, if you do not observe this safety information:

- serious personal injury
- death

*The danger is: **mechanical effects.***

execute protection on the motor side, if an automatic restarting of the drive is possible - because of the automatic restart the operating personal is subject to potential injury!



7.5.2 Monitoring functions motor-sided power unit

- **Monitoring function overcurrent (motor)**

Each of the three phase currents of the motor is monitored.

In case of the exceeding of the phase current of 30 % of the peak value of the permissible peak current the **b maXX 4500** generates a message. This message is stored in **b maXX 4500** and is transferred to the controller. This message „Ready-to-operate motor-sided power unit“ is reset.



NOTE

The overcurrent message and the consequential stopping of the drive protects this of damage/destruction. In order to avoid the message „overcurrent (motor)“, you must limit the permissible peak current of the motor phase currents by the control system.

- **Monitoring function ground current (motor)**

The ground fault current of the motor phase current monitored.

A message is generated, if the error current exceeds 20 % of the amplitude of the permissible peak current of the power unit. As a cause of error an ground fault at the motor connection is likely. This message is transferred to the controller. This message „Ready-to-operate motor-sided power unit“ is reset.

- **Monitoring function overcurrent**

The level of the voltage is monitored.

If the DC link voltage reaches 830 V, a message is generated. This message is transferred to the controller. This message „Ready-to-operate motor-sided power unit“ is reset.



NOTE

The voltage can increase until switch-off takes place, if the drive brakes and if there is no or too little chopper power at the DC-link.

- **Monitoring function overtemperature heat sink**

The temperature of the heat sink is monitored.

On the heat sink there is a linear temperature sensor, whose measured value is sent to the controller. Therewith the controller carries the temperature monitoring (for this see description of controller) and this must be set according to the technical data in the description of controller. If the heat sink exceeds the permissible temperature, the message „Ready-to-operate motor-sided power unit“ is reset.

**CAUTION**

The following **may occur**, if you do not observe this safety information:

- damage to property

*The danger is: **temperature of unit too high**. The maximum permissible temperature of the heat sink is 90 °C - if there is a higher temperature the device can be destructed.*

Set the controller in such a way, that the „ready-to-operate BB motor-sided power unit“ is reset by the controller at a temperature of heat sink of 85 - 90 °C.

- **Monitoring function internal auxiliary supply**

The voltage, which is necessary for the controlling of the power transistors is monitored. If the internal auxiliary supply is missing, a message is generated. This message is transferred to the controller. This message „Ready-to-operate BB motor-sided power unit“ is reset.

- **Safety relay** (option)

The output status of the safety relay is monitored.

Further information referring to the safety relay you find in [▶Messages via relay contacts◀](#) on page 60 and in [▶Appendix E - STO \(Safe Torque Off\)◀](#) from page 97.

7.5.3 Messages via relay contacts

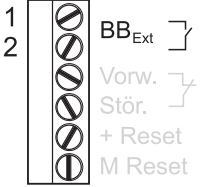
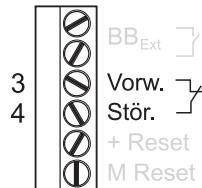
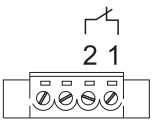
| Plug-in terminal | Description |
|--|---|
|  <p>Figure 17: BB_Ext, X99AB</p> | <p>„Ready-to-operate supply unit“</p> <p>Contact open: The message „ready-to-operate BB supply unit“ isn't present.</p> <p>Contact closed: The message „ready-to-operate BB supply unit“ is present.</p> <p>Further information acc. message „Ready-to-operate BB power unit“ is to be found in ►„Ready-to-operate BB supply unit“◄ on page 55.</p> |
|  <p>Figure 18: Pre-warning/error, X99AB</p> | <p>Pre-warning -error (pre-warning is actually the wrong expression, warning would be correct)</p> <p>Contact closed: The message WARNING isn't present.</p> <p>Contact open: The message WARNING is present.</p> <p>In which case this message is generated, please read in ►Monitoring functions of the supply unit◄ on page 57.</p> |
|  <p>Figure 19: X68</p> | <p>With the safety relay you are able to switch off the supply voltage of the transistor control. After the switching-off the motor is zero-torque, but is isn't isolated from the power module. The motor is not off-circuit!</p> <p>A typical application for the safety relay is:</p> <ul style="list-style-type: none"> ► very quick re-uptake of the operation after switching off <p>This is possible, because the DC link voltage is not switched off.</p> <p>Status signal safety relay</p> <p>Contact closed: +24V-supply for the safety relay is missing. The output stage and accordingly the inverter is inhibited.</p> <p>Contact open: +24V supply for the safety relay is existing. The output stage and accordingly the inverter can be controlled by the controller.</p> <p>If the +24V-supply for the safety relay is taken away, while the drive is running, then the drive is immediately switched zero-torque (this means the device doesn't supply any power anymore), the motor rotates freely back to zero.</p> <p>In order to start the drive again you must follow the following procedure:</p> <ul style="list-style-type: none"> Switch on +24V supply for safety relay Reset existing message by a reset of the controller <p>Also see ►Appendix E - STO (Safe Torque Off)◄ from page 97.</p> |

7.6 Maintenance

Maintenance is first of all the monitoring of the environmental conditions. With accordant projection of your installation you can execute the monitoring of the environmental conditions in the running operation and don't have to interrupt the operation for the maintenance.

Further information is to be found in [►Maintenance◄](#) from page 61.

MAINTENANCE

In this chapter we describe, how you can safely maintain your device.

8.1 Safety instructions

- ▶ Refer to ▶[Fundamental safety instructions](#)◀ from page 9.
- ▶ Refer to the danger areas of the devices.

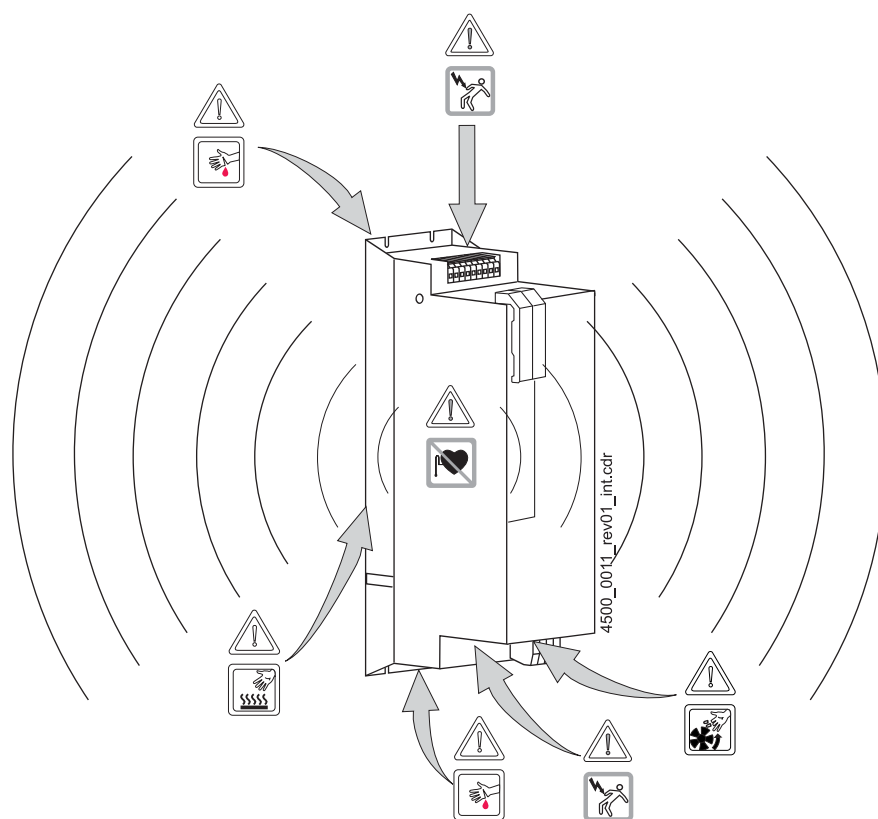

Figure 20: Danger areas

8.2 Environmental conditions

If the prescribed environmental conditions are complied with, the device is maintenance-free. The prescribed environmental conditions are to be found in chapter [►Appendix D - Technical data](#) from page 83. The most important prescribed environmental conditions are:

- Dustless ambient air
- Temperature: min. 5 °C to max. 55 °C
- Relative air humidity: 5 % to 85 %, no condensation
- (Operational-) height: absolute altitude up to 2000 m

8.3 Inspection intervals - maintenance notes

Baumüller Nürnberg GmbH recommends a steady checking of the environmental conditions. Thus you will receive the possibility, to react immediately, in case the actual conditions deviate from the prescribed conditions.



WARNING

The following **can occur**, if you disregard this safety note:

- serious personal injury
- death



*The danger is: **electricity**. The unit carries dangerous voltages and currents, as well as residual charges in the DC-link.*

Assure, that when working in the control cabinet, that all devices in the control cabinet are off-circuit and are safe against re-starting.

Await the discharge of the DC-link, before you install the safety relay. The capacitors which are used in the device are **10 min.** after interruption of the supply voltage automatically discharged so far, that the terminals can be demounted without danger. If you have additional capacitors connected to the DC link, the decharging also can last much longer. In this case you must determine the necessary waiting time yourself and you must determine the deenergization at all terminals of the device (also see [►Dangers due to residual energy](#) on page 20).

- At least once a day check the equipment at the control cabinet, which ensure the required environmental air (e.g. air filters).
- Maintain the air filters according to the indications of the manufacturer.

In the case of polluted environmental air, the required cooling air rate can not be reached anymore, if dirt deposits narrow/block up the ventilation slots. If the devices are dirty, contact Baumüller Nürnberg GmbH, in order to initiate a servicing or send the device to the company for inspection.

**WARNING**

The following **can occur**, if you disregard this safety note:

- serious personal injury
- death



*The danger is: **electricity**. The device can be damaged by incorrect maintenance in such a way, that a safe operating isn't possible anymore.*

Do not maintain the device yourself.

Never remove dirt deposits especially in the inside of the device with sharp objects like screwdrivers or by the usage of e. g. compressed air, steam jet appliances/high pressure cleaners.

REPAIR

In this chapter we describe, where the devices are repaired.

WARNING



The following **can occur**, if you disregard this safety note:

- serious personal injury
- death



*The danger is: **electricity**. After a faulty repair the device doesn't fulfill the safety instructions anymore.*

Have the devices only be repaired by Baumüller Nürnberg GmbH or by authorized servicing.



SHUTDOWN, STORAGE

In this chapter we describe, how you decommission and store the device.

10.1 Safety instructions

- Refer to [►Fundamental safety instructions◄](#) from page 9 and the information in [►Transportation and packing◄](#) from page 23.

The shutdown of the device may only be carried out by for this qualified personnel.



DANGER ()

The following **will occur**, if you do not observe this safety note:

- serious personal injury
- death

*The danger is: **Electricity and electrical charge, which was stored.** Electrical connections, which are not switched current-free, carry dangerous voltage. The modules in the device (e. g. capacitors) may also contain dangerous charges after switching off!*

Assure, when working in the control cabinet, that all electrical connections in the control cabinet are off-circuit and are safe against re-start.

Before working, check at the electrical connections with suitable measuring devices, that the connections are off-circuit.

Remove the connections not until you have verified yourself of the isolation from supply.

The capacitors which are used in the device are **10 min.** after interruption of the supply voltage automatically discharged so far, that the terminals can be demounted without danger. Dependent of the size there are different discharging times. These are to be found from [►D.6 Electrical data - BM454X◄](#) from page 88. If you have additional capacitors connected to the DC link, the decharging also can last much longer. In this case the necessary waiting time must be determined self (also see [►Dangers due to residual energy◄](#) on page 20).

10.2 Requirements to the executing personnel

The personnel, who is appointed to setting out of operation, must have the required knowledge and instructions, which is necessary for an execution according to the rules. Select the personnel in such a way, that the safety instructions, which are mounted to the device and its parts as well as to the terminals, are understood and applied to.

10.3 Put out of operation

Carry out the setting out of operation as follows:

- 1 Put the device off-circuit and assure the device against unintentional re-closing.
- 2 Check the isolation from supply of all connections (earliest 10 minutes after switching off).
- 3 Demount the connections and protect the connections according to the safety instructions.
- 4 Document the setting out of operation.

10.4 Demounting

The demounting assumes a completed, documented setting out of operation.



CAUTION ()

The following **can occur**, if you disregard this safety note:

- minor to medium personal injury.

In case, while mounting, you lift a device with unprotected hands, fingers/palm can be cut. If the device falls off, your feet can be cut up.



wear safety gloves



wear safety shoes

- 1 secure the device against falling off/out.
- 2 enable all mechanical connections
- 3 lift the device out of the control cabinet.
- 4 store the device in a suitable packing.
- 5 at transportation pay attention to, that the device is not damaged by wrong storage or severe shocks, also see [▶To be considered by transportation◀](#) on page 23.

In case you want to dispose the device, you will find in chapter [▶Disposal◀](#) from page 71 further information.

10.5 Storage conditions

The device is maintenance-free. If you keep to the environmental conditions during the entire period of storage, you can assume, that the device will not be damaged. In case the environmental conditions during storage are not kept, you should assume that the device is damaged after storage.



CAUTION

The following **may occur**, if you do not observe this safety information:

- damage to property

*The danger is: **incorrect environmental conditions**. Incorrect storage can damage/destroy the device.*

Assure, that the environmental conditions are kept during the entire period of storage:

- Climatic category 1 K 4
- Temperature range - 25 °C to + 55 °C

*The danger is: **recommissioning without forming of the capacitors**. From six months storage period on, the capacitors are destroyed during commissioning, if they are not formed beforehand.*

- Form the DC link capacitors by supplying the device for at least one hour ready-to-operate with mains voltage, but do not allow a pulse enable.
 - Take into account, that it is imperative, to connect the accordingly specified line commutating reactor. Devices, which do not need a line commutating reactor, can be supplied directly with mains voltage.
-

10.6 Recommissioning

Carry out commissioning as with a new device, see
[►Mounting◄](#) from page 31, [►Installation◄](#) from page 37.

11

DISPOSAL

In this chapter we describe the correct and safe disposal of the devices of the series **b maXX**. During the disposal you will mainly get metal parts (iron- and non-iron metal), electronic scrap and plastics.

NOTE



Baumüller products do not belong to the scope of the EU guideline for the disposal of electrical and electronics devices (WEEE, 2002/96/EG). Therefore, no costs are to be carried by Baumüller for the canceling and disposal of old devices.

11.1 Safety instructions

► Refer to ►[Fundamental safety instructions](#)◄ from page 9.

DANGER



The following **will occur**, if you do not observe this safety note:

- serious personal injury
- death



*The danger is: **electricity**. The containing components in the device (e. g. capacitors) can contain dangerous charges! The capacitors used in the device are after **10 min.** automatically so far discharged, that they can be demounted without danger.*

If you have additional capacitors connected to the, the discharging also can last much longer. In this case you must determine the necessary waiting time self (also see ►[Dangers due to residual energy](#)◄ on page 20).

Demount the capacitors only then, if you have verified yourself of the isolation from supply.



CAUTION

The following **can occur**, if you disregard this safety note:

- minor to medium personal injury.

*The danger is: **sharp edges**.* The components of the device, sheet metal components, heat sinks and so on can have sharp edges!

In case you lift a device during demounting with non-protected hands, your fingers/palms can be cut. If the device falls off, your feet can be cut up.



wear safety gloves



wear safety shoes



WARNING

The following **can occur**, if you disregard this safety note:

- personal injury

*The danger is: **mechanical effects**.* A device of the size 454x weighs 26 kg and can injure you seriously if it falls off.

Assure, that the device cannot fall off, by appropriate actions like supports, cranes, helpers.



CAUTION

The following **may occur**, if you do not observe this safety information:

- Environmental pollution

*The danger is: **incorrect disposal**.*

You may only dispose under consideration of the safety instructions. If necessary, also refer to the local regulations. In case you cannot carry out a secure disposal, contact a certified disposal business.

Dangerous materials may be result or may be set free from a fire.

Do not expose electronic components to high temperatures.

The inner insulation e. g. various power semiconductors hold beryllium oxide. When opened, the beryllium dust is dangerous to your health.

Do not open the electronic components.

11.2 Requirements to the executing personnel

The personnel, whom you instruct to dispose/demount the device must have the knowledge and training to carry out these works properly. The personnel is to be selected in such a way, that the safety instructions on the device and its parts is understood and referred to by the personnel.

11.3 Disposal instructions

- Preconditions**
- The device has already properly been demounted.
 - All technical appliances for demounting are prepared and are in a faultlessly condition.

11.3.1 Modules

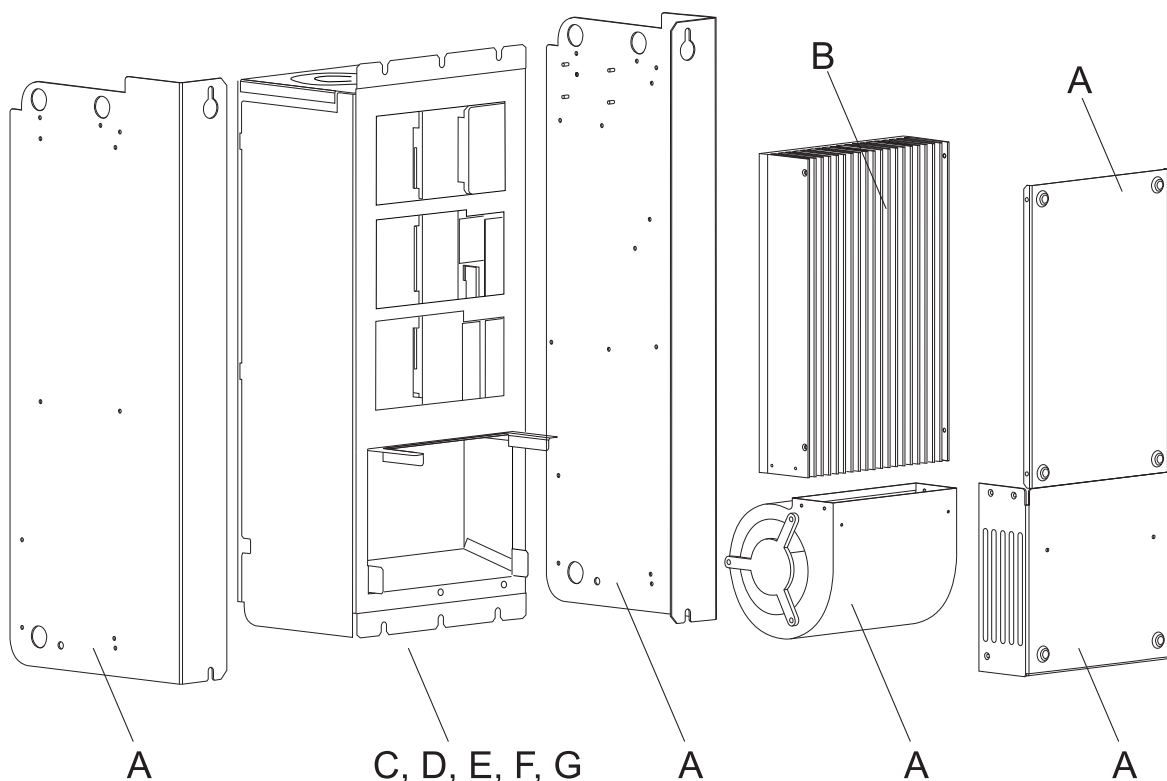

Figure 21: Demounting scheme

The components/modules given in round brackets you will find in the above figure.

- Sheet steel** (A) Sheet steel must be given to the iron metal recycling.
- Aluminum** (B) Aluminum must be given to the non-iron metal recycling.
- Aluminum/copper compound** (C) Aluminum/copper compound must be given to the non-iron metal recycling.
- Plastics** (D) The plastic parts of the housing as well as the plastic covers and further small plastic parts must be given to the plastics recycling.



CAUTION

The following **may occur**, if you do not observe this safety information:

- Environmental pollution

*The danger is: **incorrect disposal.***

Capacitors, semiconductor modules and electronic scrap is to be recycled as special waste.

| | |
|------------------------------|--|
| Capacitors | (E) Capacitors are to be recycled as special waste. Thereby refer to the relevant instructions. |
| Semiconductor modules | (F) Semiconductor modules are to be recycled as special waste. Thereby refer to the relevant instructions. |
| Electronic scrap | (G) The electronic scrap from PCBs, which no further can be demounted, must be recycled as special waste. Thereby refer to the relevant instructions. |

11.4 Recycling plants/offices

Assure, that the disposal is carried out according to your company's regulations and the regulations of the disposal companies and official administrations. In case of doubt, contact the local business administration, which is responsible for your company or the environmental office.



APPENDIX A - ABBREVIATIONS

| | | | |
|---------------|--|--------------------------|--|
| A | Ampere | EXT, ext | external |
| AC | Alternating current | FI | Residual current |
| AIO | Function module analog input/output | FIO | Function module fast digital input output |
| ASCII | American Standard Code for Information Interchange | GL | Synchronous operation |
| BACI | Baumüller drives communication interface | HLG | Ramp function generator |
| BB | Ready-to-operate | HS | Main contactor |
| BBext | Ready-to-operate (external) | HSE | Main contactor on |
| BBint | Ready-to-operate (internal) | HSF | Main contactor enable |
| BCC | Block Check Character | î | Peak current, curve shape not defined |
| BSA | Reference potential analog | I2t | Function module overload monitoring |
| BSD | Reference potential digital | I_{AC} | Effective value, alternating current |
| CAL | CAN Application Layer | I_{Aist} | Armature current actual value |
| CAN | Network for controller ambience | I_{DC} | Effective value, direct current |
| CiA | CAN in Automation | I_{eff} | Effective value, alternating current |
| COB-ID | Identification for CAN object | IF | Impulse enable |
| CPU | Central processing unit | I_F | Field current |
| DC | Direct current | I_{Fmax} | Maximum field current (rated current) |
| DIN | Deutsches Institut für Normung e.V. (German Institute for Standardization) | I_{Fmin} | Minimum field current |
| DIO | Function module digital input/output | I_{Fsoll} | Field current setpoint value |
| DSV | Data set manager | IEE | Function module incremental encoder emulation |
| EDS | Electronic data sheet | ID-no. | Identification number |
| EMF | Electromotive force | Inc | Counting unit of position |
| EMC | Electromagnetic compatibility | Ink | PPR count of incremental encoder |
| EN | European standard | IS | Impulse inhibit |
| ENC | Function module incremental encoder | ISO | International Organization for Standardization |
| ESD | Electrostatic discharge | I_{soll} | Armature current setpoint |
| | | IW | Actual value |

| | | | |
|-------------------------|---|-----------|---------------|
| IWK | Actual value channel | VE | Logic element |
| LT | Power unit | ZK | DC-link |
| M24 | Reference potential 24 V | | |
| MR1 | Torque direction 1 | | |
| MR2 | Torque direction 2 | | |
| n = 0 | Speed = 0 | | |
| n_{ist} | Speed actual value | | |
| n_{max} | Maximum speed | | |
| n_{min} | Minimum speed | | |
| NN | Altitude over sea level | | |
| n_{soll} | Speed setpoint value | | |
| PDO | Process data object | | |
| PE | Protective conductor | | |
| PELV | Protective extra-low voltage with safety separation, earthed | | |
| POS | Positioning | | |
| PSI | Program Storage Interface | | |
| PWM | Function module pulse-width modulation | | |
| PZD | Process data | | |
| R_A | Armature resistance | | |
| RF | Controller enable | | |
| SDO | Service data object | | |
| SELV | Safety extra-low voltage with safety separation | | |
| SIE | Function module SSI encoder emulation | | |
| SM | Synchronous motor | | |
| SR | Safety relay | | |
| SW | Setpoint value, software | | |
| SWG | Setpoint value generator | | |
| SYNC | Synchronization message | | |
| TM | Motor temperature sensor | | |
| U | Voltage | | |
| Ū | Peak voltage | | |
| U_A | Armature voltage | | |
| U_{AC} | Effective value, alternating voltage | | |
| U_{DC} | Effective value, direct-current voltage | | |
| U_{eff} | Effective value, alternating voltage | | |
| U_{ZK} | DC-link voltage | | |
| V | Volt | | |
| VBG | German Administerial Occupation Co-operative | | |
| VDE | Association for Electrical, Electronic & Information Technologies | | |



APPENDIX B - SPARE PARTS AND ACCESSORIES

In this appendix we are listing the spare-/accessory parts for the devices of the series **b maXX**. In case you have questions and suggestions according the accessories, do not hesitate to contact our product management.

B.1 Interface cable



NOTE

Screening of the interface cables, which are used may only be connected to the controller side with the connector housing.

In case the pre-assembled interface cable for **b maXX** is used, the connection of cable screen with the housing of the sub-D-plug must be separated PC-sided.

| Interface | Identification | Length | Item number |
|-------------|--------------------|--------|-------------|
| X1 (RS 232) | Interface cable PC | 3 m | 213 846 |
| X1 (RS 232) | Interface cable PC | 5 m | 213 283 |
| X1 (RS 232) | Interface cable PC | 15 m | 231 086 |

Further lengths on request.

B.2 Plugs

| Part | Part no. | Manufacturer - part no. / type |
|-----------------|-----------------|--|
| Plug for X99 A | 00309454 | Phoenix Contact - MVSTBW 2,5/6-ST |
| Plug for X99 AB | 00309455 | Phoenix Contact - MVSTBR 2,5/6-ST |
| Plug for X68 | 00309482 | Phoenix Contact - MC 1,5/4-STF-3,81-BD:1-4 |



APPENDIX C - DECLARATION OF CONFORMITY

C.1 Declaration of Conformity



EG - Declaration of Conformity

Doc.-No. 5.15004.00
Date: 25-Feb-2015

according to EMC Directive 2004/108/EC and Low Voltage Directive 2006/95/EC

The Manufacturer: Baumüller Nürnberg GmbH
 Ostendstraße 80-90
 90482 Nürnberg, Germany

declares, that the products:

Designation: Power unit b maXX 4500
 Type: BM45XX - XXX - XXXXX[Ryy][XXX] - XX
 Manufactured since: 01-Aug-2015

are developed, designed and manufactured in accordance with the EMC Directive 2004/108/EC and the Low Voltage Directive 2006/95/EC.

Applied harmonised standards:

| Standard | Title |
|--------------------------|--|
| DIN EN 62061:2010-05 | Safety of machinery - Functional safety of safety-related electrical, electronic and programmable electronic control systems |
| DIN EN 61800-5-1:2008-04 | Adjustable speed electrical power drive systems. Part 5-1: Safety requirements. Electrical, thermal and energy |
| DIN EN 61800-5-2:2008-04 | Adjustable speed electrical power drive systems. Part 5-2: Safety requirements. Functional |
| DIN EN 61800-3:2005-07 | Adjustable speed electrical power drive systems. Part 3: EMC requirements and specific test methods |

The products must be installed correctly and all notes and safety notes of the referring instruction handbook must be complied with, to guarantee the compliance to the guidelines.

Nuremberg / 21-Jul-2015
 Location / Date

Subject to change of this declaration of EC conformity without notice. Actual valid edition on request.



EG - Declaration of Conformity
according to Machinery Directive 2006/42/EC

Doc.-No. 5.15004.00
Date: 25-Feb-2015

The Manufacturer: Baumüller Nürnberg GmbH
 Ostendstraße 80-90
 90482 Nürnberg, Germany

declares, that the products:

Designation: Power unit b maXX 4500 with safety relay
 Type: BM45XX-SI1-XXXXXS01
 with controller BUS6-MC-XX-XXXX-XXXX-SIXX-... or BUS6-S1-VC-...

Manufactured since: 01-Aug-2015

are developed, designed and manufactured in accordance with the Machinery Directive 2006/42/EC.
 These products complies with the requirements of the EMC Directive 2004/108/EC and the Low Voltage Directive 2006/95/EC.

Applied harmonised standards:

| Norm | Titel |
|-----------------------------|--|
| EN 62061:2005 | Safety of machinery - Functional safety of safety-related electrical, electronic and programmable electronic control systems |
| EN ISO 13849-1:2008/AC:2009 | Safety of machinery - Safety-related parts of control systems Part 1: General principles for design |
| EN 61800-5-1:2007 | Adjustable speed electrical power drive systems. Part 5-1: Safety requirements. Electrical, thermal and energy |
| EN 61800-5-2:2007 | Adjustable speed electrical power drive systems. Part 5-1: Safety requirements. Functional |
| EN 60204-1:2006/A1:2009 | Safety of machinery. Electrical equipment of machines Part 1:General requirements |
| EN 61800-3:2004 | Adjustable speed electrical power drive systems. Part 3: EMC requirements and specific test methods |
| IEC 61508, part 1-7:2010 | Functional safety of electrical/electronic/programmable electronic safety-related systems |

Authorised person to compile the technical files:

Name: Engelbert Meier, Baumüller Nürnberg GmbH, dept. AES
 Adress: Ostendstraße 80-90, 90482 Nürnberg, Germany

Notified body executed the EC type-examination procedures according to Machinery Directive 2006/42/EC:

Name: TÜV Rheinland Industrie Service GmbH
 Adress: Am Grauen Stein, 51105 Köln / Germany
 Identification number: 0035
 Registration numbers: 01/205/5354.00/13

Attention should be paid to the safety instructions in the instruction handbook.
 This product is to be used in machinery and must not put into operation until the machinery, into with it is incorporated, has been declared to be in conformity with the Machinery Directive 2006/42/EC.

Nuremberg / 21-Jul-2015
 Location / Date

Subject to change of this declaration of EC conformity without notice. Actual valid edition on request.



APPENDIX D - TECHNICAL DATA

In this chapter the detailed technical data of the device series **b maXX 4500** is to be found.

D.1 Requirements on the power supply

D.1 Requirements on the power supply

| | | |
|--|-----------------------------|--|
| Mains | BM45XX - XTX ¹²⁾ | Industrial network with direct or low impedance grounded star point (TN-mains or TT-mains) |
| | BM45XX - XIX | Industrial mains with no neutral point or with a grounded neutral point of high impedance (IT mains) Industrial network with direct or low impedance grounded corner point (grounded delta wye) |
| Inductance (sum of mains inductance and mains choke inductance) | BM454X | min. $u_k = 2,4 \%$ max. $u_k = 4 \%$ |
| Rated mains input voltage/-frequency ^{1) 8)} (U_{AC}) device | | 3 x 400 V 50/60 Hz |
| Absolute minimum supply voltage ^{1) 8)} (U_{AC}) device Absolute maximum supply voltage ^{1) 8)} (U_{AC}) device | | 3 x 300 V / 50/60 Hz 3 x 528 V / 50/60 Hz |
| Absolute minimum frequency ⁹⁾ Absolute maximum frequency ⁹⁾ | | 47 Hz 63 Hz |
| Harmonics (mains voltage) | | $THD_U \leq 12 \%$ ²⁾ |
| Unbalanced mains voltage | | max. 3 % ³⁾ |
| Commutating dip | | Depth of dip < 40 %, area < 250 % x degree ²⁾ |
| Voltage dip | | 10 % up to 80 % ^{11) 1)} |
| Voltage variations/-fluctuations | | +/-10 % ¹⁰⁾ +10 % to -15 % at duration ≤ 1 min ¹⁰⁾ |
| Max. short-circuit current mains ⁷⁾ | | 65000 A |
| Rated mains input voltage -frequency (U_{AC}) Fan ⁶⁾ | BM454X-S/A, | 230 V \pm 10 % 50/60 Hz |
| Control voltage ⁴⁾ (U_{DC}) | | + 24 V -15 % / +20 % ⁵⁾ |

¹⁾ At voltage interruptions ((0.9 - 0) X U_{AC} for $t > 0.1$ sec.) the error „power unit not ready-to-operate“ is generated.

²⁾ EN 61800-3, chapter 5.2.1, class 3

³⁾ EN 61000-2-4, tab. 1, class 3

⁴⁾ The control voltage must accord to PELV (EN 50178, chapter 3.49 and accordingly SELV (EN 50178, chapter 3.70).
At control voltage of < 24 V the fan power output is reduced. It, therefore, may be necessary, to reduce the output currents as well.
in case you consider UL 508 C: limit the current to 4 A with fuses which are in accordance with UL 248 and to a voltage of max. 30 V_{DC} .

⁵⁾ referring to EN61131-2:1994, table 7. Output power of the power supply unit: see „power loss referring to control voltage“ in „electrical data - BM45XX“.

⁶⁾ is only valid for BM454X cooling variants S.

⁷⁾ only necessary in order to comply with UL 508 C.

⁸⁾ The rated voltage is 400 V.
At mains input voltage is below 400 V the output power of the device reduces (see curves).

⁹⁾ Change rate of mains frequency max. 1 Hz/s (EN 61000-2-4, class 3)

¹⁰⁾ EN 61200-2-4, class 3

¹¹⁾ EN 61800-3:2004 and A1:2012

¹²⁾ The connection or the drive of a device with the marking BM45XX-XTX at an IT mains or at a grounded delta wye is not permissible.

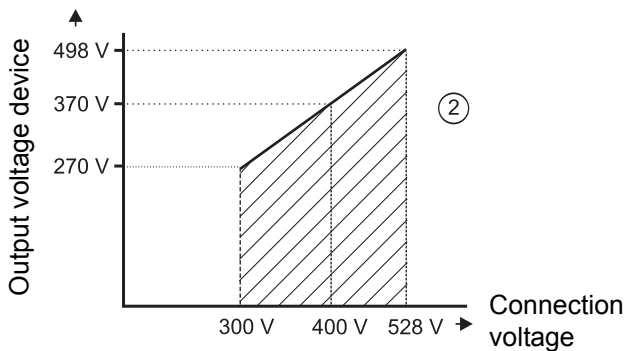

② Curve „output voltage“

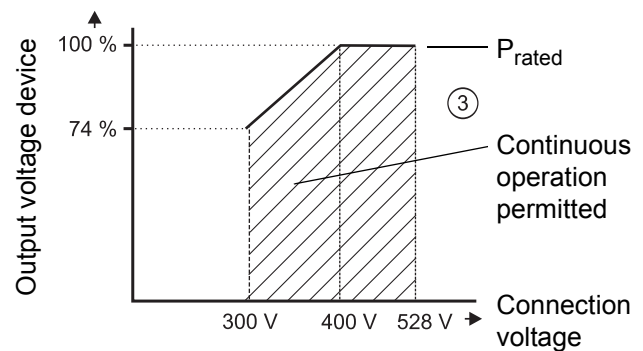

③ If you multiply the output current with the output voltage you will get the output power of the device.

$$S_{Out} = U_{Out} \times I_{Out} \times \sqrt{3}$$

In order to receive the specified curve/area, it is necessary, that output current is reduced between 400 and 528.

The characteristic curves „Output current in dependence of the supply voltage“ you will find in the electrical data of the individual devices from [▶Page 88◀](#).

D.2 Requirements to the motor

The **b maXX 4500** is dimensioned for the operation of three-phase motors with a mains voltage of 3 x 400 V and a rated DC link voltage of ≥ 540 V.

The use of devices is also possible at smaller voltages starting from 3 x 300 V. This, however, presupposes, that the three-phase motors, which are used, are enabled for the operation at inverters with up to 800 V DC link voltage, because the chopper resistor voltage (see [▶D.6 Electrical data - BM454X◀](#) from page 88 ff.) remains. Therewith only three-phase motors with $U_{DC, rated} \geq 540$ V may be used.

D.3 Required environmental conditions

D.3 Required environmental conditions

| | |
|---|---|
| Transportation temperature range | - 25 °C to + 70 °C |
| Transportation climatic category | 2 K 3 ¹⁾ |
| Storage temperature range | - 25 °C to + 55 °C |
| Storage climatic class | 1 K 4 ¹⁾ |
| Operational environment | outside of residential areas ²⁾ |
| Operation temperature range | min. 5 °C to max. 55 °C ³⁾ |
| Operation climatic class | 3 K 3 ¹⁾ |
| Mounting height ⁴⁾ | absolute altitude up to 2000 m |
| Relative humidity (operation) | 5 % to 85 % no condensation ¹⁾ |
| Ionized and non-ionized radiation | < measurable area |
| Vibration, shock and repetitive shock | max 1 g ⁵⁾ |
| Degree of pollution | 2 ⁶⁾ |
| Environmental conditions (EN 60721-3-3) | 3 K 3, 3 B 1, 3 C 3 except salt fog, 3 S 2, 3 M 3 |

¹⁾ EN 50178, table 7

²⁾ At usage in residential areas there are very strict limit values for the electromagnetic emission, which must be complied with. Additional filter measures may become necessary.

³⁾ Rated temperature = 40° C

⁴⁾ Characteristic curve: Power output of the device in dependence with the mounting height at normal pressure

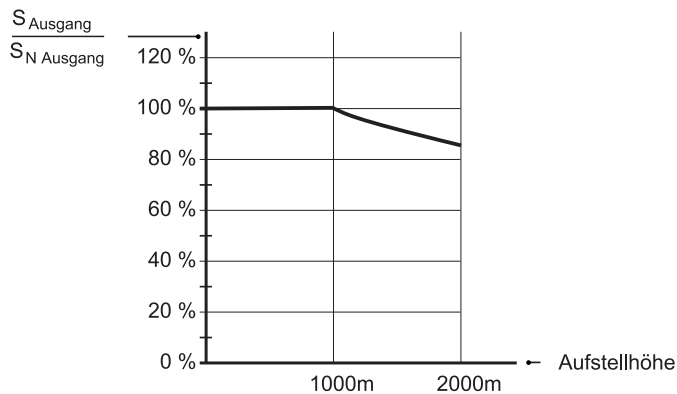

⁵⁾ EN 50178, chapter 9.4.3.2

⁶⁾ EN 50178, table 2

D.4 Cooling

| | |
|---------------------------------------|---------------------------------------|
| Cooling air temperature ¹⁾ | min. 5 °C to max. 55 °C ²⁾ |
| Cooling air requirement ³⁾ | see electrical data |

¹⁾ Air temperature in the entire suction area of the device.

²⁾ Rated temperature = 40° C

³⁾ The cooling air requirement corresponds at least to that of a free-blowing device. Free-blowing means, that the air inlet and the air outlet operates unrestricted. With the mounting of the device into a control cabinet it therefore can be necessary to use additional fans, so that the necessary cooling air requirement is covered. If the necessary cooling air requirement of the power heat sink is not provided, then the output power of the device has to be reduced.

D.5 Non-electrical data

| Device | Dimensions (W x H x D) | Weight with controller, without plug-in modules | Noise development |
|------------------------|---------------------------|--|-----------------------------|
| BM454X ²⁾ : | 190 x 665 x 374 mm | 26.4 kg | max. 80 db(A) ¹⁾ |

¹⁾ 98/37/EG, appendix I, chapter 1.7.4.f, paragraph 8

²⁾ Predetermined are the dimensions for the devices BM45XX-S.

D.6 Electrical data - BM454X

D.6 Electrical data - BM454X

| | | BM4543 | BM4544 | BM4545 |
|---|------------------------|-----------------------|-------------|--|
| Input rated power ¹⁾²⁾ | | 48.5 kVA | 58.2 kVA | 72.7 kVA |
| Input rated current ¹⁾²⁾ (I_{eff}) | | 70.0 A | 84 A | 105 A |
| Distortion factor of the input current ¹⁾²⁾ (THD _I) | | 60 % | 59 % | 45 % |
| Input current, max. ²⁾ (I_{eff}) | | 105 A | 105 A | 133 A |
| DC link rated current ¹⁾ | | 540 V _{DC} | | |
| DC link capacity (internal) | | 1880 μF | 2350 μF | 3055 μF |
| DC link capacity (external), permitted | | max. 20 mF | | |
| DC link discharging time (internal DC link capacity) | | 39 s | 50 s | 64 s |
| Output voltage ¹⁾ (U_{AC}) | | 3 x 0 V to 3 x 370 V | | |
| Output frequency | | 0 Hz to 450 Hz | | |
| Output apparent power ¹⁾ | at 4 kHz ⁴⁾ | max. 53 kVA | max. 66 kVA | max. 86 kVA |
| Output apparent power ¹⁾ | at 8 kHz ⁴⁾ | max. 49 kVA | max. 47 kVA | max. 62 kVA |
| Motor power, typical ¹⁾ | at 4 kHz ⁴⁾ | max. 36 kW | max. 45 kW | max. 58 kW |
| Motor power, typical ¹⁾ | at 8 kHz ⁴⁾ | max. 34 kW | max. 32 kW | max. 42 kW |
| Output rated current ¹⁾⁵⁾⁶⁾⁷⁾ (I_{AC}) | at 4 kHz ⁴⁾ | max. 80 A | max. 100 A | max. 130 A |
| Output rated current ¹⁾⁵⁾⁶⁾⁷⁾ (I_{AC}) | at 8 kHz ⁴⁾ | max. 75 A | max. 72 A | max. 94 A |
| Output peak current ¹⁾⁵⁾⁶⁾⁸⁾ (I_{AC}) | at 4 kHz ⁴⁾ | max. 120 A | max. 130 A | max. 170 A |
| Output peak current ¹⁾⁵⁾⁶⁾⁸⁾ (I_{AC}) | at 8 kHz ⁴⁾ | max. 90 A | max. 94 A | max. 130 A |
| Max. peak current time ⁸⁾⁹⁾ | | 60 s (150 s *) | | |
| Input power DC link terminals | | max. 58 kW | | |
| Chopper current, permissible (\hat{I}) | | max. 67 A | max. 100 A | max. 100 A |
| Ballastwiderstand extern | | ≥ 12 Ω | ≥ 8 Ω | ≥ 8 Ω |
| Chopper start-up voltage (\hat{U}) ¹²⁾ | | 780 V | | |
| Chopper peak power | | 53 kW | 80 kW | 80 kW |
| Permissible chopper continuous power | | 36 kW | 45 kW | 58 kW |
| Power loss referring to mains voltage | | 1080 W | 1350 W | 1740 W |
| Power loss referring to control voltage | | max. 75 W | | |
| Power loss of equipment fan according to 230 V _{AC} ¹¹⁾ | | 87 W | | |
| Cooling air requirement of power heat sink | | 260 m ³ /h | | 260 / 210 m ³ /h ¹⁰⁾ |
| Cooling air requirement of the interior space of device | | 60 m ³ /h | | |

* At printing unit application, where a continuous machine standstill with converter maximum current doesn't occur, the converter maximum current can be used for 150 s, in order to accelerate the machine from standstill to its operating speed (except power units with controller BUS 6 V). Precondition for this is the utilization of the complete overload time of 150 s, is an initial condition of the converter, especially of the heat sinks, there is no higher temperature than 40 °C. Otherwise, during the overload time the permitted maximum temperature would be exceeded and the converter would switch off with an error message.

- 1) All rated values refer to a mains input voltage of 400 V/50 Hz and a control voltage of 24 V.
- 2) In case you use the following commutation chokes at a mains with $u_{K,mains}=0.4\%$:
BM4543 Item no. 00368380, BM4544: Item no. 00368381, BM4545: Item no. 00368381.
- 3) The output voltage is a pulsed d.c. voltage. The operating range refers to the effective value of the fundamental wave.
- 4) Switching frequency of the inverter (adjustable).
- 5) Effective value at an environmental temperature of 40 °C.
- 6) At rated input supply voltage the device enables the rated-/maximum output currents. At input voltages above the rated supply voltage the output currents at constantly output power have to be accordingly reduced.



Abbildung 22: Derating curves BM4543, BM4544



Abbildung 23: Derating curves BM4545

- 7) Between 40° C and 55° C the output current must be reduced.
The acceptable output current (I_0) is calculated with the following formula:

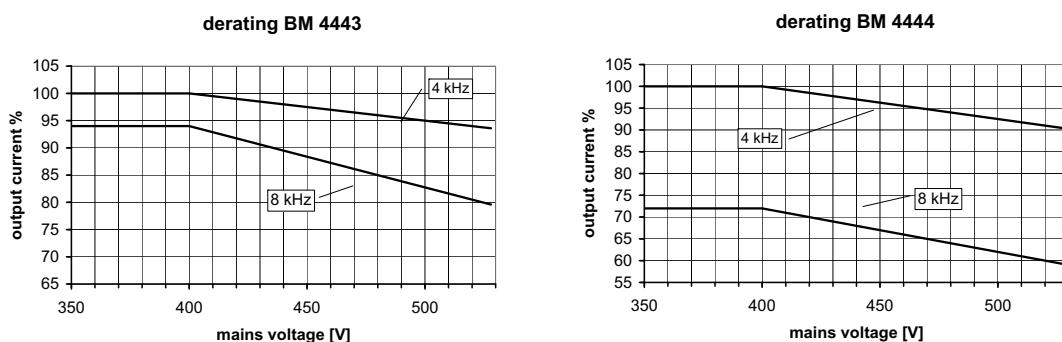
$$I_0 = I_0 \cdot \left(1 - \left(\frac{\text{coolant temperature} - 40^\circ\text{C}}{^\circ\text{C}} \cdot 0,03 \right) \right)$$

- 8) This overload time is dependent on the motor current and of the heat sink temperature and is determined by the Ixt-monitoring of the device.
- 9) The peak current can only be supplied at a heat sink temperature of <75 °C (BM4543) or <80 °C (BM4544).
If these heat sink temperature thresholds are exceeded the output current is automatically reduced to the rated current.
- 10) The cooling air requirement is at the BM4545-S 260 m³/h.
- 11) Is only valid for cooling variant S.
- 12) Also refer to [D.2 Requirements to the motor](#) on page 85.

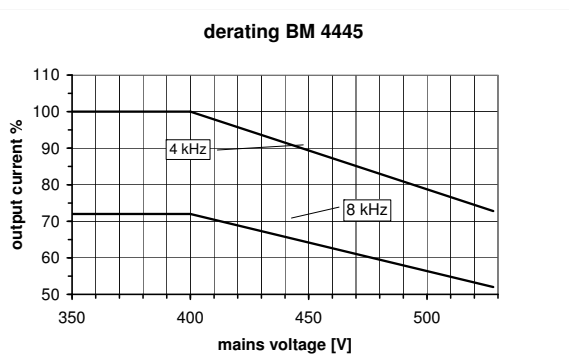
D.7 Fuse protection

We differ between the protection of the power cable and the protection of the device. In order to fulfill the CE specifications - here especially EN60204-1 - you have to protect the power cables.

Cable protection

Place in safety fuses of the operation class gL DIN VDE 0636-201 / IEC 60269-2-1 / HD 630.2.1 54 or cable protection switches with the triggering characteristic K referring to DIN VDE 0636-201 / IEC 60204-1 60269-2-1 / HD 630.2.1 54, to protect the cables. These fuses protect against overloading and from consequential damages from faults e. g. by fire. You cannot prevent, that the device is extensively destroyed, if a short circuit or an ground fault occurs in the DC link.

Carry out the protection according to EN 60204-1 („Electrical equipment of machines“). Dimension the cable protection fuses, dependent on the used cross section according to the, at the time, valid, national standards and local regulations.

Device protection

Place in semiconductor fuses with the triggering characteristic aR DIN VDE 0636-201 / IEC 60269-2-1 HD 630.2.1 54. Switch these in series to the cable protection fuses. These protect the input-sided rectifier-triggering, in case of a short circuit, against completely destruction, so that a repair of the device is possible.

Dimension the suitable device protection fuses, dependent on the peak current and the under [►Device protection◄](#) on page 91 required limit load integral i^2t_{OFF} .

Cable protection + device protection

You have two possibilities to protect the cable and the device:

- connect fuses and semiconductors in series
- use whole range fuses with trigger characteristic gR (DIN VDE 0636-201/IEC 60269-2-1/HD 630.2.154)

Dimension the suitable cable and device protection fuses dependent on the used cross section of the used mains line, from the peak current and the under [►Device protection◄](#) on page 91 demanded limit load integral i^2t_{OFF} .

D.7.1 Cable protection

The current-carrying capacity of conductors is determined in table 5 of EN60204-1. For your operation you must determine the accordant value in the standard yourself, by taking into consideration, amongst other things the cable mounting. Here you will find an extraction for the laying of PVC- isolated cables on open cable racks:

| Cable cross section | Fuse rated current |
|---------------------|--------------------|
| 1.5 mm ² | 16.1 A |
| 2.5 mm ² | 22 A |
| 4 mm ² | 30 A |
| 6 mm ² | 37 A |
| 10 mm ² | 52 A |
| 16 mm ² | 70 A |

| Cable cross section | Fuse rated current |
|---|--------------------|
| 25 mm ² | 88 A |
| 35 mm ² | 114 A |
| 50 mm ² | 123 A |
| 70 mm ² | 155 A |
| 95 mm ² | 192 A |
| 120 mm ² | 221 A |
| 150 mm ² / 185 mm ² | 355 A |

Use suitable fuses with the enable characteristic gL or gR.

D.7.2 Device protection



| Device | Maximum load value ¹⁾ | I ² t value ¹⁾ , In case you consider UL 508 C |
|---------|----------------------------------|---|
| BM454X: | ≤ 15,000 A ² s | ≤ 15,000 A ² s |

¹⁾ Use fuses, which **under-run in the operating point** of the BM4500-device the stated tripping integral ($i^2 t_{off}$).

D.7.3 Cable protection + device protection

Consider by your choice of the whole range fuses the current-carrying capacity of the, to the device connected mains cables and the allowable maximum load of the device.



















D.7.4 Full-range fuses gR, gRL, gR/gS, gGR (device and cable) BM454X, type NH

| | | | |
|----------------|-----|---|---|
| Bussmann | 00 | 80A/690V: 170M2699 | 100A/690V: 170M2700 |
| | | 125A/690V: 170M2701 ¹⁾ | |
| | 1 | 80A/690V: 170M4178 | 100A/690V: 170M4179 |
| | | 125A/690V: 170M4180 | |
| Ferraz Shawmut | 000 | 80A/690V: 6.9 GGR 000 PV 080/ 6,9 GGR 000 D08L 080 | |
| | 00 | 80A/690V: 6.9 GGR 00 PV 080/ 6,9 GGR 00 D08L 080 | |
| SIBA | 1 | 80A/690V: 2021120-80A | 100A/690V: 2021120-100A |
| | | 80A/690V: 2021134-80A  US | 100A/690V: 2021134-100A  US ¹⁾ |
| Siemens | 000 | 80A/690V: 3NE1 820-0  US | |

Size _____ ▲

¹⁾ For the connection of an additional DC link capacity or the parallel operation of up to five devices suitable, that means the DC link of several devices is connected with at the same time existent mains connection of every device.

D.7.5 Semiconductors aR (device) BM454X, type NH

| | | | |
|----------|-----|---|--|
| Bussmann | 000 | 80A/690V: 170M1566 c  | 100A/690V: 170M1567 c  |
| | | 125A/690V: 170M1568 c  | |
| | 00 | 80A/1000V: 170M2680 | 100A/1000V: 170M2681 |
| | | 125A/1000V: 170M2682 | |
| | 1 | 80A/690V: 170M3811 c  | 100A/690V: 170M3812 c  |
| | | 125A/690V: 170M3813 c  | |
| SIBA | 1 | 125A/690V: 2021120/125A ¹⁾ | |
| | | 125A/690V: 2021134/125A c  | |
| Siemens | 000 | 80A/690V: 3NE8 720-1 c  | 100A/690V: 3NE8 721-1 c  |
| | | 125A/690V: 3NE8 722-1 c  | |
| | 00 | 80A/690V: 3NE8 020-1 c  | 100A/690V: 3NE8 021-1 c  |
| | | 125A/690V: 3NE8 022-1 c  | |
| | 0 | 80A/1000V: 3NE4 120 c  | 100A/1000V: 3NE4 121 c  |
| | | 125A/1000V: 3NE4 122 c  | |
| | 1 | 100A/1000V: 3NE3 221 c  | 125A/1000V: 3NE3 222 c  |

Size _____ ↑

¹⁾ For the connection of an additional DC link capacity or the parallel operation of up to five devices suitable, that means the DC link of several devices is connected with at the same time existent mains connection of every device.

D.8 24V extra-low voltage protection

In case you refer to UL 508 C: assure, that all connections at the device have an maximum voltage of 30 V. Additionally these terminals must be protected with fuses which are in accordance with UL 248 with a triggering current of maximum 4 A.

D.9 Cable mains - device

| Device | Cross section ¹⁾ | Maximum length ²⁾ | Connection to device ³⁾ |
|--------|--|--|---|
| BM454X | 4 x 16 to 50 mm ² (AWG 6 -0) | Mains to mains filter: user-defined Mains filter to mains choke/ device: max. 30 cm | With/without wire end ferrule (screw terminal) |

¹⁾ Possible cross section

For UL conform machines/installations you must use UL certified circuit cables.

²⁾ The length of the cable between mains filter and mains is not of importance for the compliance to the EMC regulation.

³⁾ The installing of the cables is user-defined.

D.10 Cable device-motor

| Device | Cross section ¹⁾ | Maximum length ²⁾³⁾ | Connection to device |
|--------|--|--|---|
| BM454X | 4 x (16 to 50 mm ²) (AWG 6 - 0) | dependent on the used cross section: 4 x 1.5 to 2,5 mm ² (AWG 16 -12): 100m 4 x 4 to 25 mm ² (AWG 10 -3): 60m 4 x 35 mm ² (AWG 1): 50m ≥ 4 x 50 mm ² (AWG 1/0): 15m | flexible cable with/without wire end ferrule (screw terminal) |

¹⁾ Possible cross section

Use a screened circuit Baumüller-line, optical shield coverage > 85%. Do not use single conductors.

For UL conform machines/installations you must use UL certified circuit cables.

²⁾ Only for Baumüller cables with this maximum length and by usage of a Baumüller mains filter you can assume, that the limit values of the EMC product standard EN 61800-3 are complied with.

³⁾ In case you use parallel-installed motor cables, the maximum length is to be reduced by the factor 1/n.

D.11 Cable control voltage supply/signals

| | |
|------------------------------|--|
| Cross section ¹⁾ | ≤ 1.5 mm ² |
| maximum length ²⁾ | user-defined |
| Connection to device | with /without wire end ferrules (plug-in terminal) |

¹⁾ The installing of the cables is user-defined.

²⁾ The length of the cable has no influence on the compliance to the EMC regulation.

D.12 Type of protection

| | |
|--------------------|---|
| Type of protection | IP 10 (IP 20, if safe-to-touch connection according IP 20 is ensured) |
|--------------------|---|

D.13 Fire fighting appliances

| | |
|-----------------|------------|
| Fight fire with | ABC-Pulver |
|-----------------|------------|

D.14 Mains filter

In order to comply with the required limit values of the EMC product standard a mains filter is necessary for each device.

Insert in proportion of the application a mains filter from the following table.

TN-mains

| $I_{Nom AC}^{1)}$ | Type | Part number |
|-------------------|---------------------|-------------|
| 100 A | BFN 3-1 - 100 - 001 | 314283 |
| 130 A | BFN 3-1 - 130 - 001 | 314284 |
| 180 A | BFN 3-1 - 180 - 001 | 314285 |
| 250 A | BFN 3-1 - 250 - 001 | 373891 |

¹⁾ Rated temperature = 40° C

IT-mains

| $I_{Nom AC}^{1)}$ | Type | Part number |
|-------------------|---------------------|-------------|
| 250 A | BFN 3-1 - 250 - 002 | 373620 |

¹⁾ Rated temperature = 40° C

D.15 Mains chokes

Current

Choose the mains chokes in dependent on their application on the basis of the input rated current. Take into account, that the maximum input current may not saturate the choke.

Inductance

Furthermore, chose the mains chokes dependent on the short circuit voltage of the mains, so that the demanded mains inductance, under [►Requirements on the power supply◄](#) on page 84, is complied with.



NOTE

At 60 Hz there is another short circuit voltage with the same choke like at the 50 Hz; with the formula $u_k = (\omega L \times I_N \times \sqrt{3}) / U_N$ (with $\omega = 2\pi \times f$) you can calculate the resulting impedance voltage at another mains frequency.

| $I_{\text{Nom AC}}$ | Inductance | Type designation | Item number |
|---------------------|------------|-------------------|-------------|
| 115 A | 0.26 mH | BK3-0115/0140-001 | 368381 |
| 164 A | 0.18 mH | BK3-0165/0200-001 | 368382 |
| 197 A | 0.15 mH | BK3-0195/0240-001 | 368383 |

The listed chokes are specified for the operation at 400 V / 50 Hz or 480 V / 60 Hz. Die chokes have, at a mains voltage of 400 V and a frequency of 50 Hz at rated current a short circuit voltage of 4 % of the mains voltage.



APPENDIX E - STO (SAFE TORQUE OFF)

E.1 General: Methods to avoid an unexpected starting

In order to avoid danger for persons, for example operators, service- and maintenance technicians, the machine has to be kept in a secure condition (safe stop), while interfering in the dangerous area of the machine. This is why a reliable prevention of an unexpected starting is demanded (amongst other things Machine directive 98/37/EG and 2006/42/EG, appendix I, 1.2.4; EN ISO 12100-1). Under unexpected starting every starting is to be understood, that can cause a risk, when appearing unexpected for persons (EN 292-1). Moreover, besides the transition of the enabling to the operating status of the machine, also the unexpected moving of the machine, that means the transition from the safe stop into an unsafe moving has to be considered. This is necessary, because the unexpected moving usually is to be led back to an interruption of the control loop of the machine. In this case the drive is, because of its control system, anxious to achieve highest speed at maximum acceleration. If an unexpected starting occurs, the operator therefore doesn't have the possibility to remove himself or his hand from the danger area anymore. This is why the drive has to be stopped and has to be kept safe in its 'off-position', when having opened, electrical interlocked safety devices. The motor may not be able to generate torque and thus is not able to generate a dangerous movement.

The prevention of an unexpected starting of the machine can be reached by electrical separated safety devices, e.g. contactors. By some machine types it has to be done without the isolation of the electrical connection of the drive to the mains, if e. g. a drive supplied by a power converter is often stopped and started again. The constant dis- and re-charging of the represents a big stress for the concerned parts and often leads to disturbing delays and failures of these parts.

The precondition of starting an three-phase motor is the generation of a rotating field, which drives the inductor of the motor. When having variable-speed three-phase drives, usually in the micro-processors a complex pulse pattern is generated, then the pulses are amplified and are used for the switching of the power semiconductors. If either no defined pulse pattern is available or the amplifying connection is interrupted, e. g. by switching off of the power supply with a relay (safety relay), no rotary field can be generated. An error at the pulse pattern generating therefore cannot lead to a starting of the motor, as long as the second precondition, namely the interruption of the amplifying power supply is available and contrary. The protection against unexpected starting is reached by an electromechanical method which is superior to the electronics. It is reached by a safe isolation - elsewhere than in the load circuit.

The power supply to the windings of the motor is reached at a stoppage by inhibiting the power semiconductor. The behavior of the drive, which has been shut down, has to be considered if such an error scenario arises, because semiconductors possibly can fail or be started, because

of electromagnetic interferences. The fail or „accidental“ starting of a single or of several power semiconductors at the same DC link pole does not lead to an uncontrollable starting, as no current flow is accomplished. Not until additionally a further power semiconductor is interconnected at another DC link pole, current is able to flow through the motor. If, thereby the is directly short-circuited, the fuses which are upstreamed to the converter are tripped, the motor doesn't start. If the is „short-circuited“ over a winding of the motor, a magnetic field can be set up in the motor. If it is an asynchronous motor, then the generated d. c. magnetic properties cannot cause a lurch of the inductor. By the permanent-magnetic synchronous motor the inductor will rotate into a notch position. The therewith angular movement which is covered is dependable of the inductor's position and the number of pole pairs of the motor. It amounts to maximum $180^\circ/\text{number of pole pairs}$. Subsequently the enabled DC link operates like a brake, this means after the ending of the lurching movement the drive is in a blocked status. A starting of the drive is impossible. If a machine with a synchronous motor is planned, the possible sudden movement must be considered, because it can lead to a dangerous movement. Therefore the machinist must carry out a safety evaluation for this movement.



NOTE

At total failure of an internal driver (IGBT) or an control element, it can trigger a temporary excitement of the drive (also in the STO state).

If the link to a winding of the motor is „short-circuited“, a magnetic field develops in the motor. If this is an asynchronous motor, the generated DC field cannot effect a jolt of the rotor.

The rotor in a permanently energized synchronous motor will rotate into a notch position. The angular movement depends on the rotor position and the number of pole pairs of the motor. It amounts to a maximum of $180^\circ/\text{number of pole pairs}$.

The potential jolting movement must be considered, if a machine with a synchronous motor is developed.



NOTE

The function is limited to the prevention of an unexpected starting. The switching of the safety relay, while the choke of the motor is rotating, causes an uncontrolled coasting of the machine. Braking with the converter is not possible.

**WARNING**

The following **may occur**, if you do not observe this warning information:

- serious personal injury
- death



*The hazard is: **electricity**. Power supply voltage can be present at the motor and at the device, if STO / Safe stop function is active.*

De-energize the device, as it would be done with a device without safety relay. The device and the motor is **not** de-energized by the safety relay!

**NOTE**

There is no isolation from the supply system if the function STO/Safe stop is activated. There can be potential at the converter and at the motor. In the case of maintenance-, service- and repair- works on electrical components of the drive system, protection against dangers must be provided by other means (e. g. main switch).

E.2 Safety categories according to EN ISO 13849-1

Dependent on the possible dangers (these are rated due to the consideration of the severity of injuries, the frequency of the length of stay within the danger area and possibilities in order to prevent dangers) security relevant components of machines have to meet certain safety criteria. The requirements to safety-based parts are divided into five categories in the standard EN 954-1.

In category B basic demands, in 1 additionally safety-technical checked components and principles are claimed. In category 2 an error between inspection intervals can lead to a loss of the safety function.

Category 3 accords to the level “the single-error-certainty to recognize errors partially”. The safety-relevant components must be in such a way, that a single error doesn't lead to a loss of the safety function, whereat not the complete possible errors can be self-contained recognized by the system. Therefore an accumulation of unrecognized errors can lead to a loss of the safety function.

Category 4 accords to the level “self-monitoring”. This component recognizes self-contained possible errors and signals these in time of the loss of the safety function. Also if up to three from one another independent errors arise the safety function is always maintained.

E.3 The safety relay

The function of the safety relay is executed in fail-safe-technic, also named closed-circuit principle. The safety function “safe stop” is active, as long as no voltage is applied to the input terminals (X68: 3.4). Consequently the functioning of the safety function is guaranteed if power failure operates. In order to deactivate “safe stop” a voltage of 24 V must be applied to the terminal, which is concerned (X68:3.4).

In order to externally monitor the safety relay you can check its present switch at its positively driven status signal contacts (X68: 1.2). If, at the safety relay (X68: 3.4) there isn't voltage (during the „safe stop“), then the status signal contacts are closed (NC contact). Also a cable break can thusly be recognized as an error.

If the voltage at the input terminals of the relay (X68: 3.4) is switched off, the converter generates one or two error messages (F0204 and/or F0206), which it displays at the V-controller. The drive can be taken into operation again, not until these messages have been reset after a new switching on of the safety relay with a reset signal from controller (e. g. via X26, pin programmable or via the interface to a bus system).

Applications, which require a risk reduction according to category 3, performance-level d or SIL2, must have a second independent shutdown path. The safety relay presents a shutdown path only. The connection diagram and the requirements and the notes according to [▶E.7 Classification of safety and instructions◀](#) on page 106 must be considered in order to execute a two-channel shutdown.

The switch-on and switch-off sequence of the enable signals as well as of the safety relay must be considered in order to assure an operation of the drive without trouble.

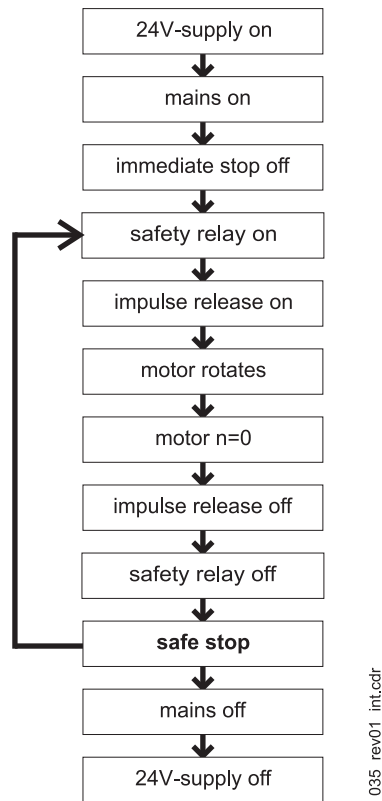

Figure 24: Sequence diagram of safety relay

Baumüller devices, which are designed with a safety relay (optional), comply with the requirements of category 3 (EN ISO 13849-1) for the safety-relevant application “protection against unexpected starting”, if the configuring and installation instructions are complied with.

Before the commissioning of the machine, in which the converter with the safety relay is built in, the safety function “protection against unexpected starting” must be checked. Therefore a safety device (e. g. door contact) must be enabled. The motor must now be zero-torque.

NOTE



A device with safety relay, whose part number does **not** start with „06“, does not apply as a safety device as defined by the PL classification according to ISO 13849 or SIL according to EN 61800.

This device is not certificated for safety functions

E.4 Application example for machine of category 3 according to EN ISO 13849-1

Exemplary the following diagram shows the usage and cabling of machine tool, at which the safe taking of work pieces at opened cover is possible according to category 3 (EN ISO 13849-1).

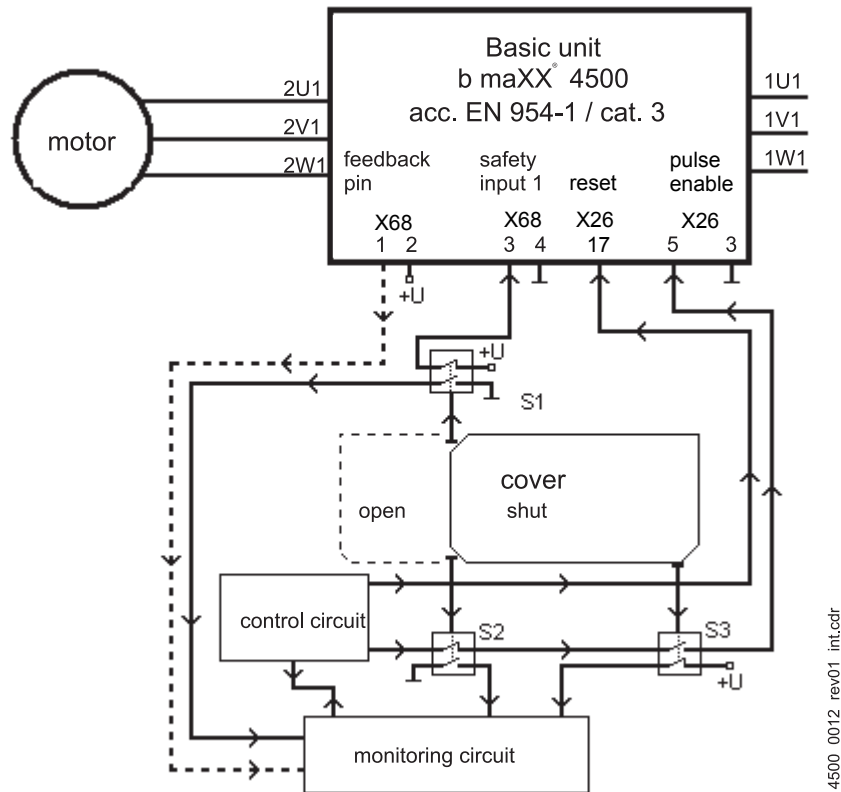

Figure 25: Application example for safe stop according to category 3 (EN ISO 13849-1)

The switching-off of the electrical drive motor operates on two channels.

- S2 (NC contact) and S3 (NO contact) has hardware effects on the pulse enable input of the converter (X26:14). Only if S2 and S3 display a closed cover (and therewith a safe status) voltage is being applied to the pulse enable input of the converter.
- S1 (NC contact) has hardware effects on the safety relay of the converter. Only if S1 shows a closed cover (and therewith a safe status) there is voltage at the safety relay input (X68: 3) and therewith a torque is possible to be generated at the shaft of the motor. The NO contact of S1 is connected with the monitoring circuit.
- The monitoring circuit, a fail-safe monitoring control of the category 3 (EN ISO 13849-1), checks on its own the directly connected switching contacts of the position switch S1 (NO contact), S2 (NO contact) and S3 (NC contact). If the cover is not completely closed or if there is a theoretical impossible status of the position switch contacts (e. g. S1 and S2 show a different switching status or S2 and S3 show the same switching status), then the control circuit will not receive an enable signal from the monitoring circuit. A missing enable signal of the monitoring equipment leads to an immediate switch-off of the converter by means of the control circuit. If the monitoring circuit has recognized an error (e. g. different switching status of S1 and S2), this will be displayed to the operator and commissioning of the drive is possible not until the error has been repaired.
- The status signal contact of the safety relay (X68: 1.2; NC contact) additionally can be evaluated from the monitoring circuit (but is not imperative).
- The position switches, which are used, must unavoidable have actuated and mechanical connected contacts as well as a connection on two channels (NC contact/ NO contact combination). The mechanical operating at the safety device must take place unavoidable, that means tamper-proof.

The connection cables between the safety relay input (X68: 3.4) and the control as well as between the pulse enable input at the controller (X26) and the control may not be run together, outside the switching cabinet in one cable channel.

- S1 (NC contact) has hardware effects on the safety relay of the converter. Only if S1 displays a closed cover (and therewith a safe status) there is voltage at the safety relay input (X68: 3) and therewith makes a generation of torque at the shaft of the motor possible. The NO contact of S1 is connected with the monitoring circuit.
- S3 (NO contact) has hardware effects on the pulse enable input of the converter (X26: 14). Only if S3 displays a closed barrier (and therewith a safe status) voltage is applied to the pulse enable input of the converter.
- The monitoring circuit, a fail-safe monitoring control of category 4 (EN ISO 13849-1), checks on its own the directly connected switch contacts of the position switches S1 (NO contact), S2 (NO contact), S3 (NC contact) and the status signal contact of the safety relay (X68: 1.2 NC contact) as well as the contactor K1 (NO contact). If the barrier is not completely closed or if there is a theoretically impossible status of the limit switch contacts (e. g. S1 and S2 show a different switch status or S2 and S3 show the same switch status or the status signal contact of the safety relay is opened/closed, although the status signal contact of S1 is closed/opened), then the control circuit does not receive an enable signal of the monitoring circuit. A missing enable signal of the monitoring device leads to a direct switching off of the converter by means of the control circuit. If the monitoring circuit has recognized an error (e. g. different switch status of S1 and S2), this is displayed to the operator and the commissioning of the drive is not possible until the error has been repaired.
- The position switches, which are used, must unavoidable have actuated and mechanical connected contacts as well as a connection on two channels (NC contact/ NO contact combination). The mechanical operating at the safety device must take place unavoidable, that means tamper-proof.

The connection cables between the contactor K1 and the control circuit as well as between the safety relay input at the converter (X68: 3.4) and the control circuit may not be run together outside the switching cabinet in one cable channel.



NOTE

All information given in the manual for the converter, especially the chapters safety instruction, installation and commissioning, must absolutely be observed.

For the use and the installation of the safety devices the relevant legal and official requirements of the Safety Authorities and of the EU-Directives for safety regulations at installations and machines (for example EN 60204-1, safety of machines, electrical equipment and EN 292-2, safety of machinery - general configuration guidelines).

E.6 Operating lifetime

The mechanical life expectancy of the safety relay is at least 1×10^7 cycles of operation.

E.7 Classification of safety and instructions

according to DIN EN ISO 13849-1 and EN 62061

In connection with the controller M-Drive (model SI) the converter BM454X (model S01) consists of the safety function STO (Safe Torque Off).

The drive is switched off torque with this function STO.

The drive stops after running out (coasting) provided that there is no load at the drive mode. For this reason there is no danger provided that the STO function was selected. A starting of the drive without the reset of the STO function is not possible.



NOTE

A device with safety relay, whose part number does **not** start with „06“, does not apply as a safety device as defined by the PL classification according to ISO 13849 or SIL according to EN 61800.

This device is not certificated for safety functions



NOTE

Only a device which is affixed with the test mark of the TÜEV Rheinland has a certificated safety function.



The STO function fulfills the following safety classification and standards:

- PL-d according to DIN EN ISO 13849-1 with the following parameters:
 - Structure: Cat 3
 - MTTFd: high
 - DC: low
- SIL 2 according to EN 62061 and 61508 with $PFH_{DSSD} = 4,38 \times 10^{-10}$

Further notes referring to the function STO: EN 61800 part 5.2

Functional principle:

The converter series BM454X (M-Drive and V-controller) has two different shutdown methods, which switch off the commutation in the power unit.

Both shutdown methods are shown in the following image:

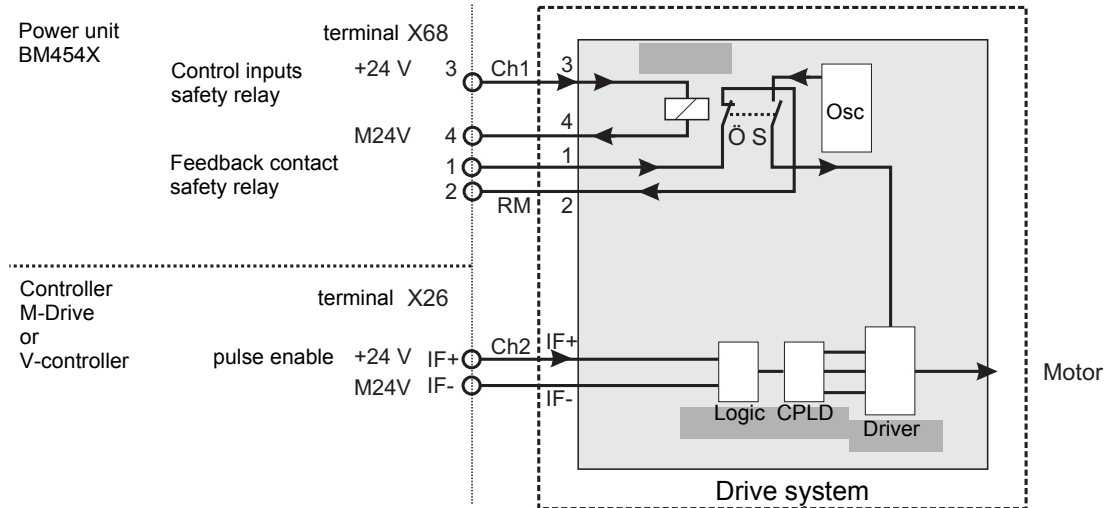

Figure 27: Shutdown methods for converter series BM454X

The first shutdown method is made by interrupting the driver supply for the motor control by a restraint-guided relay.

The drive can only be moved if the relay is current carrying (control inputs X68:3 and X68:4).

The state of the relay contact can be made with a sampling via the restraint-guided NC (signal outputs X68:1 and X68:2).

The second shutdown method is made over the M-Drive or the V-controller (pulse enable at the controller inputs X26: IF+ and IF-) in order to reach a quick shutdown and is controlled via a semiconductor chain. The driver generates the necessary signals for the driver only if the inputs IF+ and IF- are supplied with current.



NOTE

The safety classifications are valid, if the following safety notes were considered and were complied with.

- The classification of the safety category applies only to the STO function.
 - The following switching measures must be met to achieve the safety function:
 - Two-channel connection of the shutdown
 - Control of the positively driven NC contact.
 - Using an external circuit or switching device, which is adequate for two-channel monitoring (for example safety switching device or safe control).
 - The faultless functioning of the relay must be checked at least once a year. The relays must be de-energized. The closing function of the NC contacts must be monitored.
 - Prior to switching on the drive for the first time (with a safety device), the state of the NC contacts must be monitored on its closing function.
 - An abrupt stop of the drive or an irregular running can be caused by an error in the safety chain. The drive must be switched off, if this error occurs.
 - The STO function separates the drive from its torque, but not from its voltage. For the safe isolation of the supply, other measures must be executed (for example the use of a main switch).
 - At total failure of an internal driver (IGBT) or an control element, it can trigger a temporary excitement of the drive (also in the STO state). The angular movement depends on the rotor position and the number of pole pairs of the motor. It amounts to a maximum of 180° / number of pole pairs.
 - The correct function of the second shutdown path „pulse enable“ must be checked at least once a year. Therefore the pulse enable (X26: IF+ and IF-) must be switched off from power then the motor must be without torque.
-



NOTE

The installation of a BM4500 must be done according IEC 60204-1 to avoid EMC disturbances, e.g. using filters for the power supply, cable screening, EMC compatible cable laying, a.s.o.



Table of figures

| | |
|--|-----|
| Danger areas | 27 |
| Position of type key label | 28 |
| Danger areas at the mechanic mounting | 32 |
| Installation space BM454X-S/Z | 33 |
| Drilling pattern BM454X | 34 |
| Mounting instruction BM 454X-S | 36 |
| Danger areas at the electrical installation | 37 |
| Terminal connection diagram of power connections | 42 |
| Electrical connections | 43 |
| Control connection X99A | 45 |
| Ready-to-operate internal | 46 |
| Control connection X99AB | 47 |
| potential free optocoupler input | 47 |
| Safety relay X68 | 49 |
| Position of relay contacts | 53 |
| „Ready-to-operate“ | 54 |
| BB_Ext, X99AB | 60 |
| Pre-warning/error, X99AB | 60 |
| X68 | 60 |
| Danger areas | 61 |
| Demounting scheme | 73 |
| Derating curves BM4543, BM4544 | 89 |
| Derating curves BM4545 | 89 |
| Sequence diagram of safety relay | 101 |
| Application example for safe stop according to category 3 (EN ISO 13849-1) | 102 |
| Application example for safe stop according to category 4 (EN ISO 13849-1) | 104 |
| Shutdown methods for converter series BM454X | 107 |



Table of figures



Index

| | | | |
|------------------------------------|--------|-----------------------------|------------|
| A | | E | |
| Absolute maximum voltage | 84 | EMC instructions | 40 |
| Absolute minimum voltage | 84 | EMC-compatible installation | 40 |
| Accessories | 77 | EN 60204 1-1 | 90 |
| B | | Environmental conditions | 51, 62, 86 |
| b maXX® 4500 | 83 | Environmental temperature | 86 |
| BB ext | 55 | F | |
| BB INT | 55 | Fire fighting | 21 |
| C | | First steps | 7 |
| Cable | | Fuse protection | 90 |
| EMC instructions | 40 | Fuses | 39 |
| Cable control voltage supply | 94 | H | |
| Cable protection | 90, 91 | Hardware type | 29 |
| Cable screens | 40 | I | |
| Cables | | IEC 60204-1 | 39 |
| laying | 40 | Inappropriate use | 11 |
| Capacitors | 67 | Inspection intervals | 62 |
| Circuit breaker | 90 | Installation | |
| Class of protection | 19 | electrical mains | 38 |
| Components/modules | 73 | preconditions | 37 |
| Connecting cable | 39 | Installation space | 31, 33 |
| Connection cross-section | 44 | Interconnect the devices | 26 |
| Connection data of the connections | 44 | Interface cable RS 232 | 77 |
| Connection diagrams | 43 | Introduction | 7 |
| Connection technology | 44 | Isolation from supply | 67 |
| Connection torque | 44 | L | |
| Construction of the devices | 25 | Laying | 40 |
| Control cabinet | 51, 62 | Legal instructions | 10 |
| Controller cartridge | 25 | Low-voltage supply | 84 |
| Controller type | 28 | M | |
| Cooling type | 28 | Mains | 84 |
| Current grading | 28 | Mains chokes | 95, 96 |
| D | | Mains failure monitoring | 57 |
| Danger areas | 27, 61 | Mains type | 29 |
| Dangers | 9, 22 | Mains voltage | 84 |
| DC link | 62 | Maintenance | 60, 61 |
| Declaration of Conformity | 79 | Maintenance notes | 62 |
| Demounting | 68 | Marking | 28 |
| Demounting scheme | 73 | Maximum temperature | 59 |
| Device description | 25 | Modification | 19 |
| Device generation | 28 | Modules | 73 |
| Device protection | 90, 91 | Monitoring | 58 |
| Discharge | 62 | Mounting | 31, 37 |
| Disposal | 71 | Mounting height | 86 |
| Disposal instructions | 73 | Mounting instructions | 34 |
| Drilling patterns | 34 | Mounting technic | 34 |



Index

| | | | |
|------------------------------------|-------------|----------------------------|--------------------|
| N | | | |
| Non-electrical data | 87 | Servo converter | 25 |
| O | | Shutdown | 67 |
| Operating sequence of installation | 41 | Size of cabinet | 28 |
| Operation | 51 | Spare parts | 77 |
| Operation height | 62 | Start the drive | 60 |
| Overtemperature | 59 | State of software | 29 |
| Overview | 27 | Storage | 67 |
| | | Storage conditions | 69 |
| | | Survey of appliance series | 7 |
| P | | T | |
| Packing | 23 | Technical data | 83 |
| Personnel | 20 | Temperature | 62 |
| qualified | 20 | Terminals | 41 |
| Phase failure monitoring | 57 | Terms | |
| Power supply | 84 | definition | 8 |
| Power unit | 25 | Transportation | 23 |
| Prepare mounting | 33 | climatic category | 23 |
| Professional | 20 | shock | 23 |
| Protective measures | 9 | temperature range | 23 |
| Put out of operation | 68 | Type key | 28 |
| Q | | U | |
| Qualified personnel | 20, 32, 52 | UL 508 C | 39, 41, 84, 91, 93 |
| R | | Unexpected starting | 97 |
| Rated mains input voltage | 84 | Unpacking | 23 |
| Ready-to-operate controller | 54 | W | |
| Ready-to-operate external | 55 | Washers | 36 |
| Ready-to-operate internal | 55 | WEEE, 2002/96/EG | 71 |
| Ready-to-operate power unit | 54 | | |
| Ready-to-operate supply unit | 54 | | |
| Recommissioning | 69 | | |
| Recycling | 73 | | |
| Relative air humidity | 62 | | |
| Repair | 65 | | |
| Requirements to the motor | 85 | | |
| Residual energy | 20 | | |
| Responsibility and liability | 22 | | |
| S | | | |
| Safe stop | 97 | | |
| Safety categories | 100 | | |
| Safety fuses | 90 | | |
| Safety instructions | 9, 22 | | |
| Safety notes | 22 | | |
| Safety relay | 29, 41, 100 | | |
| is switched off | 56 | | |
| Screwing (UL) | 41 | | |
| Screws | 36 | | |
| Semiconductor fuses | 90 | | |



Revision survey

| Version | Edition | Changing |
|------------|------------|---|
| 5.05022.01 | 20.06.2006 | First edition |
| | | Appendix Safe torque off revised |
| 5.05022.04 | 10.08.2011 | Chap. 4.6 UL-notes added, Appendix Safe torque off revised Appendix D7 added, Note added concerning part number „06“ |
| 5.05022.05 | 25.02.2015 | Changes chapter STO |

be in motion

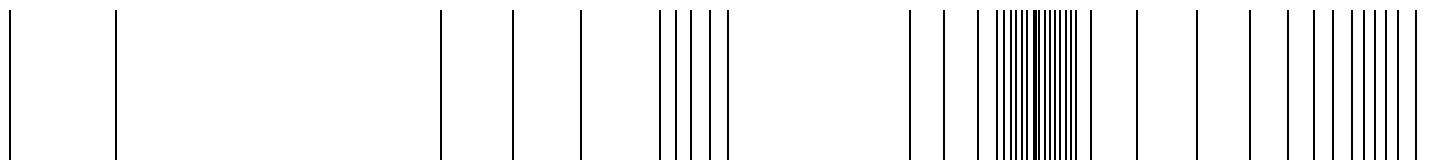

Baumüller Nürnberg GmbH Ostendstraße 80-90 90482 Nürnberg T: +49(0)911-5432-0 F: +49(0)911-5432-130 www.baumueller.de

All information given in this manual is customer information, subject to change without notice. We reserve the right to further develop and actualize our products continuously using our permanent revision service. Please notice, that specifications/data/information are current values according to the printing date. These statements are not legally binding according to the measurement, computation and calculations. Before you make any information given in this manual to the basis of your own calculations and/or applications, please make sure that you have the latest edition of the information in hand. No liability can be accepted concerning the correctness of the information.