



# **INVERTER**

# **VF200**

# **Instruction Manual**



Read this manual carefully before attempting to operate the inverter and store it for future reference.

WME-VF200-A

---

2013.01 | [panasonic.net/id/pidsx/global](http://panasonic.net/id/pidsx/global)



# Foreword

---

Thank you for purchasing Panasonic products.

- For optimum performance and safety, please read this manual carefully before using this product.
- Please save this manual for future use.

## Applicability of the Product

---

- This general-purpose inverter manufactured by us is not designed or manufactured to be used in machine or system in situations that can affect or endanger human life.  
Before using this product in special applications such as machinery or systems in movable object, medical, aerospace, nuclear energy control, submarine relay equipments or systems, please contact us.
- Although this product was manufactured under strict quality control system, it is strongly recommended to install safety devices to prevent serious accidents when used in facilities where a breakdown of this product is likely to cause a serious injury or major losses.
- Do not use this product for loads other than a 3-phase induction motor.

# Table of contents

---

Safety Precautions .....	1
Points for Handling .....	9
Special Precautions .....	10
1. Parts Identification .....	13
1.1 Part Names and Functions .....	14
1.2 Details on Part Number .....	16
2. Installation .....	17
2.1 Safety Precautions .....	18
2.2 Installation Precautions .....	19
2.3 Outline Dimensions .....	21
2.4 Removal and Installation of Operation Panel .....	23
3. Wiring .....	25
3.1 Safety Precautions .....	26
3.2 Removal and Installation of Terminal Cover .....	27
3.3 Wiring (Main Circuit) .....	29
3.4 Wiring (Control Circuit) .....	33
4. Operation Method(Basic Operation) .....	43
4.1 Safety Precautions .....	44
4.2 Description of Operation Panel/Simple Panel .....	45
4.3 Operation Modes .....	47
4.4 Type of Operation Method .....	50



# Table of contents

---

4.5	Setting Frequency with Operation Panel .....	51
4.6	Setting Forward/Reverse Run with Operation Panel .....	52
4.7	Operating with Operation Panel .....	54
5.	Control Status Monitor .....	69
5.1	List of Control Status Monitor Items .....	70
5.2	Introduction of Monitor No .....	72
6.	Function Parameters .....	81
6.1	Setting and Changing Function Parameters .....	82
6.2	Function Parameter List .....	86
7.	Custom Mode .....	95
7.1	Allocating Parameter No.....	96
7.2	Setting and Changing Parameters .....	98
8.	Setting Modes and Copy Functions of Built-in Memory .....	101
8.1	Setting Modes and Copy Functions of Built-in Memory .....	102
8.2	Setting Built-in Memory Parameters .....	103
8.3	Parameter Upload Function (CPY1) .....	105
8.4	Parameter Download Function (CPY2) .....	107
8.5	Parameter Verification Function .....	109
8.6	To Display or Conceal Built-in Memory Setting Mode .....	111
9.	Troubleshooting.....	113
9.1	Safety Precautions .....	114
9.2	Abnormality Diagnostic Function and Resetting Method .....	114
9.3	Handling Abnormalities .....	118

# Table of contents

---

10. Maintenance and Inspection .....	121
10.1 Safety Precautions .....	122
10.2 Precautions on Inspection .....	122
10.3 Inspection Items .....	122
10.4 Component Replacement .....	124
10.5 Maintenance and Inspection Table .....	125
11. Specifications .....	129
11.1 Rated Specifications .....	130
11.2 Standard Specifications .....	132
11.3 Common Specifications .....	133
Appendix .....	139
Function Parameter List .....	140
“Administrative Measures for Control of Pollution Caused by Electronic Information Products” in China Names and Content Marks of Toxic or Hazardous Substances and Elements .....	276
Precautions on European Standard Directives .....	277
Conditions of CE Marking .....	278
Warranty .....	279



# Safety Precautions

## Safety Precautions

Read this manual and related documents before attempting to install, operate, service or inspect the inverter.

Make sure that you have a full understanding of the device, the safety information and all precautions before starting use.

Precautions described in this manual are divided into two grades: “Danger” and “Caution”.



: Indicates dangerous situations that could lead to injury or death in case of mishandling.

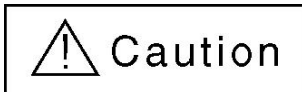

: Indicates dangerous situations that could lead to moderate or minor injury or property damage in case of mishandling.

In addition, failure to follow the precautions in

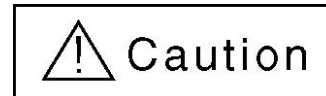

may also lead to serious situations depending on conditions.

Since the precautions of the above two grades are of critical importance, please make sure to observe them strictly.

## 1. Installation

### Caution

- Install the unit on non-flammable material, such as metal, etc. Failure to do so may lead to fire.
- Do not place the unit near flammable materials. Failure to do so may lead to fire.
- Do not hold the unit by terminal cover while transporting it. Failure to do so may cause the unit to drop and result in injury.
- Do not let foreign matter such as metal sheet enter into the unit. Failure to do so may lead to fire.
- Install the unit on a place strong enough to support the weight of it according to the instruction manual. Failure to do so may lead to dropping of the unit and thus result in injury.
- Do not install or operate an inverter that is damaged or with part(s) missing. Failure to do so may result in injury.

## 2. Wiring

### Danger

- Always make sure that power is OFF before starting wiring. Failure to do so may result in an electric shock or fire.
- Always connect ground wire. Failure to do so may result in an electric shock or fire.
- Wiring work should always be carried out by qualified electrician. Failure to do so may result in an electric shock or fire.
- Always install the unit before wiring. Failure to do so may result in an electric shock or injury.

 **Caution**

- Do not connect an AC power supply to output terminals (U, V, W). Failure to do so may result in injury or fire.
- Make sure that the voltage rating of the product matches with that of AC power supply. Or it may result in injury and fire.
- Tighten terminal screws to specified torque. Failure to do so may lead to fire.

### 3. Operation

 **Danger**

- Always close terminal cover before turning ON inlet power . Do not open the terminal cover while the power is ON. Failure to do so may result in an electric shock or fire.
- Do not operate the switches or dials with wet hands. Failure to do so may result in an electric shock.
- Do not touch inverter terminals even when the inverter is stopped while power ON. Failure to do so may result in an electric shock.
- The STOP button is not designed for emergency stop purposes. Set a separate button for emergency stop. Failure to do so may result in injury.
- Depending on the start mode and settings of ride-through function, if operating signal is ON or the power is restored from a power failure, the inverter may start (or restart) suddenly. Keep away from the unit to avoid injury.  

( Design the machine so that it can ensure personal safety even if the inverter starts suddenly. )
- Depending on the setting of start mode function, when reset fault trip with the operating signal present, the inverter may restart suddenly.

(Always take measures to ensure personal safety.) Failure to do so may result in injury.

- When retry function is in use, the unit may automatically start (restart) suddenly, so do not approach the unit. (Always take measures to ensure personal safety.) Failure to do so may result in injury.

- While auto-tuning function is in use, the inverter will automatically drive the motor in the stand-alone mode when the RUN button on the panel is pressed.

(Always take measures to ensure personal safety.) Failure to do so may result in injury.

- If data change during operation, variations of the motor and motor load may change drastically and sudden stop will occur.

(Always take measures to ensure personal safety.) Failure to do so may result in injury.

### Caution

- The heat sink and braking resistors are under high temperature, so do not touch them. Doing so may result in burns.
- The inverter can be easily set to operate from low speed to high speed. Confirm the allowable range of motor and machine carefully during setup. Failure to do so may result in injury.
- Set separate holding brakes if required. Failure to do so may result in injury.



## 4. Maintenance, Inspection and Part Replacement

### Danger

- Wait at least five minutes after turning OFF inlet power before starting maintenance and inspection. Failure to do so may result in an electric shock.
- Maintenance, inspection and part replacement work must be done only by qualified persons.  
[Remove all metal personal belongings (watches, bracelets, etc.) before starting work.] (Use tools treated with insulation.) Failure to do so may result in an electric shock or injury.

### Caution

- Employ an electrical engineering company to periodically tighten the terminal screws. Loosen screws may lead to overheating or fire.

## 5. Others

### Danger

- Never modify the unit. Failure to do so may result in injury.

## 6. General Precautions

All diagrams in this instruction manual show the state with the cover or safety partitions removed to explain the details. Be sure to replace the covers and partitions in position, and then operate the unit according to the instruction manual.

## 7. Warning Label on Inverter

[Inverter Surface]

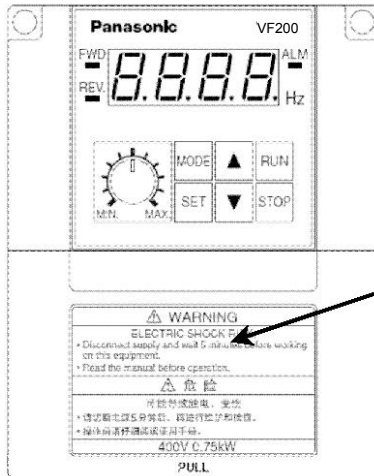

Example: 400V 0.75kW



# Points for Handling

Special Precautions.....	10
--------------------------	----

## Special Precautions

---

- ◆ Use the inverter only within allowable ambient temperature range (-10~50°C).

Since service life of the inverter is greatly affected by ambient temperature, use it within allowable temperature range. Also, observe the installation directions and conditions. (Refer to P.21)

- ◆ The inverter will be damaged if the power voltage is applied to its output side.

Applying power voltage to the output terminal U, V or W will damage the inverter. Check carefully for faulty wiring and operation sequence (commercial switching circuit, etc.). Never apply a voltage exceeding the allowable range.

- ◆ Never touch inside of the inverter during operation.

Failure to do so could be extremely dangerous, since the inverter contains high-voltage circuit. Before making an internal check, be sure to wait at least 5 minutes after turning OFF the inverter. Do not touch heat sink or braking resistor during operation as these parts are under high temperature.

- ◆ Radio interference

The main circuit of the inverter contains a high-frequency harmonic component and may interfere with communicating equipments (such as AM radio) nearby. The severity of interference depends on the radio field strength and is hard to be eliminated completely. While it may be reduced by relocating radio antenna, using noise filter, housing the inverter in a metal box, or routing cables in conduit. (Please inquire separately.)

- ◆ Do not conduct insulation test between wires of the inverter.

To measure insulation resistance between power cord and motor wires, please remove the cables connected to the inverter and conduct test with them. Do not conduct insulation test on the control circuits. However, insulation test can be performed between charging unit and the ground.

- ◆ **Do not use a magnetic contactor which is connected to power side or load side of the inverter to start or stop the motor (inverter).**

Frequent ON/OFF switching on the power supply side can cause inverter malfunction. Also, do not conduct ON/OFF switching on load side during inverter operation, or it can cause fault trip of the inverter. Start or stop the motor by operating signals of the inverter only.

- ◆ **Do not connect a power capacitor or a surge absorber to output side of the inverter.**

Such device can damage the inverter, resulting in broken of capacitors and other parts. Remove it if connected.

- ◆ **Do not use the inverter for load other than a motor or for a 1-phase motor.**

- ◆ **If parameters are frequently written in, service life of built-in non-volatile memory (EEPROM) of the inverter will be shortened.**

The maximum life of non-volatile memory (EEPROM) used in VF200 is 100,000 times. Therefore, do not write in parameters frequently.

- ◆ **Precautions for inverter's protection function**

The inverter integrates various protection functions such as stall prevention, current limiting and over-current shut-off. These protection functions are functions used to protect the inverter against the sudden abnormal conditions, instead of general control functions.

Therefore, avoid using them in applications where they will be activated under normal conditions.

Failure to do so may reduce the inverter's service life or damage the inverter.

Always measure the output current, etc. with a meter, check the details of the fault trip memory, and confirm that operation conditions conform to the precautions and specifications are correct.



# 1

## Parts Identification

1.1 Part Names and Functions .....	14
1.2 Details on Part Number .....	16



# 1.1 Part Names and Functions

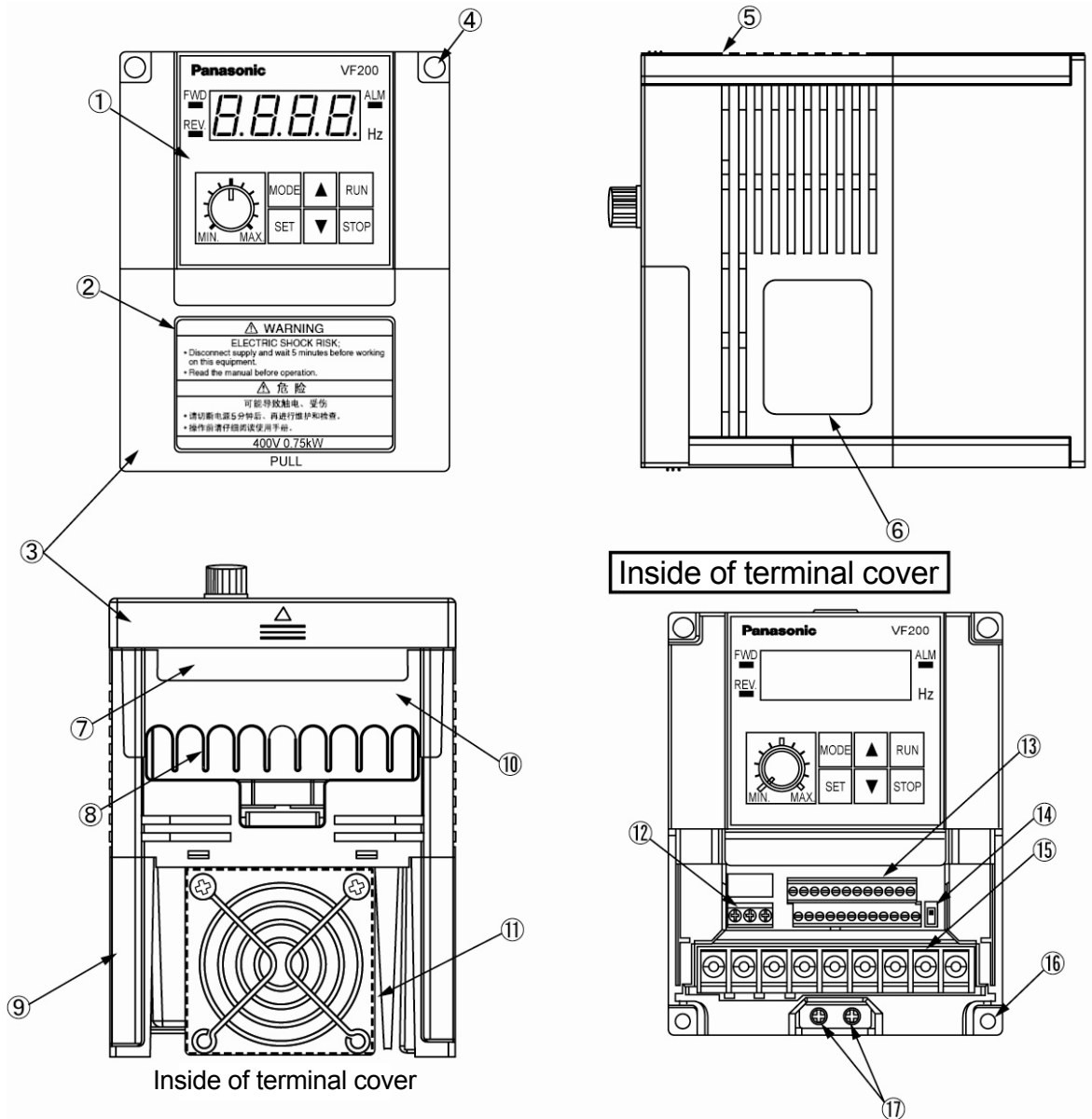

Inside of terminal cover

Inside of terminal cover

Note) This explanatory drawing shows the state with terminal cover removed. During normal use, do not remove terminal cover.

- ① Operation panel unit
- ② Warning label
- ③ Terminal cover 1 (terminal cover for control circuit)
- ④ Mounting holes
- ⑤ Casing
- ⑥ Rating nameplate\*1
- ⑦ Inlet hole for control wire
- ⑧ Inlet hole for main circuit wire
- ⑨ Heat sink
- ⑩ Terminal cover 2 (terminal cover for main circuit)
- ⑪ Cooling fan\*2
- ⑫ Terminal block for control circuit (relay output)
- ⑬ Terminal block for control circuit (signal input/output)
- ⑭ SINK/SOURCE changeover switch
- ⑮ Terminal block for main circuit
- ⑯ Mounting holes
- ⑰ Ground terminal

\*1 Check that the rating nameplate confirms to your order.

\*2 Not provided on the models of 0.75 kW or lower capacity.

## 1.2 Details on Part Number

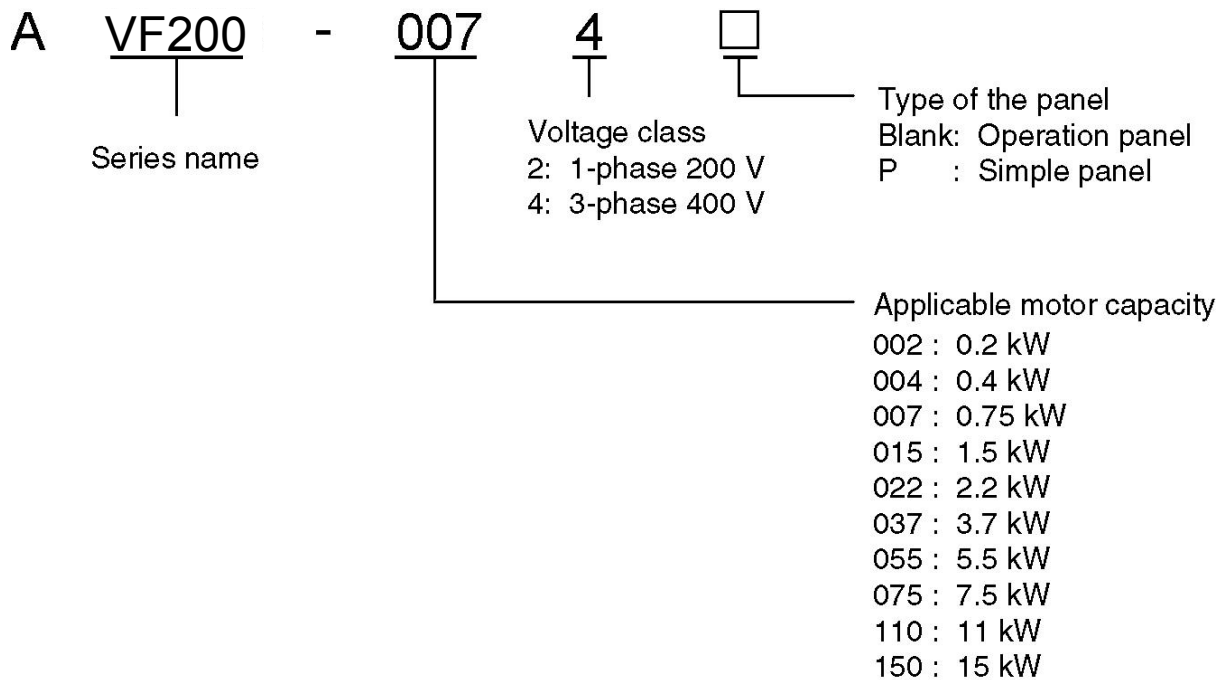

Power supply	Applicable motor capacity (kW)	Part Number	
		Operation panel	Simple panel
1-phase 200 V	0.2	AVF200-0022	AVF200-0022P
	0.4	AVF200-0042	AVF200-0042P
	0.75	AVF200-0072	AVF200-0072P
	1.5	AVF200-0152	AVF200-0152P
	2.2	AVF200-0222	AVF200-0222P
3-phase 400 V	0.75	AVF200-0074	AVF200-0074P
	1.5	AVF200-0154	AVF200-0154P
	2.2	AVF200-0224	AVF200-0224P
	3.7	AVF200-0374	AVF200-0374P
	5.5	AVF200-0554	AVF200-0554P
	7.5	AVF200-0754	AVF200-0754P
	11	AVF200-1104	AVF200-1104P
15	AVF200-1504	AVF200-1504P	

# 2

## Installation

2.1 Safety Precautions .....	18
2.2 Installation Precautions .....	19
2.3 Outline Dimensions .....	21
2.4 Removal and Installation of Operation Panel ....	23

## 2.1 Safety Precautions

---



### Caution

Install the unit on non-flammable material, such as metal, etc.

Failure to do so may lead to fire.

Do not place the unit near flammable materials.

Failure to do so may lead to fire.

Do not hold the unit by terminal cover while transporting it.

Failure to do so may cause the unit to drop and result in injury.

Do not let foreign matter such as metal sheet enter into the unit.

Failure to do so may lead to fire.

Install the unit on a place strong enough to support the weight of it according to the instruction manual.

Failure to do so may lead to dropping of the unit and thus result in injury.

Do not install or operate an inverter that is damaged or with part(s) missing.

Failure to do so may result in injury.

## 2.2 Installation Precautions

---

■ Do not install the inverter in the following locations.

- Locations subject to direct sunlight
- Locations subject to water vapor or high humidity
- Locations with large amount of oil mist, dust or fiber dust
- Locations where rain water, water drops or oil drops may come in contact
- Locations where corrosive gases, explosive gases or flammable gases are present
- Installation onto flammable materials such as wood, or near flammable materials
- Locations subject to vibration

■ Make sure that ambient temperature stays within the specifications.

If the inverter is installed near a heat generating device or is housed in a panel, surrounding temperature will increase. This may reduce the life of the inverter. When housing the inverter in a panel, give sufficient consideration to cooling method and panel size.

○ Allowable ambient temperature: -10 to +50 °C

(Ambient temperature should be measured at a point 5 cm from the inverter.)

○ In case multiple inverters are installed

If multiple inverters are installed sideways, ambient temperature should be within -10 to + 40 °C.

■ Install the inverter vertically.

Installing the inverter in any other way will decrease heat dissipation effect and result in malfunction.

## 2. Installation

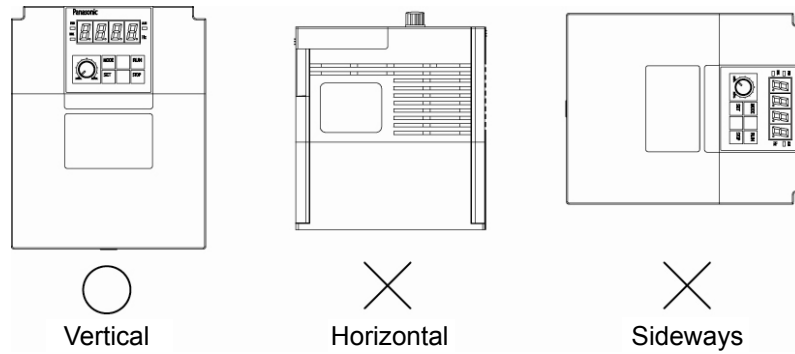

### ■ Space for installation

When a single inverter is installed

To ensure sufficient space for ventilation (cooling) and wiring of the inverter, always provide a clearance as shown in the following figure.

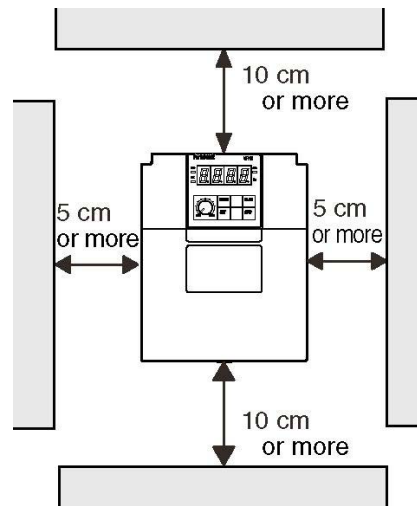

When multiple inverters are installed sideways

If multiple inverters are installed sideways inside control panel, always provide a clearance as shown in the following figure.

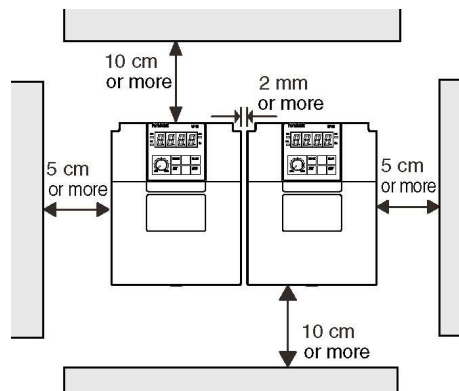

## 2.3 Outline Dimensions

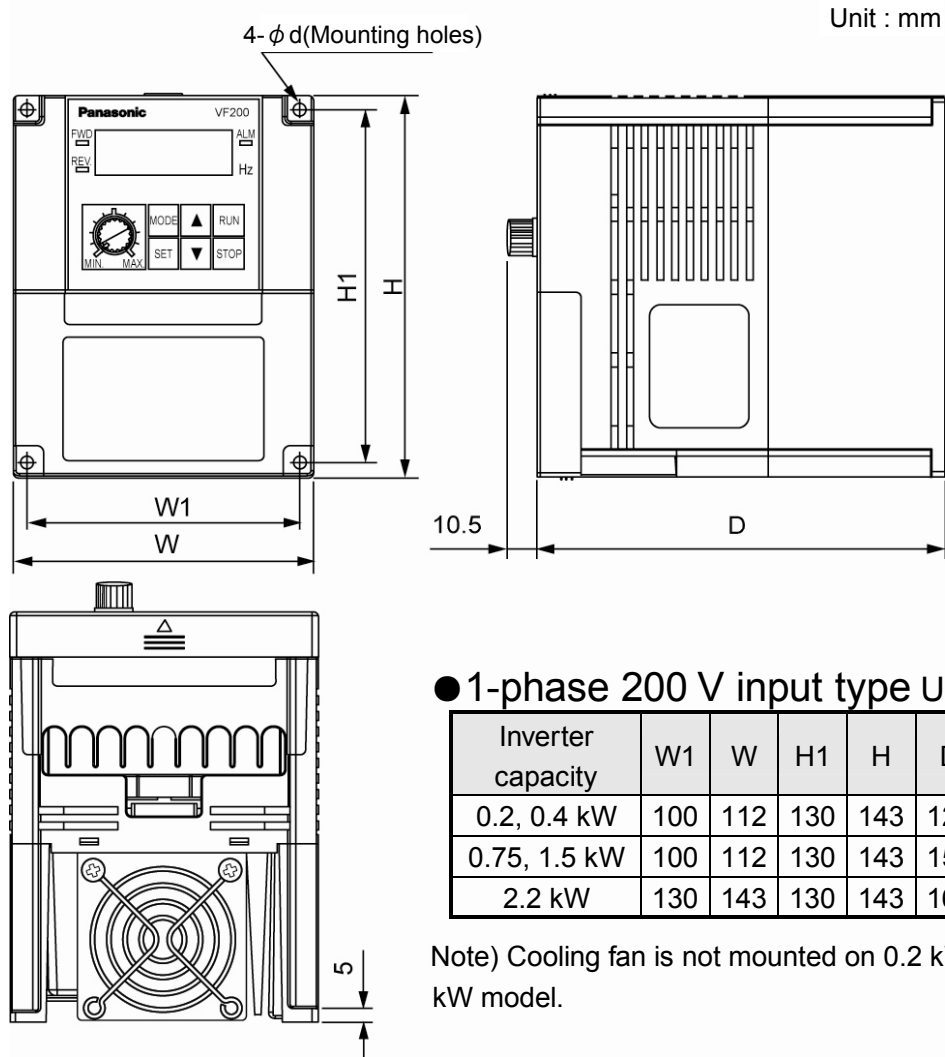

● 3-phase 400 V input type Unit: mm

Inverter capacity	W1	W	H1	H	D	$\phi$ d
0.75, 1.5 kW	100	112	130	143	150	5
2.2, 3.7 kW	130	143	130	143	150	5
5.5, 7.5 kW	150	163	190	203	179	5
11, 15 kW	204	223	265	283	179	7

Note) The cooling fan is not mounted on 0.75 kW model.



### ■ Operation panel

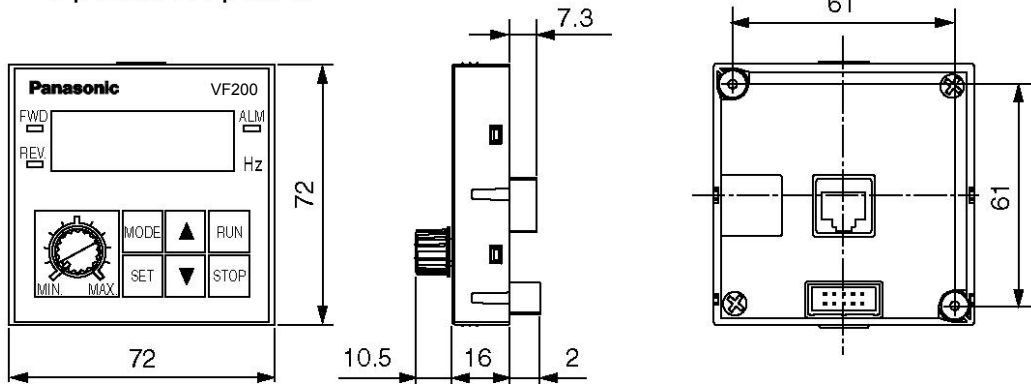

## 2.4 Removal and Installation of Operation Panel



### Caution

Cut off the power supplied to operation panel before removing it.  
Do not remove the operation panel frequently.  
Otherwise, malfunction may occur.

Do not connect the inverter or operation panel to PC or other devices via a LAN cable.

Or other devices may be damaged.

- (Removal) ① While holding the center top and bottom part of the operation panel, pull it up vertically to remove it.
- (Installation) ② While holding the center top and bottom part of the operation panel, align mounting position (align transverse slot on operation panel with flange on the casing) and press down vertically to install it.

Note) After installation, confirm that the operation panel is fitted in position.

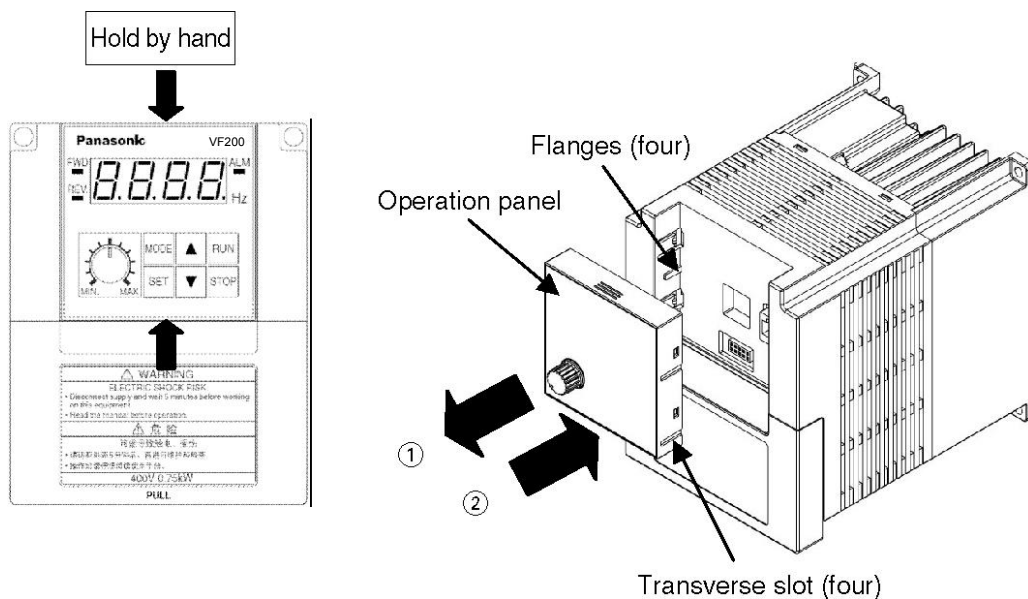

## 2. Installation

### ■ Connect the operation panel via a LAN cable

A commercially available LAN cable can be used to connect the main unit of the inverter and the operation panel.

Use LAN cable only for the purpose of connecting the main unit of the inverter and operation panel. Otherwise, the inverter could be damaged.

Specification for LAN cable: 8-Pin straight cable of CAT5 or higher (maximum length is 5 m)

1. Cut off the power and then remove the panel following above instructions.
2. Insert one end of LAN cable to the main unit of the inverter and the other end to connector (RJ45) on the panel until a "click" sound is heard.

### ■ Inverter side

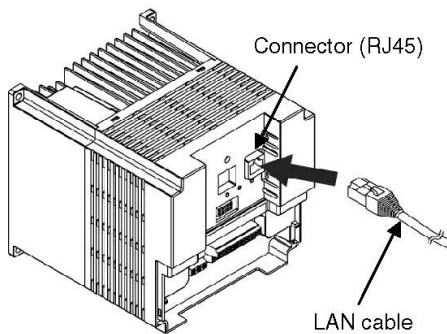

### ■ Operation panel side

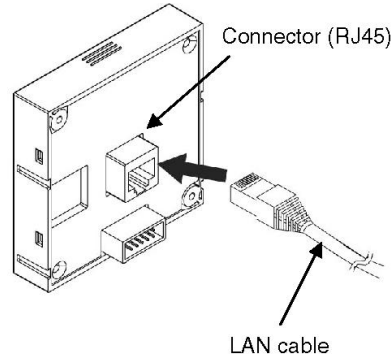

### ■ Installed on the plate (panel)

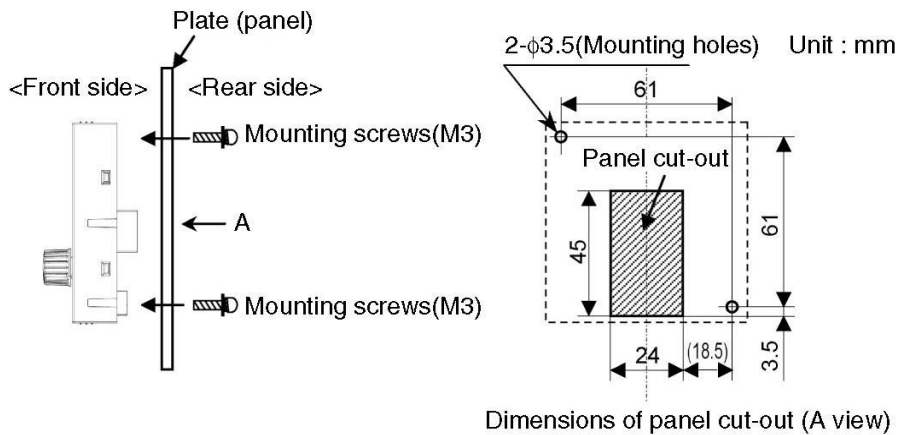

### ■ Mounting Procedure

1. Cut the mounting plate to above dimensions.  
The suitable thickness of the plate is 1.0 mm ~ 3.5 mm.
2. Mount the operation panel onto the front side of plate (panel), and attach the mounting screws supplied onto the rear side. (Tightening torque: 0.6 N·m)
3. Mount LAN cable after the operation panel is installed.



# 3

## Wiring

3.1 Safety Precautions .....	26
3.2 Removal and Installation of Terminal Cover.....	27
3.3 Wiring (Main Circuit).....	29
3.4 Wiring (Control Circuit) .....	33

## 3.1 Safety Precautions

---

 <b>Danger</b>	<p>Make sure that power is turned OFF before starting wiring. Failure to do so may result in an electric shock or fire. Always connect ground wire. Failure to do so may result in an electric shock or fire. Wiring work should always be carried out by qualified electrician. Failure to do so may result in an electric shock or fire. Always install the unit before wiring. Failure to do so may result in an electric shock or injury.</p>
 <b>Caution</b>	<p>Do not connect an AC power source to output terminals (U, V, W). Failure to do so may result in injury or fire. Make sure that the voltage rating of the product matches with that of AC power source. Failure to do so may result in injury or fire. Tighten the terminal screws to the specified tightening torque. Failure to do so may lead to fire.</p>

## 3.2 Removal and Installation of Terminal Cover

### ■ Removal and Installation of Terminal Cover 1 (Terminal Cover for Control Circuit )

{ Removal }

① While holding the center bottom edge of the terminal cover 1 and pull it up lightly.

{ Installation }

② Insert the mounting jaw of terminal cover 1 into the slot on the casing, then lightly press down the center bottom edge of the terminal cover 1.

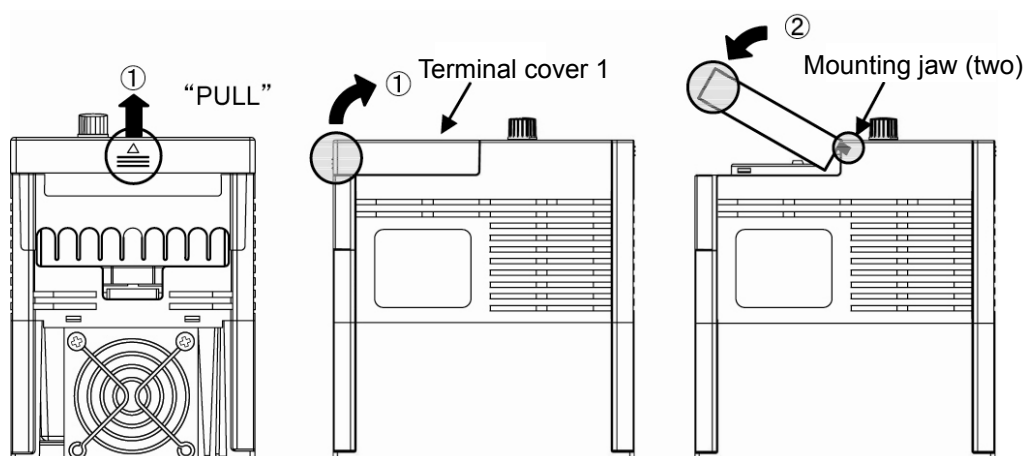

### ■ Removal and Installation of Terminal Cover 2 (Terminal Cover for Main Circuit )

{ Removal }

① While holding the center part of the terminal cover 2, pull it up lightly until the mounting jaw releases.

{ Installation }

② Insert the mounting jaw of terminal cover 2 into the slot on the casing, then lightly press down the terminal cover 2.

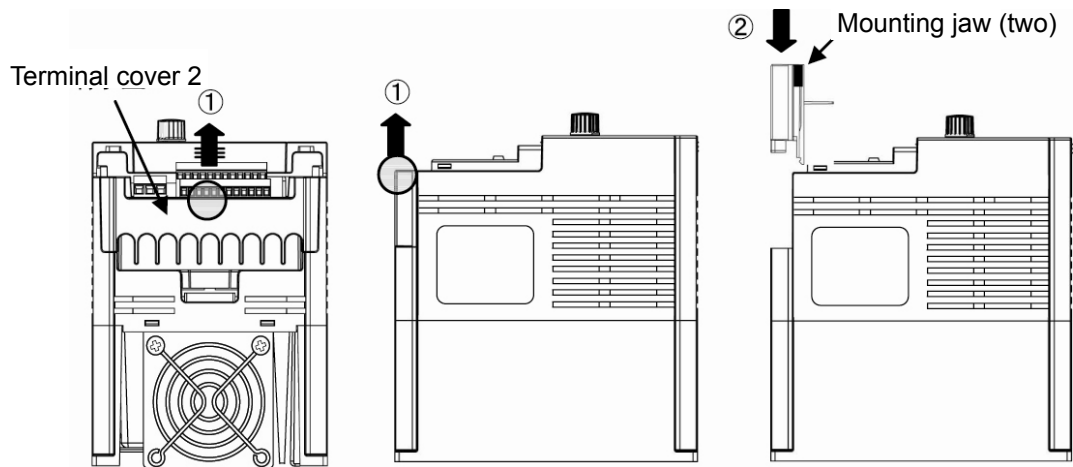

Note) After installation, make sure that the terminal cover 1 and 2 are fitted in position.

## 3.3 Wiring (Main Circuit)

### 3.3.1 Wiring (Terminals for Main Circuit)

- 1-phase 200 V 0.2~2.2 kW

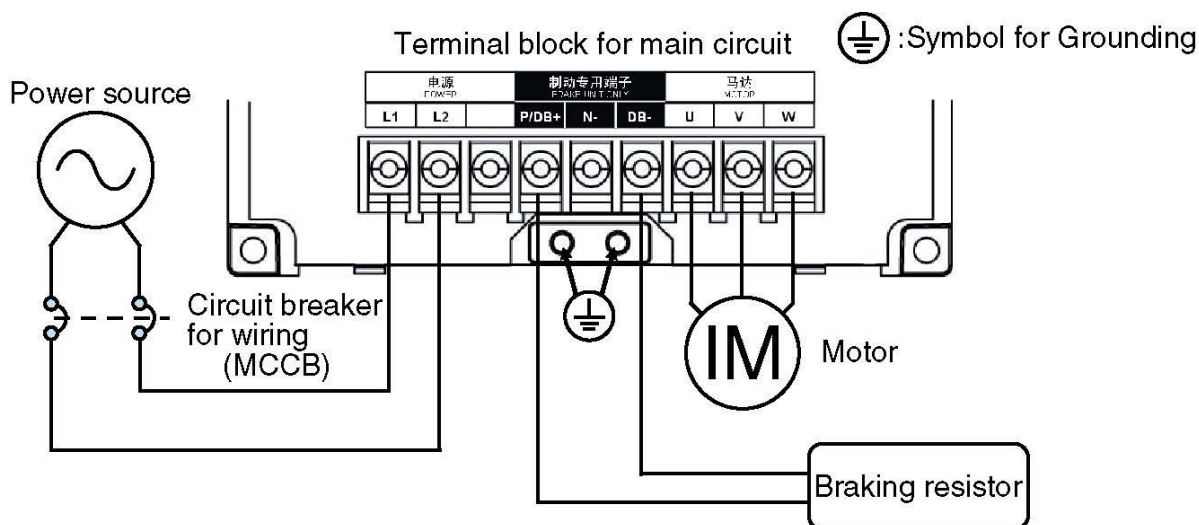

- 3-phase 400 V 0.75~15 kW

To conform to CE mark compliance, protective devices against overcurrent, short-circuit and current leakage must be set up on the power supply side of the inverter.

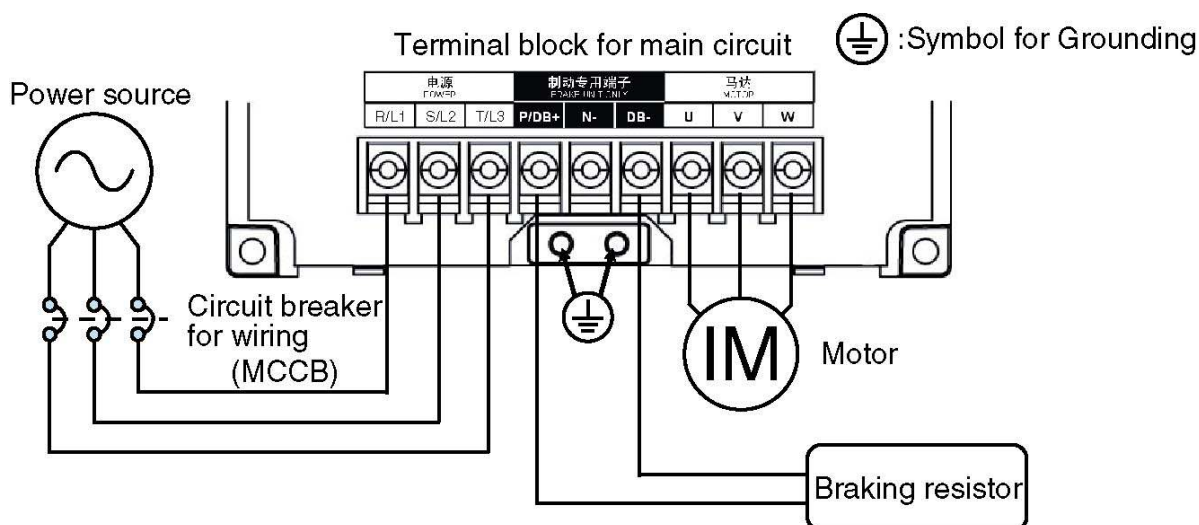



### 3. Wiring

---

#### ■ Functions of Terminals for Main Circuit

Terminal No.	Terminal name	Explanation of terminal function
R/L1, S/L2. T/L3	Power supply for Main circuit	For 1-phase 200 V type, connect to terminal L1 and L2.
U, V, W	Inverter output	Connect to 3-phase motor.
P/DB+, DB-	Braking resistor connection	Connect to braking resistor.
N—	Internal DC voltage (negative)	Negative terminal of internal DC voltage.
 × 2	Ground	Ground terminal. 1-phase 200 V: ground resistance 100 Ω or less 3-phase 400 V: ground resistance 10 Ω or less Ground the neutral of power source.

## 3.3.2 Precautions on Wiring Main Circuit

---

### ■ Precautions on Wiring

To avoid mistakes in wiring and operation, be sure to observe the following guides. (Failure to do so may damage the unit.)

- Always connect the power source to input terminals (R/L1, S/L2, T/L3), and connect the motor to output terminals (U,V,W).
- Use round crimp terminals with sleeve for power source and motor connections. Select crimp terminals according to wire sizes and screw sizes.
- After wiring main circuit, confirm the tightening condition of terminals.
- Main circuit must be wired prior to control circuit. Otherwise, re-tightening operation is not possible after control circuit wiring is completed.
- When connecting directly to a transformer of large capacity (500 kVA or more), always install an AC reactor on the input side of the inverter.

Note 1: It is recommended to use teflon insulated wire (600 V, Class 2, allowable operating temperature up to 75 °C) for main circuit wiring.

Note 2: Use wires with larger diameter if the wiring distance is long.

Note 3: If the overcurrent trip of the circuit breaker is magnetic type, the device could become overheated due to higher harmonics. Use a load rate of 50% or lower in this case.

Note 4: If a circuit breaker for motor protection is in use, remove it.

Note 5: Always connect protective devices against overcurrent, short-circuit and current leakage on the input side.

### ■ Precautions on Using Regenerative Brakes

- When using regenerative brakes, set the parameter P019 to "0". Since the factory setting is "1", the brakes will not be activated.

- Specifications for regenerative brakes are shown as follows. Carefully consider the operation conditions before using them. Note that the inverter could be damaged if a brake outside specifications is used.

Max. duty factor (%ED): 5% • Max. operating time: 5 s • Max. torque: 100%

### 3. Wiring

#### ■ Connected Device, Wire Size and Tightening Torque (1-phase 200 V)

Inverter capacity	Current rating of circuit breaker for wiring (MCCB)	Wire size		Terminal screw size	Tightening torque
		L1, L2 U, V, W	Ground wire		
0.2 kW	5 A	2 mm <sup>2</sup> (AWG14)	2 mm <sup>2</sup> (AWG14)	M4	1.2 N • m
0.4 kW	10 A				
0.75 kW	15 A				
1.5 kW	20 A				
2.2 kW	40 A	3.5 mm <sup>2</sup> (AWG12)			

#### ■ Connected Device, Wire Size and Tightening Torque (3-phase 400 V)

Inverter capacity	Current rating of circuit breaker for wiring (MCCB)	Wire size		Terminal screw size	Tightening torque
		R/L1, S/L2, T/L3, U, V, W	Ground wire		
0.75 kW	5 A	2 mm <sup>2</sup> (AWG14)	2 mm <sup>2</sup> (AWG14)	M4	1.2 N • m
1.5 kW	10 A				
2.2 kW	15 A				
3.7 kW	20 A				
5.5 kW	30 A	2 mm <sup>2</sup> (AWG14)	3.5 mm <sup>2</sup> (AWG12)		
7.5 kW	30 A	3.5 mm <sup>2</sup> (AWG12)			
11 kW	50 A	5.5 mm <sup>2</sup> (AWG10)	8 mm <sup>2</sup> (AWG8)	M5	2.0 N • m
15 kW	60 A	8 mm <sup>2</sup> (AWG8)			



## 3.4 Wiring (Control Circuit)

### 3.4.1 Terminal Arrangement and Functions

#### ■ Terminal arrangement

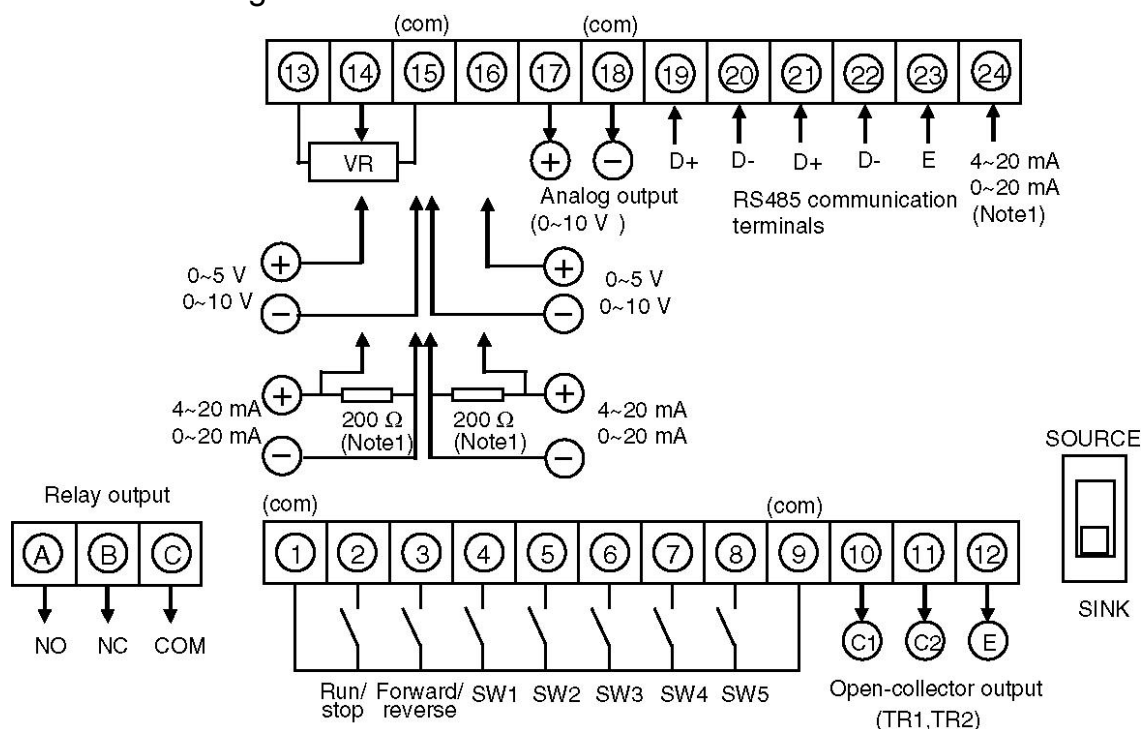

- Specification for frequency setting potentiometer (VR): 10 kΩ, 1/4W or higher
- Specification for relay output contact : 1c volt free contact  
230 VAC 0.3 A, 30 VDC 0.3A (resistive load)

- Specification for open-collector output: Max. rating 50 VDC, 50 mA

Note 1) If the unit version is Ver3.0 or later, a built-in 200 Ω resistor should be set between terminal No.24 and COM.

If analog input signal of 4 to 20 mA / 0 to 20 mA is used, external resistor connection can be eliminated by connecting terminal No.24 to No.14 or No.16. For external connection, it is recommended to use a resistor of 200 Ω, 1/4 W.

#### ■ Explanation of terminals for control circuit

Terminal No.	Terminal function	Related parameter No.
①	Common terminal for input signals (②~⑧)	—
②	Input terminal for start /stop, forward run signal	P003
③	Input terminal for forward / reverse, reverse run signal	P003
④	Input terminal for multi-function control signal SW1	P036, P041
⑤	Input terminal for multi-function control signal SW2	P037, P041
⑥	Input terminal for multi-function control signal SW3	P038, P041
⑦	Input terminal for multi-function control signal SW4	P039, P041
⑧	Input terminal for multi-function control signal SW5	P040, P041
⑨	Common terminal for input signals (②~⑧)	—
⑩	Output terminal for open-collector (TR1) (C1: Collector)	P090
⑪	Output terminal for open-collector (TR2) (C2: Collector)	P091
⑫	Open-collector output terminal (E: Emitter)	P090, P091
⑬	Connection terminal for frequency setting potentiometer (+5 V)	P004
⑭	Input terminal for analog signal of frequency setting	P004
⑮	Common terminal for analog signals (⑬, ⑭, ⑯, ⑰)	—
⑯	Input terminal for the 2 <sup>nd</sup> analog signal	P106—P111, P124, P125
⑰	Output terminal for multi-function analog signal (0 ~ 10 V/PWM)	P097, 098
⑱	Common terminal for analog signals (⑬, ⑭, ⑯, ⑰)	—
⑲	+ terminal for RS485 communication transmission line (D+)	P135—P142
⑳	- terminal for RS485 communication transmission line (D-)	P135—P142
㉑	+ terminal for RS485 communication transmission line (D+)	P135—P142
㉒	- terminal for RS485 communication transmission line (D-)	P135—P142
㉓	Terminal for terminal station of RS485 communication (E)	P135—P142

---

⑳	Built-in 200 $\Omega$ terminal for analog current input	P004, P125
A	Output terminal for relay contact (NO: factory setting)	P092
B	Output terminal for relay contact (NC: factory setting)	P092
C	Output terminal for relay contact (COM)	P092

Note ) Common terminals (①, ⑨, ⑮, ⑱) are connected internally.

Do not ground the common terminal.

### 3.4.2 Common Precautions on Terminals for Control Circuit

#### ■ Precautions on Wiring

- For wiring of terminals of control circuit, strip specified length of insulation coating before connecting.
- Loosen the terminal screws and insert the wires from bottom of the terminal block, and tighten the screws to specified tightening torque.
- Twist the strands of stripped wires, avoiding length variance.

Also, do not solder them.

- Any loose connection could cause wire to come off and lead to malfunction.

Also, over-tightening could cause short-circuit due to screws and the unit broken, thus lead to malfunction.

- Use shielded cables for all control signal lines and separate them from power lines or high-voltage circuits (20 cm or more).
- Wiring length of control signal lines should be within 30 m.
- Since input signals of control circuit are feeble, use dedicated terminals for feeble signals to avoid poor contact during contact input.

#### ■ Wire Size and Tightening Torque for Control Circuit Terminal

Terminal symbol	Screw size	Tightening torque N · m	Wire size	Stripping length of wire
A, B, C	M3	0.5 to 0.6	0.25 to 0.75 mm <sup>2</sup> (AWG24 to AWG18)	6 mm
①~②④	M2	0.22 to 0.25	0.25~0.75 mm <sup>2</sup> (AWG24 to AWG18)	5 mm

- Screwdriver: Small-size ⊖ screwdriver

(Thickness of the edge: 0.4 mm/ Width of the edge: 2.5 mm)

- Removed length of insulation

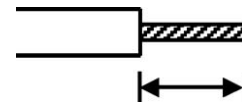

### 3.4.3 Specific Precautions on Each Terminal

#### ■ Terminals for Control Circuit (Terminal No.1~9)

- Control logic of input signal can be switched according to the connected external input devices. Please set the changeover switch of VF200 unit as required.
- Input circuit is shown in the following figure. Take back current and leakage current into account.

#### Wiring diagram and precautions for sink input setting

- Set the changeover switch to “SINK” position.
- Since the power of internal circuit is supplied from internal +12 V, never connect an external power source. Otherwise, it can cause inverter fault.
- Please connect signals of volt free contact or open-collector to control terminal No.2 to 8.

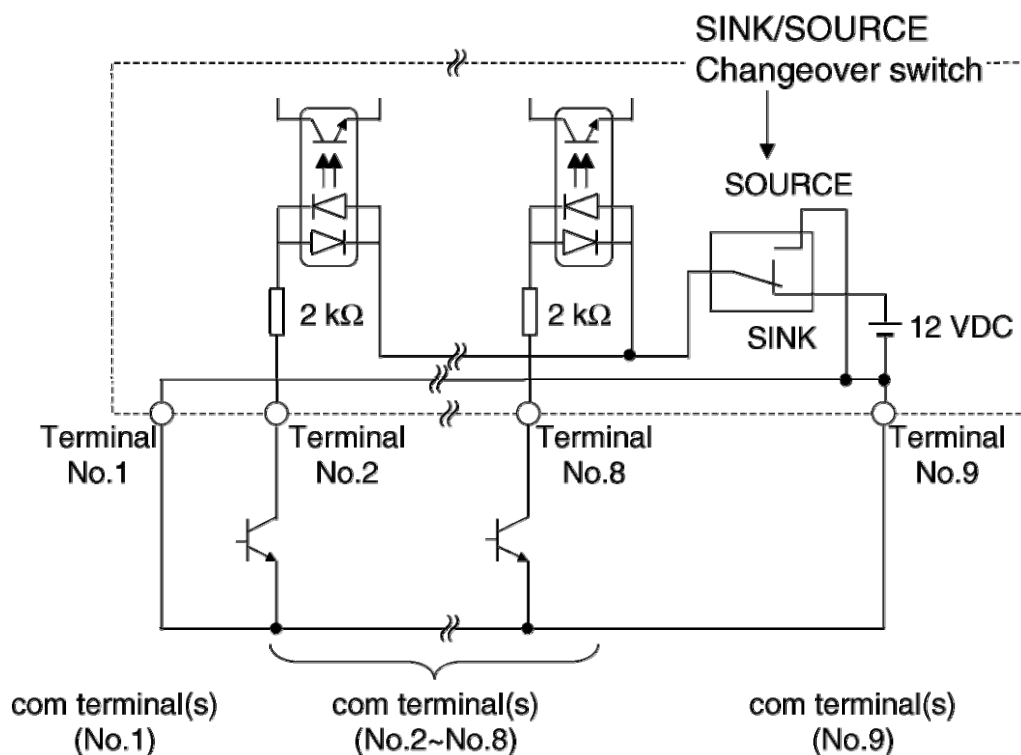



### 3. Wiring

Wiring diagram and precautions for source input setting

- Set the changeover switch to "SOURCE" position.
- Supply +24V power to each input terminal.

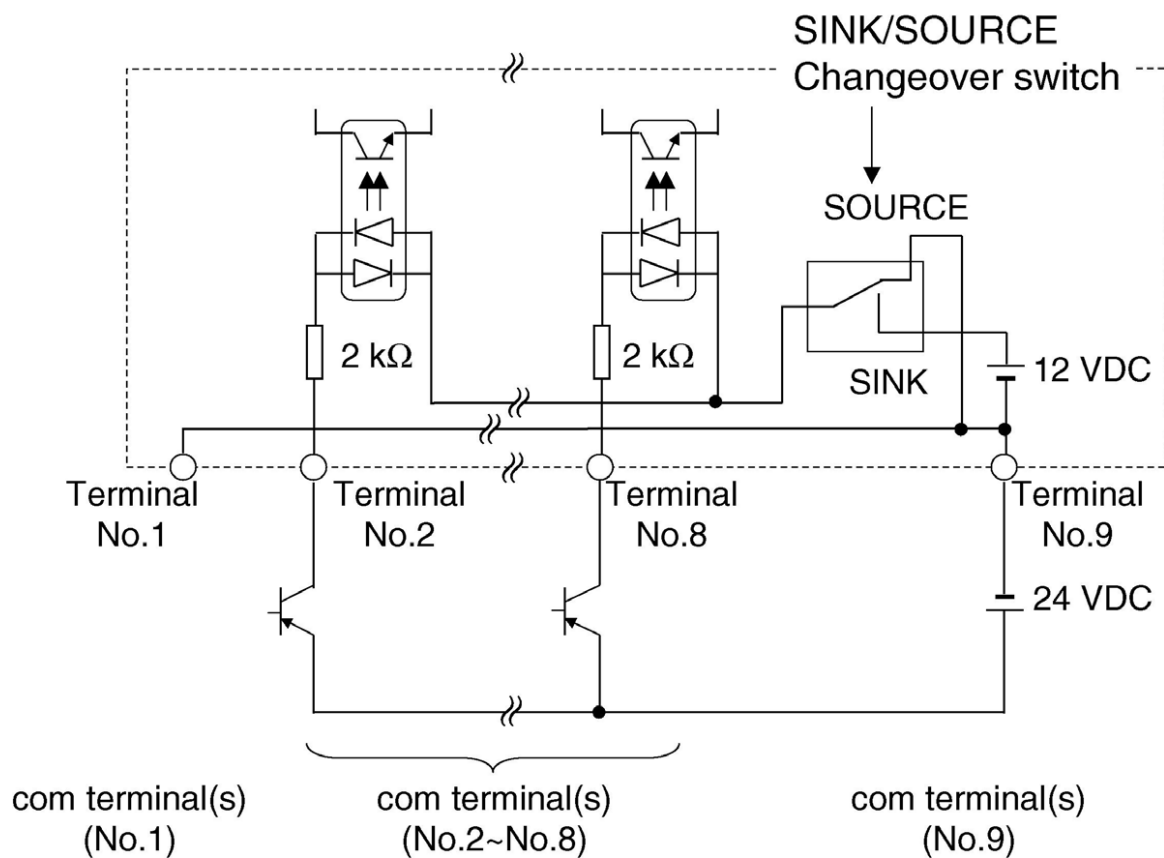

### ■ Wiring for PWM/Pulse input controlled Operating Frequency Mode (Terminal No.7, 8)

- When parameter P087 is set to "1", the operating frequency will be controlled by external PWM signal from PLC, etc.
- When parameter P087 is set to "2", the operating frequency will be controlled by external pulse signal from PLC, etc.
- Terminal No.7 is the input terminal for changeover of frequency setting signal (SW4) (OFF: PWM/Pulse input signal, ON: controlled by the signal set in parameter P004), while terminal No.8 is the input terminal for PWM/Pulse input signal .
- As for the transistor for PWM/Pulse input signal, please use one with maximum voltage rating over 50 V and maximum current rating over 50 mA.
- In addition, to use PWM signal for operating frequency control, relevant settings must be made to parameter P088 and P089.
- Use pulse signal for operating frequency control, relevant settings must be made to parameter P174.
- When setting value is "1" or "2", the SW function for SW4 (terminal No.7) and SW5 (terminal No.8) will be forced to be used for controlling PWM/pulse signal only.

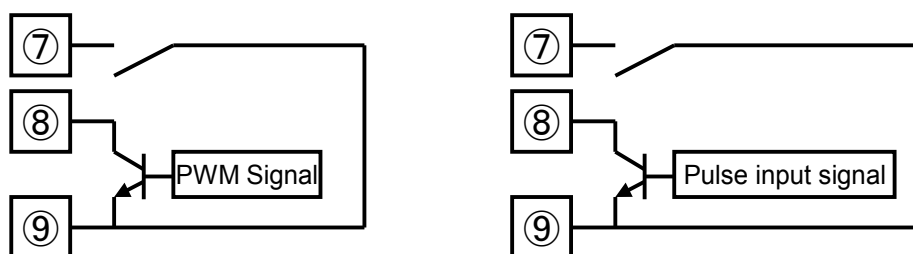

### ■ Wiring for Open-collector Output Terminals (Terminal No.10 to 12)

- When using open-collector output terminals to drive inductive loads, always connect a freewheel diode.

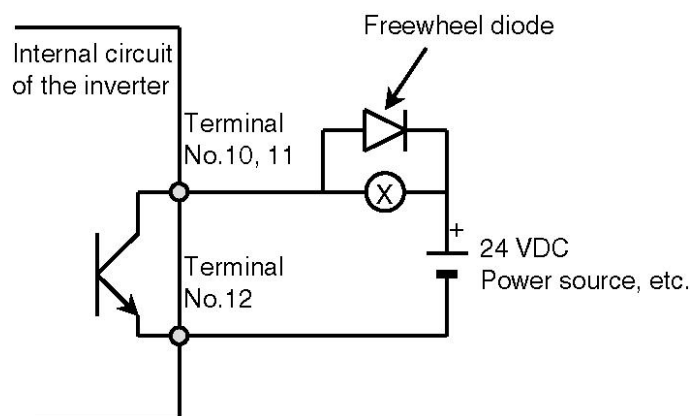

### 3. Wiring

#### ■ Wiring for Analog Signal Terminals (Terminal No.13 to 16, 24)

- When parameter P004 is set to “2”, frequency setting will be made through external potentiometer.
- When using external potentiometer for frequency setting, select a potentiometer of “10 k $\Omega$ , 1/4 W or higher” rating.
- When parameter P004 is set to “5” (4 to 20 mA) or “6” (0 to 20 mA), frequency setting will be made through analog current signal.
- When using analog current signal (4 to 20 mA, 0 to 20 mA) for frequency setting, connect a resistor of “200  $\Omega$ , 1/4 W” rating. (Failure to do so may damage the inverter.)
- If the unit version is Ver3.0 or later, a built-in 200  $\Omega$  resistor should be set between terminal No.24 and COM. If analog input signal of 4 to 20 mA / 0 to 20 mA is used, external resistor connection can be eliminated by connecting terminal No.24 to No.14 or No.16.

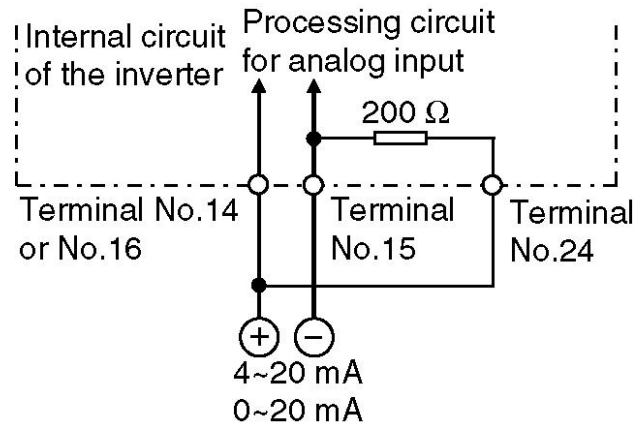

#### ■ Wiring for RS485 Communication Terminals (Terminal No.19 to 23)

The following figure shows the terminals used when connection is made between PC and PLC via RS485 communication lines.

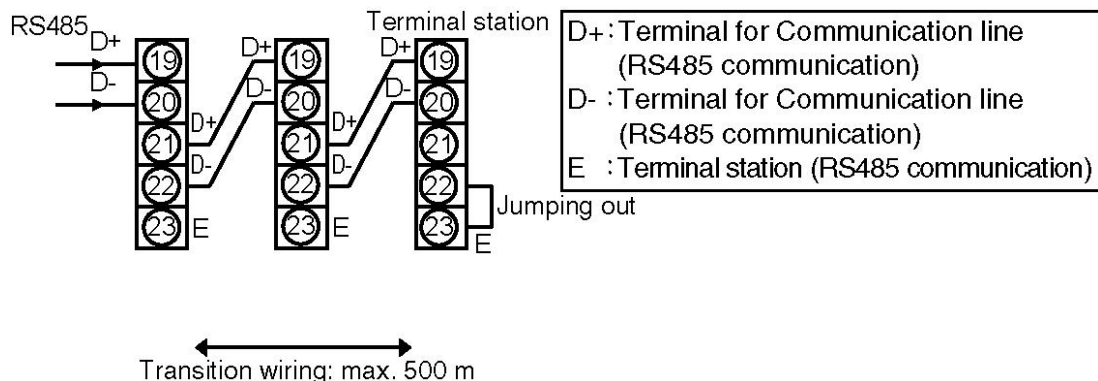

- As for communication cable, use a shielded twisted-pair cable and separate it from power lines or high-voltage circuits (20 cm or more).
- The total wiring length of the communication cables must not exceed 500 m.
- Connect the communication terminals “D+” to “D+” and “D-” to “D-”.
- Jump out the terminal “D-” and “E” of the inverter used as terminal station. Jumping is not allowed for any other device.





# 4

## Operation Method (Basic Operation)

4.1 Safety Precautions .....	44
4.2 Description of Operation Panel/Simple Panel .....	45
4.3 Operation Modes .....	47
4.4 Type of Operation Method .....	50
4.5 Setting Frequency with Operation Panel.....	51
4.6 Setting Forward/Reverse Run with Operation Panel ....	52
4.7 Operating with Operation Panel .....	54

## 4.1 Safety Precautions

---

 <b>Danger</b>	<ul style="list-style-type: none"><li>• Always close the terminal cover before turning ON the inlet power.</li><li>• Do not open the terminal cover while the power is ON. Failure to do so may result in an electric shock or fire.</li><li>• Do not operate the switches or dials with wet hands. Failure to do so may result in an electric shock.</li><li>• Do not touch the inverter terminals when the inverter power is ON or even when the inverter is stopped. Failure to do so may result in an electric shock.</li><li>• The STOP button is not designed for emergency stop purpose, so set a separate button for emergency stop. Failure to do so may result in injury.</li></ul>
 <b>Caution</b>	<ul style="list-style-type: none"><li>• The heat sinks and braking resistors are at high temperature, so do not touch them. Failure to do so could lead to burn.</li><li>• The inverter can easily be switched to high speed from low speed, so confirm the allowable range of the motor and machine before making settings. Failure to do so could lead to injury.</li><li>• Set separate holding brakes if required. Failure to do so could lead to injury.</li><li>• Before turning on the power, check the following points again.<ol style="list-style-type: none"><li>1. Check if all wirings are correct or not again. Reversed wirings between power supply and load in particular could damage the inverter.</li><li>2. Check if the voltage rating of the inverter matches with power supply.</li><li>3. Check if a phase-lead capacitor is connected to the motor. Connection of phase-lead capacitor could result in faults to the inverter and capacitor.</li><li>4. Confirm the set frequency before starting a trial operation.</li></ol></li></ul>

## 4.2 Description of Operation Panel/Simple Panel

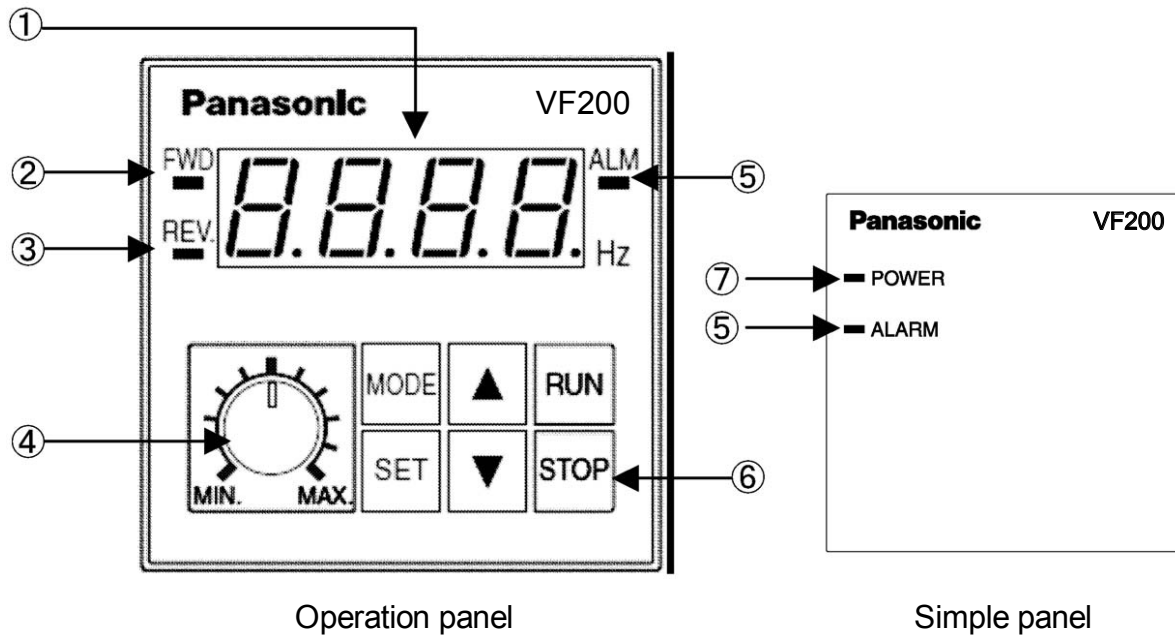

	Component name	Details of function
①	Display part	For displaying output frequency, current, linear speed, set frequency, communication station No., error details, each mode indication and function setting data
②	FWD indicator (green)	For indicating forward run (ON during constant-speed running/Flickering during acceleration/deceleration running)
③	REV indicator (green)	For indicating reverse run (ON during constant-speed running/Flickering during acceleration/deceleration running)
④	Potentiometer on the panel	A potentiometer dial on operation panel for setting the operating frequency.
⑤	Alarm (ALM) indicator (red)	For indicating abnormality and alarms. (Refer to P100: Alarm LED Operation Select)















#### 4. Operation Method (Basic Operation)

---

	Component name	Details of function
⑥	RUN button	A button for making inverter running
	STOP button	A button for making inverter stopping
	MODE button	A button for switching various modes (such as “operation status display”, “frequency setting and monitor”, “rotation direction setting”, “control state monitor”, “custom”, “function setting” and “built-in memory setting”), and switching data display to mode display
	SET button	A key for switching between mode display and data display and saving the data. In “operation status display mode”, it is used for the switching between frequency display and current display.
	▲ (UP) button	It is used to change data and output frequency, and to set forward run direction when carrying out forward run with operation panel.
	▼ (DOWN) button	For changing data and output frequency, and for setting reverse run direction during reverse run made with operation panel.
⑦	POWER LED	Lighting up when the inverter power is turned ON.

## 4.3 Operation Modes

### ■ Functions of Operation Modes

Mode	Description	Panel display content	
① Operation status display mode	For displaying output frequency and output current		
② Frequency setting mode	For digital setting of frequency and frequency command monitoring		
③ Rotation direction setting mode	For rotation direction setting of panel operation and control status (operation panel/external control/communication) monitoring		 <small>Run command status Rotation direction</small>
④ Control status monitoring mode	For monitoring of control status and abnormality		
⑤ Custom mode	For registering up to 10 frequently-used parameters, changing and monitoring data		
⑥ Function setting mode	For changing and monitoring parameter data as well as using copy function of parameter data		
⑦ Built-in memory setting mode	For changing set data in built-in memory of operation panel (Option: Display/ Conceal)		

### ■ Switching of Operation Modes

- Press MODE button to switch various modes in order.
- In each mode, if SET button is pressed, data monitoring or changing function will be enabled; and if MODE button is pressed, it will return to the previous display status. Therefore, if SET button is pressed by mistake, just press MODE button to return to the previous display status.

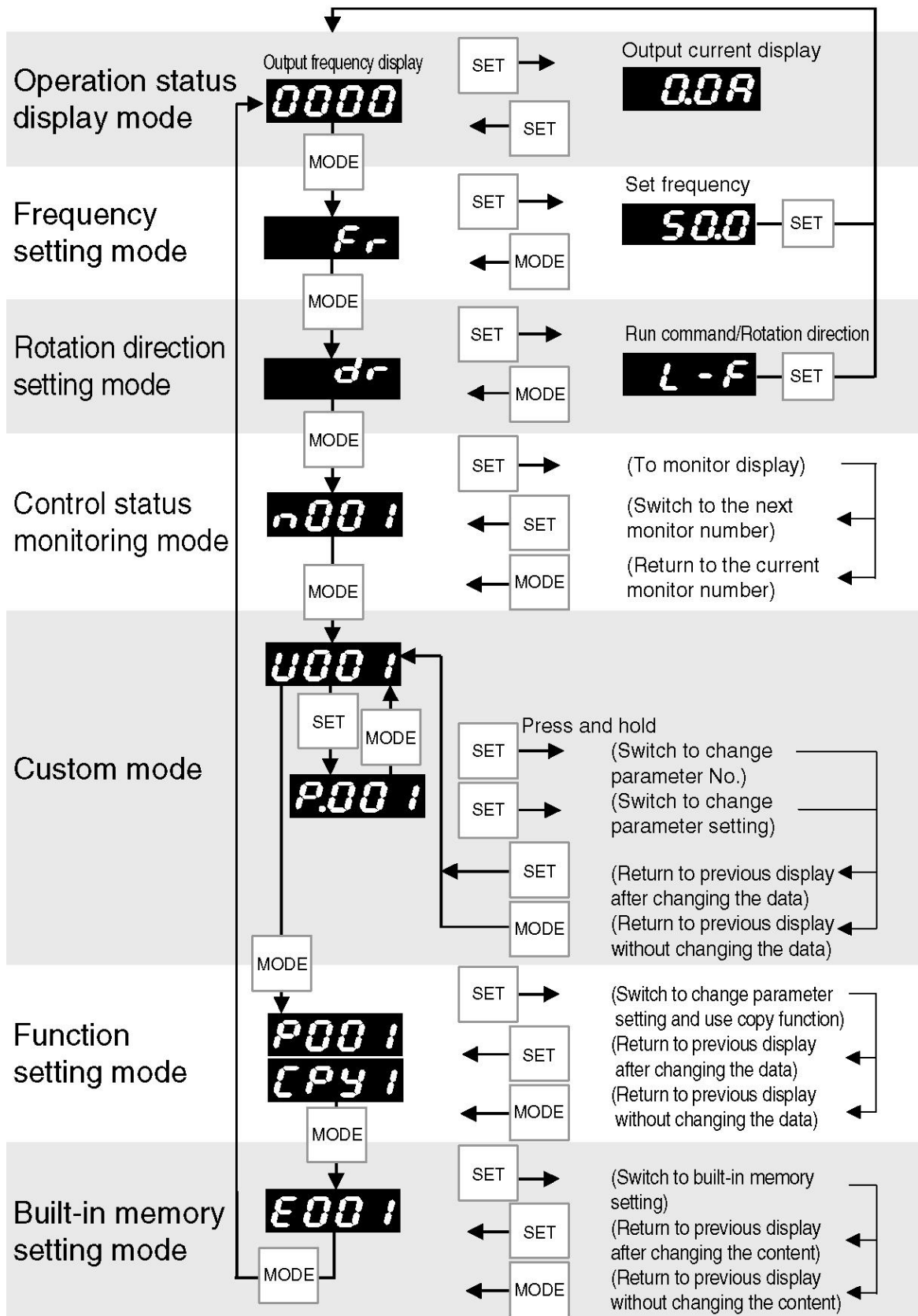

## 4.4 Type of Operation Method

---

There are 3 methods to operate VF200 as follows.

1. Operation panel

Making inverter operation by using buttons and potentiometer on operation panel.

2. External control

Making inverter operation by using control circuit terminals. (Refer to P.142.)

3. Communication (RS485)

Making inverter operation by using commands sent from host computer or host PLC.

(Refer to P.142 and P.254.)

For details of communication functions, please refer to “VF200 communication function manual”, which can be downloaded from our website:  
<http://device.panasonic.cn/ac/c>

## 4.5 Setting Frequency with Operation Panel

---

There are 2 modes to set frequency with operation panel as follows.

- Potentiometer Setting Mode (Parameter P004 is set to “0”: factory setting.)

Adjust the position of potentiometer dial on operation panel to make setting.

MIN. position stands for operation stop (0V stop: see parameter P101), while

MAX. position for the maximum frequency.

- Digital Setting Mode (Parameter P004 is set to “1”.)

Press MODE button on the panel to enter frequency setting mode (display: Fr);

press SET button and display the frequency to be set by pressing UP and DOWN

buttons and then press SET button again to complete the setting. Also, the

following “MOP function” can be used for frequency setting during operation.

### MOP function

The frequency can be changed by pressing and holding UP or DOWN button during operation. However, if parameter P003 is set to “1”, this function does not work.

The operation will vary according to the settings of “Parameters” P154: MOP Function Select” and “P155: MOP Operation Acceleration/Deceleration Time”.

## 4.6 Setting Forward/Reverse Run with Operation Panel

There are 2 modes to set forward/reverse run with operation panel as follows.

■ **Forward/Reverse Run Button Operation Mode** (Parameter P003 is set to “1”.)

Press UP (forward run) button or DOWN (reverse run) button on the panel to select the rotation direction. Then press RUN button to start operation.

\* The inverter will not run just by pressing RUN button.

\* The “MOP function” cannot be used if frequency setting is made in “Digital Setting Mode”.

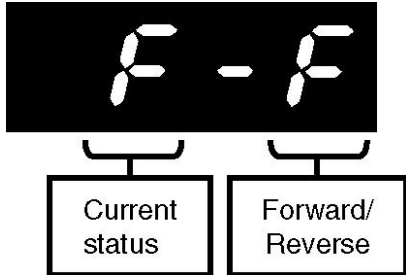

Current status	Display	Rotation direction	Display
During stop	O	Forward run	F
During forward run	F	Reverse run	r
During reverse run	r		

■ **Rotation Direction Setting Operation Mode** (Parameter P003 is set to “0”.)

In Operation Status Display Mode, press MODE button twice to enter Rotation Direction Setting Mode. Press SET button to display the rotation direction data, change the rotation direction with UP and DOWN buttons, and then press SET button again to apply the change. (The factory setting is “forward run”.)

Finally, press RUN button to start operation.

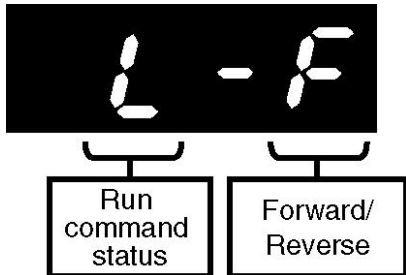

Run command	Display	Rotation direction	Display
Operation panel	L	Forward run	F
External control	E	Reverse run	r
Communication	C		

\* The relationship between operation modes and “MOP function” and “Rotation direction setting content”

Operation mode	MOP function	Rotation direction setting content
Forward/Reverse Run Button Operation Mode	× (unavailable)	Only monitoring function is available
Rotation Direction Setting Operation Mode	○ (available)	Both monitoring and direction setting function are available

### 【Note】

---

---

- When operation mode is set to Forward/Reverse Run Button Operation Mode, the MOP function cannot be used even if frequency setting is made in Digital Setting Mode.



## 4.7 Operating with Operation Panel

When the inverter is operated with operation panel, as shown in “4.5 Setting Frequency with Operation Panel” and “4.6 Setting Forward/Reverse Run with Operation Panel”, there are 4 combined modes by using parameters “P003: Run Command Select” and “P004: Frequency Setting Signal”.

This section will describe the four operation modes through specific examples.

		Parameter P004: “Frequency Setting Signal”	
		Setting value “0”	Setting value “1”
Parameter P003: “Run Command Select”	Setting value “0”	Operation mode 1	Operation mode 3
	Setting value “1”	Operation mode 2	Operation mode 4

### ■ Operation status when the panel is removed during operation

Sometimes OP trip will not occur if the operation panel is removed during operation.

Item	Conditions of OP trip occurrence	Conditions of OP trip non-occurrence
Setting values of “P003: Run Command Select” and “P004: Frequency Setting Signal”	P003 = 0 or 1 or P004 = 0	P003 is set to a value greater than “2” and P004 is set to a value greater than “1”.
Inverter operation status when the panel is removed during operation	Operation stops due to OP trip occurrence.	Operation continues.

## 4.7.1 Operating with Operation Panel - 1 (Factory Setting)

- Forward/reverse run function: Rotation Direction Setting Operation Mode”(Parameter P003 = 0)
- Frequency setting: Potentiometer Setting Mode (Parameter P004 = 0)

### ■ Operating Example ①: Forward run operation at operating frequency of 25 Hz

#### 1. Turn on the power.

The display part will be ON immediately after power-on.

(Operation Status Display Mode)

#### 2. Start operation.

Press  button.

The inverter enters operation status, but it can be only in 0V stop status due to the frequency setting dial is in the MIN. position.



#### 3. Adjust frequency.

Turn the frequency setting dial  clockwise slowly till the value “25.0” appears. The motor starts to run. The value “25.0” indicates that the motor is running at 25 Hz.

#### 4. Input stop command.

Press  button. The motor starts to decelerate till to stop.

## 4. Operation Method (Basic Operation)

---

### ■ Operating Example ②: Reverse run operation at operating frequency of 25 Hz

#### 1. Turn on the power.

The display part will be ON immediately after power-on.



(Operation Status Display Mode)

#### 2. Change rotation direction.

Press **MODE** button twice successively.



Press **SET** button. (The display part is flickering.)



Press  button. (The display part is flickering.)



Press **SET** button to set data.



(Return to Operation Status Display Mode.)

#### 3. Start operation.

Press **RUN** button. The inverter enters operation status, but it can be only in 0V stop status due to the frequency setting dial is in the MIN. position.



#### 4. Adjust frequency.

Turn the frequency setting dial  clockwise slowly till the value “25.0” appears. The motor starts to run. The value “25.0” indicates that the motor is running at 25 Hz.



#### 5. Input stop command.

Press **STOP** button. The motor starts to decelerate till to stop.



### ■ Operating Example ③: Changing rotation direction during operation

The operations are the same as “Changing rotation direction” shown in the above example. But in this case, as the SET button is pressed in the final procedure, the display will be switched to Operation Status Display Mode and the motor will rotate in reverse direction with deceleration.

## 4.7.2 Operating with Operation Panel - 2

- Forward/reverse run function: Forward/Reverse Run Button Operation Mode (Parameter P003 = 1)
- Frequency setting: Potentiometer Setting Mode (Parameter P004 = 0)

### ■ Operating Example ①: Forward run operation at operating frequency of 25 Hz

#### 1. Turn on the power.

The display part will be ON immediately after power-on.

(Operation Status Display Mode)

#### 2. Set rotation direction.

Press  button to select forward run.

(Press  button to select reverse run.)

#### 3. Start operation.

Press  button.

The inverter enters running status, but it can be only in 0V stop status due to the frequency setting dial is in the MIN. position.

#### 4. Adjust frequency.

Turn the frequency setting dial  clockwise slowly till the motor starts to run. The value “25.0” indicates that the motor is running at 25 Hz.

#### 5. Input stop command.

Press  button. The motor starts to decelerate till to stop.

## 4. Operation Method (Basic Operation)

---

### ■ Operating Example ②: Monitoring and setting potentiometer frequency

command before operation

#### 1. Turn on the power.

The display part will be ON immediately after power-on.



(Operation Status Display Mode)

#### 2. Confirm and set operating frequency.

Press  button.



Press  button to confirm frequency command.



Turn the frequency setting dial  clockwise, and set frequency command to 25 Hz.



Press  button to set operating frequency.



#### 3. Set rotation direction.

Press  button to select forward run.



(Press  button to select reverse run.)

#### 4. Start operation.

Press  button. The motor starts to run. The value "25.0" indicates that the motor is running at 25 Hz.





#### 5. Switch forward run to reverse run during operation.

Press  button.



#### 6. Start operation.

Press  button. The motor gradually decelerates and starts reverse run operation at 25 Hz again.

Forward 

↓ 

Reverse 

7. Stop operation.

Press  button. The motor starts to decelerate till to stop.



#### 4. Operation Method (Basic Operation)

---

##### ■ Operating Example ③: Cancelling rotation direction setting

To cancel the setting, press  /  button again after using them to set the rotation direction.

During forward run operation at 25 Hz



1. Set rotation direction.

Press  button to select reverse run.



2. Cancel the setting.

Press  button.



The display is switched to “operation status” from “rotation direction” and the setting is cancelled.

#### 【Note】

---

---

- When the inverter is stopped, you may also use the same procedure as above to cancel the setting.
- If RUN button is not pressed after rotation direction setting, the actual rotation direction will not change.

### 4.7.3 Operating with Operation Panel - 3

- Forward/reverse run function: Rotation Direction Setting Operation Mode (Parameter P003 = 0)
- Frequency setting: Digital Setting Mode (Parameter P004 = 1)

#### ■ Operating Example ①: Forward run operation at operating frequency of 25 Hz

##### 1. Turn on the power.

The display part will be ON immediately after power-on.

(Operation Status Display Mode)

##### 2. Set operating frequency.

Press button.

Press button. (The display part is flickering.)

Press / button to make value “25.0 (Hz)” appear on the display. (The display part is flickering.)

Press button to set the changed value and return to operation status mode.

##### 3. Start operation.

Press button.

Since the factory setting is forward run, the motor will start to rotate clockwise at 25.0 Hz.





## 4. Operation Method (Basic Operation)

---

4. Set operating frequency (forward run operation at operating frequency of 50 Hz).

Press  button. (The display part is flickering.)

Press  button. (The display part is flickering.)

Press  /  button to make value "50.0 (Hz)" appear on the display. (The display part is flickering.)

Press  button to make acceleration till to 50 Hz.



5. Stop operation.

Press  button. The motor starts to decelerate till to stop.



6. Change rotation direction (reverse run operation at operating frequency of 50 Hz).

Press  button twice successively.

Press  button. (The display part is flickering.)

Press  button. (The display part is flickering.)

Press  button. (Return to Operation Status Display Mode.)



7. Start operation.

Press  button.





Since the frequency has been set to 50 Hz, the motor will start to rotate counterclockwise at 50.0 Hz.

8. Switch reverse run to forward run during operation.

Press  button twice successively.

Press  button.(The display part is flickering.)

Press  button.(The display part is flickering.)

Press  button. The motor gradually decelerates and starts forward run operation at 50 Hz again.

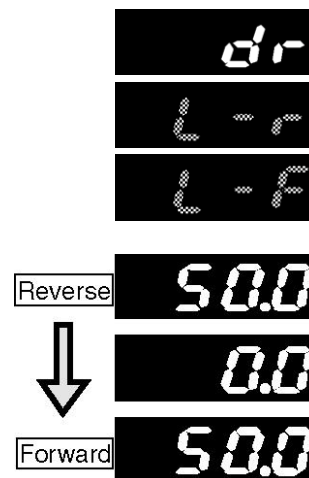



9. Stop operation.



Press  button. The motor starts to decelerate till to stop.





#### 4. Operation Method (Basic Operation)

---

■ Operating Example ②: Changing frequency by using  /  button during operation (MOP function)

Press  /  button to change operating frequency during operation. The motor will accelerate or decelerate according to such operation.

Operating frequency will rise when  button is kept on pressed.

Operating frequency will drop when  button is kept on pressed.

#### **【Note】**

---

- Once operating frequency is determined, press MODE button to display frequency setting mode “Fr” and then press SET button twice to set operating frequency.

If the above setting is not made, the frequency will not be saved when the power is OFF. The operation status will vary depending on the settings of parameters “P154: MOP Function Select” and “P155: MOP Operation Acceleration/Deceleration Time”.

## 4.7.4 Operating with Operation Panel - 4

- Forward/reverse run function: Forward/Reverse Run Button Operation Mode (Parameter P003 = 1)
- Frequency setting: Digital Setting Mode (Parameter P004 = 1)

### ■ Operating Example: Forward run operation at operating frequency of 25 Hz

#### 1. Turn on the power.

The display part will be ON immediately after power-on.

(Operation Status Display Mode)

#### 2. Set operating frequency.

Press button.

Press button. (The display part is flickering.)

Press / button to make value "25.0 (Hz)" appear on the display. (The display part is flickering.)

Press button to set the data.

#### 3. Set rotation direction.

Press button to select forward run.

(Press button to select reverse run.)

#### 4. Start operation.

Press button.

The motor starts to rotate clockwise at 25 Hz.

#### 4. Operation Method (Basic Operation)

---

##### 5. Start forward run operation at operating frequency of 50



Hz.

Press  button.



Press  button. (The display part is flickering.)



Press  /  button to make value "50.0 (Hz)" appear on the display. (The display part is flickering.)



Press  button to set operating frequency.



##### 6. Stop operation.

Press  button. The motor starts to decelerate till to stop.



##### 7. Start reverse run operation at operating frequency of 50

Hz.

Press  button to select reverse run.



##### 8. Start operation.

Press  button.



Since the frequency has been set to 50 Hz, the motor will start to rotate counterclockwise at 50.0 Hz.

##### 9. Switch reverse run to forward run during operation.

Press  button to select forward run.



##### 10. Start operation.

Press  button.

Reverse 



The motor gradually decelerates and starts forward run operation at 50 Hz again.

Forward 

11. Stop operation.

Press  button. The motor starts to decelerate till to stop.



**【Note】**

---

- The rotation direction cannot be set in “rotation direction setting mode (dr)”. The mode can only monitor the operation panel/external control/communication controlling rotation direction and operation status.
- The MOP function cannot be used.

## 4. Operation Method (Basic Operation)

---

# 5

## Control Status Monitor

5.1 List of Control Status Monitor Items.....	70
5.2 Introduction of Monitor No.....	72



## 5.1 List of Control Status Monitor Items

The 23 items listed below can be monitored in control status monitor mode.

Monitor No.	Monitor item	Unit	Indication
n001	Output frequency	Hz	Output frequency
n002	Output current	A	Output current
n003	Output voltage	VAC	Output voltage
n004	Internal DC voltage	VDC	Internal DC voltage
n005	Set frequency	Hz	Frequency setting
n006	Communication station No.	—	Current setting of communication station No.
n007	Operation times of timer	Times	Continuous operation times of timer in one cycle
n008	Alarm type	—	Indication of alarm LED
n009	Control circuit terminal status (input signal)	—	Input signal status of control circuit terminals
n010	Control circuit terminal status (output signal)	—	Output signal status of control circuit terminals
n011	Operation status monitor	—	Operation status of inverter
n012	Operation control status monitor	—	Operation control status of inverter
n013	Terminal function status monitor	—	Function status of control circuit terminals in inverter
n014	PID setting value (SP)	%	Setting value (SP) of PID control
n015	PID measured value (PV)	%	Measured value (PV) of PID control
n016	PID output value (MV)	%	Output value (MV) of PID control
n017	Progress of automatic tuning	—	Progress of automatic tuning during PID control
n018	Accumulative operation time	—	Accumulative operation time of inverter
n019	Accumulative operation time of fan	—	Accumulative operation time of inverter fan
n020	Abnormality display 1 (latest)	—	Details of the latest abnormality
n021	Abnormality display 2 (second to latest)	—	Details of abnormality from second to latest
n022	Abnormality display 3 (third to latest)	—	Details of abnormality from third to latest

n023	Abnormality display 4 (fourth to latest)	—	Details of abnormality from fourth to latest
n024	Unit version *	—	Firmware version of VF200 unit
n025	Panel version *	—	Firmware version of operation panel
n026	Detection value for pulse input signal	Hz	Detect frequency value based on pulse input signal
n027	Winding length	m	Current winding length

## 5.2 Introduction of Monitor No.

---

### **n001** Output frequency

For displaying output frequency of inverter. When the inverter is stopped, “0.0” is displayed.

### **n002** Output Current

### **n003** Output Voltage

### **n004** Internal DC Voltage

For displaying output current, output voltage and internal DC voltage of inverter. The indications are just reference values instead of accurate values for precision measurement.

(If you need accurate values, use other measuring instrument.)

### **n005** Set Frequency

For displaying set frequency of inverter.

### **n006** Communication Station No.

For displaying set communication station number.

The communication station No. can be set with “P136: Communication Station No. Setting”.

### **n007** Operation Times of Timer

For displaying operation times of timer in one cycle during multi-speed operation of timer, acceleration/deceleration linking operation of timer, multi-speed operation of pulse input and acceleration and deceleration linking operation of pulse input. When a cycle starts, the operation times will be counted up. When each operation ends and the next run command is input, the counted times will be cleared.

Operation times of timer can be set with “P068: Timer Operation Times”.

## n008 Alarm Type

For displaying different alarm LED contents.

Alarm type	Indication
Normal	none
Abnormal output voltage alarm	ALOU
Overload alarm	ALOC
Abnormal temperature alarm	ALOH
Abnormal cooling fan alarm	ALFn
Timer stop signal	tEnd

Note) 1. When “Alarm LED Operation Select” (parameter P147) is set to “1”.  
When various alarms occur simultaneously, the display priority is as follows. (If a higher-priority alarm is in displaying, it will still exist exclusively even if a lower-priority alarm enters.)

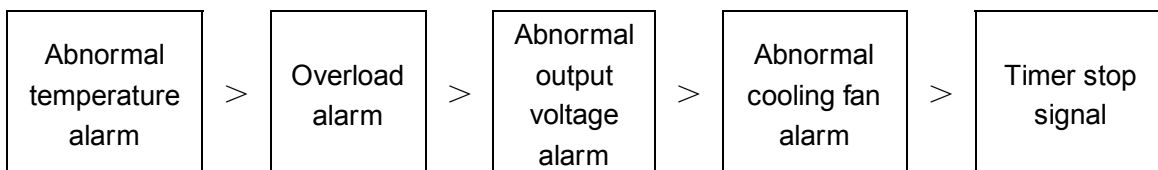

**n009** Control Circuit Terminal Status (Input Signal)

**n010** Control Circuit Terminal Status (Output Signal)

For displaying various status of input and output signals of control circuit terminals.

When input terminals (② to ⑧) and common terminal (① or ⑨) are turned ON, segment a1 to g1 light up; when input terminals (② to ⑧) and common terminal (① or ⑨) are turned OFF, segment a1 to g1 light out.

When output terminals are closed (ON) between ⑩ to ⑫ and ⑪ to ⑫, segment a1 and b1 of n010 light up; when output terminals are opened (OFF) between ⑩ to ⑫ and ⑪ to ⑫, segment a1 and b1 of n010 light out.

Segment c1 lights up when the output terminal is ON (Excitation in ON status: short circuit across A-C; non-excitation in ON status: short circuit across B-C); segment c1 lights out when the output terminal is OFF (Excitation in ON status: open circuit across B-C; non-excitation in ON status: open circuit across A-C).

Monitor No.	I/O signal	LED segment indication		
		Terminal indication	Signal ON	Signal OFF
n009	Run/stop	"a" lights up	"a1" lights up	"a1" lights out
	Forward/reverse run	"b" lights up	"b1" lights up	"b1" lights out
	SW1	"c" lights up	"c1" lights up	"c1" lights out
	SW2	"d" lights up	"d1" lights up	"d1" lights out
	SW3	"e" lights up	"e1" lights up	"e1" lights out
	SW4	"f" lights up	"f1" lights up	"f1" lights out
	SW5	"g" lights up	"g1" lights up	"g1" lights out
n010	Open-collector 1	"a" lights up	"a1" lights up	"a1" lights out
	Open-collector 2	"b" lights up	"b1" lights up	"b1" lights out
	Relay	"c" lights up	"c1" lights up	"c1" lights out

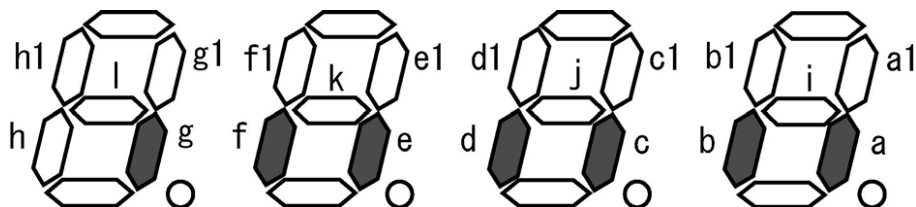

## n011 Operation Status Monitor

For displaying operation status of inverter. Each LED segment lights up and out depending on details shown in the following table.

Normally, segment i to l light up.

Monitor No.	Operation status	LED segment indication	
		Details of lighting up	Details of lighting out
n011	Operation status	Run	Stop
		"a" lights up	"a" lights out
	Reverse run status	Reverse run	Stop or forward run
		"b" lights up	"b" lights out
	Arrival signal	ON	OFF
		"c" lights up	"c" lights out
	Overload signal	ON	OFF
		"d" lights up	"d" lights out
	Frequency detection (parameter P093)	ON	OFF
		"e" lights up	"e" lights out
	Frequency detection (parameter P094)	ON	OFF
		"f" lights up	"f" lights out
	Current signal detect (upper limit)	ON	OFF
		"g" lights up	"g" lights out
	Current signal detection (lower limit)	ON	OFF
		"h" lights up	"h" lights out
	PID automatic tuning function	PID automatic tuning status	Normal operation status
		"a1" lights up	"a1" lights out
	Timer operation function	Timer operation status	Normal operation status
		"b1" lights up	"b1" lights out
Motor constant automatic tuning function	Motor constant automatic tuning status	Normal operation status	
	"c1" lights up	"c1" lights out	
Abnormality status	Abnormal	Normal	
	"d1" lights up	"d1" lights out	
Speed search function	Speed search status	Normal operation status	
	"e1" lights up	"e1" lights out	
Winding mode control	Winding mode control status	Normal operation status	
	"f1" lights up	"f1" lights out	

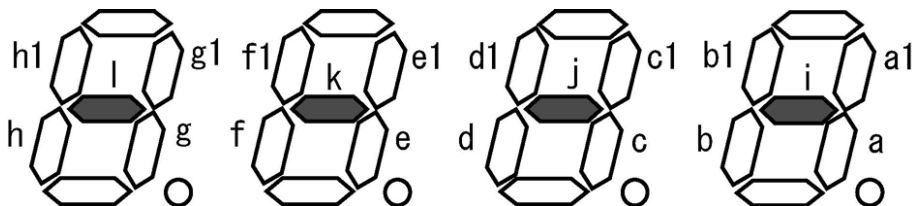

**n012** Operation Control Status Monitor

For displaying operation control status of inverter. Each LED segment lights up and out depending on details shown in the following table. Normally, segment i to l light up.

When command status is "Timer in Operation" and parameter P45 (Multi-speed Function Setting) is set to "3" or "4", relevant segment lights up if operation command is input.

When command status is "Pulse Input in Operation" and parameter P45 (Multi-speed Function Setting) is set to "5" or "6", relevant segment lights up if operation command is input.

Monitor No.	Command status	LED segment indication	
		1: with command	0: without command
n012	Run command status	"a" lights up	"a" lights out
	Reverse run command status	"b" lights up	"b" lights out
	SW1 command status	"c" lights up	"c" lights out
	SW2 command status	"d" lights up	"d" lights out
	SW3 command status	"e" lights up	"e" lights out
	SW4 command status	"f" lights up	"f" lights out
	SW5 command status	"g" lights up	"g" lights out
	Timer in operation	"h" lights up	"h" lights out
	Pulse input in operation	"a1" lights up	"a1" lights out

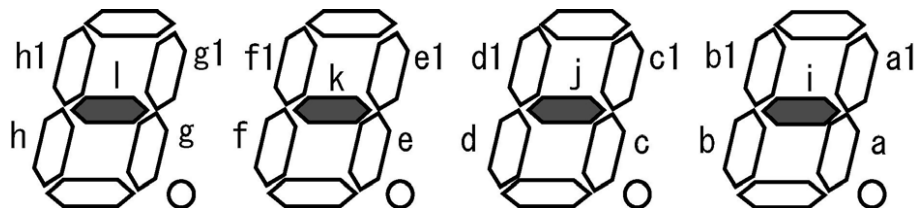

## n013 Terminal Function Status Monitor

For displaying function status of control circuit terminals. Each LED segment lights up and out depending on details shown in the following table. Normally, segment i to I light up.

Monitor No.	Command status	LED segment indication	
		1: with command	0: without command
n013	Multi-speed function	“a” lights up	“a” lights out
	Parameter setting disable function	“b” lights up	“b” lights out
	Reset input function	“c” lights up	“c” lights out
	Reset lock function	“d” lights up	“d” lights out
	JOG function	“e” lights up	“e” lights out
	Abnormal stop function from external	“f” lights up	“f” lights out
	Coast-to-stop function	“g” lights up	“g” lights out
	Frequency signal switching function	“h” lights up	“h” lights out
	The 2 <sup>nd</sup> characteristics select function	“a1” lights up	“a1” lights out
	PID control switching function	“b1” lights up	“b1” lights out
	3-wire stop command function	“c1” lights up	“c1” lights out
	Frequency ▲(UP) / ▼(DOWN) setting function	“d1” lights up	“d1” lights out
	PWM frequency signal select function	“e1” lights up	“e1” lights out
	Pulse counter input function	“f1” lights up	“f1” lights out
	Speed search function	“g1” lights up	“g1” lights out
	Winding mode pause function	“h1” lights up	“h1” lights out



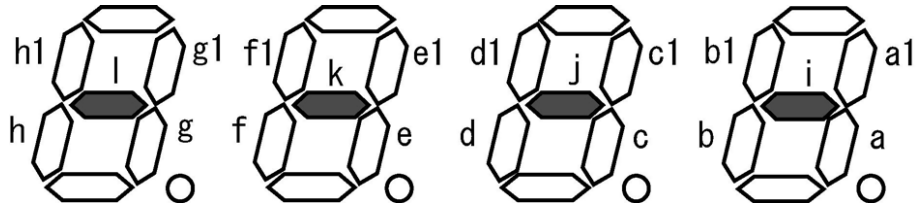

**n014** PID Setting Value (SP)

**n015** PID Measured Value (PV)

**n016** PID Output Value (MV)

---

For displaying setting value (SP), measured value (PV) and output value (MV) under PID control. The unit is “%”.

**n017** Progress of Automatic Tuning

---

For showing progress of automatic tuning when automatic tuning is set with “P106: PID Control Mode”.

The initial value is “0” and “1” to “5” is displayed depending on the progress.

When automatic tuning completes, the display will return to initial value “0”.

“0” to “5”: measurement in progress; “6”: measurement completed (End); “7”: measurement stopped (Err)

**n018** Accumulative Operation Time

**n019** Accumulative Operation Time of Fan

---

“n018” shows the accumulative power-on time of inverter. “n019” shows the accumulative operation time of inverter cooling fan. “P143: Cooling Fan ON-OFF Control” is set to “1”: In synchronized operation, no counting will be executed when the cooling fan is stopped.

The basic display unit is “0.001” corresponding to 1 hour. The display increment is “0.01” corresponding to 10 hours for the time longer than 10.0; and “0.1” corresponding to 100 hours for the time longer than 100.0; and “1” corresponding to 1000 hours for the time longer than 1000.0.

As certain errors exist in the displayed values, they are just for your reference.

<b>n020</b>	Abnormality Display 1 (Latest)
<b>n021</b>	Abnormality Display 2 (Second to Latest)
<b>n022</b>	Abnormality Display 3 (Third to Latest)
<b>n023</b>	Abnormality Display 4 (Fourth to latest)

---

For showing abnormality information of inverter (latest, second to latest, third to latest and fourth to latest).

**n024** Unit Version

**n025** Panel Version

- They show the firmware versions of VF200 unit and operation panel.
- The model code and version code are shown as follows.



Model code (Hex value)      Version code (Retain 2 decimals)

About the version of VF200 unit and operation panel

- Operation status display varies depending on the combination of firmware version of VF200 unit and operation panel.

Combination of firmware versions	Operation
VF200 unit firmware version > operation panel firmware version (VF200 unit version Ver. 1.0X excluded)	“Er2” will be displayed on the operation panel. Press “↑” button to display VF200 unit firmware version. Press “↓” button to display the operation panel firmware version.
VF200 unit firmware version ≤ operation panel firmware version	The version will be displayed as shown in the above figure.

**n026** Pulse Input Signal Detection Value

- Display frequency detection value for pulse input signal of inverter.

**n027** Winding Length

- It is used for the calculate result for winding length of pulse input signal when the setting vale for "P036:SW1 Function Select" is 14.

- The calculate result of winding length is as follow.

$$\text{Winding Length} = \frac{(\text{pulse value input to SW1}) \times (\text{P181: Winding length radio})}{1000}$$

- The relation of winding and display is as follow.

When 1m to 9,999m, display as 1 to 9999.

When 10,000m to 99,999m, display as 10.00 to 9.999.

When 100,000m to 600,000m, display as 10.00 to 60.00.

- If set value of "P038:SW3 Function Select" as 14, the calculate value will be cleared when SW3 is ON.

# 6

## Function Parameters

6.1 Setting and Changing Function Parameters .....	8/
6.2 Function Parameter List .....	83

## 6.1 Setting and Changing Function Parameters

---















Parameters can be set and monitored in Custom Mode and Function Setting Mode. Be sure to change and set various function parameters in stop status. And note that some function parameters can be changed during operation.

### 6.1.1 Setting and Changing Function Parameters in Stop Status

---

#### Setting Example

Change the maximum output frequency from 50.0 Hz to 60.0 Hz (change setting value of parameter P008 from “50.0” to “60.0”).

1. Press  button to stop the inverter. 
2. Press  button five times to select Function Setting Mode.   
(If a password is set beforehand, please enter it. Refer to parameter P150.)
3. Press  button seven times to change parameter No. to “P008”. 
4. Press  button to display setting value of parameter P008.   
(The display part is flickering.)
5. Press  button to change the displayed value to “60”.   
(The display part is flickering.)
6. Press  button to apply the value. 
7. Press  button.   
(If the built-in memory setting mode is set to “conceal”, the inverter enters “operation ready” status.)

8. Press **MODE** button to enter “operation ready” status.

That’s to say, the inverter is in normal stop status and can be operated if required. (Operation Status Display Mode)



### 【Note】

- If data is written into the built-in non-volatile memory of inverter when setting and changing operation, it can be stored even if the power is cut off. The built-in non-volatile memory of inverter can be written up to 100,000 times. Therefore, do not change parameter settings frequently.
- If you change the parameters that cannot be set during operation when the operation signal is ON, “P.Err” will flicker in the display part first. And after 2 s, the display will return to parameter No. again. That’s to say, the inverter starts operation without changing the parameter.

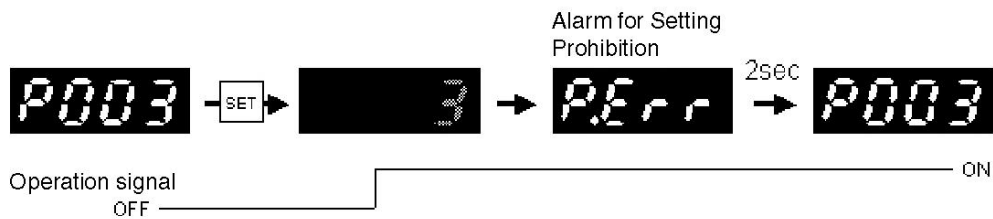

## 6.1.2 Setting and Changing Function Parameters During Operation

 <b>Danger</b>	<p>If data is changed during operation, the motor and motor load may suddenly start/stop for the great fluctuation. (Please take measures to ensure personal safety.)</p> <p>Failure to do so may result in injury.</p>
---	---

For function parameters that can be changed during operation, refer to items marked with “O” in “Changeable during Operation” of “6.2 Function Parameter List”.

### Setting Example

Change the 1<sup>st</sup> deceleration time from 5.0 s to 10.0 s (change setting value of parameter P002 from “5.0” to “10.0”)

Controlling motor with current data

1. Confirm operation status (For operation at 50.0 Hz).



2. Press  button five times to select Function Setting

Mode.



(If a password is set beforehand, please enter it. Refer to parameter P150.)

3. Press  button once to change parameter No. to “P002”.



4. Press  button to display setting value of parameter P002.







(The display part is flickering.)

5. Press  button to change the displayed value to “10.0”.



(The display part is flickering.)

## Controlling motor with new data

1. Press  button to set the value.
2. Press  button. (If the built-in memory setting mode is set to “conceal”, the inverter enters Operation Status Display Mode.)
3. Press  button to switch to Operation Status Display Mode.  
(If  button is not pressed, the display will not be switched.)

P003

E001

50.0

**【Note】**

• When “The 2<sup>nd</sup> to 16<sup>th</sup> Speed Frequency” of parameter P046 to P060 are set to “0000”, the inverter will enter 0V stop status.

If parameters “P103: Bias Frequency Setting” and “P126: The 2<sup>nd</sup> Bias Frequency Setting” are set to “0” or lower, the inverter will enter 0V stop status.

If parameters “P104: Gain Frequency Setting” and “P127: The 2<sup>nd</sup> Gain Frequency Setting” are set to “0000”, the inverter will enter 0V stop status. (The motor will start or stop when the data is changed or set to “0000”, so always ensure personal safety before operation.)

• If you monitor parameters that cannot be set during operation when the operation signal is OFF, the setting values will flicker and then become changeable.

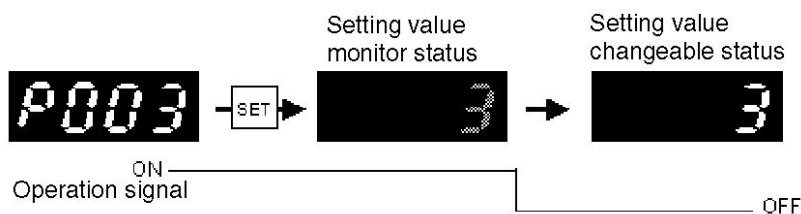



## 6.2 Function Parameter List

Function parameter list of inverter VF200 is as follows.

No.	Function name	Changeable during operation	Setting range	Unit	Initial value	Reference page
P001	The 1 <sup>st</sup> Acceleration Time	○	0000,0.1 to 3600	sec	5.0	P.140
P002	The 1 <sup>st</sup> Deceleration Time	○	0000,0.1 to 3600	sec	5.0	P.141
P003	Run Command Select		0 to 7	—	0	P.142
P004	Frequency Setting Signal		0 to 8	—	0	P.144
P005	V/F Mode		50-60-FF-3C-3C1~3C6	—	50	P.147
P006	V/F Curve		0-1	—	0	P.150
P007	Torque Boost	○*3	Auto-0 to 40	%	5 (1-phase) 4 (3-phase)	P.151
P008	Max. Output Frequency		50.0 to 400.0	Hz	50.0	P.153
P009	Base Frequency		45.0 to 400.0	Hz	50.0	P.153
P010	Change Point Frequency 1	○	0.5 to 400.0	Hz	0.5	P.154
P011	Change Point Voltage 1	○	0 to 100	%	00	P.154
P012	Change Point Frequency 2	○	0.5 to 400.0	Hz	0.5	P.154
P013	Change Point Voltage 2	○	0 to 100	%	0	P.154
P014	Max. Output Voltage		0 to 500	V	0	P.155
P015	S-shaped Acceleration/Deceleration Mode		0 to 2	—	0	P.156
P016	Electronic Thermal Select	○	0 to 3	—	2	P.157
P017	Thermal Current Setting	○	0.1 to 100.0	A	*1	P.157
P018	Overcurrent Stall Prevention Function	○	0 to 3	—	1	P.158
P019	Overvoltage Stall Prevention Function	○	0-1	—	1	P.159
P020	Current Limit Function	○	0 to 9.9	sec	0	P.160
P021	OCS Level	○	1 to 200	%	140	P.161
P022	Retry Function	○	0 to 3	—	0	P.162
P023	Retry Count	○	1 to 10	Times	1	P.162
P024	Start Mode		0 to 3	—	1	P.163

No.	Function name	Changeable during operation	Setting range	Unit	Initial value	Reference page
P025	Ride-through Restart Select		0 to 3	—	0	P.165
P026	Waiting Time	○	0.1 to 100.0	sec	0.1	P.167
P027	Reverse Run Lock		0-1	—	0	P.167
P028	Stop Mode		0-1	—	0	P.167
P029	Start Frequency	○	0.5 to 60.0	Hz	0.5	P.168
P030	Stop Frequency	○	0.5 to 60.0	Hz	0.5	P.168
P031	DC Brake Time	○	0 to 120.0	sec	0	P.169
P032	DC Brake Level	○	0 to 100	%	0	P.169
P033	Stop Frequency during Forward/Reverse Run Operation	○	0.5 to 60.0	Hz	0.5	P.170
P034	DC Brake Time during Forward/Reverse Run Operation	○	0 to 120.0	sec	0	P.170
P035	DC Brake Level during Forward/Reverse Run Operation	○	0 to 100	%	0	P.170
P036	SW1 Function Select		0 to 14	—	0	P.172
P037	SW2 Function Select		0 to 13	—	0	P.172
P038	SW3 Function Select		0 to 14	—	0	P.172
P039	SW4 Function Select		0 to 13	—	0	P.172
P040	SW5 Function Select		0 to 13	—	0	P.172
P041	Input Logic Setting		0 to 31	—	0	P.189
P042	JOG Frequency	○	0.5 to 400.0	Hz	10.0	P.190
P043	JOG Acceleration Time	○	0.0 to 3600	sec	5.0	P.190
P044	JOG Deceleration Time	○	0.0 to 3600	sec	5.0	P.190
P045	Multi-speed Function Select		0 to 6	—	0	P.191
P046	The 2 <sup>nd</sup> Speed Frequency	○	0000,0.5 to 400.0	Hz	5.0	P.204
P047	The 3 <sup>rd</sup> Speed Frequency	○	0000,0.5 to 400.0	Hz	10.0	P.204
P048	The 4 <sup>th</sup> Speed Frequency	○	0000,0.5 to 400.0	Hz	12.5	P.204

## 6. Function Parameters

No.	Function name	Changeable during operation	Setting range	Unit	Initial value	Reference page
P049	The 5 <sup>th</sup> Speed Frequency	○	0000,0.5 to 400.0	Hz	15.0	P.204
P050	The 6 <sup>th</sup> Speed Frequency	○	0000,0.5 to 400.0	Hz	17.5	P.204
P051	The 7 <sup>th</sup> Speed Frequency	○	0000,0.5 to 400.0	Hz	20.0	P.204
P052	The 8 <sup>th</sup> Speed Frequency	○	0000,0.5 to 400.0	Hz	22.5	P.204
P053	The 9 <sup>th</sup> Speed Frequency	○	0000,0.5 to 400.0	Hz	25.0	P.204
P054	The 10 <sup>th</sup> Speed Frequency	○	0000,0.5 to 400.0	Hz	27.5	P.204
P055	The 11 <sup>th</sup> Speed Frequency	○	0000,0.5 to 400.0	Hz	30.0	P.204
P056	The 12 <sup>th</sup> Speed Frequency	○	0000,0.5 to 400.0	Hz	32.5	P.204
P057	The 13 <sup>th</sup> Speed Frequency	○	0000,0.5 to 400.0	Hz	35.0	P.204
P058	The 14 <sup>th</sup> Speed Frequency	○	0000,0.5 to 400.0	Hz	40.0	P.204
P059	The 15 <sup>th</sup> Speed Frequency	○	0000,0.5 to 400.0	Hz	45.0	P.204
P060	The 16 <sup>th</sup> Speed Frequency	○	0000,0.5 to 400.0	Hz	50.0	P.204
P061	The 2 <sup>nd</sup> Acceleration Time	○	0.1 to 3600	sec	5.0	P.204
P062	The 2 <sup>nd</sup> Deceleration Time	○	0.1 to 3600	sec	5.0	P.204
P063	The 3 <sup>rd</sup> Acceleration Time	○	0.1 to 3600	sec	5.0	P.204
P064	The 3 <sup>rd</sup> Deceleration Time	○	0.1 to 3600	sec	5.0	P.204
P065	The 4 <sup>th</sup> Acceleration Time	○	0.1 to 3600	sec	5.0	P.204
P066	The 4 <sup>th</sup> Deceleration Time	○	0.1 to 3600	sec	5.0	P.204
P067	Rotation Direction of Timer Operation		0 to 255	—	0	P.205
P068	Continuous Operation Times of Timer	○	0000-1 to 9999	Times	1	P.206
P069	Continuous Operation Mode of Timer	○	0-1	—	0	P.206
P070	Continuous Waiting Time of Timer Operation	○	0000-0.1 to 6553	sec	0000	P.206
P071	The 1 <sup>st</sup> Speed Runtime	○	0000-0.1 to 6553	sec	0000	P.208

No.	Function name	Changeable during operation	Setting range	Unit	Initial value	Reference page
P072	The 2 <sup>nd</sup> Speed Runtime	○	0000·0.1 to 6553	sec	0000	P.208
P073	The 3 <sup>rd</sup> Speed Runtime	○	0000·0.1 to 6553	sec	0000	P.208
P074	The 4 <sup>th</sup> Speed Runtime	○	0000·0.1 to 6553	sec	0000	P.208
P075	The 5 <sup>th</sup> Speed Runtime	○	0000·0.1 to 6553	sec	0000	P.208
P076	The 6 <sup>th</sup> Speed Runtime	○	0000·0.1 to 6553	sec	0000	P.208
P077	The 7 <sup>th</sup> Speed Runtime	○	0000·0.1 to 6553	sec	0000	P.208
P078	The 8 <sup>th</sup> Speed Runtime	○	0000·0.1 to 6553	sec	0000	P.208
P079	The 1 <sup>st</sup> Speed Pulse Input Times	○	0000·1 to 65530	Times	0000	P.209
P080	The 2 <sup>nd</sup> Speed Pulse Input Times	○	0000·1 to 65530	Times	0000	P.209
P081	The 3 <sup>rd</sup> Speed Pulse Input Times	○	0000·1 to 65530	Times	0000	P.209
P082	The 4 <sup>th</sup> Speed Pulse Input Times	○	0000·1 to 65530	Times	0000	P.209
P083	The 5 <sup>th</sup> Speed Pulse Input Times	○	0000·1 to 65530	Times	0000	P.209
P084	The 6 <sup>th</sup> Speed Pulse Input Times	○	0000·1 to 65530	Times	0000	P.209
P085	The 7 <sup>th</sup> Speed Pulse Input Times	○	0000·1 to 65530	Times	0000	P.209
P086	The 8 <sup>th</sup> Speed Pulse Input Times	○	0000·1 to 65530	Times	0000	P.209
P087	PWM/Pulse Input Frequency Signal Select	○	0·1·2	—	0	P.210
P088	PWM Signal Average Times	○	1 to 100	Times	1	P.211
P089	PWM Signal Cycle	○	1.0 to 2000	msec	1.0	P.211
P090	Output TR1 Function Select	○	0 to 13	—	0	P.212
P091	Output TR2 Function Select	○	0 to 12	—	0	P.212
P092	Output RY Function Select	○	0 to 12, r0 to r12	—	7	P.214
P093	Sensing Frequency (Output TR)	○	0000, 0.5 to 400.0	Hz	0.5	P.216
P094	Sensing Frequency (Output RY)	○	0000, 0.5 to 400.0	Hz	0.5	P.216

## 6. Function Parameters

No.	Function name	Changeable during operation	Setting range	Unit	Initial value	Reference page
P095	Current Sensing Level	○	0.1 to 100.0	A	*1	P.217
P096	Current Sensing Delay Time	○	0.1 to 10.0	sec	0.1	P.217
P097	Analog and PWM Output Function Select	○	0-1	—	0	P.217
P098	Analog and PWM Output Voltage Compensation	○	25 to 100		100	P.219
P099	Lower Frequency Limit	○	0.5 to 400.0	Hz	0.5	P.219
P100	Upper Frequency Limit	○	0.5 to 400.0	Hz	400.0	P.219
P101	0V Stop Function Select		0000,0.5 to 400.0	Hz	0.5	P.220
P102	Bias/Gain Function Select		0-1	—	0	P.221
P103	Bias Frequency Setting	○	-99.0 to 250.0	%	0	P.221
P104	Gain Frequency Setting	○	0.0 to 500.0	%	100	P.221
P105	Analog Input Filter	○	5 to 200	Times	10	P.222
P106	PID Control Mode	○	0 to 3, A0 to A3	—	0	P.223
P107	Proportional Gain [Kp]	○	0.1 to 1000	—	1	P.225
P108	Integral Time [Ti]	○	0000-0.1 to 3600	sec	0	P.225
P109	Derivative Time [Td]	○	0000-0.1 to 3600	sec	0	P.225
P110	Control Cycle [Ts]	○	0.01 to 60.00	sec	0.01	P.225
P111	PID Target Value	○	0.0 to 100.0	%	100.0	P.225
P112	The 1 <sup>st</sup> Skip Frequency	○	0000,0.5 to 400.0	Hz	0000	P.229
P113	The 2 <sup>nd</sup> Skip Frequency	○	0000,0.5 to 400.0	Hz	0000	P.229
P114	The 3 <sup>rd</sup> Skip Frequency	○	0000,0.5 to 400.0	Hz	0000	P.229
P115	Skip Frequency Band Width	○	0 to 10	Hz	0	P.229
P116	The 2 <sup>nd</sup> Base Frequency		45.0 to 400.0	Hz	50.0	P.230
P117	The 2 <sup>nd</sup> Torque Boost	○*6	Auto-0 to 40	%	5 (1-phase) 4 (3-phase)	P.231
P118	The 2 <sup>nd</sup> Electronic Thermal Select	○	0 to 3	—	2	P.233

No.	Function name	Changeable during operation	Setting range	Unit	Initial value	Reference page
P119	The 2 <sup>nd</sup> Thermal Current Setting	○	0.1 to 100.0	A	*1	P.233
P120	The 2 <sup>nd</sup> Change Point Frequency 1	○	0.5 to 400.0	Hz	0.5	P.235
P121	The 2 <sup>nd</sup> Change Point Voltage 1	○	0 to 100	%	0	P.235
P122	The 2 <sup>nd</sup> Change Point Frequency 2	○	0.5 to 400.0	Hz	0.5	P.235
P123	The 2 <sup>nd</sup> Change Point Voltage 2	○	0 to 100	%	0	P.235
P124	The 2 <sup>nd</sup> Analog Input Function Select		0·1·2·3	—	0	P.237
P125	The 2 <sup>nd</sup> Analog Input Signal Select		3 to 6	—	3	P.240
P126	The 2 <sup>nd</sup> Bias Frequency Setting	○	-99.0 to 250.0	%	0	P.241
P127	The 2 <sup>nd</sup> Gain Frequency Setting	○	0.0 to 500.0	%	100	P.241
P128	Carrier Frequency	○	0.8 to 10.0	kHz	2.5	P.243
P129	Vector Control Select		0·1	—	0	P.244
P130	Motor Capacity		0.4 to 15	—	*1	P.247
P131	Motor Poles Number		2·4·6	—	4	P.247
P132	Motor Constant Measuring Function		0·1 to 3	—	0	P.248
P133	Voltage Compensation Constant		0.01 to 99.99	V	*1	P.251
P134	Slip Compensation Frequency		-5.00 to 5.00	Hz	*1	P.253
P135	Communication Protocol Select	○	0·1	—	0 *2	P.254
P136	Communication Station No. Setting	○	01 to 31	—	01 *2	P.254
P137	Communication Speed Setting	○	4800·9600· 19200·38400	bps	96 *2	P.254
P138	Stop Bit Length	○	1·2	—	1 *2	P.254
P139	Parity Check	○	0 to 2	—	0 *2	P.254
P140	Timeout Sensing	○	0000·0.1 to 60.0	sec	0000 *2	P.254

## 6. Function Parameters

No.	Function name	Changeable during operation	Setting range	Unit	Initial value	Reference page
P141	Wait-to-send Time	○	1 to 1000	msec	1 *2	P.254
P142	Judging Time for TEXT Completion	○	3 to 200	msec	3 *2	P.254
P143	Cooling Fan ON-OFF Control Select	○	0 to 3	—	0	P.256
P144	Input Terminal Filter	○	5 to 100	Times	20	P.256
P145	Operation Status Monitor	○	0 to 7	—	0	P.257
P146	Linear Speed Multiplier	○	0.1 to 100.0	—	3	P.258
P147	Alarm LED Operation Select	○	0 to 6	—	0	P.258
P148	Upper Voltage Limit of Alarm LED	○	0.1 to 600.0	V	550.0	P.259
P149	Upper Current Limit of Alarm LED	○	0.1 to 100.0	A	*1	P.260
P150	Password	○	0000·1 to 9999	—	0000	P.260
P151	Setting Data Clear		0·1·2·3	—	0	P.261
P152	DC Brake Time during Startup	○	0000·0.1 to 120	sec	0000	P.261
P153	DC Brake Level during Startup	○	0 to 100	%	0	P.261
P154	MOP Function Select	—	0·1·2	—	0	P.264
P155	Acceleration/deceleration Time for MOP Operation	○	0000·0.1 to 3600	sec	0.5	P.264
P156	Slip Compensation Control		0·1·2	—	0	P.266
P157	The 2 <sup>nd</sup> Analog Superimposed Value	○	-100.0 to 100.0	%	0	P.267
P158	The 2 <sup>nd</sup> Motor Capacity		0.4 to 15	—	*1	P.267
P159	The 2 <sup>nd</sup> Motor Pole Number		2·4·6	—	4	P.267
P160	The 2 <sup>nd</sup> Voltage Compensation Constant		0.01 to 99.99	—	*1	P.268
P161	The 2 <sup>nd</sup> Slip Compensation Frequency		-5.00 to 5.00	—	*1	P.268
P162	Speed Search Select during Startup	○	0·1	—	0	P.268

No.	Function name	Changeable during operation	Setting range	Unit	Initial value	Reference page
P163	Waiting Time to Speed Search	○	0.0 to 100.0	sec	0.5	P.269
P164	Voltage Recover Time for Speed Search	○	0.1 to 10.0	sec	0.5	P.269
P165	Speed Search Select during Retry	○	0-1	—	0	P.270
P166	Speed Search Retry Select	○	0-1	—	0	P.270
P167	Speed Search Retry Times	○	0 to 10	Times	0	P.270
P168	Upper Frequency Limit Select for Speed Search	○	0-1	—	0	P.271
P169	Winding Mode Control Select	○	0-1-2	—	0	P.271
P170	Amplitude in Winding Mode	○	0.0 to 100.0	%	50.0	P.271
P171	Recoil Frequency Band in Winding Mode	○	0.0 to 100.0	%	10.0	P.272
P172	Winding Mode Cycle	○	0.0 to 3000.0	sec	10.0	P.272
P173	Rise Time Coefficient in Winding Mode	○	0.0 to 100.0	%	50.0	P.272
P174	Pulse Input Signal Frequency	○	1 to 10000	Hz	1000	P.272
P175	Pulse Input Signal Bias	○	-99.0 to 100.0	%	0.0	P.273
P176	Pulse Input Signal Gain	○	0.0 to 100.0	%	100.0	P.273
P177	Pulse Input Signal	○	10 to 100	msec	50.0	P.273
P178	Winding Mode Operation Select	○	0 to 3	—	0	P.274
P179	Max random rise time	○	0 to 100.0	%	50	P.275
P180	Minimum random rise time	○	0 to 100.0	%	50	P.275
P181	Winding length multiplier	○	0 to 9999	—	1	P.275
P182	Winding stop length	○	0-1 to 60.00	m	0	P.275

**【Note】**

- \*1: The initial values of such parameters vary depending on the ratings of inverter.
- \*2: As for parameter P135 to P142, the changed values will apply when the power is turned ON from OFF.
- \*3: The change from manual torque boost to auto torque boost or vice versa cannot be made during operation.





# 7

## Custom Mode

7.1 Allocating Parameter No. ....	96
7.2 Setting and Changing Parameters .....	98

## 7.1 Allocating Parameter No.

---

“Custom Mode” allows selection of up to 10 function parameters changed frequently by customer, thus making data modification easier.

The number “1” to “10” can be allocated as custom parameter No. The allocated data will be written into built-in non-volatile memory of inverter. Even if the power is cut off, the data will still be held. (The built-in non-volatile memory of inverter can be written up to 100,000 times. Therefore, do not allocate the function parameter No. frequently. )

### ■ Setting Example

Allocate function parameter “P002” (The 1<sup>st</sup> Deceleration Time) to custom parameter “U001”.

1. Confirm operation status (i.e., stop status or operation status) (For operation at 50.0 Hz).



2. Press  button four times to select Custom Mode.



3. Press  button to confirm the current allocated parameter No.



\* When function parameter No. in custom mode is displayed, a dot will appear behind the letter “P” (i.e., “P”).

(If a password is set beforehand, please enter it. Refer to parameter P150. )

4. Press and hold  button for 3 s to enter allocation setting status. (The digital part is flickering.)



5. Press  button once to change parameter No. to “P.002”.



6. Press  button to complete allocation of parameter No.



Initial settings of custom parameters No.1 to No.10 are shown in the following table.

Custom parameter No.	Function Parameter No.	Function name	Initial value	Reference page
U001	P001	The 1 <sup>st</sup> Acceleration Time	5.0	P.142
U002	P002	The 1 <sup>st</sup> Deceleration Time	5.0	P.143
U003	P007	Torque Boost	4	P.153
U004	P003	Run Command Select	0	P.144
U005	P004	Frequency Setting Signal	0	P.146
U006	P008	Max. Output Frequency	50.0	P.155
U007	P009	Base Frequency	50.0	P.155
U008	P145	Operation Status Monitor	0	P.259
U009	P147	Alarm LED Operation Select	0	P.260
U010	P150	Password	0000	P.262

To restore the initial settings of allocated custom parameters No.1 to No.10, please set the function parameter “P151: Setting Data Clear” to “3”. (The data is not changed.)

#### **【Note】**

- Since all the allocated contents to custom parameters are stored in operation panel, they will remain valid even if the panel is removed and connected to other inverters.
- All data, except those that can be changed during operation, can only be monitored during operation.







## 7.2 Setting and Changing Parameters

The section describes the method of setting, changing and confirming function parameters allocated to custom parameter No. For function parameters that can be changed during operation, refer to items in “Changeable during Operation” of “6.2 Function Parameter List”.





 <b>Danger</b>	<p>If data is changed during operation, the motor and motor load may suddenly start/stop for the great fluctuation. (Please take measures to ensure personal safety.) Failure to do so may result in injury.</p>
---	--

### ■ Setting Example

Change the setting of parameter “P002” (The 1<sup>st</sup> Deceleration Time) allocated to custom parameter “U001” from “5.0” to “10.0”

1. Confirm operation status (i.e., stop status or operation status) (For operation at 50.0 Hz).  
2. Press  button four times to select Custom Mode. 
3. Press  button to confirm the current allocated parameter No. 

\*When function parameter No. in custom mode is displayed, a dot will appear behind the letter “P” (i.e., “P.”).  
(If a password is set beforehand, please enter it. Refer to parameter P150.)

4. Press  button to display setting value of parameter P008. (The display part is flickering.) 
5. Press  button to change the displayed value to “10.0”. (The display part is flickering.) 

6. Press  button to apply the value.



If data is changed during operation, the unit will start operation with the new data.

**【Note】**

---

---

- All data, except those that can be changed during operation, can only be monitored during operation.



# 8

## Setting Modes and Copy Functions of Built-in Memory

8.1 Setting Modes and Copy Functions of Built-in Memory ...	102
8.2 Setting Built-in Memory Parameters.....	103
8.3 Parameter Upload Function (CPY1).....	105
8.4 Parameter Download Function (CPY2) .....	107
8.5 Parameter Verification Function.....	109
8.6 To Display or Conceal Built-in Memory Setting Mode ...	111



## 8.1 Setting Modes and Copy Functions of Built-in Memory

---

For VF200 inverter, both of its unit and operation panel are equipped with built-in memory as well as “Parameter Copy Function”. When operation panel is removed, the data inside can be copied to other inverter units.

The inverter provides up to 4 parameter copy functions, which are located behind P182 in “Function Setting Mode” and displayed as “CPY1” to “CPY4”. They can be enabled only by changing setting data. In addition, data in built-in memory of panel can be checked in “Built-in Memory Setting Mode”.





Copy parameter No.	Function name	Details	Reference page
CPY1	Upload function	To upload parameter settings from the unit to built-in memory of operation panel.	P.107
CPY2	Download function	To download parameter settings from built-in memory of operation panel to the unit.	P.109
CPY3	Verification function	To check if function parameters in the unit are identical to those in built-in memory of operation panel.	P.111
CPY4	Built-in memory setting mode display select	To determine whether to display built-in memory setting mode or not.	P.113



## 8.2 Setting Built-in Memory Parameters











The contents of built-in memory parameters “E001” to “E182” are identical to those of function parameters “P001” to “P182”. The setting value of built-in memory parameter can be changed in “Built-in Memory Setting Mode”.

### ■ Setting Example

Change the maximum output frequency from 50.0 Hz to 60.0 Hz (change setting value of built-in memory parameter E008 from “50.0” to “60.0”).

1. Press  button to stop the inverter. 
2. Press  button four times. 

(If a password is set beforehand, please enter it. Refer to parameter P150. )
3. Press  button twice to select Built-in Memory Setting Mode. 

(If the mode is not displayed, set function copy function 4 to “E2P”.)
4. Press  button seven times to change the built-in memory parameter No. to “E008”. 
5. Press  button to display setting value of built-in memory parameter E008. (The display part is flickering.) 
6. Press  button to change the displayed value to “60.0”. (The display part is flickering.) 
7. Press  button to apply the value. 
8. Press  button to enter “operation ready” status. 

That’s to say, the inverter is in normal stop status and can be operated if required. (Operation Status Display Mode)

## 8. Setting Modes and Copy Functions of Built-in Memory

---

### **【Note】**

---

---

- Setting values of function parameters in the unit connected with operation panel will remain unchanged even those in built-in memory are changed.
- The data is written into built-in non-volatile memory of operation panel during setting and changing operation, so it can be held even if the power is cut off.

## 8.3 Parameter Upload Function (CPY1)

Refers to the function of uploading all function parameters in connected unit to built-in memory of operation panel. The upload operation will start after setting value “UPL” is set.

### ■ How to upload function parameters

1. Press  button to stop the inverter.



2. Press  button four times.



(If a password is set beforehand, please enter it. Refer to parameter P150. )

3. Press  button.



4. Press  /  button to select “CPY1”.



(“CPY1” is located behind “P182”.)

5. Press  button. (Display the current settings.)



6. Press  button to change the displayed value to “UPL”.



7. Press  button to start upload.

The displayed value (UPL) is flickering during upload.

→After upload completion, “End” is displayed.





8. Press  button. (Make displaying switched to CPY2.)

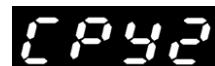

9. Press  button to enter “operation ready” status.



That's to say, the inverter is in normal stop status and can be operated if required. (Operation Status Display Mode)

### 【Note】

---

---

- The upload function cannot be used during operation. Be sure to use it in stop status.
- After upload completion, setting values of parameters in built-in memory are identical to those in the unit.
- During upload, the inverter will not start operation even if an operation signal enters. And only after upload completion (i.e., with “End” displaying) and SET button is pressed, the inverter will enter “operation ready” status.
- The data is written to built-in non-volatile memory of operation panel during data upload, so it can be held even if the power is cut off.

## 8.4 Parameter Download Function (CPY2)

Refers to the function of changing setting values of all function parameters in the unit to those in built-in memory of connected operation panel. The download operation will start after setting value “dOL” is set.

### ■ How to download parameters in built-in memory

1. Press  button to stop the inverter.



2. Press  button four times.



(If a password is set beforehand, please enter it. Refer to parameter P150.)

3. Press  button.



4. Press  /  button to select “CPY2”.



5. Press  button. (Display the current settings.)



6. Press  button to change the displayed value to “dOL”.



7. Press  button to start download.



The displayed value (dOL) is flickering during download.  
After the download completion, “End” is displayed.



8. Press  button. (Make displaying switched to CPY3.)



9. Press  button to enter “operation ready” status.



That's to say, the inverter is in normal stop status and can be operated if required. (Operation Status Display Mode)

### 【Note】

---

---

- The download function cannot be used during operation. Be sure to use it in stop status.
- After download completion, all setting values of parameters in built-in memory are identical to those in the unit.
- During download, the inverter will not start operation even if an operation signal enters. And only after download completion (i.e., with “End” displaying) and SET button is pressed, the inverter will enter “operation ready” status.
- The data is written to built-in non-volatile memory in unit during data download, so it can be held even if the power is cut off. The built-in non-volatile memory of unit can be written up to 100,000 times, so please note the download times.

## 8.5 Parameter Verification Function

Refers to the function of making comparison and verification between setting values of function parameters in the unit and those in built-in memory of operation panel. The comparison and verification will start after setting value “VEr” is set.

### ■ How to verify the parameters

1. Press  button to stop the inverter.





2. Press  button four times.



(If a password is set beforehand, please enter it. Refer to parameter P150.)

3. Press  button.



4. Press  /  button to select “CPY3”.



5. Press  button.(Display the current settings.)



6. Press  button to change the displayed value to “VEr”.





7. Press  button to start verification.



The displayed value (VEr) is flickering during verification.

#### ● If different data is checked out

- If different data is checked out, displayed parameter No. will flicker.

- In this case, press  button to display data in the unit while  button to display data in built-in memory of operation panel.

- Press  button to start verification from the next data again.

- Press  button to stop verification and “CPY3” is displayed.

After verification completion, “End” is displayed.





## 8. Setting Modes and Copy Functions of Built-in Memory

---

8. Press  button.(Make displaying switched to CPY4.)



9. Press  button to enter “operation ready” status.



That’s to say, the inverter is in normal stop status and can be operated if required. (Operation Status Display Mode)

### 【Note】

---

- The verification function cannot be used during operation. Be sure to use this function in stop status.
- During verification, the inverter will not start operation even if an operation signal enters. And only after verification completion (i.e., with “End” displaying) and SET button is pressed, the inverter will enter “operation ready” status.

## 8.6 To Display or Conceal Built-in Memory Setting Mode

For determining whether to display built-in memory setting mode or not. When copy function is unused, make setting to “conceal” for simplified operation. To display built-in memory setting mode, change the setting value to “E2P”; to conceal built-in memory setting mode, change the setting value to “OFF”.

### ■ To conceal built-in memory setting mode

1. Press  button to stop the inverter.





2. Press  button four times.



(If a password is set beforehand, please enter it. Refer to parameter P150. )

3. Press  button.



4. Press  /  button to select “CPY4”.



5. Press  button.(Display the current settings.)



6. Press  button to change the displayed value to “OFF”.



7. Press  button.



8. Press  button to enter “operation ready” status.



Operation ready status “0000” is displayed instead of “E000”.

That’s to say, the inverter is in normal stop status and can be operated if required. (Operation Status Display Mode)

### 【Note】

- This function cannot be used during operation. Be sure to use it in stop status.
- During the selection of built-in memory setting mode display, the inverter will not start operation even if an operation signal enters. And only after selection completion (i.e., with “OFF” or “ON” displaying) and SET button is pressed, the inverter will enter “operation ready” status.



# 9

## Troubleshooting

9.1 Safety Precautions.....	114
9.2 Abnormality Diagnostic Function and Resetting Method ...	114
9.3 Handling Abnormalities.....	118

## 9.1 Safety Precautions

 <b>Danger</b>	<p>Wait at least five minutes after turning off the input power before starting maintenance and inspection work. Failure to do so may result in an electric shock.</p> <p>Maintenance, inspection and part replacement work must be done only by qualified persons. (Remove metal articles such as watch, bracelet(s) etc. before operation.) (Please use insulated tools.) Failure to do so may result in an electric shock or injury.</p>
---	---

## 9.2 Abnormality Diagnostic Function and Resetting Method

### 9.2.1 Details and Remedies for Various Fault Trips

The fault trip memory stores the causes of trip in monitor modes n20 to n23. Even if the power is cut off, the fourth to the latest causes of trip will still be held. (Details of factory inspection are stored in the memory before delivery.)

Indication	Details and causes of abnormality	Remedies
SC1	• Instantaneous overcurrent during acceleration or cooling fan malfunction	<ul style="list-style-type: none"> <li>• Check if there is any shorted output or ground.</li> <li>• Remove sharp variations at load side.</li> <li>• Extend acceleration/deceleration time (parameters P001, P002 and P061 to P066).</li> <li>• Check the operation of cooling fan.</li> <li>• Stop open and close operation of magnetic contactor at load side.</li> </ul>
SC2	• Instantaneous overcurrent at constant speed or cooling fan malfunction	
SC3	• Instantaneous overcurrent during deceleration or cooling fan malfunction	
SC4	• Instantaneous overcurrent during deceleration	
SC5	• Instantaneous overcurrent at constant speed	
SC6	• Instantaneous overcurrent during acceleration	

Indication	Details and causes of abnormality	Remedies
OC1	<ul style="list-style-type: none"><li>• Overcurrent during acceleration</li></ul>	<ul style="list-style-type: none"><li>• Check output for open phase and remove sharp variations at load side.</li><li>• Extend acceleration/deceleration time (parameters P001, P002 and P061 to P066).</li><li>• Adjust torque boost level (parameter P007).</li><li>• Check for restart operation during normal operation.</li><li>• Stop open and close operation of magnetic contactor at load side.</li></ul>
OC2	<ul style="list-style-type: none"><li>• Overcurrent at constant speed</li></ul>	
OC3	<ul style="list-style-type: none"><li>• Overcurrent during deceleration</li></ul>	
OU3	<ul style="list-style-type: none"><li>• Internal DC overvoltage during acceleration</li></ul>	<ul style="list-style-type: none"><li>• Extend acceleration time (parameters P001, P061, P063 and P065).</li></ul>

## 9. Troubleshooting

Indication	Details and causes of abnormality	Remedies
OU2	<ul style="list-style-type: none"> <li>Internal DC overvoltage at constant speed</li> </ul>	Remove sharp variations at load side (parameters P002, P062, P064 and P066).
OU1	<ul style="list-style-type: none"> <li>Internal DC overvoltage during deceleration</li> </ul>	<ul style="list-style-type: none"> <li>Extend deceleration time.</li> </ul>
LU	<ul style="list-style-type: none"> <li>Power supply voltage below 85% of its rating</li> </ul>	<ul style="list-style-type: none"> <li>Measure power supply voltage and check input for open phase.</li> <li>Check ride-through restart function.</li> </ul>
OL	<ul style="list-style-type: none"> <li>The output current exceeds 125% of electronic thermal setting current or 140% of rated current of inverter for more than 1 minute.</li> </ul>	<ul style="list-style-type: none"> <li>Check electronic thermal setting current.</li> <li>Check and adjust torque boost level (parameter P007).</li> <li>Reduce load.</li> </ul>
OH	<ul style="list-style-type: none"> <li>Heat sink overheating</li> </ul>	<ul style="list-style-type: none"> <li>Check ambient temperature.</li> </ul>
AU	<ul style="list-style-type: none"> <li>External fault stop input signal is input from control circuit terminals.</li> </ul>	<ul style="list-style-type: none"> <li>Check if the external signal is proper and if timing circuit is correct.</li> </ul>
OP	<ul style="list-style-type: none"> <li>The power is turned ON with run signal ON.</li> <li>Timeout detected</li> <li>The communication cable comes off.</li> <li>The operation panel comes off.</li> </ul>	<ul style="list-style-type: none"> <li>Check start mode (parameter P057).</li> <li>Check communication setting and wiring.</li> <li>Reduce the interference around the inverter.</li> <li>Check the connection between operation panel and the inverter.</li> </ul>
FAN	<ul style="list-style-type: none"> <li>Cooling fan abnormality</li> </ul>	<ul style="list-style-type: none"> <li>Check if the cooling fan is locked.</li> </ul>
SEr	<ul style="list-style-type: none"> <li>Speed search failed</li> <li>Incorrect motor rotation direction</li> <li>The rating of the motor is too small compared with that of inverter.</li> <li>Motor rotates slowly during normal operation.</li> </ul>	<ul style="list-style-type: none"> <li>Reduce the noise around the inverter.</li> <li>Check the rotation direction of motor.</li> </ul>
CPU	<ul style="list-style-type: none"> <li>Too much interference is applied to the inverter</li> </ul>	<ul style="list-style-type: none"> <li>Reduce the interference around the inverter.</li> </ul>
Er1 <sup>*2</sup>	<ul style="list-style-type: none"> <li>Communication between the inverter unit and the operation panel failed</li> </ul>	<ul style="list-style-type: none"> <li>Check if the operation panel is connected properly to the unit.</li> </ul>
Er2	<ul style="list-style-type: none"> <li>VF200 unit firmware version &gt; Operation panel firmware version</li> </ul>	<ul style="list-style-type: none"> <li>Check the firmware version.</li> </ul>

\*<sup>2</sup> The details of abnormality corresponding to “Er1” are not displayed in monitor functions n020 to n023.

## 9.2.2 Resetting Fault Trips

If the abnormality indicator in the display part of operation panel lights up and operation is stopped, please handle the abnormality before resetting operation.

Reset by power	The reset can be made by cutting off the power once. (The inverter can operate when powered on again.)
Reset by stop signal	1 For the operation in panel setting mode (parameter P003 is set to “0” or “1”), press STOP button on operation panel to reset, and then restart the inverter. 2 For the operation in external control mode (parameter P003 is set to “2” or “3”), turn off OPERATION COMMAND button designed for external control once to reset, and then restart the inverter. Note) Reset by stop signal cannot be made through communication.
Reset by panel	For the operation in external control or communication setting mode (parameter P003 is set to “4”, “5” or “7”), the reset cannot be made even if OPERATION COMMAND button designed for external control or communication is turned OFF once. Press STOP button on operation panel to reset, and then restart the inverter.
Reset by multi-function terminal	When parameter P036 to P040 are set to “1”, turn the function setting switch ON once and OFF again to perform the reset. Then restart the unit again.
Reset by communication command	Write 0x9696 into register No. 253 (DT253) to reset the inverter.



## 9.3 Handling Abnormalities

### 9.3.1 The motor does not rotate. (When abnormality indicator lights out.)

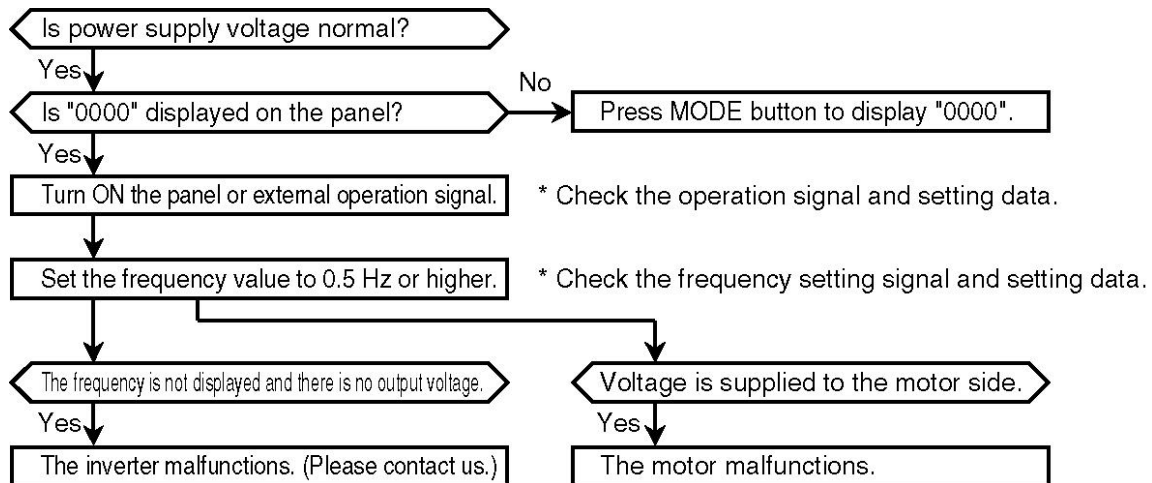

### 9.3.2 The motor does not rotate. (When abnormality indicator lights up.)

When abnormality indicators of P.114 to P.116 light up but the motor does not rotate, please check out the following two items.

1. Check whether the abnormality occurs immediately after initial installation or during operation.
2. Check whether the abnormality is caused by inverter failure (defect) or incorrect wiring and motor failure.

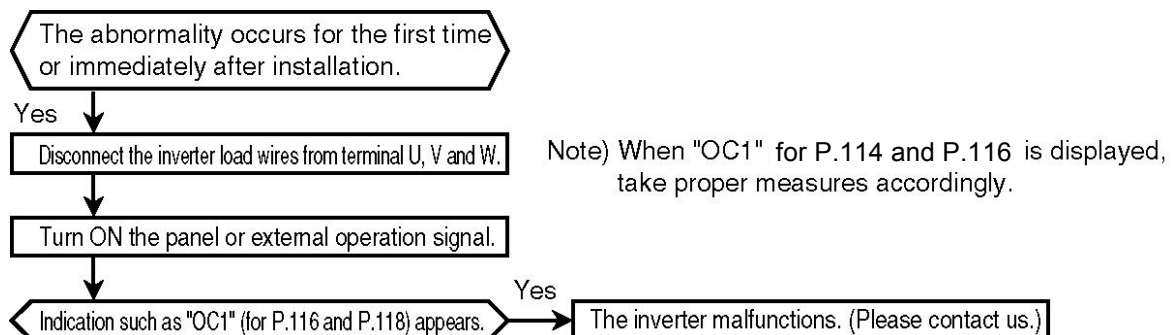

### 9.3.3 Breaker Trip

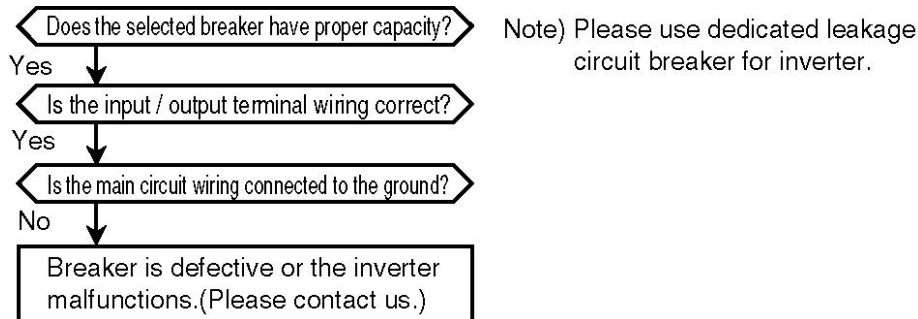

### 9.3.4 Motor Overheating

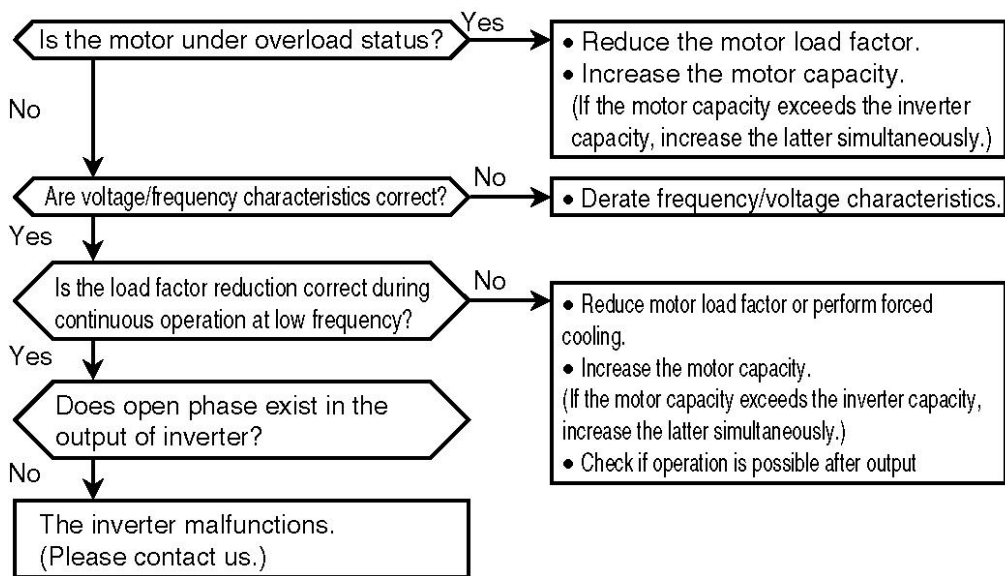

### 9.3.5 Communication Failed

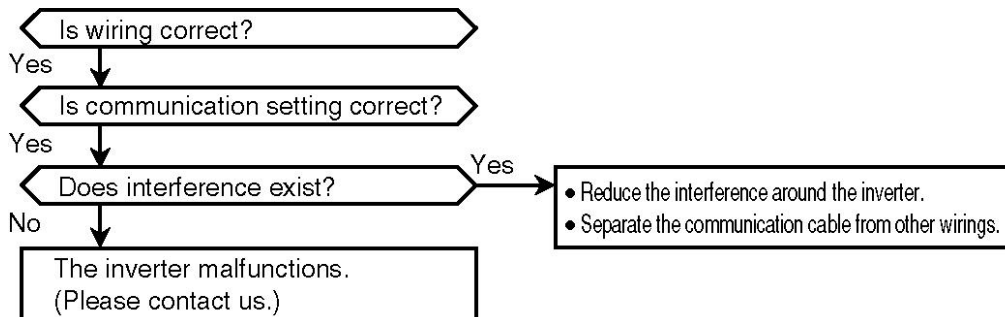





# 10

## Maintenance and Inspection

10.1 Safety Precautions .....	122
10.2 Precautions on Inspection.....	122
10.3 Inspection Items .....	122
10.4 Component Replacement .....	124
10.5 Maintenance and Inspection Table.....	125

## 10.1 Safety Precautions

---

 <b>Danger</b>	<p>Wait at least five minutes after turning off the input power before starting maintenance and inspection work.</p> <p>Failure to do so may result in an electric shock.</p> <p>Maintenance, inspection and part replacement work must be done only by qualified persons.</p> <p>(Remove metal articles such as watch, bracelet(s) etc. before operation.)</p> <p>(Please use insulated tools.)</p> <p>Failure to do so may result in an electric shock or injury.</p>
 <b>Caution</b>	<p>Employ an electrical engineering company to periodically tighten the terminal screws.</p> <p>Loose terminal screws could lead to overheating or fire.</p>

## 10.2 Precautions on Inspection

---

- To measure the insulation resistance between power supply cable and motor cable with megger, always disconnect the wires connected to the inverter first before measuring. Do not make such measurement on the control circuit.
- The inverter is mainly consisted of semiconductor elements. To prevent the negative effects arising from temperature, humidity, dust and vibration etc. in working environment and malfunctions caused by components' aging and service life, please perform daily inspection.

The following table shows the standard replacement interval (years) under normal working conditions (average annual ambient temperature = 30°C, load factor < 80% and average daily operation period < 12 h).

## 10.3 Inspection Items

---

1. Daily inspection: To check if abnormality occurs during operation.

A multimeter is normally used to check input and output voltage of inverter during operation.

2. Periodic inspection: To check all locations where inspection can be performed only when the inverter is stopped and where periodic inspection is required.

## 10.4 Component Replacement

---

Wear-out faults are related to endurance period and service life. The endurance period largely depends on the working conditions.

1. For example, service life of relay is determined by roughness of contact surface.

Contact current and load inductance are major factors affecting its service life.

2. The capacitor inside the inverter is used mainly as a smoothing filter. Due to the chemical reaction that takes place internally, its service life is greatly affected by the temperature. Generally speaking, rising of 10°C in temperature reduces the service life of an aluminum electrolytic capacitor by half, which also affects the service life of inverter.

When the inverter is used under high temperature, the aluminum electrolytic capacitor may suffer from wear-out faults prior to other components in normal status and must be replaced to extend the service life of inverter.

Component name	Standard replacement interval (year)	Method of replacement/Others
Cooling fan	5 years	Replace with a new one.
Smoothing capacitor	5 years	Investigate and replace with a new one if necessary.
Relays	-	Investigate and replace with a new one if necessary.

◆ Contact us for replacing or repairing the components.

## 10.5 Maintenance and Inspection Table

Note) Symbols used in “Inspection interval” are with different meanings: ☆ for “daily”, ○ for “yearly” and ◎ for “every two years”.

Location	Inspection item	Inspection details	Inspection interval			Inspection method	Judgment criteria	Instrument
			☆	○	◎			
Whole unit	Ambient environment	Check the ambient temperature, humidity, dust level and etc.	☆			Refer to “Precautions on Installation”.	Ambient temperature and humidity: -10 to 50°C, 90%	Thermometer Hygrometer
	Whole unit	Check for abnormal vibration and noise.	☆			Check visually and listen.	In normal status	
	Power supply voltage	Check the main circuit voltage for correct.	☆			Measure input voltage.	200 V type: 170 to 253 VAC 400 V type: 323 to 506 VAC	Multimeter
Main circuit	The whole part	1) Check if fasteners are loose; 2) Check if there is any sign of component overheating; 3) Cleaning		○		1) Strengthen the fasteners; 2) Check visually.	1), 2): In normal status	
	Connected conductors and wires	1) Check if conductors are crooked; 2) Check if the wire insulation is broken.		○		1), 2): Check visually.	1), 2): In normal status	



## 10. Maintenance and Inspection

Location	Inspection item	Inspection details	Inspection interval			Inspection method	Judgment criteria	Instrument
			☆	○	◎			
Main circuit	Transformer	Check if there is burning smell.	☆			Just smell.	In normal status	
	Terminal block	Check if there is sign of damage.		○		Check visually.	In normal status	
	Transistors and diodes	Check the resistance between terminals.			◎	Disconnect the main circuit wires and measure at the terminals.		Multimeter
	Smoothing capacitor	1) Check for liquid leakage; 2) Check if the safety valve is working correctly; 3) Measure electrostatic capacity.	☆ ☆		○	1), 2): Check visually; 3): Measure with a capacitance meter.	1), 2): In normal status. 3): Minimum 85% of rated capacity	Capacitance meter
	Relay	1) Check if the operation sound is normal; 2) Check the contact roughness.		○	○	1) Just smell; 2) Check visually.	1), 2): In normal status.	
	Resistor	1) Check if there is cracking on the insulation; 2) Check if open circuit exists.		○	○	1), 2): Check visually.	1), 2): In normal status	

Location	Inspection item	Inspection details	Inspection interval		Inspection method	Judgment criteria	Instrument
Control circuit and protection circuit	Operation check	1) Check the balance condition of output voltage between each phase during operation of single unit; 2) Inspect the protection and display circuit with timing protection operation test.		○	1) Measure the voltage between output terminals; 2) Simulate a short circuit condition between the inverter alarm outputs.	1) Line output balance is 4 V max. (8 V max. for 400 V type) 2) Timing protection circuit must function properly.	Rectifier voltmeter
	The whole part	1) Check for strange smell and discoloration; 2) Check if there is heavy rustling.		○	1), 2): Smell and check visually.	1), 2): In normal status	
	Capacitor	Check for liquid leakage and deformation.	☆		Check visually.	In normal status	
Cooling system	Cooling fan	1) Check for abnormal vibration and noise; 2) Check if connected parts are loose.	☆	○	1) Just listen; 2) Strengthen the fasteners.	1), 2): In normal status	

## 10. Maintenance and Inspection

Location	Inspection item	Inspection details	Inspection interval			Inspection method	Judgment criteria	Instrument
Display	Display unit	Check if the indicator malfunctions.	☆			Check visually.	In normal status	
	Meter	Check if the indication is correct.	☆			Check the indication.	Within specifications or control values	Voltmeter Ammeter
Motor	The whole part	1) Check for abnormal vibration and noise; 2) Check if there is burning smell.	☆			Check visually, listen and smell.	1), 2): In normal status	

# 11

## Specifications

11.1 Rated Specifications .....	130
11.2 Standard Specifications .....	132
11.3 Common Specifications .....	133

## 11.1 Rated Specifications

### • 1-phase 200 V Input Type

Model	Applicable motor output (kW)	Rated output current (A)	Rated output capacity (kVA) Note 2)	Power supply capacity (kVA) Note 3)	Mass (kg)
AVF200-0022	0.2	1.5	0.6	0.9	1.0
AVF200-0042	0.4	2.5	1.0	1.3	1.0
AVF200-0072	0.75 Note 4)	4.2	1.7	2.3	1.4
AVF200-0152	1.5 Note 4)	7.0	2.8	3.6	1.6
AVF200-0222	2.2	10.0	4.0	5.0	2.1

### • 3-phase 400 V Input Type

Model	Applicable motor output (kW)	Rated output current (A)	Rated output capacity (kVA) Note 2)	Power supply capacity (kVA) Note 3)	Mass (kg)
AVF200-0074	0.75	2.1	1.7	2.6	1.6
AVF200-0154	1.5	4.0	3.2	4.8	1.7
AVF200-0224	2.2	5.5	4.4	6.4	1.9
AVF200-0374	3.7	8.7 Note 1)	6.9	10.4	2.0
AVF200-0554	5.5	12 Note 1)	9.6	13.6	3.5
AVF200-0754	7.5	17 Note 1)	13.5	17.6	3.6
AVF200-1104	11	22 Note 1)	17.5	21.1	6.8
AVF200-1504	15	31 Note 1)	24.7	27.7	7.0

Note 1) Rated output current of 3.7 kW+ inverters varies with the set carrier frequency. Derate the output current as shown in the following figure.

•3.7 kW to 11 kW Type

•15 kW Type

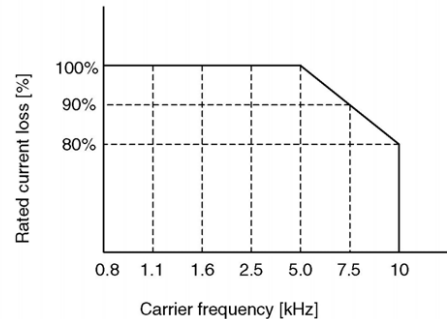
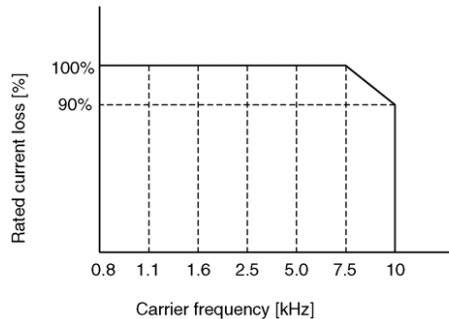

Note 2) Rated output capacity: refers to the value at output voltage of 230 VAC for 1-phase 200 V type and the value at output voltage of 460 VAC for 3-phase 400 V type.

Note 3) The power supply capacity varies with source impedance. Please use a power supply as shown on the above table.

Note 4) If excessive amount of current flows through the circuit repeatedly or the unit is used under high temperature, overcurrent trip may occur.

- For 200 V/0.75 kW inverter, if the carrier frequency is above 7.5 kHz, overcurrent trip will occur to cause reduction of overcurrent protection capability.
- For 200 V/1.5 kW inverter, if the carrier frequency is above 5 kHz, overcurrent trip will occur to cause reduction of overcurrent protection capability.

## 11.2 Standard Specifications

### • 1-phase 200 V Input Type

Items		Specifications
Standard output of applicable motor (kW)		0.2 to 2.2 kW
Rated output	Rated voltage	3-phase, 200 to 230 VAC (proportional to power supply voltage)
	Overload current rating	150% of rated output current for 1 minute
Input power supply	Number of phases, voltage and frequency	1-phase, 200 to 230 VAC, 50/60 Hz
	Allowable voltage fluctuation	+10% and –15% of rated input AC voltage
	Allowable frequency fluctuation	±5% of rated input frequency
	Instantaneous voltage drop ride-through capability	<ul style="list-style-type: none"> <li>•Operation continues when voltage is above 165 VAC.</li> <li>•Operation continues for 15 ms when voltage drops below 165 VAC.</li> </ul>

### • 3-phase 400 V Input Type

Items		Specifications
Standard output of applicable motor (kW)		0.75 to 15 kW
Rated output	Rated voltage	3-phase, 380 to 460 VAC (proportional to power supply voltage)
	Overload current rating	150% of rated output current for 1 minute
Input power supply	Number of phases, voltage and frequency	3-phase, 380 to 460 VAC, 50/60 Hz
	Allowable voltage fluctuation	+10% and –15% of rated input AC voltage
	Allowable frequency fluctuation	±5% of rated input frequency
	Instantaneous voltage drop ride-through capability	<ul style="list-style-type: none"> <li>•Operation continues when voltage is above 323 VAC.</li> <li>•Operation continues for 15 ms when voltage drops below 323 VAC.</li> </ul>

## 11.3 Common Specifications

Items		Specifications
Output Frequency	Frequency range	0.5 to 400 Hz
	Frequency display	Digital display
	Frequency accuracy	Analog setting: within $\pm 0.5\%$ of maximum setting frequency ( $25^{\circ}\text{C} \pm 10^{\circ}\text{C}$ ) Digital setting: within $\pm 0.01\%$ of maximum setting frequency ( $-10^{\circ}\text{C}$ to $+50^{\circ}\text{C}$ )
	Frequency resolution	Digital setting: 0.1 Hz Analog setting: 0.1 Hz (in 50/60 Hz mode)
Inverter control mode		High carrier frequency sinusoidal PWM control (V/F control or simple vector control is available.)
Carrier frequency		<ul style="list-style-type: none"> <li>•V/F control setting: 7 options can be selected (adjustable from 0.8 to 10 kHz).</li> <li>•Simple vector control setting: 4 options can be selected (adjustable from 2.5 to 10 kHz). (0.8, 1.1, 1.6, 2.5, 5.0, 7.5, 10.0 kHz)</li> </ul>
Operation	Start/Stop	<ul style="list-style-type: none"> <li>•Operation panel buttons</li> <li>•1a contact signal and 3-wire input (1a and 1b contact signals) can be selected.</li> <li>•RS485 communication</li> <li>•Wait time (0.1 to 100 s) can be set.</li> </ul>
	Forward/Reverse run	<ul style="list-style-type: none"> <li>•Operation panel buttons</li> <li>•1a contact signal (reverse run can be disabled.)</li> <li>•RS485 communication</li> </ul>
	JOG operation	Operation frequency: adjustable from 0.5 to 400 Hz Acceleration/deceleration time: adjustable from 0.04 to 3600 s
	Stop mode	Ramp-to-stop / coast-to-stop (switchable)
	Reset function	Stop signal reset/external reset/panel reset (optional) / power supply reset
	Start frequency	Adjustable from 0.5 to 60 Hz
	Stop frequency	Adjustable from 0.5 to 60 Hz



Items		Specifications
Operation	Ride-through restart select	0 Hz restart/operation frequency restart/speed search restart (switchable)
	Speed search	Speed search during startup (optional)
	Retry function	Retry select: validity of function, details of retry faults Retry times: adjustable from 1 to 10 times
Control	Frequency setting signal	Panel setting (operation panel): potentiometer and digital setting Analog setting signal input from external control: <ul style="list-style-type: none"> <li>• Potentiometer (10 k<math>\Omega</math>, 1/4 W or higher)</li> <li>• 0 to 5 VDC, 0 to 10 VDC</li> <li>• 4 to 20 mA, 0 to 20 mA (An external resistor of 200 <math>\Omega</math>/1/4 W or higher is connected.)</li> </ul> Digital setting signal input from external control: <ul style="list-style-type: none"> <li>• PWM signal (cycle: 0.9 to 1100 ms) or Pulse input signal</li> <li>• Frequency rise SW/reduction SW/storage SW signal</li> </ul> Communication setting: RS485
	Frequency/voltage characteristics	Base frequency: fixed at 50/60 Hz, adjustable from 45 to 400 Hz In 3-point V/F mode: adjustable voltage and frequency V/F curve: constant/square torque mode (switchable)
	Torque boost	Adjustable from 0 to 40%/auto torque boost (switchable)
	Acceleration/deceleration time	0.04 to 3600 s (independent acceleration/deceleration setting)
	Acceleration/deceleration characteristics	Linear and S-shaped acceleration/deceleration (switchable)
	The 2 <sup>nd</sup> function select	The 2 <sup>nd</sup> function select (acceleration/deceleration time, torque boost, V/F characteristics (base frequency/3-point V/F mode), electronic thermal and analog frequency setting)

Items		Specifications
Control	Multi-speed frequency setting	<ul style="list-style-type: none"> <li>•Multi-speed operation: up to 16 speed settings (No limitation to frequency setting)</li> <li>•Timer operation: up to 8 speed settings (No limitation to frequency setting)</li> <li>•Pulse input operation: up to 8 speed settings (No limitation to frequency setting)</li> </ul> It can be linked with acceleration/ deceleration time.
	Skip frequency setting	Up to 3 settings (skip frequency band adjustable from 1 to 10 Hz)
	Upper frequency limit setting	Adjustable from 0.5 to 400 Hz
	Lower frequency limit setting	Adjustable from 0.5 to 400 Hz
	Bias/gain frequency setting	Bias frequency: adjustable from -99 to 250% Gain frequency: adjustable from 0 to 500%
	External stop function	External fault stop/coast-to-stop (switchable)
	PID function	PID control mode (optional)
	Automatic tuning	Automatic tuning of motor constant
	Slip compensation control	Optional
	Cooling fan ON/OFF control	Optional
	Communication function	<ul style="list-style-type: none"> <li>•Interface : RS485 serial communication</li> <li>•Communication speeds : 4800/9600/19200/38400 bps (switchable)</li> <li>•Protocols : MEWTOCOL-COM/Modbus (RTU) (switchable)</li> <li>•Communication pattern: Half duplex</li> <li>•Maximum number of connected units: 31</li> <li>•Maximum transmission distance: 500 m (in total)</li> </ul>

## 11. Specifications

Items		Specifications
Braking	Regenerative braking torque	<ul style="list-style-type: none"> <li>•200 V 0.2 kW: 100% or higher; 0.4 kW: 80% or higher</li> <li style="padding-left: 20px;">0.75 to 2.2 kW: 20% or higher</li> <li>•400 V 0.75 to 15 kW: 20% or higher</li> </ul>
	DC braking	<p>Operate at the frequency below stop frequency</p> <ul style="list-style-type: none"> <li>•Braking torque level: 0 to 100 (20 steps adjustable)</li> <li>•Braking time: adjustable from 0.1 to 120 s</li> </ul>
Output signal	Analog output	<p>Output specification: 0 to 10 VDC (max. 1 mA)</p> <p>Output function: output frequency and output current proportion (switchable)</p>
	Open-collector output	<p>Output specification: max. rating 50 VDC/50 mA</p> <p>Output functions: operation signal, arrival signal, overload alarm, frequency detection, abnormal reverse run signal alarm, current detection, timer OFF signal and output frequency/current proportion PWM signal (cycle: 1 ms) (switchable)</p>
	Relay output	<p>Output specification: 1c contact (contact capacity 230 VAC, 0.3 A resistive load)</p> <p>Output functions: operation signal, arrival signal, overload alarm, frequency detection, abnormal reverse run signal alarm, current detection and timer OFF signal (switchable)</p>
Display	Operation/control status	<p>Output frequency, linear speed display (switchable) and rotation direction</p> <p>Output voltage, internal DC voltage, setting frequency, communication station No., operation times of timer, alarm type, control circuit terminal status (I/O signal), operation status, PID (setting value, measured value and output value), progress of automatic tuning, accumulative operation time and accumulative operation time of fan</p>

Items		Specifications
	Details of abnormality	Specific symbol is indicated when the protection function is activated (the latest four abnormalities are stored.)
Protection	Current limit	Current limit can be set within 1 to 200% of rated output current.
	Trip (stop)	Instantaneous overcurrent (SC1-6) and abnormal temperature (OH) Overcurrent (OC1-3), overload and electronic thermal relay (OL), undervoltage (LU), overvoltage (OU1-3), cooling fan fault (FAn), external fault (AU), operation fault (OP) and CPU fault (CPU)
	Stall prevention function	Overcurrent and overvoltage stall prevention
Environment	Ambient temperature and humidity	-10 to +50°C (Note 1) (without freezing) and below 90%RH (without condensation)
	Storage temperature and humidity	-25 to +65°C and below 95%RH
	Vibration	5.9 m/s <sup>2</sup> (0.6G) or lower
	Altitude	1000 m or lower
	Location	Indoor areas free of corrosive gases, flammable gases, oil mist or dust
Enclosure		IP20 cabinet-moussnted
Cooling method		<ul style="list-style-type: none"> <li>•200 V 0.2 to 0.75 kW: self-cooling; 1.5 to 2.2 kW: air-cooling</li> <li>•400 V 0.75 kW: self-cooling; 1.5 to 15 kW: air-cooling</li> </ul>

Note 1) It is -10 to +40°C when multiple inverters are installed side-by-side.



# Appendix

## Function Parameter List

## **P001** The 1<sup>st</sup> Acceleration Time

The time to accelerate from 0.5 Hz to the maximum output frequency can be set.

Data setting range (s)	0.04 • 0.1 to 3600
Increment (s)	0.1(0.1 to 999.9), 1(1000 to 3600)

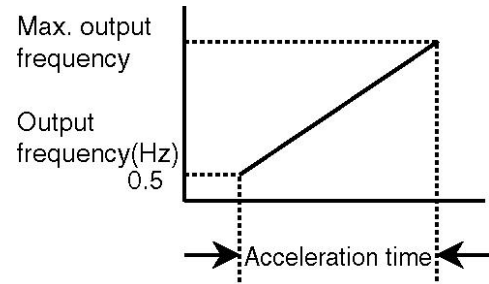

- The display code for “0.04 s” is “0000”.
- The maximum output frequency can be set with parameter P005 and P008.

### **【Note】**

- Please note that if the acceleration time setting is too small, overcurrent may occur depending on the load.

Related parameters: P005, P008

## P002 The 1<sup>st</sup> Deceleration Time

The time to decelerate from the maximum output frequency to 0.5 Hz can be set.

Data setting range (s)	0.04 • 0.1 to 3600
Increment (s)	0.1 (0.1 to 999.9), 1 (1000 to 3600)

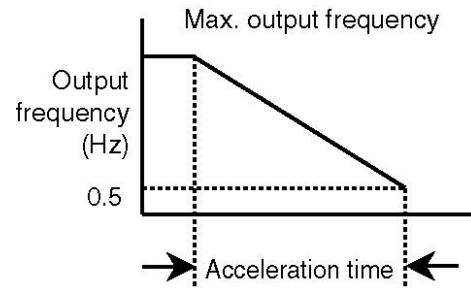

- The display code for "0.04 s" is "0000".
- The maximum output frequency is set with parameter P005 and P008.

### 【Note】

- Please note that if the deceleration time setting is too small, overcurrent may occur depending on the load.

Related parameters: P005, P008



## P003 Run Command Select

Run/stop and forward/reverse run can be selected with operation panel, signal input from external control device or communication commands.

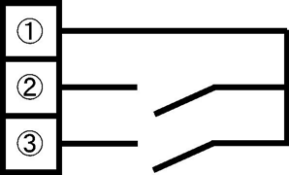
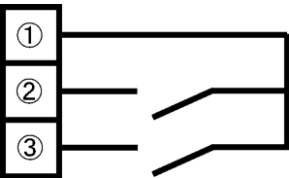
Setting value	Command status	Panel reset function	Operation method and control circuit terminal connection diagram
0	Panel	○	Start: RUN, Stop: STOP Forward/reverse run: can be set in Rotation Direction Setting mode (dr mode)
1	Panel	○	Forward run: UP+RUN, Reverse run: DOWN+RUN, Stop: STOP
2	External control	×	 <p>Common terminal (Terminal No. 1 or No. 8) ON: Start/OFF: Stop ON: Reverse run/OFF: Forward run</p>
4	External control	○	
3	External control	×	 <p>Common terminal (Terminal No. 1 or No. 8) ON: Forward run/OFF: Stop ON: Reverse run/OFF: Stop</p>
5	External control	○	
6	Communication	×	Make run command transmitted through communication valid.
7	Communication	○	

■ 3-wire run/stop command

Please assign “3-wire stop command” to any input terminal of SW1 to SW5. The following connection example indicates the situation that “3-wire stop command” is assigned to input terminal SW1.

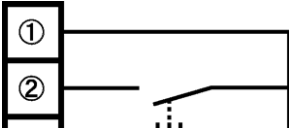
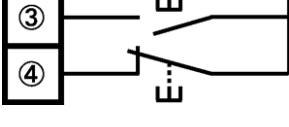
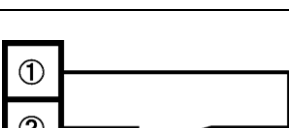
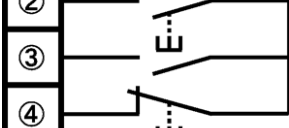
Setting value	Command status	Panel reset function	Operation method and control circuit terminal connection diagram
2	External control	×	 <p>Common terminal (Terminal No. 1 or No. 8) ON: Start ON: Reverse run/OFF: Forward run ON: Stop (*1)</p>
4	External control	○	 <p>Common terminal (Terminal No. 1 or No. 8) ON: Forward run ON: Reverse run ON: Stop (*1)</p>
3	External control	×	 <p>Common terminal (Terminal No. 1 or No. 8) ON: Forward run ON: Reverse run ON: Stop (*1)</p>
5	External control	○	 <p>Common terminal (Terminal No. 1 or No. 8) ON: Forward run ON: Reverse run ON: Stop (*1)</p>

(\*1) If any terminal of SW1 to SW5 (control circuit terminal No. 4 to No. 8) is used as “3-wire stop command”, please set “P036 to P040: SW1 to SW5 Function Select” to “10” (3-wire stop command). In addition, please note that even if “P041: Input Logic Setting” is set to “a contact input”, “b contact input” will still apply.

■ Panel reset function

When a fault trip occurs, reset cannot be made with stop signal input from external devices. Therefore, use STOP SW on the panel to reset the fault trip. But if the reset lock function is used, it will take precedence. In addition, reset function is also valid.

【Note】

- If forward run and reverse run signal are turned ON simultaneously, the operation status will not be changed. If the inverter is stopped and both signals are turned ON simultaneously, the operation will not start.

Related parameters: P036 to P040

**P004** Frequency Setting Signal

The frequency setting signal can be selected with operation panel, signal input from external devices or communication command.

Setting value	Command status	Details of signal setting	Operation method and control circuit terminal connection diagram
0	Panel	Potentiometer setting	Potentiometer on the panel MAX: maximum frequency (refer to P005 and P008) MIN: minimum frequency (or 0 V stop) OP trip will occur if the operation panel is removed during operation.
1		Digital setting	Can be set in "Frequency Setting Mode (Fr)"
2	External Control	Potentiometer	Terminal No.13, 14 and 15 (center of potentiometer is connected to No.14)
3		0 to 5 V (Voltage signal)	Terminal No.14 and 15 (14: +, 15: -)
4		0 to 10 V (Voltage signal)	Terminal No. 14 and 15 (14: +, 15: -)
5		4 to 20 mA (Current signal)	Terminal No.14 and 15 (14: +, 15: -): a 200 $\Omega$ resistor is connected between 14 and 15.
6		0 to 20 mA (Current signal)	Terminal No.14 and 15 (14: +, 15: -): a 200 $\Omega$ resistor is connected between 14 and 15.
7	Communication	RS485 communication	Make frequency command transmitted through communication valid.
8	Panel	Potentiometer setting	Potentiometer on the operation panel MAX: maximum frequency (refer to P005 and P008) MIN: minimum frequency (or 0 V stop) *Operation will continue even if the panel is removed during operation.

**【Note】**

- If a 4 to 20 mA or 0 to 20 mA signal is used, please connect a "200  $\Omega$  resistor" between terminal No.14 and 15.  
(If the 200  $\Omega$  resistor is not connected, the inverter could be damaged.)
- When frequency setting signal is set to a value other than "1" or "7", the

inverter will run or stop as defined by the setting value of “P101: 0 V Stop Function Select”. If 0 V stop function is set to invalid, parameter P101 should be set to “0000”.

Related parameters: P005, P008, P101 to P104

■ Operation when P004 is set to “8”

- The basic operation is the same as the operation when P004 is set to “0”, but the operation will continue instead of triggering OP trip even if the operation panel is removed.

- The value prior to operation panel removal is used as frequency setting.
- The following operation procedures must be performed when frequency is changed with the potentiometer after the operation panel is reinstalled.

1) Press MODE button to switch to “Frequency Setting Mode (Fr)”.

2) Press SET button.

As the frequency data flickers, it can be changed with the potentiometer.

3) Press SET button to change frequency data with the potentiometer.

After the changed frequency data is applied, acceleration or deceleration operation will start with new setting value. Thus the frequency can be changed with the potentiometer.

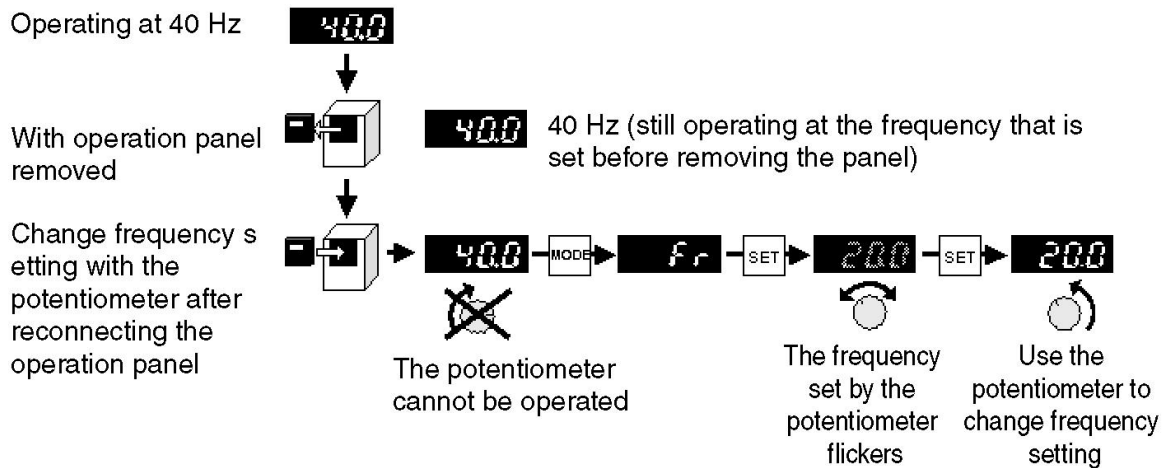

## P005 V/F Mode

V/F mode of “50· 60 Hz” and “0.5 to 400 Hz” can be set separately within the maximum output frequency band (50 to 400 Hz).

Setting value	Name	Details
50	50 Hz mode	V/F mode of 50 Hz is set regardless of parameter P008 and P009 setting.
60	60 Hz mode	V/F mode of 60 Hz is set regardless of parameter P008 and P009 setting.
FF	Free mode	V/F mode can be set in parameter P008 and P009. P008: maximum output frequency setting, P009: base frequency setting
3C	3-point mode	3-point V/F mode can be set in parameter P008 to P013. P008: maximum output frequency setting, P009: base frequency setting P010: change point frequency 1 setting, P011: change point voltage 1 setting; P012: change point frequency 2 setting, P013: change point voltage 2 setting
3C1	3-point fixed mode1	Set value of fixed mode with P009 to P013.
3C2	3-point fixed mode2	Set value of fixed mode with P009 to P013.
3C3	3-point fixed mode3	Set value of fixed mode with P009 to P013.
3C4	3-point fixed mode4	Set value of fixed mode with P009 to P013.
3C5	3-point fixed mode5	Set value of fixed mode with P009 to P013.
3C6	3-point fixed mode6	Set value of fixed mode with P009 to P013.

### ■ 50Hz mode

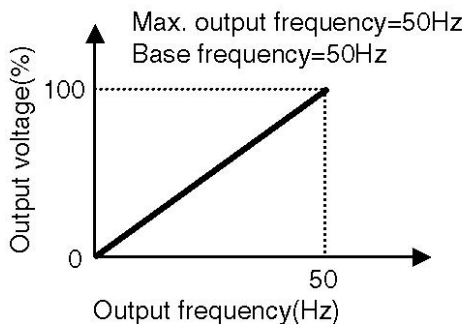

### ■ 60Hz mode

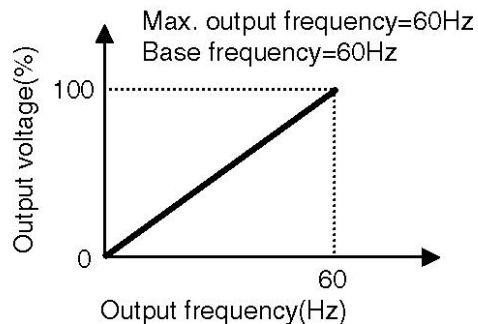

■ Free mode

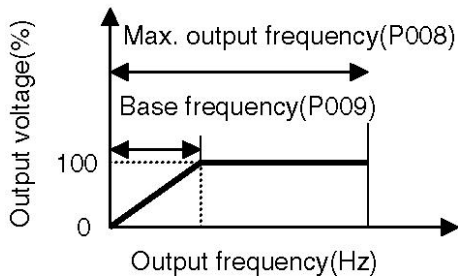

■ 3-point mode

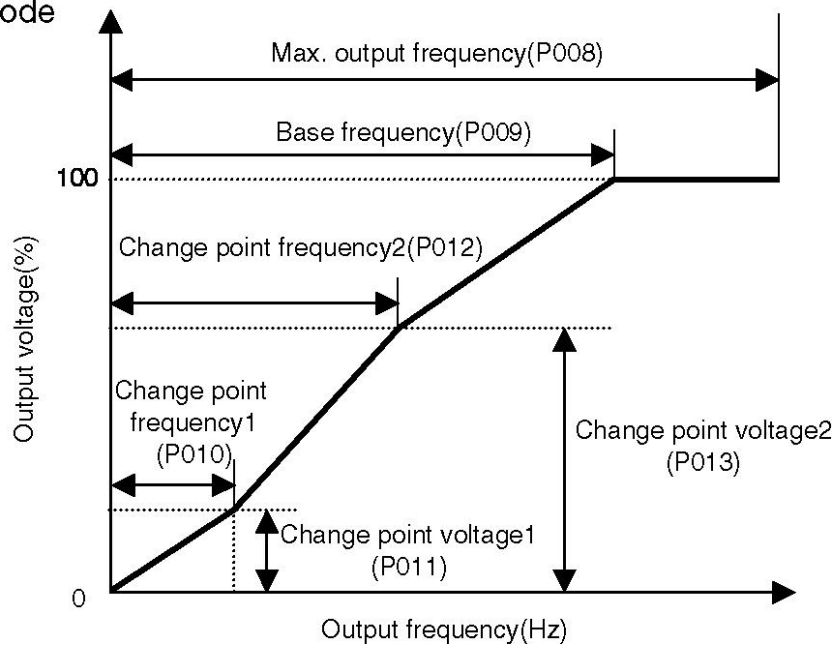

If 3-point V/F mode is used, please set each parameter according to the following relation diagram.

(Also apply to the 2<sup>nd</sup> characteristic)

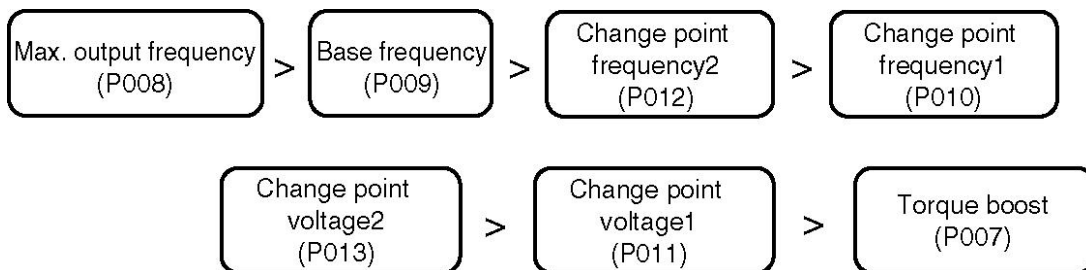

## ■ 3-point mode 1

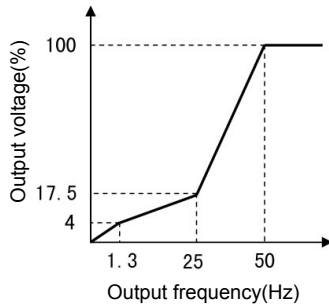

## ■ 3-point mode 2

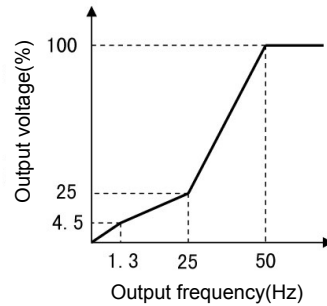

## ■ 3-point mode 3

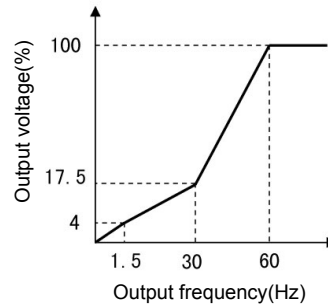

## ■ 3-point mode 4

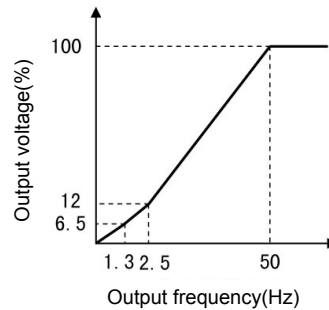

## ■ 3-point mode 5

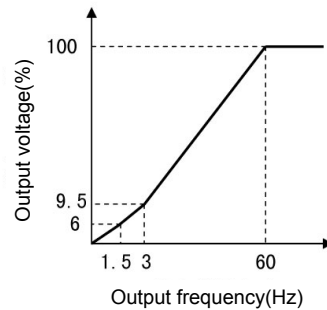

## ■ 3-point mode 6

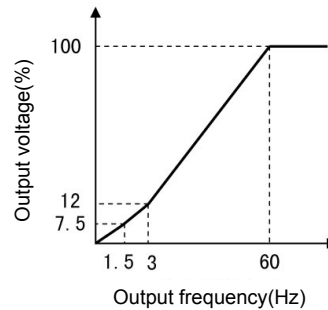
**【Note】**

- Settings for 3C1 to 3C6 don't affect the second feature.
- Factory settings of maximum output frequency and base frequency are both 50 Hz.
- Please consider the setting of Upper Frequency Limit (parameter P100) when changing the maximum output frequency.
- In free mode or 3-point mode, please note that sharp acceleration/deceleration or overcurrent may occur depending on setting values and load state if change point frequency and voltage are changed during operation.
- If change point frequency 1 or 2 is set to a value higher than base frequency, the invert will still operate according to the base frequency setting.
- If change point frequency 2 is set to a value lower than change point frequency 1, it will operate according to the setting of latter one.
- If change point voltage 1 or 2 is set below the torque boost value, it will operate according to the setting value of "P007: Torque Boost".
- If change point voltage 2 is set to a value lower than change point voltage 1, it will operate according to the setting of latter one.
- In 3-point mode, V/F curve (P006) corresponds to constant torque mode. Even if the setting is square torque mode, constant torque mode still applies.
- It is invalid during vector control (P129 = "1").

Related parameters: P007 to P013, P100



## P006 V/F Curve

Constant or square torque mode can be selected.

Setting value	Name	Remarks
0	Constant torque mode	For machine applications, etc.
1	Square torque mode	For fan and pump applications, etc.

■ Constant torque mode

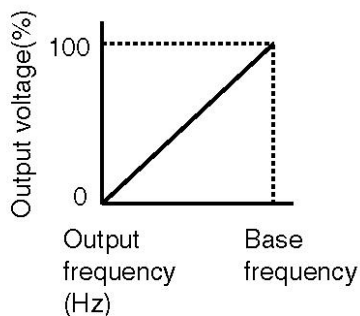

■ Square torque mode

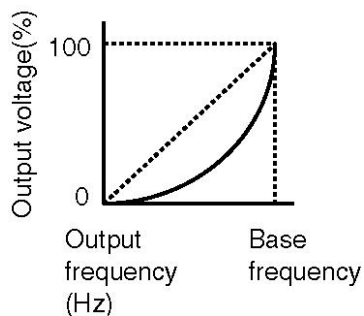

### 【Note】

- If “P005: V/F Mode” is set to 3-point mode, 3C1 to 3C6, V/F curve will correspond to constant torque mode.

Even if the setting is square torque mode, constant torque mode will still apply.

- It is invalid during vector control (P129 = “1”).

Related parameters: P005, P009

## P007 Torque Boost

- Torque boost level corresponding to load characteristics can be set. The larger the setting value is, the higher output voltage and torque boost will be.
  - After the mode is set to “auto torque boost”, the output voltage will change automatically according to the load fluctuation. To set “Auto torque boost”, please press ▼ (down) button when the operation panel displays “0”.

Name	Data setting range (%)
Auto torque boost	Auto
Manual torque boost	0 to 40%

■ Constant torque mode

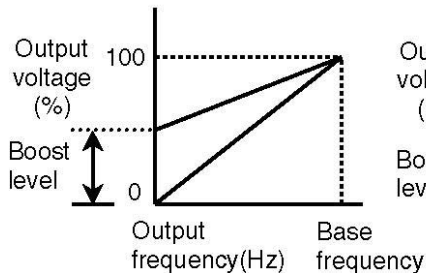

■ Square torque mode

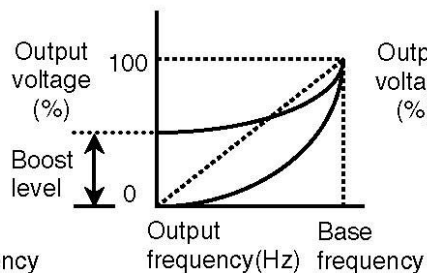

■ Auto torque boost mode

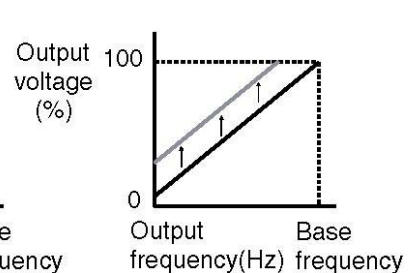

### Method of increasing torque at lower speed

- If higher torque is required at lower speed, the torque boost level can be set to a larger value, thus generating higher output voltage to increase the torque.

### 【Note】

- If the boost level setting is too high, it may cause overcurrent fault, overload fault, motor overheating or excessive noise.
- The motor current will rise after the boost level increases. Please carefully consider the settings for “P016: Electronic Thermal Select” and “P017: Thermal Current Setting”.
- Once it is set to “vector control”, the settings for parameter “P129: Vector Control Select =1” and parameter “P007: Torque Boost” will become invalid.
- During auto torque boost setting, parameter “P130: Motor Capacity”, “P131: Motor Pole Number” and “P133: Voltage Compensation Constant” must be set. The setting for “P133: Voltage Compensation Constant” can be tuned

automatically by “P132: Motor Constant Measuring Function”.

- Overcurrent trip may occur if the value of voltage compensation constant is too large.

- The torque may be insufficient at lower speed if the value of voltage compensation constant is too small.

- The change from manual torque boost to auto torque boost or vice versa cannot be made during operation.

- Please use the inverter in the following conditions when set to “auto torque boost”.

- The motor must be the squirrel-cage induction type for general purpose.

- Please select the inverter with capacity equivalent to or one level higher than motor capacity.

Example 1) Please select a 0.75 kW inverter for motor ranging from 0.4 kW to 0.75 kW.

Example 2) Please select a 1.5 kW inverter for motor ranging from 0.75 kW to 1.5 kW.

- Number of motor poles must be “2”, “4” or “6”.

- It must operate in standalone mode (i.e., one motor is driven by one inverter).

- The maximum wiring length between the inverter and motor must not exceed 30 m.

If the above conditions are not satisfied, it is unlikely to achieve sound operation performance.

- The output frequency for auto torque boost setting ranges from 1 Hz to 120 Hz.

**P008** Max. Output Frequency**P009** Base Frequency

Maximum output frequency and base frequency can be set.

(Parameter P005 is valid only when “FF” or “3C” is set.)

■ Parameter P008: Max. Output Frequency

Data setting range (Hz)	50.0 to 400.0
----------------------------	---------------

■ Parameter P009: Base Frequency

Data setting range (Hz)	45.0 to 400.0
----------------------------	---------------

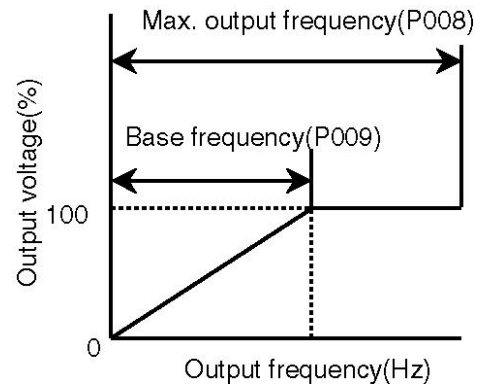

**【Note】**

- If “P005: V/F Mode” is set to “50” or “60”, the maximum output frequency and base frequency will become fixed values.
- Frequency higher than “P100: Upper Frequency Limit” cannot be output.
- If a general-purpose motor with rated frequency of 50/60 Hz is running at a frequency exceeding the ratings, the motor may be damaged. Therefore, please set a frequency that matches with motor characteristics.
- If base frequency is required to be changed simultaneously with maximum output frequency for a dedicated high-speed motor etc., such change should be made with the parameter.
- When running a general-purpose motor at a frequency higher than universal frequency, the base frequency setting should not exceed the rated output frequency (50/60 Hz) of the motor.
- When a general-purpose motor reaches a level higher than the base frequency (normally 50/60 Hz), the motor will show constant output characteristics and the generated torque will drop in reverse proportion to the frequency.

Related parameters: P005, P100

<b>P010</b>	Change Point Frequency 1	<b>P012</b>	Change Point Frequency 2
<b>P011</b>	Change Point Voltage 1	<b>P013</b>	Change Point Voltage 2

Change point 1 and 2 can be selected in 3-point mode of “P005: V/F Mode”.  
(It is valid only when parameter P005 is set to “3C”.)

■ Parameter P010: Change Point Frequency 1

Data setting range (Hz)	0.5 to 400.0
-------------------------	--------------

■ Parameter P011: Change Point Voltage 1

Data setting range (%)	0 to 100
------------------------	----------

■ Parameter P012: Change Point Frequency 2

Data setting range (Hz)	0.5 to 400.0
-------------------------	--------------

■ Parameter P013: Change Point Voltage 2

Data setting range (%)	0 to 100
------------------------	----------

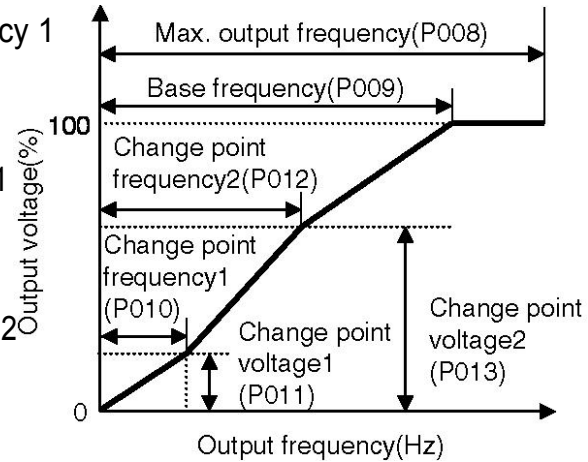

**【Note】**

- Read “P005: V/F Mode” carefully before setting.
- Change point frequency 1 and 2 will operate according to the setting value of base frequency when set to a value higher than base frequency.
- Change point frequency 2 will operate according to the the setting value of change point frequency 1 when set to a value lower than change point frequency 1.
- When setting “P007: Torque Boost”, change point voltage 1 and 2 will operate according to the setting value of torque boost if set to a value lower than torque boost level.
- Change point voltage 2 will operate according to the the setting value of change point voltage 1 when it is set to below change point voltage 1.
- Please note that sharp acceleration/deceleration or overcurrent may occur depending on setting values and load status if data is changed during operation.
- Set as "3C1" to "3C6" of "P005: V/F Mode", P010 to P013 will change to fixed value automatically, and can not be able to be changed.

Related paremeters: P005, P100, P007 to P009

**P014** Max. Output Voltage

Maximum output voltage can be set.

Data setting range (V)	1 to 500
------------------------	----------

\*When the data is set to "0", power voltage value will be output.

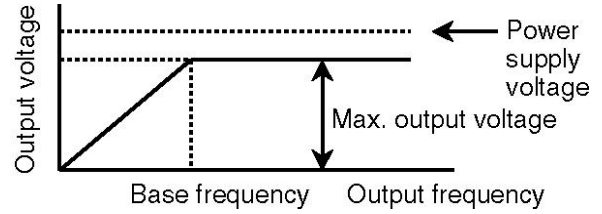
**【Note】**

- A voltage exceeding power supply rating cannot be output.
- This setting has no connection with DC brake level.

Related parameters: P005, P008

## P015 S-shaped Acceleration/Deceleration Mode

The acceleration/deceleration mode can be switched between linear and S-shaped (quadratic and cubic) pattern.

Setting value	Details
0	Linear acceleration/deceleration (Factory setting)
1	S-shaped acceleration/deceleration (Quadratic curve)
2	S-shaped acceleration/deceleration (Cubic curve)

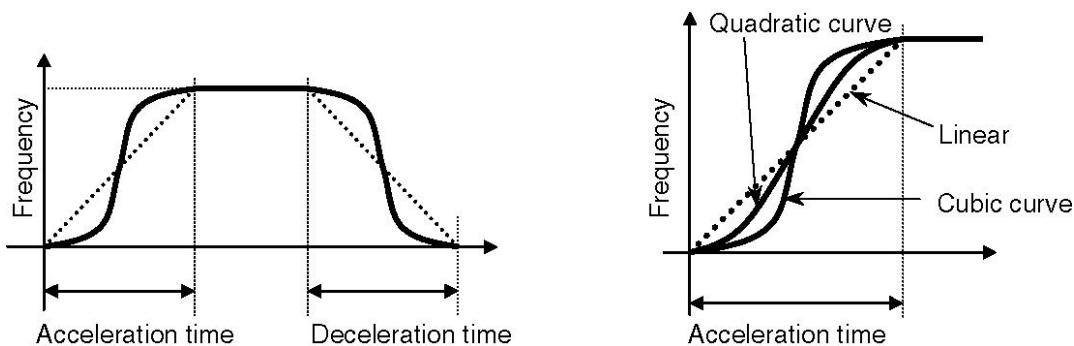

### 【Note】

- The acceleration/deceleration time remains the same regardless of the acceleration/deceleration mode (linear or s-shaped acceleration/deceleration).

Related parameters: P001, P002, P061 to P066

**P016** Electronic Thermal Select**P017** Thermal Current Setting

Electronic thermal operation level can be set when motor overload is detected and the inverter output needs to be stopped.

Operation coasts to stop when OL is displayed.

**Parameter P016: Electronic Thermal Select**

Setting value	Validity of function	Details of function
0	×	OL trip will occur if the inverter current remains 140% of its rating for 1 minute.
1	○	The output frequency is not derated
2	○	The output frequency is derated
3	○	Forced air-cooled motor specification

**\*About frequency derating**

The function can automatically compensate operation level when motor cooling performance drops during low-speed operation.

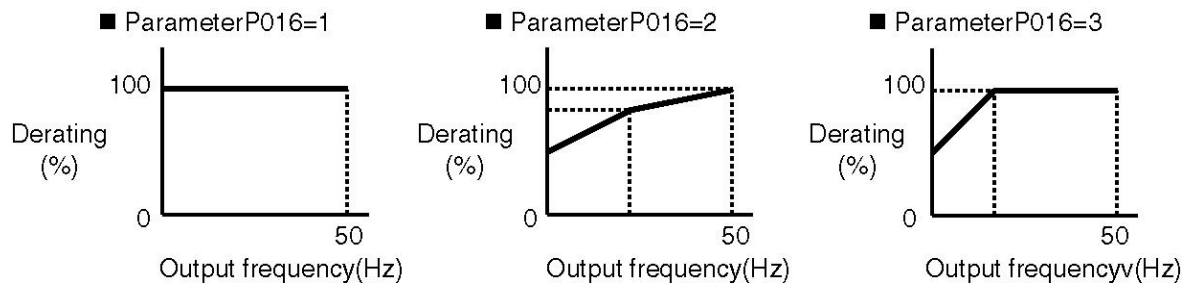
**Parameter P017: Thermal Current Setting**

Data setting range (A)	0.1 to 100.0
------------------------	--------------

\* Please make settings according to the rated current of the applicable motor.

**Example of setting current and thermal operation (P016=1)**

- Setting current  $\times 100\%$   $\Rightarrow$  Does not operate
- Setting current  $\times 125\%$   $\Rightarrow$  Operate (OL trip)



## P018 Overcurrent Stall Prevention Function

- Overcurrent stall prevention function:

During acceleration/deceleration, if acceleration/deceleration time is too short for the inertial load and the output current exceeds OCS level, the parameter serves to extend acceleration/deceleration time.

- Overcurrent trip prevention function:

If overcurrent occurs in the inverter during operation, output will be temporarily stopped and started again when the current drops to normal level.

Name	Setting value	Details
Overcurrent stall prevention function	0	Overcurrent stall prevention function OFF Overcurrent trip prevention OFF
	1	Overcurrent stall prevention function ON Overcurrent trip prevention ON
	2	Overcurrent stall prevention function OFF Overcurrent trip prevention ON
	3	Overcurrent stall prevention function ON Overcurrent trip prevention OFF

### 【Note】

- When load fluctuates drastically or the inverter accelerates or decelerates sharply, instantaneous overcurrent may sometimes lead to trip.
- For 200 V/0.75 kW inverter, if the carrier frequency setting is higher than 7.5 kHz, overcurrent trip prevention function will become invalid.
- For 200 V/1.5 kW inverter, if the carrier frequency setting is higher than 5 kHz, overcurrent trip prevention function will become invalid.
- For 3.7 kW inverter, if the carrier frequency setting is higher than 10 kHz, overcurrent trip prevention function will become invalid.
- The operation level of overcurrent stall prevention function can be set with parameter “P021: OCS Level”. The factory setting is 140% of rated current.

- Overcurrent trip prevention function is activated regardless of setting of parameter “P018: Overcurrent Stall Prevention Function” after parameter “P020: Current Limit Function” is set.

Related parameter: P021

## **P019** Overvoltage Stall Prevention Function

During deceleration, when the deceleration time is too short for the inertial load, this parameter can be used to temporarily retard deceleration, thus preventing overvoltage trip.

Setting value	Details
0	Stall prevention function disabled
1	Stall prevention function enabled

### **【Note】**

- When regenerative brake is used in the inverter with braking function, please set the value to “0”.

(The regenerative brake function will not operate since the factory setting is “1”).

- The specifications of built-in brake of inverter are as follows. Please take them into full consideration before using.

Please note that the braking resistor and inverter could be damaged if used beyond specifications.

(1) Braking torque: 100%

(2) Maximum duty factor (%ED): 5%

(3) Maximum working time: 5 s

- Only brake circuit is built in the inverter.

## P020 Current Limit Function

If the output current reaches the overcurrent stall level (OCS level) during overload operation, the frequency will be automatically reduced. When the load recovers to normal level, the frequency will be automatically restored to the original setting and the operation will continue. This function is effective for preventing overcurrent trips in sticky material crushing machines.

When the function becomes valid/invalid and the output current reaches the overcurrent stall level, deceleration time will be automatically set to lower the frequency.

The operation level (overcurrent stall level) can be set with the parameter “P021: OCS Level”.

Data setting range (s)	00 • 0.1 to 9.9
------------------------	-----------------

\* “00” corresponds to a setting without current limit.

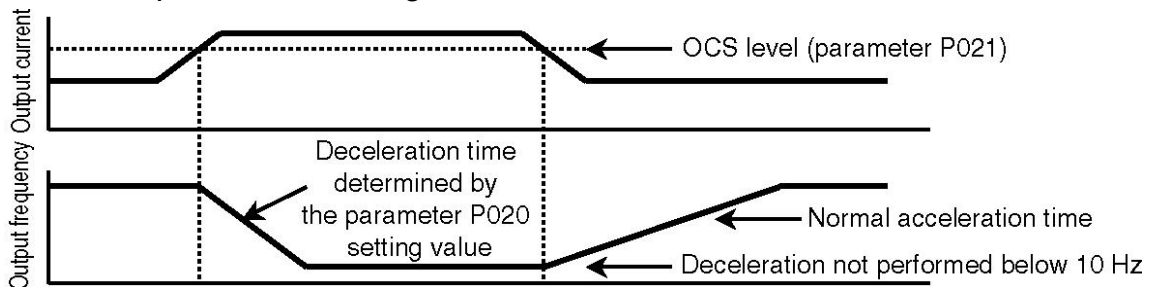

### 【Note】

- Overcurrent trip prevention function operates regardless of the setting of the parameter “P018: Overcurrent Stall Prevention Function” after the parameter “P020: Current Limit Function” is set.

Related parameters: P018, P021

**P021** OCS Level

The OCS level (overcurrent stall prevention operation level) and current limit function level can be set with a ratio (%) to the rated current of inverter.

Data setting range (%)	1 to 200
------------------------	----------

**【Note】**

---

- The factory setting of OCS level is 140% of rated current.
- The OCS level is equivalent to current limit level.
- It has no connection with electronic thermal level and overload detection level.

Related parameters: P018, P020

**P022** Retry Function

**P023** Retry Count

---

The retry function can automatically reset the fault and restart (run) operation after waiting time has elapsed when an inverter fault trip occurs. Please use this function to continue the operation.

 <b>Danger</b>	<p>When the retry function is used, the unit may automatically start (restart) suddenly, so do not approach the unit. (Please take measures to ensure personal safety.)</p> <p>Failure to do so may lead to injury.</p>
---	---

■ Parameter P022: Retry Function

Setting value	Details
0	Retry function disabled (retry is not performed.)
1	Perform retry operation only for overcurrent fault and heat sink abnormal overheating (SC1/SC2/SC3/SC4/SC5/SC6/OC1/OC2/OC3).
2	Perform retry operation only for overvoltage fault (OU1/OU2/OU3).
3	Perform retry operation only for overcurrent fault and heat sink abnormal overheating (SC1/SC2/SC3/SC4/SC5/SC6/OC1/OC2/OC3) and overvoltage fault (OU1/OU2/OU3).

■ Parameter P023: Retry count

Data setting range (times)	1 to 10
----------------------------	---------

**【Note】**

- The retry interval is set with parameter “P026: Waiting Time”.
- Fault alarm is not output during retry operation. But when the fault still occurs even if retry is performed for preset times, the fault alarm will be output.
- If an unselected fault occurs during retry, the fault alarm will be output and the retry count accumulated till present will be cleared.
- Once the power is cut off, the retry count accumulated till now will be cleared.
- If the fault does not occur for over 5 minutes, the retry times accumulated up to now will be cleared.
- When speed search is selected with parameter “P165: Speed Search Select during Retry” and the time set with parameter “P026: Waiting Time” and “P163: Waiting Time to Speed Search” has elapsed, the speed search function will start to operate.

■ Related parameter: P026

**P024 Start Mode**

This parameter is used to set the start-up operation for the case that a run signal set externally is input when the power is turned ON.



**Danger**

Depending on the start mode setting, when the run signal is ON, the inverter may start (restart) suddenly if the power is turned ON or restored after a power failure. Therefore, do not approach the unit. Design the machine so that personal safety can be ensured even if the inverter starts suddenly.

Depending on the start mode function setting, if the fault trip is reset with the run signal ON, the inverter may sometimes restart suddenly. (Please take measures to ensure personal safety.)

Failure to do so may lead to injury.

- The factory setting is "1" (OP stop).
- If the value is set to "0", operation will start immediately after the power is turned ON.
- If the value is set to "2", operation will start when the power is turned ON and after the waiting time has elapsed.

Setting value	Operation	Details of operation
0	Run	Operation starts immediately when the low voltage level (LU level) is exceeded after the power is turned ON.
1	"OP" stop	OP trip occurs when the low voltage level (LU level) is exceeded after the power is turned ON. Turn the run signal OFF once, perform reset operation and turn the run signal ON again to start operation.
2	Run after waiting time elapses	Operation starts when the low voltage level (LU level) is exceeded and the waiting time has elapsed after the power is turned ON. (The waiting time can be set with parameter P026.)
3	"OP stop"	OP trip occurs when the low voltage level (LU level) is exceeded after the power is turned ON. Turn the run signal OFF once, perform reset operation and turn the run signal ON again to start operation. (The setting will function in the same manner as data "1" with run signal ON when the power is turned ON. However, starting after the waiting time has elapsed is possible during normal startup.)

■ When power is turned ON with run signal ON

■ When run signal is turned ON after power-on

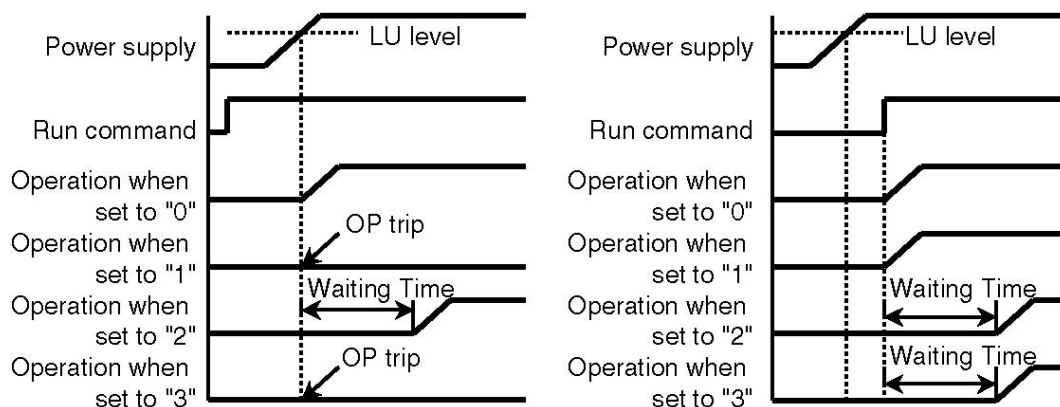

**【Note】**

- Waiting time can be set with parameter P026.

Related parameter: P026

## P025 Ride-through Restart Select

The restart pattern after constant power failure or instantaneous power supply can be selected according to the load status and system configuration. A waiting timer function is built-in.

 <b>Danger</b>	<p>The inverter may suddenly start (restart) if the power is restored after a power failure with the setting of ride-through restart, so do not approach the unit. (Please take measures to ensure personal safety.) Failure to do so may result in injury.</p>
---	---

Setting value	Inverter operation in regard to instantaneous power failure time			
	≥ 15 ms (Note 1)	>15 ms (Note 1)	≤ 100 ms (Note 2)	>100 ms (Note 2)
0	Operation continues	<ul style="list-style-type: none"> <li>• LU trip occurs and the inverter operates according to the start mode setting.</li> <li>• "LU" will be displayed and the fault alarm signal will be output.</li> </ul>		
1		<ul style="list-style-type: none"> <li>• Restart from 0 Hz after the waiting time has elapsed.</li> <li>• "LU" will be displayed, but the fault alarm signal will not be output.</li> </ul>		The inverter operates according to the start mode setting.
2		<ul style="list-style-type: none"> <li>• After the waiting time has elapsed, the inverter restarts at the frequency applied before the ride-through occurrence.</li> <li>• "LU" will be displayed, but the fault alarm signal will not be output.</li> </ul>		
3		<ul style="list-style-type: none"> <li>• After the waiting time has elapsed, the inverter will sense the motor rotation through speed search function and restart at the corresponding frequency.</li> <li>• "LU" will be displayed but the fault alarm signal will not be output.</li> </ul>		

(Note 1) This is the minimum time for operation at the rated output current. (The time may be longer depending on different models.)

(Note 2) This is the minimum time. (The time may be longer with higher rated capacity.) Even if the power failure time is relatively long



(approx. 1 min.), the inverter may sometimes restart after the power is restored. Therefore, inverter, motor and load equipments should be restarted after the power is restored for more than 4 minutes (waiting time + 2 minutes).

■ When voltage drop time is between 15 ms and 100 ms

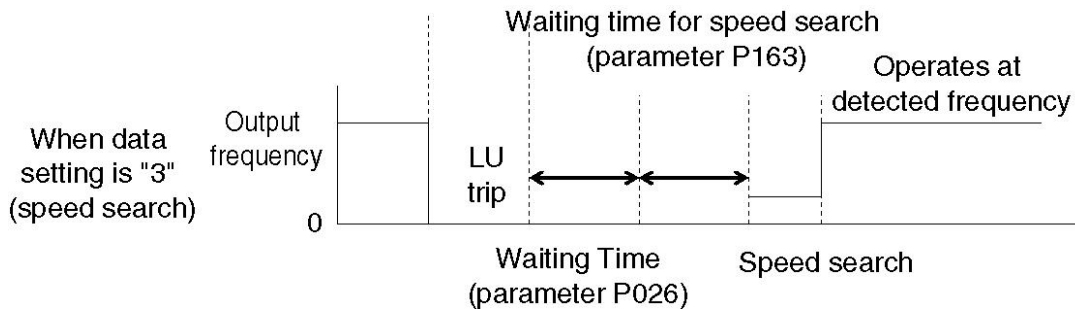
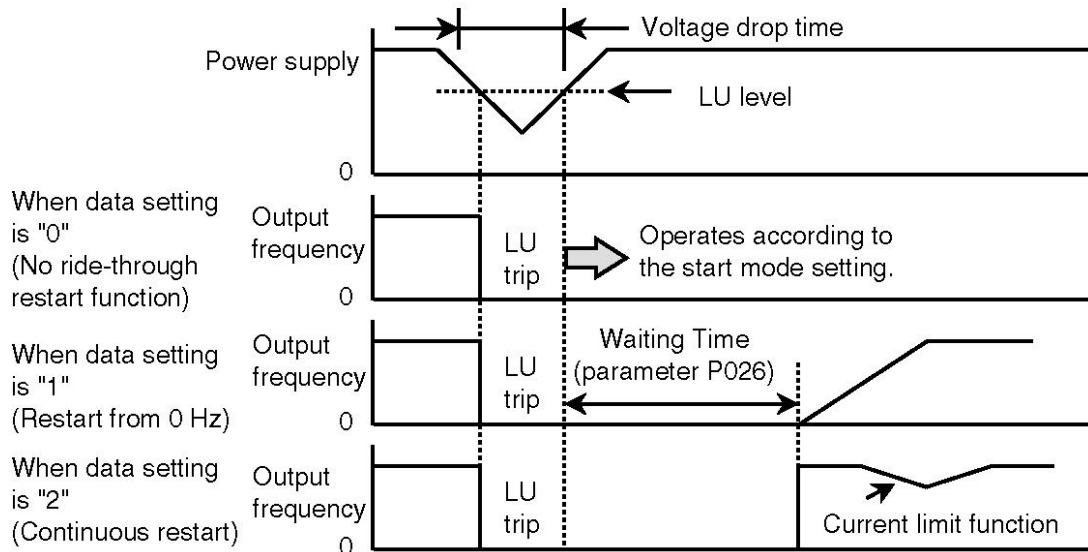

**【Note】**

- Waiting time can be set with parameter P026.

Related parameter: P026

**P026** Waiting Time

Waiting time required by the start mode, the ride-through restart and retry function can be set.

Data setting range (s)	0.1 to 100.0
------------------------	--------------

Related parameters: P022 to P025

**P027** Reverse Run Lock

When used only in forward run mode, reverse run can be disabled to avoid possible mishandling.

Setting value	Details
0	Reverse run operation enabled (Both forward run and reverse run operation enabled)
1	Reverse run disabled (Only forward run operation enabled)

**【Note】**

- When disabled, reverse run cannot be performed during the operation of panel, external control and communication.

Related parameter: P004

**P028** Stop Mode

Ramp-to-stop or coast-to-stop mode can be selected when stopping the inverter.

Setting value	Mode	Details
0	Ramp-to-stop	The inverter is stopped by the stop signal depending on the frequency decreased according to the deceleration time.
1	Coast-to-stop	The inverter output is shut off immediately by the stop signal.

## **P029** Start Frequency

---

The frequency at which the inverter output starts can be set during inverter start-up.

Data setting range (Hz)	0.5 to 60.0
----------------------------	-------------

### **【Note】**

---

---

- Please note that overcurrent may occur depending on setting values and load status if the data is changed during operation.

## **P030** Stop Frequency

---

The frequency at which the inverter output stops can be set when the inverter ramps to stop.

Data setting range (Hz)	0.5 to 60.0
----------------------------	-------------

Related parameters: P031 to P032

Please note that overcurrent may occur depending on setting values and load status if the data is changed during operation.

**P031** DC Brake Time**P032** DC Brake Level

DC brake can be applied when the inverter output frequency drops below “P030: Stop Frequency” during ramp-to-stop.

In addition, positioning control can be performed combining with JOG operation.

■ Parameter P031: DC Brake Time

Data setting range (s)	0000 • 0.1 to 120.0
------------------------	---------------------

\* The DC brake is not applied when "0000" is set.

■ Parameter P032: DC Brake Level

Data setting range (s)	0 to 100
------------------------	----------

\* The setting increment is “5”. The larger the value is, the stronger the braking force is.

■ Ramp-to-stop DC brake time (P031)

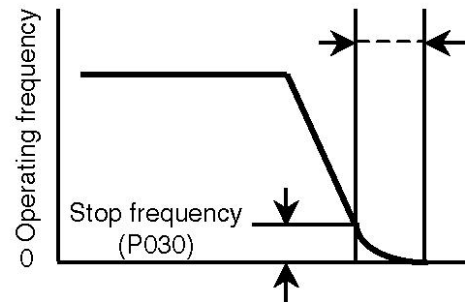

【Note】

- The frequency for applying the DC brake is set by parameter “P030: Stop Frequency”.
- DC brake during the switching between forward run and reverse run is set with parameter “P033: Stop Frequency during Forward/Reverse Run Operation”, “P034: DC Brake Time during Forward/Reverse Run Operation” and “P035: DC Brake Level during Forward/Reverse Run Operation”.

Related parameter: P030

**P033** Stop Frequency during Forward/Reverse Run Operation

**P034** DC Brake Time during Forward/Reverse Run Operation

**P035** DC Brake Level during Forward/Reverse Run Operation

DC brake can be applied when the inverter output frequency drops below “P033: Stop Frequency during Forward/Reverse Run Operation” during forward/reverse run operation.

■ Parameter P033: Stop Frequency during Forward/Reverse Run Operation

Data setting range (Hz)	0.5 to 60.0
-------------------------	-------------

■ Parameter P034: DC Brake Time during Forward/Reverse Run Operation

Data setting range (s)	0000 · 0.1 to 120.0
------------------------	---------------------

\* DC brake will be not applied if “0000” is set.

■ Parameter P035: DC Brake Level during Forward/Reverse Run Operation

Data setting range (s)	0 to 100
------------------------	----------

\* The setting increment is “5”. The larger the value is, the stronger the braking force will be.

■ During forward/reverse run

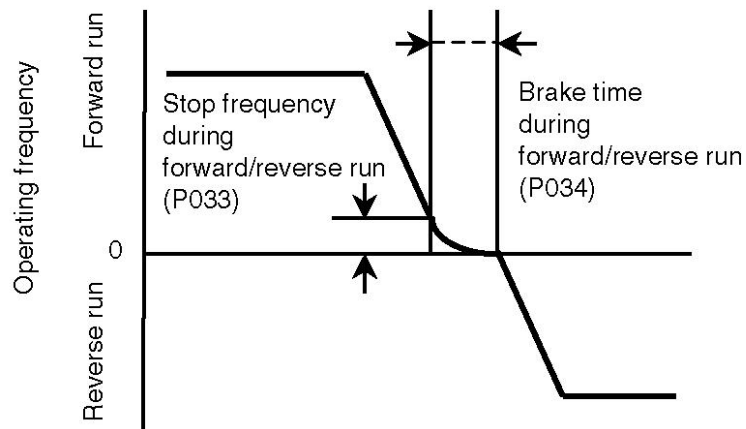

**【Note】**

- The frequency for applying DC brake is set with parameter “P033: Stop Frequency during Forward/Reverse Run Operation”.
- “P033: Stop Frequency during Forward/Reverse Run Operation” is valid only

when DC brake is applied during forward/reverse run operation.(It's valid when P034 is set to a value other than "0000".)

- To stop the inverter, DC brake can be set with parameter "P030: Stop Frequency", "P031: DC Brake Time" and "P032: DC Brake Level".

<b>P036</b>	SW1 Function Select
<b>P037</b>	SW2 Function Select
<b>P038</b>	SW3 Function Select
<b>P039</b>	SW4 Function Select
<b>P040</b>	SW5 Function Select

Control function of SW1, 2, 3, 4, 5 (control circuit terminal No. 4, 5, 6, 7, 8) can be set.

The SW to set the function	SW1 (terminal No.4)	SW2 (terminal No.5)	SW3 (terminal No.6)	SW4 (terminal No.7)	SW5 (terminal No.8)
Parameter No.	P036	P037	P038	P039	P040

Setting value	0	Multi-speed SW input	Multi-speed SW input	Multi-speed SW input	Multi-speed SW input	Multi-speed SW input
	1	Reset input	Reset input	Reset input	Reset input	Reset input
	2	Reset lock input	Reset lock input	Reset lock input	Reset lock input	Reset lock input
	3	JOG select input	JOG select input	JOG select input	JOG select input	JOG select input
	4	External fault stop input	External fault stop input	External fault stop input	External fault stop input	External fault stop input
	5	Parameter setting disable input	Parameter setting disable input	Parameter setting disable input	Parameter setting disable input	Parameter setting disable input
	6	Coast-to-stop input	Coast-to-stop input	Coast-to-stop input	Coast-to-stop input	Coast-to-stop input
	7	Frequency signal switch input	Frequency signal switch input	Frequency signal switch input	Frequency signal switch input	Frequency signal switch input
	8	The 2 <sup>nd</sup> characteristics select input	The 2 <sup>nd</sup> characteristics select input	The 2 <sup>nd</sup> characteristics select input	The 2 <sup>nd</sup> characteristics select input	The 2 <sup>nd</sup> characteristics select input
	9	PID control switch input	PID control switch input	PID control switch input	PID control switch input	PID control switch input
	10	3-wire stop command	3-wire stop command	3-wire stop command	3-wire stop command	3-wire stop command

Setting value	11	—	Pulse counter input	—	—	Frequency ▲ / ▼ setting
	12	Speed search	Speed search	Speed search	Speed search	Speed search
	13	Temporary stopping of winding mode	Temporary stopping of winding mode	Temporary stopping of winding mode	Temporary stopping of winding mode	Temporary stopping of winding mode
	14	Input mode of winding length	—	Clear winding length	—	—



### ■ Multi-speed SW Function

SW function is set so that it is used as multi-speed function.

Multi-speed function select is set with parameter P045.

- When all SWs are set to multi-speed function and 16-speed operation is performed, the four SWs with lower No. are valid as multi-speed command SW.

(Set “SW1 to SW5” to multi-speed function → Use SW1, SW2, SW3 and SW4 as multi-speed command.)

- Read “P045: Multi Speed Function Select” carefully before using this function.

(Refer to page 165)

Related parameters: P045 to P086

### ■ Reset Function

Fault stop status can be reset through external control if an inverter fault trip (stop) occurs.

When a fault trip occurs and SW signal input is turned ON, the fault trip status will be cleared if the SW signal input is turned OFF.

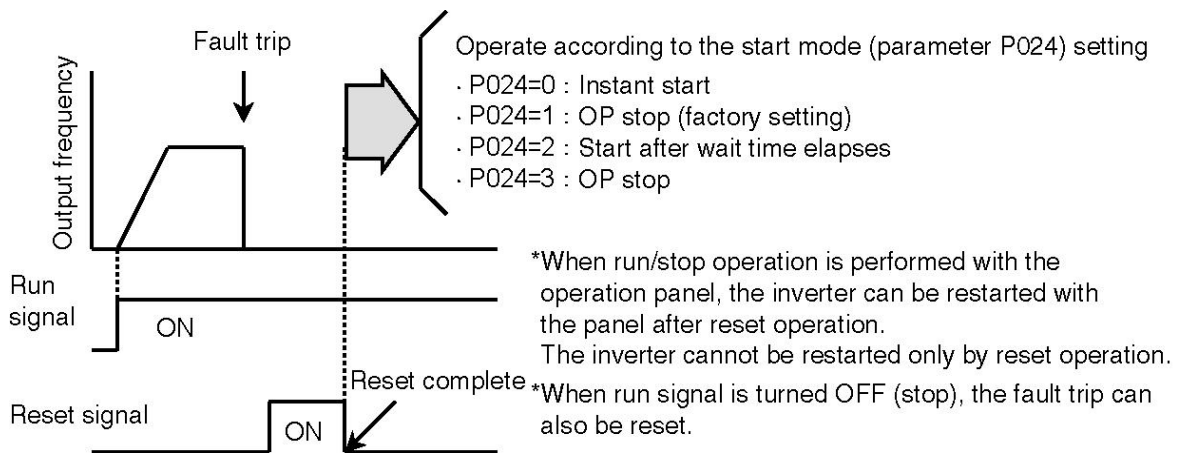

### ■ Reset Lock Function

When a fault trip occurs, clearing of fault trip status with stop signal is disabled to perform reset operation with SW signal after identifying the details of fault trip and eliminating the abnormality.

- Normally, SW signal is input with ON status.
- When a fault trip occurs, the inverter will maintain the trip status even if stop signal and reset signal are input.
- After the abnormality is identified and eliminated, the fault trip will be reset when this SW is turned OFF.

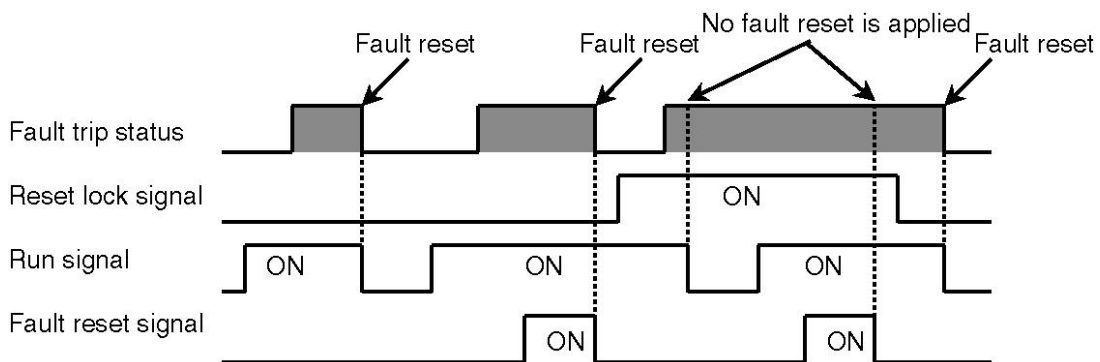

\* Turn reset lock signal OFF and press STOP button to reset the fault.  
In addition, turn the fault reset signal OFF.

### ■ JOG Function

Micro operations such as position adjustment can be performed with external control signals.

Signal input terminals for controlling micro operation from external devices can be set with parameter P036 to P040.

But Run Command Select (parameter P003) should be set through external control.

- Turn the signal input ON, and it will enter JOG operation mode.
- JOG operation is performed according to “P042: JOG Frequency”, “P043: JOG Acceleration Time” and “P044: JOG Deceleration Time” settings, after run/stop and forward/reverse run signals are input with terminal No.2 and No.3.

< Example > When SW1 (parameter P036 = 3) is set to JOG function and run command select (parameter P003 = 2) is used

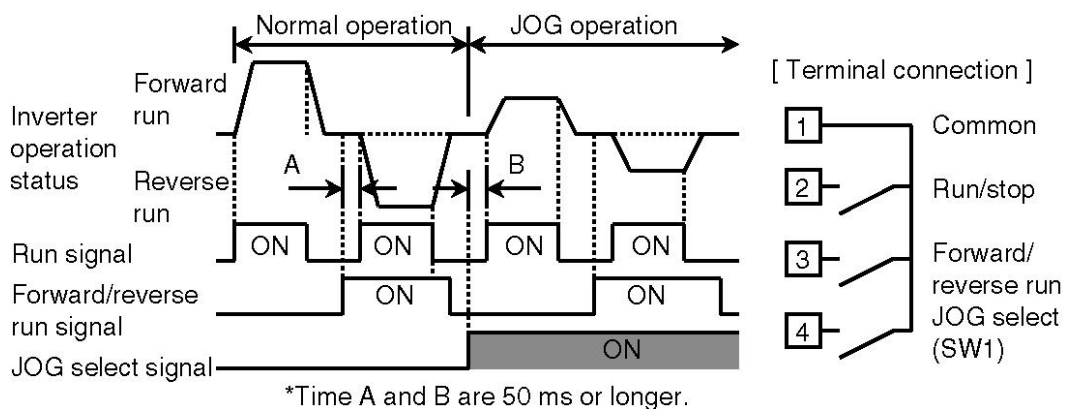

Note 1) During JOG operation, please turn the JOG select signal ON (time B) and then turn the run signal ON.

Note 2) During reverse run operation, please turn the reverse run signal ON (time A) and then turn the run signal ON.

Related parameters: P042 to P044

### ■ External Fault Stop Function

Signal input terminal for applying fault stop (emergency stop) to the inverter through external devices can be set.

- The inverter will stop output immediately after the external fault stop input (setting value = 4) turns SW signal ON and “AU” is displayed.
- Input signal logic setting (contact A and B input select) can be set with “P041: Input Logic Setting”.

< Example > When SW1 (parameter P036 = 4) is set to external fault stop, and input logic setting (P041 = 1) and run command select (parameter P003 = 2) are used

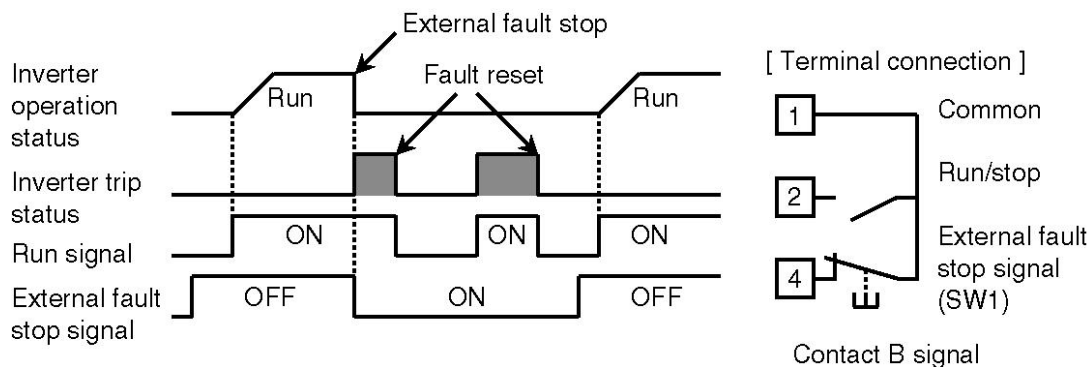

\* When external fault stop signal is set to contact B input, fault reset can be applied after run signal is turned OFF, even if external stop signal is “ON”. But fault trip will occur after the run signal is turned “ON” again. So please turn the run signal “ON” after the external fault stop signal being turned “OFF” for normal operation.

### ■ Parameter Setting Disable Function

The signal input terminal for disabling the parameter setting through external control can be set.

- After signal input is turned ON, setting parameters with the operation panel and communication are disabled.
- When the signal input is turned ON, function parameters and built-in memory parameters cannot be set but be monitored.
- During data setting, data cannot be changed even if SET button is pressed when the signal is ON.

■ Coast-to-stop Function

The signal input terminal for applying coast-to-stop through external control can be set.

- During operation, the inverter will stop output immediately after signal input is turned ON and “0.0” is displayed.

(without fault indication and fault alarm output)

- The inverter will run immediately after signal input is turned OFF and run signal is turned ON.

[Note] The inverter will start as the signal is turned OFF, so please ensure personal safety before operation.

---

- The inverter will stop normally after the run signal is turned OFF together with signal input being turned OFF.

< Example > When SW1 (parameter P036 = 6) is set to coast-to-stop and run command select (parameter P003 = 2) is used

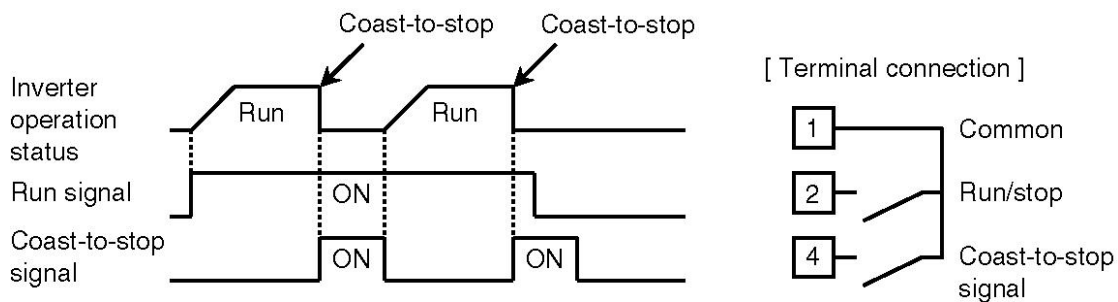

■ Frequency Signal Switching Function

Signal input terminal for switching frequency setting command from “The 1<sup>st</sup> Frequency Setting Signal (command set with parameter P004)” to “The 2<sup>nd</sup> Frequency Setting Signal (command set with parameter P125)” can be set. This function is valid when parameter “P124: The 2<sup>nd</sup> Analog Input Function Select” is set to “0: The 2<sup>nd</sup> Frequency Setting Signal”.

- When signal input is OFF: The 1<sup>st</sup> Frequency Setting Signal
- When signal input is ON: The 2<sup>nd</sup> Frequency Setting Signal

< Example > When SW1 (parameter P036 = 7) is set to frequency switching

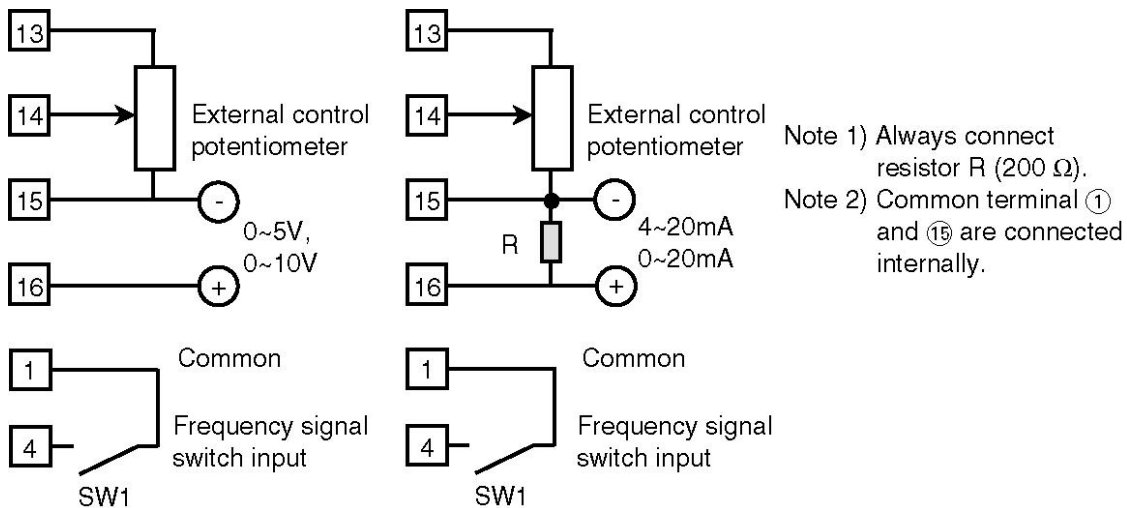

Related parameters: P124 to P127

■ The 2<sup>nd</sup> Characteristics Select Input

When SW signal is ON, the inverter will run according to the 2<sup>nd</sup> Characteristics Function settings as follows.

Switching button OFF		Switch button ON
P001: The 1 <sup>st</sup> Acceleration Time		P061: The 2 <sup>nd</sup> Acceleration Time
P002: The 1 <sup>st</sup> Deceleration Time		P062: The 2 <sup>nd</sup> Deceleration Time
P009: Base Frequency		P116: The 2 <sup>nd</sup> Base Frequency
P007: Torque Boost		P117: The 2 <sup>nd</sup> Torque Boost
P016: Electronic Thermal Select		P118: The 2 <sup>nd</sup> Electronic Thermal Select
P017: Thermal Current Setting		P119: The 2 <sup>nd</sup> Thermal Current Setting
P010: Change Point Frequency 1		P120: The 2 <sup>nd</sup> Change Point Frequency 1
P011: Change Point Voltage 1		P121: The 2 <sup>nd</sup> Change Point Voltage 1
P012: Change Point Frequency 2		P122: The 2 <sup>nd</sup> Change Point Frequency 2
P013: Change Point Voltage 2		P123: The 2 <sup>nd</sup> Change Point Voltage 2
P130: Motor Capacity		P158: The 2 <sup>nd</sup> Motor Capacity
P131: Motor Pole Number		P159: The 2 <sup>nd</sup> Motor Pole Number
P133: Voltage Compensation Constant		P160: The 2 <sup>nd</sup> Voltage Compensation Constant
P134: Slip Compensation Frequency		P161: The 2 <sup>nd</sup> Slip Compensation Frequency

Note) Ensure personal safety before switching characteristics.

■ PID Control Switching Function

Signal input terminal for cancelling PID control through external control can be set. When the signal input is turned ON, the inverter switches from “PID control” to the the command set with parameter P004.

The function is valid when parameter “P124: The 2<sup>nd</sup> Analog Input Function Select” is set to “1 to 3”.

- When the signal input is OFF: PID control or control based on auxillary frequency signal
- When the signal input is ON: command set with parameter P004

< Example > When SW1 (parameter P036 = 9) is set to frequency switching

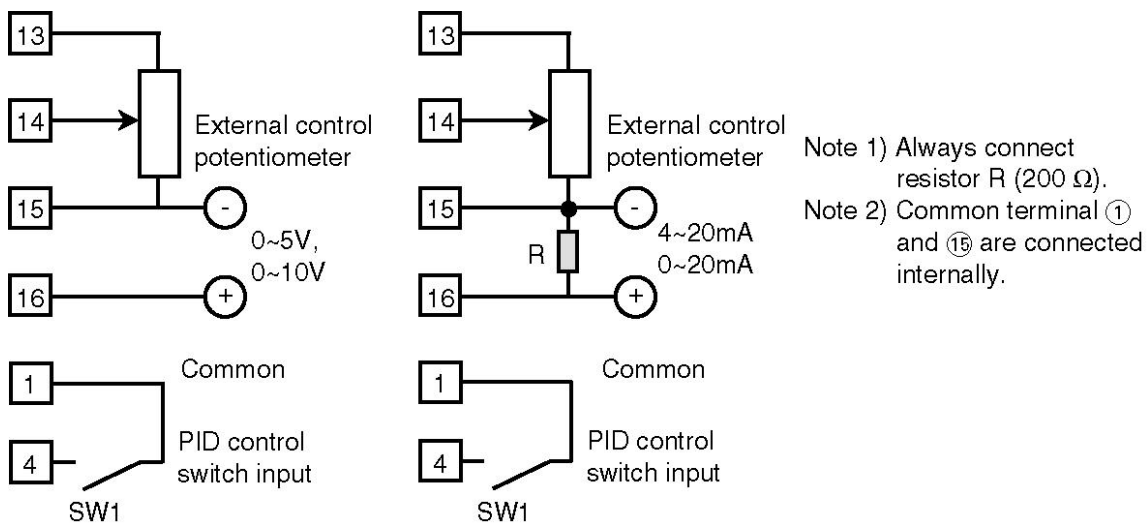

Related paremeters: P004, P124, P101 to P104



■ 3-wire Stop Command Function

Signal input terminal for executing 3-wire stop command can be set.

When “3-wire stop signal” is ON, “run signal” or “forward/reverse run operation” can be held automatically. Also, switching to OFF will cancel the holding status.

- Please set “Run Command Select” (parameter P003).
- The input signal of 3-wire stop command is “contact B input”. (regardless of “P041: Input Logic Setting”)

Related parameter: P003

■ Pulse Counter Input Function

The function can be set during multi-speed operation by inputting pulses (P045 = 5, 6). Pulse input signal is sent to SW2 (terminal No.5) and number of pulses is counted up.

The function is valid when setting of “P045: Multi Speed Function Select” is “5” or “6”.

Count the number of OFF→ON rising edges.

- For details of pulse input during multi speed operation, read “P045: Multi Speed Function Select” carefully before using the function. (Refer to P.165)

Related parameters: P001, P002, P045 to P052, P061 to P066, P079 to P086

### ■ Frequency ▲/▼ Setting Function

When frequency and parameter P040 are set to “digital setting with operation panel (P004 = 1)” and “11” respectively, SW3 and SW4 can be used to change frequency while SW5 to save this frequency.

- It is forced to be used as function input terminal of “SW3: frequency increase SW”, “SW4: frequency decrease SW” and “SW5: frequency memory SW” after parameter P040 is set to “11”.

- SW3: During ON, frequency increases. (During OFF, the existing frequency is held.)

- SW4: During ON, frequency decreases. (During OFF, existing frequency is held.)

- SW5: Turn ON once and OFF again to save the frequency at that time.)

(The frequency can be saved even if the power is turned OFF.)

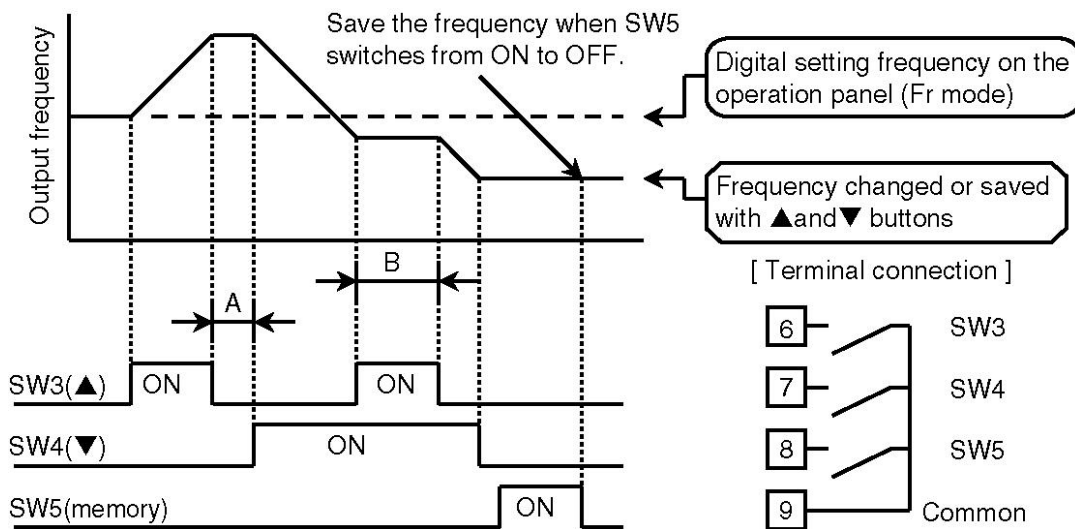

Note 1) The operating frequency will not be changed when both ▲ button (SW3) and ▼ button (SW4) are turned OFF or ON (i.e. in A or B area etc).

Note 2) The operating frequency will not be saved when “frequency memory operation of SW5” and “frequency setting in frequency setting mode” on the operation panel are not performed.

**【Note】**

---

---

- ON/OFF status of each SW can be set to “contact A input” or “contact B input” with parameter “P041: Input Logic Setting”. When using each SW function, please note the setting of parameter P041.
- When parameter “P154: MOP Function Select” is set to “1”, the acceleration/deceleration time set with parameter “P155: Acceleration/Deceleration Time for MOP Operation” will be used.

Related parameters: P004, P154, P155

## ■ Speed Search Function

- The inverter will apply minor DC voltage to the motor, detect its rotation speed and restart it at this frequency when the motor rotates freely due to inertia, which is the so-called “speed search function”.

- There are 3 methods to start speed search.

1) Through input signal from control terminals (SW1 to SW5)

Related parameters: P036 to P040 (SW1 to SW5 Function Select)

2) During motor startup

Related parameter: P162 (Speed Search Select during Startup)

3) During retry operation of inverter after fault trip occurrence

Related parameters: P022 (Retry Function), P165 (Speed Search Select during Retry)

- Perform speed search according to the following procedures.

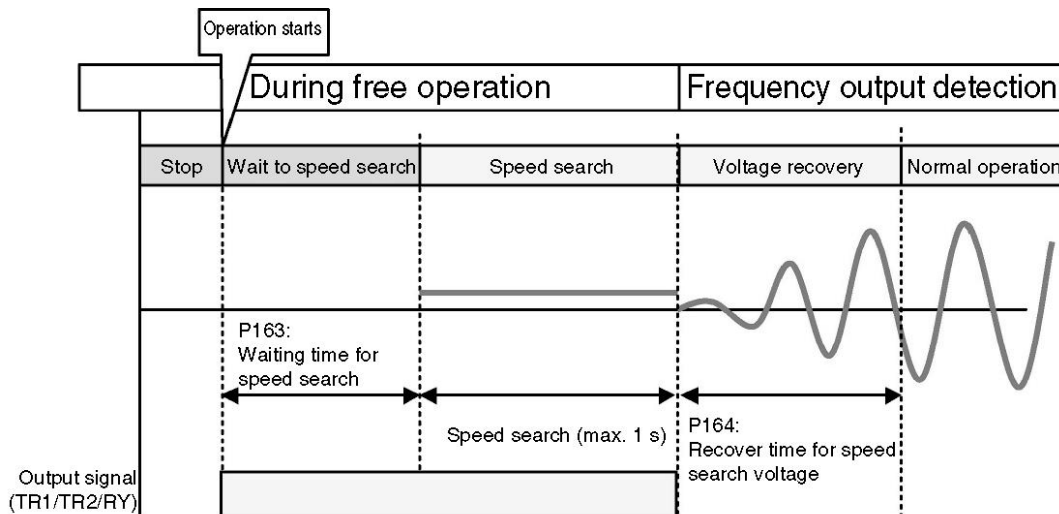

When P090 to P092 are set to "12", the output signal is ON.

- Conditions of speed search can be set with parameter P163 to P168.

## 【Note】

- To start speed search with control input is only valid during free operation. Therefore, even if the control input assigned to speed search is ON, the speed search will nevertheless be ignored.

- If the rotation speed is too low and the rotation direction does not match the rotation command, the rotation speed may not be sensed.

- The sensing function may fail if the speed search is performed for the motor with capacity smaller than the inverter.
- “CAL” will be displayed on the operation panel during speed search. During the displaying, there is minor DC voltage applied on the motor externally.

■ Winding Mode Control Function

- Winding mode control function will operate at the triangular-wave-shaped frequency as shown in the following graph.

- When parameter “P169: Coiling Mode Control Select” is set to “1” or “2”, winding mode control function will start after run comm and is turned ON.

During startup, the inverter will keep on accelerating within the time set with parameter “P001: The 1<sup>st</sup> Acceleration Time” until the set frequency is reached.

- The conditions of winding mode control are set with parameter P169 to P173.

- The operational mode of winding mode is set by parameter "P178:Winding Mode Operation Select". When parameter "P178" is set to "1" or "3", 2-point mode start.

Set frequency of second point by parameter "P046: second frequency", set stop length by parameter "P182: winding stop length", basic frequency will increase by the winding length and line feature will change, when winding length arrive stop length, will change to second frequency. When P178 is set to "2" or "3", random mode start, set random change range by parameter "P179: max random rise time ratio" and "P180: minimum random rise time ratio", and when P179<P180, random function doesn't start. Especially, when P178 is set to "3", it will be 2-point random mode, basic frequency will change from fixed frequency to second frequency by winding length. And, rise time ratio change randomly in the random rage.

- When parameter “P036 to P040: SW1 to SW5 Function Select” is set to “13”, and SW input of corresponding control input terminals (SW1 to SW5) are ON, the inverter will terminate winding mode control and continue to run at the frequency when SW input (SW1 to SW5) is turned ON.

- When stop command is turned ON, the deceleration will be performed to stop the inverter according to the value set with parameter “P002: The 1<sup>st</sup> Deceleration Time” regardless of operating frequency.

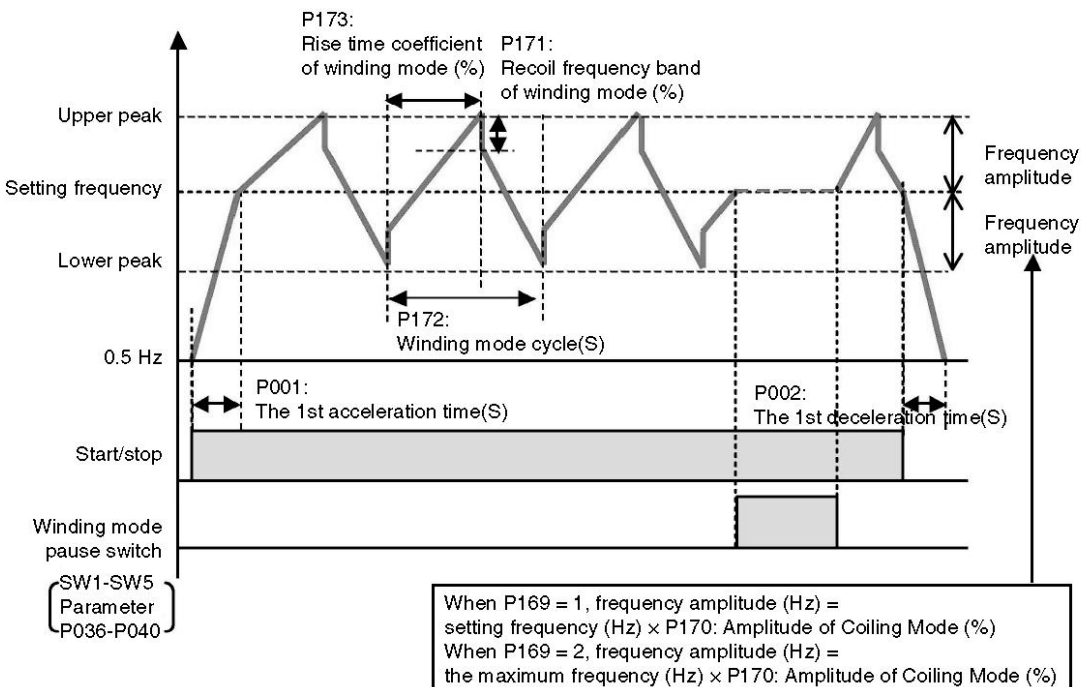

**【Note】**

If the following functions start together with winding mode control function, such function will take precedence. And what's more, winding mode control will not start when the following functions operate.

- Trial operation function
- Automatic tuning function
- Timer operation function
- PID function

**■ Winding mode input length**

When set parameter "P169: Winding mode control select" to "1" or "2", set parameter "P036: SW1 function select" to "14", and pulse input in SW1, length can be calculated by "P181: Winding length magnification".

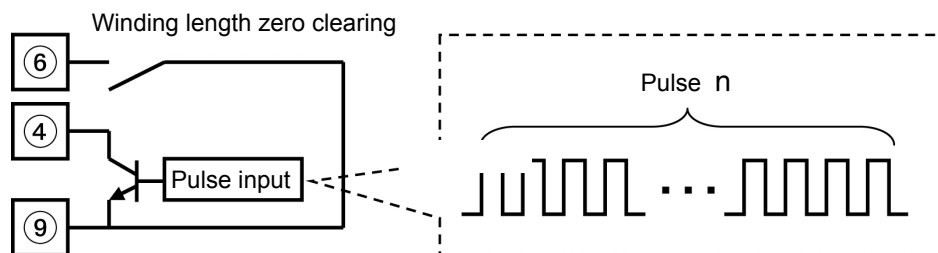

- The calculate result will be displayed in n027.

$$\text{Winding length} = \frac{(n \times \text{Winding length radio})}{1000}$$

- Set "P038: SW3 function select" to "14", the calculate value will be cleared.

## P041 Input Logic Setting

Input signals can be detected by selecting “A contact input” or “B contact input”.

### ■ Setting value

- Contact A input = “0” : When SW (button) signal is OFF (terminal level is “L”), ON will be detected.
- Contact B input = “1” : When SW (switch) signal is ON (terminal level is “H”), ON will be detected.

### ■ Setting method

- Convert bit 0 to 4 to DEC format for input.
- Input the sum of setting value × addition value into the setting data.

< Operation Example > When SW1 and SW2 are “B contact input” and the other signals are “A contact input”

$$\text{Setting value} = (0 \times 16) + (0 \times 8) + (0 \times 4) + (1 \times 2) + (1 \times 1) = 3$$

Terminal name	Without setting	SW5	SW4	SW3	SW2	SW1
Terminal No.	-	⑧	⑦	⑥	⑤	④
Bit	5 to 15	4	3	2	1	0
Setting value	0 / 1	0 / 1	0 / 1	0 / 1	0 / 1	0 / 1
Addition value	-	16	8	4	2	1

### 【Note】

- Due to the fact that ON/OFF status of each SW will change with the input logic setting, so check the input logic setting before using.
- Forward/reverse run and run/stop are fixed to “contact A input”.
- When each SW function is set to “3-wire stop command function”, “contact B input” always applies even if “Input Logic Setting” is set to “contact A input”.

Related parameters: P036 to P040



**P042** JOG Frequency

**P043** JOG Acceleration Time

**P044** JOG Deceleration Time

---

Operating frequency and acceleration/deceleration time during JOG operation can be set.

■ Parameter P042: JOG Frequency

Data setting range (Hz)	0.5 to 400.0
-------------------------	--------------

■ Parameter P043: JOG Acceleration Time

Data setting range (s)	0.04· 0.1 to 3600
Increment (s)	0.1 (0.1 to 999.9), 1 (1000 to 3600)

- The display code for 0.04 s is “0000”.

■ Parameter P044: JOG Deceleration Time

Data setting range (s)	0.04· 0.1 to 3600
Increment (s)	0.1 (0.1 to 999.9), 1 (1000 to 3600)

- The display code for 0.04 s is “0000”.

**【Note】**

---

- “Run command select” must be set to external control. (Parameter P003 can be set to “2~5”.)
- “SW function select” must be set to “JOG function”.
- When SW set to JOG function is turned ON, the inverter will enter JOG operation ready status.
- Perform JOG run/stop and forward/reverse run with terminal No.2 and No.3.
- Refer to function descriptions on page 172.
- JOG frequency under vector control is 1 Hz to 120 Hz.

Related parameters: P003, P036 to P040

## P045 Multi-speed Function Select

When SW1 to SW5 (control circuit terminal No.4 to No.8) are set as multi speed function with parameter P036 to P040 and SW2 (control circuit terminal No.5) is set as pulse counter input function with parameter P037, each control function can be set through the parameter.

Setting value	Details
0	Set to "multi-speed frequency operation"
1	Set to "2 <sup>nd</sup> /3 <sup>rd</sup> /4 <sup>th</sup> acceleration/deceleration operation"
2	Set to "acceleration/deceleration linked with multi-speed frequency operation"
3	Set to "multi-speed frequency operation using timer"
4	Set to "acceleration/deceleration linked with multi-speed frequency operation using timer"
5	Set to "multi-speed frequency operation using pulse input"
6	Set to "acceleration/deceleration linked with multi-speed frequency operation using pulse input"

When setting value is "0" to "2", set SW1 to SW5 (control circuit terminal No.4 to No.8) to "multi-speed function" (setting value = "0") with parameter P036 to P040. When setting value is "3" to "4", SW1 to SW5 (control circuit terminal No.4 to No.8) are invalid even if they are set to "multi speed function" with parameter P036 to P040.

When setting value is "5" to "6", set SW2 (control circuit terminal No.5) to "pulse counter input function" (i.e. setting value "11") with parameter P037.

Multi-speed frequency operation (setting value = "0")  
 The 2<sup>nd</sup>/3<sup>rd</sup>/4<sup>th</sup> acceleration/deceleration operation (setting value = "1")  
 Acceleration/deceleration linked with multi-speed frequency operation (setting value = "2")

■ Setting value = “1”: multi-speed frequency operation

Up to 16 steps can be set by SW in multi-speed frequency operation.

Acceleration/deceleration time is fixed to “the 1<sup>st</sup> Acceleration/Deceleration Time” (parameter P001, P002).

When functions of SW1 to SW5 are all set to “0” (multi-speed SW input function), 4 SWs (starting from the one with the smallest No.) can be valid as multi-speed command SW.

The 2<sup>nd</sup> to 16<sup>th</sup> speed frequency are set with parameter P046 to P060.

■ Setting value = “2”: The 2<sup>nd</sup>/3<sup>rd</sup>/4<sup>th</sup> acceleration/deceleration operation

When the frequency is fixed to the 1<sup>st</sup> speed, up to 4 acceleration/deceleration times can be changed through SW.

The 2<sup>nd</sup> to 4<sup>th</sup> acceleration/deceleration time can be set with parameter P061 to P066.

■ Setting value = “3”: acceleration/deceleration linked with multi-speed frequency operation

4 SWs can be used to link up to 16 speed steps and 4 acceleration/deceleration times to perform multi-speed frequency operation.

SW1 (Note 1)	SW2 (Note 1)	SW3 (Note 1)	SW4 (Note 1)	Multi-speed frequency operation		The 2 <sup>nd</sup> /3 <sup>rd</sup> /4 <sup>th</sup> acceleration/deceleration function		Acceleration/deceleration linked with multi-speed frequency operation	
				P045 = 0		P045 = 1		P045 = 2	
				Frequency	Acceleration/deceleration time	Frequency	Acceleration/deceleration time	Frequency	Acceleration/deceleration time
OFF	OFF	OFF	OFF	The 1 <sup>st</sup> speed	The 1 <sup>st</sup> acceleration/deceleration	The 1 <sup>st</sup> speed	The 1 <sup>st</sup> acceleration/deceleration	The 1 <sup>st</sup> speed	The 1 <sup>st</sup> acceleration/deceleration
ON	OFF	OFF	OFF	The 2 <sup>nd</sup> speed			The 2 <sup>nd</sup> acceleration/deceleration	The 2 <sup>nd</sup> speed	The 2 <sup>nd</sup> acceleration/deceleration
OFF	ON	OFF	OFF	The 3 <sup>rd</sup> speed			The 3 <sup>rd</sup> acceleration/deceleration	The 3 <sup>rd</sup> speed	The 3 <sup>rd</sup> acceleration/deceleration
ON	ON	OFF	OFF	The 4 <sup>th</sup> speed			The 4 <sup>th</sup> acceleration/deceleration	The 4 <sup>th</sup> speed	The 4 <sup>th</sup> acceleration/deceleration

SW1 (Note 1)	SW2 (Note 1)	SW3 (Note 1)	SW4 (Note 1)	Multi-speed frequency operation		The 2 <sup>nd</sup> /3 <sup>rd</sup> /4 <sup>th</sup> acceleration/ deceleration function		Acceleration/ deceleration linked with multi-speed frequency operation	
				P045 = 0		P045 = 1		P045 = 2	
				Frequency	Acceleration/ deceleration time	Frequency	Acceleration/ deceleration time	Frequency	Acceleration/ deceleration time
OFF	OFF	ON	OFF	The 5 <sup>th</sup> speed	The 1 <sup>st</sup> acceleration/ deceleration	The 1 <sup>st</sup> speed	The 1 <sup>st</sup> acceleration/ deceleration	The 5 <sup>th</sup> speed	The 1 <sup>st</sup> acceleration/ deceleration
ON	OFF	ON	OFF	The 6 <sup>th</sup> speed				The 6 <sup>th</sup> speed	
OFF	ON	ON	OFF	The 7 <sup>th</sup> speed				The 7 <sup>th</sup> speed	
ON	ON	ON	OFF	The 8 <sup>th</sup> speed				The 8 <sup>th</sup> speed	
OFF	OFF	OFF	ON	The 9 <sup>th</sup> speed				The 9 <sup>th</sup> speed	
ON	OFF	OFF	ON	The 10 <sup>th</sup> speed				The 10 <sup>th</sup> speed	
OFF	ON	OFF	ON	The 11 <sup>th</sup> speed				The 11 <sup>th</sup> speed	
ON	ON	OFF	ON	The 12 <sup>th</sup> speed				The 12 <sup>th</sup> speed	
OFF	OFF	ON	ON	The 13 <sup>th</sup> speed				The 13 <sup>th</sup> speed	
ON	OFF	ON	ON	The 14 <sup>th</sup> speed				The 14 <sup>th</sup> speed	
OFF	ON	ON	ON	The 15 <sup>th</sup> speed				The 15 <sup>th</sup> speed	
ON	ON	ON	ON	The 16 <sup>th</sup> speed				The 16 <sup>th</sup> speed	

(Note 1) When the functions of any 4 of SW1 to SW5 are set to "0" (multi-speed SW input function), the four SWs (starting from the one with the smallest No.) can be valid as multi-speed command SW.

< Example > When SW1, SW2, SW4 and SW5 are set to multi-speed SW input function, SW4 and SW5 will be allocated to the column (see Table above) previously occupied by SW3 and SW4.

■ Setting value = “1”: Example of multi-speed frequency operation function  
 Up to sixteen levels of frequency can be selected, switched and controlled by 4 button signals.

(The 1<sup>st</sup> speed: setting signal of P004, the 2<sup>nd</sup> to 16<sup>th</sup> speed: setting frequency of P046 to P060)

- Set any 4 buttons of SW1 to SW5 to multi-speed function buttons.

(When setting of P036 to P040 is “0”)

- With this function, 1 button, 2 buttons and 3 buttons are used to input 2-step speed, 4-step speed and 8-step speed respectively.

- The inverter will stop (0 V stop) when the 2<sup>nd</sup> to 16<sup>th</sup> speed frequency (P046 to P060) are set to “0000” and this multi-speed frequency is selected.

<When SW2 to SW5 are set to multi-speed SW input function>

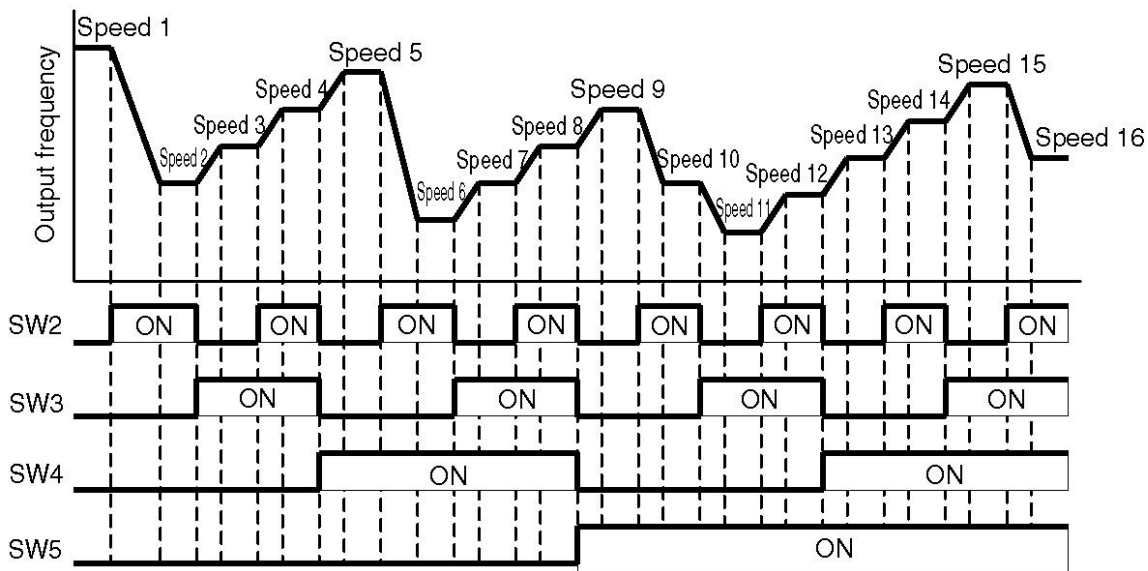

■ Setting value = “2”: Example of the 2<sup>nd</sup>, 3<sup>rd</sup> and 4<sup>th</sup> acceleration/deceleration operation function

Four groups of acceleration/deceleration times can be selected, switched and controlled with two SW signals.

(The 1<sup>st</sup> acceleration/deceleration time: P001 and P002, the 2<sup>nd</sup> to 4<sup>th</sup> acceleration/deceleration time: P061 to P066)

- Set any two buttons of SW1 to SW5 to multi-speed function buttons. (When setting of P036 to P040 is “0”)

<When SW1 and SW2 are set to multi-speed SW input function>

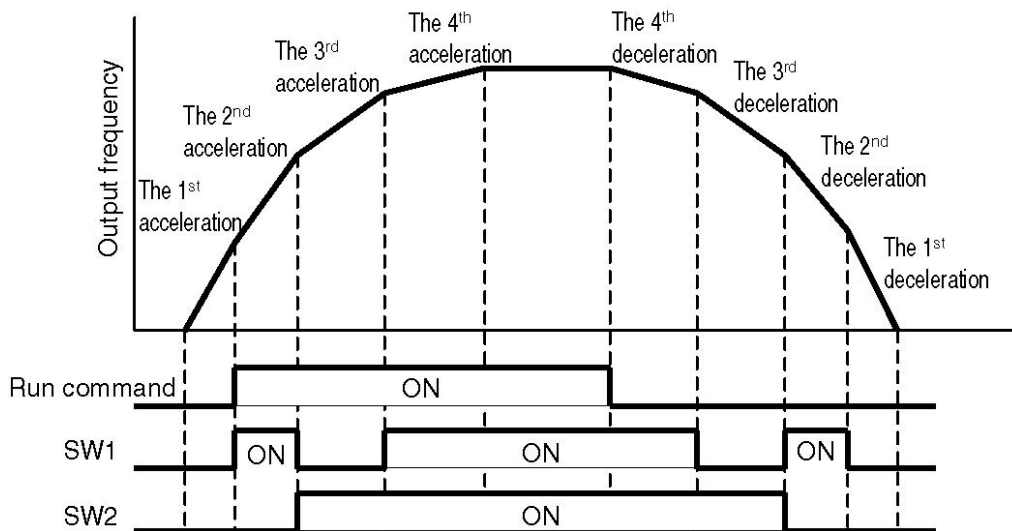

■ Setting value = “3”: Example of acceleration/deceleration linked with multi-speed frequency operation

The 2<sup>nd</sup>, 3<sup>rd</sup> and 4<sup>th</sup> speed can be linked (combined) with the 2<sup>nd</sup>, 3<sup>rd</sup> and 4<sup>th</sup> acceleration/deceleration by using two SW signals.

- Set any 2 buttons of SW1 to SW5 to multi-speed function buttons. (When setting of P036 to P040 is “0”)

<When SW1 and SW2 are set to multi-speed SW input function>

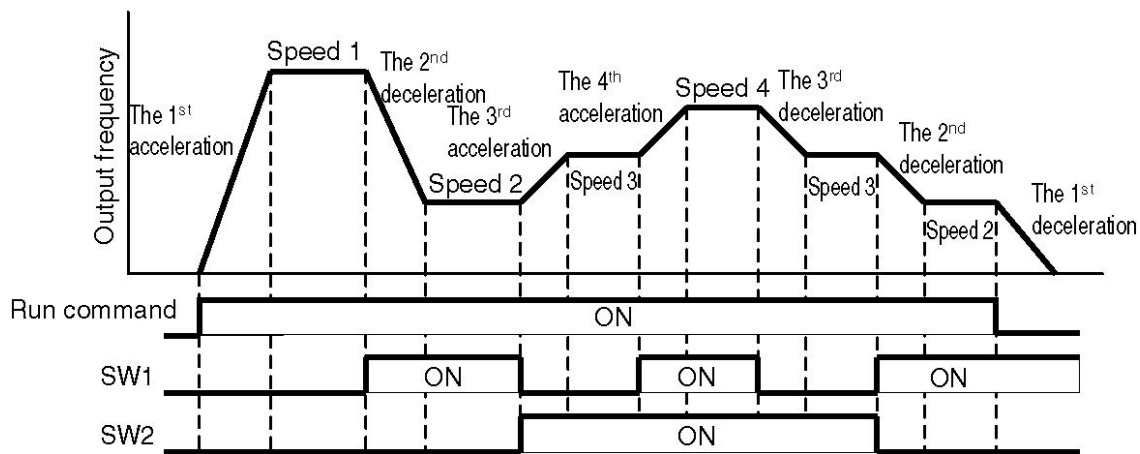

**【Note】**

- The 1<sup>st</sup> speed is command value of frequency setting signal set with parameter P004.
- The 1<sup>st</sup> acceleration time is set with parameter P001.  
The 1<sup>st</sup> deceleration time is set with parameter P002.
- The 2<sup>nd</sup> to 16<sup>th</sup> speed frequency can be set with parameter P046 to P060.  
The 2<sup>nd</sup> to 4<sup>th</sup> acceleration/deceleration time is set with parameter P061 to P066.

Related parameters: P036 to P041, P046 to P066

Multi-speed frequency operation by timer (setting value = “3”)  
Acceleration/deceleration linked with multi-speed frequency operation by timer (setting value = “4”)

■ Setting value = “3”: multi-speed frequency operation by timer

During multi-speed frequency operation using timer, the acceleration/deceleration time can be fixed to 8 steps. When the run command is input, the inverter will automatically switch to the next speed after operating within the setting time.

When SW1 to SW5 are set to “multi-speed SW input function”, even if signals are input during timer multi-speed operation using timer, such signals will be invalid and the operation will continue.

Rotation direction and continuous operation times of timer during one cycle can be set with parameter “P067: Rotation Direction of Timer Operation” and “P068: Continuous Operation Times of Timer” respectively. Operation mode and waiting time for timer operation from the end of one cycle to the next one can be set with parameter “P069: Continuous Operation Mode of Timer” and “P070: Continuous Waiting Time of Timer Operation”. Runtime for the 1<sup>st</sup> to 8<sup>th</sup> speed can be set with parameter “P071 to P078: The 1<sup>st</sup> to 8<sup>th</sup> Speed Runtime”.



■ Setting value = “4”: aceleration/deceleration linked with multi-speed frequency operation using timer

Up to 8 steps of speeds and 4 acceleration/deceleration times can be linked to perform multt-speed operation using timer.

Multi-speed frequency operation by timer				Aceleration/deceleration linked with multi-speed frequency operation by timer			
P045 = 3				P045 = 4			
Rotation direction (selected bit)	Frequency	Runtime	Acceleration/ deceleration time	Rotation direction (selected bit)	Frequency	Runtime	Acceleration/ deceleration time
Forward/ reverse run 0 / 1	The 1 <sup>st</sup> speed ①	The 1 <sup>st</sup> speed runtime T1	The 1 <sup>st</sup> acceleration time A1 The 1 <sup>st</sup> deceleration time D1	Forward/ reverse run 0 / 1	The 1 <sup>st</sup> speed ①	The 1 <sup>st</sup> speed runtime T1	The 1 <sup>st</sup> acceleration/ deceleration time A1/D1
Forward/ reverse run 0 / 1	The 2 <sup>nd</sup> speed ②	The 2 <sup>nd</sup> speed runtime T2		Forward/ reverse run 0 / 1	The 2 <sup>nd</sup> speed ②	The 2 <sup>nd</sup> speed runtime T2	The 2 <sup>nd</sup> acceleration/ deceleration time A2/D2
Forward/ reverse run 0 / 1	The 3 <sup>rd</sup> speed ③	The 3 <sup>rd</sup> speed runtime T3		Forward/ reverse run 0 / 1	The 3 <sup>rd</sup> speed ③	The 3 <sup>rd</sup> speed runtime T3	The 3 <sup>rd</sup> acceleration/ deceleration time A3/D3
Forward/ reverse run 0 / 1	The 4 <sup>th</sup> speed ④	The 4 <sup>th</sup> speed runtime T4		Forward/ reverse run 0 / 1	The 4 <sup>th</sup> speed ④	The 4 <sup>th</sup> speed runtime T4	The 4 <sup>th</sup> acceleration/ deceleration time A4/D4
Forward/ reverse run 0 / 1	The 5 <sup>th</sup> speed ⑤	The 5 <sup>th</sup> speed runtime T5		Forward/ reverse run 0 / 1	The 5 <sup>th</sup> speed ⑤	The 5 <sup>th</sup> speed runtime T5	The 1 <sup>st</sup> acceleration/ deceleration time A1/D1
Forward/ reverse run 0 / 1	The 6 <sup>th</sup> speed ⑥	The 6 <sup>th</sup> speed runtime T6		Forward/ reverse run 0 / 1	The 6 <sup>th</sup> speed ⑥	The 6 <sup>th</sup> speed runtime T6	
Forward/ reverse run 0 / 1	The 7 <sup>th</sup> speed ⑦	The 7 <sup>th</sup> speed runtime T7		Forward/ reverse run 0 / 1	The 7 <sup>th</sup> speed ⑦	The 7 <sup>th</sup> speed runtime T7	
Forward/ reverse run 0 / 1	The 8 <sup>th</sup> speed ⑧	The 8 <sup>th</sup> speed runtime T8		Forward/ reverse run 0 / 1	The 8 <sup>th</sup> speed ⑧	The 8 <sup>th</sup> speed runtime T8	

■ Example: mode for one cycle of timer operation

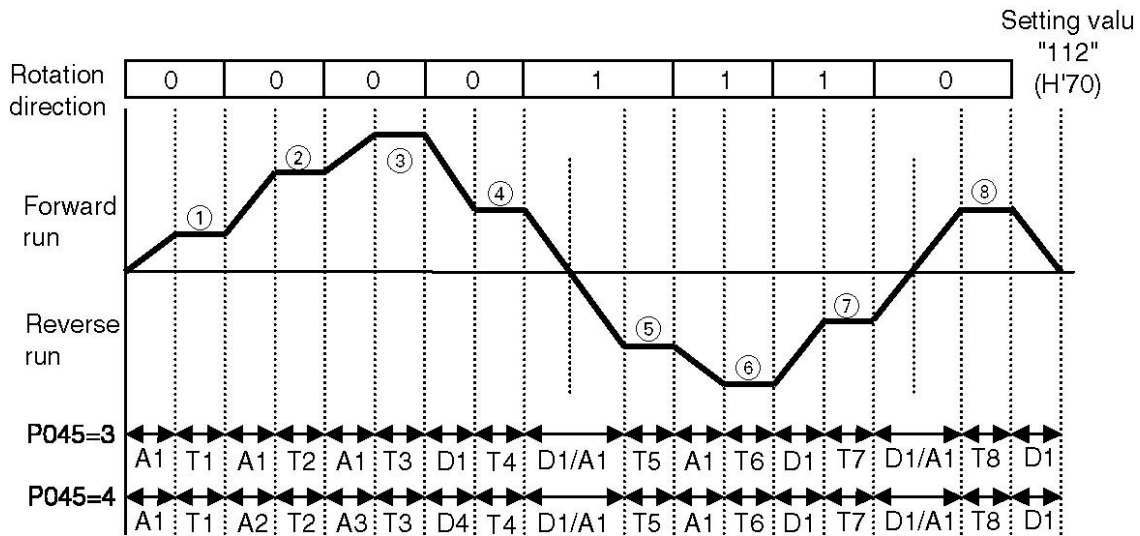

\* Setting value of "P069: Continuous Mode of Timer Operation" = "0".  
 Setting value of "P067: Rotation Direction of Timer Operation" = "112".

After the timer runs one cycle for times set with parameter "P068: Continuous Operation Times of Timer", "tEnd" will be displayed. Then the timer will return to "0000" (operation status mode) after stop command is input with "tEnd" displayed.

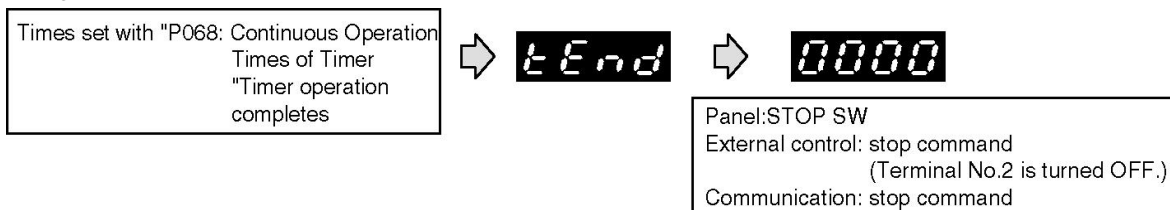

**【Note】**

- During timer operation, forward/reverse run commands input from operation panel, external control and communication are invalid.
- During timer operation, operation will be stopped immediately even in cycle operation when the stop command is input.

Related parameters: P001, P002, P036 to P041, P046 to P052, P061 to P078

Multi-speed frequency operation using pulse input (setting value = "5")  
Acceleration/deceleration linked with multi-speed frequency operation using pulse input (setting value = "6")

■ Setting value = "5": multi-speed frequency operation using pulse input  
The acceleration/deceleration time can be fixed to 8 steps at most by using SW2 to input pulses to perform multi-speed frequency operation. The speed will automatically switch to the next step after run command and the set pulse are input.

Please set "P037: SW2 Function Select" to "11". Detect the number of OFF→ON rising edges. Rotation direction and continuous operation times of timer during one cycle can be set with parameter "P067: Rotation Direction of Timer Operation" and "P068: Continuous Operation Timers of Operation" respectively. Operation mode and waiting time for timer operation from the end of one cycle to the next one can be set with parameter "P069: Continuous Mode of Timer Operation" and "P070: Continuous Waiting Time of Timer Operation". Times of pulse input for the 1<sup>st</sup> to 8<sup>th</sup> speed can be set with parameter "P079 to P086: The 1<sup>st</sup> to 8<sup>th</sup> Pulse Input Times".

■ Setting value = "6": acceleration/deceleration linked with multi-speed frequency operation using pulse input

Up to eight speed steps and four acceleration/deceleration times can be set by using SW2 to input pulses to perform multi-speed frequency operation.

Please set "P037: SW2 Function Select" to "11". Detect the number of OFF→ON rising edges.

<About pulse input to SW2>

Input the following pulses into SW2.

- Min. cycle: 100 ms
- Min. ON width: 50 ms
- Min. OFF width: 50 ms

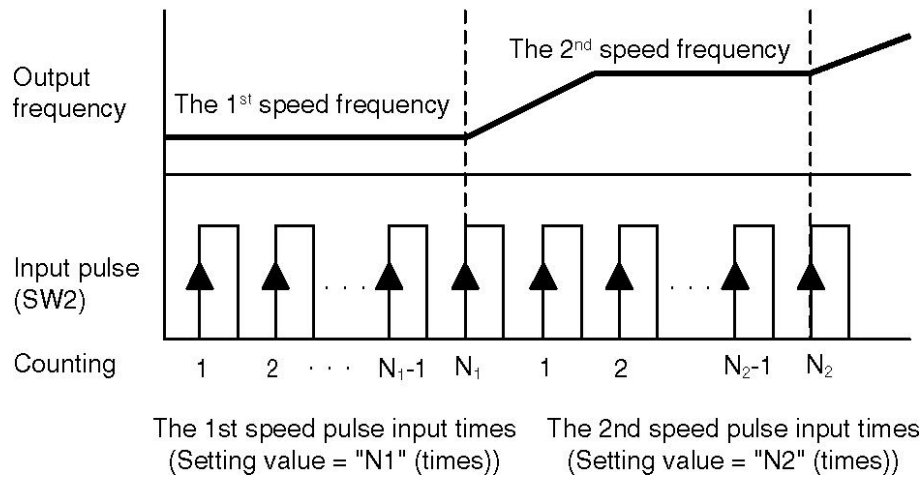
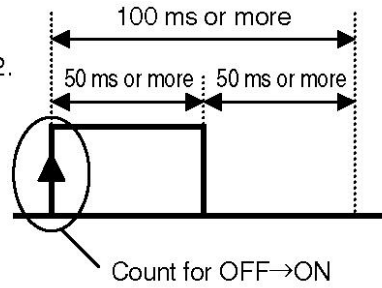

Multi-speed frequency operation using pulse input				Acceleration/deceleration linked with multi-speed frequency operation using pulse input				
P045 = 5				P045 = 6				
Rotation direction (selected bit)	Frequency	Runtime	Acceleration/ deceleration time	Rotation direction (selected bit)	Frequency	Runtime	Acceleration / deceleration time	
Forward/ reverse run 0 / 1	The 1 <sup>st</sup> speed ①	The 1 <sup>st</sup> speed pulse input times N1	The 1 <sup>st</sup> acceleration time A1 The 1 <sup>st</sup> deceleration time D1	Forward/ reverse run 0 / 1	The 1 <sup>st</sup> speed ①	The 1 <sup>st</sup> speed pulse input times N1	The 1 <sup>st</sup> acceleration/ deceleration time A1/D1	
Forward/ reverse run 0 / 1	The 2 <sup>nd</sup> speed ②	The 2 <sup>nd</sup> speed pulse input times N2		Forward/ reverse run 0 / 1	The 2 <sup>nd</sup> speed ②	The 2 <sup>nd</sup> speed pulse input times N2	The 2 <sup>nd</sup> acceleration/ deceleration time A2/D2	
Forward/ reverse run 0 / 1	The 3 <sup>rd</sup> speed ③	The 3 <sup>rd</sup> speed pulse input times N3		Forward/ reverse run 0 / 1	The 3 <sup>rd</sup> speed ③	The 3 <sup>rd</sup> speed pulse input times N3	The 3 <sup>rd</sup> acceleration/ deceleration time A3/D3	
Forward/ reverse run 0 / 1	The 4 <sup>th</sup> speed ④	The 4 <sup>th</sup> speed pulse input times N4		Forward/ reverse run 0 / 1	The 4 <sup>th</sup> speed ④	The 4 <sup>th</sup> speed pulse input times N4	The 4 <sup>th</sup> acceleration/ deceleration time A4/D4	
Forward/ reverse run 0 / 1	The 5 <sup>th</sup> speed ⑤	The 5 <sup>th</sup> speed pulse input times N5		The 1 <sup>st</sup> acceleration/ deceleration time A1/D1	Forward/ reverse run 0 / 1	The 5 <sup>th</sup> speed ⑤	The 5 <sup>th</sup> speed pulse input times N5	The 1 <sup>st</sup> acceleration/ deceleration time A1/D1
Forward/ reverse run 0 / 1	The 6 <sup>th</sup> speed ⑥	The 6 <sup>th</sup> speed pulse input times N6			Forward/ reverse run 0 / 1	The 6 <sup>th</sup> speed ⑥	The 6 <sup>th</sup> speed pulse input times N6	
Forward/ reverse run 0 / 1	The 7 <sup>th</sup> speed ⑦	The 7 <sup>th</sup> speed pulse input times N7			Forward/ reverse run 0 / 1	The 7 <sup>th</sup> speed ⑦	The 7 <sup>th</sup> speed pulse input times N7	
Forward/ reverse run 0 / 1	The 8 <sup>th</sup> speed ⑧	The 8 <sup>th</sup> speed pulse input times N8			Forward/ reverse run 0 / 1	The 8 <sup>th</sup> speed ⑧	The 8 <sup>th</sup> speed pulse input times N8	

■ Example: Mode for one cycle of pulse input operation

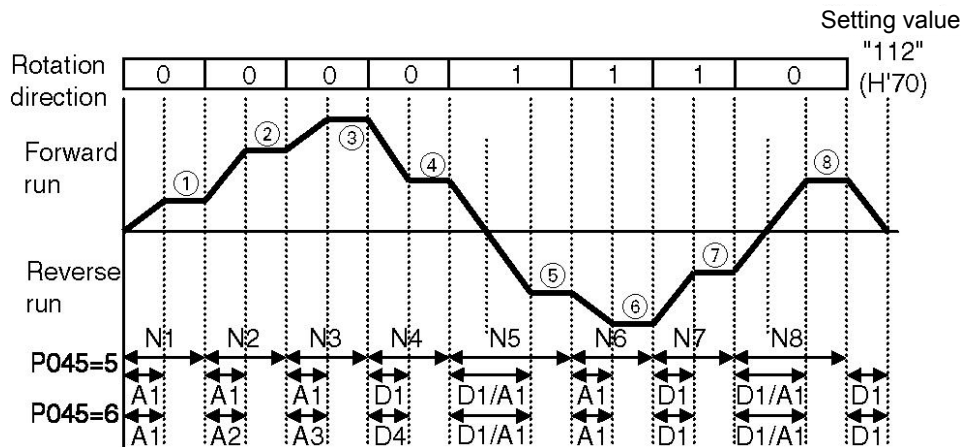

\* Setting value of "P069: Continuous Operation Mode of Timer" is "0".  
 Setting value of "P067: Rotation Direction of Timer Operation" is "14".

After the timer runs one cycle for times set with parameter "P068: Continuous Operation Times of Timer", "tEnd" will be displayed. Then the timer will return to "0000" (operation status mode) after stop command is input with "tEnd" displayed.

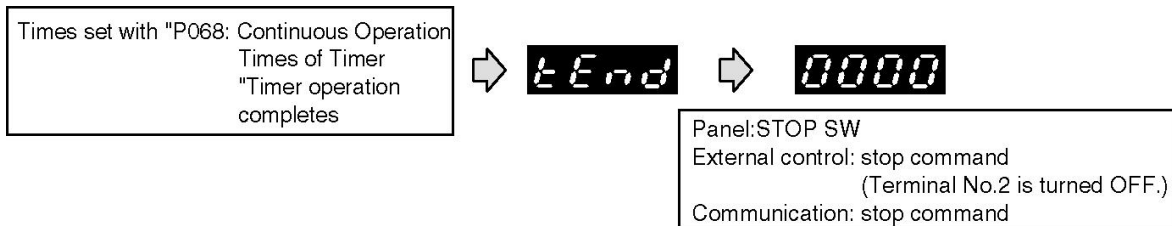

**【Note】**

- During pulse input operation, forward/reverse run commands input from operation panel, external control and communication are invalid.
- During pulse input operation, the operation will be stopped immediately even in cycle operation when the stop command is input.

Related parameters: P001, P002, P036 to P041, P046 to P052, P061 to P070, P079 to P086

<b>P046</b>	The 2 <sup>nd</sup> Speed Frequency	<b>P051</b>	The 7 <sup>th</sup> Speed Frequency	<b>P056</b>	The 12 <sup>th</sup> Speed Frequency
<b>P047</b>	The 3 <sup>rd</sup> Speed Frequency	<b>P052</b>	The 8 <sup>th</sup> Speed Frequency	<b>P057</b>	The 13 <sup>th</sup> Speed Frequency
<b>P048</b>	The 4 <sup>th</sup> Speed Frequency	<b>P053</b>	The 9 <sup>th</sup> Speed Frequency	<b>P058</b>	The 14 <sup>th</sup> Speed Frequency
<b>P049</b>	The 5 <sup>th</sup> Speed Frequency	<b>P054</b>	The 10 <sup>th</sup> Speed Frequency	<b>P059</b>	The 15 <sup>th</sup> Speed Frequency
<b>P050</b>	The 6 <sup>th</sup> Speed Frequency	<b>P055</b>	The 11 <sup>th</sup> Speed Frequency	<b>P060</b>	The 16 <sup>th</sup> Speed Frequency

The 2<sup>nd</sup> to 16<sup>th</sup> speed frequency can be set to perform multi-speed operation.

Data setting range (Hz)	0000 • 0.5 to 400.0
-------------------------	---------------------

- “0000” indicates 0 V stop.
- When under vector control, the frequency is 1 Hz to 120 Hz.

Related parameters: P036 to P041, P045, P061 to P086

<b>P061</b>	The 2 <sup>nd</sup> Acceleration Time	<b>P063</b>	The 3 <sup>rd</sup> Acceleration Time	<b>P065</b>	The 4 <sup>th</sup> Acceleration Time
<b>P062</b>	The 2 <sup>nd</sup> Deceleration Time	<b>P064</b>	The 3 <sup>rd</sup> Deceleration Time	<b>P066</b>	The 4 <sup>th</sup> Deceleration Time

The 2<sup>nd</sup> to 4<sup>th</sup> acceleration/deceleration time can be set to perform 4-step acceleration/deceleration control operation.

The 2<sup>nd</sup> to 4<sup>th</sup> acceleration/deceleration time corresponds to the frequency band of 0.5 Hz to the max. output frequency.

Data setting range (s)	0.1 to 3600
Increment (s)	0.1 (0.1 to 999.9), 1 (1000 to 3600)

Related parameters: P036 to P041, P045 to P048, P067 to P086

## P067 Rotation Direction of Timer Operation

Rotation direction at each level from the 1<sup>st</sup> to 8<sup>th</sup> speed can be set in “P045: Multi Speed Function Select” when setting value is “3 to 6”.

“0” and “1” indicate forward run and reverse run respectively, while the 1<sup>st</sup> to 8<sup>th</sup> speed indicate different levels. After rotation direction is determined (“0” (forward run) or “1” (reverse run)), the sum of 0 or 1 multiplied by addition value corresponding to each level can be acquired and used as setting value.

(Refer to the following table. The sum of rotation direction (“0” or “1”) multiplied by addition value of each speed level is used as setting value.)

■ Example of setting: The 1<sup>st</sup> speed = forward run, the 2<sup>nd</sup> speed = forward run, the 3<sup>rd</sup> speed = forward run, the 4<sup>th</sup> speed = forward run  
The 5<sup>th</sup> speed = reverse run, the 6<sup>th</sup> speed = reverse run, the 7<sup>th</sup> speed = reverse run, the 8<sup>th</sup> speed = forward run

Speed	The 1 <sup>st</sup> speed	The 2 <sup>nd</sup> speed	The 3 <sup>rd</sup> speed	The 4 <sup>th</sup> speed	The 5 <sup>th</sup> speed	The 6 <sup>th</sup> speed	The 7 <sup>th</sup> speed	The 8 <sup>th</sup> speed
Rotation direction	Forward run	Forward run	Forward run	Forward run	Reverse run	Reverse run	Reverse run	Forward run
Set value	0 / 1	0 / 1	0 / 1	0 / 1	0 / 1	0 / 1	0 / 1	0 / 1
Addition value	1	2	4	8	16	32	64	128

$$(0 \times 1) + (0 \times 2) + (0 \times 4) + (0 \times 8) + (1 \times 16) + (1 \times 32) + (1 \times 64) + (0 \times 128) = 112$$

So the setting value is “112”.

### 【Note】

- This function is valid only when the setting is “3” to “6” in “P045: Multi Speed Function Select”.
- Please note that rotation direction varies depending on the setting.

Related parameters: P001, P002, P045 to P052, P061 to P066



**P068** Continuous Operation Times of Timer

Continuous operation times of timer in one cycle can be set by using the 1<sup>st</sup> to 8<sup>th</sup> speed operation as “timer operation cycle” when the setting is “3” to “6” in “P045: Multi Speed Function Select”.

Data setting range (times)	0000 • 1 to 9999
-------------------------------	------------------

\* “0000” indicates that there is no limit to operation times. After run command is input, the operation will keep on until stop command is input.

**【Note】**

---

- This function is valid only when the setting is “3” to “6” in “P045: Multi-Speed Function Select”.
- If data is changed during operation, the data will become valid only after the next cycle arrives.

Related parameters: P045, P069 to P070

**P069** Continuous Operation Mode of Timer**P070** Continuous Waiting Time of Timer Operation

Operation mode and continuous waiting time of timer operation from the end of the 1<sup>st</sup> cycle to the 2<sup>nd</sup> cycle can be set when the setting is “3” to “6” in “P045: Multi Speed Function Select”.

If continuous operation mode of timer is set to “1”, continuous waiting time of timer operation will become invalid.

■ Parameter P069: Continuous Operation Mode of Timer

Setting value	Details
0	After one cycle of operation, the operation returns to the 0 V stop status within the 1 <sup>st</sup> deceleration time and enters the next cycle.
1	After one cycle of operation, the operating frequency will change to the 1 <sup>st</sup> speed frequency of the next cycle within the 1 <sup>st</sup> deceleration time.

■ Parameter P070: Continuous Waiting Time of Timer Operation

Data setting range (s)	0000 • 0.1 to 6553
Increment (s)	0.1 (0.1 to 999.9), 1 (1000 to 6553)

\* “0000” indicates that there is no waiting time.

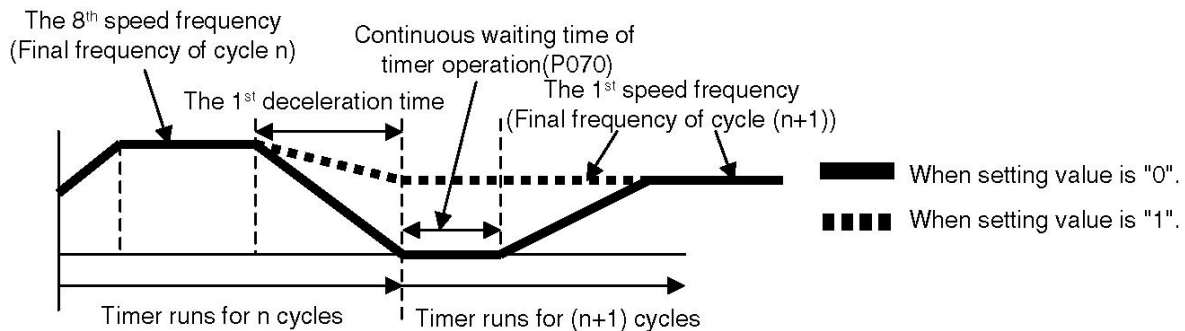

**[Note]**

- If data is changed during operation, the data will become valid only after the next cycle arrives.
- If data is changed during waiting time, the data will become valid only after the next cycle arrives.

Related parameters: P002, P045 to P052, P061 to P068

<b>P071</b>	The 1 <sup>st</sup> Speed Runtime	<b>P075</b>	The 5 <sup>th</sup> Speed Runtime
<b>P072</b>	The 2 <sup>nd</sup> Speed Runtime	<b>P076</b>	The 6 <sup>th</sup> Speed Runtime
<b>P073</b>	The 3 <sup>rd</sup> Speed Runtime	<b>P077</b>	The 7 <sup>th</sup> Speed Runtime
<b>P074</b>	The 4 <sup>th</sup> Speed Runtime	<b>P078</b>	The 8 <sup>th</sup> Speed Runtime

Runtime at the 1<sup>st</sup> to 8<sup>th</sup> speed frequency can be set when the setting is “3” or “4” in “P045: Multi Speed Function Select”.

Data setting range (s)	0000 • 0.1 to 6553
Increment (s)	0.1(0.1 to 999.9), 1(1000 to 3600)

\* “0000” indicates that no operation will be performed at the set speed.

**【Note】**

---

- Each function is valid only when the setting is “3” to “4” in “P045: Multi Speed Function Select”.
  - The inverter will not operate at the set speed when the setting is “0000”. Multi-speed operation using timer will be performed only at the speed for which time is set with P071 to P078.
- If data is changed during operation, the data will become valid only after the next cycle arrives.

Related parameters: P045 to P052, P061 to P070

<b>P079</b>	The 1 <sup>st</sup> Speed Pulse Input Times	<b>P083</b>	The 5 <sup>th</sup> Speed Pulse Input Times
<b>P080</b>	The 2 <sup>nd</sup> Speed Pulse Input Times	<b>P084</b>	The 6 <sup>th</sup> Speed Pulse Input Times
<b>P081</b>	The 3 <sup>rd</sup> Speed Pulse Input Times	<b>P085</b>	The 7 <sup>th</sup> Speed Pulse Input Times
<b>P082</b>	The 4 <sup>th</sup> Speed Pulse Input Times	<b>P086</b>	The 8 <sup>th</sup> Speed Pulse Input Times

Pulse input times at the 1<sup>st</sup> to 8<sup>th</sup> speed frequency can be set when the setting is “5” or “6” in “P045: Multi-Speed Function Select”.

Data setting range (times)	0000 · 0.1 to 65530
Increment (times)	Indication “0.1” = “1 time” (Indication: 0.1 to 999.9) Indication “1” = “10 times” (Indication: 1000 to 6553)

\* “0000” indicates that no operation will be performed at the set speed.

**【Note】**

• Each function is valid only when the setting is “5” to “6” in “P045: Multi Speed Function Select”.

• The inverter will not operate at the set speed when the setting is “0000”.

Multi-speed operation using pulse input will be performed only at the speed for which time is set with P079 to P086.

If data is changed during operation, the data will become valid only after the next cycle arrives.

Related parameters: P045 to P052, P061 to P070

## P087 PWM/Pulse Input Frequency Signal Select

PWM/Pulse Input signal from PLC etc. can be used to control the operating frequency. (However, the allowable PWM signal cycle ranges from 0.9 ms to 1100 ms.)

Setting value	Details
0	PWM frequency signal select disabled
1	PWM frequency signal
2	Pulse input frequency signal

\*When PWM/Pulse Input frequency signal is selected, functions of SW4 (terminal No.7) and SW5 (terminal No.8) will be used by PWM or pulse control exclusively.

### ■ Connection and function descriptions of control circuit terminals

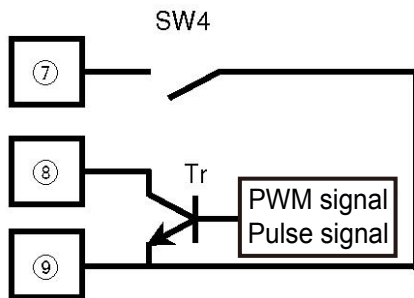

- Terminal No.7: frequency signal switch input terminal  
ON: signal set with parameter P004  
OFF: PWM/Pulse input frequency signal
- Terminal No.8: PWM/Pulse signal input terminal  
Max. rated voltage: 50 V DC  
Current: 50 mA or more  
Please use the open-collector signal input with the following specifications.

### ■ The relationship between PWM signal and frequency command value

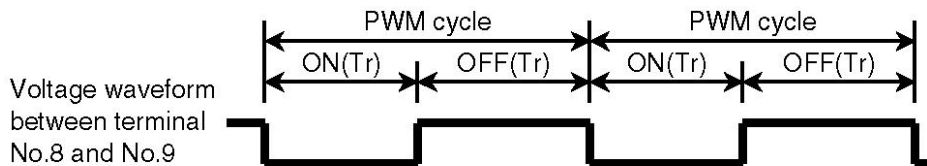

$$\text{Frequency command value (Hz)} = \text{ON time} / \text{PWM cycle} \times \text{Max. output frequency (Hz)}$$

### ■ The relationship between pulse signal and frequency

Please set pulse input value per second when the output frequency is max in parameter "P174: pulse input signal frequency".

- When set parameter P005 to "50" or "60", the max output frequency is "50Hz" or "60Hz", and when the value is "FF" or "3C", the max output frequency is the value of parameter P008.
- If parameter P005 is set to "50" or "60", the maximum output frequency will be "50 Hz" or "60 Hz" respectively; if set to "FF" or "3C", the maximum output frequency will be the value of parameter P 008.

### 【Note】

- The allowable PWM signal cycle ranges from 0.9 ms to 1100 ms.
- When P087 = 1, the settings of "P039: SW4 Function Select" and "P040: SW5 Function Select" are invalid.

Related parameters: P005, P008, P088, P089

## P088 PWM Signal Average Times

The inverter measures and calculates ON time and OFF time of each PWM cycle used as frequency command.

When using this parameter, the times of each PWM cycle command should be averaged, and then the average operation times are set as final output frequency.

Data setting range (times)	1 to 100
-------------------------------	----------

\* If average times are increased, the frequency command will become stable, but the response speed will decrease.

Related parameters: P087, P089

## P089 PWM Signal Cycle

PWM signal cycle can be input with this parameter.

Data can be set within  $\pm 12.5\%$  of the input PWM signal cycle.

Data setting range (ms)	1 to 2000
----------------------------	-----------

### 【Note】

- The output frequency controlled by PWM signal is “0 V stop or the minimum frequency (without ON status)” and “the maximum frequency (without OFF status)”.
- Due to the fact that the output frequency accuracy relative to input signal will decrease around the minimum frequency and maximum frequency, do not use the inverter for precise frequency control.
- The 2<sup>nd</sup> frequency setting signal is prior to PWM frequency signal when the 2<sup>nd</sup> frequency setting signal is selected (ON).
- PID control function is invalid when PWM frequency signal is selected. PWM frequency signal cannot be used as PID setting value (SP).

Related parameters: P087, P088

**P090** Output TR1 Function Select

**P091** Output TR2 Function Select

Functions of open-collector output 1 (control circuit terminal No.10 to No.12) and open-collector output 2 (control circuit terminal No.11 to No.12) can be set.

	TR1P090	TR2P091	Function	ON conditions for open-collector output
Setting value	0	0	Run signal	With run signal ON or during inverter output
	1	1	Reverse run signal	When inverter is in reverse run status
	2	2	Arrival signal	When output frequency is within $\pm 2$ Hz of setting frequency
	3	3	Overload alarm	When the output current is above 140% of the rated current or the electronic thermal level is reached.
	4	4	Frequency sensing	When the output frequency is above sensing frequency (parameter P093 setting).
	5	5	Current sensing (1)	When the output current is above the sensing current level (parameter P095 setting).
	6	6	Current sensing (2)	When the output current is below the sensing current level (parameter P095 setting).
	7	7	Fault alarm (1)	When fault trip occurs in the inverter
	8	8	Fault alarm (2)	When the inverter is in normal status (OFF for fault trip status)
	9	9	After one cycle of timer operation	When one cycle of timer operation completes (output is available only during waiting time)
	10	10	Timer operation completed	When timer operation completes (with "tEnd" displayed)
	11	11	Alarm	Output is available with alarm LED flickering.

Setting value	12	12	Speed search operation signal	When speed search starts, the open-collector output is ON; when the speed search completes, the open-collector output is OFF.
	13	-	Output status signal	PWM signals in proportion to output frequency or output current will be output.

**【Note】**

- The setting value “5” and “6” are used to set delay time of current detection signal with “P096: Current Sensing Delay Time”.
- The setting value “10” is used to output the time set with “P070: Continuous Waiting Time of Timer Operation”.
- Output frequency ratio or output current ratio of setting value “13” can be set with parameter P097. Setting value “13” can only be used to set open-collector output 1 (TR1).

Related parameters: P070, P093, P095 to P097



**P092** Output RY Function Select

Functions of relay output (control circuit terminal A, B and C) can be set.

- Energizing in ON status: The relay is turned ON when the coil is energized.  
(Signal ON status = ON between terminals A and C, OFF between terminals B and C)
- Non-energizing in ON status: the relay is turned ON when the coil is not energized.

(Signal ON status = OFF between terminals A and C, ON between terminals B and C)

Setting value		Function	ON conditions for relay
Energizing in ON status	Non-energizing in ON status		
0	r0	Run signal	With run signal ON or during inverter output
1	r1	Reverse run signal	When inverter is in reverse run status
2	r2	Arrival signal	When output frequency is within $\pm 2$ Hz of setting frequency
3	r3	Overload alarm	When the output current is above 140% of the rated current or the electronic thermal level is reached.
4	r4	Frequency sensing	When the output frequency is above sensing frequency (parameter P094 setting).
5	r5	Current sensing (1)	When the output current is above the sensing current level (parameter P095 setting).
6	r6	Current sensing (2)	When the output current is below the sensing current level (parameter P095 setting).
7	r7	Fault alarm (1)	During fault trip occurrence in the inverter.
8	r8	Fault alarm (2)	When the inverter is in normal status (OFF for fault trip status).

---

9	r9	After one cycle of timer operation	When one cycle of timer operation completes (output is available only during waiting time).
10	r10	Timer operation completed	When timer operation completes (with “tEnd” displayed).
11	r11	Alarm	Output is available with alarm LED flickering.
12	r12	Speed search operation signal	When speed search starts, the open-collector output is ON; when the speed search completes, the open-collector output is OFF.

**【Note】**

- The setting value “5” and “6” are used to set delay time of current detection signal with “P096: Current Sensing Delay Time”.
- The setting value “10” is used to output the time set with “P070: Continuous Waiting Time of Timer Operation”.

Related parameters: P070, P094 to P096

**P093** Sensing Frequency [ Output TR ]

**P094** Sensing Frequency [ Output RY ]

Open-collector 1, 2 and relay output can be used to set the frequency sensed when outputting frequency sensing signals.

■ Parameter P093: Sensing Frequency [Output TR]

Data setting range (Hz)	0000 • 0.5 to 400.0
----------------------------	---------------------

- It is valid in open-collector output 1 and 2.
- “0000” indicates 0 V stop (0.0).

■ Parameter P094: Sensing Frequency [Output RY]

Data setting range (Hz)	0000 • 0.5 to 400.0
----------------------------	---------------------

- “0000” indicates 0 V stop (0.0).

■ The relationship between output frequency and each output signal

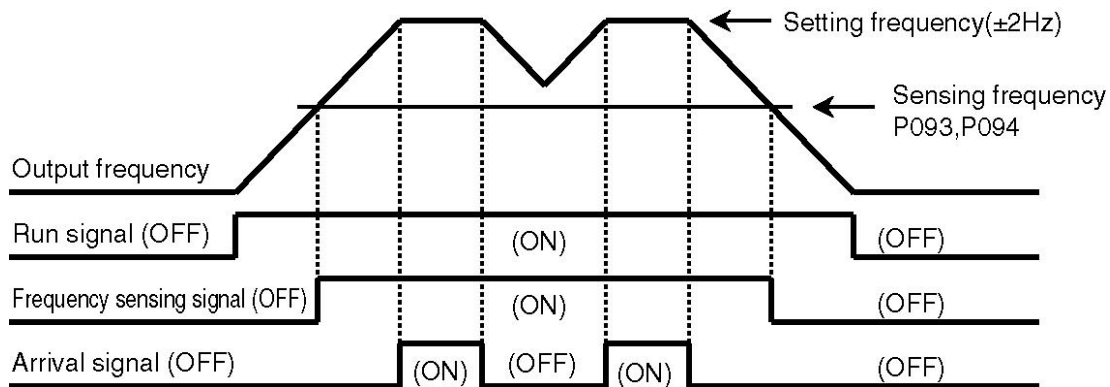

Related parameters: P090 to P092

**P095** Current Sensing Level  
**P096** Current Sensing Delay Time

Open-collector 1, 2 and relay output can be used to set current sensing level and delay time when current sensing signal is output.

■ Parameter P095: Current Sensing Level

Data setting range (A)	0.1 to 100.0
------------------------	--------------

■ Parameter P096: Current Sensing Delay Time

Data setting range (s)	0.1 to 10.0
------------------------	-------------

- Current sensing delay time refers to the delay time for a signal to switch from OFF to ON.

The delay time for a signal to switch from ON to OFF is about 100 ms (fixed value).

Related parameters: P090 to P092

**P097** Analog and PWM Output Function Select

Functions of “0 to 10 V voltage signal” and “output state signal (PWM)” output from control circuit terminal No.17 and terminal No.10 to No.12 can be set respectively.

Setting value	Details
0	Signals in proportion to output frequency are output.
1	Signals in proportion to output current are output.

■ The relationship between 0 to 10 V voltage signal and output frequency/output current

<In proportion to output frequency>

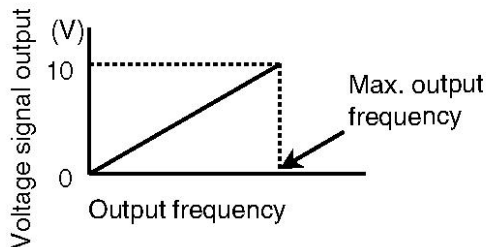

<In proportion to output current>

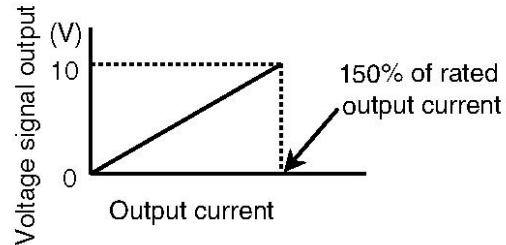

■ The relationship between PWM output signal and output frequency/output current

<In proportion to output frequency>

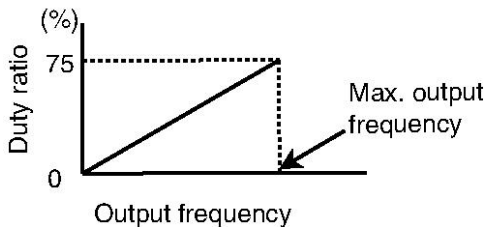

<In proportion to output current>

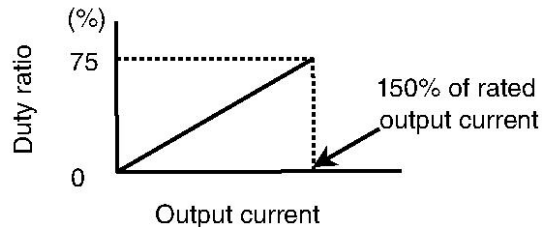

- The cycle of PWM output signal is "1 ms".

■ Precautions on 0 to 10 V voltage output and output status signal (PWM)

- Such output signal is not for precise measurement purpose, so use it just as reference value.

(Please use other measuring devices for the condition that needs accurate signal.)

- Please note that the large signal value may be output when the signal in proportion to the output current is below 40% of rated current.

(For example, certain level of signal will still be output even if there is no output current. However, "0" level will be output if the inverter is stopped.)

**【Note】**

---

- To acquire "PWM output" with terminal No.10 to No.12, set "P090: Output TR1 Function Select" to "13".

Related parameters: P090, P098

**P098** Analog and PWM Output Voltage Compensation

“0 to 10 V voltage signal” and “output status signal (PWM)” can be compensated.

Data setting range (%)	25 to 100 (increment = 1%)
------------------------	----------------------------

■ Adjustment range (full-scale)

- Analog output voltage signal: 3.75 to 10 (V)
- PWM signal : 56.3 to 75 (%)

Related parameters: P090, P097

**P099** Lower Frequency Limit**P100** Upper Frequency Limit

Upper limit and lower limit of output frequency can be set.

■ Parameter P099: Lower Frequency Limit

Data setting range (Hz)	0.5 to 400.0
-------------------------	--------------

■ Parameter P100: Upper Frequency Limit

Data setting range (Hz)	0.5 to 400.0
-------------------------	--------------

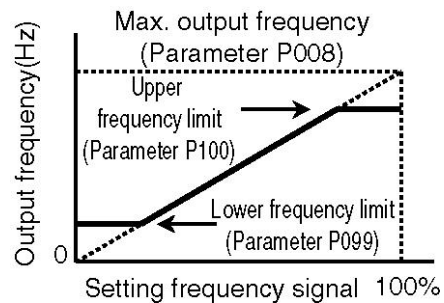
**【Note】**

- When the upper frequency limit is lower than the maximum output frequency (parameter P008), the upper frequency takes precedence.
- When the lower frequency limit is higher than the upper frequency limit (reverse run setting), the latter takes precedence.
- The inverter may accelerate/decelerate depending on settings when data is changed during operation.

Related parameters: P005, P008

## P101 0 V Stop Function Select

When the frequency setting signal is lower than than setting value, the inverter output can be stopped by using 0 V stop function.

Data setting range (Hz)	0000 · 0.5 to 400.0
----------------------------	---------------------

- Setting value “0000” :0 V stop function disabled
- Setting value “0.5 to 400.0” :0 V stop function enabled (0 V stop frequency setting)

### ■ 0 V stop function

- When the frequency signal is set to “analog setting (parameter P004 = “0”, “2”, “3”, “4”, “5”, “6” and “8”), the inverter will stop output after the frequency setting signal reaches the setting value of 0 V stop function select.

- 0 V stop will not be performed if 0 V stop function select is set to “0000”.

The inverter will continuously run at the lower frequency limit if the frequency setting signal is lower than 1/100 (1%) of full scale.

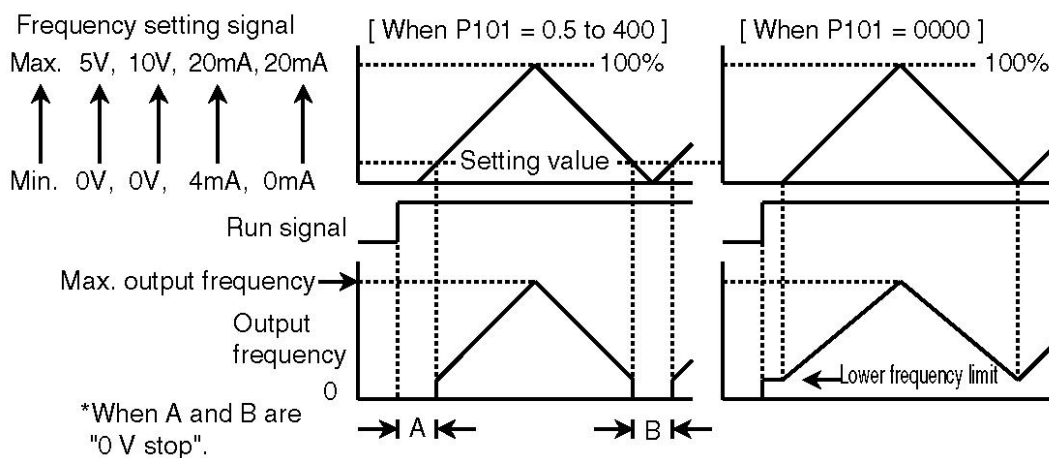

**【Note】**

- When frequency setting signal is set with digital or communication method, the inverter will not perform 0 V stop.
- If frequency setting signal is lower than 1/100 (1%) of full scale, the command value will become 0 Hz.

Related parameters: P004, P099, P125

**P102** Bias/Gain Function Select

**P103** Bias Frequency Setting

**P104** Gain Frequency Setting

The relationship between output frequency and frequency setting signal (frequency setting analog signal of control circuit terminal No.14 or potentiometer) can be adjusted freely. Please use this function according to the applications.

■ Parameter P102: Bias/Gain Function Select

Setting value	Details
0	Without bias/gain function
1	With bias/gain function

■ Parameter P103: Bias Frequency Setting

Data setting range (%)	−99.0 to 250.0
------------------------	----------------

■ Parameter P104: Gain Frequency Setting

Data setting range (%)	0.0 to 500.0
------------------------	--------------

- Bias frequency and gain frequency are set with the ratio (%) of 100% maximum output frequency (parameter P008).
- The frequency exceeding the maximum frequency or the upper frequency limit will not be output.  
Also, the frequency will not drop below the lower frequency limit.
- The inverter will not perform reverse run operation even if negative frequency setting signal is input.



■ When bias frequency is set to “positive”

■ When bias frequency is set to “negative”

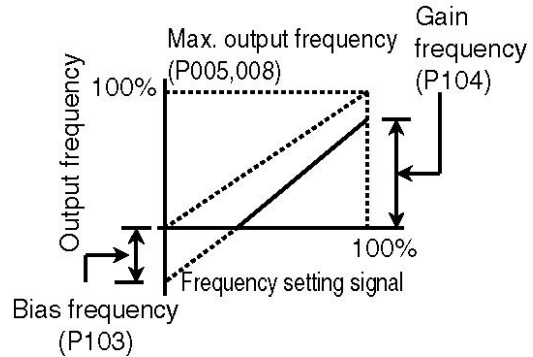
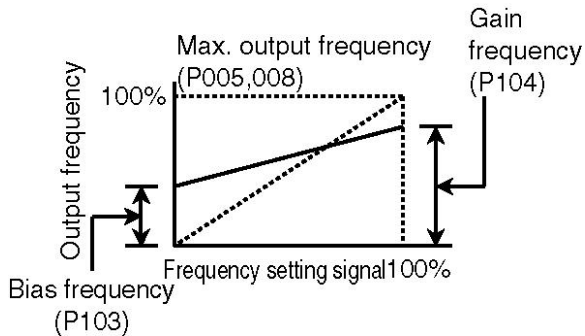

Related parameters: P004, P005, P008

## P105 Analog Input Filter

Filter constant of analog input terminal (control circuit terminal No.14 and No.16) can be set to eliminate external interference caused by external voltage or current frequency setting signals.

Data setting range (times)	5 to 200 (Increment = 1)
----------------------------	--------------------------

- Filter constants of analog input signals for control circuit terminal No.14 and No.17 share the same setting value.
- Frequency command will become stable with the setting value increased, but response speed will decrease.

Related parameters: P004, P125

**P106** PID Control Mode

With this function, the inverter can be used to control processes such as flow, air volume or pressure.

 <b>Danger</b>	<p>When the automatic tuning through PID control starts, the inverter will automatically drive the motor within the range of upper/lower frequency limit. Therefore, do not approach the unit.</p> <p>Failure to do so may result in injury.</p>
---	--

“PID operation mode select” and “switch setting for automatic tuning function” can be performed.

Setting value	PID operation mode		Automatic tuning function
0	Derivative-precedence type	Negative operation	×
1		Positive operation	
2	Proportional-derivative precedence type	Negative operation	
3		Positive operation	
A0	Derivative-precedence type	Negative operation	○
A1		Positive operation	
A2	Proportional-derivative precedence type	Negative operation	
A3		Positive operation	

■ PID operation mode select

• Either “derivative-precedence type” or “proportional-derivative precedence type” PID control can be selected.

Derivative precedence type PID control: generally speaking, when the setting value (SP) is changed, output variation will increase and convergence will speed up.

Proportional-derivative precedence type PID control: generally speaking, when the setting value (SP) is changed, output variation will decrease and convergence will slow down.

- Upward/downward direction (negative operation/positive operation) of the output can be selected when the process changes.

Negative operation: the output is increased with the measured value (PV) decreased.(For example: heating air)

Positive operation: the output is increased with the measured value (PV) increased.(For example: cooling air)

#### ■ Automatic tuning function

- Through automatic tuning, the inverter will calculate the optimum values of proportional gain (Kp), integral time (Ti) and derivative time (Td) required by PID control, and set the speculated results to parameters automatically.

The switch setting for automatic tuning function can be set with setting data “A0” to “A3”.

Refer to operation procedures of automatic tuning on page 250.

#### 【Note】

---

---

- Before performing automatic tuning, allowable ranges of the motor and machine must be confirmed.

Related parameters: P107 to P111, P124 to P127, P157

---

<b>P107</b>	Proportional Gain [Kp]
<b>P108</b>	Integral Time [Ti]
<b>P109</b>	Derivative Time [Td]
<b>P110</b>	Control Cycle [Ts]
<b>P111</b>	PID Target Value

---

Proportional gain, integral time, derivative time, control cycle and PID target value required in PID control can be set.

- Parameter P107 to P109 are used to set coefficients for PID control.
- Parameter P110 is used to set PID control cycle.
- When P004 = “1” or “7”, setting value (SP) can be set with parameter P111.

■ Parameter P107: Proportional Gain [Kp]

Data setting range	0.1 to 1000
--------------------	-------------

■ Parameter P108: Integral Time [Ti]

Data setting range (s)	0000 • 0.1 to 3600
------------------------	--------------------

\* “0000” indicates there is no integral control.

■ Parameter P109: Derivative Time [Td]

Data setting range (s)	0000 • 0.1 to 3600
------------------------	--------------------

\* “0000” indicates that there is no derivative control.

■ Parameter P110: Control Cycle [Ts]

Data setting range (s)	0.01 to 60.00
------------------------	---------------

■ Parameter P111: PID Target Value

Data setting range (%)	0.0 • 0.1 to 100.0
------------------------	--------------------

Related parameters: P004, P036 to P040, P099, P102 to P104, P124 to P127

■ Setting procedures of PID control

1. PID control select

- “P124: The 2<sup>nd</sup> Analog Input Function Select” is set to “1” or “2”.  
“1” and “2” will be treated as “measured value” and “bias signal” respectively.
- When parameter P142 = “0” or “3”, PID control will not be performed.

2. Measured value (PV)

- “P125: The 2<sup>nd</sup> Analog Input Signal Select” is set to the signal specification of the detector.
- The relationship between detector signal and measured value (PV) is set with “P126: The 2<sup>nd</sup> Bias Frequency Setting” and “P127: The 2<sup>nd</sup> Gain Frequency”.

<Example> 4 mA = 0%, 20 mA = 100%

- Bias can be added with “P157: The 2<sup>nd</sup> Analog Superimposed Value”.

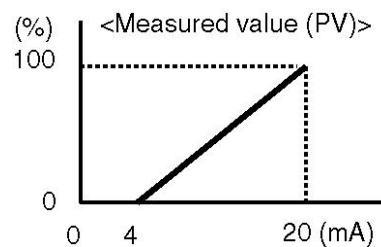

### 3. Setting value (SP)

- Setting signal of setting value (SP) is set with parameter P004 (Frequency Setting Signal).

(Note) When Parameter P004 = "1" or "7", setting value (SP) is set with parameter P111 (PID Target Value).

- The relationship between setting signal and setting value (SP) is set with parameter P102 to P104 (Bias/Gain Function Select, Bias Frequency and Gain Frequency Setting).

<Example> 0 V = 0%, 5 V = 100%

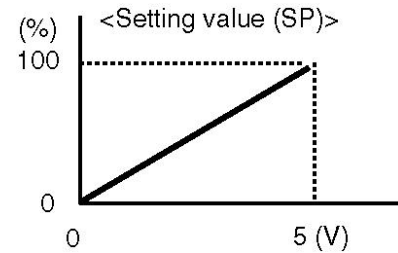

### 4. PID operation mode select

- PID operation mode is selected with parameter P106 (PID Control Mode).

### 5. Proportional gain (Kp), integral time (Ti), derivative time (Td) and control cycle (Ts) settings

- Coefficients (Kp, Ti and Td) used in PID control are set with parameter P107 to P109.

\* Automatic tuning function can be used to adjust coefficients (Kp, Ti and Td) and change setting values.

- PID control cycle (Ts) is set with parameter P110.

\*The lower/upper limit of output frequency is set with parameter P099 and P100.

■ Operation procedure of automatic tuning

1. Switch to automatic tuning function

Select “A0 to A3” with “P106: PID Control Mode” and press

 button to set the data.

2. Enter measurement ready status

Press  button to enter measurement ready status.



3. Automatic tuning starts

Turn run command ON, and automatic tuning will start.  
(The displaying part will flicker.)

\*The inverter will drive the motor automatically.



4. Automatic tuning completes

When automatic tuning completes, “End” will be displayed after measured data are written to parameter P107 to P109 automatically, indicating that automatic tuning is complete.

After that, data of parameter P106 will be automatically changed to PID operation mode without automatic tuning function.

(When performed with “A0”, “A1” and “A2”, the data will be changed to “0”, “1” and “2” respectively.)



5. Enter operation ready status (normal stop status)

Turn stop command ON and enter operation ready status.

After that, normal operation can be performed.



\*PID control status can be monitored in control state monitor (n14 to n17).

**【Note】**

---

• Depending on different processes, automatic tuning may not be performed. In this case, automatic tuning will stop with “Err” displayed and setting value of each parameter will remain unchanged. “Err” can be reset after stop command is turned ON to switch to normal stop status.

• After multi-speed signal is input, PID control will be terminated to perform multi-speed operation.

• After JOG signal is input, PID control will not be performed.

• After PWM signal is selected, PID control will not be performed.

<b>P112</b>	The 1 <sup>st</sup> Skip Frequency
<b>P113</b>	The 2 <sup>nd</sup> Skip Frequency
<b>P114</b>	The 3 <sup>rd</sup> Skip Frequency
<b>P115</b>	Skip Frequency Band Width

If mechanical parts of the load resonate at a specific output frequency of inverter, continuous operation within frequency band should be avoided by setting the skip frequency and the skip frequency band.

- Up to 3 skip frequency values can be set, and the skip frequency band can be set between 1 and 10 Hz.

- Parameter P112: The 1<sup>st</sup> Skip Frequency
- Parameter P113: The 2<sup>nd</sup> Skip Frequency
- Parameter P114: The 3<sup>rd</sup> Skip Frequency

Data setting range (Hz)	0000 • 0.5 to 400.0
----------------------------	---------------------

\* "0000" indicates that there is no skip frequency setting.

- Parameter P115: Skip Frequency Band Width

Data setting range (Hz)	0 • 1 to 10
----------------------------	-------------

\* "0" indicates that there is no skip function setting.

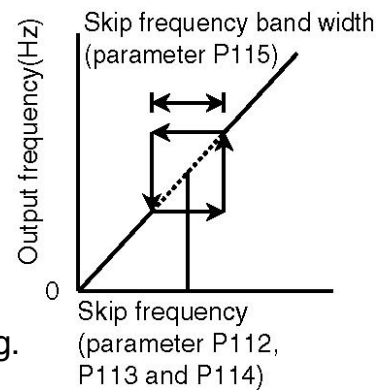



## P116 The 2<sup>nd</sup> Base Frequency

The 2<sup>nd</sup> base frequency can be selected and set with the 2<sup>nd</sup> characteristics select button.

(It is valid only when parameter P005 is set to “FF” or “3C”.)

### ■ Parameter P116: The 2<sup>nd</sup> Base Frequency

Data setting range (Hz)	45.0 to 400.0
----------------------------	---------------

- The maximum output frequency can be set by parameter P005 (V/F Mode) or parameter P008 (Max. Output Frequency).

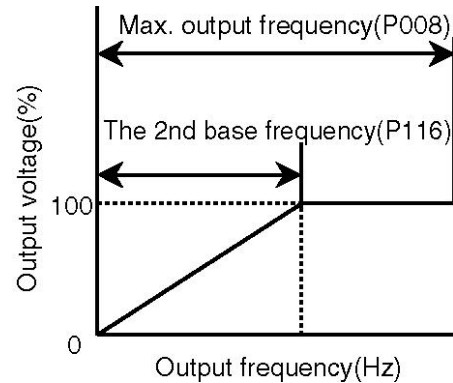

### 【Note】

- If “P005: V/F Mode” is set to “50” or “60”, the maximum output frequency and base frequency will be fixed values.
- A frequency value exceeding “P100: Upper Frequency Limit” cannot be output.
- If a general-purpose motor with rated frequency of 50/60 Hz is running at a frequency value exceeding the ratings, the motor may be damaged. Therefore, please set the frequency to match motor characteristics.
- If the base frequency is required to be changed together with the maximum output frequency for a dedicated high-speed motor etc., such change can also be changed with the parameter.
- When running the general-purpose motor at a frequency value exceeding the universal frequency, please set the base frequency to the rated output frequency (50/60 Hz) of general-purpose motor.
- When the general-purpose motor reaches a level exceeding the base frequency (normally 50/60 Hz), the motor will have the constant output characteristics and the generated torque will drop in reverse proportion to the frequency.

Related parameters: P005, P008, P036 to P040, P100, P117, P120 to P123

## P117 The 2<sup>nd</sup> Torque Boost

The 2<sup>nd</sup> torque boost can be selected and set with the 2<sup>nd</sup> characteristics select button. The larger the setting value is, the higher output voltage and torque boost are.

• After the mode is set to “auto torque boost”, the output voltage will be changed automatically according to the load fluctuation. To set “Auto torque boost”, please press ▼ (down) button with the operation panel displaying “0”.

Name	Data setting range (%)
Auto torque boost	Auto
Manual torque boost	0 to 40%

■ Constant torque mode

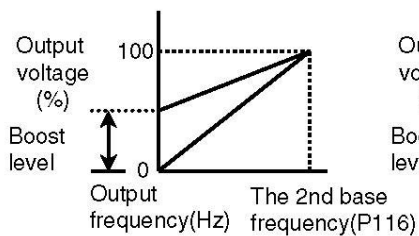

■ Square torque mode

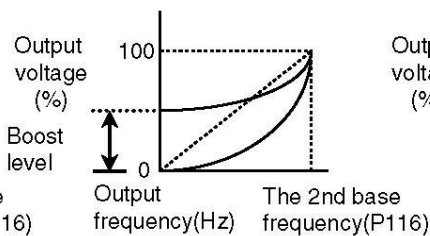

■ Auto torque boost mode

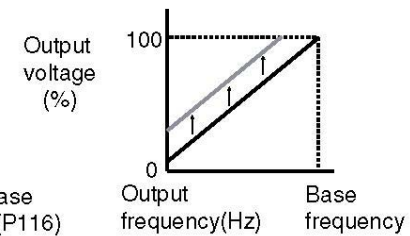

### 【Note】

- If the boost level setting is too high, overcurrent fault, overload fault, motor overheating or excessive noise may occur.
- The motor current will rise after the boost level is increased. Please carefully consider the settings of “P118: The 2<sup>nd</sup> Electronic Thermal Select” and “P119: The 2<sup>nd</sup> Thermal Current Setting”.
- It is invalid under vector control (P129 = “1”).
- During auto torque boost setting, parameter “P158: The 2<sup>nd</sup> Motor Capacity”, “P159: The 2<sup>nd</sup> Motor Pole Number” and “P160: The 2<sup>nd</sup> Voltage Compensation Constant” must be set, or automatic tuning can be performed by using parameter “P132: Motor Constant Measuring Function”.
- Overcurrent trip may occur if the voltage compensation constant is too high.
- The torque may be insufficient at lower speed if the voltage compensation constant is too low.
- The change from manual torque boost to auto torque boost or vice versa cannot be made during operation.

● Please use the inverter in the following conditions when set to “auto torque boost”.

- The motor must be the squirrel-cage induction motor for general purpose.
- Please select the inverter with the capacity equivalent to or 1 level higher than motor capacity.

Example 1) Please select a 0.75 kW inverter for motor ranging from 0.4 kW to 0.75 kW.

Example 2) Please select a 1.5 kW inverter for motor ranging from 0.75 kW to 1.5 kW.

- The motor must be a 2-pole, 4-pole or 6-pole one.
- It must be operated under standalone mode (i.e., one motor is driven by one inverter).
- The maximum wiring length between the inverter and motor must not exceed 30 m.

If the above conditions are not satisfied, sound operation performance cannot be achieved.

When vector control is selected, the output frequency ranges from 1 Hz to 120 Hz.

- During auto torque boost setting, the output frequency ranges from 1 Hz to 120 Hz.

Related parameters: P005, P008, P036 to P040, P116, P118 to P123

**P118** The 2<sup>nd</sup> Electronic Thermal Select

**P119** The 2<sup>nd</sup> Thermal Current Setting

Electronic thermal operation level can be selected and set with the 2<sup>nd</sup> characteristics select button when the inverter output is stopped. Operation ceases to stop when OL is displayed.

■ Example for setting current and thermal operation (P016 = 1)

- Setting current  $\times 100\%$   $\Rightarrow$  Does not operate
- Setting current  $\times 125\%$   $\Rightarrow$  Operate (OL trip)

■ Parameter P118: The 2<sup>nd</sup> Electronic Thermal Select

Setting value	Validity of function	Details of function
0	×	OL trip will occur if current up to 140% of inverter's rating continues for 1 minute.
1	○	Without output frequency derating
2	○	With output frequency derating
3	○	Forced air-cooled motor specification

\*About frequency derating

Cooling performance of the motor will be reduced at lower speed. To handle the problem, this function can automatically compensate operation level.

■ Parameter P119 = 1

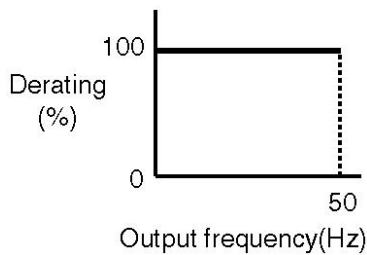

■ Parameter P119 = 2

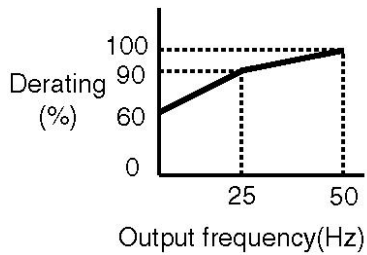

■ Parameter P119 = 3

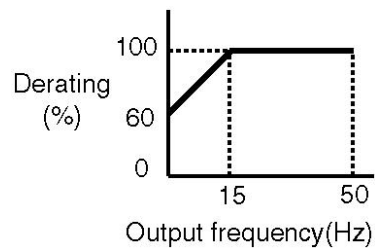

■ Parameter P119: The 2<sup>nd</sup> Thermal Current Setting

Data setting range (A)	0.1 to 100.0
------------------------	--------------

\* Please make settings according to the rated current of the applicable motor.

Related parameters: P036 to P040

<b>P120</b>	The 2 <sup>nd</sup> Change Point Frequency 1	<b>P122</b>	The 2 <sup>nd</sup> Change Point Frequency 2
<b>P121</b>	The 2 <sup>nd</sup> Change Point Voltage 1	<b>P123</b>	The 2 <sup>nd</sup> Change Point Voltage 2

Change point 1 and 2 can be selected in 3-point mode of “P005: V/F Mode”.  
(It is valid only when parameter P005 is set to “3C”.)

■ Parameter P120: The 2<sup>nd</sup> Change Point Frequency 1

Data setting range (Hz)	0.5 to 400.0
-------------------------	--------------

■ Parameter P121: The 2<sup>nd</sup> Change Point Voltage 1

Data setting range (%)	0 to 100
------------------------	----------

■ Parameter P122: The 2<sup>nd</sup> Change Point Frequency 2

Data setting range (Hz)	0.5 to 400.0
-------------------------	--------------

■ Parameter P123: The 2<sup>nd</sup> Change Point Voltage 2

Data setting range (%)	0 to 100
------------------------	----------

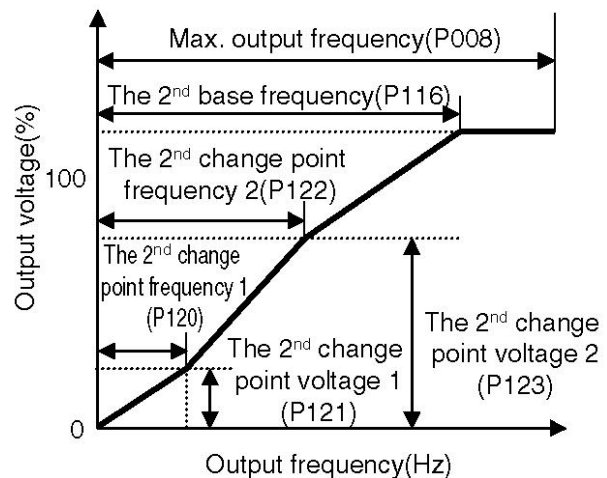

【Note】

- Read “P005: V/F Mode” carefully before setting.
- When set above base frequency, the 2<sup>nd</sup> change point frequency 1 and 2 will operate according to the setting value of base frequency.
- When set below the 2<sup>nd</sup> change point frequency 1, the 2<sup>nd</sup> change point frequency 2 will operate according to the the setting value of the 2<sup>nd</sup> change point frequency 1.
- When setting “P117: The 2<sup>nd</sup> Torque Boost”, the 2<sup>nd</sup> change point voltage 1 and 2 will operate according to the setting value of the 2<sup>nd</sup> torque boost if they are set below the 2<sup>nd</sup> torque boost level.
- When set below the 2<sup>nd</sup> change point voltage 1, the 2<sup>nd</sup> change point voltage 2 will operate according to the the setting value of the 2<sup>nd</sup> change point voltage 1.

- Please note that sharp acceleration/deceleration or overcurrent may occur depending on setting values and load status if data is changed during operation.
- If auto torque boost is selected with parameter “P117: The 2<sup>nd</sup> Torque Boost”, auto torque boost will take precedence, and settings related to 3-point mode (parameters P120 to P123: Change Point Voltage and Change Point Frequency) will become invalid.

Related parameters: P005, P008, P036 to P040, P116, P117

## P124 The 2<sup>nd</sup> Analog Input Function Select

The control function of the 2<sup>nd</sup> analog input terminal (control circuit terminal No.16) can be selected.

Name	Setting value	Details
The 2 <sup>nd</sup> analog input function select	0	The 2 <sup>nd</sup> frequency setting signal
	1	Measured value of PID control
	2	Bias signal of PID control
	3	Auxiliary frequency setting signal

### ■ The 2<sup>nd</sup> frequency setting signal (setting value = “0”)

- The 2<sup>nd</sup> analog input terminal can be used as the 2<sup>nd</sup> frequency setting signal.
- Frequency setting command can be switched between the 1<sup>st</sup> frequency setting signal and the 2<sup>nd</sup> frequency setting signal depending on the input status set with parameter “P036 to P040: SW1 to SW5 Function Select”.  
SW with OFF input: the 1<sup>st</sup> frequency setting signal  
SW with ON input: the 2<sup>nd</sup> frequency setting signal

### ■ Measured value of PID control (setting value = “1”)

- The 2<sup>nd</sup> analog input terminal can be used as feedback signal of PID control (measured value PV).
  - Input signals (0 to 5 V, 0 to 10 V, 4 to 20 mA and 0 to 20 mA) are fed back as measured values (PVs) of PID control (positive values: 0 to 100%).
  - After parameter P124 is set to “1”, set target value (SP) to the output frequency through parameter “P004: Frequency Setting Signal” to perform PID control so that measured value PV will approach target value SP and the output frequency will be changed accordingly.
    - When parameter “P004: Frequency Setting Signal” is specified as “1” or “7”, parameter “P111: PID Target Value” can be used.
    - Parameters for PID control can be set with parameter P106 to P111.



■ Bias signal of PID control (setting value = “2”)

- The 2<sup>nd</sup> analog input terminal can be used as measured value of PID control (bias signal).

- Input signals (0 to 5 V, 0 to 10 V, 4 to 20 mA and 0 to 20 mA) are fed back as bias signal of PID control (setting example: -10% to +10%).

- Bias value can be converted inside the inverter with parameter “P126: The 2<sup>nd</sup> Bias Frequency Setting”, “P127: The 2<sup>nd</sup> Gain Frequency Setting” and “P157: The 2<sup>nd</sup> Analog Superimposed Value Setting”.

<Example> When the analog input ranges from 0 to 5 V and both the 2<sup>nd</sup> bias value and the 2<sup>nd</sup> gain are set to “10”

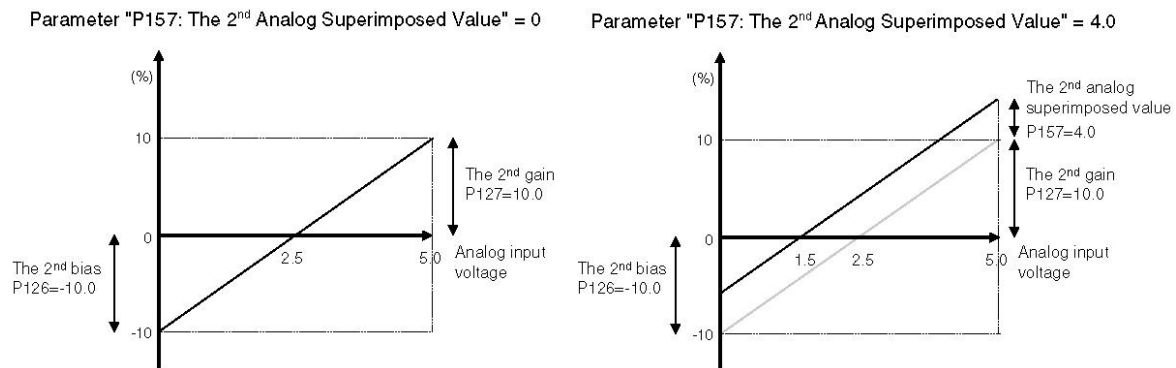

- After parameter P124 is set to “2”, set target value (SP) to the output frequency through parameter “P004: Frequency Setting Signal” to perform PID control that approaches target value SP depending on the bias signal input to the analog input terminals. The output frequency will also be changed accordingly. In this case, the inverter’s output frequency is determined by the following formula.

$$\text{Output frequency} = \text{Max. output frequency} \times (\text{The 1}^{\text{st}} \text{ frequency setting signal (\%)} + \text{bias signal (\%)})$$

- The value of the 1<sup>st</sup> frequency setting signal (%) depends on the value of parameter “P004: Frequency Setting Signal”. But when parameter “P004: Frequency Setting Signal” is specified as “1” or “7”, parameter “P111: PID Target Value” can be used.

- Parameters for PID control can be set with parameter P106 to P111.

### ■ Auxiliary frequency setting signal (setting value = “3”)

- The 2<sup>nd</sup> analog input terminal can be used as auxiliary frequency setting signal.
- Input signals (0 to 5 V, 0 to 10 V, 4 to 20 mA and 0 to 20 mA) are fed back as auxiliary frequency setting signal added to the 1<sup>st</sup> frequency setting signal (%) (setting example: -10% to +10%).
- The setting value of auxiliary frequency setting signal is converted inside the inverter with parameter “P126: The 2<sup>nd</sup> Bias Frequency Setting”, “P127: The 2<sup>nd</sup> Gain Frequency Setting” and “P157: The 2<sup>nd</sup> Analog Superimposed Value Setting”.

<Example> When the analog input ranges from 0 to 5 V and both the 2<sup>nd</sup> bias value and the 2<sup>nd</sup> gain are set to “10”

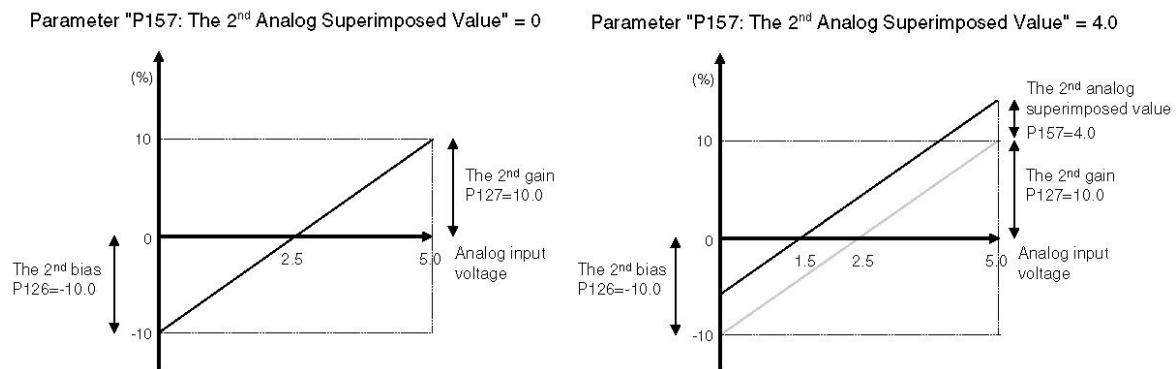

- It can be used when the result of PID calculation made by external devices such as PLC is added to the speed command value.
- The inverter’s output frequency is determined by the following formula.

Output frequency = Max. output frequency × (The 1<sup>st</sup> frequency setting signal (%) + auxiliary frequency setting signal (%))

- The value of the 1<sup>st</sup> frequency setting signal (%) depends on the value of parameter “P004: Frequency Setting Signal”. But when parameter “P004: Frequency Setting Signal” is specified as “1” or “7”, parameter “P111: PID Target Value” can be used.

Related parameters: P004, P036 to P040, P106 to P111, P125 to P127, P157

**P125** The 2<sup>nd</sup> Analog Input Signal Select

Setting signal of the 2<sup>nd</sup> analog input terminal (control circuit terminal No.16) can be selected.

Setting value	Details of setting signal	Operation method and control circuit terminal connection diagram
3	0 to 5 V (voltage signal)	Terminals No.16 and 15 (16: +, 15: -)
4	0 to 10 V (voltage signal)	Terminals No.16 and 15 (16: +, 15: -)
5	4 to 20 mA (current signal)	Terminals No.16 and 15 (16: +, 15: -): a 200 $\Omega$ resistor is connected between No.16 and No.15.
6	0 to 20 mA (current signal)	Terminals No.16 and 15 (16: +, 15: -): a 200 $\Omega$ resistor is connected between No.16 and No.15.

**【Note】**

---

- If 4 to 20 mA or 0 to 20 mA signal is used, please connect a “200  $\Omega$  resistor” between terminal No.16 and 15.(If the 200  $\Omega$  resistor is not connected, the inverter could be damaged.)

- The inverter will run or stop as defined by the setting value of “P101: 0 V Stop Function Select”.

To make 0 V stop function invalid, please set parameter P101 to “0000”.

(Refer to “0 V Stop Function Select” on page 222.)

Related parameters: P101, P124, P126, P127

**P126** The 2<sup>nd</sup> Bias Frequency Setting  
**P127** The 2<sup>nd</sup> Gain Frequency Setting

The relationship between the output frequency and the 2<sup>nd</sup> analog input signal (control circuit terminal No.16) can be adjusted freely. Please use this function according to the applications.

■ Parameter P126: The 2<sup>nd</sup> Bias Frequency Setting

Data setting range (%)	-99.0 to 250.0
------------------------	----------------

■ Parameter P127: The 2<sup>nd</sup> Gain Frequency Setting

Data setting range (%)	0.0 to 500.0
------------------------	--------------

- The 2<sup>nd</sup> bias frequency and the 2<sup>nd</sup> gain frequency can be set with the ratio (%) of the maximum output frequency (100%) (parameter P008).
- The frequency exceeding the maximum frequency or the upper frequency limit will not be output.

Also, the frequency will not drop below the lower frequency limit.

- The inverter will not run in reverse direction even if negative frequency setting signal is input.

■ The relationship between the 2<sup>nd</sup> frequency setting signal and the output frequency

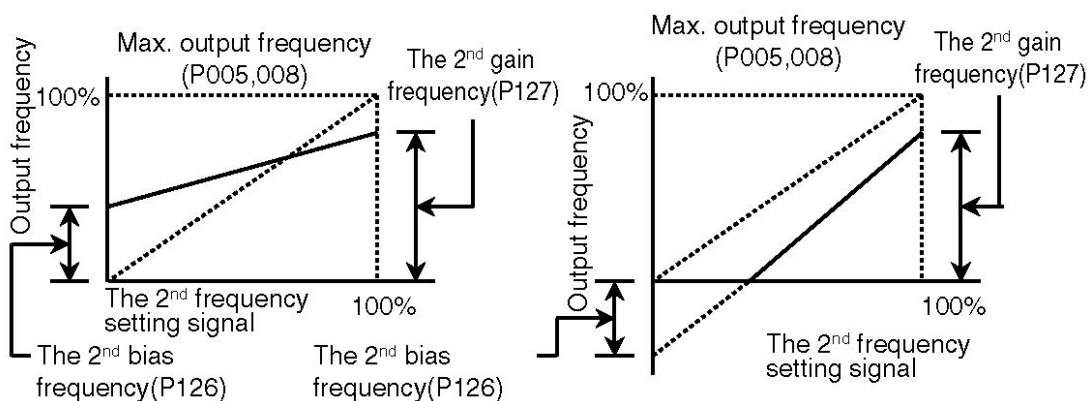

■ The relationship between the feedback signal and the measured value (PV) of PID control

(When parameter “P124: The 2<sup>nd</sup> Analog Input Function Select” is set to “1”.)

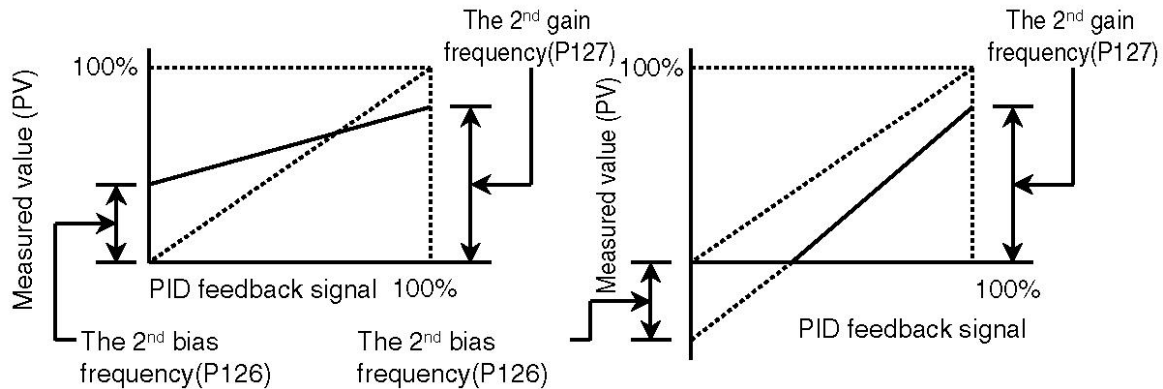

**【Note】**

• The frequency exceeding the maximum frequency or the upper frequency limit will not be output.

Also, the frequency will not drop below the lower frequency limit.

• The inverter will not perform reverse run operation even if the 2<sup>nd</sup> frequency setting signal input is a negative value.

Feedback signal of PID control for negative values is 0%.

• The 2<sup>nd</sup> bias frequency and the 2<sup>nd</sup> gain frequency have no connection with the setting values of bias/gain function select (parameter P102).

Related parameters: P005, P008, P036 to P040, P124, P125, P106 to P111

**P128** Carrier Frequency

This carrier frequency can be adjusted to reduce motor noise and avoid mechanical resonance.

■ When “P129: Vector Control Select” setting = “0” (when V/F control is selected)

Setting value (kHz)	0.8, 1.1, 1.6, 2.5, 5.0, 7.5 , 10.0 (7 settings)
---------------------	--

■ When “P129: Vector Control Select” setting = “1” (when vector control is selected)

Setting value (kHz)	2.5, 5.0, 7.5, 10.0 (4 settings)
---------------------	----------------------------------

**【Note】**

· This setting can be changed during operation, but the following change between low frequency group and high frequency group can be made only when the inverter is stopped.

Low frequency group: 0.8 to 1.6 kHz

High frequency group: 2.5 to 10.0 kHz

· When the carrier frequency is set to 7.5 kHz for a 3.7 KW+ inverter, please derate the output current according to the limitations on page 132.

· When the carrier frequency is set to 7.5 kHz or 10.0 kHz, it will vary depending on the output frequency.

For 1-phase 200 V type

1) When set to 7.5 kHz, carrier frequency of 5.0 kHz will be output for frequency band of 0.5 to 5 Hz.

2) When set to 10.0 kHz, carrier frequency of 5.0 kHz and 7.5 kHz will be output for frequency band of 0.5 to 5 Hz and 5 to 10 Hz respectively.

For 3-phase 400V type

1) When set to 7.5 kHz, carrier frequency of 5.0 kHz will be output for frequency band of 0.5 to 10 Hz.

2) When set to 10.0 kHz, carrier frequency of 5.0 kHz and 7.5 kHz will be output for frequency band of 0.5 to 10 Hz and 10 to 15 Hz respectively.

Related parameter: P129

**P129** Vector Control Select

This function is effective for the case that the load fluctuates sharply when high start-up torque or sufficient torque at lower speed is required. But it is not applicable to the load whose minor rotation may cause problems at lower speed.

Setting value	Details
0	V/F control
1	Vector control

● In vector control mode, please use the inverter in the following conditions.

- A squirrel-cage or induction motor for general purpose should be selected.
- Please select the inverter with the capacity equivalent to or 1 level higher than motor capacity.

<Exampel 1> Please select a 0.75 kW inverter for motor ranging from 0.4 kW to 0.75 kW (including 0.75 kW).

<Exampel 2> Please select a 1.5 kW inverter for motor ranging from 0.75 kW to 1.5 kW (including 1.5 kW).

- The motor must be a 2-pole, 4-pole or 6-pole one.
- It must operate in standalone mode (i.e., one motor is driven by one inverter).
- The maximum wiring length between the inverter and motor must not exceed 30 m.
- The carrier frequency should be higher than 2.5 kHz.

If the above conditions are not satisfied, sound operation performance cannot be achieved.

● In vector control mode, carrier frequency in area where output frequency is relatively lower may vary accordingly.

**■ Setting procedure when vector control is selected**

- 1) Control method select: Vector control select (set P129 to “1”).
- 2) Motor capacity select : Capacity of motor in use is set to “P130: Motor Capacity).(0.4 to 15kW)  
Motor capacity = Inverter capacity (factory setting)  
If the motor capacity is equal to the inverter, no additional setting will be required.
- 3) Motor polarity setting : Motor polarity to be used can be set with “P131: Motor Pole Number”.(2/4/6 poles)  
Factory setting of motor polarity is 4-pole.  
If the motor polarity is 4-pole, no additional setting will be required.
- 4) Trial operation : If required motor characteristics have been acquired, it indicates that the setting is complete.  
(Operation under motor constant is recommended by our company.)  
If the required motor characteristics have not been acquired, the following settings need to be made.
- 5) Motor constant setting : When motor constant is known beforehand
  - Setting of “P133: Voltage Compensation Constant”
  - Setting of “P134: Slip Compensation Frequency”When motor constant is unknown beforehand, automatic tuning will be performed.
  - “P132: Motor Constant Measuring Function” can be set to “1” to measure voltage compensation constant.
  - “P132: Motor Constant Measuring Function” can be set to “2” to measure slip compensation frequency.
- 6) Trial operation : If required motor characteristics have been acquired, it indicates that the setting is complete.  
If required motor characteristics have not been acquired after setting motor constant through P133 and P134, automatic tuning will be performed.



**【Note】**

---

---

- When vector control is selected, the output frequency ranges from 1 Hz to 120 Hz.
- Vector control select is valid only when “P128: Carrier Frequency” is from 2.5 kHz to 10.0 kHz.

When carrier frequency is set to “0.8 kHz to 1.6 kHz” and “P129: Vector Control Select” is set to “1” (vector control), the setting value of carrier frequency will be changed to 2.5 kHz automatically.

- For the 2<sup>nd</sup> motor, related parameters are as follows:  
“P158: The 2<sup>nd</sup> Motor Capacity”, “P159: The 2<sup>nd</sup> Motor Pole Number”, “P160: The 2<sup>nd</sup> Voltage Compensation Constant” and “P161: The 2<sup>nd</sup> Slip Compensation Frequency”.

Related parameters: P128, P130 to P134, P158 to P161

## P130 Motor Capacity

• During vector control or when auto torque boost or slip compensation is performed through V/F control, inverter capacity used to drive the motor can be set.

Setting value	Motor capacity
0.2	0.2 kW
0.4	0.4 kW
0.7	0.75 kW
1.5	1.5 kW
2.2	2.2 kW

Setting value	Motor capacity
3.7	3.7 kW
5.5	5.5 kW
7.5	7.5 kW
11.0	11.0 kW
15.0	15.0 kW

### 【Note】

• After setting value is changed, motor constants recommended by our company will be assigned to “P133: Voltage Compensation Constant” and “P134: Slip Compensation Frequency”.

Related parameters: P129, P131 to P134

## P131 Motor Pole Number

• During vector control or when auto torque boost or slip compensation is performed through V/F control, pole number required to drive the motor can be set.

Setting value	Motor Pole Number
2	2 poles
4	4 poles
6	6 poles

### 【Note】

• After setting value is changed, motor constants recommended by our company will be assigned to “P133: Voltage Compensation Constant” and “P134: Slip Compensation Frequency”.

Related parameters: P129 to P130, P131 to P134

## P132 Motor Constant Measuring Function

• During vector control or when auto torque boost or slip compensation is performed through V/F control, motor constant can be set through “automatic tuning” or specified as values recommended by our company.

 <b>Danger</b>	<ul style="list-style-type: none"> <li>• When automatic tuning of voltage compensation constant starts, the inverter will automatically apply DC high-voltage to the motor. Therefore, do not approach the unit. Failure to do so may result in electric shock.</li> <li>• When automatic tuning of slip compensation frequency starts, the inverter will drive the motor at 60 Hz. Therefore, do not approach the unit. Failure to do so may result in injury.</li> </ul>
---	--

Setting value	Details
0	It indicates the value in normal status. * The value is set in case that automatic tuning mode status for setting value “1” and “2” is cancelled.
1	When voltage compensation constant is set to automatic tuning mode: When the inverter returns to operation status display mode and enters measurement status after data setting, the constant measurement can be started by pressing RUNSW button.
2	When slip compensation constant is set to automatic tuning mode: When the inverter returns to operation status display mode and enters measurement status after data setting, the constant measurement can be started by pressing RUNSW button.
3	Constants recommended by our company will be assigned to “P133: Voltage Compensation Constant” and “P134: Slip Compensation Frequency” according to the setting values of “P130: Motor Capacity” and “P131: Motor Pole Number”. (If constants for P133 and P134 are changed after data setting, the setting value will become “0” automatically.)

### 【Note】

- Please perform automatic tuning when the motor is fully stopped.
- Please perform automatic tuning of slip compensation frequency when there is no load on the motor shaft.
- Acceleration time for automatic tuning of slip compensation frequency can

be set with P001. When acceleration time is too short, overcurrent trip may occur and tuning operation cannot be performed correctly.

- Automatic tuning sometimes cannot be performed when the inverter is affected by power supply environment and connected with special-purpose motor etc. In this case, set parameter P133 and P134 manually.

- For the 2<sup>nd</sup> motor, related parameters are as follows:

“P158: The 2<sup>nd</sup> Motor Capacity”, “P159: The 2<sup>nd</sup> Motor Pole Number”, “P160: The 2<sup>nd</sup> Voltage Compensation Constant” and “P161: The 2<sup>nd</sup> Slip Compensation Frequency”.

- When automatic tuning of motor constant and PID control are set simultaneously, the latter will take precedence.

Related parameters: P129 to P131, P133, P134, P158 to P161

■ Operation procedure of automatic tuning

1. Switch to automatic tuning mode setting

- When voltage compensation constant is measured, P132 is set to “1”.
- When slip compensation frequency is measured: P132 is set to “2”.

2. Enter measurement ready status

Press  button to enter operation status display mode.

- Displayed when voltage compensation constant is measured (P132 = “1”)
- Displayed when slip compensation frequency is measured (P132 = “2”)



3. Automatic tuning starts

Press  button to start automatic tuning.

- When voltage compensation constant is measured  
Normally the inverter will automatically apply high DC voltage to the motor for 2 s. The display flickers during measurement (P132 = “1”).
- When slip compensation frequency is measured  
The inverter will drive the motor automatically at 60 Hz. The tuning operation will normally last until (the 1<sup>st</sup> acceleration time + 5 s) has elapsed. The display flickers during measurement (P132 = “2”).



4. Automatic tuning completes

When automatic tuning completes, data will be written to parameter P133 or P134 automatically, indicating that automatic tuning is complete.

- The display indicate that voltage compensation constant measurement is complete.
- The display indicate that frequency compensation frequency measurement is complete.



## 5. Enter operation ready status (normal stop status)

Press  button to enter operation ready status.

After that, normal operation can be performed.

- For the 2<sup>nd</sup> motor, related parameters are as follows.  
 “P158: The 2<sup>nd</sup> Motor Capacity”, “P159: The 2<sup>nd</sup> Motor Pole Number”, “P160: The 2<sup>nd</sup> Voltage Compensation Constant” and “P161: The 2<sup>nd</sup> Slip Compensation Frequency”.



● When tuning result is beyond specific range

Sometimes, special-purpose motors such as high-speed motor and high-slip motor etc. cannot be tuned correctly. In case that improper tuning is performed, “tEr1” and “tEr2” will be displayed and fault trip will occur. Just press STOP SW button to reset.

### P133 Voltage Compensation Constant

During vector control or when auto torque boost is performed through V/F control, necessary voltage compensation constants should be set.

Setting value (V)	0.01 to 99.99 (increment = 0.01)
-------------------	----------------------------------

The setting value of voltage compensation constant can be calculated by the following formula.

$$\text{Setting value} = R \times I$$

R: including one-phase resistance of wiring  
 (1/2 of measured resistance between motor terminals)

I: Equivalent current (Equivalent to rated current of inverter corresponding to motor with same capacity)

For 1-phase 200 V type		For 3-phase 400V type			
Motor capacity	Equivalent current (A)	Motor capacity	Equivalent current (A)	Motor capacity	Equivalent current (A)
0.2 kW	2.3	0.4 kW	1.6	5.5 kW	12.0
0.4 kW	3.0	0.75 kW	2.1	7.5 kW	17.0
0.75 kW	5.0	1.5 kW	4.0	11 kW	22.0
1.5 kW	8.0	2.2 kW	6.0	15 kW	31.0
2.2 kW	11.0	3.7 kW	9.4		

---

**【Note】**

---

- If the setting value is too high, overcurrent trip may occur.
- If the setting value is too low, torque insufficiency may occur at lower speed.
- Automatic tuning sometimes cannot be performed when the inverter is affected by power supply environment and connected with special-purpose motor etc. In this case, please make manual settings according to relevant methods.

“P133: Voltage Compensation Constant” can be tuned automatically with “P132: Motor Constant Measuring Function”.

Related parameters: P129 to P132, P134

## P134 Slip Compensation Frequency

During vector control or when slip compensation is performed through V/F control, slip compensation frequency can be set.

Setting value (Hz)	-5.00 to 5.00 (increment = 0.01)
--------------------	----------------------------------

Slip compensation frequency is set by converting slip (at 60 Hz) to frequency value.

Please make settings according to the following method.

$$\text{Setting value} = \frac{N_0 - N_1}{N_0} \times 60(\text{Hz})$$

$N_0 : \frac{120 \times 60}{\text{Motor pole number}}$   
 $N_1 : \text{Rated RPM of motor (at 60 Hz)}$

### 【Note】

- If the setting value is relatively high, RPM of motor may be higher than the target value.
- When the setting value is relatively low, RPM of motor may be lower than the target value.
- Automatic tuning sometimes cannot be performed when the inverter is affected by power supply environment and connected with special-purpose motor etc. In this case, please make manual settings according to relevant methods.

“P134: Slip Compensation Frequency” can also be tuned automatically with “P132: Motor Constant Measuring Function”.

Related parameters: P129 to P133, P156, P158 to P161



<b>P135</b>	Communication Protocol Select	<b>P139</b>	Parity Check
<b>P136</b>	Communication Station No. Setting	<b>P140</b>	Timeout Sensing
<b>P137</b>	Communication Speed Setting	<b>P141</b>	Wait-to-send Time
<b>P138</b>	Stop Bit Length	<b>P142</b>	Judging Time for TEXT Completion

Important parameters necessary for sending commands to inverter through communication can be set.

■ P135: Communication Protocol Select

VF200 is based on two protocols: MEWTOCOL-COM and Modbus (RTU).

Either protocol can be selected.

Setting value	Details of function
0	MEWTOCOL-COM
1	Modbus (RTU)

■ P136: Communication Station No. Setting

Data setting range	1 to 31
--------------------	---------

■ P137: Communication Speed Setting

Setting value	Details of function
48	4800 bps
96	9600 bps
192	19200 bps
384	38400 bps

■ P138: Stop Bit Length

Setting value	Details of function
1	1 bit
2	2 bit

■ P139: Parity Check

Setting value	Details of function
0	Without parity check
1	Odd parity
2	Even parity

**■ P140: Timeout Sensing**

Data setting range (s)	0000· 0.1 to 60.0
------------------------	-------------------

\* “0000” indicates a setting without timeout sensing.

**■ P141: Wait-to-send Time**

Data setting range (ms)	1 to 1000
-------------------------	-----------

**■ P142: Judging Time for TEXT Completion**

Data setting range (ms)	3 to 200
-------------------------	----------

\*The setting is valid only when protocol Modbus (RTU) is used.

**【Note】**

- For details of communication function, please refer to “VF200 communication function manual”, which can be downloaded from our website: <http://pewc.panasonic.cn/ac/c/>.
- After setting values for communication parameter P135 to P142, please cut off the power once.

After the power supply reset, the setting values will be applied in the inverter.

**P143** Cooling Fan ON-OFF Control Select

- Operation modes of cooling fan in normal status and fault status can be set.

Setting value	Details	
	Operation of cooling fan	Operation when heat sink is faulty
0	Power-on: ON Power-off :OFF	The inverter stops abnormally.
1	Power-on: ON Heat sink temperature is below 100 °C: OFF	The inverter stops abnormally.
2	Power-on: ON Power-off :OFF	The inverter does not stop but sends out alarm.
3	Power-on: ON Heat sink temperature is below 100 °C: OFF	The inverter does not stop but sends out alarm.

**【Note】**

- The parameter is invalid to models without cooling fan (1-phase 200 V/ 0.2 to 0.75 kW model and 3-phase 400 V/0.75 kW model).

**P144** Input Terminal Filter

Filter constant of control circuit terminals (No.2 to No.8) can be set in the inverter to effectively remove interference of external signal input.

















Setting value (times)	5 to 100 (Increment = 1)
-----------------------	--------------------------

**【Note】**

- If the setting value is too high, the interference resistance capability will be enhanced, but response speed of control input terminals will decrease.
- If the setting value is too low, the interference resistance capability will be weakened, but response speed of control input terminals will increase.
- When start/stop, forward run and reverse run signal (terminal No.2 and No.3) are used to operate the inverter, internal processing time of the inverter will become longer even if the setting value is low. In this case, response speed of control input terminals will be slower than other terminals.

## P145 Operation Status Monitor

Display on the panel can be adjusted according to applications.

Setting value	Function name	LED indication	
		Operation ready status (stop status)	Operation status
0	Output frequency		
1	Linear speed		
2	Output current		
3	Communication station No.		
4	Setting frequency		
5	Communication station No./output frequency		
6	Communication station No./linear speed		
7	Communication station No./output current		

\* The values above are examples of display for “operating frequency (50.0)”, “output current (1.0 A)”, “setting frequency (50.0)”, “communication station No. (01)” and “linear speed multiplier (0.5)”.

### 【Note】

- In “operation status display mode”, current display will be shown by pressing SET button.
- Operation ready status in this manual is recorded as “0000”, but the display will vary with setting values when this parameter is changed.

Related parameter: P146

## P146 Linear Speed Multiplier

When setting value in “P145: Operation Status Monitor” is “1” (linear speed), multiplier relative to output frequency can be set.

### ■ Parameter P146: Linear Speed Multiplier

Data setting range	0.1 to 100.0
--------------------	--------------

<Setting example> When linear speed is displayed

$$\text{Linear speed (m/min)} = F \text{ (Hz)} \times K \text{ (multiplier)}$$

- To display linear speed 25 (m/min) at 50 Hz, set multiplier (K) to “0.5”.

### 【Note】

- Linear speed exceeding “9999” is displayed as “9.9.9.9”.

Related parameter: P145

## P147 Alarm LED Operation Select

Alarm LED operation of the panel can be selected with this parameter.

Setting value	Function name	Details of Function
0	N/A	N/A (The LED lights up when fault trip occurs)
1	Full monitor alarm	When any of the specified conditions (output voltage fault, overload, temperature abnormality, timer operation stop and cooling fan abnormality) is satisfied, the alarm LED will flicker.
2	Output voltage Fault alarm	When the setting value (P147) is reached, the alarm LED will flicker.
3	Overload alarm	When the setting value (P148) is reached, the alarm LED will flicker.
4	Abnormal temperature alarm	When heat sink temperature rises above 80 °C, the alarm LED will flicker.
5	Timer stop signal	When timer operation is complete, the alarm LED will flicker. (The signal is linked with timer operation function. When ∞ is displayed, the alarm LED will not flicker.)

6	Abnormal cooling fan alarm	When cooling fan abnormality occurs, the alarm LED will flicker.
---	----------------------------	--

- If fault trip occurs, the alarm LED will light up.
- Monitor function “n008: Alarm Type” can be used to identify the type of the current alarm.
- When alarm LED operation select (parameter P147) is set to “1” and several alarms occur simultaneously, the alarm display order is as follows.  
(If a higher-priority alarm is in operation, it will still be displayed even if a lower-priority alarm enters.)

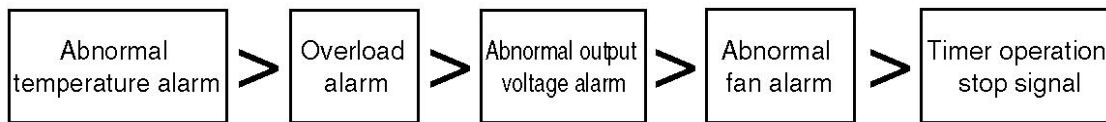

- When settings of “P090 to P092: Output TR1, TR2 and Ry Function Select” are set to “11”, it can be output to the external devices as alarm signal.

Related parameters: P148, P149

### **P148** Upper Voltage Limit of Alarm LED

When alarm LED operation select is set to “1” or “2”, the upper voltage limit to judge output voltage fault alarm can be set with this parameter.

If output voltage of inverter is higher than setting value, the alarm LED will flicker as output voltage fault alarm.

Data setting range (V)	0.1 to 600.0
------------------------	--------------

Related parameter: P147

**P149** Upper Current Limit of Alarm LED

---

When alarm LED operation select is set to “1” or “3”, the upper current limit to judge overload fault alarm can be set with this parameter.

If output current of inverter is higher than setting value, the alarm LED will flicker as overload fault alarm.

Data setting range (A)	0.1 to 100.0
------------------------	--------------

Related parameter: P147

**P150** Password

---

To prevent accidental changes to the data after parameter setting is complete, password can be set with this parameter.

Data setting range	0000 • 1 to 9999
--------------------	------------------

\* “0000” indicates that there is no password.

To set a password, press MODE button in “control status monitor mode” and password input display switches to “PS”. After entering the password and pressing SET button, you will have access to “custom mode”, “function setting mode” and “built-in memory setting mode”.

If you do not enter the password when password input display switches to “PS”, the display will return to “operation status display mode” as MODE button is pressed.

## ■ Procedures of changing parameter data after setting password

- When password is set to “7777”

### 1. Enter operation status display mode

(Press  button to stop the inverter during operation.)





### 2. Enter password input display mode

Press  button four times to enter password input display mode. (“PS” will flicker.)



\* If the password is unknown, press  button to return to “0000”.

### 3. Display password

Press  /  button to display a preset password.  
(The displaying part will flicker.)



### 4. Display “custom mode”

Press  button to display “custom mode”.



(Example: when the previous parameter No. is U001)

The operation procedures afterwards are just the same as that of changing normal data.

- After parameter setting, “Custom Mode”, “Function Setting Mode” and “Built-in Memory Setting Mode” cannot be entered without inputting the password.

(Please keep your password secure so as not to forget it.)



## **P151** Setting Data Clear

All data can be restored to factory settings with this parameter.

Setting value	Details
0	It indicates the value in normal status.
1	Except motor constants, all data will be restored to factory settings.*
2	All data will be restored to factory settings.
3	Functions allocated in “custom mode” will be restored to factory settings.

### \* Motor constants

Name	Parameter No.	
	For the 1 <sup>st</sup> motor	For the 2 <sup>nd</sup> motor
Motor capacity	P130	P158
Motor pole number	P131	P159
Voltage Compensation Constant	P133	P160
Slip Compensation Frequency	P134	P161

### 【Note】

- When the setting value is changed to a value other than “0” and SET button is pressed, the display will automatically switch to “0” afterwards to apply the change.

## **P152** DC Brake Time during Startup

## **P153** DC Brake Level during Startup

- After pause stop, coast-to-stop motors can be restarted with this parameter.

Parameter No.	Name	Setting range
P152	DC Brake Time during Startup	0000 0.1 to 120 (s)
P153	DC Brake Level during Startup	0 to 100 (%)

\*1: When DC brake function is not used, set P152 to “0000”.

\*2: It can be set with increment of 5%. The higher the value is, the stronger the brake force is.

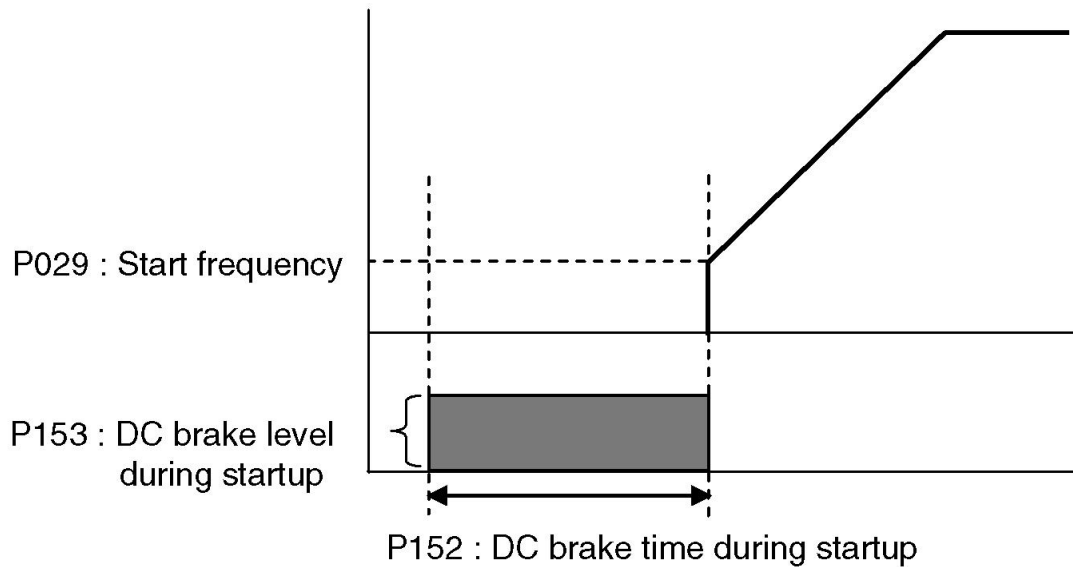
**【Note】**

- The start frequency is specified by parameter “P029: Start Frequency”.
- Please note that sharp acceleration/deceleration or overcurrent may occur depending on setting values and load status if data is changed during operation.
- When parameter “P162: Speed Search during Startup” is set to “enabled”, the setting value of DC brake set with this parameter is “disabled”.

**P154** MOP Function Select

**P155** Acceleration/deceleration Time for MOP Operation

Operation of frequency change can be set with these parameters when MOP function is used.

When acceleration/deceleration time is relatively short, frequency change is much easier with this function.

■ Parameter P154: MOP Function Select

Setting value	Function name	Details
0	Operation linked with acceleration/deceleration time	Acceleration/deceleration is performed according to the acceleration/deceleration time set with parameter P001 and P002.
1	MOP operation linked with acceleration/deceleration time	Press UP/DOWN button to perform acceleration/deceleration according to the acceleration/deceleration time set with parameter P155.
2	Operation linked with frequency setting	Press UP/DOWN button to switch to frequency setting mode. But if operation linkage is not performed, press SET button after frequency is selected and acceleration/deceleration will be performed according to the acceleration/deceleration time set with parameter P001 and P002.

■ Parameter P155: Acceleration/deceleration Time for MOP Operation

Data setting range (s)	0.04 • 0.1 to 3600
Increment (s)	0.1 (0.1 to 999.9), 1 (1000 to 3600)

- When parameter P154 is set to “1”, applicable acceleration/deceleration time can be set with this parameter.
- When the data setting range is “0.04 s”, the display is “0000”.
- The maximum frequency is set with parameter P005 and P008.

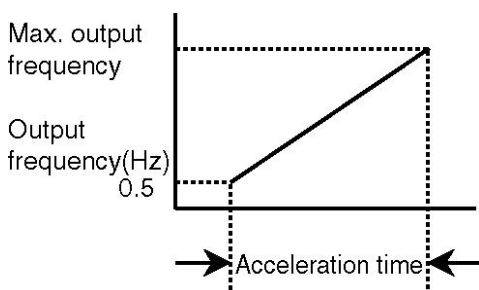

**【Note】**

• This function still applies even if parameter “P040: SW5 Function Select” is set to “11: Frequency ▲ / ▼ setting”. But when P154 is set to “2”, acceleration/deceleration will be performed according to acceleration/deceleration time set with parameter P001 and P002.

■ Operation when parameter P154 is set to “2: Operation linked with frequency setting”

- If ▲/▼ button is pressed when the operating frequency is displayed, the displayed data will flicker and enter frequency setting status.
- If SET button is pressed, operation will be started according to the new frequency value applied beforehand and acceleration/deceleration will be performed.
- Press MODE button with displayed data flickering to return to the previous status.

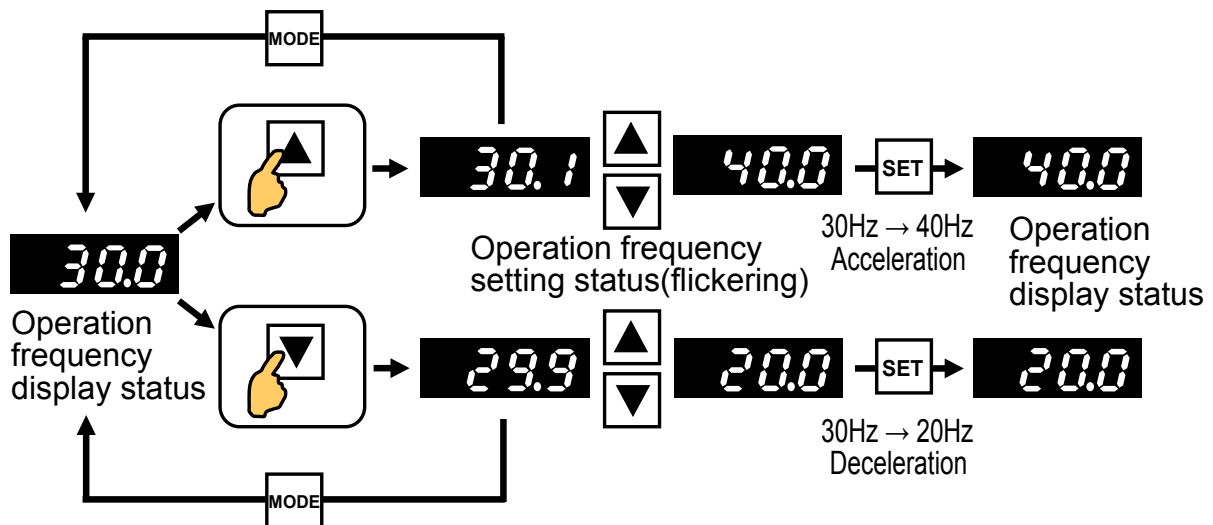

Related parameters: P001, P002, P005, P008, P040, P154

**P156** Slip Compensation Control

During V/F control, the slip in relation to speed command value is detected and slip compensation is controlled with this parameter.

Setting val	Details
0	Without slip compensation
1	Slip compensation made in normal status
2	Slip compensation not performed during deceleration

**【Note】**

---

- During slip compensation control, parameter “P130: Motor Capacity”, “P131: Motor Pole Number” and “P134: Slip Compensation Frequency” must be set. “P134: Slip Compensation Frequency” can also be tuned automatically by “P132: Motor Constant Measurement Function”.

- For the 2<sup>nd</sup> motor, related parameters are as follows.

- “P158: The 2<sup>nd</sup> Motor Capacity”, “P159: The 2<sup>nd</sup> Motor Pole Number” and “P161: The 2<sup>nd</sup> Slip Compensation Frequency”.

- In slip compensation control mode, please use the inverter in the following conditions.

- The motor must be the squirrel-cage induction motor for general purpose.

- Please select the inverter with the capacity equivalent to or 1 level higher than motor capacity.

< Example 1 > Please select a 0.75 kW inverter for motor ranging from 0.4 kW to 0.75 kW.

< Example 2 > Please select a 1.5 kW inverter for motor ranging from 0.75 kW to 1.5 kW.

- The motor must be a 2-pole, 4-pole or 6-pole one.

- It must be operated under standalone mode (i.e., one motor is driven by one inverter).

- The maximum wiring length between the inverter and motor must not exceed 30 m.

If the above conditions are not satisfied, sound operation performance cannot be achieved.

- During vector control, this parameter is invalid.

- When slip compensation control is selected, the output frequency ranges from 1 Hz to 120 Hz.

**P157** The 2<sup>nd</sup> Analog Superimposed Value

Bias value can be superimposed to the 2<sup>nd</sup> analog input value with this parameter.

Name	Setting range
The 2 <sup>nd</sup> Analog Superimposed Value	−100.0% to +100.0%

Related parameters: P124, P126 to P127

**【Note】**

- For setting method, please refer to “P124: The 2<sup>nd</sup> Analog Input Function Select”.

**P158** The 2<sup>nd</sup> Motor Capacity

- During vector control or when auto torque boost or slip compensation is performed through V/F control, inverter capacity used to drive the motor can be set.
- Related setting values are the same as the those of 1<sup>st</sup> motor. Please refer to parameter “P130: Motor Capacity”.

**【Note】**

- If data is changed, the setting values of parameter “P160: The 2<sup>nd</sup> Voltage Compensation Constant” and “P161: The 2<sup>nd</sup> Slip Compensation Frequency” will be automatically changed to motor constants recommended by our company.

**P159** The 2<sup>nd</sup> Motor Pole Number

- During vector control or when auto torque boost or slip compensation is performed through V/F control, pole number required to drive the motor can be set.
- Related setting values are the same as the those of 1<sup>st</sup> motor. Please refer to parameter “P131: Motor Pole Number”.

**【Note】**

---

---

• If data is changed, the setting values of parameter “P160: The 2<sup>nd</sup> Voltage Compensation Constant” and “P161: The 2<sup>nd</sup> Slip Compensation Frequency” will be automatically changed to motor constants recommended by our company.

**P160** The 2<sup>nd</sup> Voltage Compensation Constant

---

- During vector control or when auto torque boost is performed through V/F control, necessary voltage compensation constants should be set.
- Related setting values are the same as the those of 1<sup>st</sup> motor. Please refer to parameter “P133: Voltage Compensation Constant”.

**【Note】**

---

---

“P160: The 2<sup>nd</sup> Voltage Compensation Constant” can be tuned automatically with “P132: Motor Constant Measuring Function”.

**P161** The 2<sup>nd</sup> Slip Compensation Frequency

---

- During vector control or when auto torque boost is performed through V/F control, necessary voltage compensation constants should be set.
- Related setting values are the same as the those of 1<sup>st</sup> motor. Please refer to parameter “P134: Slip Compensation Frequency”.

**【Note】**

---

---

“P161: The 2<sup>nd</sup> Slip Compensation Frequency” can also be tuned automatically by “P132: Motor Constant Measurement Function”.

**P162** Speed Search Select during Startup

---

Whether speed search is performed or not during startup can be set with this parameter.

Setting value	Details
0	Speed search during startup is disabled. When speed search is selected with parameter “P036 to P040: SW1 to SW5 Function Select”, speed search will be performed if relevant SWs are turned ON.
1	Speed search during startup is enabled.

### **P163** Waiting time for speed search

The waiting time to start speed search can be set with this parameter during speed search.

Setting range(s)	0.0 to 100.0 (s)
------------------	------------------

#### **【Note】**

- If “P026: Waiting Time” is set and the waiting time has elapsed, the inverter will enter waiting status according to the setting value of “Waiting Time for Speed Search” and then start speed search.

### **P164** Voltage Recover Time for Speed Search

The voltage can be applied gradually at the frequency detected during speed search.

Setting range(s)	0.1 to 10.0 (s)
------------------	-----------------

#### **【Note】**

- If the setting value is too low, overcurrent trip may occur.



**P165** Speed Search Select during Retry

When retry function is set to “enabled” with parameter “P022: Retry Function”, whether speed search is performed or not during retry after fault occurrence can be set with this parameter.

Setting value	Details
0	Disabled: speed search is not performed during retry after fault occurrence.
1	Enabled: speed search is performed during retry after fault occurrence.

**P166** Speed Search Retry Select

Whether speed search is performed again after speed search select failure can be set with this parameter.

Setting value	Details
0	When speed search fails or upper limit of retry times for speed search is exceeded, “SEr” is displayed on the operation panel and operation is stopped.
1	When speed search fails or upper limit of retry times for speed search is exceeded, operation starts at the start frequency.

**P167** Speed Search Retry Times

Speed search retry times can be set when “Speed Search Retry Select” is selected.

Setting range (Times)	0 to 10
-----------------------	---------

**P168** Upper Frequency Limit Select for Speed Search

Frequency range for speed search can be set with this parameter.

Setting value	Details
0	Speed search is performed below the maximum frequency.
1	Speed search is performed at the frequency lower than the previous frequency before the operation is stopped normally.

**P169** Winding Mode Control Select

Whether winding mode control is selected or not and the amplitude during such control can be set with this parameter.

Setting value	Details
0	Winding mode control is OFF.
1	Amplitude is set based on the setting frequency.
2	Amplitude is set based on the maximum frequency.

**P170** Amplitude in Winding Mode

Frequency amplitude under winding mode control can be set with this parameter.

Setting range (%)	0.0% to 100.0 %
-------------------	-----------------

When P169 = 1, frequency amplitude (Hz) = setting frequency (Hz) × amplitude in winding mode (%)

When P169 = 2, frequency amplitude (Hz) = maximum frequency (Hz) × amplitude in winding mode (%)

For details of winding mode control, refer to P162.

### **P171** Recoil Frequency Band in Winding Mode

---

Percent of recoil frequency for frequency amplitude set with parameter P170 can be set with this parameter.

Setting range (%)	0.0% to 100.0%
-------------------	----------------

### **P172** Winding Mode Cycle

### **P173**

### Rise Time Coefficient in Winding Mode

---

Time required for one cycle of winding mode control operation and the acceleration time in one cycle can be set with these parameters.

■ Winding Mode Period

Setting range (sec)	0.0~3600
---------------------	----------

■ Rise Time Coefficient in Winding Mode

Setting range (%)	0.0~100.0
-------------------	-----------

The formulas of acceleration/deceleration time below can be acquired via setting of P172 and P173.

Rise time of triangular-wave frequency = winding mode cycle (s) × rise time coefficient of winding mode (%)

Drop time of triangular-wave frequency = winding mode cycle (s) × (100 - rise time coefficient of winding mode (%))

### **P174** Pulse Input Signal Frequency

---

It is used when set “P87: PWM/pulse frequency signal select” to “2”.

Please set pulse input count per second (pulse frequency) when it is max output frequency.

Setting range (Hz)	1~10000 (Setting unit: 1Hz)
--------------------	-----------------------------

**P175** Pulse Input Signal Bias**P176** Pulse Input Signal Gain

It can change the relationship between pulse frequency signal and output frequency. Please use as needed.

■ P175: Pulse Input Signal Bias

Setting range (%)	-99.0~100.0(Setting unit: 0.1%)
-------------------	---------------------------------

■ P176: Pulse Input Signal Gain

Setting range (%)	0.0~100.0(Setting unit: 0.1%)
-------------------	-------------------------------

- Bias and gain are set by the proportion of max output frequency (parameter P008).
- Don't output frequency which is more than max output frequency and upper limiting frequency. Frequency can not descend to frequency below lower rate limit.
- Even if input minus frequency signal, inverter won't reverse.

■ When bias is set to positiv

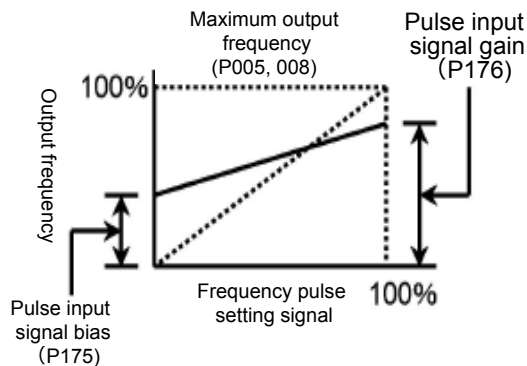

■ When bias is set to minus

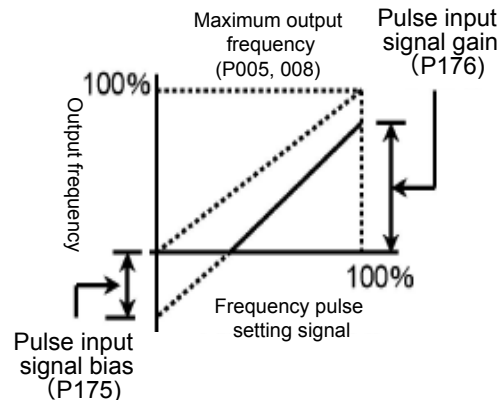
**P177** Pulse input signal filter

It can be used for setting pulse input signal's response. Please set when abnormal frequency be detected.

Setting range (time)	10~100 (Setting unit: 1 time)
----------------------	-------------------------------

## P178 Winding Mode Operation Select

It is used for setting winding mode operation select.

Value	Name
0	Normal mode
1	2-point normal mode
2	Random mode
3	2-point random mode

### ■ Random mode

When set “P178: winding mode operation select” to “2” or “3”, winding mode is random mode. Rise time is swing between “P179: max random rise time” and “P180: minimum random rise time”.

### ■ 2-point mode

When set “P178: winding mode select” to “1” or “3”, and “P182: winding stop length” is not 0, winding mode is 2-point mode. Setting frequency will change by the increase of winding length, and will be “P046: second speed frequency” at last.

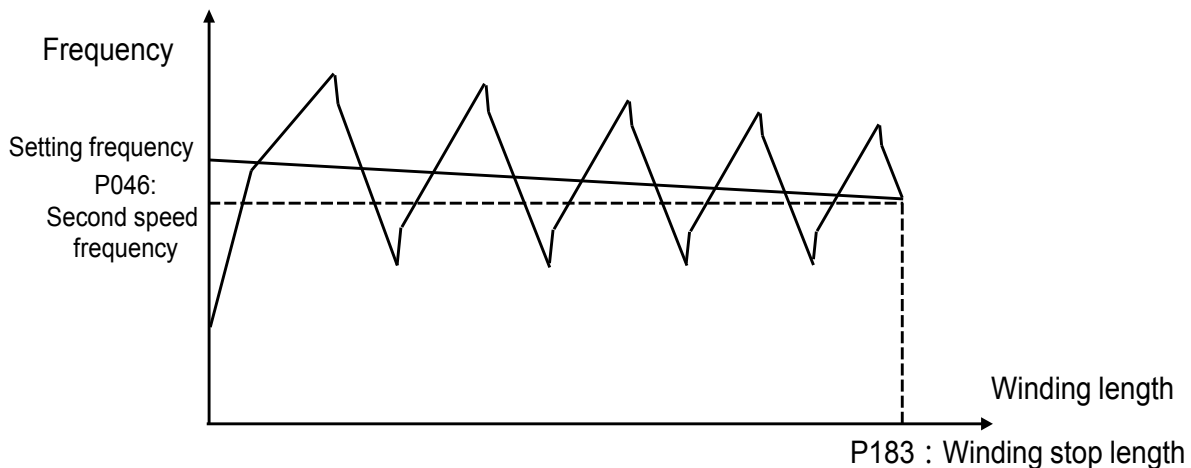

Especially, when P178 is set to “3”, 2-point mode, reference frequency change from setting frequency to second speed frequency by winding length, and rise time ratio change in random range.

**P179** Max random rise time**P180** Minimum random rise time

Set the max and minimum value of rise time for random function.

Setting range (%)	0.0~100.0(Setting unit: 0.1%)
-------------------	-------------------------------

**P181** Winding length multiplier

Setting range (%)	0.0~100.0(Setting unit: 0.1%)
-------------------	-------------------------------

When set parameter “P169: winding mode control select” to “1” or “2”, and set parameter “P036: SW1 function select” to “14”, input pulse in SW1, it can be used for calculating the length of “P181: winding length multiplier”.

**P182** Winding stop length

When winding length is counted to stop length, winding mode will stop.

Setting range (m)	0~60.00 (Setting unit: 1m)
-------------------	----------------------------

- When setting value is 0, winding mode stop working.
- The relationship between setting value and display is as follow.  
When 1m~9,999m, display as 1~9999.  
When 10,000m~99,999m, display as 1.000~9.999.  
When 100,000m~600,000m, display as 10.00~60.00.

# “Administrative Measures for Control of Pollution Caused by Electronic Information Products” in China

## Names and Content Marks of Toxic or Hazardous Substances and Elements

Component name	Toxic or hazardous substances or elements					
	Lead (Pb)	Mercury (Hg)	Cadmium (Cd)	Hexavalent Chromium (Cr6+)	Polybrominated Biphenyl (PBB)	Polybrominated Diphenyl Ethers (PBDE)
Base plate assembly	×	○	○	○	○	○
Case	○	○	○	○	○	○
Other accessories	○	○	○	○	○	○

○ : Indicates that the content of toxic or hazardous substances contained in all homogeneous materials for this component is below the standard specified in “Requirements for Concentration Limits for Certain Hazardous Substances in Electronic Information Products”.

× : Indicates that the content of toxic or hazardous substances contained in at least one homogeneous material for this component is above the standard specified in “Requirements for Concentration Limits for Certain Hazardous Substances in Electronic Information Products”.

Note: This product complies with RoHS Directive.

The items that does not comply with RoHS Directive are also listed in the table above.

TYPE 1

# Precautions on European Standard Directives

---

1. CE Marking labeled on the inverter is based on Low Voltage Directive.
2. Adaptability to EMC Directive shall be determined in a complete plant equipped with the inverter.
3. Inverter's control circuit terminals are only basically insulated (protection against electric shock I, overvoltage category II, pollution degree 2).  
To meet requirements of CE Marking, final product shall be subject to insulation.
4. Power supply input end of the inverter shall be equipped with protection devices for overcurrent, short circuit and leakage of electricity.
5. Main circuit wiring shall be connected with ring-type compression terminals.  
Main circuit wiring 200V type : (L, N, U, V, W)  
400V type : (R/L1, S/L2, T/L3, U, V, W)
6. The inverter is only used for fixed installation, not for other occasions.
7. Adaptability to Low Voltage Directive for the inverter
  - 1) Protection against Electric Shock: I
  - 2) Overvoltage category: II
  - 3) Pollution degree: 2
8. The capacity of relay output terminal mark A, B, C is 30V DC, 0.3A.
9. Make sure to ground the supply neutral. (only 400V-type)



## Conditions of CE Marking

---

VF200 inverter meets requirements of overvoltage category II stipulated in EN 61800-5-1 standard.

A transformer subject to basic insulation shall be installed between inverter and power supply.

The insulated transformer shall use the product in compliance with EN standard or IEC standard (with basic insulation at least).

Overall system shall meet requirements of overvoltage category III stipulated in EN 61800-5-1 standard.

According to EMC regulation, the inverter is not an independent operating unit. The overall system may not be evaluated based on electro magnetic compatibility, until the overall system is composed of the inverter and device with filter.

# Warranty

---

The products and specifications listed in this document are subject to change without prior notice as occasioned by the improvements that we introduce into our products. Therefore, when you consider the use of the product and place orders for the product, you may contact our customer service representatives and check that the details listed in this document are commensurate with the most up-to-date information.

We spare no efforts to give utmost care and attention to the quality of this product. However, to ensure optimal performance, we recommend that:

- 1) When our product is used beyond the range of the specifications, environment or conditions listed herein, or it is used in any environment or conditions not listed herein, or when you are considering the use of product in any condition or environment that is not specified herein, or when you are considering the use of our product for particular purposes for which high reliability is required such as safety environment and control systems used for the railroad, aviation or medical care industries, you should contact our customer service representatives and obtain proper specification sheets.
- 2) Consult with us for the specifications of your own products, end users, environment and conditions of use, installation locations etc. to prevent accidents caused by the items not listed herein.
- 3) Take safety measures (such as double interlock, etc.) to the external circuit of the product to ensure the safety of the whole system in case of abnormalities caused by product failure or external factors; and always use this product within its limits and capacity mentioned in this document.
- 4) For the product you have purchased from us or with the product delivered to your premises, promptly perform an acceptance inspection; for handling of our product both before and during the acceptance inspection, give full attention to the control and preservation of our product.

## 【Warranty period】

- The warranty period of this product is 3 years from either the date of purchase or the date on which the product is delivered to the location specified by the

Buyer.

However, the warranty period (the so-called “3 years”) shall be valid only until 42 months from the date of manufacture which includes a maximum of 6-month distribution period.

**【Warranty scope】**

• In the event of any failure or obvious defect in the product due to the reasons solely attributable to Panasonic Electric Works, Panasonic Electric Works shall remedy such malfunctioning or defective product at its own cost in one of the following ways: i) repair such product; ii) replace such product; iii) supply of replacement parts.

However, the warranty shall not cover the failures or defects arising from any of the following reasons.

1. Specifications, standards and handling procedures specified by the Buyer.
2. Modifications to the structure, performance or specifications performed by a party other than the Seller after the date of purchase or the date on which the product is delivered.
3. Phenomena that could not have been foreseen with the technology that was put into practical use at or after the time of purchase.
4. Cases that the range of conditions, circumstances or environment described in the manual or specification sheet are exceeded.
5. Damages that could be avoided if Buyer’s product provides the function and structure generally accepted in the industry when this product is incorporated into Buyer’s product.
6. Natural disasters or force majeure.
7. Consumable goods such as capacitor, cooling fan and relay or optional accessories such as cables.

In addition, the warranty described herein shall only cover the single unit purchased or delivered by Panasonic Electric Works. Damages arising from failures or defects of this product are excluded from this warranty.

# Revision History

---

The manual No. is recorded on the back cover.

Issue Date	Manual No.	Descriptions of Revision
2013.01	WME-VF200-A	The 1 <sup>st</sup> edition

# ATTENTION

- This product is not designed or manufactured to be used in equipment or systems in situations that can affect or endanger human life.  
When considering this product for operation in special applications such as machinery or systems used in movable body, medical, aerospace, nuclear energy, or submarine relay applications, please contact your nearest Panasonic dealer.
- Although this product was manufactured under strict quality control conditions, it is strongly advised to install safety devices to forestall serious accidents when used in facilities where a breakdown of this product is likely to cause a serious human injury or generate major losses.
- Consult with your Panasonic dealer when using this product for loads other than a 3-phase AC motor.

Please contact .....

## **Panasonic Industrial Devices SUNX Suzhou Co., Ltd.**

No.97, Huoju Road, New District Suzhou, Jiangsu province, China

Phone: +86-512-6843-2580 FAX: +86-512-6843-2590

[panasonic.net/id/pidsx/global](http://panasonic.net/id/pidsx/global)

About our sale network, please visit our website.

January, 2013 PRINTED IN CHINA

© Panasonic Industrial Devices SUNX Suzhou Co., Ltd. 2013  
WME-VF200-A