

# Magelis Smart iPC Industrial PCs User Manual

eng

November 2004



---

---

# Table of Contents

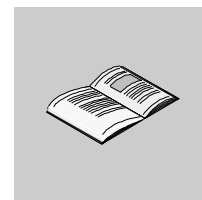

---

|                  |   |           |
|------------------|---|-----------|
|                  | <b>Safety Information</b> .....           | <b>5</b>  |
|                  | <b>About the Book</b> .....               | <b>17</b> |
| <b>Part I</b>    | <b>General overview</b> .....             | <b>19</b> |
|                  | At a Glance .....                         | 19        |
| <b>Chapter 1</b> | <b>Introduction</b> .....                 | <b>21</b> |
|                  | Introduction .....                        | 21        |
| <b>Chapter 2</b> | <b>Physical overview</b> .....            | <b>23</b> |
|                  | At a Glance .....                         | 23        |
|                  | Package Contents .....                    | 24        |
|                  | Smart iPC Unit description .....          | 25        |
| <b>Chapter 3</b> | <b>Characteristics</b> .....              | <b>27</b> |
|                  | At a Glance .....                         | 27        |
|                  | Characteristics of the Smart iPC .....    | 28        |
|                  | Environment characteristics .....         | 30        |
| <b>Part II</b>   | <b>Implementation</b> .....               | <b>31</b> |
|                  | At a Glance .....                         | 31        |
| <b>Chapter 4</b> | <b>Main Power Connection</b> .....        | <b>33</b> |
|                  | At a Glance .....                         | 33        |
|                  | Connecting the Power Wires .....          | 34        |
|                  | Grounding Cautions .....                  | 38        |
|                  | Connecting I/O Signal Lines .....         | 39        |
| <b>Chapter 5</b> | <b>Getting started</b> .....              | <b>41</b> |
|                  | First power-up .....                      | 41        |
| <b>Chapter 6</b> | <b>Hardware extensions</b> .....          | <b>45</b> |
|                  | At a Glance .....                         | 45        |
|                  | Before installation .....                 | 46        |
|                  | Removing the Smart iPC Unit's Cover ..... | 47        |

---

|                   |   |           |
|-------------------|---|-----------|
|                   | Smart iPC internal view . . . . .           | 48        |
|                   | Main Memory Installation . . . . .          | 49        |
|                   | PCMCIA Unit Installation . . . . .          | 50        |
|                   | CF Card Installation and Removal . . . . .  | 52        |
| <b>Chapter 7</b>  | <b>Configuration of the Bios . . . . .</b>  | <b>55</b> |
|                   | At a Glance . . . . .                       | 55        |
|                   | Accessing the Bios configuration . . . . .  | 56        |
|                   | Configuration Screens . . . . .             | 57        |
| <b>Chapter 8</b>  | <b>Maintenance . . . . .</b>                | <b>59</b> |
|                   | Regular Cleaning . . . . .                  | 59        |
| <b>Part III</b>   | <b>Installation . . . . .</b>               | <b>63</b> |
|                   | At a Glance . . . . .                       | 63        |
| <b>Chapter 9</b>  | <b>Dimension/Assembly. . . . .</b>          | <b>65</b> |
|                   | At a Glance . . . . .                       | 65        |
|                   | Dimensions . . . . .                        | 66        |
|                   | Cropping for Cabinet Installation . . . . . | 68        |
|                   | Panel Mounting . . . . .                    | 69        |
|                   | Installing the Smart iPC . . . . .          | 70        |
| <b>Chapter 10</b> | <b>Connections to PLCs. . . . .</b>         | <b>75</b> |
|                   | Connection to PLCs . . . . .                | 75        |
| <b>Part IV</b>    | <b>Appendices . . . . .</b>                 | <b>77</b> |
|                   | At a Glance . . . . .                       | 77        |
| <b>Chapter 11</b> | <b>Accessories . . . . .</b>                | <b>79</b> |
|                   | Accessories . . . . .                       | 79        |

---

# Safety Information

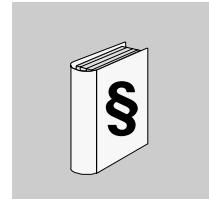

---

## General safety information for users

### General

The present documentation is aimed at qualified technical personnel responsible for the implementation, operation and maintenance of the products described. It contains the information necessary for compliance with the proper use of the products. However, those who wish to make more "advanced" use of our products may find it necessary to consult our nearest distributor in order to obtain additional information.

**The contents of this documentation are not contractual, and in no way constitutes an extension to, or restriction of, the contractual warranty clauses.**

### Personnel qualifications

Only **qualified personnel** are authorized to implement, operate or maintain the products. The interference of non-qualified persons or failure to observe the security instructions contained in this manual, or attached to the devices, can endanger the personnel and/or do irreparable damage to the equipment. The following persons can be designated as "**qualified personnel**":

- at application design level, engineering department personnel who are familiar with automation safety concepts (for example, a design engineer),
  - at equipment implementation level, personnel who are familiar with the installation, connection and commissioning of automation equipment (for example, an installation assembly or cabling engineer, or a commissioning technician),
  - at operation level, personnel who are experienced in the use and control of automation and computing equipment (for example, an operator),
  - as far as preventive or corrective maintenance is concerned, persons trained and qualified in regulating or repairing automatic and computing devices (for example an operating technician, or an after-sales service technician, etc.).
-

**Switching off**

Control software such as is typically used on Industrial PCs permits various users to be given different rights. A user who may not close software may also not switch the Industrial PC off, since data can be lost from the hard disk by switching off while software is running.

If the Industrial PC is switched off as the software is writing a file to the hard disk, the file can be destroyed. Control software typically writes data to the hard disk every few seconds, so that the probability of causing damage by switching off while the software is running is very high.

To avoid that please respect the instructions of the operation system for closing the softwares and switching off the Industrial PC.

---

**Compliance of use**

The products described in the present documentation **comply with the European Directives\*** to which they are subject (EC marking). However, these can only be used correctly if in applications for which they are specifically intended, as specified in the relevant documentation, and in connection with approved third-party products. As a general rule, correct usage of the products, with no danger to personnel or hardware, consists of complying with all handling, transport and storage recommendations, and all installation, operation and maintenance instructions.

\* EMCD and LVD directives concerning Electromagnetic Compatibility and Low Voltage.

---

**Replacement and recycling of used batteries**

Replace batteries with those of the same type, and dispose of any defective batteries in the same way as toxic waste.

Lithium or mercury batteries must not be thrown into a fire, opened, recharged or welded.

---

**Lithium battery**

The terminal contains a lithium battery, which is used to save certain data such as the date and time.

This must only be replaced by a qualified technician.

---

|   |   |
|---|---|
|  | <b>WARNING</b>  |
|   | Non-compliance with this warning may lead to a risk of explosion!<br><b>Failure to follow this precaution can result in death, serious injury, or equipment damage.</b> |

---

**Federal  
Communications  
Commission  
Radio Frequency  
Interference  
Statement - For  
U.S.A.**

This equipment has been tested and found to comply with the limits for a Class A digital device, pursuant to Part 15 of the FCC Rules. These limits are designed to provide reasonable protection against harmful interference in a residential installation. This equipment generates, uses and can radiate radio frequency energy and, if not installed and used in accordance with the instructions, may cause harmful interference to radio communications. However, there is no guarantee that interference will not occur in a particular installation. If this equipment does cause harmful interference to radio or television reception, which can be determined by turning the equipment off and on, the user is encouraged to try to correct the interference by one or more of the following measures:

- Reorient or relocate the receiving antenna.
- Increase the separation between the equipment and receiver.
- Connect the equipment into an outlet on a circuit different from that to which the receiver is connected.
- Consult the Support Service Center or an experienced radio/TV technician for help.

|   |   |
|---|---|
|  | <b>WARNING</b>  |
|   | <p>To assure continued compliance, use only shielded interface cables when connecting to a computer or peripheral. Also, any changes or modifications not expressly approved by the party responsible for compliance could void the user's authority to operate this equipment. This device complies with Part 15 of the FCC Rules. Operation is subject to the following two conditions:</p> <ul style="list-style-type: none"><li>● This device may not cause harmful interference received, including interference that may cause undesired operation.</li><li>● This device must accept any interference received, including interference that may cause undesired operation.</li></ul> <p><b>Failure to follow this precaution can result in death, serious injury, or equipment damage.</b></p> |

**Safety Warnings**  
**- For U.K.**

|   |  |
|---|--|
|  | <b>WARNING</b>   |
|   | <p><b>This apparatus must be earthed for your safety.</b></p> <p>To ensure safe operation the three-pin plug must be inserted only into a standard three-pin power point, which is effectively earthed through the normal household wiring.</p> <p>Extension cords used with the equipment must be three-core and be correctly wired to provide connection to earth. Wrongly wired extension cords are a major cause of fatalities.</p> <p>The fact that the equipment operates satisfactorily does not imply that the power point is earthed and that the installation is completely safe. For your safety, if you have any doubt about the effective earthing of the power point, consult a qualified electrician.</p> <p><b>Failure to follow this precaution can result in death, serious injury, or equipment damage.</b></p> |



**WARNING****THIS APPLIANCE MUST BE EARTHED****Important**

The wires in this mains lead are coloured in accordance with the following code:

- Green-and-yellow: Earth
- Blue: Neutral
- Brown: Live

As the colours of the wires in the mains lead of this apparatus may not correspond with the coloured markings identifying the terminals in your plug, proceed as follows:

The wire which is coloured GREEN-and-YELLOW must be connected to the terminal in the plug which is marked by the letter E or by the safety earth symbols coloured GREEN or GREEN-and-YELLOW.

The wire which is coloured Blue must be connected to the terminal which is marked with the letter N or coloured BLACK.

The wire which is coloured Brown must be connected to the terminal which is marked with the letter L or coloured RED.

The mains plug on this equipment must be used to disconnect the mains power.

Please ensure that a socket outlet is available near the equipment and is easily accessible.

**Failure to follow this precaution can result in death, serious injury, or equipment damage.**

|   |  |
|---|--|
|  | <b>WARNING</b>   |
|   | <ul style="list-style-type: none"><li>● This equipment is not designed for connection to an IT power system:<br/>An IT system is a system having no direct connections between live parts and Earth; the exposed conductive parts of the electrical installation are earthed.<br/>An IT system is not permitted where the computer is directly connected to public supply systems in the UK.</li><li>● Disconnect the mains plug from the supply socket when the computer is not in use.</li></ul> <p><b>Failure to follow this precaution can result in death, serious injury, or equipment damage.</b></p> |

---

**Warnung Für  
Deutschland**

**Warnung bezüglich der Lithiumbatterie (Sicherungsbatterie)**

Lithiumbatterie

Dieser Computer enthält eine Lithiumbatterie zur Sicherung von Datum und Uhrzeit der eingebauten Uhr sowie anderer Systemdaten im Speicher bei einer Unterbrechung der Hauptstromversorgung. Diese Sicherungsbatterie darf nur von Kundendienstpersonal ausgewechselt werden.

Warnung! Bei falschem Gebrauch besteht Explosionsgefahr!

Entsorgung gebrauchter Batterien nach Angaben des Herstellers.

---

## Hazardous Location Installations - for USA and Canada

---

### General

Schneider Automation designed the systems with the intention of meeting the requirements of Class 1, Division 2 hazardous location applications. Division 2 locations are those locations that are normally non-hazardous, but potentially hazardous should an accident expose the area to flammable vapors, gases or combustible dusts.

These systems are non-incendiary devices. They are not intrinsically safe and should never be operated within a Division 1 (normally hazardous) location when installed as described here. Nor should any peripheral interface device attached to these systems be located within Division 1 locations unless approved and/or certified diode barriers are placed in series with each individual signal and DC power line. Any such installations are beyond the bounds of Schneider Automation design intent. Schneider Automation accepts no responsibility for installations of this equipment or any devices attached to this equipment in Division 1 locations.

**It is mandatory to install the Hazardous Location.**

### Warning

For AC version equipment only:  
the power switch is in arcing device. It should be switched to the ON position and the corresponding retainer bracket for the Control Box should be attached according to the Hazardous Location Kit service instruction

Only technically qualified service personnel should perform installation and service. These workstations are designed to require no service in the course of normal operation by an operator.

### Warning

It is the user's responsibility in case of maintenance or repair of any subassembly to verify that the exchanged or repaired module is labelled as a Class I Division 2 hazardous location.

It is the responsibility of the customer to ensure that the product is properly rated for the location. If the intended location does not presently have a Class, Division and Group rating, then users should consult the appropriate authorities having jurisdiction in order to determine the correct rating for that hazardous location.

In accordance with Federal, State/Provincial, and Local regulations, all hazardous location installations should be inspected prior to use by the appropriate authority having jurisdiction. Only technically qualified personnel should install, service, and inspect these systems.

**Warning**

Suitable for use in Class I, Division 2 Groups A, B, C, and D, hazardous locations or non-hazardous locations only.

**Warning - Explosion Hazard**

Substitution of components may impair suitability for Class I, Division 2.

**Warning**

For a use in hazardous locations, the PCI or ISA controller cards shall be found in category NWHP2, provided that they are suitable for Class I, Division 2, Groups A, B, C, and D; T-code: T4A, and suitable for an ambient temperature range of +0°C to +50°C.

**Warning - Explosion Hazard**

Do not connect or disconnect equipment unless the power has been switched off or the area is known to be non-hazardous.

**Warning**

Power wiring must be in accordance with the National Electrical Code article 501.4(B) for Class I, Division 2.

**Warning - Explosion Hazard**

When in hazardous locations, turn off power before replacing or wiring modules.

**Warning - Explosion Hazard**

Do not connect or disconnect the output ports such as PS2/USB/Communication cable/Video connectors, when the unit is in a Hazardous Location area

**Definition**

The following Class and Division explanations are derived from Article 500 (Sections 5 and 6) of the United States National Fire Protection Agency National Electric Code (NFPA 70, 1990). They are not complete and are included here only for a general description for those not familiar with generic hazardous locations requirements. Persons responsible for the installation of this equipment in hazardous locations are responsible for ensuring that all relevant codes and regulations related to location rating, enclosure, and wiring are met.

**Class I Locations**

Class I locations are those in which flammable gases or vapors are or may be present in the air in quantities sufficient to produce explosive or ignitable mixtures.

**Class II Locations**

Class II locations are those that are, or may become, hazardous because of the presence of combustible dust.

**Division 1 Locations**

A Division 1 location is one in which flammable or ignitable gases, vapors or combustible dusts and particles can exist due the following conditions:

- Normal operating conditions.
- Due to repair, maintenance conditions, leakage, or where mechanical failure or abnormal operation of machinery or equipment might release or cause explosive or ignitable mixtures to be released or produced.
- Combustible dusts of an electrically conductive nature may be present in hazardous quantities.

**Note**

Schneider Automation MPC\*\*\* systems are not suitable for installation within Class II Division 2 and Class 1 Division 1 locations.

**Note**

Electrical equipment cannot be installed in Division 1 locations unless they are intrinsically safe, installed inside approved explosion-proof enclosures, or installed inside approved purged and pressurized enclosures.

**Division 2 Locations**

- Class I volatile flammable liquids or flammable gases are handled, processed or used, but confined within closed containers or closed systems from which they can escape only in cases of accidental rupture or breakdown of such enclosures or systems, or in case of abnormal operation of equipment.
- Ignitable concentrations of Class I vapors or gases are normally prevented by positive mechanical ventilation, but may become hazardous due to mechanical failure of those ventilation systems.
- Location is adjacent to a Division 1 location.
- Class II combustible dust is not normally in the air in quantities sufficient to produce explosive or ignitable mixtures. Dust accumulations are normally insufficient to interfere with normal operation of electrical equipment or other apparatus. Combustible dust may be in suspension in the air as a result of the following: infrequent malfunctioning of handling or processing equipment; combustible dust accumulations on, or in the vicinity of, electrical equipment; may be ignitable by abnormal operation or failure of electrical equipment.

**Groups**

All electrical equipment that is approved for use in hazardous locations must include a group rating. Various flammable and combustible substances are divided into these groups as a function of their individual maximum experimental safe gap (MESG), explosion pressure, and ignition temperature. Component temperatures and the potential for spark based upon voltage, current and circuit characteristics of electrical equipment will determine what the equipment group rating will be. A device approved for installation within Class I, Group A locations may also be used in Groups B, C, or D.

**Note**

Approved Class I equipment may not be suitable for Class II installations. Class I includes Groups A, B, C, and D. Class II includes Groups F, and G.

**Power Switch**

The amount of input power required by these systems classifies a power switch as an incendiary device because the voltage and current across the make/break device are capable of creating a spark.

Hazardous location regulations require that a power switch rated for ordinary locations may be used if it is located in an area specified as non-hazardous.

However, limits in cable length between the workstation and the power switch may apply. Otherwise the switch must be compliant with Class I, Division 1 requirements (intrinsically safe). These switches are built in a manner that prevents the possibility of a spark when contacts are made or broken.

Use suitable UL listed and/or CSA Certified Class I, Division 1 switches in hazardous locations. These switches are available from a wide number of sources. It is the responsibility of the customer to ensure that the power switch selected for the installation has the correct hazardous locations rating for the location in which it is installed.

**Cable connections**

Division 2 hazardous location regulations require that all cable connections be provided with adequate strain relief and positive interlock. USB connections can never be used in hazardous location installations, because USB connectors do not provide adequate strain relief. Never connect or disconnect a cable while power is applied at either end of the cable. All communication cables should include a chassis ground shield. This shield should include both copper braid and aluminum foil. The D-sub style connector housing should be a metal conductive type (e.g., molded zinc) and the ground shield braid should be well terminated directly to the connector housing. Do not use a shield drain wire.

The outer diameter of the cable must be suited to the inner diameter of the cable connector strain relief in order to ensure that a reliable degree of strain relief is maintained. Always secure the D-Sub connectors to the workstation-mating connectors via the two screws located on both sides.

**Warning**

Never connect or disconnect the communication cables while power is applied at either end of the cable. This may result in an incendiary spark. Permanent damage to the workstation communication components may occur.

**Operation and Maintenance**

The systems have been designed for compliance with relevant spark ignition tests. However, please note that the workstation front panel keypad switches and PS/2 connector are the only make/break components intended to be exercised by the operator in the course of normal operation.

Always observe the following rules with respect to hazardous location installations:

- Always install the workstations within an enclosure suitable for the specific application. General-purpose enclosures may be acceptable for Class I applications but are never acceptable for Class II applications. Type 4 (IP 65) enclosures are recommended even when not required by regulations.
- If present, keep enclosure doors or openings closed at all times, to avoid the accumulation of foreign matter inside the workstation.
- Never subject the unit to any installation or service procedures unless power is removed and the area is known to be non-hazardous. This includes the installation or removal of power cables, communication cables, or removal of the rear cover of the unit.

---

**Safety Agency Approval**

The Schneider Automation systems are designed to meet the following standards:

- Underwriters Laboratories Inc., UL 1604 Standard for Safety Electrical equipment for use in Class I Division 2 locations
  - Underwriters Laboratories Inc., UL 60950, Information Technology Equipment
  - Canadian Standard Association, Specification C22.2 No. 213-M1987 Non incendiary electrical equipment for use in Class I, Division 2 hazardous locations.
  - Canadian Standards Association, Specification C22.2 No. 950 Information Technology Equipment
  - EN 60950, Information Technology Equipment
-



---

## About the Book

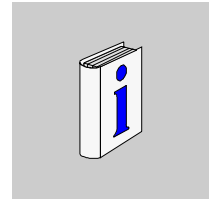

---

### At a Glance

**Document Scope** This manual describes the installation of the Magelis Smart iPC of industrial PCs.

### Related Documents

| Title of Documentation                           | Reference Number |
|--|------------------|
| Magelis Smart and Compact iPC installation guide | 35008589         |

**User Comments** We welcome your comments about this document. You can reach us by e-mail at [techpub@schneider-electric.com](mailto:techpub@schneider-electric.com)

---



---

# General overview

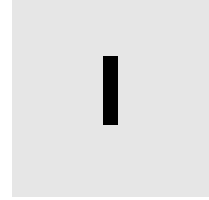

---

## At a Glance

### Subject of this part

This part provides an overview of the Magelis Smart iPC products.

### What's in this Part?

This part contains the following chapters:

| Chapter | Chapter Name      | Page |
|---------|-------------------|------|
| 1       | Introduction      | 21   |
| 2       | Physical overview | 23   |
| 3       | Characteristics   | 27   |



---

# Introduction



---

## Introduction

### Thank you

Congratulations!

Thank you for having purchased an industrial computer from the Magelis Smart iPC range.

This computer, designed to operate in an industrial environment, features the very latest technologies.

---

### At a Glance

Magelis Smart iPC computers is a panel PC product working with 24VDC industrial voltage.

The Smart iPC runs Microsoft Windows® embedded operating system and is dedicated to web browsing application.

The reference of the product is :

- Reference: MPC ST52 ●●● ●●●

The characteristics are detailed in chapter 3.

---



---

# Physical overview



# 2

---

## At a Glance

### Subject of this chapter

This chapter provides physical overviews of the products.

### What's in this Chapter?

This chapter contains the following topics:

| Topic                      | Page |
|----------------------------|------|
| Package Contents           | 24   |
| Smart iPC Unit description | 25   |





---

## Package Contents

---

**Items**

The following items are included in the Smart Magelis iPC package. Before using the unit, please confirm that all items listed here are present.

| Designation                                | Figure  |
|--|---|
| MPC ST52 *** **                            |  A line drawing of a rectangular MPC ST52 unit with a smaller inner rectangle and a small component on the right side. |
| Installation Fasteners (4/set x 2)         |  A line drawing of a T-shaped installation fastener with a hook on the bottom.   |
| Installation Guide                         |  A rectangular icon with the text "Installation Guide" inside.   |
| CF Card                                    |  A line drawing of a CompactFlash (CF) card.  |
| CD-ROM<br>OS restore and bundled softwares |  A line drawing of a CD-ROM disc.  |

---



## Smart iPC Unit description

### Features

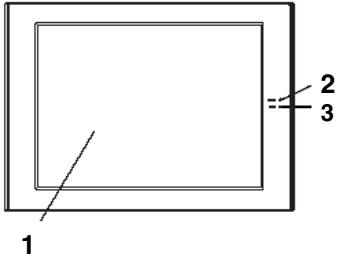
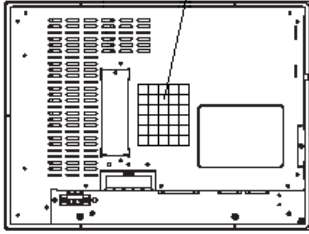
| View       | Figure   | Legend   |     |        |       |                                |        |  |            |                                  |     |        |       |                  |
|------------|--|--|-----|--------|-------|--------------------------------|--------|--|------------|----------------------------------|-----|--------|-------|------------------|
| Front      |  <p>1</p> <p>2</p> <p>3</p> | <p>1 : Display / Touch Panel<br/>2 : Power Lamp LED (POWER)</p> <table border="1"> <thead> <tr> <th>LED</th> <th>Status</th> </tr> </thead> <tbody> <tr> <td>Green</td> <td>Normal Operation<br/>(Power On)</td> </tr> <tr> <td>Orange</td> <td>System Monitor Error<br/>Touch Panel<br/>Self Test Error</td> </tr> <tr> <td>Orange/Red</td> <td>Backlight is not<br/>functionning</td> </tr> </tbody> </table> <p>3 : IDE Access Lamp</p> <table border="1"> <thead> <tr> <th>LED</th> <th>Status</th> </tr> </thead> <tbody> <tr> <td>Green</td> <td>Normal Operation</td> </tr> </tbody> </table> | LED | Status | Green | Normal Operation<br>(Power On) | Orange | System Monitor Error<br>Touch Panel<br>Self Test Error | Orange/Red | Backlight is not<br>functionning | LED | Status | Green | Normal Operation |
| LED        | Status   |  |     |        |       |                                |        |  |            |                                  |     |        |       |                  |
| Green      | Normal Operation<br>(Power On)   |  |     |        |       |                                |        |  |            |                                  |     |        |       |                  |
| Orange     | System Monitor Error<br>Touch Panel<br>Self Test Error   |  |     |        |       |                                |        |  |            |                                  |     |        |       |                  |
| Orange/Red | Backlight is not<br>functionning   |  |     |        |       |                                |        |  |            |                                  |     |        |       |                  |
| LED        | Status   |  |     |        |       |                                |        |  |            |                                  |     |        |       |                  |
| Green      | Normal Operation   |  |     |        |       |                                |        |  |            |                                  |     |        |       |                  |
| Rear       |  <p>4</p>                  | 4 : Fan  |     |        |       |                                |        |  |            |                                  |     |        |       |                  |

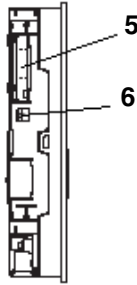
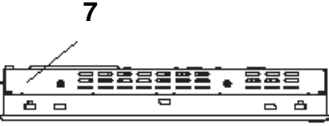
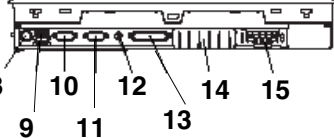
| View      | Figure  | Legend   |
|-----------|---|--|
| Left Side |  | <p>5 : PCMCIA Interface</p> <p>6 : Ethernet Interface<br/>10 Base-T / 100 BASE-TX<br/>Auto Changeover</p>  |
| Top       |  | <p>7 : Rear Cover</p> <p>This cover is removed when installing a main memory</p>   |
| Bottom    |  | <p>8 : Keyboard Connector (KEYBOARD)<br/>Connect a PS/2-compatible keyboard</p> <p>9 : USB Interface (2 ports)<br/>Provides a USB 1.1 compatible connection. Connect a USB connectable device here.</p> <p>10 : Serial Interface (COM1)</p> <p>11 : Serial Interface (COM2)</p> <p>12 : Speaker Output Connector (SPEAKER OUT)</p> <p>13 : Printer Connector (LPT1)</p> <p>14 : CF Card Interface Cover</p> <p>15 : Power Input Terminal Block</p> |

---

# Characteristics



# 3

---

## At a Glance

### Subject of this chapter

This chapter gives the product characteristics.

### What's in this Chapter?

This chapter contains the following topics:

| Topic                            | Page |
|----------------------------------|------|
| Characteristics of the Smart iPC | 28   |
| Environment characteristics      | 30   |

## Characteristics of the Smart iPC

---

### Introduction

The different characteristics of the Smart iPC model are given below.

---

### CPU characteristics

| Element              | Characteristics                             |
|----------------------|---|
| Processor            | VIA 667 MHz, secondary memory cache 512 KB  |
| RAM                  | DIMM Socket 1: 256 MB / 512 MB (max 512 MB) |
| Video processor      | VIA Twister-T with 32 Mb ram UMA type       |
| Ethernet TCP/IP link | 1 x 10/100base TX (RJ45 interface)          |
| PS/2 ports           | 1 keyboard interface                        |
| USB ports            | 2 x USB 1.1                                 |
| COM 1 serial port    | RS232C                                      |
| COM 2 serial port    | RS232C                                      |
| Parallel port        | 1 bi-directional link                       |
| Extension card slot  | 1 PCI 2.2 interface slot                    |
| PCMCIA slot          | 2 ports Type 2 on side                      |
| Audio port           | Speaker out in standard jack interface)     |
| Dimensions (WxHxD)   | 395 mm x 294 mm x 60 mm                     |
| Weight               | 6.0 Kg                                      |

---

### Display characteristics

| Element                | Characteristics  |
|------------------------|--|
| Graphics               | XGA active matrix (1024x768 dots), VESA max. 64 K colors   |
| Nb of colors           | 260 K colors   |
| Brightness             | 250 cd/m (typical value, adjust through Windows® 4 steps)  |
| View angle             | Vertical 140°, horizontal 160° maximum                     |
| Touch sensitive screen | Analog resistive film, resolution 1024x1024, USB interface |
| Backlight's life span  | >50 000h at ambient temperature 25 °C                      |

---

**Power supply**

| <b>Element</b> | <b>Characteristics</b>       |
|----------------|------------------------------|
| Supply voltage | 24 V DC (range 18...36 V DC) |
| Consumption    | 90 W                         |
| Short dips     | 1 ms                         |

**Operating systems**

The products are delivered with a Compact Flash card pre-installed operating system according the reference ordered.  
 The products work with the operating system Microsoft Windows XP embedded.

| <b>Reference</b> | <b>Characteristics</b>  |
|------------------|---|
| MPC ST52 NDJ 00T | Smart iPC with display 15" XGA Touch Screen, 24 V DC supply, Compact Flash with Windows Embedded XP pre-installed |

## Environment characteristics

---

**General** The environment characteristics given below are applicable to the products.

---

**Characteristics** The environment characteristics are as follows:

| Characteristics                           | Value   | Standards  |
|---|---|--|
| <b>Degree of Protection</b>               | <ul style="list-style-type: none"> <li>● IP 65/NEMA4 for the front panel.</li> <li>● IP 20 for the rest of the product</li> </ul> | -  |
| <b>Operating temperature</b>              | 0 °C to 50 °C   | EN 61131-2, UL compliant   |
| <b>Storage temperature</b>                | -20 °C to 60 °C   | IEC 68-2-2 tests Bb and Ab,<br>IEC 68-2-14 tests Na and EN 61131-2 compliant |
| <b>Operating altitude</b>                 | 0 to 3000 m maximum   | -  |
| <b>Storage altitude</b>                   | 0 to 12000 m maximum  | -  |
| <b>Vibration</b><br>(in operation)        | 3,5mm amplitude from 5 to 9 Hz,<br>1 g amplitude from 9 to 150 Hz   | IEC 68-2-6 Fc test<br>and EN 61131-2 compliant                               |
| <b>Shock Resistance</b><br>(in operation) | 15 g over 11 ms   | IEC 68-2-27 Ea test<br>and EN 61131-2 compliant                              |
| <b>Hygrometry</b>                         | 10 - 90%  | -  |
| <b>Immunity to interference</b>           | High frequency interference   | EN 61131, IEC 1000-4-3/6 level 3   |
|   | Electromagnetic waves   | Class A/EN 55022/55011   |
|   | Safety of personnel and property  | EN 61131-2, UL/CSA and IEC 529/IEC 950                                       |

---

**Certification** The products have been developed to comply with the following standards:

- UL 508
  - IEC/EN 60950
  - EN 55022
  - IEC/EN 61131-2
  - CUL
  - Classification in hazardous areas CLASS 1 - Division 2 - UL1604
-

---

# Implementation

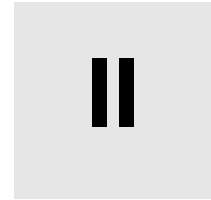

---

## At a Glance

### Subject of this part

This part concerns the implementation of products.

### What's in this Part?

This part contains the following chapters:

| Chapter | Chapter Name              | Page |
|---------|---------------------------|------|
| 4       | Main Power Connection     | 33   |
| 5       | Getting started           | 41   |
| 6       | Hardware extensions       | 45   |
| 7       | Configuration of the Bios | 55   |
| 8       | Maintenance               | 59   |

---





---

# Main Power Connection



# 4

---

## At a Glance

### Subject of this chapter

This chapter concerns the connection of the products to the main power.

### What's in this Chapter?

This chapter contains the following topics:

| Topic                       | Page |
|-----------------------------|------|
| Connecting the Power Wires  | 34   |
| Grounding Cautions          | 38   |
| Connecting I/O Signal Lines | 39   |

## Connecting the Power Wires

---

### Precautions

|   |  |
|---|--|
|  | <b>WARNING</b>   |
|   | <p>To avoid the dangers of fire, electric hazards and equipment damage, be sure to use only the specified voltage when operating the Smart iPC.</p> <p>Since the unit has no power ON/OFF switch, be sure to attach a breaker-type switch to its power cord.</p> <p><b>Failure to follow this precaution can result in death, serious injury, or equipment damage.</b></p> |

#### **Important :**

- When the FG terminal is connected, be sure the wire is grounded. Not grounding the Magelis Smart iPC unit will result in excess noise.

#### **Note :**

- Whenever possible, use thick wire (max. 2mm<sup>2</sup>) length limited to 30 metres (60 meters round trip) or length limited to 20 meters (40 meters round trip with 1,5mm section copper wires), for Magelis Smart iPC power wires. Also, to reduce noise be sure to twist the wire ends.
-

## Terminal Block Description

The figure below presents how to wire the Terminal Block

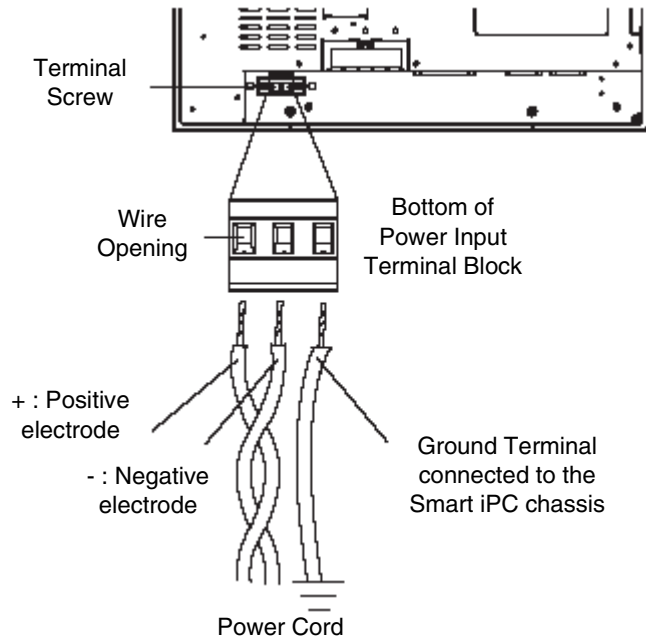

### Note :

- The torque required to tighten these screw is 0.5 to 0.6N•m.
- Do not solder the wire itself.
- If the central wire's end strands are not twisted correctly, the end strands may either short against each other, or against an electrode.
- **Protection fuse** : The 24 VDC mains supply modules for the Smart iPC are fitted with a protection fuse as standard. This fuse, fitted in series with the 24 V DC input, is located inside the module but cannot be accessed.

## How to Wire the Terminal Block

When connecting the wires, be sure to follow the procedures given below.

| Step | Action   |
|------|--|
| 1    | Confirm that the power cable is disconnected from the power supply.                    |
| 2    | Loosen the screws from the middle three (3) terminals.                                 |
| 3    | Remove the wire's external covering and insert the wire center stand into the opening. |
| 4    | Re-attach the screws.  |

**Possible connections**

**Connection of a Smart iPC supplied by a non-grounded safety DC network :**

The 0V and mechanical ground are connected internally.

Specific connection measures are to be taken for specific applications that use a floating network installation. These depending on the chosen mode of installation.

For this, the 24V DC input of the Smart iPC supply is isolated from the outputs and mechanical ground :

- Primary/Secondary dielectric strength: 1000V AC
- Primary/Ground dielectric strength: 1000V AC

**Connection of a 24V DC Smart iPC using a floating direct current network :**

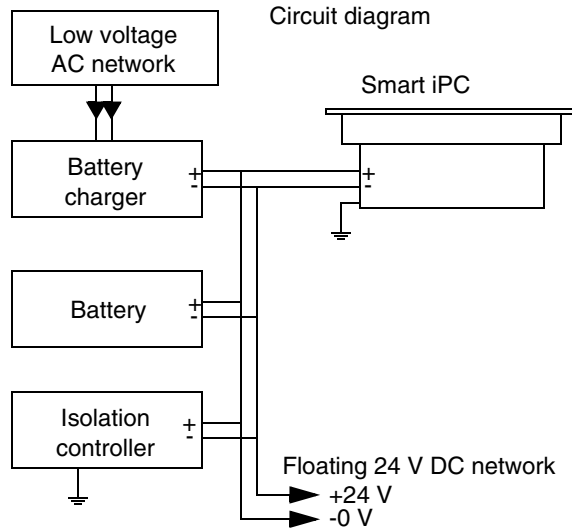

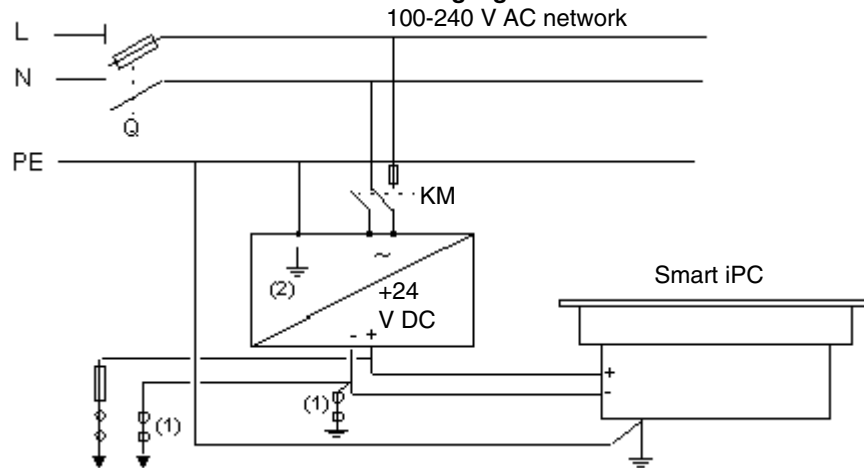
**Connection of a 24V DC Smart iPC using a ground referenced network :**

Q : General isolator

KM : Line contactor or circuit breaker

(1) : Isolation strip for detecting grounding faults

(2) : Possibility of using a TSX SUP 1101 process supply (see Schneider automation product catalog).

## Grounding Cautions

---

### Overview

**Note :** Use a grounding resistance of 100Ω or less, and a 2 mm<sup>2</sup> or thicker wire, or your country's applicable standard. For details, contact your local distributor.

---

### Dedicated Ground

- Set up a dedicated ground when using the rear panel's FG terminal.

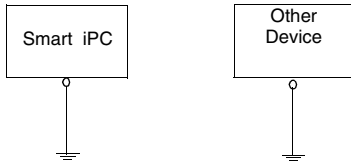

### Shared Ground allowed

- If a dedicated ground is not possible, use a shared ground, as shown in figure.
- Inside the Smart iPC unit, the SG (Signal Ground) and FG (Frame Ground) terminals are connected to each other.

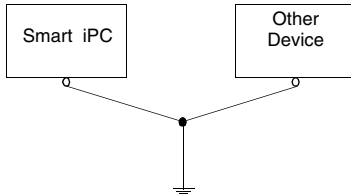

### Shared Ground not allowed

- When connecting an external device to Smart iPC with the SG terminal, ensure that no short-circuit loop is created when you set up the system.
- The grounding point must be as close to the Smart iPC as possible, and the grounding wires must be as short as possible. If the wires must be long, use thick, insulated wires and run them through conduits.

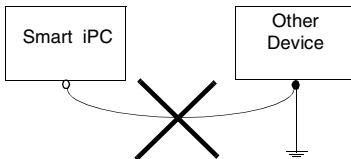

## Connecting I/O Signal Lines

---

### Precautions

- I/O signal lines must be wired separately from the power circuit cable. If the power circuit cable needs to be wired together with the input/output (I/O) signal lines for any reason, use shielded cables and ground one end of the shield to the Smart iPC's FG terminal.
-





---

## Getting started



# 5

---

### First power-up

#### Warning

**Note:** Before the first power-up, please read the "LIMITED USE LICENSE AGREEMENT" carefully, then remove the seal.

#### Preparation

On first power-up, it is necessary, depending on the software configuration of your MPC••, to perform the following operations:

- You need to enter the licence number of the operating system. For this action, you need to connect a PS/2 or USB keyboard to the unit.
  - You need to customize and parameter your system or see Installation Guide for Magelis iPC industrial PC.
-

## Some useful tools

You can notice in the taskbar some useful shortcuts.

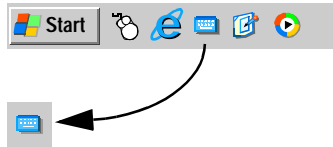

- This is the virtual keyboard. Just click on it, and a graphical keyboard appears. It is useful when you don't want or can't connect a keyboard to the unit.



- This is the virtual mouse button selector. It allows the user to associate the next "click" to a "right click". For instance, this tool permits the use of contextual menus.



Backlight  
Brightness

- Configuration Panel / Brightness : This link allows the user to change the brightness of the screen (useful for dark areas).
-

---

**EFW manager  
(Enhanced Write  
Filter)****Description :**

The Magelis iPC operating system, Windows Xpe, is installed on a memory cartridge. This cartridge is a rewritable "Compactflash" card and this media offers a relatively restricted number of writing.

To resolve this limitation, the operating system must store its temporary data in dynamic memory (RAM).

All those operations are managed by EWF. The EWF manager can be temporarily inhibited.

The data which are concerned by this behaviour are all configuration files like : registry, softwares and users manager.

When EWF is enabled, all operating system modifications will be lost after Magelis iPC restarting :

- New applications installation
- New peripheral installation
- New users creation
- Network configuration : IP address, operating mode...
- OS custom : background picture, screen saver...

**Validation / Inhibition of EWF manager :**

In Magelis iPC, an utility program allows to enable or disable EWF manager. This tool is located in the follow directory : C:\Program files\Change EWF State\ChangeEWFstate.exe



Any changes will be taken account after restarting of the terminal.

**ENABLED** : EWF activated. Normal behaviour.

**DISABLED** : EWF inhibited. The operator can, after restarting, do different actions and changes settings that he doesn't want to lose :

- New applications installation
- New peripheral installation
- New users creation
- Network configuration : IP address, operating mode...
- OS custom : background picture, screen saver...

**Warning :**

**After any context modifications, EWF manager must be reenabled.**

---

**CD restore**

See Installation Guide for Magelis iPC industrial PC.

---



---

## Hardware extensions

# 6

---

### At a Glance

#### Subject of this chapter

This chapter concerns the hardware extensions for the Smart iPC. A wide variety of optional units, Main Memory, CF cards, PCMCIA (PC cards) manufactured by Schneider Electric and commercial PCMCIA (PC Cards) can be used with the Smart iPC. Unscrew the five (5) cover attachment screws, and remove the cover.

#### What's in this Chapter?

This chapter contains the following topics:

| Topic                               | Page |
|-------------------------------------|------|
| Before installation                 | 46   |
| Removing the Smart iPC Unit's Cover | 47   |
| Smart iPC internal view             | 48   |
| Main Memory Installation            | 49   |
| PCMCIA Unit Installation            | 50   |
| CF Card Installation and Removal    | 52   |

---

## Before installation

---

### Overview

Install the desired products as shown in the "Smart iPC Internal View" drawing. For the detailed optional unit installation procedures, refer to that unit's "Installation Guide".

|   |  |
|---|--|
|  | <b>WARNING</b>   |
|   | <p><b>Be sure to disconnect the main power from the power supply and confirm that power is not supplied to the Smart iPC unit before installing any optional units, Main Memory, CF cards. Failure to do so can result in an electric shock.</b></p> <p><b>Important</b></p> <ul style="list-style-type: none"><li>● Use a screwdriver to loosen and tighten the screws. Be sure not to tighten the screws too tightly. Excessive force can damage the equipment.</li><li>● When removing or replacing screws, be careful that they do not fall inside the unit's chassis.</li></ul> <p><b>Failure to follow this precaution can result in death, serious injury, or equipment damage.</b></p> |

---

# Removing the Smart iPC Unit's Cover

## Description

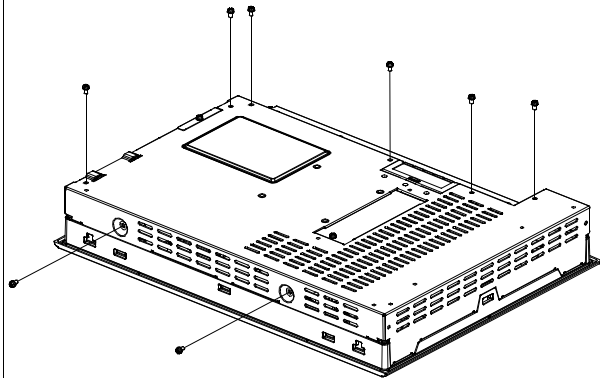
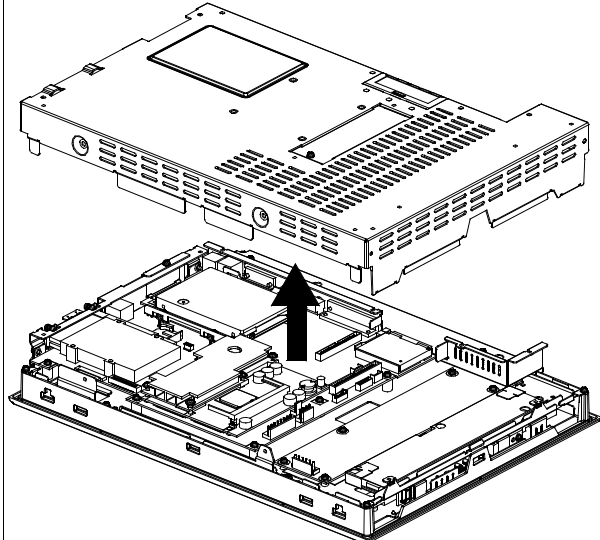
| Step | Action  |
|------|---|
| 1    | <p>Lay the Smart iPC unit on its front face and remove the eight (8) cover attachment screws.</p>  <p>The diagram shows the Smart iPC unit from a top-down perspective. Eight screws are shown being removed from the top cover. The screws are located at the corners and along the edges of the cover. The unit is shown lying on its front face.</p>   |
| 2    | <p>Slide the rear cover up to remove it in the direction shown. (When reattaching the screws, use a torque of 0.5 to 0.6N•m.)</p>  <p>The diagram shows the Smart iPC unit with the rear cover removed. The rear cover is shown above the unit, and a black arrow points upwards from the unit, indicating the direction in which the rear cover was removed. The unit is shown lying on its front face.</p> |

## Smart iPC internal view

---

### Illustration

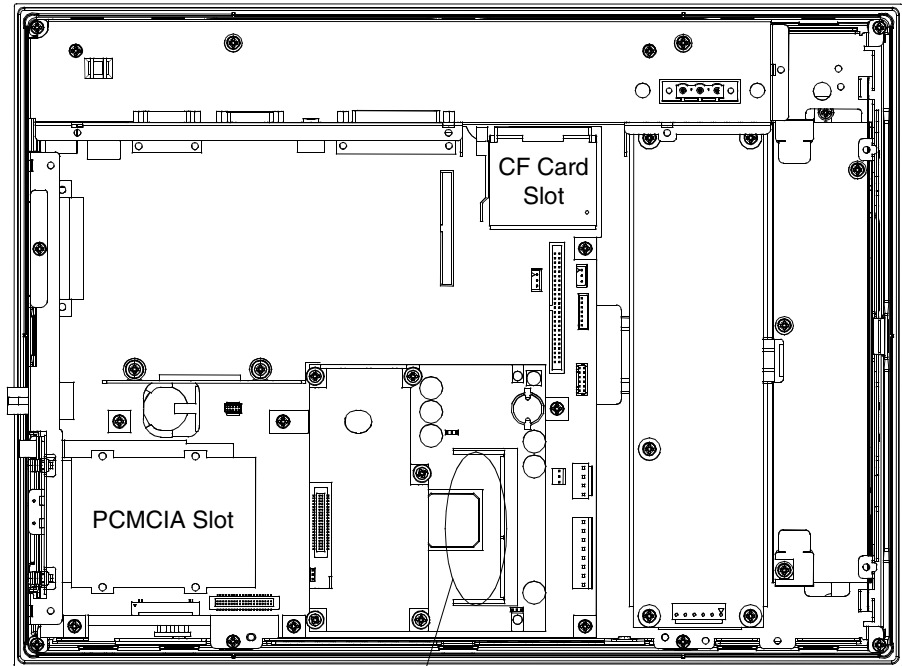

Main Memory Installation Area

---



---

## Main Memory Installation

---

### Illustration

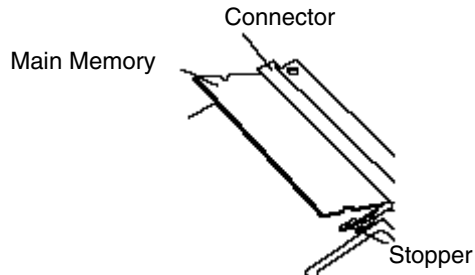

### How to Install the Main Memory

The table below presents the operating mode to install the Main Memory module

| Step | Action  |
|------|---|
| 1    | Remove the Smart iPC unit's rear cover  |
| 2    | Angle the main memory module down slightly, and push it in until the connector pins mate with the module's pins. Then, lower the module until it is horizontal and insert it completely into the connector. This connector is shown in Smart iPC Internal View. |
| 3    | Push in the main memory module until the stopper snaps into place.  |

---

## PCMCIA Unit Installation

### How to install the PCMCIA Unit

The table below presents the operating mode to install the PCMCIA Unit.

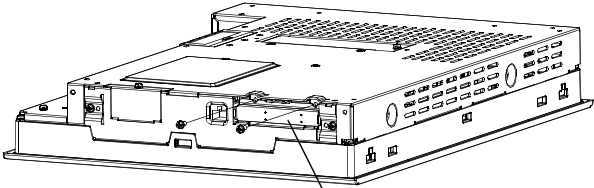
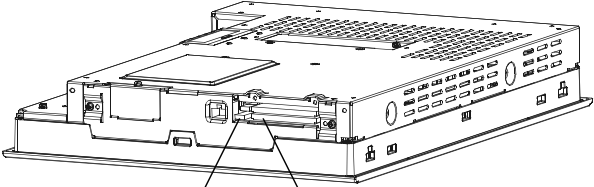
| Step | Action   |
|------|--|
| 1    | Remove the Smart iPC unit's rear cover see Removing the Smart iPC Unit's Cover   |
| 2    | Remove the PCMCIA slot cover's screws. <div style="text-align: center;">  <p data-bbox="902 688 1116 711">PCMCIA Slot Cover</p> </div>   |
| 3    | <p data-bbox="499 738 875 761"><b>Inserting a commercial-type PC Card</b></p> <p data-bbox="499 768 1108 790">Insert the commercial-type PC Card into the PCMCIA connector.</p> <p data-bbox="499 797 559 820"><b>Note :</b></p> <ul data-bbox="499 826 1240 878" style="list-style-type: none"> <li data-bbox="499 826 1240 878">• The PCMCIA slot has 2 connectors. When inserting the PCMCIA Card, check carefully that it is connected to the correct connector..</li> </ul> <div style="text-align: center;">  <p data-bbox="636 1143 765 1166">Eject Button</p> <p data-bbox="867 1143 1105 1166">PC Card (commercial)</p> </div> <p data-bbox="499 1192 732 1214"><b>Removing the PC Card</b></p> <p data-bbox="499 1221 1157 1273">Press the eject button twice to remove the PC Card from the PCMCIA connector.</p> <p data-bbox="499 1279 1039 1302">Pressing the eject button once causes its tip to come out.</p> <p data-bbox="499 1308 1240 1331">Pressing the eject button the second ejects the PC Card from the PCMCIA slot.</p> |

---

| Step | Action   |
|------|--|
| 4    | <p data-bbox="474 199 1219 253">Replace the PCMCIA slot cover removed in (1) and secure it in place using the two PCMCIA slot screws. The necessary torque is 0.5N•m to 0.6N•m.</p> <p data-bbox="474 256 536 280"><b>Note :</b></p> <ul data-bbox="474 284 1219 506" style="list-style-type: none"><li data-bbox="474 284 1219 370">• When using a PC Card with a cable attached, Schneider recommends you use a clamp or other type of device to prevent vibration from possibly dislodging the cable.</li><li data-bbox="474 373 1219 506">• Be sure to stop the Smart iPC unit PC Card's driver prior to removing the PC Card. A failure to stop this driver may result in damage to either the PC Card, the PC Card's data, or may cause Windows. to hang up. For information on the procedure for stopping the PC Card's driver, please refer to your OS' User Manual.</li></ul> |

---

## CF Card Installation and Removal

---

### When using the Smart iPC Unit and a CF Card

|   |   |
|---|---|
|  | <b>CAUTION</b>  |
|   | <p><b>Follow the precautions below</b></p> <p>Be sure to use only CF Cards manufactured by Schneider. Smart iPC unit performance cannot be guaranteed when using another manufacturer's CF Card.</p> <p>Be sure to follow the instructions given below to prevent the CF Card's internal data from being destroyed or a CF Card malfunction from occurring:</p> <ul style="list-style-type: none"><li>• DO NOT bend the CF Card.</li><li>• DO NOT drop or strike the CF Card against another object.</li><li>• Keep the CF Card dry.</li><li>• DO NOT touch the CF Card connectors.</li><li>• DO NOT disassemble or modify the CF Card.</li></ul> <p><b>Failure to follow this precaution can result in injury or equipment damage.</b></p> |

---

**When using the  
CF Card Unit and  
the CF Card**

|   |  |
|---|--|
|  | <b>CAUTION</b>   |
|   | <p><b>Follow the precautions below</b></p> <p>Prior to inserting the CF Card, be sure to confirm that the rear and the front of the CF Card are correctly oriented, and that the CF Card connector position is correct. If the CF Card is inserted incorrectly, the CF Card, its internal data, and the CF card unit may be damaged.</p> <p>Since the Smart iPC unit's OS views the CF Card as a hard disk, do not remove or insert the CF Card when the unit's power is switched ON. Doing so may damage data and stop OS operation. Be sure to shut down the OS and switch power OFF prior to removing or inserting a CF Card.</p> <p>Never turn OFF or reset the Smart iPC while accessing the CF Card to prevent damaging file data. Also, be sure to shut down the Smart iPC unit's OS before turning OFF the main power.</p> <p><b>Failure to follow this precaution can result in injury or equipment damage.</b></p> |

---

**Limitation of the  
number of  
writings of data**

The CF Card has a limitation of the number of writings of data of approximately 100,000 times. Therefore, be sure to back up all CF Card data regularly to another storage media.

---

**CF Card  
Insertion and  
Removal**

Familiarize yourself with the differences between the top and bottom surfaces of the CF Card. Also, be sure that the Card is properly oriented when it is inserted (i.e. whether the top of the card is up or down etc.).

---

**How to Insert the CF Card**

The table below presents the operating mode to insert the CF Card.

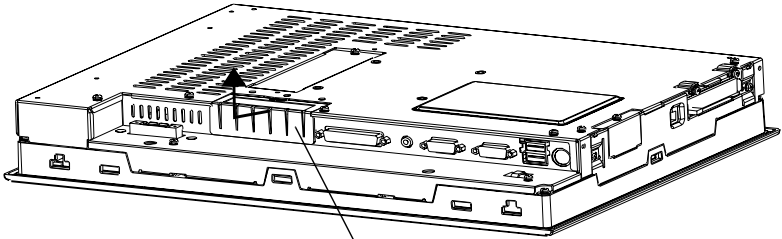
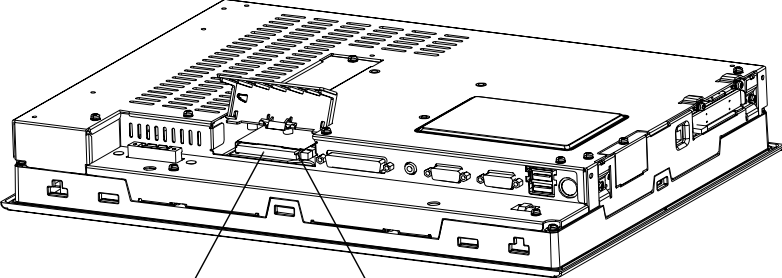
| Step  | Action   |
|---|--|
| 1   | Slide the CF Card cover in the direction shown and open the CF Card cover.                 |
|  <p>CF Card Cover</p>             |  |
| 2   | Insert the CF Card firmly into the CF card slot, and check that the eject button pops out. |
|  <p>CF Card      Eject Button</p> |  |

**How to Remove the CF Card**

The table below presents the operating mode to remove the CF Card.

| Step | Action   |
|------|--|
| 1    | Press the eject button in fully to remove the CF Card from the CF Card slot. |
| 2    | After inserting/removing the CF card, be sure to replace the CF Card cover.  |

---

# Configuration of the Bios



---

## At a Glance

### Subject of this chapter

This chapter describes how to access certain parameters of the Bios (operating system of the computer) that need to be modified depending on its existing configuration.

### What's in this Chapter?

This chapter contains the following topics:

| Topic                            | Page |
|----------------------------------|------|
| Accessing the Bios configuration | 56   |
| Configuration Screens            | 57   |

## Accessing the Bios configuration

### Precautions

#### Important :

- Normally, use only the factory (default) settings.

#### Note :

- The following settings are those pre-set at the factory.

### How to access the Bios Configuration

The table below presents the operating mode to access the Bios Configuration.

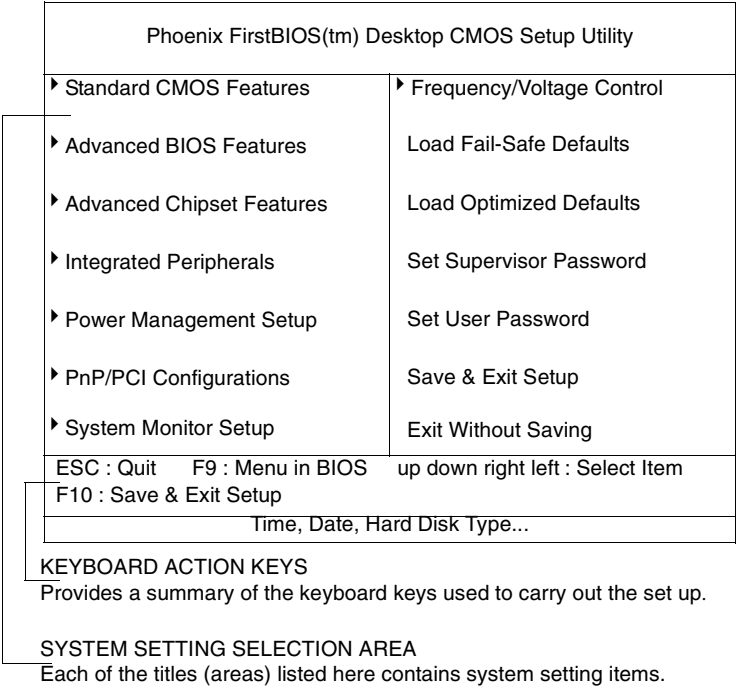
| Step                        | Action   |                          |                             |                          |                         |                             |                         |                          |                         |                          |                   |                          |                   |                        |                     |
|-----------------------------|--|--------------------------|-----------------------------|--------------------------|-------------------------|-----------------------------|-------------------------|--------------------------|-------------------------|--------------------------|-------------------|--------------------------|-------------------|------------------------|---------------------|
| 1                           | Connect a keyboard to the Smart iPC Unit.  |                          |                             |                          |                         |                             |                         |                          |                         |                          |                   |                          |                   |                        |                     |
| 2                           | Turn the main power ON.  |                          |                             |                          |                         |                             |                         |                          |                         |                          |                   |                          |                   |                        |                     |
| 3                           | <p>After the message "Press &lt;DEL&gt; to Enter SETUP" appears, press the [DEL] key until the following screen appears.</p>  <p>Phoenix FirstBIOS(tm) Desktop CMOS Setup Utility</p> <table border="1"> <tr> <td>▸ Standard CMOS Features</td> <td>▸ Frequency/Voltage Control</td> </tr> <tr> <td>▸ Advanced BIOS Features</td> <td>Load Fail-Safe Defaults</td> </tr> <tr> <td>▸ Advanced Chipset Features</td> <td>Load Optimized Defaults</td> </tr> <tr> <td>▸ Integrated Peripherals</td> <td>Set Supervisor Password</td> </tr> <tr> <td>▸ Power Management Setup</td> <td>Set User Password</td> </tr> <tr> <td>▸ PnP/PCI Configurations</td> <td>Save &amp; Exit Setup</td> </tr> <tr> <td>▸ System Monitor Setup</td> <td>Exit Without Saving</td> </tr> </table> <p>ESC : Quit    F9 : Menu in BIOS    up down right left : Select Item<br/>F10 : Save &amp; Exit Setup</p> <p>Time, Date, Hard Disk Type...</p> <p><b>KEYBOARD ACTION KEYS</b><br/>Provides a summary of the keyboard keys used to carry out the set up.</p> <p><b>SYSTEM SETTING SELECTION AREA</b><br/>Each of the titles (areas) listed here contains system setting items.</p> | ▸ Standard CMOS Features | ▸ Frequency/Voltage Control | ▸ Advanced BIOS Features | Load Fail-Safe Defaults | ▸ Advanced Chipset Features | Load Optimized Defaults | ▸ Integrated Peripherals | Set Supervisor Password | ▸ Power Management Setup | Set User Password | ▸ PnP/PCI Configurations | Save & Exit Setup | ▸ System Monitor Setup | Exit Without Saving |
| ▸ Standard CMOS Features    | ▸ Frequency/Voltage Control  |                          |                             |                          |                         |                             |                         |                          |                         |                          |                   |                          |                   |                        |                     |
| ▸ Advanced BIOS Features    | Load Fail-Safe Defaults  |                          |                             |                          |                         |                             |                         |                          |                         |                          |                   |                          |                   |                        |                     |
| ▸ Advanced Chipset Features | Load Optimized Defaults  |                          |                             |                          |                         |                             |                         |                          |                         |                          |                   |                          |                   |                        |                     |
| ▸ Integrated Peripherals    | Set Supervisor Password  |                          |                             |                          |                         |                             |                         |                          |                         |                          |                   |                          |                   |                        |                     |
| ▸ Power Management Setup    | Set User Password  |                          |                             |                          |                         |                             |                         |                          |                         |                          |                   |                          |                   |                        |                     |
| ▸ PnP/PCI Configurations    | Save & Exit Setup  |                          |                             |                          |                         |                             |                         |                          |                         |                          |                   |                          |                   |                        |                     |
| ▸ System Monitor Setup      | Exit Without Saving  |                          |                             |                          |                         |                             |                         |                          |                         |                          |                   |                          |                   |                        |                     |
| 4                           | Use the arrow keys to move the cursor to the desired selection.  |                          |                             |                          |                         |                             |                         |                          |                         |                          |                   |                          |                   |                        |                     |



## Configuration Screens

### Precaution

#### Important :

- Normally, use only the factory (default) settings.

### Standard CMOS Features

Selecting the STANDARD CMOS FEATURES menu item produces the following screen.

| Phoenix FirstBIOS(tm) Desktop CMOS Setup Utility<br>Standard CMOS Features  |                                      |  |
|---|--------------------------------------|--|
| Date (mm:dd:yy):<br>Time (hh:mm:ss):  | Wed, Jun 25 2003<br>14 : 50 : 3      | Item Help  |
| ▶ IDE Primary Master<br>▶ IDE Primary Slave<br>▶ IDE Secondary Master<br>▶ IDE Secondary Slave  | [None]<br>[None]<br>[None]<br>[None] | Menu Level ▶<br>Change the day, month, year<br>and century |
| Drive A   | [1.44M, 3.5 in.]                     |  |
| Video   | [EGA/VGA]                            |  |
| Halt On   | [All, But Keyboard]                  |  |
| Base Memory   | 640K                                 |  |
| Extended Memory   | 11366K                               |  |
| Total Memory  | 114688K                              |  |
| up/down/right/left:Move Enter:Select +/-/PU/PD:Value F10:Save ESC:Exit F1: General Help<br>F5:Previous Values F6:Fail-Safe Defaults F7:Optimized Defaults |                                      |  |

### How to Modify the Date

#### Date (mm:dd:yy)

The Smart iPC unit's internal calendar and clock allow you to set the date. The day of the week is automatically set.

Month: Jan/Feb/Mar/Apr/May/June/Jul/Aug/Sep/Oct/Nov/Dec

Day:1 to 31

Year: 1999 to 2099

**How to Modify the Time**

**Time (hh:mm:ss)**

The Smart iPC unit's internal clock can be set. The hh/mm/ss (0:0:0) format is factory set prior to shipping.

Hours: 0 to 23

Minutes: 0 to 59

Seconds: 0 to 59

---

**How to Set Supervisor Password**

This password is used to change system information settings. It is designed to prevent unapproved users from changing the system information settings. Entering up to 8 characters here will overwrite the current password.

When you wish to have no password, click on the [Enter] key. Next, the words "PASSWORD DISABLE" will appear, providing confirmation that the Password is no longer set.

When password input is required, use the [Advanced BIOS Features] area's [Security Option] feature to enter the password.

**See :** Advanced BIOS Features

---

**How to Set User Password**

This password is used to view system information settings. It is designed to prevent unapproved users from viewing the system information settings. Entering up to 8 characters here will overwrite the current password.

When you wish to have no password, click on the [Enter] key. Next, the words "PASSWORD DISABLE" will appear, providing confirmation that the Password is no longer set.

When password input is required, use the [Advanced BIOS Features] area's [Security Option] feature to enter the password.

**See :** Advanced BIOS Features

**Important :**

- When using either [Set Supervisor Password] or [Set User Password], you can easily view and change system settings.
  - When using BOTH the [Set Supervisor Password] and [Set User Password] features, [Set User Password] will allow you to only view system data, not change it.
- 

**How to Save and Exit Setup**

This feature saves the settings entered in the Setup Utility and restarts the Smart iPC unit.

---

**How to Exit Without Saving**

This feature quits the Setup Utility program without saving any settings entered.

---

---

# Maintenance

# 8

---

## Regular Cleaning

### Precaution

|   |  |
|---|--|
|  | <b>CAUTION</b>   |
|   | <p><b>Do not clean the unit with thinner, organic solvents, or strong acids.</b></p> <p><b>Failure to follow this precaution can result in injury or equipment damage.</b></p> |

### How to Clean the Display

| Action   | Figure   |
|--|--|
| When the display surface or frame become dirty, use a soft cloth moistened with neutral detergent to wipe away any dust or stains. |  <p>Neutral detergent</p> <p>Display</p> |

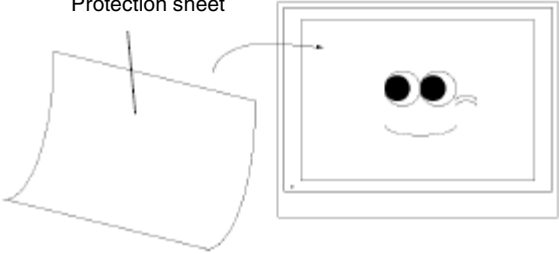
| Action   | Figure   |
|--|--|
| <p>Do not use sharp or hard objects, such as a mechanical pencil or screwdriver, to push on the display. This could damage the unit.</p> |  |
| <p>Use the screen protection sheet when using the Smart iPC in extremely dirty or dusty areas.</p>                                       |  |

**How to Install Gasket Replacement**

The moisture resistant gasket protects the Smart iPC. See Installation Procedures and improves its water resistance for instructions on installing the Smart iPC’s gasket.

**Important :**

- A gasket which has been used for a long period of time may have scratches or dirt on it, and could have lost much of its water resistance. Be sure to change the gasket periodically (or when scratches or dirt become visible).

**How to Clean the Fan Fiter**

Since excessive dirt and dust in the filter of the Compact iPC’s electric fan can potentially affect the performance of the unit, regular inspection and cleaning of the filter is strongly recommended.

## Illustration

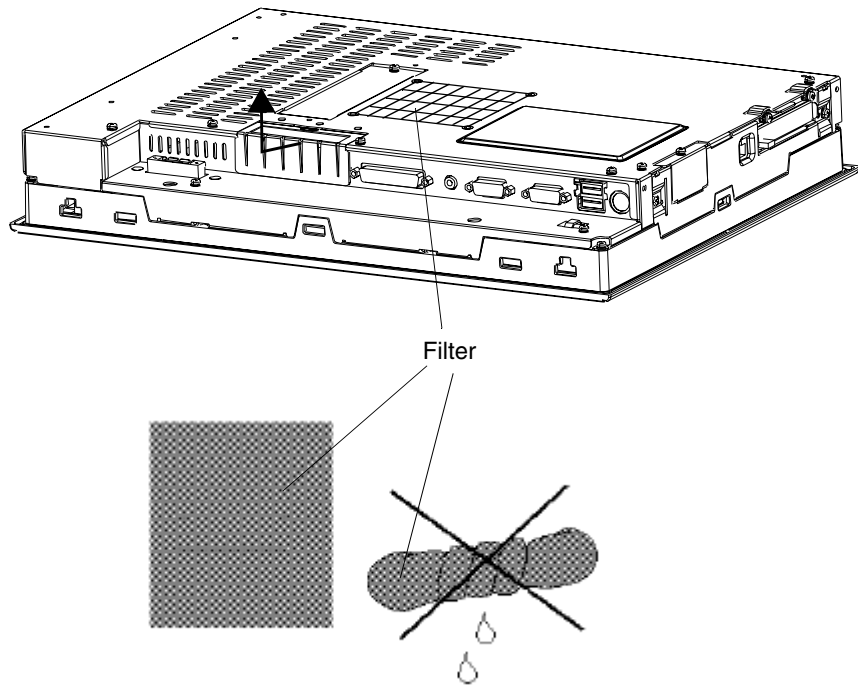

The table below presents the operating mode to clean the Fan Filter.

| Step | Action  |
|------|---|
| 1    | Remove the fan cover after having unscrewed the 4 screws.   |
| 2    | Remove the filter.  |
| 3    | <p>Clean the filter completely. If stubborn dirt or stains are present, wash the filter with a neutral detergent.</p> <p><b>Important :</b></p> <ul style="list-style-type: none"> <li>• Do not wring the filter to dry it.</li> <li>• When drying the filter, dry it without exposing it to direct sunlight.</li> <li>• Allow it to air dry completely before reattaching to the Compact iPC.</li> </ul> |
| 4    | After having posed the filter on the grid, reattach the cover with its cover attachment screws.   |



---

# Installation

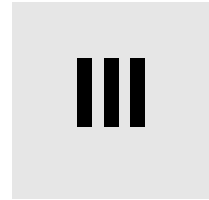

---

## At a Glance

### Subject of this part

This part concerns product installation.

### What's in this Part?

This part contains the following chapters:

| Chapter | Chapter Name        | Page |
|---------|---------------------|------|
| 9       | Dimension/Assembly  | 65   |
| 10      | Connections to PLCs | 75   |





---

## Dimension/Assembly

# 9

---

### At a Glance

#### Subject of this chapter

This chapter concerns the dimensions and the panel mouting of products.

#### What's in this Chapter?

This chapter contains the following topics:

| Topic                             | Page |
|-----------------------------------|------|
| Dimensions                        | 66   |
| Cropping for Cabinet Installation | 68   |
| Panel Mounting                    | 69   |
| Installing the Smart iPC          | 70   |

## Dimensions

---

### Dimensions of the Smart iPC Unit

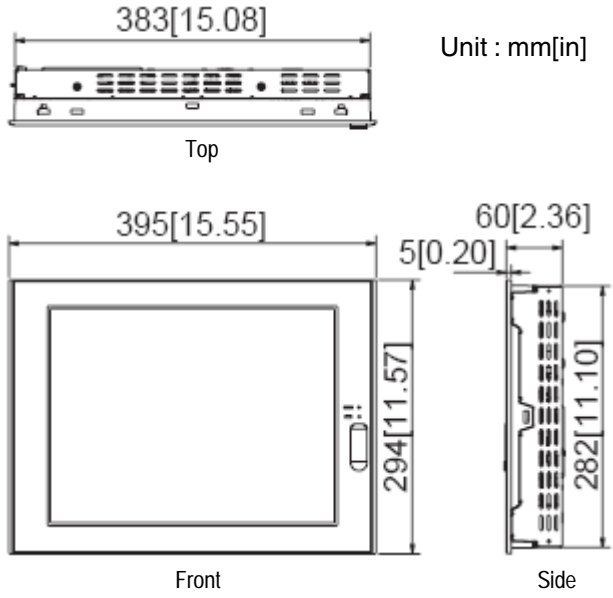

**Other  
Dimensions  
(with Installation  
Fasteners  
installed)**

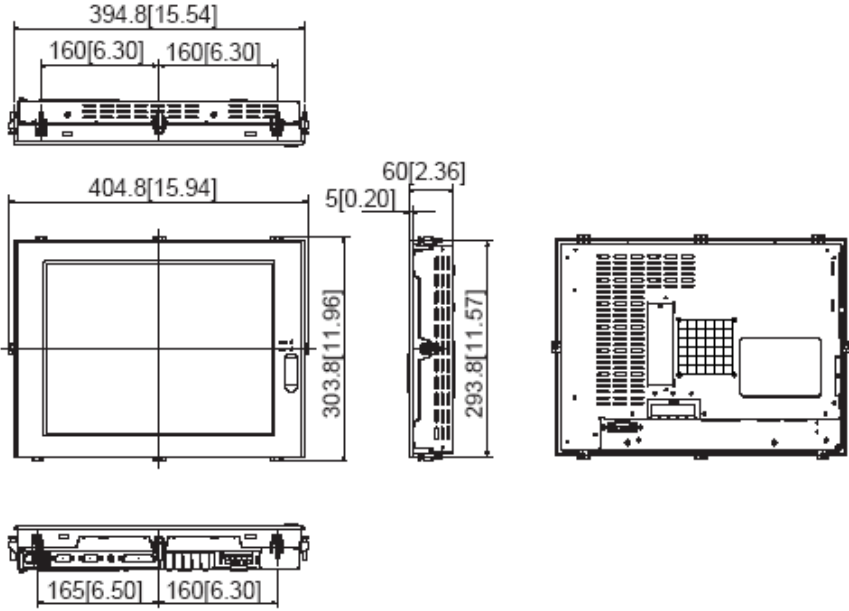

## Cropping for Cabinet Installation

---

### Overview

For cabinet installation, it is necessary for products to be cropped.

---

### Dimensions

The dimensions of the crop are given below.

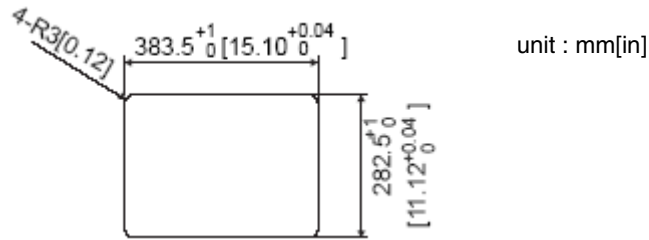

### Precautions

#### Important :

- Be sure the thickness of the installation panel is from 1.6 mm [0.06 in] to 10 mm [0.39 in] .
  - All panel surfaces used should be strengthened. Especially, if high levels of vibration are expected and the products installation surface (i.e. an operation panel's door, etc.) can move (i.e.open or close) due consideration should be given to the products weight.
  - To insure that the products water resistance is maintained, be sure to install it into a panel that is flat and free of scratches or dents.
  - Be sure all installation tolerances are maintained to prevent the unit from falling out of its installation panel.
-

## Panel Mounting

### Overview

The products are designed to be attached to the door of a cabinet with the attachments described below

### Dimensions

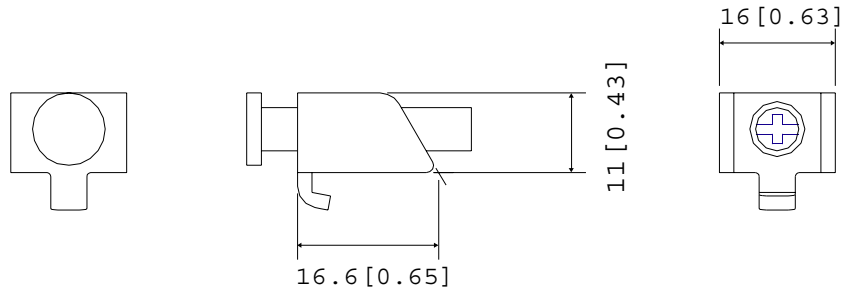

unit : mm[in]

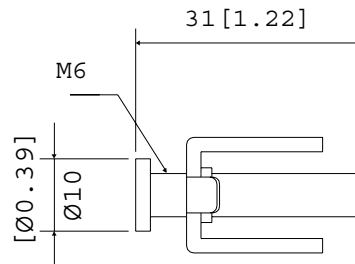

## Installing the Smart iPC

---

### Installation Location

- Avoid placing the Smart iPC next to other devices that might cause overheating.
  - Keep the Smart iPC away from arc-generating devices such as magnetic switches and non-fuse breakers.
  - Avoid using the Smart iPC in environments where corrosive gases are present.
  - To ensure the reliability, operability and ventilation of the Smart iPC, be sure to install it in locations that are more than 50mm away from adjacent structures or equipment. Also, consider the need for installing or removing PCMCIA modules, or connectors when designing and installing your product.
- 

### Illustration

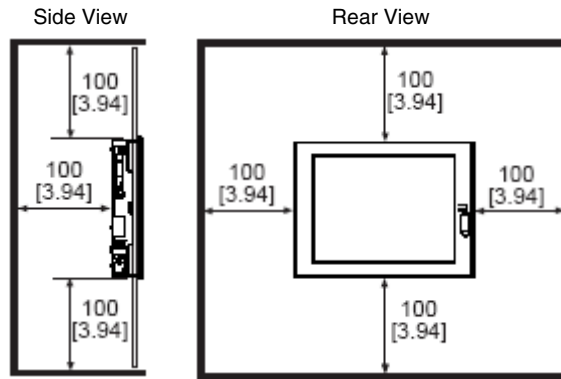

### Vibration and Shocks

If the Smart iPC is moved when its enclosure doors are open, or while it is installed in a rack equipped with caster wheels, the unit can receive excessive vibration or jolting. Be especially careful at this time.

---

## How to Install the Smart iPC Unit

Follow the steps given below when installing the Smart iPC.

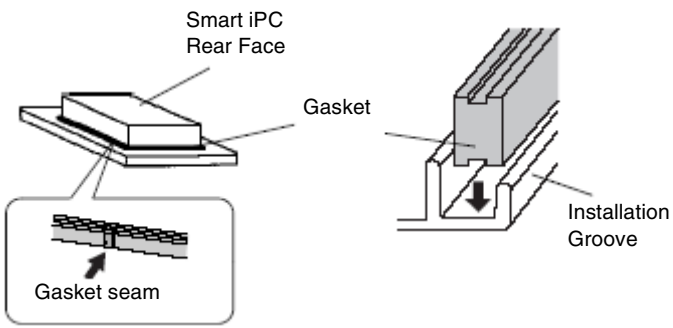
| Step | Action   |
|------|--|
| 1    | <p><b>Attaching the Installation Gasket</b></p> <p>Even if the your Smart iPC's Installation Gasket is not needed to prevent water from entering the unit, the gasket also acts as a vibration absorber and should always be attached. To install it, place the unit face down on a soft surface and attach the gasket to the rear side of the display face, in the plastic bezel's groove (see picture below).</p> <p><b>Important :</b></p> <ul style="list-style-type: none"> <li>• Before mounting the Smart iPC into a cabinet or panel, check that the installation gasket is attached to the unit.</li> <li>• A gasket which has been used for a long period of time may be scratched or dirty, and may have lost much of its water resistance. Be sure to change the gasket at least once a year, or when scratches or dirt become visible.</li> <li>• The corresponding gasket is provided into the maintenance kit ref: MPC YK 50 MNT KIT.</li> <li>• Since the gasket is flexible but not elastic, be careful not to stretch it unnecessarily, as doing so could tear the gasket.</li> <li>• Be sure, when pushing the gasket into the installation groove and around the corners of the unit, that the gasket's seam is not placed in a corner. Placing the seam here could eventually cause the gasket to tear.</li> <li>• Be sure to place the gasket's flat, non-grooved side facing down.</li> </ul> <div style="text-align: center;">  <p>The diagram consists of two parts. On the left, a perspective view shows a rectangular Smart iPC unit with a gasket attached to its rear face. Labels point to 'Smart iPC Rear Face' and 'Gasket'. A circular inset below shows a close-up of the 'Gasket seam' on the gasket's surface. On the right, a cross-sectional view shows the 'Gasket' being pushed into the 'Installation Groove' of the bezel. An arrow indicates the direction of insertion.</p> </div> <p><b>Note :</b></p> <ul style="list-style-type: none"> <li>• The Smart iPC's bezel has a part attached to it. To prevent the installation gasket from contacting this part, be sure to press the installation gasket completely into its groove.</li> </ul> <p><b>Important :</b></p> <ul style="list-style-type: none"> <li>• If the installation gasket is not properly inserted into the groove, the gasket's moisture resistance may not be equivalent to IP 65.</li> <li>• When the installation gasket is properly inserted, approximately 2.0 mm of it will extend outside the groove. Before installing a Smart iPC into a panel, be sure to confirm that the gasket is correctly in place.</li> </ul> |

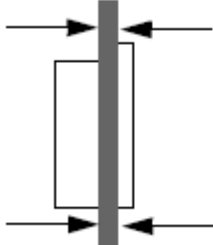
| Step | Action  |
|------|---|
| 2    | <p data-bbox="445 203 637 224"><b>Create a Panel Cut</b></p> <p data-bbox="445 230 1238 310">Create a panel cut for the Smart iPC, like that pictured here. Two additional items, the installation gasket and the installation fasteners are required when installing the unit.</p> <p data-bbox="445 316 705 337">See Panel Cut Dimensions</p> <div data-bbox="454 391 670 578" style="border: 1px solid black; padding: 10px; text-align: center;"><p data-bbox="528 396 596 417"><b>Panel</b></p><p data-bbox="509 480 616 501"><b>Panel Cut</b></p></div> <p data-bbox="445 602 509 623"><b>Note :</b></p> <ul data-bbox="445 630 1238 711" style="list-style-type: none"><li data-bbox="445 630 1238 678">• To obtain the maximum degree of moisture resistance, be sure to install the Smart iPC on a smooth, flat surface.</li><li data-bbox="445 685 1130 711">• The panel itself can be from 1.6 mm [0.06 in] to 10.0 mm [0.39 in] thick</li></ul> <p data-bbox="445 717 559 738"><b>Important :</b></p> <ul data-bbox="445 745 1238 800" style="list-style-type: none"><li data-bbox="445 745 1238 800">• Strengthening may be required for the panel. Be sure to consider the weight of the Unit when designing the panel.</li></ul> <div data-bbox="463 841 1057 1084" style="text-align: center;"><p data-bbox="683 850 1057 872">1.6 mm [0.06 in] - 10.0mm [0.39 in]</p></div> |

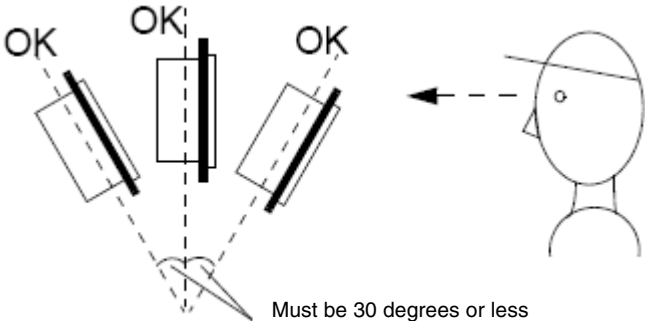
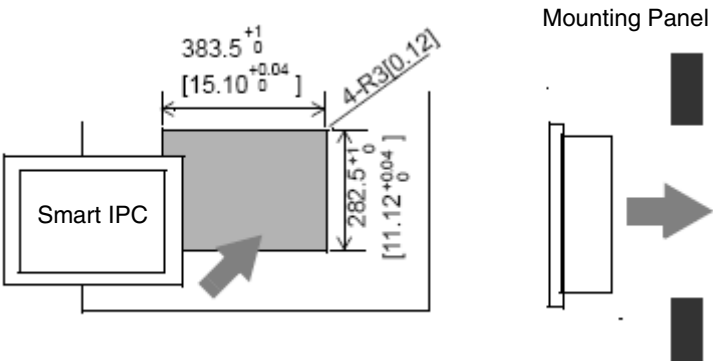

| Step | Action   |
|------|--|
| 3    | <p><b>Smart iPC Viewing Angle</b></p> <ul style="list-style-type: none"><li>• Be sure that the panel's viewing angle is tilted no more than 30 degrees from parallel to the operator (i.e. operator is directly in front).</li></ul>  <ul style="list-style-type: none"><li>• Avoid placing the Smart iPC next to other devices that might cause overheating.</li><li>• Avoid using the Smart iPC where the ambient temperature will be higher than the allowed specification.</li><li>• Keep the Smart iPC away from arc-generating devices such as magnetic switches and non-fuse breakers.</li><li>• Avoid using the Smart iPC in environments where corrosive gases are present.</li></ul> |
| 4    | <p><b>Insert the Smart iPC installation slot</b></p>  <p><b>Important :</b></p> <ul style="list-style-type: none"><li>• Be sure the panel cut's actual measurements are the same as those given here, otherwise the Smart iPC may slip or fall out of the panel.</li></ul>  |

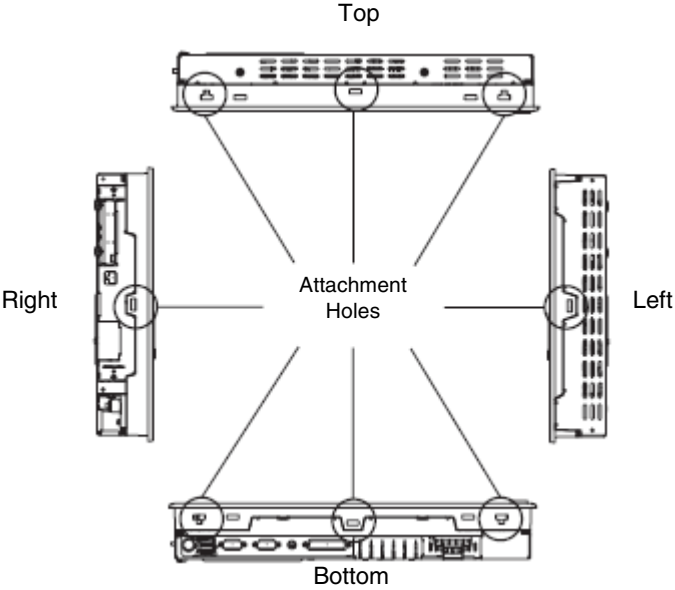
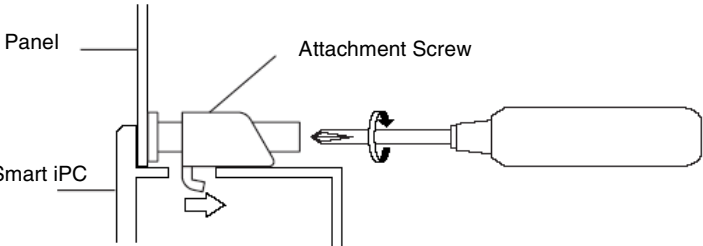
| Step | Action   |
|------|--|
| 5    | <p data-bbox="443 199 1241 280"><b>Attach and Secure the Rear Installation Attachments</b><br/>Locate the Smart iPC's attachment holes, located on the top, bottom, and sides of the Unit.</p> <div data-bbox="463 313 1138 898" style="text-align: center;"><p data-bbox="799 313 841 337">Top</p><p data-bbox="758 581 868 630">Attachment Holes</p><p data-bbox="772 873 854 898">Bottom</p><p data-bbox="463 597 525 621">Right</p><p data-bbox="1087 597 1142 621">Left</p></div> <div data-bbox="463 914 1166 1157" style="text-align: center;"><p data-bbox="463 946 525 971">Panel</p><p data-bbox="758 946 937 971">Attachment Screw</p><p data-bbox="463 1076 552 1101">Smart iPC</p></div> <p data-bbox="443 1174 1241 1429"><b>Important :</b></p> <ul data-bbox="443 1206 1241 1255" style="list-style-type: none"><li>• Excessive torque may damage the Smart iPC unit.</li><li>• To ensure a high degree of moisture resistance, the torque should be 0.5N•m.</li></ul> <p data-bbox="443 1263 1241 1287"><b>Note :</b></p> <ul data-bbox="443 1295 1241 1429" style="list-style-type: none"><li>• Depending on the installation panel's thickness, etc., the number of installation fasteners used may need to be increased to provide the desired level of moisture resistance.</li><li>• The corresponding installation attachments can be purchased as spare parts with the maintenance kit ref:MPC YK 50 MNT KIT.</li></ul> |

---

## Connections to PLCs

# 10

---

### Connection to PLCs

#### Nano, Micro, Premium

This connection requires the use of connection cable **TSX PCX 1031** supplied with PL7 Pro and PL7 Junior software.

This 2 meter-long cable is equipped with the following:

- A 9-contact SUB-D-type female connector for connection to the Smart iPC.
- A 5-contact microDin-type male connector for connection to the PLC.

---

#### Series 7

This concerns TSX 27 PLCs, and TSX/PMX 47/67/87/107 PLCs.

This connection requires the use of connection cable **FT20CBCL30** supplied with XTEL Pack software.

This 2.5 meter-long cable is equipped with the following:

- A 9-contact SUB-D- type female connector for connection to the Smart iPC.
- A 9-contact SUB-D-type male connector for connection to the PLC.

---

#### TSX 17

TSX 17 PLCs are connected via an accessory for converting the COM1 link (RS 232) into a RS 485 link (to be ordered separately).

Accessory reference number: **TSX 17 ACC PC**

---

#### April 2000/30000

This connection requires the use of connection cable **TSX PKIT 2040** (to be ordered separately).

This 2 meter-long cable is equipped with the following:

- A 9-contact SUB-D- type female connector for connection to the Smart iPC.
  - A 9-contact SUB-D-type male connector for connection to the PLC.
-



---

# IV



---

## Appendices

### At a Glance

---

**Subject of this part**

This part contains the appendices relating to the products.

---

**What's in this Part?**

This part contains the following chapters:

| Chapter | Chapter Name | Page |
|---------|--------------|------|
| 11      | Accessories  | 79   |

---



---

## Accessories

11

---

### Accessories

#### List

Accessories are available as options. The list of accessories is shown below:

| Description                       | Reference        |
|-----------------------------------|------------------|
| RAM 512Mb 1,7G                    | MPC YK05 RAM 512 |
| RAM 512Mb 667M                    | MPC YK02 RAM 512 |
| Empty Compact Flash 512Mb         | MPC YN00 CFE 00N |
| Protection sheet                  | MPC YK50 SPS KIT |
| Industrial external PS/2 keyboard | MPC YN00 KBD 00N |

---

