

# Rotary encoders and angle sensors

## Product overview



Partnership.

Precise.

Pioneering.

# Visibly better: Baumer sensors.

The Baumer Group is leading at international level in the development and production of sensors, shaft encoders, measuring instruments as well as components for automatic image processing. As an owner-managed family business, we employ about 2700 workers worldwide in 38 subsidiaries and 19 countries. With marked customer orientation, consistently high quality and vast innovation capability, Baumer develops specific solutions for many industries and applications worldwide.

## Our standards – your benefits.

- Passion coupled with expertise – both have made us a sensor pioneer and technology leader
- Our range of services is hard to beat – we have the right product, developed by our own team, for every task
- Inspiring through innovation – a challenge Baumer employees take on every day
- Reliability, precision and quality – our customers' requirements are what drives us
- Partnership from the start – together with our customers we develop suitable solutions
- Always a step ahead – thanks to our production depth, our flexibility and our delivery reliability
- Available worldwide – Baumer is Baumer everywhere





## Baumer sensors – precise, compact and reliable.

Baumer offers a broad portfolio of standard products based on a multitude of sensor technologies. Our customers benefit from the comprehensive consultation and reliable service we provide around the world. In close collaboration with them we develop specific solutions with distinct advantages in cost and performance. Our customers benefit from our international development teams, the considerable diversity of our production facilities and optimized business processes, which guarantee maximum flexibility and promptness in the implementation of customer requirements.



Downloadable data sheets as well as further information about our products is available at:  
[www.baumer.com/motion](http://www.baumer.com/motion)

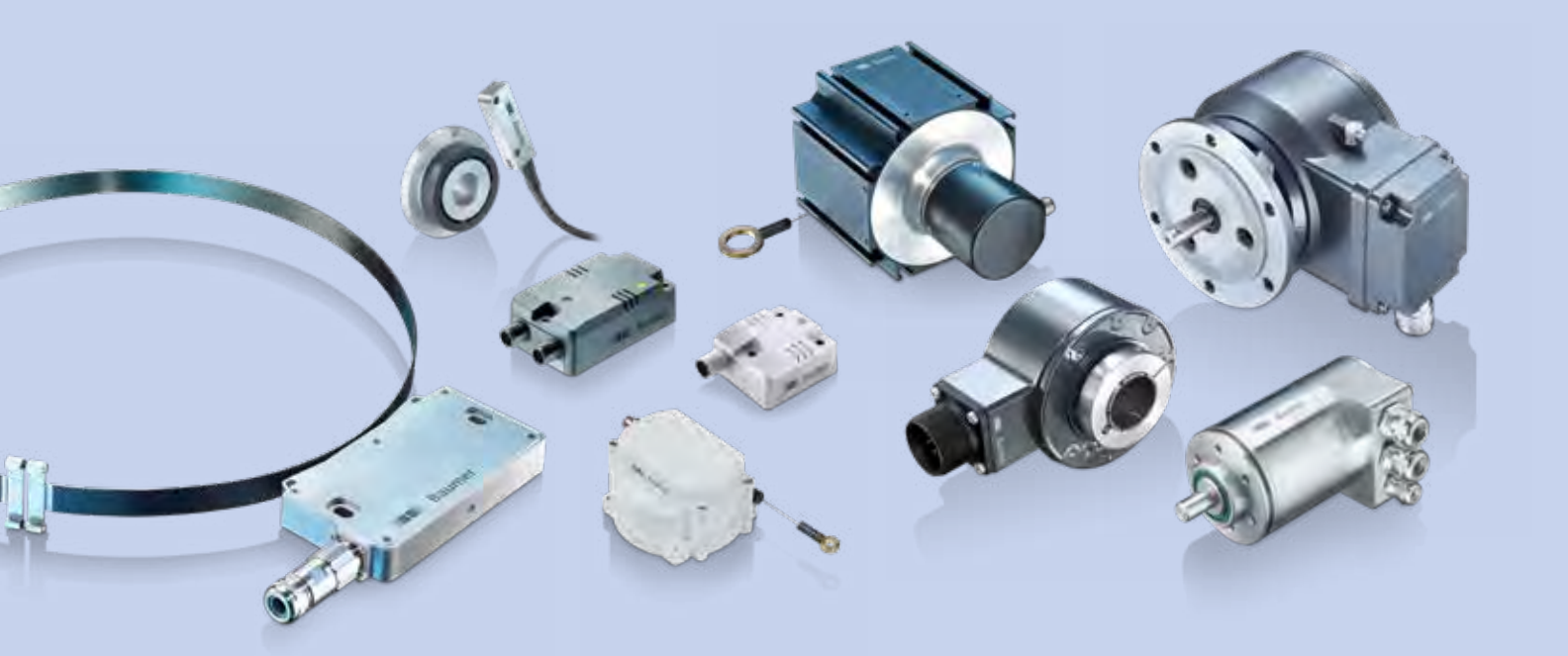

# Content.

<b>Industrial encoders incremental</b>	<b>4</b>	<b>Bearingless encoders</b>	<b>52</b>
Size up to $\varnothing 40$ mm	6	Incremental	54
Size $\varnothing 58$ mm	8	Absolute	58
Large hollow shaft	10	For wide shaft diameter	61
Sine/Cosine	12	Analog magnetic rotary sensors	62
Inch size / square flange	14		
EURO flange B10	15	<b>Hall / speed sensores</b>	<b>64</b>
<b>Industrial encoders absolute</b>	<b>16</b>	<b>Programmable encoders</b>	<b>68</b>
Size up to $\varnothing 36$ mm	18		
Size $\varnothing 58$ mm	20	<b>For special applications</b>	<b>72</b>
Large hollow shaft	25	Encoders for hazardous environments	74
		Redundant absolute encoders	76
<b>HeavyDuty encoders incremental</b>	<b>26</b>	SIL encoders incremental	77
Size up to $\varnothing 120$ mm / solid shaft	28	Stainless steel encoders	78
Size up to $\varnothing 105$ mm / hollow shaft	30	Offshore encoders	80
Large hollow shaft	32		
Sine/Cosine	34	<b>Inclination &amp; acceleration sensors</b>	<b>82</b>
		Inclination sensors	84
<b>HeavyDuty encoders absolute</b>	<b>36</b>	Dynamic inclination sensors / acceleration sensors	85
Size up to $\varnothing 115$ mm	36		
Large hollow shaft	37	<b>Distance measurement</b>	<b>86</b>
		Cable transducers	88
<b>HeavyDuty speed switches / monitors</b>	<b>38</b>	Linear magnetic encoders	90
Mechanical / electronic	38	Measuring wheel encoders	91
Digital / stand-alone	39		
Digital / encoder-integrated	40	<b>Accessories</b>	<b>92</b>
		Mounting accessories / programming tools	92
<b>HeavyDuty tachogenerators</b>	<b>44</b>	Connectors / cable / measuring wheels / counters	93
		Signal processing	94
<b>HeavyDuty combinations</b>	<b>48</b>		
		<b>Index</b>	<b>98</b>

Flexible,  
robust and  
precise.



*OptoPulse*® EIL580-SC  
with clamping flange and M23 connector

# Industrial encoders incremental



## Incredibly versatile.

From cost-efficient standard products on to high-resolution variants with 80 000 ppr: In our portfolio you always will encounter the matching incremental encoder. Our passion for sensors lays the groundwork for innovative products available in different designs and variants – with robust magnetic or precise optical sensing, optional HTL, TTL or sine signals and with all standard mechanical interfaces.

The product portfolio comprises particularly compact designs of mere 24 mm in diameter on to large hollow shaft diameters up to 85 mm. Configurable encoders allow for maximum flexibility in a wide range of applications. In doing so, they contribute towards cutting down on costs in maintenance and inventory.



## Service

*OptoPulse*® – quickly available with short lead times.

*OptoPulse*® also sets new standards when it comes to delivery, because we ship many types of devices directly from stock on the day they are ordered. Other preferred types up to 10 units are delivered within a few working days thanks to optimally coordinated processes.

# Industrial encoders incremental

## Size up to $\varnothing 40$ mm

Precise optical sensing.

Up to 2048 pulses per revolution.

- Solid shaft, blind or through hollow shaft
- Ideal where space is tight



Features	<ul style="list-style-type: none"> <li>■ Size <math>\varnothing 24</math> mm</li> <li>■ Solid shaft with synchro flange</li> </ul>	<ul style="list-style-type: none"> <li>■ Size <math>\varnothing 24</math> mm</li> <li>■ Blind hollow shaft</li> </ul>	<ul style="list-style-type: none"> <li>■ Size <math>\varnothing 30</math> mm</li> <li>■ Solid shaft with synchro flange</li> </ul>	<ul style="list-style-type: none"> <li>■ Size <math>\varnothing 40</math> mm</li> <li>■ Blind hollow or through hollow shaft</li> </ul>
Product family	ITD 01 B14	ITD 01 A4	BDK 16	BHK 16
Sensing method	Optical			
Size (housing)	$\varnothing 24$ mm		$\varnothing 30$ mm	$\varnothing 40$ mm
Voltage supply	5 VDC $\pm 5\%$ , 8...30 VDC		5 VDC $\pm 10\%$ , 10...30 VDC	
Output stage				
- TTL/RS422	■	■	■	■
- HTL/push-pull	■	■	■	■
Output signals	A 90° B, R + inverted			
Shaft type				
- Solid shaft	$\varnothing 4$ mm	–	$\varnothing 5$ mm	–
- Blind hollow shaft	–	$\varnothing 4$ mm	–	$\varnothing 12$ mm
- Through hollow shaft	–	–	–	$\varnothing 6$ mm
Connection				
- Flange connector M9	–	–	Radial	
- Cable	Radial / axial	Radial	Radial / axial	Radial
Pulses per revolution	30...1024		10...2048	
Operating temperature	-20...+85 °C			
Protection	IP 54		IP 42, IP 64	IP 42
Operating speed	$\leq 18\,000$ rpm	$\leq 10\,000$ rpm	$\leq 12\,000$ rpm (IP 42) $\leq 6000$ rpm (IP 65)	$\leq 12\,000$ rpm
Max. shaft load	$\leq 5$ N axial, $\leq 8$ N radial	–	$\leq 10$ N axial, $\leq 10$ N radial	–



# Industrial encoders incremental

## Size up to ø40 mm

Robust magnetic sensing.  
Up to 1024 pulses per revolution.

- Solid shaft or blind hollow shaft
- Ideal where space is tight

[www.baumer.com/incremental](http://www.baumer.com/incremental)

*EcoMag*



Features	<ul style="list-style-type: none"> <li>■ Size ø30 mm</li> <li>■ Solid shaft with synchro flange</li> </ul>	<ul style="list-style-type: none"> <li>■ Size ø30 mm</li> <li>■ Solid shaft with synchro flange</li> <li>■ High protection IP 67</li> </ul>	<ul style="list-style-type: none"> <li>■ Size ø40 mm</li> <li>■ Blind hollow shaft</li> </ul>
Product family	BRIV 30	BRIV 30R	BRIH 40
Sensing method	Magnetic		
Size (housing)	ø30 mm	ø30 mm	ø40 mm
Voltage supply	5 VDC ±10 %, 20...28 VDC		
Output stage			
- TTL/RS422	■	■	■
- HTL/push-pull	■	■	■
Output signals	A 90° B, R + inverted		
Shaft type			
- Solid shaft	ø5 mm	ø6 mm, ø8 mm	–
- Blind hollow shaft	–	–	ø6 mm, ø12 mm
Connection			
- Flange connector M9	Radial	Radial / axial	Radial
- Cable	Radial / axial	Radial / axial	Radial
Pulses per revolution	2...1024		
Operating temperature	-20...+65 °C -20...+85 °C (5 VDC)	-40...+65 °C -40...+85 °C (5 VDC)	-20...+65 °C -20...+85 °C (5 VDC)
Protection	IP 64	IP 67	IP 65
Operating speed	≤6000 rpm		
Max. shaft load	≤10 N axial, ≤10 N radial	≤30 N axial, ≤50 N radial	–

*EcoMag*

*EcoMag* – robust incremental encoders with resilient magnetic sensing.

# Industrial encoders incremental

## Size ø58 mm

Precise optical sensing. Flexibly programmable.  
Up to 65 536 pulses per revolution.

- Solid shaft, blind or through hollow shaft
- Robust all-metal housing



OptoPulse®



Features	■ Solid shaft with clamping flange		■ Solid shaft with synchro flange		■ Blind hollow shaft		■ Through hollow shaft	
Product family	EIL580-SC	EIL580P-SC	EIL580-SY	EIL580P-SY	EIL580-B	EIL580P-B	EIL580-T	EIL580P-T
Programmable	-	■	-	■	-	■	-	■
Sensing method	Optical							
Size (housing)	ø58 mm							
Voltage supply	5 VDC ±5 %, 8...30 VDC, 4.75...30 VDC							
Output stage								
- TTL/RS422	■		■		■		■	
- HTL/push-pull	■		■		■		■	
Output signals	A 90° B, R + inverted							
Shaft type								
- Solid shaft	ø10 mm		ø6 mm		-		-	
- Blind hollow shaft	-		-		ø8...15 mm		-	
- Through hollow shaft	-		-		-		ø8...15 mm	
Connection								
- Flange connector M12, M23	Radial / axial						Radial	
- Cable	Radial / axial / tangential						Radial / tangential	
Pulses per revolution	100...5000	1...65 536	100...5000	1...65 536	100...5000	1...65 536	100...5000	1...65 536
Operating temperature	-40...+85 °C (option: +100 °C)							
Protection	IP 65, IP 67							
Operating speed	≤12 000 rpm (IP 65) ≤6000 rpm (IP 67)				≤8000 rpm (IP 65) ≤6000 rpm (IP 67)		≤6000 rpm (IP 65) ≤3000 rpm (IP 67)	
Max. shaft load	≤40 N axial, ≤80 N radial				-		-	
Options	Approval ATEX II 3 D, Zone 22 (ExEIL580, ExEIL580P), Square flange 2.5 Inch, EURO-flange B10 (REO-flange) SIL2/PLd certification (EIL576S-S)				Isolated hollow shaft, hybrid bearings Stainless steel design (GE333) Operating temperature up to +120 °C (ITD21H00) SIL3/SIL2 certification (EIL576S-T)			

OptoPulse®

The innovative optical sensing method utilized by *OptoPulse*® incremental encoders ensures ultra-high accuracy and consistently high signal quality throughout the entire temperature range. The heart of this technology is a monolithic OptoASIC with high integration density particularly conceived for high-precision encoders. Thanks to the limited number of discrete components, reliability in the application is decisively improved when it comes to shocks and vibrations.

# Industrial encoders incremental

## Size ø58 mm

Robust magnetic sensing.  
Up to 2048 pulses per revolution.

- Solid shaft, blind or through hollow shaft
- Robust all-metal housing

[www.baumer.com/incremental](http://www.baumer.com/incremental)

EcoMag



Features	■ Solid shaft with clamping flange	■ Solid shaft with synchro flange	■ Blind hollow shaft	■ Through hollow shaft
Product family	BRIV 58K	BRIV 58S	BRIH 58S	BRID 58S
Sensing method	Magnetic			
Size (housing)	ø58 mm			
Voltage supply	5 VDC ±10 %, 10...30 VDC			
Output stage				
- TTL/RS422	■	■	■	■
- HTL/push-pull	■	■	■	■
Output signals	A 90° B, R + inverted			
Shaft type				
- Solid shaft	ø10 mm	ø6 mm	–	–
- Blind hollow shaft	–	–	ø12 mm	–
- Through hollow shaft	–	–	–	ø12 mm
Connection				
- Flange connector M12, M23	Radial			
- Cable	Radial			
Pulses per revolution	64...2048			
Operating temperature	-20...+85 °C			
Protection	IP 42, IP 65			
Operating speed	≤12 000 rpm (IP 42), ≤6000 rpm (IP 65)			
Max. shaft load	≤40 N axial, ≤60 N radial		–	–



## ShaftLock

The *ShaftLock* locking collar prevents the large high-quality bearing pack from any misalignment by high axial shaft loads during operation or at installation. The *ShaftLock* technology ensures maximum precision and improved service life, keeps code disc and sensing unit safe from damage and avoids cost-intensive downtime.

# Industrial encoders incremental

## Large hollow shaft

Precise optical sensing. Flexibly programmable.  
Up to 80 000 pulses per revolution.

- Blind hollow or through hollow shaft
- Easy installation



Features	<ul style="list-style-type: none"> <li>■ Through hollow shaft</li> <li>■ Torque support</li> <li>■ Up to 2048 ppr</li> </ul>	<ul style="list-style-type: none"> <li>■ Through hollow shaft</li> <li>■ Up to 10 000 ppr</li> </ul>	<ul style="list-style-type: none"> <li>■ Through hollow shaft</li> <li>■ Protection up to IP 67</li> <li>■ Up to 80 000 ppr</li> <li>■ Isolated shaft</li> </ul>	<ul style="list-style-type: none"> <li>■ Through hollow shaft</li> <li>■ Protection up to IP 67</li> <li>■ Programmable 1...8192 ppr</li> <li>■ Isolated shaft</li> </ul>
Product family	ITD 40	ITD 41	HS35F	HS35P
Programmable	–	–	–	■
Sensing method	Optical			
Size (housing)	ø80 mm		ø3.15" (ø80 mm)	
Voltage supply	5 VDC ±5 %, 8...30 VDC		4.75...30 VDC	
Output stage				
- TTL/RS422	■	■	■	■
- HTL/push-pull	■	■	■	■
Output signals	A 90° B, R + inverted			
Shaft type				
- Through hollow shaft	ø17...27 mm	ø17...30 mm	ø0.375...1" (ø9.525...25.4 mm)	
Connection				
- Flange connector M23	Radial	Radial	–	–
- Flange connector MIL	–	–	Radial, 7-/10-pin	Radial, 7-/10-pin
- Cable	Radial			
Pulses per revolution	200...2048	2000...10 000	1024...80 000	1...8192
Operating temperature	-20...+70 °C, -20...+100 °C		-40...+100 °C (-40...+212 °F)	
Protection	IP 65		IP 54, IP 65, IP 67	
Operating speed	≤5000 rpm, ≤3000 rpm (>70 °C)		≤5000 rpm	
Options	Torque support with electric isolation Stainless steel design		Sinus/Cosinus output signals (HS35S)	

# Industrial encoders incremental

## Large hollow shaft

Precise optical sensing.  
Up to 10 000 pulses per revolution.

- Through hollow shaft
- Easy installation

[www.baumer.com/incremental](http://www.baumer.com/incremental)



Features	<ul style="list-style-type: none"> <li>■ Through hollow shaft up to <math>\varnothing 50</math> mm</li> <li>■ Very flat design</li> <li>■ Clamping at B side</li> <li>■ Stainless steel design</li> </ul>	<ul style="list-style-type: none"> <li>■ Through hollow shaft up to <math>\varnothing 65</math> mm</li> <li>■ Clamping at B side</li> </ul>	<ul style="list-style-type: none"> <li>■ Through hollow shaft up to <math>\varnothing 85</math> mm</li> <li>■ Bearingless</li> </ul>
Product family	ITD61H00	ITD 70	ITD 75
Sensing method	Optical		
Size (housing)	$\varnothing 120$ mm	$\varnothing 150$ mm	
Voltage supply	4.75...30 VDC, 8...30 VDC	5 VDC $\pm 5$ %, 8...30 VDC	
Output stage			
- TTL/RS422	■	■	■
- HTL/push-pull	■	■	■
Output signals	A 90° B, R + inverted		
Shaft type			
- Through hollow shaft	$\varnothing 30$ ...50 mm	$\varnothing 38$ ...65 mm	$\varnothing 60$ ...85 mm
Connection			
- Flange connector M23	Radial	Radial	–
- Cable	Radial		
Pulses per revolution	1024...10 000	1000...2500	
Operating temperature	-20...+70 °C		
Protection	IP 54		
Operating speed	$\leq 4000$ rpm	$\leq 3000$ rpm	
Options	Cable with connector		

# Industrial encoders incremental

## Sine/Cosine

Precise optical sensing. Highest signal quality.

- Size  $\varnothing 58...80$  mm
- Maximum speed 6000 rpm
- Robust all-metal housing



Features	<ul style="list-style-type: none"> <li>■ Through hollow shaft</li> <li>■ Tangential cable outlet</li> </ul>	<ul style="list-style-type: none"> <li>■ Through hollow shaft</li> <li>■ Inch size</li> <li>■ Protection up to IP 67</li> </ul>	<ul style="list-style-type: none"> <li>■ Through hollow shaft</li> </ul>
Product family	ITD22H00	HS355	ITD 42 A4 Y79
Sensing method	Optical / <i>LowHarmonics</i>		
Size (housing)	$\varnothing 58$ mm	$\varnothing 3.15"$ ( $\varnothing 80$ mm)	$\varnothing 80$ mm
Voltage supply	5 VDC $\pm 10$ %	4.75...30 VDC	5 VDC $\pm 10$ %, 8...30 VDC
Output stage	SinCos 1 Vpp		
Shaft type	- Through hollow shaft		
	$\varnothing 10$ mm, $\varnothing 12$ mm, $\varnothing 14$ mm	$\varnothing 0.375...1"$ ( $\varnothing 9.525...25.4$ mm)	$\varnothing 20...27$ mm
Connection	- Flange connector MIL		
	–	Radial, 7-/10-pin	–
	- Cable		
	Tangential	Radial	Radial
Sine periods per revolution	1024...2048	1024...5000	1024...2048
Operating temperature	-30...+100 °C	-40...+100 °C (-40...+212 °F)	-20...+85 °C
Protection	IP 65	IP 54, IP 65, IP 67	IP 65
Operating speed	$\leq 6000$ rpm	$\leq 5000$ rpm (IP 65) $\leq 3000$ rpm (IP 67)	$\leq 5000$ rpm
Options	SIL3/SIL2 certification (EIL576S-T)	HTL/TTL output signals (HS35F) Programmable (HS35P)	–

## LowHarmonics

*LowHarmonics* is leading cutting-edge technology by generating sine signals with negligible harmonic content. Sine encoders with *LowHarmonics* ensure improved control quality, less drive heating and higher energy efficiency.

# Industrial encoders incremental Sine/Cosine



[www.baumer.com/incremental](http://www.baumer.com/incremental)

# Industrial encoders incremental

## Inch size / square flange

Precise optical sensing. Flexibly programmable.  
Up to 80 000 pulses per revolution.

- Solid shaft, blind or through hollow shaft
- Robust all-metal housing
- Protection up to IP 67



Features	<ul style="list-style-type: none"> <li>■ Solid shaft with square flange</li> <li>■ Inch size</li> <li>■ Up to 65 536 ppr</li> </ul>	<ul style="list-style-type: none"> <li>■ Blind hollow shaft</li> <li>■ Up to 65 536 ppr</li> </ul>	<ul style="list-style-type: none"> <li>■ Through hollow shaft</li> <li>■ Up to 65 536 ppr</li> </ul>	<ul style="list-style-type: none"> <li>■ Through hollow shaft</li> <li>■ Inch size</li> <li>■ Up to 80 000 ppr</li> <li>■ Isolated shaft</li> </ul>				
Product family	EIL580-SQ	EIL580P-SQ	EIL580-B	EIL580P-B	EIL580-T	EIL580P-T	HS35F	HS35P
Programmable	–	■	–	■	–	■	–	■
Sensing method	Optical							
Size (housing)	2.5 x 2.5" (63.5 x 63.5 mm)		2.28" (ø58 mm)		2.28" (ø58 mm)		ø3.15" (ø80 mm)	
Voltage supply	5 VDC ±5 %, 8...30 VDC, 4.75...30 VDC						4.75...30 VDC	
Output stage								
- TTL/RS422	■		■		■		■	
- HTL/push-pull	■		■		■		■	
Output signals	A 90° B, R + inverted							
Shaft type								
- Solid shaft	ø3/8 x 4/5", ø10 mm		–		–		–	
- Blind hollow shaft	–		ø0.315-0.591" (ø8...15 mm)		–		–	
- Through hollow shaft	–		–		ø0.315-0.591" (ø8...15 mm)		ø0.375...1" (ø9.525...25.4 mm)	
Connection								
- Flange connector MIL	–		–		–		7-/10-pin, radial	
- Flange connector M12, M23	Radial / axial		Radial / axial		Radial		–	
- Cable	Radial / axial / tangential		Radial / axial / tangential		Radial / tangential		Radial	
Pulses per revolution	100...5000	1...65 536	100...5000	1...65 536	100...5000	1...65 536	1024...80 000	1...8192
Operating temperature	-40...+85 °C (optional +100 °C)						-40...+100 °C (-40...+212 °F)	
Protection	IP 65, IP 67						IP 54, IP 65, IP 67	
Operating speed	≤12 000 rpm (IP 65) ≤6000 rpm (IP 67)		≤8000 rpm (IP 65) ≤6000 rpm (IP 67)		≤8000 rpm (IP 65) ≤6000 rpm (IP 67)		≤5000 rpm	
Max. shaft load	≤40 N axial, ≤80 N radial		–		–		–	
Options	–		Isolated hollow shaft		Isolated hollow shaft		SinCos output signals (HS35S)	



# Industrial encoders incremental

## EURO flange B10

Precise optical sensing. Flexibly programmable.  
Up to 65 536 pulses per revolution.

- Solid shaft
- High-power signal output drivers
- Protection up to IP 67

[www.baumer.com/incremental](http://www.baumer.com/incremental)



Features	<ul style="list-style-type: none"> <li>■ Solid shaft with EURO flange B10</li> <li>■ Up to 65 536 ppr</li> </ul>	<ul style="list-style-type: none"> <li>■ Solid shaft with EURO flange B10</li> <li>■ Up to 2048 ppr</li> <li>■ More powerful output drivers</li> <li>■ Sense line</li> </ul>	<ul style="list-style-type: none"> <li>■ Solid shaft with EURO flange B10</li> <li>■ Up to 6000 ppr</li> <li>■ More powerful output drivers</li> <li>■ Sense line</li> </ul>	
Product family	EIL580-S1	EIL580P-S1	ITD 40 B10	ITD 41 B10
Programmable	–	■	–	–
Sensing method	Optical			
Size (housing)	ø115 mm		ø82 mm	
Voltage supply	5 VDC ±5 %, 8...30 VDC 4.75...30 VDC		5 VDC ±5 %, 8...30 VDC	
Output stage				
- TTL/RS422	■	–	–	–
- HTL/push-pull	■	■	–	■
Output signals	A 90° B, R + inverted			
Shaft type				
- Solid shaft	ø11 mm			
Connection				
- Flange connector M12	Radial / axial		–	–
- Flange connector M23	Radial / axial		–	–
- Cable	Radial / axial / tangential		Radial	
Pulses per revolution	100...5000	1...65 536	200...2048	1000...6000
Operating temperature	-40...+85 °C (optional +100 °C)		-20...+70 °C (-20...+100 °C)	
Protection	IP 65, IP 67		IP 65	
Operating speed	≤12 000 rpm (IP 65) ≤6000 rpm (IP 67)		≤12 000 rpm	≤6000 rpm
Max. shaft load	≤40 N axial, ≤80 N radial		≤40 N axial, ≤60 N radial	
Options	–		Seawater resistant, cable with connector	

# Compact high performance.



Absolute encoders in ø58 mm design:  
EAL580 with clamping flange

# Industrial encoders absolute



## All standard interfaces, either device-integrated or in modular bus cover.

With Baumer, you will always encounter the absolute encoder that is just right for your requirements – with conventional point-to-point interface or realtime Ethernet, with precise optical or robust magnetic sensing, from compact  $\varnothing 28$  mm size on to large hollow shafts of  $\varnothing 50$  mm. The products are optimized for maximum performance and hence ideal for demanding applications where they measurably contribute towards increased productivity.

Reliable quality and flexible supplies of any interface and product variant: This involves qualified and committed people, intelligent technologies and the latest production methods.



### Sensing technologies

Optical or magnetic sensing

Optical encoders ensure ultimate precision and maximum magnetic field immunity in parallel.

They allow for resolutions up to 18 bits per turn at an accuracy as high as  $\pm 0.01^\circ$ . Magnetic encoders of the *MAGRES* series are particularly robust and always provide reliable operation even under heavy shocks and vibrations or where there is dew and condensation.



# Industrial encoders absolute

## Size up to $\varnothing 36$ mm

### Robust, precise magnetic sensing.

- Solid shaft and blind hollow shaft
- Compact designs for tight spaces
- Shock resistant up to 500 g
- Angular accuracy up to  $\pm 0.15^\circ$



MAGRES



Features	<ul style="list-style-type: none"> <li>■ Solid shaft with flat mounting flange</li> <li>■ Redundant sensing and interface</li> </ul>	<ul style="list-style-type: none"> <li>■ Solid shaft with synchro flange</li> </ul>	<ul style="list-style-type: none"> <li>■ Solid shaft with synchro flange</li> <li>■ E1 compliant design</li> <li>■ Corrosion protection CX (C5-M)</li> <li>■ ISO 13849 compliant firmware</li> </ul>	<ul style="list-style-type: none"> <li>■ Blind hollow shaft</li> </ul>
Product family	EAM280	EAM360-SW	EAM360R-SW	EAM360-B

### Interface

- SSI / SSI + incremental	–	■ / ■	–	■ / ■
- Analog	■	–	■	–
- CANopen® / redundant	■ / ■	■ / –	■ / –	■ / –
- CANopen® Lift	–	■	–	■
- SAE J1939	–	–	■	–

Function principle	Singleturn	Multiturn	Singleturn	Multiturn	Singleturn	Multiturn	Singleturn
Sensing method	Magnetic						
Size (housing)	$\varnothing 28.6$ mm	$\varnothing 36$ mm					
Voltage supply	10...30 VDC (CANopen®) 12...30 VDC (Analog) 5 VDC $\pm 5$ % (Analog)	4.5 ... 30 VDC (CANopen®, SAE J1939, SSI) 8 ... 30 VDC / 14 ... 30 VDC (Analog - type-specific)					
Shaft type	$\varnothing 6$ mm	$\varnothing 10$ mm	$\varnothing 10$ mm	–			
- Solid shaft	$\varnothing 6$ mm	$\varnothing 10$ mm	$\varnothing 10$ mm	–			
- Blind hollow shaft	–	–	–	$\varnothing 10...15$ mm			
Connection							
- Flange connector M12	Radial	Radial	Radial	Radial	Radial	Radial	Radial
- Cable	Radial	Radial (0.14 mm <sup>2</sup> )	Radial (0.5 mm <sup>2</sup> )	Radial (0.5 mm <sup>2</sup> )	Radial (0.5 mm <sup>2</sup> )	Radial (0.14 mm <sup>2</sup> )	Radial (0.14 mm <sup>2</sup> )
Steps per turn	4096/12 bits (Analog) 16384/14 bits (CANopen®)	$\leq 65536/16$ bits	$\leq 65536/16$ bits	$\leq 65536/16$ bits	$\leq 65536/16$ bits	$\leq 65536/16$ bits	$\leq 65536/16$ bits
Number of turns	–	$\leq 262144/18$ bits	–	$\leq 262144/18$ bits	–	$\leq 262144/18$ bits	–
Absolute accuracy	$\pm 1.8^\circ$	Up to $\pm 0.15^\circ$					
Operating temperature	-40...+85 °C						
Protection	IP 65, IP 67	IP 65, IP 67		IP 67		IP 65, IP 67	
Operating speed	$\leq 800$ rpm	$\leq 6000$ rpm					
Max. shaft load	$\leq 10$ N axial, $\leq 10$ N radial	$\leq 40$ N axial, $\leq 80$ N radial					
Options	Cable with DEUTSCH connector	Additional incremental signals (SSI, CANopen®) Corrosion protection CX (C5-M)		Cable with DEUTSCH connector		Additional incremental signals (SSI, CANopen®) Corrosion protection CX (C5-M)	

# Industrial encoders absolute

## Size up to ø36 mm

CANopen SAE J1939 SSI HTL / TTL



0...10 V  
0.5...4.5 V  
4...20 mA

[www.baumer.com/absolute](http://www.baumer.com/absolute)

MAGRES



Features	<ul style="list-style-type: none"> <li>Blind hollow shaft</li> <li>E1 compliant design</li> <li>Corrosion protection CX (C5-M)</li> <li>ISO 13849 compliant firmware</li> </ul>	
Product family	EAM360R-B	
Interface		
- SSI	–	
- Analog	■	
- CANopen® / redundant	■ / –	
- CANopen® Lift	–	
- SAE J1939	■	
Function principle	Multiturn	Singleturn
Sensing method	Magnetic	
Size (housing)	ø36 mm	
Voltage supply	4.5... 30 VDC (CANopen®, SAE J1939) 8... 30 VDC / 14... 30 VDC (Analog - type-specific)	
Shaft type		
- Blind hollow shaft	ø10...15 mm	
Connection		
- Flange connector M12	Radial	
- Cable	Radial (0.5 mm <sup>2</sup> )	
Steps per turn	≤65536/16 bits	≤65536/16 bits
Number of turns	≤262144/18 bits	–
Absolute accuracy	Up to ±0.15°	
Operating temperature	-40...+85 °C	
Protection	IP 67	
Operating speed	≤6000 rpm	
Max. shaft load	≤40 N axial, ≤80 N radial	
Options	Cable with DEUTSCH connector	

## MAGRES – Robust precision

The latest generation of our absolute encoders *MAGRES* is based on an innovative, patent-pending magnetic singleturn and multiturn sensing method with proven but even further improved robustness and longevity.

Thanks to optimally harmonized components and supreme, sophisticated signal processing, these encoders operate with a precision that previously only optical encoders could achieve.

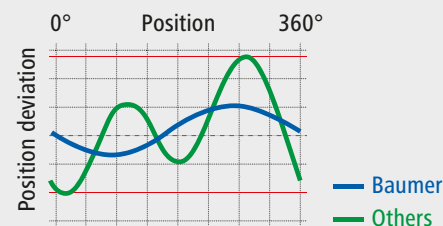

## R-Series for extreme applications

Your benefits

- CX (C5-M) corrosion protection for high durability in outdoor use
  - E1 compliant design for high electromagnetic compatibility when used in vehicles
  - ISO 13849 compliant firmware for use in safety functions up to PLD
  - Robust strand cross-section 0.5 mm<sup>2</sup> for cable with DEUTSCH connector
- Our qualified and experienced experts would be glad to support you in the design of your safety-relevant application and its certification by the notified body.

# Industrial encoders absolute

## Size ø58 mm

Robust, precise magnetic sensing.  
Integrated interface and modular bus covers.

- Solid shaft and blind hollow shaft
- Hermetically sealed, compliance up to IP 69K
- Shock resistant up to 500 g
- Angular accuracy up to  $\pm 0.15^\circ$



MAGRES



Features	<ul style="list-style-type: none"> <li>■ Solid shaft with clamping or synchro flange</li> </ul>	<ul style="list-style-type: none"> <li>■ Solid shaft with clamping or synchro flange</li> <li>■ E1 compliant design</li> <li>■ Corrosion protection CX (C5-M)</li> <li>■ ISO 13849 compliant firmware</li> </ul>	<ul style="list-style-type: none"> <li>■ Blind hollow shaft</li> </ul>	<ul style="list-style-type: none"> <li>■ Blind hollow shaft</li> <li>■ E1 compliant design</li> <li>■ Corrosion protection CX (C5-M)</li> <li>■ ISO 13849 compliant firmware</li> </ul>
Product family	EAM580-S	EAM580R-S	EAM580-B	EAM580R-B

### Interface

- SSI / SSI + incremental	■ / ■	-	■ / ■	-
- Analog	-	■	-	■
- CANopen® / redundant	■ / -	■ / ■	■ / -	■ / ■
- CANopen® Lift	■	-	■	-
- SAE J1939	-	■	-	■
- Profinet	■	-	■	-
- EtherCAT / EtherNet/IP	■ / ■	- / -	■ / ■	- / -

Function principle	Multiturn	Singleturn	Multiturn	Singleturn	Multiturn	Singleturn	Multiturn	Singleturn
Sensing method	Magnetic							
Size (housing)	ø58 mm							
Voltage supply	4.5 ... 30 VDC (CANopen®, SAE J1939, SSI), 8 ... 30 VDC / 14 ... 30 VDC (Analog - type-specific), 10 ... 30 VDC (Ethernet)							
Shaft type	- Solid shaft				- Blind hollow shaft			
	ø6 mm, ø10 mm				ø10...15 mm			
Connection	- Flange connector M12		- Flange connector M23		- Cable			
	Radial		Radial		Radial (0.14 mm <sup>2</sup> )		Radial (0.5 mm <sup>2</sup> )	
Steps per turn	≤65536/16 bits		≤65536/16 bits		≤65536/16 bits		≤65536/16 bits	
Number of turns	≤262144/18 bits		≤262144/18 bits		≤262144/18 bits		≤262144/18 bits	
Absolute accuracy	Up to $\pm 0.15^\circ$							
Operating temperature	-40...+85 °C							
Protection	IP 65, IP 67		IP 67		IP 65, IP 67		IP 67	
Operating speed	≤6000 rpm							
Max. shaft load	≤40 N axial, ≤80 N radial							
Options	Additional incremental signals (SSI, CANopen®) Corrosion protection CX (C5-M)		Cable with DEUTSCH connector Two-channel architecture		Additional incremental signals (SSI, CANopen®) Corrosion protection CX (C5-M)		Cable with DEUTSCH connector Two-channel architecture	

# Industrial encoders absolute

## Size ø58 mm



[www.baumer.com/absolute](http://www.baumer.com/absolute)

**MAGRES**  
hermetic



Features	<ul style="list-style-type: none"> <li>■ Solid shaft with clamping flange</li> <li>■ Multiturn</li> <li>■ Hermetically sealed</li> <li>■ Integrated interfaces</li> </ul>	<ul style="list-style-type: none"> <li>■ Solid shaft with clamping flange</li> <li>■ Multiturn</li> <li>■ Hermetically sealed</li> <li>■ Modular bus cover</li> </ul>
Product family	BMMV 58 - hermetic	BMMV 58 - hermetic

Interface		
- SSI	■	–
- CANopen®	■	■
- Profibus-DP	■	■
- Profinet	–	■
- SAE J1939	–	■
- EtherCAT / EtherNet/IP	– / –	■ / ■

Function principle	Multiturn	
Sensing method	Magnetic	
Size (housing)	ø58 mm	
Voltage supply	10...30 VDC	
Shaft type		
- Solid shaft	ø10 mm	
Connection	Flange connector M12	
Steps per turn	≤4096/12 bits ≤8192/13 bits (Profibus)	≤4096/12 bits
Number of turns	≤65536/16 bits (Profibus) ≤262 144/18 bits	≤65536/16 bits ≤262 144/18 bits (CANopen®)
Absolute accuracy	±1°	
Operating temperature	-40...+85 °C	
Protection	IP 68, IP 69 K	
Operating speed	≤6000 rpm	
Max. shaft load	≤120 N axial, ≤280 N radial	

# Industrial encoders absolute

## Size $\varnothing 58$ mm

### Precise optical sensing.

- Resolution up to 18 bits per revolution
- High accuracy up to  $\pm 0.01^\circ$
- Operating temperature up to  $-40^\circ\text{C}$
- LED status indicators



Features	■ Solid shaft with clamping or synchro flange		■ Blind hollow or through hollow shaft		■ Solid shaft with clamping or synchro flange		■ Blind hollow or through hollow shaft	
Product family	EAL580-SC	EAL580-SV	EAL580-B	EAL580-T	EAL580-SC	EAL580-SV	EAL580-B	EAL580-T
Interface	Up to 18 bits singleturn resolution				Up to 13 bits singleturn resolution			
- Profinet	■	■	■	■	■	■	■	■
- EtherCAT	■	■	■	■	■	■	■	■
- EtherNet/IP	■	■	■	■	■	■	■	■
Function principle	Multiturn / Singleturn							
Sensing method	Optical							
Size (housing)	$\varnothing 58$ mm							
Voltage supply	10...30 VDC							
Flange	Clamping flange	Synchro flange	Blind hollow shaft	Through hollow shaft	Clamping flange	Synchro flange	Blind hollow shaft	Through hollow shaft
Shaft type								
- Solid shaft	$\varnothing 10$ mm	$\varnothing 6$ mm	–	–	$\varnothing 10$ mm	$\varnothing 6$ mm	–	–
- Blind hollow shaft	–	–	$\varnothing 10...15$ mm	–	–	–	$\varnothing 10...15$ mm	–
- Through hollow shaft	–	–	–	$\varnothing 10...14$ mm	–	–	–	$\varnothing 10...14$ mm
Connection	Flange connector 3xM12							
Steps per turn	$\leq 262\ 144/18$ bits				$\leq 8192/13$ bits			
Number of turns	$\leq 8192/13$ bits		$\leq 8192/13$ bits		$\leq 65536/16$ bits		$\leq 65536/16$ bits	
Absolute accuracy	$\pm 0.01^\circ$				$\pm 0,025^\circ$			
Protection	IP 54, IP 65, IP 67							
Operating temperature	$-40...+85^\circ\text{C}$ (depending on product and variant)							
Operating speed	$\leq 6000$ rpm							
Max. shaft load	$\leq 20$ N axial, $\leq 40$ N radial		–		$\leq 20$ N axial, $\leq 40$ N radial		–	
Options	Preset / reset button (not at EtherCAT)							



# Industrial encoders absolute

## Size ø58 mm



HighRes – up to 18 bits  
singleturn resolution

[www.baumer.com/absolute](http://www.baumer.com/absolute)



Features	■ Solid shaft with clamping flange		■ Solid shaft with synchro flange		■ Blind hollow shaft		■ Through hollow shaft	
Interface <sup>1)</sup>	Product family - up to 18 bits singleturn resolution							
- SSI / SSI + incremental	GBM2W	GBA2W	GBM2W	GBA2W	GBM2S	GBA2S	GBM2H	GBA2H
Interface	Product family - up to 13 bits singleturn resolution							
- SSI / SSI + incremental	GM400	GA240	GM401	GA241	GXM2S	GXA2S	G0M2H	G0A2H
- CANopen®	GXP5W	GXU5W	GXP5W	GXU5W	GXP5S	–	G0P5H	–
Function principle	Multiturn	Singleturn	Multiturn	Singleturn	Multiturn	Singleturn	Multiturn	Singleturn
Sensing method	Optical							
Size (housing)	ø58 mm							
Voltage supply	10...30 VDC							
Shaft type								
- Solid shaft	ø10 mm		ø6 mm		–		–	
- Blind hollow shaft	–		–		ø10...15 mm		–	
- Through hollow shaft	–		–		–		ø10...14 mm	
Connection	Flange connector M12, M23, D-SUB or cable (depending on product and variant)							
Steps per turn	≤262 144/18 bits resp. ≤8192/13 bits							
Number of turns	≤65536/16 bits	–	≤65536/16 bits	–	≤65536/16 bits	–	≤65536/16 bits	–
Absolute accuracy	±0.01° (singleturn 18 bits), ±0.025° (singleturn 13 bits)							
Protection	IP 54, IP 65				IP 54 (IP 65 optional)		IP 54	
Operating temperature	-40...+85 °C (depending on product and variant)							
Operating speed	≤6000 rpm							
Max. shaft load	≤20 N axial, ≤40 N radial				–			
Options	Stainless steel / offshore design							

1) BISS C, CANopen®, RS485, Modbus on request

# Industrial encoders absolute

## Large hollow shaft

Precise optical sensing. SSI / fieldbus interface.

- Shallow installation depth
- Easy installation
- Wide range of accessories



Features	<ul style="list-style-type: none"> <li>■ Through hollow shaft up to <math>\varnothing 25.4</math> mm</li> <li>■ Integrated interface SSI</li> </ul>	<ul style="list-style-type: none"> <li>■ Through hollow shaft up to <math>\varnothing 50.8</math> mm</li> <li>■ Integrated interface SSI</li> </ul>	<ul style="list-style-type: none"> <li>■ Through hollow shaft up to <math>\varnothing 25.4</math> mm</li> <li>■ Modular bus cover</li> </ul>	<ul style="list-style-type: none"> <li>■ Through hollow shaft up to <math>\varnothing 50.8</math> mm</li> <li>■ Modular bus cover</li> </ul>
Product family	G1M2H	G2M2H	G1MMH	G2MMH

### Interface

- SSI	■	■	–	–
- CANopen®	–	–	■	■
- Profibus-DP	–	–	■	■

Function principle	Multiturn			
Sensing method	Optical			
Size (housing)	$\varnothing 90$ mm	$\varnothing 116$ mm	$\varnothing 90$ mm	$\varnothing 116$ mm
Voltage supply	10...30 VDC			
Shaft type				
- Through hollow shaft	$\varnothing 25.4$ mm	$\varnothing 50.8$ mm	$\varnothing 25.4$ mm	$\varnothing 50.8$ mm
Connection				
- Bus cover	–		M12 or cable gland (depending on product and variant)	
- Flange connector M23	Radial		–	
Steps per turn	$\leq 8192/13$ bits			
Number of turns	$\leq 4096/12$ bits		$\leq 65536/16$ bits	
Absolute accuracy	$\pm 0.025^\circ$			
Operating temperature	$-25...+85^\circ\text{C}$			
Protection	IP 54			
Operating speed	$\leq 3800$ rpm	$\leq 2000$ rpm	$\leq 3800$ rpm	$\leq 2000$ rpm
Operating temperature	–		Steps per turn Number of turns Rotational direction Preset	
Options	Operating temperature $-40...+85^\circ\text{C}$ Protection IP 65 Additional incremental signals (ATD 4S A4)		Operating temperature $-40...+85^\circ\text{C}$ Protection IP 6	

# Industrial encoders absolute

## Large hollow shaft



[www.baumer.com/absolute](http://www.baumer.com/absolute)

Tough where it's rough.  
Precise in operation.



Incremental encoder HOG 10 with  
blind hollow shaft



## HeavyDuty encoders, speed switches, tachogenerators and combinations.

For decades, Baumer HeavyDuty encoders have been proving unrivalled reliability under most adverse conditions. Whether at gantry cranes, vertical lift bridges, steel plants or windpower stations – these encoders are extremely robust, reliable and durable.

Product combinations merging several sensing methods or twin encoders can take over specific tasks and safety functions. In drive applications where besides the speed information additional control signals are required, HeavyDuty product combinations of encoders, tachogenerators and speed switches will

provide you with the decisive impulse thanks to their integrated additional functions.

Durable and reliable thanks to proven HeavyDuty technology.

- Solid aluminium or stainless steel housing
- Bearings at both shaft ends
- HeavyDuty connection technology
- Isolated against shaft currents
- Explosion protection against gases and dust
- Protected against sea and tropical climate



### Baumer Hübner

Hübner Berlin, now Baumer Hübner, is the Baumer Group competence center for HeavyDuty sensors particularly conceived for drive engineering. We have been world-leading in this industry for more than 50 years, setting new benchmarks for reliable encoders, tachogenerators and speed switches in HeavyDuty technology. Our unrivalled resilient products are optimized to match your individual application and merge longtime branch expertise with cutting-edge technology. For dependable operation you can always rely on.

# HeavyDuty encoders incremental

## Size up to $\varnothing 120$ mm / solid shaft

### Solid shaft with EURO flange B10.

- Precision speed signals for drive engineering
- Robust electrical and mechanical designs
- Redundant sensing / twin encoders
- Second shaft end for centrifugal / speed switches
- Integrated function monitoring EMS



Features	<ul style="list-style-type: none"> <li>■ Solid shaft with EURO flange B10</li> <li>■ Housing uncoated</li> </ul>	<ul style="list-style-type: none"> <li>■ Solid shaft with EURO flange B10</li> <li>■ Corrosion protection C4</li> </ul>	<ul style="list-style-type: none"> <li>■ Solid shaft with EURO flange B10</li> <li>■ Shallow installation depth &lt;70 mm</li> </ul>	<ul style="list-style-type: none"> <li>■ Solid shaft with EURO flange B10</li> <li>■ Pulses per revolution up to 5000</li> </ul>
Product family	POG 86E	POG 86	OG 9	POG 9
Sensing method	Optical			
Size (housing)	$\varnothing 115$ mm			
Voltage supply	5 VDC $\pm 5$ %, 9...26 VDC			
Output stage				
- TTL/RS422	■	■	■	■
- HTL/push-pull	–	–	–	–
- HTL-P (Power Linedriver)	■	■	■	■
- LWL (fiber-optic interface)	With fiber-optic transducer (Outdoor-Box)			
Output signals	K1, K2, K0 + inverted			
Shaft type				
- Solid shaft	$\varnothing 11$ mm			
Flange	EURO flange B10			
Connection	Terminal box			
Pulses per revolution	512...2500	500...5000	1...1250	300...5000
Operating temperature	-40...+100 °C		-30...+100 °C	
Protection	IP 56		IP 55	
Operating speed	$\leq 12\,000$ rpm			
Max. shaft load	$\leq 250$ N axial, $\leq 450$ N radial			
Explosion protection	Ex II 3G IIC / 3D IIIC (ATEX)			
Options	Corrosion protection C4	Function monitoring EMS Second shaft end Centrifugal switch (FSL)	–	Function monitoring EMS Second shaft end Speed switches (FSL, ESL) Twin encoder POG 9 G

## Powerful output drivers

To ensure optimum HTL or TTL signal quality via RS422 even at extended cable length we deploy short circuit proof power drivers with max. 300 mA peak current. This allows for direct TTL signal supply in extended transmission length of more than 500 m and yet extremely compact housings. The high-current power drivers HTL-P are fully compatible to HTL/push-pull and allow for long-distance lines up to 350 m.

# HeavyDuty encoders incremental

## Size up to ø120 mm / solid shaft

Durable & reliability thanks to proven HeavyDuty technology.

- Solid aluminium or stainless steel housings
- Bearings at both shaft ends
- EX-protection for gas and dust
- Insulation against shaft currents
- Protection against seawater and tropical conditions



[www.baumer.com/HD-incremental](http://www.baumer.com/HD-incremental)



Features	<ul style="list-style-type: none"> <li>■ Solid shaft with EURO flange B10</li> <li>■ Pulses per revolution up to 10800</li> </ul>	<ul style="list-style-type: none"> <li>■ Solid shaft with EURO flange B10</li> <li>■ Pulses per revolution up to 5000</li> <li>■ High protection IP 66</li> </ul>	<ul style="list-style-type: none"> <li>■ Solid shaft with EURO flange B10</li> <li>■ Corrosion protection CX (C5-M)</li> </ul>	<ul style="list-style-type: none"> <li>■ Solid shaft with EURO flange B10</li> <li>■ IECEx certification</li> </ul>
Product family	POG 90	POG 10	POG 11	EEx OG 9
Sensing method	Optical			
Size (housing)	ø115 mm			ø120 mm
Voltage supply	5 VDC ±5 %, 9...30 VDC			
Output stage				
- TTL/RS422	■	■	■	■
- HTL-P (Power Linedriver)	■	■	■	■
- LWL (fiber-optic interface)	With fiber-optic transducer (Outdoor-Box)			
Output signals	K1, K2, K0 + inverted			
Shaft type				
- Solid shaft	ø11 mm			
Flange	EURO flange B10			
Connection	Terminal box, rotatable			
Pulses per revolution	1024...10800	300...5000	25...5000	
Operating temperature	-20...+85 °C	-40...+100 °C -50...+100 °C (option)	-40...+55 °C (<500 ppr) -50...+55 °C (<500-2500 ppr) -25...+55 °C (>3072 ppr)	
Protection	IP 66	IP 66	IP 67	IP 56
Operating speed	≤12 000 rpm			≤6000 rpm
Max. shaft load	≤300 N axial, ≤450 N radial			≤200 N axial, ≤350 N radial
Explosion protection	Ex II 3G IIC / 3D IIIIC (ATEX)			Ex II 2G IIC (ATEX/IECEx)
Options	Second shaft end Centrifugal switch (FSL) Speed switch (ESL) Housing foot B3	Function monitoring EMS Redundant (POG 10M) Housing foot B3	Function monitoring EMS Redundant (POG 11M) Housing foot B3	Sinus/Cosinus version: EExOG 9 S



### EURO flange B10

EURO flange B10 is the global mounting standard for HeavyDuty shaft encoders.

# HeavyDuty encoders incremental

## Size up to $\varnothing 105$ mm / hollow shaft

### Blind hollow shaft or cone shaft.

- Precision signals in drive engineering
- Robust electrical and mechanical design
- Redundant sensing
- Integrated function monitoring EMS



Features	<ul style="list-style-type: none"> <li>■ Blind hollow shaft</li> <li>■ High shock and vibration resistance</li> </ul>	<ul style="list-style-type: none"> <li>■ Cone shaft or blind hollow shaft</li> <li>■ Rotatable terminal box</li> <li>■ Isolated ball bearings</li> </ul>	<ul style="list-style-type: none"> <li>■ Cone shaft or blind hollow shaft</li> <li>■ Rotatable terminal box</li> <li>■ Corrosion protection C4</li> <li>■ Isolated ball bearings</li> </ul>
Product family	HOG 71	HOG 86E	HOG 86
Sensing method	Optical		
Size (housing)	$\varnothing 60$ mm	$\varnothing 99$ mm	$\varnothing 99$ mm
Voltage supply	5 VDC $\pm 5\%$ , 9...26 VDC		
Output stage			
- TTL/RS422	■	■	■
- HTL/push-pull	■	–	–
- HTL-P (Power Linedriver)	–	■	■
- LWL (fiber-optic interface)	With fiber-optic transducer (Outdoor-Box)		
Output signals	K1, K2, K0 + inverted		
Shaft type			
- Cone shaft 1:10	–	$\varnothing 17$ mm	
- Blind hollow shaft	$\varnothing 12...14$ mm	$\varnothing 12...16$ mm	
Connection	Terminals	Terminal box rotatable, flange connector M23	Terminal box rotatable, flange connector M23 or cable
Pulses per revolution	64...2048	512...2500	500...5000
Operating temperature	-20...+85 °C	-40...+100 °C	
Protection	IP 66		
Operating speed	$\leq 10\,000$ rpm		
Max. shaft load	$\leq 30$ N axial, $\leq 40$ N radial	$\leq 350$ N axial, $\leq 450$ N radial	$\leq 350$ N axial, $\leq 450$ N radial
Explosion protection	Ex II 3G IIC / 3D IIIC (ATEX)		
Options	–	Corrosion protection C4	Function monitoring EMS Hybrid bearings Redundant (HOG 86M)

## Redundant sensing

Devices with redundant, i.e. double sensing support demanding applications, e.g. where high availability and functional safety are required. Our qualified and experienced experts would be glad to support you in the design of your safety-relevant application and its certification by the notified body.



# HeavyDuty encoders incremental

## Size up to $\varnothing 105$ mm / hollow shaft

With the HOG 86, HOG 9 and HOG 10 series from Hübner Berlin, you have a unique product portfolio at your disposal that combines more than 60 years of experience of the world market leader and the latest technologies to unrivalled robust and durable products.



[www.baumer.com/HD-incremental](http://www.baumer.com/HD-incremental)



Features	<ul style="list-style-type: none"> <li>■ Cone shaft or blind hollow shaft</li> <li>■ Pulses per revolution up to 5000</li> <li>■ Isolated ball bearings</li> </ul>	<ul style="list-style-type: none"> <li>■ Cone shaft or blind hollow shaft</li> <li>■ Pulses per revolution up to 5000</li> <li>■ Hybrid bearings as standard</li> <li>■ Corrosion protection CX (C5-M)</li> </ul>	<ul style="list-style-type: none"> <li>■ Cone shaft or blind hollow shaft</li> <li>■ Corrosion protection CX (C5-M)</li> <li>■ Hybrid bearings as standard</li> <li>■ Protection class IP 67</li> </ul>	<ul style="list-style-type: none"> <li>■ Cone shaft or blind hollow shaft</li> <li>■ Pulses per revolution up to 10 000</li> <li>■ Hybrid bearings as standard</li> </ul>
Product family	HOG 9	HOG 10	HOG 11	HOG 100
Sensing method	Optical			
Size (housing)	$\varnothing 97$ mm	$\varnothing 105$ mm		
Voltage supply	5 VDC $\pm 5$ %, 9...30 VDC		5 VDC $\pm 5$ %, 9...26 VDC, 9...30 VDC	
Output stage				
- TTL/RS422	■	■	■	■
- HTL/push-pull	—	—	—	—
- HTL-P (Power Linedriver)	■	■	■	■
- LWL (fiber-optic interface)	With fiber-optic transducer (Outdoor-Box)			
Output signals	K1, K2, K0 + inverted			
Shaft type				
- Cone shaft 1:10	$\varnothing 17$ mm			
- Through hollow shaft	$\varnothing 12...16$ mm	$\varnothing 12...20$ mm		
Connection	Flange connector M23	Terminal box axial, radial		
Pulses per revolution	300...5000		1024...10 000	
Operating temperature	-30...+100 °C	-40...+100 °C (-50...+100 °C option)		-30...+85 °C
Protection	IP 56	IP 66	IP 67	IP 66
Operating speed	$\leq 10\,000$ rpm	$\leq 6000$ rpm		
Max. shaft load	$\leq 400$ N axial, $\leq 500$ N radial	$\leq 450$ N axial, $\leq 600$ N radial		
Explosion protection	Ex II 3G IIC / 3D IIIC (ATEX)			
Options	Function monitoring EMS	Function monitoring EMS Redundant (HOG 10M)	Function monitoring EMS Redundant (HOG 11M) DNV certificate	Centrifugal switch (FSL) Speed switch (ESL) Redundant (HOG 100M)

## Enhanced Monitoring System EMS

Enhanced Monitoring System EMS in incremental encoders monitors all crucial encoder functionalities throughout the encoder's entire speed range. EMS will signal connection errors and speed up commissioning. During operation, EMS facilitates error tracking and prevents cost-intensive downtime.

# HeavyDuty encoders incremental

## Large hollow shaft

Hollow shaft up to  $\varnothing 75$  mm.

- Precise optical encoders for large drive shafts
- Outstanding high mechanical reserve capacity
- For use in permanently oily-wet environments
- Hybrid bearings as standard



Features	<ul style="list-style-type: none"> <li>■ Through hollow shaft</li> <li>■ Corrosion protection CX (C5-M)</li> <li>■ Integrated lightning protection</li> <li>■ Shaft with special seals for offshore applications</li> </ul>	<ul style="list-style-type: none"> <li>■ Through hollow shaft up to <math>\varnothing 38</math> mm</li> </ul>	<ul style="list-style-type: none"> <li>■ Through hollow shaft</li> <li>■ Rotatable terminal box</li> <li>■ Operating speed up to 6000 rpm</li> <li>■ Pulses per revolution up to 5000</li> </ul>	<ul style="list-style-type: none"> <li>■ Blind hollow shaft</li> <li>■ Surface protection for harsh environments</li> <li>■ Corrosion protection CX (C5-M)</li> <li>■ Protection IP 67</li> <li>■ Pulses per revolution up to 8192</li> </ul>
Product family	HOG 131	HOG 16	HOG 163	HOG 165
Sensing method	Optical			
Size (housing)	$\varnothing 130$ mm	$\varnothing 158$ mm	$\varnothing 158$ mm	$\varnothing 165$ mm
Voltage supply	5 VDC $\pm 5$ %, 9...30 VDC			
Output stage				
- TTL/RS422	■	■	■	■
- HTL-P (Power Linedriver)	■	■	■	■
- LWL (fiber-optic)	With fiber-optic transducer (Outdoor-Box)			
Output signals	K1, K2, K0 + inverted			
Shaft type				
- Through hollow shaft	$\varnothing 16...36$ mm	$\varnothing 20...38$ mm	$\varnothing 38...75$ mm	–
- Blind hollow shaft	–	–	–	$\varnothing 20...38$ mm
Connection	Terminal box		Terminal box rotatable	
Pulses per revolution	1024...3072	250...2500	250...5000	1024...8192
Operating temperature	-40...+100 °C	-40...+100 °C	-40...+85 °C (-50...+100 °C optional)	-40...+100 °C
Protection	IP 56	IP 66	IP 56	IP 67
Operating speed	$\leq 6000$ rpm			
Max. shaft load	$\leq 300$ N axial, $\leq 500$ N radial	$\leq 450$ N axial, $\leq 600$ N radial	$\leq 300$ N axial, $\leq 500$ N radial	$\leq 500$ N axial, $\leq 650$ N radial
Explosion protection	Ex II 3G IIC / 3D IIC (ATEX)			
Options	Redundant (HOG 131M)	Redundant (HOG 16M) Blind hollow shaft Hybrid bearings	Redundant (HOG 163M)	Redundant (HOG 165M) Through hollow shaft Long torque arm Hollow shaft with keyway

## Hybrid bearings

Hybrid bearings consist of a steel race hosting high-strength ceramic balls. Hybrid bearings enable 5 times the service life of conventional steel bearings. In parallel, hybrid bearings provide high-voltage proof isolation of the encoder shaft.

# HeavyDuty encoders incremental

## Large hollow shaft



Through hollow shaft up to  $\varnothing 150$  mm.

- Precise optical encoders for large drive shafts
- Outstanding high mechanical reserve capacity
- Isolated shaft

[www.baumer.com/HD-incremental](http://www.baumer.com/HD-incremental)



Features	<ul style="list-style-type: none"> <li>■ Through hollow shaft up to <math>\varnothing 115</math> mm</li> <li>■ Rotatable terminal box</li> <li>■ Robust light-metal housing</li> <li>■ Pulses per revolution up to 2048</li> </ul>	<ul style="list-style-type: none"> <li>■ Through hollow shaft up to <math>\varnothing 115</math> mm</li> <li>■ Rotatable terminal box</li> <li>■ Robust light-metal housing</li> <li>■ Pulses per revolution up to 4000</li> </ul>	<ul style="list-style-type: none"> <li>■ Through hollow shaft up to <math>\varnothing 150</math> mm</li> <li>■ Plug-in electronics for quick exchange, no need to uninstall</li> <li>■ With crane eye for easy handling</li> </ul>
Product family	HOG 220	HOG 22	HOG 28
Sensing method	Optical		
Size (housing)	$\varnothing 227$ mm		$\varnothing 287$ mm
Voltage supply	5 VDC $\pm 5\%$ , 9...30 VDC		5 VDC $\pm 5\%$ , 9...26 VDC
Output stage			
- TTL/RS422	■	■	■
- HTL-P (Power Linedriver)	■	■	■
- LWL (fiber-optic)	With fiber-optic transducer (Outdoor-Box)		
Output signals	K1, K2, K0 + inverted		
Shaft type			
- Through hollow shaft	$\varnothing 80...115$ mm		$\varnothing 120...150$ mm
Connection	Terminal box radial rotatable		Terminal box radial rotatable, mating connector M23
Pulses per revolution	1024, 2048	720...4000	1024...2048
Operating temperature	-30...+85 °C		
Protection	IP 56	IP 54	IP 56
Operating speed	$\leq 3800$ rpm		$\leq 3600$ rpm
Max. shaft load	$\leq 450$ N axial, $\leq 700$ N radial		$\leq 550$ N axial, $\leq 800$ N radial
Explosion protection	Ex II 3G IIC / 3D IIIC (ATEX)		
Options	Redundant (HOG 220M) Isolated hollow shaft	Redundant (HOG 22M) Protection IP 56 Isolated hollow shaft	Redundant (HOG 28M)

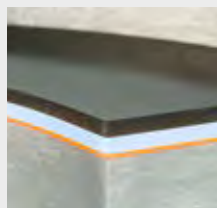

## Outstanding corrosion protection

Thanks to optimized material selection and highly resistant coatings, Baumer encoders and sensors are ideally suited for corrosive environments, for example for permanent outdoor use at sea or in mobile automation. Their corrosion protection is determined by complex salt spray tests and usually corresponds to the highest corrosivity category C5-M (from 2018 CX) based on the EN ISO 12944 standard.

# HeavyDuty encoders incremental

## Sine/Cosine

Solid shaft with EURO flange B10. Blind hollow shaft.

- Precise optical sensing
- Extremely high signal quality



Features	<ul style="list-style-type: none"> <li>■ Solid shaft with EURO flange B10</li> <li>■ Sine periods per revolution up to 5000</li> </ul>	<ul style="list-style-type: none"> <li>■ Blind hollow shaft up to <math>\varnothing 14</math> mm</li> <li>■ High resistance against shocks and vibrations</li> </ul>
Product family	POGS 90	HOGS 71
Sensing method	Optical	
Size (housing)	$\varnothing 115$ mm	$\varnothing 60$ mm
Voltage supply	5 VDC $\pm 10\%$ , 9...30 VDC	
Output stage	-	
- SinCos 1 Vpp	■	■
Output signals	K1, K2, K0 + inverted	
Shaft type	-	
- Solid shaft	$\varnothing 11$ mm	-
- Cone shaft 1:10	-	-
- Blind hollow shaft	-	$\varnothing 12...14$ mm
- Through hollow shaft	-	-
Flange	EURO flange B10	
Connection	Terminal box, rotatable	Connecting terminals in the housing
Sine periods per revolution	720...5000	1024...5000
Operating temperature	-20...+85 °C	
Protection	IP 66	
Operating speed	$\leq 10\,000$ rpm	
Max. shaft load	$\leq 250$ N axial, $\leq 350$ N radial	$\leq 30$ N axial, $\leq 40$ N radial
Explosion protection	Ex II 3G IIC / 3D IIIC (ATEX)	
Options	Second shaft end	-

# HeavyDuty encoders incremental Sine/Cosine

Blind hollow, through hollow or cone shaft.

- Precise optical sensing
- Extremely high signal quality



[www.baumer.com/HD-incremental](http://www.baumer.com/HD-incremental)



Features	■ Cone shaft or blind hollow shaft up to $\varnothing 20$ mm	■ Through hollow shaft up to $\varnothing 75$ mm	■ Through hollow shaft up to $\varnothing 70$ mm ■ Axial torque plate
Product family	HOGS 100	HOGS 14	HOGS 151
Sensing method	Optical		
Size (housing)	$\varnothing 105$ mm	$\varnothing 158$ mm	$\varnothing 168$ mm
Voltage supply	5 VDC $\pm 10\%$ , 9...30 VDC		
Output stage			
- SinCos 1 Vpp	■	■	■
Output signals	K1, K2, K0 + inverted		A+, B+, R+, A-, B-, R-
Shaft type			
- Cone shaft 1:10	$\varnothing 17$ mm	–	–
- Blind hollow shaft	$\varnothing 12...20$ mm	–	–
- Through hollow shaft	–	$\varnothing 40...75$ mm	$\varnothing 60...70$ mm
Connection	Terminal box, rotatable		Round connector, cable
Sine periods per revolution	1024...5000		
Operating temperature	-20...+85 °C		
Protection	IP 66	IP 55	IP 54
Operating speed	$\leq 10\,000$ rpm	$\leq 6300$ rpm	
Max. shaft load	$\leq 450$ N axial, $\leq 600$ N radial	$\leq 150$ N axial, $\leq 200$ N radial	$\leq 350$ N axial, $\leq 500$ N radial
Explosion protection	Ex II 3G IIC / 3D IIIC (ATEX)		
Options	Second shaft end Centrifugal switch (FSL) Speed switch (ESL)	–	–

## LowHarmonics

*LowHarmonics* is leading cutting-edge technology by generating sine signals with negligible harmonic content. Sine encoders with *LowHarmonics* ensure improved control quality, less drive heating and higher energy efficiency.

# HeavyDuty encoders absolute

## Size up to $\varnothing 115$ mm

Solid shaft with EURO flange B10. Hollow shaft or cone shaft.

- Extremely robust design with bearings at both shaft ends
- Highly robust, magnetic singleturn scanning
- Energy self-sufficient *MicroGen* revolution counter
- Additional incremental signals with zero pulse
- Integrated speed switch optional

Programmable via  
Wifi adaptor



Features	<ul style="list-style-type: none"> <li>■ Solid shaft with EURO flange B10</li> <li>■ Corrosion &amp; seawater proof</li> <li>■ Double-sided mounting</li> </ul>	<ul style="list-style-type: none"> <li>■ Solid shaft with EURO flange B10</li> <li>■ Corrosion &amp; seawater proof</li> <li>■ Double-sided mounting</li> <li>■ Programmable</li> </ul>	<ul style="list-style-type: none"> <li>■ Cone shaft or hollow shaft</li> <li>■ Corrosion &amp; seawater proof</li> <li>■ Double-sided mounting</li> </ul>	<ul style="list-style-type: none"> <li>■ Cone shaft or hollow shaft</li> <li>■ Corrosion &amp; seawater proof</li> <li>■ Double-sided mounting</li> <li>■ Programmable</li> </ul>
Product family	PMG 10	PMG 10P	HMG 10	HMG 10P

Interface								
- SSI / SSI + Incremental	■ / ■		■ / ■		■ / ■		■ / ■	
- TTL/RS422 <sup>1)</sup>	■		■		■		■	
- HTL-P (Power Linedriver) <sup>1)</sup>	■		■		■		■	
- Profinet / Profibus-DP	■ / ■		■ / ■		■ / ■		■ / ■	
- EtherCAT / EtherNet/IP	■ / ■		■ / ■		■ / ■		■ / ■	
- CANopen® / DeviceNet	■ / ■		■ / ■		■ / ■		■ / ■	
Function principle	Multiturn	Singleturn	Multiturn	Singleturn	Multiturn	Singleturn	Multiturn	Singleturn
Programmable	-	-	■	■	-	-	■	■
Sensing method	Magnetic							
Size (housing)	$\varnothing 115$ mm				$\varnothing 105$ mm			
Voltage supply	10...30 VDC (SSI 4.75...30 VDC)							
Shaft type								
- Solid shaft	$\varnothing 11$ mm				-			
- Cone shaft 1:10	-				$\varnothing 17$ mm			
- Blind hollow shaft	-				$\varnothing 16...20$ mm			
- Through hollow shaft	-				$\varnothing 16...20$ mm			
Connection	Bus cover, terminal box, mating connector M12 or M23							
Steps per turn	$\leq 1\,048\,576/20$ bits (additional 1...131 072 pulses per revolution)							
Number of turns	$\leq 1\,048\,576/20$ bits	-	$\leq 1\,048\,576/20$ bits	-	$\leq 1\,048\,576/20$ bits	-	$\leq 1\,048\,576/20$ bits	-
Protection	IP 66, IP 67							
Operating temperature	-40...+95 °C (Fieldbus: -40...+85 °C)							
Operating speed	$\leq 12000$ rpm (Fieldbus: $\leq 6000$ rpm)							
Max. shaft load	$\leq 450$ N axial, $\leq 650$ N radial							
Options	Additional incremental signals with zero pulse Integrated speed switch WLAN adapter for easy programming							

1) can be flexibly combined with other interfaces

# HeavyDuty encoders absolute

## Large hollow shaft



[www.baumer.com/HD-absolute](http://www.baumer.com/HD-absolute)



Features	<ul style="list-style-type: none"> <li>■ Through hollow shaft</li> <li>■ Corrosion &amp; seawater proof</li> <li>■ Axial torque plate</li> </ul>
Product family	HMG 161
<b>Interface</b>	
- SSI	■
- Profinet / Profibus-DP	- / ■
- CANopen® / DeviceNet	■ / ■
Function principle	Multiturn   Singleturn
Programmable	-
Sensing method	Optical
Size (housing)	ø160 mm
Voltage supply	9...30 VDC
<b>Shaft type</b>	
- Cone shaft 1:10	-
- Blind hollow shaft	-
- Through hollow shaft	ø38...70 mm
Connection	Bus cover, terminal box
Steps per turn	≤8192/13 bits
Number of turns	≤65 536/16 bits   -
Protection	IP 56
Operating temperature	-20...+85 °C
Operating speed	≤5000 rpm
Max. shaft load	≤350 N axial, ≤500 N radial
Explosion protection	Ex II 3G IIC / 3D IIIC (ATEX)
Options	Additional incremental signals Isolated bearings

## Programming / monitoring

With the compact programming Wifi adapter, you can intuitively parameterise your HeavyDuty encoder HMG 10 and PMG 10 using a PC, tablet or smartphone – even if it is already installed in the system. The monitoring function clearly visualises the current encoder signals, for example during commissioning.



## MicroGen

The patented *MicroGen* revolution counter is the heart of the HeavyDuty absolute encoders. *MicroGen* operates without battery or gears, generating energy straight from the encoder shaft movement. *MicroGen* has been standing the test of time for more than 10 years in tough HeavyDuty applications. Characterized by the principle's simplicity, the encoders are immune against magnetic fields, and combine wear-free operation over a large temperature range with leading edge robustness.

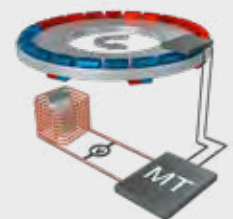

# HeavyDuty speed switches / monitors

## Mechanical / electronic

### Mechanical centrifugal switches or electronic speed switches.

- Mechanical centrifugal switches without auxiliary power supply
- Electronic speed switch, energy-autonomous tacho principle
- Up to three switching outputs
- Solid shaft
- EURO flange B10



Features	<ul style="list-style-type: none"> <li>■ Mechanical centrifugal switch</li> <li>■ Operating temperature max. +130 °C</li> </ul>	<ul style="list-style-type: none"> <li>■ Electronic speed switch</li> <li>■ Speed up to 6000 rpm</li> </ul>	<ul style="list-style-type: none"> <li>■ Electronic speed switch</li> <li>■ 3 outputs</li> </ul>	<ul style="list-style-type: none"> <li>■ Electronic speed switch</li> </ul>
Product family	FS 90	ES 90	ES 93	ES 100
Voltage supply	–	–	–	–
Switching outputs	1 output, speed-controlled	1 output, speed-controlled	3 outputs, speed-controlled	1 output, speed-controlled
Output switching capacity	≤6 A / 230 VAC ≤1 A / 125 VDC	≤6 A / 250 VAC ≤1 A / 48 VDC	–	≤6 A / 250 VAC ≤1 A / 48 VDC
Minimum switching current	50 mA	100 mA	40 mA	100 mA
Size (housing)	ø115 mm			
Shaft type	–			
- Solid shaft	ø11 mm			
Flange	EURO flange B10			
Connection	Terminal box			
Operating temperature	-40...+130 °C		-20...+85 °C	
Protection	IP 55			
Operating speed (n)	≤1.25 x ns	≤6000 rpm	≤5000 rpm	≤500 rpm
Switching speed range (ns) <sup>1</sup>	850...4500 rpm	650...6000 rpm	200...5000 rpm	110...500 rpm
Max. shaft load	≤150 N axial, ≤250 N radial			
Options	Product combination with encoder or tachogenerator			

1) Any selected switching speed as a permanent factory setting



# HeavyDuty speed switches / monitors

## Digital / Stand-alone



### Stand-alone product for outdoor and switchboard.

- Configurable of HTL/TTL, PNP and SinCos signals
- Configurable switching thresholds
- Integrated speed display
- Standard component or safety component certified up to SIL3 / PLe

[www.baumer.com/HD-speed](http://www.baumer.com/HD-speed)



Features	<ul style="list-style-type: none"> <li>■ Configurable speed monitoring</li> <li>■ Outdoor housing</li> <li>■ With speed display</li> </ul>	<ul style="list-style-type: none"> <li>■ Relay modul for DS 93 and encoder with DSL-R</li> <li>■ High switching performance</li> <li>■ DIN rail mount</li> </ul>	<ul style="list-style-type: none"> <li>■ Safe speed monitors with SIL3/PLe certification</li> <li>■ For non-certified incremental encoders / proximity switches</li> <li>■ Inputs SinCos, TTL, HTL, PNP</li> </ul>	<ul style="list-style-type: none"> <li>■ Safe speed monitors with SIL3/PLe certification</li> <li>■ For SIL-certified SinCos encoders</li> <li>■ Inputs SinCos</li> </ul>
Product family	DS 93	DS 93 R	GMM230S, GMM236S	GMM240S, GMM246S
Voltage supply	15...26 VDC	–	18...30 VDC	
Switching outputs	3 outputs, speed-controlled	3 potential-free relay contacts with changeover contact	1 relay-, 1 analog- and 4 control outputs HTL	
Output switching capacity	High: 12 V, Low: 0 V ≤40 mA	≤6 A at 250 VAC or ≤1 A at 48 VC each output	Relay 5...36 V (5 mA...5 A) Analog 4...20 mA (≤270 Ω) HTL (≤30 mA each output)	
Size (housing)	122 x 122 x 80 mm	50 x 75 x 55 mm	50 x 100 x 165 mm	
Connection	Terminals with cable gland	Screw terminal or connector D-SUB		
Operating temperature	-20...+70 °C	-20...+50 °C	-20...+55 °C	
Protection	IP 65	IP 20	IP 20	
Switching speed range (ns)	≤20 000 rpm	≤20 000 rpm	≤500 kHz	
Options	Relay module with 3 potential-free relay contacts (DS 93R)	–	Splitter output SinCos and RS422 Programming unit	

## SAFETY

Mechanical centrifugal switches and electronic speed switches are ideally suited for the simple and fast implementation of safety functions when exceeding or falling below the speed of drives, machines and systems.

The following device types flexibly support the diverse requirements of safety architectures in OEM and retrofit applications:

- Speed switches
- Rotary encoder/speed switch combination
- Rotary encoder with integrated speed switch
- Stand-alone devices for encoder signal evaluation

In the design of your safety-relevant application and its certification by the notified body, our qualified and experienced experts would be glad to support you.

# HeavyDuty speed switches / monitors

## Digital / encoder-integrated

### Incremental encoders with digital speed switch.

- Blind or through hollow shaft
- Space-saving integration into encoder housing
- User-configurable on/off switching speeds
- Up to three switching outputs

Configurable by  
PC software



Features	<ul style="list-style-type: none"> <li>■ Blind hollow shaft</li> <li>■ 2 switching outputs</li> </ul>	<ul style="list-style-type: none"> <li>■ Blind hollow shaft</li> <li>■ 3 switching outputs</li> </ul>	<ul style="list-style-type: none"> <li>■ Through hollow shaft</li> <li>■ 2 switching outputs</li> </ul>	<ul style="list-style-type: none"> <li>■ Through hollow shaft</li> <li>■ 3 switching outputs</li> </ul>
Product family	HOG 10+DSL.E	HOG 10+DSL.R	HOG 165+DSL.E	HOG 165+DSL.R
Sensing method	Optical			
Size (housing)	ø105 mm		ø165 mm	
Voltage supply	9...30 VDC	15...30 VDC	9...30 VDC	15...30 VDC
Output stage				
- TTL/RS422	■	■	■	■
- HTL-P (Power Linedriver)	■	■	■	■
Output signals	K1, K2, K0 + inverted			
Shaft type				
- Blind hollow shaft	ø16 mm		–	–
- Through hollow shaft	–	–	ø25 mm	
Connection	Terminal box			
Pulses per revolution	512...2500		512...4096	
Operating temperature	-30...+85 °C			
Protection	IP 66		IP 67	
Operating speed (n)	≤6000 rpm			
Switching speed range (ns)	3...6000 rpm			
Max. shaft load	≤250 N axial, ≤450 N radial		≤150 N axial, ≤200 N radial	
Switching outputs	2 relay outputs, each with its individual attack value, 1 relay output as control output	3 transistor outputs, each with its individual attack value	2 relay outputs, each with its individual attack value, 1 relay output as control output	3 transistor outputs, each with its individual attack value
Output switching capacity	≤0.25 A at 230 VAC/VDC at each output	High: 12 V, Low: 0 V ≤20 mA	≤0.25 A at 230 VAC/VDC at each output	High: 12 V, Low: 0 V ≤20 mA
Explosion protection	Ex II 3G IIC / 3D IIC (ATEX)			
Options	–	Relay module with 3 potential-free relay contacts (DS 93R)	–	Relay module with 3 potential-free relay contacts (DS 93R)

# HeavyDuty speed switches / monitors

## Digital / encoder-integrated



### Incremental encoders with digital speed switch.

- Solid shaft with EURO flange B10
- Space-saving integration into encoder housing
- User-configurable on/off switching speeds
- Up to three switching outputs

[www.baumer.com/HD-speed](http://www.baumer.com/HD-speed)



Features	<ul style="list-style-type: none"> <li>■ Solid shaft with EURO flange B10</li> <li>■ 2 switching outputs</li> </ul>	<ul style="list-style-type: none"> <li>■ Solid shaft with EURO flange B10</li> <li>■ 3 switching outputs</li> </ul>
Product family	POG 10+DSL.E	POG 10+DSL.R
Sensing method	Optical	
Size (housing)	ø120 mm	
Voltage supply	9...30 VDC	15...30 VDC
Output stage		
- TTL/RS422	■	■
- HTL-P (Power Linedriver)	■	■
Output signals	K1, K2, K0 + inverted	
Shaft type		
- Solid shaft	ø11 mm	
Flange	EURO flange B10	
Connection	Terminal box	
Pulses per revolution	512...2500	
Operating temperature	-30...+85 °C	
Protection	IP 66	
Operating speed (n)	≤6000 rpm	
Switching speed range (ns)	3...6000 rpm	
Max. shaft load	≤300 N axial, ≤450 N radial	
Switching outputs	2 relay outputs, each with its individual attack value, 1 relay output as control output	3 transistor outputs, each with its individual attack value
Output switching capacity	≤0.25 A at 230 VAC/VDC at each output	High: 12 V, Low: 0 V ≤40 mA
Explosion protection	Ex II 3G IIC / 3D IIIC (ATEX)	
Options	–	Relay module with 3 potential-free relay contacts (DS 93R)

# HeavyDuty speed switches / monitors

## Digital / encoder-integrated

Absolute and incremental encoders with digital speed switch.

- Space-saving integration into encoder housing
- User-configurable on/off switching speeds
- Operating temperature -40...+95 °C and corrosion protection CX (C5-M)
- Additional incremental signals with zero pulse



Features	<ul style="list-style-type: none"> <li>■ Solid shaft with EURO flange B10</li> <li>■ 1 switching output</li> </ul>	<ul style="list-style-type: none"> <li>■ Solid shaft with EURO flange B10</li> <li>■ 1 switching output</li> <li>■ Programmable</li> </ul>	<ul style="list-style-type: none"> <li>■ Cone shaft or hollow shaft</li> <li>■ 1 switching output</li> </ul>	<ul style="list-style-type: none"> <li>■ Cone shaft or hollow shaft</li> <li>■ 1 switching output</li> <li>■ Programmable</li> </ul>
Product family	PMG 10D	PMG 10PD	HMG 10D	HMG 10PD

### Interface

- SSI / SSI + Incremental	■ / ■	■ / ■	■ / ■	■ / ■
- TTL/RS422 <sup>1)</sup>	■	■	■	■
- HTL-P (Power Linedriver) <sup>1)</sup>	■	■	■	■
- Profinet / Profibus-DP	■ / ■	■ / ■	■ / ■	■ / ■
- EtherCAT / EtherNet/IP	■ / ■	■ / ■	■ / ■	■ / ■
- CANopen® / DeviceNet	■ / ■	■ / ■	■ / ■	■ / ■

Function principle	Singleturn / Multiturn			
Sensing method	Magnetic			
Size (housing)	ø115 mm		ø105 mm	
Voltage supply	9...30 VDC			
Shaft type				
- Solid shaft	ø11 mm		-	
- Cone shaft 1:10	-		ø17 mm	
- Blind hollow shaft	-		ø16...20 mm	
- Through hollow shaft	-		ø16...20 mm	
Flange	EURO flange B10		-	
Connection	Bus cover, terminal box, mating connector M12 or M23			
Steps per turn	≤1 048 576/20 bits (additional 1...131 072 pulses per revolution)			
Number of turns	≤1 048 576/20 bits			
Protection	IP 66, IP 67			
Operating temperature	-40...+95 °C (Fieldbus: -40...+85 °C)			
Operating speed (n)	≤12 000 rpm (Fieldbus: ≤12 000 rpm)			
Switching speed range (ns)	2...12 000 rpm			
Max. shaft load	≤450 N axial, ≤650 N radial			
Switching outputs	1 transistor output speed controlled			
Output switching capacity	≤100 mA with 30 VDC			
Options	Additional incremental signals Relay output	Additional incremental signals WiFi adaptor for programming	Additional incremental signals Relay output	Additional incremental signals WiFi adaptor for programming

1) can be flexibly combined with other interfaces

# HeavyDuty speed switches / monitors

## Digital / encoder-integrated

Flexible variety.  
Individual configuration.

- Pulses per revolution
- Speed switching limits
- Switching characteristics / hysteresis
- SSI settings of absolute value

EtherCAT

CANopen

EtherNet/IP

DeviceNet

PROFINET

PROFINET

SSI

**HUBNER**  
BERLIN  
A Baumer Brand

[www.baumer.com/HD-speed](http://www.baumer.com/HD-speed)

## Intelligent HeavyDuty encoders

Intelligent HeavyDuty encoders with integrated speed switch provide positions as well as signals for speed detection and speed limitation in harsh environments.

### Advantages

- Fast integration into your application
- Flexible parameterization and convenient monitoring of current signals
- Smartphone, tablet and PC directly connectable via WLAN programming adapter
- Integrated web server for access without software installation



# HeavyDuty tachogenerators

## Tachogenerators

Solid shaft with EURO flange B10.  
Idle voltage up to 200 mV/rpm.

- Ultimate lifetime thanks to *LongLife* commutator with embedded silver track
- Real-time acquisition of speed and rotational direction
- Operating temperature up to +130 °C



Features	■ Solid shaft with EURO flange B10		■ Solid shaft with EURO flange B10, ø85 mm ■ Double tacho with redundant output (TDPZ)		■ Solid shaft with EURO flange B10 ■ Double tacho with redundant output (TDPZ)		■ Solid shaft with EURO flange B10 ■ Double tacho with redundant output (TDPZ)	
Product family	GTF 7.08	GTF 7.16	TDP 0.09	TDPZ 0.09	TDP 0.2	TDPZ 0.2	TDP 13	TDPZ 13
Voltage supply	No							
Size (housing)	ø115 mm		ø85 mm		ø115 mm		ø120...175 mm	
Shaft type	- Solid shaft							
	ø11 mm		ø6 mm		ø7...14 mm		ø14...18 mm	
Flange	EURO flange B10							
Idle voltage	10...60 mV per rpm		10...60 mV per rpm		10...150 mV per rpm		20...100 mV per rpm	
							10...200 mV per rpm	
Performance								
- Speed ≥5000 rpm	0.3 W	0.6 W	–	–	–	–	–	–
- Speed ≥3000 rpm	–	–	1.2 W	2 x 0.3 W	12 W	2 x 0.3 W	–	–
- Speed ≥2000 rpm	–	–	–	–	–	–	40 W	2 x 0.2 W
Rotor moment of inertia	0.4 kgcm <sup>2</sup>	0.6 kgcm <sup>2</sup>	0.25 kgcm <sup>2</sup>	0.29 kgcm <sup>2</sup>	1.1 kgcm <sup>2</sup>	1.2 kgcm <sup>2</sup>	0.4 kgcm <sup>2</sup>	0,6 kgcm <sup>2</sup>
Connection	Connector		Terminal box					
Operating temperature	-30...+130 °C							
Protection	IP 55		IP 56		IP 55			
Operating speed	≤9000 rpm		≤10 000 rpm		≤10 000 rpm		≤6000 rpm	
Max. shaft load	≤150 N axial, ≤250 N radial		≤40 N axial, ≤60 N radial		≤250 N axial, ≤350 N radial		≤80 N axial, ≤100 N radial	
Options	–		–		Sea/tropical climate protection Second shaft end Protection IP 56		–	

## LongLife

*LongLife* technology in HeavyDuty tachogenerators is based on a commutator-embedded silver track which reduces wear virtually to zero. *LongLife* tachogenerators combine very high signal quality for optimum dynamic control with outstanding resilience and unrivalled longevity.



# HeavyDuty tachogenerators

## Tachogenerators

Analog tachogenerators by Baumer stand out by ultra-accurate conversion of tacho voltage throughout the entire speed range. *LongLife* transmission technology contributes a major share.



[www.baumer.com/HD-tacho](http://www.baumer.com/HD-tacho)

# HeavyDuty tachogenerators

## Tachogenerators

Bearingless hollow shaft or cone shaft designs.  
Idle voltage up to 60 mV per rpm.

- Ultimate longevity thanks to *LongLife* commutator with embedded silver track
- Operating temperature up to +130 °C
- Very high accuracy throughout the entire speed range



Features	<ul style="list-style-type: none"> <li>■ Tachogenerator</li> <li>■ Bearingless</li> <li>■ Blind hollow shaft</li> </ul>	<ul style="list-style-type: none"> <li>■ Tachogenerator</li> <li>■ Bearingless</li> <li>■ Blind hollow shaft</li> </ul>	<ul style="list-style-type: none"> <li>■ Tachogenerator</li> <li>■ Bearingless</li> <li>■ Blind hollow shaft</li> </ul>	<ul style="list-style-type: none"> <li>■ Tachogenerator</li> <li>■ Bearingless</li> <li>■ Blind hollow shaft</li> </ul>	<ul style="list-style-type: none"> <li>■ Tachogenerator</li> <li>■ Bearingless</li> <li>■ Blind hollow shaft</li> </ul>	
Product family	GT 5	GT 7.08	GT 7.16	GT 9	GTB 9.06	GTB 9.16
Voltage supply	No					
Size (housing)	ø52 mm	ø85 mm		ø89 mm	ø95 mm	
Shaft type						
- Cone shaft 1:10	–	–		ø17 mm	ø17 mm	
- Blind hollow shaft	ø8...12 mm	ø12...16 mm		ø12...16 mm	ø12...16 mm	
Idle voltage	7...10 mV per rpm	10...60 mV per rpm		10...20 mV per rpm	10...20 mV per rpm	60 mV per rpm
Performance						
- Speed ≥5000 rpm	0.075 W	0.3 W	0.6 W	0.3 W	0.3 W	
Rotor moment of inertia	0.05 kgcm <sup>2</sup>	0.4 kgcm <sup>2</sup>	0.55 kgcm <sup>2</sup>	0.95 kgcm <sup>2</sup>	0.95 kgcm <sup>2</sup>	1.95 kgcm <sup>2</sup>
Connection	Plug-in terminals	Connector		Plug-in terminals	Connector	
Operating temperature	-30...+130 °C					
Protection	IP 20	IP 55		IP 0	IP 68	
Operating speed	≤10 000 rpm	≤9000 rpm				
Options	–	Cable 0.6 m		Protection IP 44 with Protective cover	–	



# HeavyDuty tachogenerators

## Tachogenerators



[www.baumer.com/HD-tacho](http://www.baumer.com/HD-tacho)



Features	<ul style="list-style-type: none"> <li>■ Tachogenerator</li> <li>■ Bearingless</li> <li>■ Blind hollow shaft</li> </ul>	<ul style="list-style-type: none"> <li>■ Tachogenerator</li> <li>■ Blind hollow shaft</li> </ul>
Product family	GTR 9	KTD 4
Voltage supply/frequency	No	
Size (housing)	ø95 mm	ø86 mm
Shaft type		
- Blind hollow shaft	ø16 mm	ø10...16 mm
Idle voltage	20...60 mV per rpm	10...60 mV per rpm
Performance		
- Speed $\geq 5000$ rpm	0.9 W	–
Rotor moment of inertia	1.95 kgcm <sup>2</sup>	600 kgcm <sup>2</sup>
Connection	Connector	Cable, radial
Operating temperature	-30...+130 °C	-15...+100 °C (-30...+100 °C optional)
Protection	IP 56	IP 54
Operating speed	$\leq 9000$ rpm	$\leq 6000$ rpm

# HeavyDuty combinations

## Incremental twin encoders

Two encoders on a common shaft.  
Solid, blind hollow or cone shaft.

- Every encoder with optional redundant sensing
- Integrated function monitoring EMS



Features	<ul style="list-style-type: none"> <li>■ Solid shaft with EURO flange B10</li> <li>■ Speed up to 12 000 rpm</li> </ul>	<ul style="list-style-type: none"> <li>■ Solid shaft with EURO flange B10</li> <li>■ Corrosion protection CX (C5-M)</li> </ul>	<ul style="list-style-type: none"> <li>■ Cone shaft or blind hollow shaft</li> <li>■ Speed up to 10 000 rpm</li> <li>■ Isolated ball bearings</li> </ul>	<ul style="list-style-type: none"> <li>■ Cone shaft or blind hollow shaft</li> <li>■ Corrosion protection CX (C5-M)</li> <li>■ Hybrid ball bearings as standard</li> </ul>
Product family	POG 86 G   POG 9 G	POG 10 G   POG 11 G	HOG 9 G	HOG 10 G   HOG 11 G
Sensing method	Optical			
Size (housing)	ø115 mm		ø97 mm	ø105 mm
Voltage supply	5 VDC ±5 %, 9...30 VDC			
Output stage				
- TTL/RS422	■	■	■	■
- HTL-P (Power Linedriver)	■	■	■	■
Shaft type				
- Solid shaft	ø11 mm	ø11 mm	–	–
- Cone shaft	–	–	ø17 mm	ø17 mm
- Blind hollow shaft	–	–	ø16 mm	ø16...20 mm
Flange	EURO flange B10		–	–
Connection	Terminal box		Flange connector M23	Terminal box
Pulses per revolution	300...5000		300...5000	300...5000
Operating temperature	-40...+100 °C, -25...+100 °C (>3072 ppr)			
Protection	IP 56	IP 66   IP 67	IP 56	IP 66   IP 67
Operating speed	≤12 000 rpm	≤6000 rpm	≤10 000 rpm	≤6000 rpm
Max. shaft load	≤250 N axial, ≤350 N radial	≤300 N axial, ≤450 N radial	≤400 N axial, ≤500 N radial	≤450 N axial, ≤600 N radial
Explosion protection	Ex II 3G IIC / 3D IIC (ATEX)			
Options	Function monitoring EMS	Function monitoring EMS Redundant sensing and two terminal boxes per encoder	Function monitoring EMS	Function monitoring EMS Redundant sensing and two terminal boxes per encoder

## Combinations 1 + 1 = 1

1 + 1 = 1 translates into HeavyDuty product combinations where HeavyDuty encoders, tachogenerators and speed switches are combined into a robust unit. Hence, besides speed feedback, the application may involve more signals for drive regulation. In parallel, HeavyDuty combinations provide different output signals and sharing a common shaft to save space, they excel with ultimate reliability and longevity.

# HeavyDuty combinations Tachogenerators



With mechanical centrifugal switch, electronic speed switch or incremental encoder.

- Energy self-sufficient speed switch thanks to centrifugal force / tacho principle
- Electronic speed switch ESL with 1 or 3 switching outputs
- Mechanical centrifugal switch FSL with one switching output

[www.baumer.com/HD-combi](http://www.baumer.com/HD-combi)



Features	<ul style="list-style-type: none"> <li>■ Tacho generator with mechanical centrifugal switch</li> <li>■ Solid shaft with EURO flange B10</li> </ul>	<ul style="list-style-type: none"> <li>■ Tacho generator with mechanical centrifugal switch</li> <li>■ Solid shaft with EURO flange B10</li> </ul>	<ul style="list-style-type: none"> <li>■ Tacho generator with electronic speed switch</li> <li>■ Solid shaft with EURO flange B10</li> </ul>	<ul style="list-style-type: none"> <li>■ Tacho generator with encoder</li> <li>■ Solid shaft with EURO flange B10</li> </ul>		
Product family	TDP 0,09+FSL	TDP 0,2+FSL	TDPZ 0,2+FSL	TDP 0,2+ESL	TDPZ 0,2+ESL	TDP 0,2+OG9
Sensing method	Optical					
Size (housing)	ø85 mm		ø115 mm			
With centrifugal switch	■	■	-		-	
With speed switch	-		■		-	
Voltage supply	No		No		12 VDC ±10 % (only TDP 0.2 +ESL 93)	
Idle voltage	10...60 mV per rpm	10...150 mV per rpm	0...100 mV per rpm	10...150 mV per rpm	20...100 mV per rpm	10...150 mV per rpm
Performance (Speed >3000 rpm)	1.2 W	12 W	2 x 3 W	12 W	2 x 3 W	12 W
Shaft type	- Solid shaft					
- Solid shaft	ø6 mm	ø7...14 mm		ø7...14 mm		ø11 mm
Flange	EURO flange B10					
Connection	Terminal box					
Operating temperature	-30...+130 °C		-30...+130 °C		-25...+85 °C	
	-30...+100 °C -25...+100 °C (>3072 ppr)					
Protection	IP 56		IP 55		IP 55	
Operating speed (n)	≤1.25 x ns		≤1.25 x ns		≤6000 rpm	
Switching speed range (ns) <sup>1</sup>	850...4500 rpm		850...4500 rpm		200...600 rpm	
Max. shaft load	≤40 N axial, ≤60 N radial		≤60 N axial, ≤80 N radial			
Switching outputs (speed-controlled)	1 output		1 output		1 or 3 outputs	
Output circuit	Normally open / Normally closed		Normally open / Normally closed		Transistor outputs: High: 12 V, Low: 0 V ≤40 mA	
Options	-		Redundant output (TDPZ)		Redundant output (TDPZ)	

1) Any selected switching speed as a permanent factory setting

# HeavyDuty combinations

## Incremental encoders with speed switch

### Mechanical centrifugal switch or electronic speed switch.

- Energy self-sufficient speed switch thanks to centrifugal force / tacho principle
- Electronic speed switch ESL with one or three switching outputs
- Mechanical centrifugal switch FSL with one switching output



Features	<ul style="list-style-type: none"> <li>■ Solid shaft with EURO flange B10</li> <li>■ Pulses per revolution 500...5000</li> </ul>	<ul style="list-style-type: none"> <li>■ Solid shaft with EURO flange B10</li> <li>■ Pulses per revolution 300...5000</li> </ul>	<ul style="list-style-type: none"> <li>■ Solid shaft with EURO flange B10</li> </ul>	<ul style="list-style-type: none"> <li>■ Solid shaft with EURO flange B10</li> <li>■ Corrosion protection CX (C5-M)</li> <li>■ For use in salty, oily-wet environments</li> </ul>			
Product family	POG 86+FSL	POG 9+FSL	POG 9+ESL	POG 10+FSL	POG 10+ESL	POG 11+FSL	POG 11+ESL
Sensing method	Optical						
Size (housing)	ø115 mm						
With centrifugal switch	■	■	–	■	–	■	–
With speed switch	–	–	■	–	■	–	■
Voltage supply	5 VDC ±5 %, 9...30 VDC						
Output stage							
- TTL/RS422	■	■		■		■	
- HTL-P (Power Linedriver)	■	■		■		■	
Output signals	K1, K2, K0 + inverted						
Shaft type							
- Solid shaft	ø11 mm						
Flange	EURO flange B10						
Connection	Terminal box						
Pulses per revolution	500...5000		300...5000				
Operating temperature	-30...+100 °C		-30...+100 °C   -20...+85 °C		-40...+100 °C   -25...+85 °C		-40...+100 °C   -25...+85 °C
Protection	IP 56		IP 56		IP 66		IP 67
Operating speed	≤6000 rpm						
Switching speed range (ns) <sup>1)</sup>	850...4500 rpm (FSL), 200...6000 rpm (ESL)						
Max. shaft load	≤300 N axial, ≤450 N radial						
Switching outputs (speed-controlled)	1 output		1 output   1 or 3 outputs		1 output   1 or 3 outputs		1 output   1 or 3 outputs
Output circuit	Norm. open/ Norm. closed		Norm. open/ Norm. closed   Transistor outputs		Norm. open/ Norm. closed   Transistor outputs		Norm. open/ Norm. closed   Transistor outputs
Options	Function monitoring EMS			Function monitoring EMS Redundant sensing			

1) Any selected switching speed as a permanent factory setting

# HeavyDuty combinations

## Incremental encoders with speed switch



### Mechanical centrifugal switch or electronic speed switch.

- Energy self-sufficient speed switch thanks to centrifugal force / tachometer principle
- Electronic speed switch ESL with one or three switching outputs
- Mechanical centrifugal switch FSL with one switching output

[www.baumer.com/HD-combi](http://www.baumer.com/HD-combi)



Features	■ Cone shaft or blind hollow shaft	■ Cone shaft or blind hollow shaft ■ Special sealing against ingress of solids	■ Cone shaft or blind hollow shaft ■ Corrosion protection CX (C5-M) ■ For use in salty, oily-wet environments		
Product family	HOG 86+FSL	HOG 10+FSL	HOG 10+ESL	HOG 11+FSL	HOG 11+ESL
Sensing method	Optical				
Size (housing)	ø99 mm		ø105 mm		
With centrifugal switch	■	■	–	■	–
With speed switch	–	–	■	–	■
Voltage supply	5 VDC ±5 %, 9...30 VDC				
Output stage					
- TTL/RS422	■	■		■	
- HTL-P (Power Linedriver)	■	■		■	
Output signals	K1, K2, K0 + inverted				
Shaft type					
- Cone shaft 1:10	ø17 mm				
- Blind hollow shaft	ø16 mm		ø16...20 mm		
Connection	Terminal box				
Pulses per revolution	500...5000		300...5000		
Operating temperature	-40...+100 °C		-40...+100 °C   -20...+85 °C		-40...+100 °C   -20...+85 °C
Protection	IP 66		IP 66		IP 67
Operating speed	≤6000 rpm				
Switching speed range (ns) <sup>1)</sup>	850...4500 rpm		850...4500 rpm (FSL) 200...6000 rpm (ESL)		850...4500 rpm (FSL) 200...6000 rpm (ESL)
Max. shaft load	≤350 N axial, ≤450 N radial		≤450 N axial, ≤600 N radial		
Switching outputs (speed-controlled)	1 output		1 output   1 or 3 outputs		1 output   1 or 3 outputs
Output circuit	Norm. open/ Norm. closed		Norm. open/ Norm. closed   Transistor outputs		Norm. open/ Norm. closed   Transistor outputs
Options	Function monitoring EMS Redundant sensing				

# Durable and space-saving.



Bearingless incremental encoder:  
MIR 10



## Non-contact, wear-free and compact.

Bearingless encoders by Baumer operate on the non-contact method, most utilize magnetic sensing and virtually all are free from wear. No dust, dirt or condensation will impair their reliable operation. They even withstand harmful fibres dominating any environment in the textile industry. Our bearingless encoders are particularly resistant to shocks and vibrations with a virtually unlimited service life.

Forgoing any mechanical components prone to wear, these encoders master also highspeed applications. The portfolio comprises incremental encoders with square wave and sinusoidal signals as well as absolute product variants with most common interfaces.

## Easy integration - reduced overall costs

Their extremely shallow installation depth, some designs merely 10 mm, make bearingless encoders with ring magnet and sensor an ideal solution where installation space is very limited – whether on shafts with 6 or 600 mm diameter. The narrow ring magnet and the lean sensor head even allow for attachment to the A-end of the shaft, for example between gearing and the machine part to be driven.

# Bearingless encoders

## Incremental

Hollow shaft up to  $\varnothing 150$  mm.  
Up to 8192 pulses per revolution.

- Square wave and SinCos signals
- Wear-free operation
- Small mounting depth for easy integration
- Immunity against dust, dirt, fibres and fluids



Features	<ul style="list-style-type: none"> <li>■ Through hollow shaft up to <math>\varnothing 43.5</math> mm</li> <li>■ Up to 1024 ppr</li> </ul>	<ul style="list-style-type: none"> <li>■ Through hollow shaft up to <math>\varnothing 43.5</math> mm</li> <li>■ Up to 4096 ppr</li> <li>■ Metal die cast housing</li> </ul>	<ul style="list-style-type: none"> <li>■ Through hollow shaft up to <math>\varnothing 45</math> mm</li> <li>■ Up to 50 ppr</li> </ul>	<ul style="list-style-type: none"> <li>■ Through hollow shaft up to <math>\varnothing 28</math> mm</li> <li>■ Up to 2048 ppr</li> </ul>
Product family	MDFK 08	MIR 10	ITD 67	ITD49H   ITD49H Sine
Sensing method	Magnetic			
Magnetic wheel diameter	$\varnothing 30.5 \dots 56$ mm	$\varnothing 30.5 \dots 56$ mm	$\varnothing 72$ mm	$\varnothing 40$ mm
Mount magnetic wheel	Radial screw connection			Hot shrinking, stick, radial screw connection
Dimensions (sensor head)	15 x 8.5 x 45.5 mm	10 x 15 x 45.5 mm	20 x 11 x 75 mm	12 x 16 x 48 mm
Voltage supply	8...30 VDC 5 VDC $\pm 5$ %	10...30 VDC 5 VDC $\pm 5$ %	8...26 VDC	5 VDC $\pm 5$ % 8...26 VDC   5 VDC $\pm 10$ %
Output stage				
- TTL/RS422	■	■	–	■   –
- HTL/push-pull	■	■	■	■   –
- SinCos 1 Vpp	–	–	–	–   ■
Output signals	A 90° B, R + inverted	A 90° B, R + inverted	A, B	A 90° B, R / A 90° B, R + inv.
Output frequency	$\leq 250$ kHz	$\leq 350$ kHz	$\leq 160$ kHz	$\leq 300$ kHz (TTL)   $\leq 180$ kHz $\leq 160$ kHz (HTL)
Shaft type				
- Through hollow shaft	$\varnothing 6 \dots 43.5$ mm	$\varnothing 6 \dots 43.5$ mm	$\varnothing 10 \dots 45$ mm	$\varnothing 9 \dots 28$ mm
Connection				
- Cable	Tangential			
Pulses per revolution	256...1024	320...4096	20, 50	64...2048   –
Sine periods per revolution	–	–	–	–   64
Operating temperature	-25...+85 °C	-40...+85 °C	-20...+85 °C	-40...+100 °C
Protection	IP 67	IP 66, IP 67	IP 67	IP 67
Operating speed	$\leq 20\,000$ rpm	$\leq 20\,000$ rpm	$\leq 10\,000$ rpm	$\leq 30\,000$ rpm
Options	Cable with pre-assembled connector Several mounting options Magnetic shields Redundant sensing of a magnetic wheel with two sensing heads			



# Bearingless encoders

## Incremental

Bearingless encoders by Baumer operate on non-contact sensing technology and are virtually wearfree. They withstand shocks and vibrations and are ideal for applications where space is tight.

[www.baumer.com/bearingless](http://www.baumer.com/bearingless)



Features	<ul style="list-style-type: none"> <li>Through hollow shaft up to <math>\varnothing 65</math> mm</li> <li>Up to 4095 ppr</li> </ul>	<ul style="list-style-type: none"> <li>Through hollow shaft up to <math>\varnothing 150</math> mm</li> <li>Up to 8192 ppr</li> </ul>		
Product family	ITD69H	ITD69H Sine	ITD89H	ITD89H Sine
Sensing method	Magnetic			
Magnetic wheel diameter	$\varnothing 81$ mm		$\varnothing 162$ mm	
Mount magnetic wheel	Hot shrinking, stick, radial screw connection		Hot shrinking, stick	
Dimensions (sensor head)	12 x 16 x 48 mm			
Voltage supply	5 VDC $\pm 5$ % 8...26 VDC	5 VDC $\pm 10$ %	5 VDC $\pm 5$ % 8...26 VDC	5 VDC $\pm 10$ %
Output stage				
- TTL/RS422	■	–	■	–
- HTL/push-pull	■	–	■	–
- SinCos 1 Vpp	–	■	–	■
Output signals	A 90° B, R / A 90° B, R + inverted			
Output frequency	$\leq 300$ kHz (TTL) $\leq 160$ kHz (HTL)	$\leq 180$ kHz	$\leq 300$ kHz (TTL) $\leq 160$ kHz (HTL)	$\leq 180$ kHz
Shaft type				
- Through hollow shaft	$\varnothing 40...65$ mm		$\varnothing 70...150$ mm	
Connection				
- Cable	Tangential			
Pulses per revolution	128...4096	–	256...8192	–
Sine periods per revolution	–	128	–	256
Operating temperature	-40...+100 °C			
Protection	IP 67			
Operating speed	$\leq 15\,000$ rpm		$\leq 7\,500$ rpm	
Options	Cable with pre-assembled connector Several mounting options Magnetic shields Redundant sensing of a magnetic wheel with two sensing heads			

## Redundant sensing

To increase the availability and safety of your application, redundant sensing of one magnetic pole wheel with two sensing heads can be applied.

In the design of your safety-relevant application and its certification by the notified body, our qualified and experienced experts would be glad to support you.

# Bearingless encoders

## Incremental

Hollow shaft up to  $\varnothing 740$  mm.  
Up to 32 768 pulses per revolution.

- Square wave and SinCos signals
- Wear-free operation and wide axial tolerance  $\pm 3$  mm
- Pole wheel fixation by screwing, stretching, gluing or shrinking



*HDmag*



Features	<ul style="list-style-type: none"> <li>■ Through hollow shaft <math>\varnothing 16 \dots 80</math> mm</li> <li>■ Installation depth <math>\leq 40</math> mm</li> <li>■ Stainless steel wheel</li> </ul>	<ul style="list-style-type: none"> <li>■ Through hollow shaft <math>\varnothing 50 \dots 180</math> mm</li> <li>■ Installation depth <math>\leq 40</math> mm</li> <li>■ Stainless steel wheel</li> </ul>	<ul style="list-style-type: none"> <li>■ Through hollow shaft <math>\varnothing 70 \dots 340</math> mm</li> <li>■ Installation depth <math>\leq 40</math> mm</li> <li>■ Stainless steel wheel</li> </ul>	<ul style="list-style-type: none"> <li>■ Through hollow shaft <math>\varnothing 650 \dots 740</math> mm</li> <li>■ Installation depth <math>\leq 40</math> mm</li> </ul>
Product family	MHGE 100	MHGE 200	MHGE 400	MHGE 800
Sensing method	Magnetic			
Magnetic wheel diameter	$\varnothing 99.9$ mm	$\varnothing 201.7$ mm	$\varnothing 405.4$ mm	$\varnothing 813$ mm
Dimensions (sensor head)	100 x 40 x 65 mm			
Voltage supply	Rectangular: 4.75...30 VDC, Sine: 5 VDC			
Output stage				
- TTL/RS422	■	■	■	■
- HTL/push-pull	■	■	■	■
- SinCos 1 Vpp	■	■	■	■
Output signals	A 90° B, R + inverted			
Output frequency	$\leq 300$ kHz			
Shaft type				
- Through hollow shaft	$\varnothing 16 \dots 80$ mm	$\varnothing 50 \dots 180$ mm	$\varnothing 70 \dots 340$ mm	$\varnothing 650 \dots 740$ mm
Connection				
- Flange connector M23	Tangential			
- Terminal box	Cable gland M20, tangential			
Pulses per revolution	64...4096	128...8192	256...16 384	512...32 768
Sine periods per revolution	64	128	256	512
Operating temperature	$-40 \dots +100$ °C			
Protection	IP 66, IP 67			
Operating speed	$\leq 8000$ rpm	$\leq 4000$ rpm	$\leq 2000$ rpm	$\leq 1000$ rpm
Options	DNV certificate			DNV certificate Stainless steel wheel

## HDmag

Bearingless *HDmag* encoders are based on the high-resolution scanning of a precision magnetic wheel combined with digital real-time signal processing. *HDmag* encoders are available as incremental and absolute variants, provide outstanding high resolution and fit virtually any shaft diameter.

# Bearingless encoders

## Incremental



Hollow shaft up to  $\varnothing 340$  mm.  
Up to 524 288 pulses per revolution.

- Square wave and SinCos signals
- Wear-free operation and wide axial tolerance  $\pm 3$  mm
- Pole wheel fixation by screwing, gluing or shrinking
- Superb signal quality thanks to FPGA signal processing

[www.baumer.com/bearingless](http://www.baumer.com/bearingless)



Features	<ul style="list-style-type: none"> <li>■ Through hollow shaft <math>\varnothing 16 \dots 80</math> mm</li> <li>■ Installation depth <math>\leq 35</math> mm</li> <li>■ Stainless steel wheel</li> </ul>	<ul style="list-style-type: none"> <li>■ Through hollow shaft <math>\varnothing 50 \dots 180</math> mm</li> <li>■ Installation depth <math>\leq 35</math> mm</li> <li>■ Stainless steel wheel</li> </ul>	<ul style="list-style-type: none"> <li>■ Through hollow shaft <math>\varnothing 70 \dots 340</math> mm</li> <li>■ Installation depth <math>\leq 35</math> mm</li> <li>■ Stainless steel wheel</li> </ul>
Product family	MHGP 100	MHGP 200	MHGP 400
Sensing method	Magnetic		
Magnetic wheel diameter	$\varnothing 99.9$ mm	$\varnothing 201.7$ mm	$\varnothing 405.4$ mm
Dimensions (sensor head)	120 x 30 x 90 mm		
Voltage supply	4.5...30 VDC		
Output stage			
- TTL/RS422	■	■	■
- HTL/push-pull	■	■	■
- SinCos 1 Vpp	■	■	■
Output signals	A 90° B, R + inverted		
Output frequency	$\leq 2$ MHz		
Shaft type			
- Through hollow shaft	$\varnothing 16 \dots 80$ mm	$\varnothing 50 \dots 180$ mm	$\varnothing 70 \dots 340$ mm
Connection			
- Flange connector M23	Tangential		
Pulses per revolution	64...131 072	128...262 144	256...524 288
Sine periods per revolution	8192	16384	32768
Operating temperature	$-20 \dots +85$ °C		
Protection	IP 66, IP 67		
Operating speed	$\leq 8000$ rpm	$\leq 4000$ rpm	$\leq 2000$ rpm

# Bearingless encoders

## Absolute

Compact kit design  $\varnothing 36$  mm and  $\varnothing 58$  mm.  
Singleturn and multiturn variants.

- Analog, SSI, fieldbus and realtime Ethernet interface
- Touchless, wear-free operation
- Immune against dust, dirt, fibres and fluids
- Wide axial tolerance for magnet rotor



MAGRES



Features	<ul style="list-style-type: none"> <li>■ Encoder kit – size <math>\varnothing 36</math> mm</li> </ul>	<ul style="list-style-type: none"> <li>■ Encoder kit – size <math>\varnothing 36</math> mm</li> <li>■ E1 compliant design</li> <li>■ Corrosion protection CX (C5-M)</li> <li>■ ISO 13849 compliant firmware</li> </ul>	<ul style="list-style-type: none"> <li>■ Encoder kit – size <math>\varnothing 58</math> mm</li> </ul>	<ul style="list-style-type: none"> <li>■ Encoder kit – size <math>\varnothing 58</math> mm</li> <li>■ E1 compliant design</li> <li>■ Corrosion protection CX (C5-M)</li> <li>■ ISO 13849 compliant firmware</li> </ul>
Product family	EAM360 Kit	EAM360R Kit	EAM580 Kit	EAM580R Kit

### Interface

- SSI / SSI + Incremental	■ / ■	–	■ / ■	–
- Analog	–	■	–	■
- CANopen®	■	■	■	■
- SAE J1939	–	■	–	■
- Profinet	–	–	■	–
- EtherCAT	–	–	■	–
- EtherNet/IP	–	–	■	–

Function principle	Singleturn / Multiturn			
Sensing method	Magnetic			
Size (housing)	$\varnothing 36$ mm		$\varnothing 58$ mm	
Voltage supply	4.5 ... 30 VDC (CANopen®, SAE J1939, SSI) 8 ... 30 VDC / 14 ... 30 VDC (Analog - type-specific) 10 ... 30 VDC (Ethernet)			

### Shaft type

- Bore magnet rotor	$\varnothing 6$ mm, $\varnothing 8$ mm, $\varnothing 12$ mm
---------------------	-------------------------------------------------------------

### Connection

- Flange connector M12	Radial			
- Flange connector M23	–	–	Radial	–
- Cable	Radial (0.14 mm <sup>2</sup> )	Radial (0.5 mm <sup>2</sup> )	Radial (0.14 mm <sup>2</sup> )	Radial (0.5 mm <sup>2</sup> )

Steps per turn	$\leq 65536/16$ bits			
Number of turns	$\leq 262\ 144/18$ bits			
Operating temperature	-40...+85 °C			
Protection	IP 67			
Operating speed	$\leq 6000$ rpm			
Options	Additional incremental signals (SSI, CANopen®)	Cable with DEUTSCH connector	Additional incremental signals (SSI, CANopen®)	Cable with DEUTSCH connector

Compact kit design  $\varnothing 50$  mm and  $\varnothing 55$  mm.  
Singleturn variants.

- Analog, SSI and CANopen® redundant interface
- Touchless, wear-free operation
- Immune against dust, dirt, fibres and fluids
- Small mounting depth down to 10 mm

[www.baumer.com/bearingless](http://www.baumer.com/bearingless)

MAGRES



Features	<ul style="list-style-type: none"> <li>■ Encoder kit – size <math>\varnothing 50</math> mm</li> <li>■ Integrated interfaces</li> <li>■ Singleturn</li> </ul>	<ul style="list-style-type: none"> <li>■ Encoder kit – size <math>\varnothing 55</math> mm</li> <li>■ Integrated interfaces</li> <li>■ Singleturn</li> </ul>
Product family	EAM500	BMSK 55
<b>Interface</b>		
- SSI	–	■
- Analog	■	–
- CANopen® / redundant	■ / ■	– / –
Function principle	Singleturn	
Sensing method	Magnetic	
Size (housing)	$\varnothing 50$ mm	$\varnothing 55$ mm
Voltage supply	10...30 VDC (CANopen®) 12...30 VDC (Analog) 5 VDC $\pm 5$ % (Analog)	10...30 VDC (on request) 5 VDC $\pm 10$ %
<b>Shaft type</b>		
- Bore of magnet rotor	$\varnothing 5...8$ mm	
Connection	Cable, radial	
Steps per turn	$\leq 4096/12$ bits (Analog) $\leq 16384/14$ bits (CANopen®)	$\leq 4096/12$ bits
Absolute accuracy	$\pm 1.8^\circ$	$\pm 1^\circ$
Operating temperature	$-40...+85$ °C	$-20...+85$ °C
Protection	IP 67	
Operating speed	$\leq 3000$ rpm	$\leq 6000$ rpm

# Bearingless encoders

## Absolute

Hollow shaft up to  $\varnothing 340$  mm. Singleturn variants.

- SSI interface
- Additional square wave and SinCos signals
- Wide axial tolerance  $\pm 3$  mm
- Touchless, wear-free operation
- Immune against dust, dirt, fibres and fluids



HDmag



Features	<ul style="list-style-type: none"> <li>■ Wear-free encoder</li> <li>■ Through hollow shaft <math>\varnothing 30</math> mm</li> </ul>	<ul style="list-style-type: none"> <li>■ Wear-free encoder</li> <li>■ Through hollow shaft <math>\varnothing 16...80</math> mm</li> <li>■ Stainless steel wheel</li> </ul>	<ul style="list-style-type: none"> <li>■ Wear-free encoder</li> <li>■ Through hollow shaft <math>\varnothing 50...180</math> mm</li> <li>■ Stainless steel wheel</li> </ul>	<ul style="list-style-type: none"> <li>■ Wear-free encoder</li> <li>■ Through hollow shaft <math>\varnothing 70...340</math> mm</li> <li>■ Stainless steel wheel</li> </ul>
Product family	MHAD50	MHAP 100	MHAP 200	MHAP 400

### Interface

- SSI	■	■	■	■
- CANopen®	■	–	–	–

Function principle	Singleturn			
--------------------	------------	--	--	--

Sensing method	Magnetic			
----------------	----------	--	--	--

Magnetic wheel diameter	$\varnothing 50$ mm	$\varnothing 101.3$ mm	$\varnothing 203.1$ mm	$\varnothing 406.8$ mm
-------------------------	---------------------	------------------------	------------------------	------------------------

Dimensions (sensor head)	55 x 36 x 20 mm	120 x 30 x 90 mm	120 x 30 x 78 mm	120 x 30 x 78 mm
--------------------------	-----------------	------------------	------------------	------------------

Voltage supply	4.5...30 VDC			
----------------	--------------	--	--	--

### Output stage

- TTL/RS422	■	■	■	■
- HTL/push-pull	■	■	■	■
- SinCos 1 Vpp	–	■	■	■

Output signals	A 90° B + inverted			
----------------	--------------------	--	--	--

### Shaft type

- Through hollow shaft	$\varnothing 30$ mm	$\varnothing 16...80$ mm	$\varnothing 50...180$ mm	$\varnothing 70...340$ mm
------------------------	---------------------	--------------------------	---------------------------	---------------------------

Connection	Flange connector M12, cable	Flange connector M23, tangential		
------------	-----------------------------	----------------------------------	--	--

Pulses per revolution	1024...8192	1...131 072	1...262 144	1...524 288
-----------------------	-------------	-------------	-------------	-------------

Sine periods per revolution	–	1...8192	1...16 384	1...32 768
-----------------------------	---	----------	------------	------------

Operating temperature	-40...+85 °C	-20...+85 °C		
-----------------------	--------------	--------------	--	--

Protection	IP 67	IP 66, IP 67		
------------	-------	--------------	--	--

Operating speed	$\leq 6000$ rpm	$\leq 8000$ rpm	$\leq 4000$ rpm	$\leq 2000$ rpm
-----------------	-----------------	-----------------	-----------------	-----------------

# Bearingless encoders

## For large shaft diameters

Hollow shaft  $\varnothing 3183$  mm. Up to 131 072 pulses per revolution.

- Square wave, SinCos and SSI interface
- Position and speed signals via SSI
- Any shaft diameter as standard
- Wear-free and wide axial tolerance  $\pm 5$  mm
- Radial air gap up to 3 mm



[www.baumer.com/bearingless](http://www.baumer.com/bearingless)

*HDmag flex*



Features	<ul style="list-style-type: none"> <li>■ Incremental magnetic belt encoder</li> <li>■ With adapter wheel</li> <li>■ Pulses per revolution up to 131 072</li> <li>■ For shaft <math>\varnothing 90 \dots 300</math> mm</li> </ul>	<ul style="list-style-type: none"> <li>■ Incremental magnetic belt encoder</li> <li>■ Pulses per revolution up to 131 072</li> <li>■ For shaft <math>\varnothing 300 \dots 3183</math> mm</li> </ul>	<ul style="list-style-type: none"> <li>■ Quasi-absolute magnetic belt encoder</li> <li>■ With adapter wheel</li> <li>■ Resolution up to 24 bits singleturn</li> <li>■ For shaft <math>\varnothing 90 \dots 300</math> mm</li> </ul>	<ul style="list-style-type: none"> <li>■ Quasi-absolute magnetic belt encoder</li> <li>■ Resolution up to 24 bits singleturn</li> <li>■ For shaft <math>\varnothing 300 \dots 3183</math> mm</li> </ul>
Product family	MIR 350F	MIR 3000F	MQR 350F	MQR 3000F
Sensing method	Magnetic			
Dimensions (sensor head)	165 x 25 x 93 mm			
Voltage supply	4.75...30 VDC			
Output stage				
- TTL/RS422	■	■	■	■
- HTL/push-pull	■	■	■	■
- SinCos 1 Vpp	■	■	■	■
- SSI	–	–	Linedriver RS485	
Output signals	A 90° B, R + inverted		0...24 bits singleturn 0...24 bits speed signal	
Shaft type				
- Magnetic belt	$\varnothing 90 \dots 300$ mm	$\varnothing 300 \dots 3183$ mm	$\varnothing 90 \dots 300$ mm	$\varnothing 300 \dots 3183$ mm
Connection	Flange connector M23, tangential			
Pulses per revolution	512...131 072		1024...4096	
Sine periods per revolution	512...16 384		1024...4096	
Operating temperature	-40...+85 °C			
Protection sensing head	IP 67	IP 66, IP 67	IP 67	IP 66, IP 67
Operating speed	$\leq 2000$ rpm	$\leq 1850$ rpm	$\leq 2000$ rpm	$\leq 1850$ rpm
Options	–	–	Additional incremental signals	

## *HDmag flex*

*HDmag flex* magnetic belt encoders operate on the proven *HDmag* technology. The sensor head will fit any shaft diameter thanks to both sensing elements being permanently aligned in the factory. The magnetic scale is buckled on the shaft like a belt. *HDmag flex* magnetic belt encoders are characterized by short lead times, easy installation with wide axial and radial tolerances, outstanding robustness and reliability for precise position and speed feedback with ultimate resolution.

# Bearingless encoders

## Analog magnetic rotary encoders

Cylindrical design. Angular range 120...360°.

- Linearized analog output signals
- Resolution up to 0.09°
- With magnet rotor
- Absolute sensing

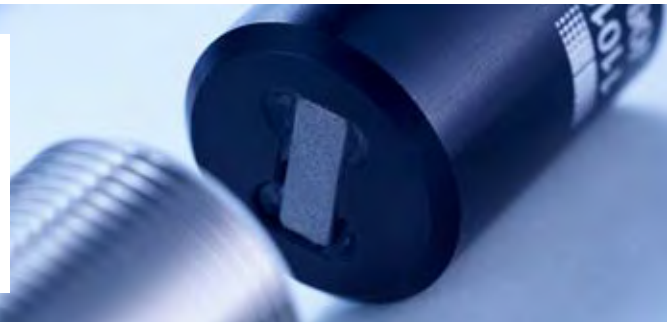

Features	<ul style="list-style-type: none"> <li>■ Linear angular range 120°</li> <li>■ Output signal 4...20 mA</li> </ul>	<ul style="list-style-type: none"> <li>■ Linear angular range 270°</li> <li>■ Output signal 4...20 mA</li> </ul>	<ul style="list-style-type: none"> <li>■ Linear angular range 160°</li> <li>■ Output signal 0.5...4.5 VDC / 1...9 VDC</li> </ul>	<ul style="list-style-type: none"> <li>■ Linear angular range 360°</li> <li>■ Output signal 0...4.3 VDC / 0...5 VDC</li> </ul>		
Product family	MDRM 18	MDRM 18	MDRM 18	MDRM 18	MDRM 18	MDRM 18
Dimensions (sensor head)	M18 x 1 (cylindrical threaded)					
Angular range	120° linear	270° linear		160° linear	360° linear	
Resolution	0.09°	0.09°	1.41°	0.09°	0.09°	1.41°
Working distance max.	5 mm (with magnet rotor MSFS)	5 mm (with magnet rotor MSFS)	4 mm (with magnet rotor MSFS)	5 mm (with magnet rotor MSFS)	5 mm (with magnet rotor MSFS)	4 mm (with magnet rotor MSFS)
Output circuit	Current output			Voltage output		
Output signal	4...20 mA			0.5...4.5 VDC 1...9 VDC	0...4.3 VDC	0...5 VDC
Response time	<2 ms					
Connection	Cable 2 m Mating connector M12	Cable 2 m Connector M12		Cable 2 m Mating connector M8	Cable 2 m Connector M12	
Voltage supply	15...30 VDC			5 VDC 12...28 VDC	4.7...7.5 VDC	4.75...5.25 VDC
Operating temperature	-40...+85 °C					
Protection	IP 67					

## Functional principle

The heart of a magnetic angle sensor is the integrated dual differential Hall element which builds an electrical parameter related to the flux direction of an exterior magnetic field. This magnetic field rotating about the element's center axis generates two sinusoids shifted by 90° which are utilized to detect the rotation angle for output as an absolute value. The integrated electronics evaluates the sinusoids into a linear voltage or current signal. The absolute detection principle ensures output of the correct rotation angle even after power failure.



# Bearingless encoders

## Analog magnetic rotary encoders

Rectangular design. Angular range 270...360°.

- Linearized analog output signals
- Resolution up to 0.09°
- With magnet rotor
- Absolute sensing

[www.baumer.com/bearingless](http://www.baumer.com/bearingless)



Features	<ul style="list-style-type: none"> <li>■ Linear angular range 270°</li> <li>■ Output signal 4...20 mA</li> <li>■ Resolution 0.09°</li> </ul>	<ul style="list-style-type: none"> <li>■ Linear angular range 270°</li> <li>■ Output signal 4...20 mA</li> <li>■ Resolution 1.41°</li> </ul>	<ul style="list-style-type: none"> <li>■ Linear angular range 360°</li> <li>■ Output signal 0...4.3 VDC</li> <li>■ Resolution 0.09°</li> </ul>	<ul style="list-style-type: none"> <li>■ Linear angular range 360°</li> <li>■ Output signal 0...5 VDC</li> <li>■ Resolution 1.41°</li> </ul>
Product family	MDFM 20	MDFM 20	MDFM 20	MDFM 20
Dimensions (sensor head)	20 × 30 × 8 mm (rectangular)			
Angular range	270° linear		360° linear	
Resolution	0.09°	1.41°	0.09°	1.41°
Working distance max.	5 mm (with magnet rotor MSFS)	4 mm (with magnet rotor MSFS)	5 mm (with magnet rotor MSFS)	4 mm (with magnet rotor MSFS)
Output circuit	Current output		Voltage output	
Output signal	4...20 mA		0...4.3 VDC	0...5 VDC
Response time	<4 ms			
Connection	Cable 2 m Mating connector M8			
Voltage supply	15...30 VDC		4.7...7.5 VDC	4.75...5.25 VDC
Operating temperature	-40...+85 °C			
Protection	IP 67			

Bare your teeth.



Hall sensor MHRM18

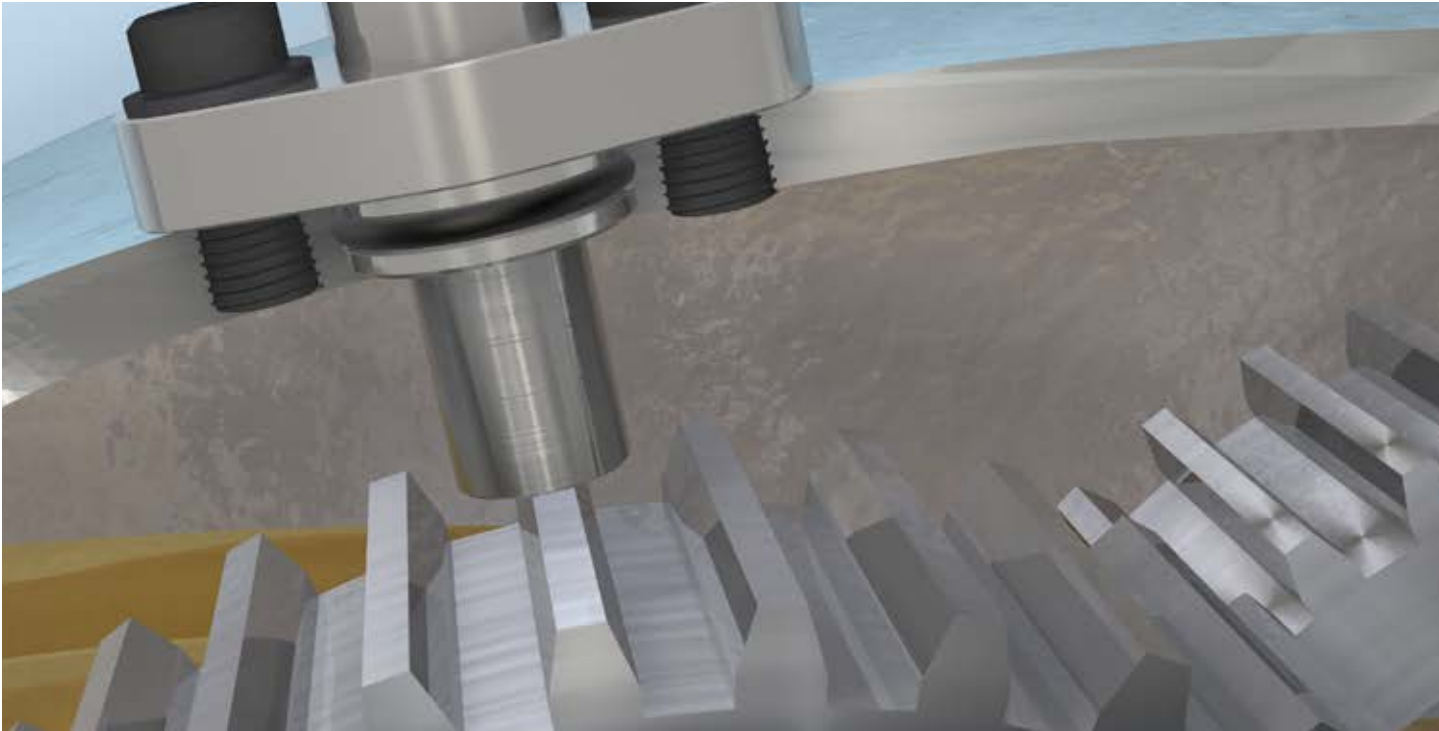

## Non-contact and wear-free detection

Thanks to their high switching frequency of up to 20 kHz, hall sensors are preferred for the measurement and monitoring of speeds, velocities and positions of fast-rotating gears. Thanks to their high resolution, gear teeth can be reliably detected even from module size 1. Thanks to two phase shifted signals, the direction of rotation can be determined in addition to the speed.

Since hall sensors do not require any moving mechanical elements, wear is minimized and the service life is considerably extended. In a full metal housing, they are ideally suited for use in dirty, humid or oily environments.

# Hall / speed sensors

## Size up to 18 mm. Incremental.

- Scanning of gear wheels from module 1
- High switching frequency up to 20 kHz
- For dirty, humid and oily environments
- Wide temperature range up to +120 °C



Features	<ul style="list-style-type: none"> <li>■ Cylindrical design M12</li> <li>■ 1-channel push-pull output</li> <li>■ High switching frequency</li> <li>■ Large temperature range</li> </ul>	<ul style="list-style-type: none"> <li>■ Cylindrical design M12</li> <li>■ 2-channel push-pull output</li> <li>■ Detection of speed and rotational direction</li> <li>■ High protection class and pressure resistance</li> <li>■ Wide temperature range up to +120 °C</li> </ul>	<ul style="list-style-type: none"> <li>■ Cylindrical design M12</li> <li>■ 1-channel PNP output</li> <li>■ High degree of protection and pressure resistance</li> <li>■ Wide temperature range up to +120 °C</li> </ul>	<ul style="list-style-type: none"> <li>■ Cylindrical design M18</li> <li>■ 1-channel PNP output</li> <li>■ Wide temperature range up to +120 °C</li> </ul>
Product family	MHRM 12 - 1 channel	MHRM 12 - 2 channels	IHRM 12 - 1 channel	MHRM 18 - 1 channel
Dimensions (sensor head)	M12 x 1 (cylindrical threaded)			M18 x 1 (cylindrical threaded)
Housing length	50 mm, 60 mm	60 mm		
Switching frequency	0...15 kHz		1...20 kHz	
Gear size	From module 1			
Gear width	>6 mm			
Operating distance max.	0.7 mm (module 1) 2.4 mm (module 3)		1 mm (module 1) 2.5 mm (module 3)	0.7 mm (module 1) 1.8 mm (module 2)
Output signal A	Push-pull	Push-pull	PNP	PNP
Output signal B	–	Push-pull	–	–
Connection	Cable, connector	Cable	Cable, mating connector M12	Cable
Housing material	Brass nickel plated		Chrome-nickel steel	
Operating temperature	-40...+85 °C		-40...+120 °C	-40...+120 °C (-25...+75 °C)
Protection (sensing face)	IP 67		IP 68	
Protection (sensor)	IP 67			

## Robust speed measurement

Hall sensors operate on non-contact sensing of ferromagnetic objects. Thanks to very high switching frequencies they are even capable of detecting the teeth at fast rotating gears. Space-saving and extremely robust, they provide eased speed feedback.

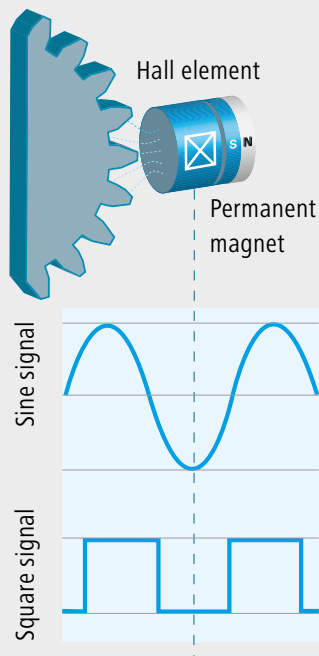

## Functional principle

Hall sensors operate on a current-carrying semiconductor which is biased by a permanent magnet installed behind. This magnetic field being penetrated by a ferromagnetic object causes the semiconductor to change voltage, which is transformed by the integrated electronics into an amplified square signal.

# Unlimited possibilities.



Incremental encoder EIL580P  
with handheld programming tool

# Programmable encoders



## Less variants – lower storage costs

The Baumer portfolio of programmable encoders is unique and offers the right solution for every application. Sophisticated encoder designs optimized for quick availability reduce downtime to a minimum by ultimate robustness and longevity. Extremely versatile, they break new ground in terms of commissioning, service and maintenance.

Easy and intuitive programming solutions by Baumer enable staff of any experience level to start immediately. Convenient handling speeds up commissioning.

According to the product variant, the encoders can be intuitively configured using the handheld programming tool, a PC, tablet or smartphone - even if the encoder is already installed in the system. Convenient parameter download simplifies documentation and encoder integration.

Whether as end customer, system integrator, maintenance technician or wholesaler - thanks to configuration flexibility few variants will suffice in your application. This will not only speed up your processes but in parallel significantly cut down on inventory costs.

# Programmable encoders

## Size $\varnothing 58$ mm

Precise optical or magnetic sensing.  
Up to 131 072 pulses per revolution.

- Easy programming by software and handheld tool
- Solid shaft, blind or through hollow shaft
- Adjustable level of the electrical interface (HTL or TTL)



Features	<ul style="list-style-type: none"> <li>■ Industrial encoder</li> <li>■ Solid shaft with clamping flange</li> </ul>	<ul style="list-style-type: none"> <li>■ Industrial encoder</li> <li>■ Solid shaft with synchro flange</li> </ul>	<ul style="list-style-type: none"> <li>■ Industrial encoder</li> <li>■ Blind hollow shaft</li> </ul>	<ul style="list-style-type: none"> <li>■ Industrial encoder</li> <li>■ Through hollow shaft</li> </ul>
Product family	EIL580P-SC	EIL580P-SY	EIL580P-B	EIL580P-T
Configurable parameters	Pulses per revolution, output stage HTL or TTL, zero pulse, signal sequence			
Configuration	PC software / hardware adapter, handheld programming tool			
Sensing method	Optical			
Size (housing)	$\varnothing 58$ mm			
Voltage supply	4.75...30 VDC			
Output stage				
- TTL/RS422	■	■	■	■
- HTL/push-pull	■	■	■	■
Output signals	A 90° B, R + inverted			
Shaft type				
- Solid shaft	$\varnothing 10$ mm	$\varnothing 6$ mm	–	–
- Blind hollow shaft	–	–	$\varnothing 8...15$ mm	–
- Through hollow shaft	–	–	–	$\varnothing 8...15$ mm
Connection				
- Flange connector M23	Radial / axial		Radial	
- Cable	Radial / axial / tangential		Radial / tangential	
Pulses per revolution	1...65 536			
Operating temperature	-40...+100 °C			
Protection	IP 65, IP 67			
Operating speed	$\leq 12\,000$ rpm (IP 65) $\leq 6000$ rpm (IP 67)		$\leq 8000$ rpm (IP 65) $\leq 6000$ rpm (IP 67)	
Max. shaft load	$\leq 40$ N axial, $\leq 80$ N radial		–	
Options	Certification ATEX II 3 D, Zone 22 (ExEIL580, ExEIL580P), Square flange 2.5 Inch, EURO-flange B10 (REO-flange), isolated hollow shaft, fix pulse number (EIL580)			



# Programmable encoders

## Size up to $\varnothing 115$ mm

### Flexible variety. Individual configuration.

- Pulses per revolution
- Zero pulse blanking
- Signal level HTL / TTL
- Speed switching limits and switching characteristics

HighRes – up to 131 072 pulses per revolution

[www.baumer.com/programmable](http://www.baumer.com/programmable)



Features	<ul style="list-style-type: none"> <li>■ Industrial encoder</li> <li>■ Through hollow shaft</li> <li>■ Inch dimensions</li> <li>■ Isolated shaft</li> </ul>	<ul style="list-style-type: none"> <li>■ HeavyDuty encoder</li> <li>■ Absolute and incremental signals / speed switch</li> <li>■ Solid shaft with EURO flange B10</li> </ul>	<ul style="list-style-type: none"> <li>■ HeavyDuty rotary encoder</li> <li>■ Absolute and incremental signals / speed switch</li> <li>■ Cone shaft or hollow shaft</li> </ul>
Product family	HS35P	PMG 10P	HMG 10P
Configurable parameters	Pulses per revolution, output stage HTL or TTL, zero pulse	Pulses per revolution, switching speed, SSI settings of absolute output	Pulses per revolution, switching speed, SSI settings of absolute output
Configuration	PC software / hardware adapter, handheld programming tool	WLAN adapter, monitoring function	WLAN adapter, monitoring function
Sensing method	Optical	Magnetic	Magnetic
Size (housing)	$\varnothing 3.15''$ ( $\varnothing 80$ mm)	$\varnothing 115$ mm	$\varnothing 105$ mm
Voltage supply	4.75...30 VDC		
Output stage			
- TTL/RS422	■	■	■
- HTL/push-pull	■	■	■
Output signals	A 90° B, R + inverted	A 90° B, R + inverted	A 90° B, R + inverted
Shaft type			
- Solid shaft	–	$\varnothing 11$ mm	–
- Cone shaft 1:10 mm			$\varnothing 17$ mm
- Blind hollow shaft	–	–	$\varnothing 16...20$ mm
- Through hollow shaft	$\varnothing 0.375...1''$ ( $\varnothing 9.525...25.4$ mm)	–	$\varnothing 16...20$ mm
Connection			
- Terminal box	–	Radial	Radial
- Flange connector M23	–	Radial	Radial
- Flange connector MIL	Radial, 7-/10-pin	–	–
- Cable	Radial	–	–
Pulses per revolution	1...8192	1...131072	1...131072
Operating temperature	-40...+100 °C (-40...+212 °F)	-40...+95 °C	-40...+95 °C
Protection		IP 66, IP 67	IP 66, IP 67
Operating speed	$\leq 5000$ rpm	$\leq 12\,000$ rpm	$\leq 12\,000$ rpm
Max. shaft load	–	$\leq 450$ N axial, $\leq 650$ N radial	–
Options	Fix resolution HTL/TTL up to 80 000 ppr, SinCos up to 5000 periods per revolution	Integrated speed switch Absolute interfaces	Integrated speed switch Absolute interfaces

# Solutions for every scenario.



Absolute encoder / ATEX  
X 700 with bus cover



## SIL, Ex, stainless steel and offshore encoders.

Encoders and sensors for hazardous areas, highly corrosive environments or for applications with functional safety - we are your strong partner if you are facing special challenges.

The worldwide experience and many years of competence of our Baumer experts extends to many fields of application for encoders and sensors, for example electrical drive technology, mobile automation and offshore use on drilling rigs or in wind turbines.

Relevant certificates and type examinations from notified bodies as well as test certificates by renowned organisations such as UL, ATEX, IECEx and DNV stand as proof.

### Certification

Ever-extending IECEx certification of our explosion-protected HeavyDuty incremental encoders ensures compliance to most demanding international safety directives. Hence, the encoders are approved for use throughout all 30 countries supporting the IECEx standard. International certification provides particular benefit to OEMs when exporting their machines and systems.

# For special applications

## Encoders for hazardous environments

Zone 1, 2 | Zone 21, 22 | Class I Division 1, Class 2 Division 1.  
ATEX, IECEx, IEC (UL).

- Size  $\varnothing 58...160$  mm
- Square wave and sine signals
- SSI, CANopen®, Profibus-DP



Features	<ul style="list-style-type: none"> <li>■ Incremental encoder</li> <li>■ Solid shaft with EURO flange B10</li> <li>■ ATEX-/IECEx certification</li> <li>■ SinCos signal with <i>LowHarmonics</i></li> </ul>	<ul style="list-style-type: none"> <li>■ Incremental encoder</li> <li>■ Through hollow shaft</li> <li>■ ATEX-/IECEx certification</li> </ul>	<ul style="list-style-type: none"> <li>■ Incremental encoder</li> <li>■ Solid shaft with clamping or synchro flange</li> <li>■ Blind or through hollow shaft</li> <li>■ ATEX certification</li> </ul>	<ul style="list-style-type: none"> <li>■ Incremental encoder</li> <li>■ Solid shaft with clamping or synchro flange</li> <li>■ Blind or through hollow shaft</li> <li>■ ATEX certification</li> <li>■ Programmable</li> </ul>	
Product family	EEx OG 9	EEx OG 9 S	EEx HOG 161	ExEIL580	ExEIL580P
Sensing method	Optical				
Size (housing)	$\varnothing 120$ mm	$\varnothing 120$ mm	$\varnothing 160$ mm	$\varnothing 58$ mm	$\varnothing 58$ mm
Voltage supply	5 VDC $\pm 5\%$ 9...26 VDC 9...30 VDC	5 VDC $\pm 5\%$ 9...30 VDC	5 VDC $\pm 5\%$ 9...26 VDC 9...30 VDC	5 VDC $\pm 5\%$ 8...30 VDC 4.75...30 VDC	4.75...30 VDC
Output stage					
- TTL/RS422	■	–	■	■	■
- HTL/push-pull	■	–	■	■	■
- SinCos 1 Vpp	–	■	–	–	–
Output signals	K1, K2, K0 + inverted		A 90° B, R + inverted		A 90° B, R + inverted
Shaft type					
- Solid shaft	$\varnothing 11$ mm	–	–	$\varnothing 6$ mm, $\varnothing 10$ mm	$\varnothing 6$ mm, $\varnothing 10$ mm
- Blind hollow shaft	–	–	–	$\varnothing 8...15$ mm	$\varnothing 8...15$ mm
- Through hollow shaft	–	–	$\varnothing 30...70$ mm	$\varnothing 8...15$ mm	$\varnothing 8...15$ mm
Flange	EURO flange B10		–	Clamping/synchro flange	Clamping/synchro flange
Connection					
- Terminal box	Radial		Radial	–	–
- Flange connector M12, M23	–		–	Radial / axial	Radial / axial
- Cable	–		–	Radial / axial / tangential	Radial / axial / tangential
Pulses per revolution	1...5000	–	250...2500	100...5000	1...65 536
Sine periods per revolution	–	1024...2048	–	–	–
Operating temperature	-50...+55°C -40...+55°C -25...+55°C	-20...+55°C	-20...+58°C (IP 56) -20...+66°C (IP 54)	-20...+60°C	-20...+60°C
Protection	IP 56		IP 54, IP 56	IP 65	IP 65
Operating speed	$\leq 5600$ rpm		$\leq 5600$ rpm	$\leq 12\,000$ U/min (+20 °C) $\leq 8000$ U/min (+60 °C)	$\leq 12\,000$ U/min (+20 °C) $\leq 8000$ U/min (+60 °C)
Max. shaft load	$\leq 200$ N axial, $\leq 350$ N radial		$\leq 450$ N axial, $\leq 650$ N radial	ExEIL580-S: $\leq 40$ N axial, $\leq 80$ N radial	ExEIL580P-S: $\leq 40$ N axial, $\leq 80$ N radial
Explosion protection	Ex II 2G (ATEX/IECEx)		Ex II 2G (ATEX/IECEx)	Ex II 3D (ATEX)	Ex II 3D (ATEX)
Options	Cable gland M16, M20, M25x1.5		Cable gland M20x1.5	–	–

# For special applications

## Encoders for hazardous environments

Zone 1, 2 | Zone 21, 22 | Class I Division 1, Class 2 Division 1.  
ATEX, IECEx, IEC (UL).

- Size  $\varnothing 70$  mm
- Square wave and sine signals
- SSI, CANopen®, Profibus-DP



<b>Features</b>	<ul style="list-style-type: none"> <li>■ Incremental encoder</li> <li>■ Solid shaft with clamping flange</li> <li>■ Stainless steel housing</li> <li>■ ATEX certification</li> </ul>	<ul style="list-style-type: none"> <li>■ Absolute encoder</li> <li>■ Solid shaft with clamping flange</li> <li>■ Stainless steel housing</li> <li>■ ATEX certification</li> </ul>	<ul style="list-style-type: none"> <li>■ Absolute encoder</li> <li>■ Solid shaft with clamping flange</li> <li>■ Stainless steel housing</li> <li>■ ATEX certification</li> <li>■ Modular bus cover</li> </ul>	<ul style="list-style-type: none"> <li>■ Absolute encoder</li> <li>■ Solid shaft with clamping flange</li> <li>■ Stainless steel housing</li> <li>■ ATEX certification</li> <li>■ Modular bus cover</li> </ul>
<b>Product family</b>	X 700 - incremental	X 700 - SSI	X 700 - CANopen®	X 700 - Profibus-DP

### Interface

- SSI	–	■	–	–	–	–	–
- CANopen®	–	–	–	■	–	–	–
- Profibus-DP	–	–	–	–	–	–	■
<b>Function principle</b>	Incremental	Multiturn	Singleturn	Multiturn	Singleturn	Multiturn	Singleturn
<b>Sensing method</b>	Optical						
<b>Size (housing)</b>	$\varnothing 70$ mm						
<b>Voltage supply</b>	4.75...30 VDC		10...30 VDC				
<b>Output stages</b>							
- TTL/RS422	■	–	–	–	–	–	–
- HTL/push-pull	■	–	–	–	–	–	–
<b>Output signals</b>	A 90° B, R + inverted		–	–	–	–	–
<b>Shaft type</b>							
- Solid shaft	$\varnothing 10$ mm						
<b>Flange</b>	Clamping flange						
<b>Connection</b>							
- Cable gland	Axial		Axial		Bus cover, radial		Bus cover, radial
<b>Pulses per revolution</b>	5...5000		–		–		–
<b>Steps per turn</b>	–	$\leq 8192/13$ bits	$\leq 16384/14$ bits	$\leq 8192/13$ bits	$\leq 16384/14$ bits	$\leq 8192/13$ bits	$\leq 16384/14$ bits
<b>Number of turns</b>	–	$\leq 4096/12$ bits	–	$\leq 4096/12$ bits	–	$\leq 4096/12$ bits	–
<b>Absolute accuracy</b>	–	$\pm 0.025^\circ$					
<b>Operating temperature</b>	-25...+70 °C		-25...+60 °C				
<b>Protection</b>	IP 67						
<b>Operating speed</b>	$\leq 6000$ rpm						
<b>Max. shaft load</b>	$\leq 60$ N axial, $\leq 50$ N radial						
<b>Explosion protection</b>	Ex II 2D/2G (ATEX)						

# For special applications

## Redundant absolute encoders

Two sensing systems.

For maximum availability and safety.

- Size  $\varnothing 28...58$  mm
- SSI, CANopen®, analog



Features	<ul style="list-style-type: none"> <li>■ Solid shaft with flat mounting flange</li> <li>■ Singleturn</li> <li>■ Redundant sensing and interface</li> </ul>	<ul style="list-style-type: none"> <li>■ Encoder kit – size <math>\varnothing 50</math> mm</li> <li>■ Singleturn</li> <li>■ Corrosion protection CX (C5-M)</li> <li>■ Redundant sensing and interface</li> </ul>	<ul style="list-style-type: none"> <li>■ Solid shaft or hollow shaft</li> <li>■ E1 compliant design</li> <li>■ Corrosion protection CX (C5-M)</li> <li>■ ISO 13849 compliant firmware</li> <li>■ Two-channel architecture</li> </ul>
Product family	EAM280	EAM500	EAM580R

### Interface

- Analog / redundant	■ / ■	■ / ■	–	
- CANopen® / redundant	■ / ■	■ / ■	■ / ■	
Function principle	Singleturn	Singleturn	Multiturn	Singleturn
Sensing method	Magnetic			
Size (housing)	$\varnothing 28.6$ mm	$\varnothing 50$ mm	$\varnothing 58$ mm	
Voltage supply	10...30 VDC (CANopen®), 12...30 VDC (Analog) 5 VDC $\pm 5\%$ (Analog)		10...30 VDC	

### Shaft type

- Solid shaft	$\varnothing 6$ mm	–	$\varnothing 6$ mm / $\varnothing 10$ mm	
- Blind hollow shaft	–	–	$\varnothing 10...15$ mm	
- Ring magnet bore	–	$\varnothing 5...8$ mm	–	
Connection	Flange connector M12, cable	Cable	Flange connector M12, cable	
Total resolution	$\leq 12$ bits (Analog) / $\leq 14$ bits (CANopen®)		$\leq 32$ bits	$\leq 16$ bits
Steps per turn	4096/12 bits (Analog) / 16384/14 bits (CANopen®)		16384/14 bits	65536/16 bits
Number of turns	–	–	$\leq 262144/18$ bits	–
Absolute accuracy	$\pm 1.8^\circ$	$\pm 1.8^\circ$	Up to $\pm 0.15^\circ$	
Operating temperature	$-40...+85^\circ\text{C}$		$-40...+85^\circ\text{C}$	
Protection	IP 65	IP 67	IP 67	
Operating speed	$\leq 800$ rpm	$\leq 3000$ rpm	$\leq 6000$ rpm	
Max. shaft load	$\leq 10$ N axial, $\leq 10$ N radial	–	$\leq 40$ N axial, $\leq 80$ N radial	

## Functional safety with standard components

An efficient and economic implementation of functional safety applications with standard components in the sense of the Machinery Directive is possible under certain pre-conditions. In the design of your safety-relevant application and its certification by the notified body, our qualified and experienced experts would be glad to support you.

# For special applications SIL encoders incremental

With SIL2 and SIL3 certificate.  
For quick implementation of your system concepts.

- Safe rotary encoders
- Square wave and SinCos signals



Features	<ul style="list-style-type: none"> <li>■ Incremental encoders</li> <li>■ Solid shaft with clamping or synchro flange</li> <li>■ SIL2 certification</li> </ul>	<ul style="list-style-type: none"> <li>■ Sine encoders</li> <li>■ Through hollow shaft</li> <li>■ SIL2/SIL3 certification</li> </ul>	<ul style="list-style-type: none"> <li>■ Sine encoders</li> <li>■ Cone shaft</li> <li>■ Blind hollow shaft</li> <li>■ PLd/SIL2 certification</li> </ul>	<ul style="list-style-type: none"> <li>■ SIL3/PLe certification</li> <li>■ For certified and non-certified encoders</li> <li>■ Safety-related splitter output</li> </ul>
Product family	EIL576S-S	EIL576S-T	HOGS 100S	GMM230S, GMM240S
Sensing method	Optical			–
Size (housing)	ø58 mm	ø58 mm	ø105 mm	50 x 100 x 165 mm
Voltage supply	24 VDC +20/-50 %	5 VDC ±10 %	5 VDC ±10 %, 7...30 VDC	18...30 VDC
Output stage				
- TTL/RS422	■	–	–	■
- HTL/push-pull	■	–	–	■
- SinCos 1 Vpp	–	■	■	–
Output signals	A 90° B + inverted	A, B, R	K1, K2, K0 + inverted	A 90° B + inverted
Switching outputs	–	–	–	1 relay, 1 analog and 4 control output HTL
Output switching capacity	–	–	–	Relay 5...36 V (5 mA...5 A) Analog 4...20 mA (≤270 Ω) HTL (≤30 mA per output)
Shaft type				
- Cone shaft 1:10	–	–	ø17 mm	–
- Solid shaft	ø6 mm / ø10 mm	–	–	–
- Blind hollow shaft	–	–	ø16 mm	–
- Through hollow shaft	–	ø10...14 mm	–	–
Connection	Flange connector M12, M23	Cable	Terminal box	Plug-in screw or connector D-SUB
Pulses per revolution	5...5000	–	–	–
Sine periods per revolution	–	1024, 2048	1024...5000	–
Operating temperature	-25...+85 °C	-30...+100 °C	-25...+85 °C	-20...+55 °C
Protection	IP 54 (without shaft seal) IP 65 (with shaft seal)	IP 65	IP 66	IP 20
Operating speed	≤10 000 rpm	≤6000 rpm	≤10 000 rpm	≤500 kHz
Max. shaft load	≤20 N axial, ≤40 N radial	–	≤250 N axial, ≤400 N radial	–
Certification	SIL2 according to DIN EN 61508	SIL2 or SIL3 compliant in redundant use	PLd/SIL2 certification	PLe EN ISO 13849-1, SIL3 EN 61508, EN 6206
Other	–	For use with SIL3 / PLe-certified motion monitors GMM240S / GMM246S		Programming unit

# For special applications

## Stainless steel encoders / incremental

Housing V2A or V4A. Up to 10 000 pulses per revolution.

- Size  $\varnothing 58...89$  mm
- Square wave and SinCos signals



Features	<ul style="list-style-type: none"> <li>■ Through hollow shaft</li> <li>■ Up to 6000 ppr</li> </ul>	<ul style="list-style-type: none"> <li>■ Solid shaft with clamping flange</li> <li>■ Up to 6000 ppr</li> </ul>	<ul style="list-style-type: none"> <li>■ Through hollow shaft</li> <li>■ Up to 6000 ppr</li> </ul>	<ul style="list-style-type: none"> <li>■ Blind hollow shaft</li> <li>■ Up to 10 000 ppr</li> <li>■ Sine periods per revolution 1024...2048</li> </ul>	
Product family	GE333	GE355	GF355	ITD 21 A4 Y65	ITD 41 A4 Y141   ITD 42 A4 Y141
Sensing method	Optical				
Size (housing)	$\varnothing 58$ mm			$\varnothing 89$ mm	
Voltage supply	5 VDC $\pm 10\%$ , 4.75...30 VDC, 10...30 VDC			5 VDC $\pm 5\%$ , 8...30 VDC	
Output stage					
- TTL/RS422	■	■	■	■	–
- HTL/push-pull	■	■	■	■	–
- SinCos 1 Vpp	–	–	–	–	■
Output signals	A 90° B, R + inverted			A, B, R + inv.	A, B, R
Shaft type					
- Solid shaft	–	$\varnothing 10$ mm	–	–	–
- Blind hollow shaft	–	–	–	$\varnothing 20...27$ mm	$\varnothing 20...27$ mm
- Through hollow shaft	$\varnothing 12$ mm	–	$\varnothing 10...14$ mm	–	–
Connection					
- Cable	Radial	Radial / axial	Radial	Radial	
Pulses per revolution	5...6000	5...6000	200...6000	200...10 000	–
Sine periods per revolution	–	–	–	–	1024...2048
Operating temperature	-25...+100 °C (5 VDC) -25...+85 °C (24 VDC)	-25...+85 °C	-20...+70 °C	-20...+70 °C	-20...+85 °C
Protection	IP 65	IP 67	IP 66	IP 67	
Operating speed	$\leq 6000$ rpm	$\leq 10 000$ rpm	$\leq 3000$ rpm	$\leq 2500$ rpm	
Max. shaft load	–	$\leq 20$ N axial, $\leq 40$ N radial	–	–	
Material	Stainless steel: 1.4305	Stainless steel: 1.4305	Stainless steel: 1.4404	Stainless steel: 1.4305	Stainless steel: 1.4305
Options	–	–	Cable with connector	Cable with connector	



# For special applications Stainless steel encoders / absolute

Housing V2A or V4A.

- Size  $\varnothing 58$  mm
- SSI, fieldbus, realtime Ethernet

PROFI<sup>®</sup>  
BUS

PROFI<sup>®</sup>  
NET

EtherNet/IP<sup>™</sup>

CANopen<sup>®</sup>

SSI

SAE J1939

MAGRES  
hermetic



Features	<ul style="list-style-type: none"> <li>■ Solid shaft with clamping flange</li> <li>■ Integrated interfaces</li> </ul>	<ul style="list-style-type: none"> <li>■ Solid shaft with clamping or synchro flange</li> <li>■ Through hollow shaft</li> <li>■ Flexible bus cover</li> </ul>	<ul style="list-style-type: none"> <li>■ Solid shaft with clamping flange</li> <li>■ Hermetically sealed</li> <li>■ Integrated interfaces</li> </ul>	<ul style="list-style-type: none"> <li>■ Solid shaft with clamping flange</li> <li>■ Hermetically sealed</li> <li>■ Flexible bus cover</li> </ul>
Product family	GE244    GE404	GEMMW    GEMMH	BMMV 58 - hermetic	BMMV 58 - hermetic

## Interface

- SSI	■	–	■	–
- CANopen <sup>®</sup>	–	■	■	■
- SAE J1939	–	■ 1)	–	■
- Profinet	–	■ 1)	–	■
- Profibus-DP	–	■	■	■
- EtherNet/IP	–	■ 1)	–	■

Function principle	Singleturn	Multiturn	Multiturn	Multiturn	Multiturn
Sensing method	Optical			Magnetic	
Size (housing)	$\varnothing 58$ mm				
Voltage supply	10...30 VDC				
Shaft type					
- Solid shaft	$\varnothing 10$ mm		$\varnothing 6, \varnothing 10$ mm	–	$\varnothing 10$ mm
- Through hollow shaft	–		–	$\varnothing 12...14$ mm	–
Connection	M23 radial		Bus cover cable gland		Bus cover M12
Total resolution	14 bits	26 bits	29 bits	$\leq 29$ bits	$\leq 30$ bits
Steps per turn	$\leq 16384/14$ bits	$\leq 4096/12$ bits	$\leq 8192/13$ bits	$\leq 8192/13$ bits	$\leq 4096/12$ bits
Number of turns	–	$\leq 16384/14$ bits	$\leq 65\,536/16$ bits	$\leq 65\,536/16$ bits	$\leq 262\,144/18$ bits
Absolute accuracy	$\pm 0.025^\circ$			$\pm 1^\circ$	
Operating temperature	$-25...+85^\circ\text{C}$			$-40...+85^\circ\text{C}$	
Protection	IP 67			IP 68, IP 69 K	
Operating speed	$\leq 6000$ rpm				
Max. shaft load	$\leq 20$ N axial $\leq 40$ N radial		$\leq 20$ N axial $\leq 40$ N radial	–	$\leq 120$ N axial (combined), $\leq 280$ N radial (combined) $\leq 270$ N axial (single load)
Material	Stainless steel: 1.4305 / 1.4404		Stainless steel: 1.4305		

1) on request

# For special applications

## Offshore incremental encoders

For use in CX environments.

- Size  $\varnothing 100 \dots 800$  mm
- Square wave and SinCos signals

**HUBNER**  
**BERLIN**  
A Baumer Brand



Features	<ul style="list-style-type: none"> <li>■ Cone shaft, solid shaft, blind hollow shaft</li> <li>■ Stainless steel housing</li> </ul>		<ul style="list-style-type: none"> <li>■ Cone shaft or blind hollow shaft</li> <li>■ High protection IP 67</li> </ul>		<ul style="list-style-type: none"> <li>■ Through hollow shaft</li> </ul>	<ul style="list-style-type: none"> <li>■ Through hollow shaft</li> <li>■ Bearingless encoders</li> <li>■ Up to 32 768 ppr</li> </ul>
Product family	POG 10	HOG 10	HOG 11	HOG 131	MHGE 100 - MHGE 800	
Sensing method	Optical				Magnetic	
Size (housing)	$\varnothing 115$ mm	$\varnothing 105$ mm	$\varnothing 105$ mm	$\varnothing 130$ mm	100 x 40 x 65 mm	
Size (magnetic wheel)					$\varnothing 99.9 \dots 813$ mm	
Voltage supply	5 VDC $\pm 5$ % 9...30 VDC			5 VDC $\pm 5$ %, 9...26 VDC 9...30 VDC		Rectangular: 4.75...30 VDC Sine: 5 VDC
Output stage						
- TTL/RS422	■	■	■	■	■	
- HTL-P (Power Linedriver)	■	■	■	■	■	
- SinCos 1 Vpp	-	-	-	-	■	
Output signals	K1, K2, K0 + inverted				A+, B+, R+, A-, B-, R-	
Output frequency	$\leq 120$ kHz				$\leq 300$ kHz	
Shaft type						
- Solid shaft	$\varnothing 11$ mm	-	-	-	-	
- Cone shaft 1:10	-	$\varnothing 17$ mm	$\varnothing 17$ mm	-	-	
- Blind hollow shaft	-	$\varnothing 12 \dots 20$ mm	$\varnothing 12 \dots 20$ mm	-	-	
- Through hollow shaft	-	-	-	$\varnothing 16 \dots 36$ mm	$\varnothing 16 \dots 740$ mm	
Connection	Terminal box	Cable	Terminal box		Flange connector M23	
Pulses per revolution	300...5000		300...2500		2048...3072	
64... 32 768						
Sine periods per revolution	-	-	-	-	64... 512	
Operating temperature	-40...+100 °C		-30...+85 °C		-40...+100 °C	
-40...+100 °C						
Protection	IP 66		IP 67		IP 56	
IP 67 (sensor head)						
Operating speed	$\leq 6000$ rpm				$\leq 8000$ rpm	
Max. shaft load	$\leq 300$ N axial, $\leq 450$ N radial	$\leq 450$ N axial, $\leq 600$ N radial	$\leq 250$ N axial, $\leq 400$ N radial		$\leq 300$ N axial, $\leq 500$ N radial	
-						
Explosion protection	Ex II 3G IIC / 3D IIIC (ATEX)				-	
-						
Corrosion protection	C4		CX (C5-M)		CX (C5-M)	
-						
Options	-	-	DNV certificate		-	
DNV certificate						

# For special applications Offshore absolute encoders

For use in CX environments.

- Size ø58...115 mm
- SSI, fieldbus, real-time Ethernet

PROFI<sup>®</sup>  
BUS

PROFI<sup>®</sup>  
NET

SSI

EtherCAT

CANopen

DeviceNet

EtherNet/IP



Features	■ Solid shaft with clamping or synchro flange	■ Through hollow shaft	■ Cone, solid or hollow shaft	■ Double-sided mounting	■ Stainless steel housing
Product family	GM400-C <sup>1)</sup>	GM401-C <sup>1)</sup>	G0M2H-C <sup>1)</sup>	G0A2H-C <sup>1)</sup>	PMG 10   HMG 10

## Interface

- SSI / SSI + incremental	■ / ■	■ / ■	■ / ■	■ / ■
- CANopen <sup>®</sup> / DeviceNet	–	–	■ / ■	■ / ■
- Profinet / Profibus-DP	–	–	■ / ■	■ / ■
- EtherCAT / EtherNet/IP	–	–	■ / ■	■ / ■

Function principle	Multiturn	Multiturn	Singleturn	Multiturn / Singleturn
Sensing method	Optical			
Size (housing)	ø58 mm	ø58 mm	ø115 mm	ø105 mm
Voltage supply	10...30 VDC	10...30 VDC	9...30 VDC	
Shaft type	ø10 mm	ø6 mm	–	ø11 mm   –
- Cone shaft 1:10	–	–	–	ø17 mm
- Blind hollow shaft	–	–	–	ø12...20 mm
- Through hollow shaft	–	–	ø12...14 mm	–   ø12...20 mm
Flange	Clamping flange	Synchro flange	–	EURO flange B10   –
Connection	Flange connector M23 cable		Flange connector M23 cable	Bus cover, terminal box, connector M12 or M23
Total resolution	≤30 bits	≤26 bits	≤14 bits	≤40 bits
Steps per turn	≤16384/14 bits	≤16384/14 bits	≤16384/14 bits	≤1 048 576/20 bits
Number of turns	≤65536/16 bits	≤4096/12 bits	–	≤1 048 576/20 bits
Absolute accuracy	±0.025°	±0.025°	–	–
Protection	IP 54, IP 65	IP 54 (IP 65 option)	–	IP 66, IP 67
Operating temperature	-25...+85 °C	-25...+85 °C	–	-40...+100 °C
Operating speed	≤6000 rpm	≤6000 rpm	–	≤12 000 rpm
Max. shaft load	≤20 N axial, ≤40 N radial	–	–	≤450 N axial, ≤650 N radial
Corrosion protection	CX (C5-M)			
Options	Additional incremental signals			

1) on request

# Tilt and vibration safely under control.



Inclination sensor GIM500R.

# Inclination / acceleration sensors



## Precise and robust.

The Baumer GIM inclination sensors are ideal for easy and precise angle measurement at all types of machinery and system components, especially where the rotary axis is difficult to access. Robust industrial design with IP 69 protection, corrosion resistance CX (C5-M), supreme EMC capabilities and E1 compliant electronics ensure ultimate durability in harsh environments, particularly in mobile automation.

Baumer inclination and acceleration sensors utilize MEMS technology (micro electro mechanical system) and stand out by compact designs, high cost efficiency and ultimate durability under adverse conditions.

The Baumer GAM900 acceleration sensor is a two-in-one product. It delivers precise acceleration information to a higher-level system via CANopen® or analog interface. In parallel, the sensor monitors shocks and vibrations, and reports any limit exceeded via the relay output.

The product variant GAM900S provides limit monitoring in compliance to functional safety integrity requirements up to SIL2/PLd. The EC type examination enables fast implementation of demanding safety requirements and speeds up conformity assessment procedures in accordance with the Machinery Directive.



Functional Safety Type Approved

www.tuv.com  
ID 0600000000



## Functional safety with certificate

The EC type-examination of the acceleration sensor GAM900S by the notified body TÜV Rheinland certifies the compliance with the increased requirements of the conformity assessment procedure according to the Machinery Directive. Further SIL2/PLd certified encoders complete the Baumer portfolio and simplify safety certification of the installation.

# Inclination / acceleration sensors

## Inclination sensors

One and two-dimensional sensing. Compact design.

- Analog, CANopen® and SAE J1939
- Robust metal or plastic housing
- MEMS technology without moving parts



[www.baumer.com/inclination](http://www.baumer.com/inclination)



<b>Features</b>	<ul style="list-style-type: none"> <li>■ Measuring range 0...360°</li> <li>■ Corrosion protection CX (C5-M)</li> <li>■ E1 compliant design</li> </ul>	<ul style="list-style-type: none"> <li>■ Measuring range up to ±60°</li> <li>■ Corrosion protection CX (C5-M)</li> <li>■ E1 compliant design</li> </ul>	<ul style="list-style-type: none"> <li>■ Measuring range 0...360°</li> <li>■ Corrosion protection CX (C5-M)</li> <li>■ E1 compliant design</li> <li>■ ISO 13849 compliant firmware</li> </ul>	<ul style="list-style-type: none"> <li>■ Measuring range up to ±90°</li> <li>■ Corrosion protection CX (C5-M)</li> <li>■ E1 compliant design</li> <li>■ ISO 13849 compliant firmware</li> </ul>
<b>Product family</b>	GIM140R - 1-dimensional	GIM140R - 2-dimensional	GIM500R - 1-dimensional	GIM500R - 2-dimensional

### Interface

- Analog	■	■	■	■
- CANopen® / redundant	■ / ■	■ / ■	■ / -	■ / -
- SAE J1939	-	-	■	■

<b>Sensing method</b>	MEMS	
<b>Size (housing)</b>	48 x 14 x 45 mm	48 x 24 x 52 mm
<b>Voltage supply</b>	8...30 VDC, 12...30 VDC	8...36 VDC
<b>Connection</b>	Cable	Cable, flange connector 1x or 2x M12
<b>Total resolution</b>	0.2°	0.025°

### Accuracy

- Sensing range 0...360°	±0.4°	-	±0.1°	-
- Sensing range ±10°	-	±0.4°	-	±0.1°
- Sensing range ±30°, ±60°	-	±0.4°	-	±0.1°
- Sensing range ±90°	-	-	-	±0.1°

<b>Operating temperature</b>	-40...+85 °C	
<b>Protection</b>	IP 67 / IP 69K	IP 69K
<b>Options</b>	Out-of-range diagnostic Cable with DEUTSCH connector Dual-channel architecture	Out-of-range diagnostic Cable with DEUTSCH connector

## Measuring inclination even in harsh environments

Inclination sensors detect the angle of inclination towards the horizontal line at machines and equipment. Acting as electronic water scale, they are ideal for measuring inclination angles, particularly where rotation shafts are difficult to access. Baumer inclination sensors significantly contribute towards improved safety, for example at cranes. The robust and saltwater-proof, IP 69K-rated aluminium die cast housing makes them ideal for industrial use in a rough ambience.

# Inclination / acceleration sensors

## Dynamic inclination sensors / acceleration sensors

### Dynamic inclination and vibration detection.

- Motion detection in up to three axes
- Suitable for outdoor and offshore use
- Analog, CANopen® and SAE J1939
- Individually configurable filters



[www.baumer.com/acceleration](http://www.baumer.com/acceleration)



<b>Features</b>	<ul style="list-style-type: none"> <li>■ Measuring range 0...360°</li> <li>■ Precise, extremely robust inclination detection</li> <li>■ Dynamically compensated with gyroscope and sensor fusion</li> </ul>	<ul style="list-style-type: none"> <li>■ Measuring range up to ±90° / ±180°</li> <li>■ Precise, extremely robust inclination detection</li> <li>■ Dynamically compensated with gyroscope and sensor fusion</li> </ul>	<ul style="list-style-type: none"> <li>■ Vibration/shock detection in three axes</li> <li>■ Limit monitoring with two relay outputs</li> </ul>	<ul style="list-style-type: none"> <li>■ Safe vibration/shock detection in three axes</li> <li>■ Redundant limit monitoring</li> <li>■ SIL2/PLd certification</li> </ul>
<b>Product family</b>	GIM741R - 1-dimensional	GIM741R - 2-dimensional	GAM900	GAM900S

### Interface

- Analog	–	–	■	■
- CANopen®	■	■	■	■
- SAE J1939	■	■	–	–
<b>Relay output</b>	–	–	2	1 (safe)
<b>Sensing method</b>	MEMS			MEMS (redundant)
<b>Size (housing)</b>	77 x 29 x 62 mm		55 x 30 x 90 mm	
<b>Voltage supply</b>	9...35 VDC		10...30 VDC	
<b>Connection</b>	Flange connector 2x M12		Flange connector 1x or 2x M12	
<b>Frequency bands</b>	–		6 (configurable)	4 (configurable)
<b>Total resolution</b>	0.01°		<4 mg	
<b>Accuracy 3σ (with band pass filtering)</b>	–		=35 mg (range ±1000 mg) =10 mg (range ±250 mg)	=60 mg (range ±1000 mg) =15 mg (range ±250 mg)
<b>Accuracy</b>	±0.5°		–	
<b>Measuring range</b>	0...360°	±90°, ±180°	±2 g	
<b>Operating temperature</b>	-40...+85 °C			
<b>Protection</b>	IP 67 / IP 69K		IP 67	
<b>Material</b>	Aluminium / glass-fiber reinforced plastic			
<b>Options</b>	–		Filter up to 150 Hz	

## Highest precision in dynamic applications

Dynamic inclination sensors are based on a multi-axis inertial measuring unit (IMU) with acceleration sensors and gyroscopes. Intelligent filters for sensor data fusion provide precise and extremely robust information about the current position and movement of an object, highly accurate even during dynamic movements with vibrations, shocks and high accelerations.

# Linear measurement made easy.



Cable transducer GCA5  
for measuring length up to 7.8 m.





## Easy attachment – reliable results.

Whether original equipment or retrofitting – Baumer cable transducers are ideal for simple and precise linear distance measurement. Though providing large measuring length, the cable transducers come in a compact design for reduced installation effort compared to conventional products. The integrated components are robust to ensure reliable and low-maintenance operation in harsh environments.

Your added value:

- Compact design or modular system
- Measuring length up to 50 m
- Absolute or incremental interfaces
- Comprehensive mounting accessories for optimum installation

### Redundant variants

Cable transducers with redundant sensing and signal output of the position value will increase application availability and safety.

Our qualified and experienced experts would be glad to support you in the design of your safety-relevant application and its certification by the notified body.



### Three-chamber design

Baumer cable transducers feature a three-chamber design to endure harsh environments. The electronics being completely isolated from the cable mechanism means optimum protection against ingress of moisture or other harmful ambient impacts.

# Distance measurement

## Cable transducers

Robust design for outdoor use. Measuring length up to 20 m.

- Absolute position sensing integrated
- Redundant sensing and interface
- Analog and CANopen®
- Compact housing



Features	<ul style="list-style-type: none"> <li>■ Measuring length up to 4.7 m</li> <li>■ Non-contact magnetic sensing</li> <li>■ Dirt skimmer</li> <li>■ Three-chamber design</li> </ul>	<ul style="list-style-type: none"> <li>■ Measuring length up to 7.8 m</li> <li>■ Non-contact magnetic sensing</li> <li>■ Dirt skimmer</li> <li>■ Three-chamber design</li> </ul>	<ul style="list-style-type: none"> <li>■ Measuring length up to 12 m</li> <li>■ Absolute potentiometer sensing</li> <li>■ Dirt skimmer</li> <li>■ Three-chamber design</li> </ul>	<ul style="list-style-type: none"> <li>■ Measuring length up to 20 m</li> <li>■ Absolute potentiometer sensing</li> <li>■ Dirt skimmer</li> <li>■ Three-chamber design</li> </ul>	
Product family	GCA3	GCA5	GCA8	GCA12	GCA20
Function principle	Absolute				
Interface					
- Analog / redundant	■ / ■	■ / ■	■ / ■	■ / ■	
- CANopen® / redundant	■ / ■	■ / ■	■ / ■	■ / ■	
Sensing method	Non-contact magnetic		Potentiometric		
Size	88 x 88 x 60.5 mm	88 x 88 x 65 mm	88 x 88 x 80.5 mm	126 x 126 x 98 mm	222 x 271 x 124 mm
Voltage supply	8...30 VDC, 12...30 VDC (Analog), 10...30 VDC (CANopen®)				
Measuring length max.	4.7 m	7.8 m	8 m	12 m	20 m
Linearity (Interface-dependent)	±0.5 %	±0.5 %	±0.3 %		±1 %
Connection					
- Flange connector M12	Radial				
- Cable	Radial				
Resolution	Up to 14 bits				
Operating temperature	-40...+85 °C				
Protection	IP 67	IP 67	IP 65		IP 65
Materials	Housing: Plastic Cable: Stainless steel with coating		Housing: Plastic/aluminium Cable: Stainless steel with coating		Housing: Aluminium Cable: Stainless steel with coating
Options	Integrated redundant inclination sensor	Integrated redundant inclination sensor Two-channel architecture ISO13849 compliant firmware	Integrated redundant inclination sensor		Integrated redundant inclination sensor

## Integrated inclination sensor

Your added value:

- A single compact sensor to measure length and angle simultaneously
- Convenient length and inclination readout via CANopen®
- Ideal for boom position measurement by saving installation space and cabling effort

# Distance measurement Cable transducers

## Modular system. Measuring length up to 50 m.

- Flexible product combinations of cable-pull and standard rotary encoder
- All standard interfaces
- Maximum reliability and longevity
- Precision metal housing
- Highest linearity

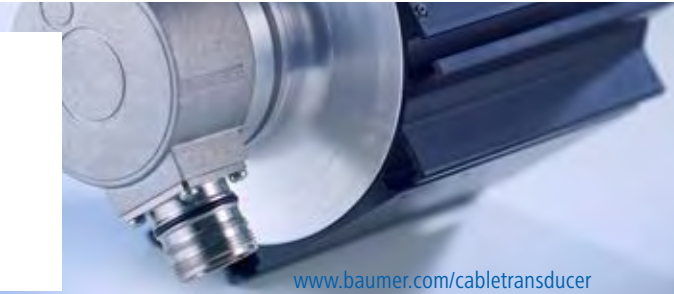

[www.baumer.com/cabletransducer](http://www.baumer.com/cabletransducer)



Features	<ul style="list-style-type: none"> <li>■ Measuring length 2.4 m</li> <li>■ Absolute or incremental encoder</li> <li>■ Cable-pull housing: plastic</li> </ul>	<ul style="list-style-type: none"> <li>■ Measuring length 3 m</li> <li>■ Absolute or incremental encoder</li> <li>■ Cable-pull housing: aluminium</li> </ul>	<ul style="list-style-type: none"> <li>■ Measuring length 5...15 m</li> <li>■ Absolute or incremental encoder</li> <li>■ Cable-pull housing: aluminium</li> </ul>	<ul style="list-style-type: none"> <li>■ Measuring length 30...50 m</li> <li>■ Absolute or incremental encoder</li> <li>■ Cable-pull housing: aluminium</li> </ul>
Product family	GCA2	GCA4	GCA15	GCA50
Function principle	Absolut			
Interface				
- SSI	■	■	■	■
- CANopen® / DeviceNet	■ / ■	■ / ■	■ / ■	■ / ■
- SAE J1939	■	■	■	■
- Profinet / Profibus-DP	■ / ■	■ / ■	■ / ■	■ / ■
- EtherCAT / EtherNet/IP	■ / ■	■ / ■	■ / ■	■ / ■
Sensing method	Optical			
Size	60 x 60 mm	96 x 96 x 56 mm	115 x 115 x 82.5 - 180.5 mm	200 x 200 x 268 - 333.5 mm
Voltage supply	10...30 VDC			
Measuring length	2.4 m	3 m	5...15 m	30...50 m
Linearity	±0.01 %	±0.02 % (3...7.5 m), ±0.01 % (10...50 m)		
Connection				
- Flange connector M12, M23	Radial, axial			
- Cable	Radial, axial			
- Bus cover	Radial			
Operating temperature	-20...+85 °C (optional: -40...+85 °C)			
Protection	IP 50 (cable-pull), IP 65 (encoder)			
Materials	Cable-pull housing: plastic Encoder housing: aluminium Wire: sheathed stainless steel	Cable-pull housing: aluminium Encoder housing: aluminium Wire: sheathed stainless steel		

# Distance measurement

## Linear magnetic encoders

Non-contact length measuring operations,  
cost-efficient and precise.

- Non-contact, wearfree magnetic sensing technology
- Impervious to soiling and resistant against vibration
- Extended life span thanks to robustness and durability in extreme conditions
- Maximized machine and system uptime



Features	<ul style="list-style-type: none"> <li>■ Linear measuring system</li> <li>■ Output signals A 90° B with index pulse</li> <li>■ Output circuit push-pull or RS422</li> </ul>
Product family	MIL10
Size (sensor head)	Rectangular
Dimensions (sensor head)	10 x 15 x 45.5 mm
Sensing distance	0.1...0.6 mm
Interpolation	Factor 20, 50, 100
Movement speed	<ul style="list-style-type: none"> <li>&lt;5 m/s (resolution 5 µm)</li> <li>&lt;10 m/s (resolution 10 µm)</li> <li>&lt;25 m/s (resolution 25 µm)</li> </ul>
Output circuit	HTL/Push-pull TTL/RS422
Output signals	A 90° B
Total resolution	<ul style="list-style-type: none"> <li>5 µm (factor 4 evaluation)</li> <li>10 µm (factor 4 evaluation)</li> <li>25 µm (factor 4 evaluation)</li> </ul>
System accuracy	±(0.02 mm +0.04 mm x magnetic belt length)
Connection	<ul style="list-style-type: none"> <li>Cable 2 m</li> <li>Cable 0.3 m with connector M12</li> </ul>
Voltage supply	10...30 VDC, 5 VDC ±5 %
Operating temperature	-40...+85 °C
Protection	IP 66, IP 67

# Distance measurement Measuring wheel encoders

## The efficient and reliable solution to measure length.

- Programmable incremental encoders used in conjunction with measuring wheels
- Particularly easy acquisition of position and speed with high flexibility
- Perfect for ink jet and laser printing applications thanks to precise optical sensing



Features	<ul style="list-style-type: none"> <li>■ Encoder assembly including tether arm and measuring wheel</li> <li>■ User-adjustable contact pressure</li> </ul>	<ul style="list-style-type: none"> <li>■ Solid shaft with clamping flange or synchro flange</li> <li>■ Incremental encoder with measuring wheel and programming tool</li> </ul>
Product family	MA20	EIL580P-SC    EIL580P-SY
Configurable parameters	16 pre-defined resolutions	Pulses per revolution, output stage HTL or TTL, zero pulse, signal sequence
Configuration	HEX switch	PC software / hardware adapter, handheld programming tool
Sensing method	Optical	
Size (housing)	ø40 mm (encoder)	ø58 mm
Voltage supply	4.75...30 VDC	
Output stage		
- TTL/RS422	–	■
- HTL/push-pull	■	■
Output signals	A 90° B	A 90° B, R + inverted
Shaft type		
- Solid shaft	ø6 mm	ø10 mm    ø6 mm
Flange	–	Clamping flange    Synchro flange
Connection		
- Flange connector M12	Radial	Radial / axial
- Flange connector M23	–	Radial / axial
- Cable	Radial	Radial / axial / tangential
Pulses per revolution	100...25 000	1...65 536
Operating temperature	-20...+85 °C	-40...+100 °C
Protection	IP 64	IP 65, IP 67
Operating speed	≤3000 rpm	≤12 000 rpm (IP 65) ≤6000 rpm (IP 67)
Options	Measuring wheels available with different rubber linings	Approval ATEX II 3 D, zone 22 (ExEIL580, ExEIL580P) Measuring wheels MR2, MR5, MR7

## Convenient programming

Easy programming of EIL580P and Ex EIL580P by handheld tool

- User-configurable resolution and signal levels
- Intuitive operation
- 4 user-assignable keys
- Standard AA battery supply



## Measuring wheels

Baumer offers a wide selection of measuring wheels of the MR2, MR5 and MR7 series to ensure the best match with the material properties of the measuring object: Aluminium, TPE, PUR and NBR with diameters from 20 to 50 cm. For best results and optimum grip.



# Accessories

## Mounting accessories and programming.

Several mechanical and electric interface concepts as well as increasingly demanding applications call for appropriate accessories.

With Baumer you will always encounter the matching mounting accessories like torque supports, spring washers, connectors and cables.



## Mounting accessories for hollow shaft encoders

Matching accessories for hollow shaft mount

- Stator couplings for ultra-precise mount with maximum installation flexibility
- Safe and easy anti-torsion spring washers and pins
- Torque supports for industry and HeavyDuty variants

## Mounting accessories for solid shaft encoders

Matching accessories for solid shaft mount

- Shaft couplings to link drive shaft and encoder shaft
- Mounting clamp to secure encoder flange
- Adaptor flange and mounting angle for quick and safe encoder mount
- Flange adaptor, for example to change a clamping flange into a synchro flange

## Programming and diagnostic tools

For encoder commissioning and configuration

- Signal processing for interpolation, conversion, regenerating and as a switching relay, HTL, TTL, SinCos and fiber-optic
- Programming tools with GSD-/EDS-/XML files as well as instruction manuals, USB adaptor and PC software
- Testing equipment for incremental encoders for consistent monitoring of encoder data
- PC software for display and evaluation

## Connectors, cables, measuring wheels and counters.

Deployed in conjunction with incremental encoders, measuring wheels perform the task of length measurement or speed monitoring. Learn more at: [www.baumer.com](http://www.baumer.com)

[www.baumer.com/accessories](http://www.baumer.com/accessories)



## Varied connectors and cables

Matching all encoders and angular sensors

- Mating connector M12, M23, MIL and other standards
- Mating connector pre-assembled or for self-assembly
- Different cables, non-assembled

## Small and large measuring wheels

Measuring wheels – for any surface the optimum grip

- Wheel material and surface profile depending on the application
- Circumference 20 or 50 cm
- For shaft diameters from 4 to 12 mm

## Counters and displays

Acquisition, display and control of process data and measured values

- Counters / position displays / process displays
- Preset counters / multifunction devices
- Time / hour counters

# Accessories

## Signal processing

### Digital converters.

- Level conversion and potential separation
- For extended signal transmission length
- TTL, HTL and SinCos

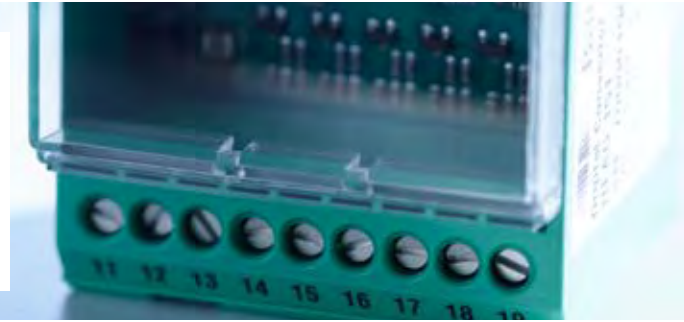

Features	<ul style="list-style-type: none"> <li>■ Conversion HTL to TTL / TTL to HTL</li> <li>■ Signal regeneration</li> <li>■ Potential separation with several receivers</li> <li>■ 1 input unit / 3 output units</li> </ul>	<ul style="list-style-type: none"> <li>■ Conversion TTL to HTL</li> <li>■ Conversion HTL to TTL</li> <li>■ Signal regeneration</li> </ul>	<ul style="list-style-type: none"> <li>■ Conversion TTL to HTL</li> <li>■ Conversion HTL to TTL</li> <li>■ Signal regeneration</li> </ul>		
Product family	HEAG 150	HEAG 151	HEAG 152	HEAG 153	HEAG 154
Size	DIN rail housing 150 x 75 x 55 mm	DIN rail housing 50 x 75 x 55 mm			
Voltage supply	5 VDC ±5 %, 9...26 VDC	5 VDC ±5 %		9...26 VDC	
Inputs					
- Number	1	1	1	1	1
- TTL/RS422	■	■	—	■	—
- HTL/push-pull	■	—	■	—	■
Outputs					
- Number	3	1	1	1	1
- TTL/RS422	■	■	■	—	—
- HTL/push-pull	■	—	—	■	■
Input signals	K1, K2, K0 + inverted	K1, K2, K0 + inverted			
Output signals	K1, K2, K0 + inverted	K1, K2, K0 + inverted			
Output circuit	Optocoupler				
Connection	Screw terminals				
Consumption	≤300 mA	≤75 mA		≤100 mA	
Input frequency	120 kHz, 200 kHz	200 kHz	120 kHz	200 kHz	120 kHz
Operating temperature	-20...+50 °C				
Protection	IP 20				





### Precision interpolators and signal converters.

- Enhanced resolution and signal interpolation
- Up to three signal outputs
- TTL, HTL and SinCos

[www.baumer.com/signal-processing](http://www.baumer.com/signal-processing)



<b>Features</b>	<ul style="list-style-type: none"> <li>■ Precision interpolator</li> <li>■ Splitter for signal conversion SinCos to TTL/HTL</li> <li>■ Additional signal interpolation</li> </ul>	<ul style="list-style-type: none"> <li>■ Precision sine multiplier</li> <li>■ Converter SinCos to multiple SinCos</li> </ul>	<ul style="list-style-type: none"> <li>■ Precision interpolator</li> <li>■ Precision splitter</li> <li>■ Converter SinCos to multiple SinCos</li> <li>■ Additional HTL or TTL signal interpolation</li> </ul>
<b>Product family</b>	<b>HEAG 158</b>	<b>HEAG 159</b>	<b>HEAG 160</b>
<b>Size</b>	Surface mount housing 122 x 122 x 80 mm		
<b>Voltage supply</b>	10...30 VDC	5 VDC ±5%, 10...30 VDC	
<b>Inputs</b>			
- Number	2	2	2
- TTL/RS422	–	–	–
- HTL/push-pull	–	–	–
- SinCos 1 Vpp	■	■	■
<b>Outputs</b>			
- Number	3	2	4
- TTL/RS422	■	–	■
- HTL/push-pull	■	–	■
- SinCos 1 Vpp	–	■	■
- Error output	■	–	■
<b>Input signals</b>	A+, A-, B+, B-, R+, R-		
<b>Output signals</b>	A+, A-, B+, B-, R+, R-		
<b>Connection</b>	Mating 3-pin connector M23		
<b>Consumption</b>	≤150 mA (15 VDC)	≤500 mA (5 VDC), ≤300 mA (10...30 VDC)	
<b>Input frequency</b>	400 kHz		
<b>Operating temperature</b>	0...+50 °C		
<b>Protection</b>	IP 65		
<b>Options</b>	A+, A-, B+, B-, R+, R-, Error		

# Accessories

## Signal processing

Optical signal transmission.  
Serial communication via up to 2 optical fibers.

- Immunity to interference in environments with high EMC loads.
- Transmission range up to 1500 m
- High-precision, redundant transmission of TTL/HTL encoder signals
- Automatic real-time channel switching in case of fiber optic failure



Features	<ul style="list-style-type: none"> <li>■ Transmitter for fiber optic signals (FO)</li> <li>■ Switch cabinet device for DIN rail mounting</li> <li>■ Conversion HTL/TTL to FO</li> <li>■ 4+2 channels</li> <li>■ Transmission length <math>\leq 1500</math> m</li> </ul>	<ul style="list-style-type: none"> <li>■ Transmitter for fiber optic signals (FO)</li> <li>■ Field device with outdoor box</li> <li>■ Conversion HTL/TTL to FO</li> <li>■ 4+2 channels</li> <li>■ Transmission length <math>\leq 1500</math> m</li> </ul>	<ul style="list-style-type: none"> <li>■ Receiver for fiber optic signals (FO)</li> <li>■ Switch cabinet device for DIN rail mounting</li> <li>■ Conversion FO to HTL/TTL</li> <li>■ 2+4 channels</li> <li>■ 3 status outputs</li> </ul>
Product family	LWL-SHR	LWL-SBR	LWL-EHR
Size	100 x 75 x 53 mm	122 x 81 x 220 mm	100 x 75 x 53 mm
Voltage supply	9...30 VDC		
Inputs			
- Number	4	4	2
- TTL/RS422	■	■	—
- HTL/push-pull	■	■	—
- Error	■	■	—
- LWL	—	—	■
Outputs			
- Number	2	2	4
- TTL/RS422	—	—	■
- HTL/push-pull	—	—	■
- LWL	■	■	—
Input signals	K1, K2, K0 + inverted, Err +/-	K1, K2, K0 + inverted, Err +/-	LWL 1, 2
Output signals	LWL 1, 2	LWL 1, 2	K1, K2, K0 + inverted, Err +/-
Connection			
- Screw terminal	■	■	■
- Cable gland	—	M16, M20, M32x1.5	—
- Fiber-optic	2x ST connector	2x ST connector	2x ST connector
Consumption	$\leq 300$ mA		
Operating temperature	-20...+70 °C	-40...+85 °C	-20...+70 °C
Protection	IP 20	IP 66, IP 67	IP 20
Signal monitoring	Error detection and status signals Redundant transmission via two optical fibers Automatic channel switching in case of failure of a fiber optic line		

Optical signal transmission.  
Parallel communication via up to 4 optical fibres.

- Immunity to interference in environments with high EMC loads.
- Transmission range up to 1500 m
- High precision transmission of TTL/HTL encoder signals

[www.baumer.com/signal-processing](http://www.baumer.com/signal-processing)



Features	<ul style="list-style-type: none"> <li>■ Signal conversion TTL to LWL</li> <li>■ For EMC-critical environments</li> </ul>	<ul style="list-style-type: none"> <li>■ Signal conversion HTL to LWL</li> <li>■ For EMC-critical environments</li> </ul>	<ul style="list-style-type: none"> <li>■ Signal conversion LWL to TTL</li> <li>■ For EMC-critical environments</li> </ul>	<ul style="list-style-type: none"> <li>■ Signal conversion LWL to HTL</li> <li>■ For EMC-critical environments</li> </ul>
Product family	HEAG 171	HEAG 172	HEAG 173	HEAG 174
<b>Size</b>	Surface mount housing 122 x 122 x 80 mm		DIN rail housing 50 x 75 x 55 mm	
<b>Voltage supply</b>	5 VDC ±5 %, 9...26 VDC	9...26 VDC	5 VDC ±5 %	10...30 VDC
<b>Inputs</b>				
- Number	4	4	3	3
- TTL/RS422	■	–	–	–
- HTL/push-pull	–	■	–	–
- LWL	–	–	■	■
<b>Outputs</b>				
- Number	4	4	3	3
- TTL/RS422	–	–	■	–
- HTL/push-pull	–	–	–	■
- LWL	■	■	–	–
<b>Input signals</b>	K1, K2, K3, K4 + inverted		LWL 1, 2, 3	
<b>Output signals</b>	LWL 1, 2, 3, 4		K1, K2, K3 + inverted	
<b>Connection</b>				
- Screw terminals	–	–	■	■
- Cable gland M16	■	■	–	–
- Cable gland M20	■	■	–	–
<b>Max. load current</b>	200 mA		60 mA	
<b>Operating temperature</b>	-20...+70 °C		-20...+50 °C	
<b>Protection</b>	IP 65		IP 20	

## Efficiency for long distances

To provide interference-immune efficient long-distance transmission of encoder signals and information, the Baumer solution converts incremental square signals (8-channel maximum) and status signals in real-time into a serial digital data stream. This digital data stream is transmitted, optically by light pulses via one or two optical fibers, protected by a CRC checksum against bit errors and loss of individual data packets.

For maximum system availability, we recommend redundant transmission via two optical fibers in parallel. If one optical fiber should fail, the receiver will further generate high-quality signals from the information of the remaining optical channel.

# Index

BDK 16	6	G0M2H	23	GXA2S	23
BHK 16	6	G0M2H-C	81	GXM2S	23
BMMV 58 - hermetic	21, 79	G0P5H	23	GXP5S	23
BMSK 55	59	G1M2H	25	GXP5W	23
BRID 58S	9	G1MMH	25	GXU5W	23
BRIH 40	7	G2M2H	25	HEAG 150	94
BRIH 58S	9	G2MMH	25	HEAG 151	94
BRIV 30	7	GA240	23	HEAG 152	94
BRIV 30R	7	GA241	23	HEAG 153	94
BRIV 58K	9	GAM900	85	HEAG 154	94
BRIV 58S	9	GAM900S	85	HEAG 158	95
DS 93	39	GBA2H	23	HEAG 159	95
DS 93 R	39	GBA2S	23	HEAG 160	95
EAL580-B	22	GBA2W	23	HEAG 171	97
EAL580-SC	22	GBM2H	23	HEAG 172	97
EAL580-SV	22	GBM2S	23	HEAG 173	97
EAL580-T	22	GBM2W	23	HEAG 174	97
EAM280	18, 76	GCA12	88	HMG 10	36, 81
EAM360 Kit	58	GCA15	89	HMG 10D	42
EAM360-B	18	GCA2	89	HMG 10P	36, 67
EAM360R Kit	58	GCA20	88	HMG 10PD	42
EAM360R-B	19	GCA3	88	HMG 161	37
EAM360R-SW	18	GCA4	89	HMG10P	67
EAM360-SW	18	GCA5	88	HOG 10	31, 80
EAM500	59, 76	GCA50	89	HOG 10 G	48
EAM580 Kit	58	GCA8	88	HOG 10+DSL.E	40
EAM580-B	20	GE244	79	HOG 10+DSL.R	40
EAM580R	76	GE333	78	HOG 10+ESL	51
EAM580R Kit	58	GE355	78	HOG 10+FSL	51
EAM580R-B	20	GE404	79	HOG 100	31
EAM580R-S	20	GEMMH	79	HOG 11	31, 80
EAM580-S	20	GEMMW	79	HOG 11 G	48
EEx HOG 161	74	GF355	78	HOG 11+ESL	51
EEx OG 9	29, 74	GIM140R	84	HOG 11+FSL	51
EEx OG 9 S	74	GIM500R	84	HOG 131	32, 80
EIL576S	77	GIM741R	85	HOG 16	32
EIL580-B	8, 14	GM400	23	HOG 163	32
EIL580-S1	15	GM400-C	81	HOG 165	32
EIL580-SC	8	GM401	23	HOG 165+DSL.E	40
EIL580-SQ	14	GM401-C	81	HOG 165+DSL.R	40
EIL580-SY	8	GMM230S	39, 77	HOG 22	33
EIL580-T	8, 14	GMM236S	39	HOG 220	33
EIL580P-B	8, 66	GMM240S	39, 77	HOG 28	33
EIL580P-SC	8, 66, 91	GMM246S	39	HOG 71	30
EIL580P-SY	8, 66, 91	GT 5	46	HOG 86	30
EIL580P-T	8, 66	GT 7.08	46	HOG 86+FSL	51
ES 90	38	GT 7.16	46	HOG 86E	30
ES 93	38	GT 9	46	HOG 9	31
ExEIL580	74	GTB 9.06	46	HOG 9 G	48
ExEIL580P	74	GTB 9.16	46	HOGS 100	35
FS 90	38	GTF 7.08	44	HOGS 100S	77
G0A2H	23	GTF 7.16	44	HOGS 14	35
G0A2H-C	81	GTR 9	47	HOGS 151	35

HOGS 71	34	PMG 10	36, 81
HS35F	10, 14	PMG 10D	42
HS35P	10, 14, 67	PMG 10P	36, 67
HS35S	12	PMG 10PD	42
ITD 01 A4	6	POG 10	29, 80
ITD 01 B14	6	POG 10 G	48
ITD 40	10	POG 10+DSL.E	41
ITD 40 B10	15	POG 10+DSL.R	41
ITD 41	10	POG 10+ESL	50
ITD 41 A4 Y141	78	POG 10+FSL	50
ITD 41 B10	15	POG 11	29
ITD 42 A4 Y141	78	POG 11 G	48
ITD 42 A4 Y79	12	POG 11+ESL	50
ITD 67	54	POG 11+FSL	50
ITD 70	11	POG 86	28
ITD 75	11	POG 86 G	48
ITD21 A4 Y65	78	POG 86+FSL	50
ITD22H00	12	POG 86E	28
ITD49H	54	POG 9	28
ITD49H Sine	54	POG 9 G	48
ITD61H00	11	POG 9+ESL	50
ITD69H	55	POG 9+FSL	50
ITD69H Sine	55	POG 90	29
ITD89H	55	POGS 90	34
ITD89H Sine	55	TDP 0,09	44
KTD 4	47	TDP 0,09+FSL	49
LWL-EHR	96	TDP 0,2	44
LWL-SBR	96	TDP 0,2+ESL	49
LWL-SHR	96	TDP 0,2+FSL	49
MA20	91	TDP 0,2+OG9	49
MDFK 08	54	TDP 13	44
MDFM 20	63	TDPZ 0,09	44
MDRM 18	62	TDPZ 0,2	44
MHAD 50	60	TDPZ 0,2+ESL	49
MHAP 100	60	TDPZ 0,2+FSL	49
MHAP 200	60	TDPZ 13	44
MHAP 400	60	X 700 - CANopen	75
MHGE 100	56, 80	X 700 - incremental	75
MHGE 200	56, 80	X 700 - Profibus-DP	75
MHGE 400	56, 80	X 700 - SSI	75
MHGE 800	56, 80		
MHGP 100	57		
MHGP 200	57		
MHGP 400	57		
MHRM 12	70		
MHRM 18	70		
MIL10	90		
MIR 10	54		
MIR 3000F	61		
MIR 350F	61		
MQR 3000F	61		
MQR 350F	61		
OG 9	28		

Worldwide presence  
and supreme competence  
in consulting, sales  
and service.

# Baumer – the strong partner.

We at Baumer are close to our customers, understand their needs and provide the best solution. Worldwide customer service for Baumer starts with on-the-spot personal discussions and qualified consultation. Our application engineers speak your language and strive from the start, through an interactive problem analysis, to offer comprehensive and user-compatible solutions.

## We are close to you across the globe.

The worldwide Baumer sales organizations guarantee short delivery times and readiness to supply. Many of our customers are directly linked via our electronic order system with the JIT logistics process.

A worldwide network coupled with the most modern communication techniques enable us to deliver information quickly and transparently to decision makers in all Baumer locations.

Closeness to the customer for Baumer means being available for your needs anywhere and at any time.



# Worldwide presence.



## Africa

Algeria  
Cameroon  
Côte d'Ivoire  
Egypt  
Morocco  
Reunion  
South Africa

## America

Brazil  
Canada  
Colombia  
Mexico  
United States  
Venezuela

## Asia

Bahrain  
China  
India  
Indonesia  
Israel  
Japan  
Kuwait  
Malaysia  
Oman  
Philippines  
Qatar  
Saudi Arabia  
Singapore  
South Korea  
Taiwan  
Thailand  
UAE

## Europe

Austria  
Belgium  
Bulgaria  
Croatia  
Czech Republic  
Denmark  
Finland  
France  
Germany  
Greece  
Hungary  
Italy  
Malta  
Martinique  
Netherlands  
Norway  
Poland  
Portugal  
Romania  
Russia  
Serbia  
Slovakia  
Slovenia  
Spain  
Sweden  
Switzerland  
Turkey  
United Kingdom

## Oceania

Australia  
New Zealand



For more information  
about our worldwide  
locations go to:  
[www.baumer.com/worldwide](http://www.baumer.com/worldwide)



## Baumer

Passion for Sensors

**Baumer Group**  
International Sales  
P.O. Box · Hummelstrasse 17 · CH-8501 Frauenfeld  
Phone +41 (0)52 728 1122 · Fax +41 (0)52 728 1144  
[sales@baumer.com](mailto:sales@baumer.com) · [www.baumer.com](http://www.baumer.com)

Represented by: