



Controller

KUKA Roboter GmbH

KR C4; KR C4 CK

Operating Instructions

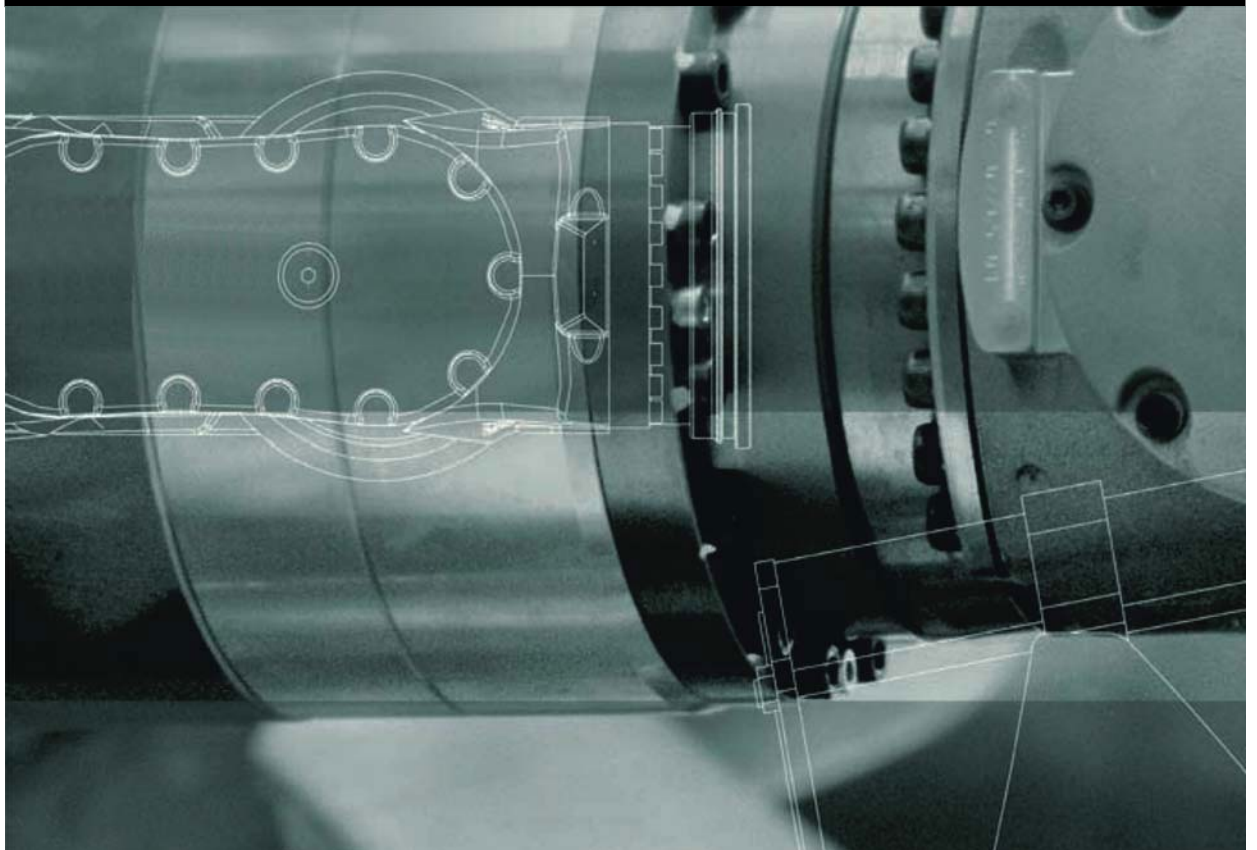

Issued: 26.01.2015

Version: BA KR C4 GI V11



© Copyright 2015

KUKA Roboter GmbH
Zugspitzstraße 140
D-86165 Augsburg
Germany

This documentation or excerpts therefrom may not be reproduced or disclosed to third parties without the express permission of KUKA Roboter GmbH.

Other functions not described in this documentation may be operable in the controller. The user has no claims to these functions, however, in the case of a replacement or service work.

We have checked the content of this documentation for conformity with the hardware and software described. Nevertheless, discrepancies cannot be precluded, for which reason we are not able to guarantee total conformity. The information in this documentation is checked on a regular basis, however, and necessary corrections will be incorporated in the subsequent edition.

Subject to technical alterations without an effect on the function.

Translation of the original documentation

KIM-PS5-DOC

Publication:	Pub BA KR C4 GI (PDF) en
Book structure:	BA KR C4 GI V12.4
Version:	BA KR C4 GI V11

Contents

1	Introduction	9
1.1	Industrial robot documentation	9
1.2	Representation of warnings and notes	9
1.3	Trademarks	9
1.4	Terms used	10
2	Purpose	13
2.1	Target group	13
2.2	Intended use	13
3	Product description	15
3.1	Overview of the industrial robot	15
3.2	Overview of the robot controller	15
3.3	KUKA Power Pack	17
3.4	KUKA Servo Pack	17
3.5	Control PC	17
3.6	Cabinet Control Unit	18
3.7	Safety Interface Board	19
3.8	Resolver Digital Converter	19
3.9	Controller System Panel	20
3.10	Low-voltage power supply unit	21
3.11	24 V external power supply	21
3.12	Batteries	21
3.13	Mains filter	21
3.14	Bus devices	21
3.14.1	KCB devices	22
3.14.2	KSB devices and configuration variants	22
3.14.3	KEB devices and configuration variants	22
3.15	Connection panel interfaces	24
3.16	Motor connector Xxx, external axes X7.1, X7.2, X7.3	26
3.16.1	Connector pin allocation, motor connector X20	27
3.16.2	Connector pin allocation for motor connector X20 with 1 KPP and 1 KSP	28
3.16.3	Connector pin allocation X20.1 and X20.4 (heavy-duty robot)	29
3.16.4	Connector pin allocation X7.1 for external axis 1	30
3.16.5	Connector pin allocation X7.1 and X7.2 for external axes 1 and 2	30
3.16.6	Connector pin allocation X7.1, X7.2 and X7.3 for external axes 1, 2 and 3	31
3.16.7	Connector pin allocation X8 (heavy-duty palletizing robot) (4 axes)	32
3.16.8	Connector pin allocation X20 (palletizing robot) (4 axes)	33
3.16.9	Connector pin allocation X20.1 and X20.4 (heavy-duty palletizing robot) (5 axes)	34
3.16.10	Connector pin allocation X20 (palletizing robot) (5 axes)	35
3.16.11	Connector pin allocation X81 (4 axes)	36
3.16.12	Connector pin allocation X82 (8 axes)	37
3.16.13	Connector pin allocation X7.1 for palletizing robot, external axis 1	37
3.16.14	Connector pin allocation X7.1 and X7.2 for palletizing robot, for external axes 1 and 2	38
3.17	Multiple connector X81, single connectors X7.1 to X7.4	38
3.17.1	Connector pin allocation X81 (3 axes)	39
3.17.2	Connector pin allocation X81 (4 axes)	40

3.17.3	Connector pin allocation X81, X7.1 (5 axes)	41
3.17.4	Connector pin allocation X81, X7.1 and X7.2 (6 axes)	42
3.17.5	Connector pin allocation X81, X7.1 to X7.3 (7 axes)	43
3.17.6	Connector pin allocation X81, X7.1 to X7.4 (8 axes)	44
3.18	Single connectors X7.1 to X7.8	46
3.18.1	Connector pin allocation X7.1 to X7.3 (3 axes)	47
3.18.2	Connector pin allocation X7.1 to X7.4 (4 axes)	48
3.18.3	Connector pin allocation X7.1 to X7.5 (5 axes)	49
3.18.4	Connector pin allocation X7.1 to X7.6 (6 axes)	50
3.18.5	Connector pin allocation X7.1 to X7.7 (7 axes)	52
3.18.6	Connector pin allocation X7.1 to X7.8 (8 axes)	54
3.19	Control PC interfaces	55
3.19.1	Motherboard D2608-K interfaces	56
3.19.2	Motherboard D3076-K interfaces	57
3.19.3	Motherboard D3236-K interfaces	58
3.20	KUKA smartPAD holder (optional)	59
3.21	Set of rollers (optional)	60
3.22	Cabinet cooling	60
3.23	Description of the space for integration of customer options	61
4	Technical data	63
4.1	External 24 V power supply	65
4.2	Safety Interface Board	65
4.3	Dimensions of robot controller	66
4.4	Minimum clearances, robot controller	67
4.5	Swing range for cabinet door	68
4.6	Dimensions of the smartPAD holder (optional)	68
4.7	Dimensions of boreholes for floor mounting	69
4.8	Dimensions of boreholes for technology cabinet	69
4.9	Plates and labels	69
5	Safety	73
5.1	General	73
5.1.1	Liability	73
5.1.2	Intended use of the industrial robot	73
5.1.3	EC declaration of conformity and declaration of incorporation	74
5.1.4	Terms used	74
5.2	Personnel	76
5.3	Workspace, safety zone and danger zone	77
5.3.1	Determining stopping distances	77
5.4	Triggers for stop reactions	78
5.5	Safety functions	78
5.5.1	Overview of the safety functions	78
5.5.2	Safety controller	79
5.5.3	Mode selection	79
5.5.4	“Operator safety” signal	80
5.5.5	EMERGENCY STOP device	80
5.5.6	Logging off from the higher-level safety controller	81
5.5.7	External EMERGENCY STOP device	81

5.5.8	Enabling device	82
5.5.9	External enabling device	82
5.5.10	External safe operational stop	82
5.5.11	External safety stop 1 and external safety stop 2	83
5.5.12	Velocity monitoring in T1	83
5.6	Additional protective equipment	83
5.6.1	Jog mode	83
5.6.2	Software limit switches	83
5.6.3	Mechanical end stops	83
5.6.4	Mechanical axis range limitation (optional)	84
5.6.5	Axis range monitoring (optional)	84
5.6.6	Options for moving the manipulator without drive energy	84
5.6.7	Labeling on the industrial robot	85
5.6.8	External safeguards	85
5.7	Overview of operating modes and safety functions	86
5.8	Safety measures	86
5.8.1	General safety measures	86
5.8.2	Transportation	87
5.8.3	Start-up and recommissioning	88
5.8.3.1	Checking machine data and safety configuration	89
5.8.3.2	Start-up mode	90
5.8.4	Manual mode	91
5.8.5	Simulation	92
5.8.6	Automatic mode	92
5.8.7	Maintenance and repair	92
5.8.8	Decommissioning, storage and disposal	94
5.8.9	Safety measures for “single point of control”	94
5.9	Applied norms and regulations	95
6	Planning	97
6.1	Electromagnetic compatibility (EMC)	97
6.2	Installation conditions	97
6.3	Connection conditions	100
6.4	Fastening the KUKA smartPAD holder (optional)	101
6.5	Power supply connection via X1 Harting connector	102
6.6	Description of safety interface X11	103
6.6.1	Safety interface X11	104
6.6.2	Interface X11 – external enabling switch	107
6.6.3	Contact diagram for connector X11	108
6.6.4	Wiring example for E-STOP circuit and safeguard	108
6.6.5	Wiring example for safe inputs and outputs	109
6.7	Safety functions via Ethernet safety interface (optional)	112
6.7.1	Schematic circuit diagram for enabling switches	115
6.7.2	SafeOperation via Ethernet safety interface (optional)	116
6.7.3	Ethernet interface (1xRJ45) X66	119
6.8	EtherCAT connection on the CIB	120
6.9	PE equipotential bonding	120
6.10	Modifying the system configuration, exchanging devices	122
6.11	Operator safety acknowledgement	122

6.12	Performance level	122
6.12.1	PFH values of the safety functions	122
7	Transportation	125
7.1	Transportation using lifting tackle	125
7.2	Transportation by fork lift truck	126
7.3	Transportation by pallet truck	128
7.4	Transportation with the set of rollers (optional)	129
8	Start-up and recommissioning	131
8.1	Start-up overview	131
8.2	Installing the robot controller	132
8.3	Connecting the connecting cables	133
8.3.1	Data cables, X21	134
8.4	Fastening the KUKA smartPAD holder (optional)	134
8.5	Plugging in the KUKA smartPAD	134
8.6	Connecting the PE equipotential bonding	135
8.7	Connecting the robot controller to the power supply	135
8.8	Reversing the battery discharge protection measures	136
8.9	Configuring and connecting safety interface X11	136
8.10	Modifying the system configuration, exchanging devices	137
8.11	Start-up mode	137
8.12	Switching on the robot controller	138
9	Operation	139
9.1	KUKA smartPAD teach pendant	139
9.1.1	Front view	139
9.1.2	Rear view	141
10	Maintenance	143
10.1	Maintenance symbols	143
10.2	Checking SIB relay outputs	145
10.3	Checking Extended SIB relay outputs	145
10.4	Cleaning the robot controller	146
11	Repair	147
11.1	Repair and procurement of spare parts	147
11.2	Wiring example X11	148
11.3	Exchanging the external fan	149
11.4	Exchanging the internal fan	150
11.5	Exchanging control PC components	151
11.5.1	Exchanging the control PC	151
11.5.2	Exchanging the control PC fan	152
11.5.3	Exchanging the motherboard	154
11.5.4	Exchanging the motherboard battery	154
11.5.5	Exchanging the LAN Dual NIC network card	154
11.5.6	Exchanging the hard drive	155
11.6	Modifying the system configuration, exchanging devices	156
11.6.1	Exchanging the KUKA Power Pack	157
11.6.2	Exchanging the KUKA Servo Pack	160

11.6.3	Exchanging the Cabinet Control Unit	163
11.6.4	Exchanging the Safety Interface Board	166
11.6.5	Exchanging the Resolver Digital Converter	169
11.7	Exchanging the batteries	171
11.7.1	Exchanging the batteries behind the cooling duct	171
11.7.2	Exchanging the batteries in the cabinet door	173
11.8	Exchanging the low-voltage power supply unit	174
11.9	Exchanging the pressure relief plug	175
11.10	Installing the KUKA System Software (KSS)	176
12	Troubleshooting	177
12.1	Cabinet Control Unit LED display	177
12.2	Cabinet Control Unit fusing	181
12.3	Resolver Digital Converter LED display	182
12.4	Controller System Panel LED display	183
12.4.1	Controller System Panel LED error display	185
12.5	Control PC interfaces	185
12.5.1	LAN Onboard LED display on motherboard D2608-K	186
12.5.2	LAN Onboard LED display on motherboard D3076-K	186
12.5.3	LAN Onboard LED display on motherboard D3236-K	187
12.6	Safety Interface Board LED display	188
12.7	Safety Interface Board fuses	191
12.8	Checking the KUKA Servo Pack	193
12.9	Checking the KUKA Power Pack	194
12.10	Checking the KUKA Power Pack 3	196
12.11	KPP and KSP error messages	196
12.12	KPP and KSP warning messages	200
13	Decommissioning, storage and disposal	205
13.1	Decommissioning	205
13.2	Storage	205
13.3	Disposal	205
14	KUKA Service	207
14.1	Requesting support	207
14.2	KUKA Customer Support	207
	Index	215

1 Introduction

1.1 Industrial robot documentation

The industrial robot documentation consists of the following parts:

- Documentation for the manipulator
- Documentation for the robot controller
- Operating and programming instructions for the System Software
- Instructions for options and accessories
- Parts catalog on storage medium

Each of these sets of instructions is a separate document.

1.2 Representation of warnings and notes

Safety

These warnings are relevant to safety and **must** be observed.

 DANGER	These warnings mean that it is certain or highly probable that death or severe injuries will occur, if no precautions are taken.
---	---

 WARNING	These warnings mean that death or severe injuries may occur, if no precautions are taken.
--	--

 CAUTION	These warnings mean that minor injuries may occur, if no precautions are taken.
--	--

NOTICE	These warnings mean that damage to property may occur, if no precautions are taken.
---------------	--

	These warnings contain references to safety-relevant information or general safety measures. These warnings do not refer to individual hazards or individual precautionary measures.
---	---

This warning draws attention to procedures which serve to prevent or remedy emergencies or malfunctions:



SAFETY INSTRUCTIONS	Procedures marked with this warning must be followed exactly.
----------------------------	--

Hints

These notices serve to make your work easier or contain references to further information.

	Tip to make your work easier or reference to further information.
---	---

1.3 Trademarks

- **Windows** is a trademark of Microsoft Corporation.
-  is a trademark of Beckhoff Automation GmbH.
-  is a trademark of ODVA.

1.4 Terms used

Term	Description
Br M{Number}	Brake Motor {Number}
CCU	Cabinet Control Unit
CIB	Cabinet Interface Board
CIP Safety	Common Industrial Protocol Safety CIP Safety is an Ethernet/IP-based safety interface for connecting a safety PLC to the robot controller. (PLC = master, robot controller = slave)
CK	Customer-built Kinematics
CSP	Controller System Panel Display element and connection point for USB and network
Dual NIC	Dual Network Interface Card Dual-port network card
EDS	Electronic Data Storage (memory card)
EDS cool	Electronic Data Storage (memory card) with extended temperature range
EMD	Electronic Mastering Device
EMC	ElectroMagnetic Compatibility
Ethernet/IP	Ethernet/Internet Protocol is an Ethernet-based field bus.
HMI	Human Machine Interface: KUKA.HMI is the KUKA user interface.
KCB	KUKA Controller Bus
KEB	KUKA Extension Bus
KLI	KUKA Line Interface Connection to higher-level control infrastructure (PLC, archiving)
KOI	KUKA Operator Panel Interface
KONI	KUKA Option Network Interface Interface for KUKA options
KPC	KUKA control PC
KPP	KUKA Power Pack Drive power supply with drive controller
KRL	KUKA Robot Language KUKA programming language
KSB	KUKA System Bus A field bus for internal networking of the controllers
KSI	KUKA Service Interface Interface on the CSP on the control cabinet The WorkVisual PC can either connect to the robot controller via the KLI or it can be plugged into the KSI.

Term	Description
KSP	KUKA Servo Pack Drive controller
KSS	KUKA System Software
Manipulator	The robot arm and the associated electrical installations
M{Number}	Motor {Number}
NA	North America
PELV	Protective Extra Low Voltage External 24 V power supply
QBS	Operator safety acknowledgement signal
RDC	Resolver Digital Converter (KR C4)
RDC cool	Resolver Digital Converter (KR C4) with extended temperature range
RTS	Request To Send Transmission request signal
SATA connections	Data bus for exchanging data between the processor and the hard drive
SG FC	Servo Gun
SIB	Safety Interface Board
SION	Safety I/O Node
SOP	SafeOperation Option with software and hardware components
PLC	A Programmable Logic Controller is used in systems as a higher-level master module in the bus system
SRM	SafeRangeMonitoring Safety option with software and hardware components
SSB	SafeSingleBrake Safety option
US1	Load voltage (24 V) not switched
US2	Load voltage (24 V) switched. Deactivates actuators, for example, when the drives are deactivated
USB	Universal Serial Bus Bus system for connecting additional devices to a computer
EA	External axis (linear unit, Posiflex)

2 Purpose

2.1 Target group

This documentation is aimed at users with the following knowledge and skills:

- Advanced knowledge of electrical and electronic systems
- Advanced knowledge of the robot controller
- Advanced knowledge of the Windows operating system



For optimal use of our products, we recommend that our customers take part in a course of training at KUKA College. Information about the training program can be found at www.kuka.com or can be obtained directly from our subsidiaries.

2.2 Intended use

Use The robot controller is intended solely for operating the following components:

- KUKA industrial robots
- KUKA linear units
- KUKA positioners
- Robot kinematic systems according to DIN EN ISO 10218-1

Misuse Any use or application deviating from the intended use is deemed to be misuse and is not allowed. This includes e.g.:

- Use as a climbing aid
- Operation outside the permissible operating parameters
- Use in potentially explosive environments
- Use in underground mining

3 Product description

3.1 Overview of the industrial robot

The industrial robot consists of the following components:

- Manipulator
- Robot controller
- Teach pendant
- Connecting cables
- Software
- Options, accessories

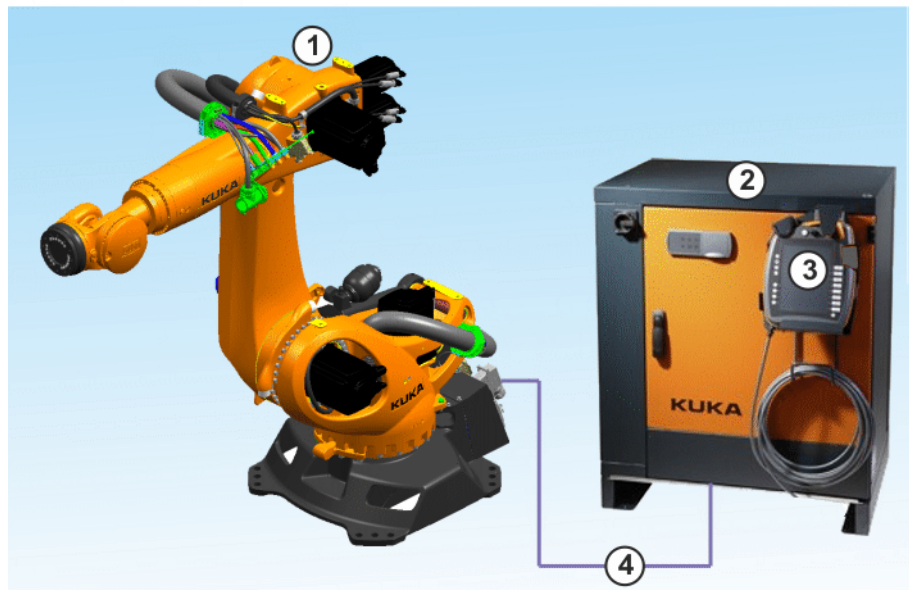

Fig. 3-1: Example of an industrial robot

- | | |
|--------------------|---------------------|
| 1 Manipulator | 3 Teach pendant |
| 2 Robot controller | 4 Connecting cables |

3.2 Overview of the robot controller

The robot controller consists of the following components:

- Control PC (KPC)
- Low-voltage power supply unit
- Drive power supply with drive controller: KUKA Power Pack (KPP)
- Drive controller: KUKA Servo Pack (KSP)
- Teach pendant (KUKA smartPAD)
- Cabinet Control Unit (CCU)
- Controller System Panel (CSP)
- Safety Interface Board (SIB)
- Fuse elements
- Batteries
- Fans
- Connection panel

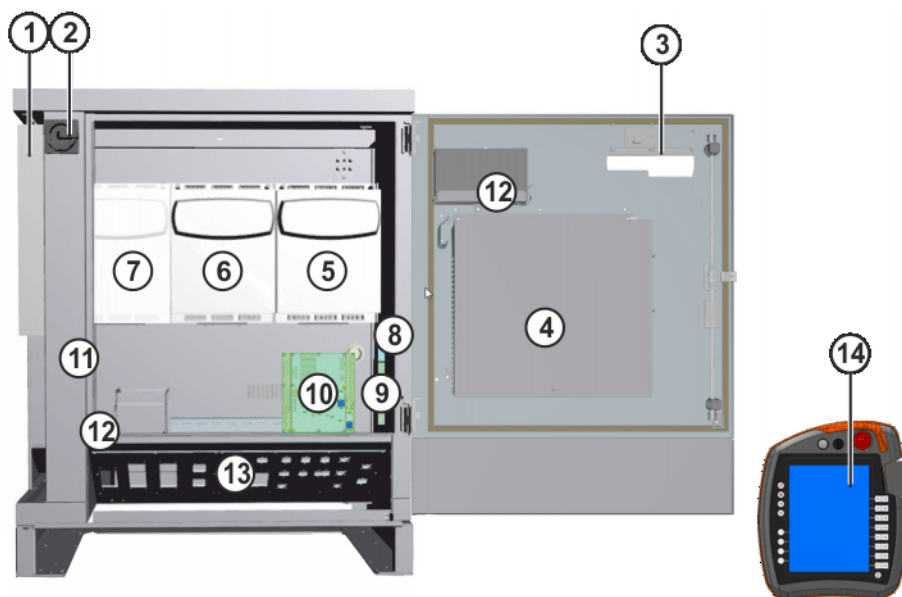

Fig. 3-2: Overview of the robot controller, front view

- | | |
|---|---|
| 1 Mains filter | 8 Brake filter |
| 2 Main switch | 9 CCU |
| 3 CSP | 10 SIB/Extended SIB |
| 4 Control PC | 11 Fuse element |
| 5 Drive power supply (drive controller, optional) | 12 Batteries (positioning depending on variant) |
| 6 Drive controller | 13 Connection panel |
| 7 Drive controller (optional) | 14 KUKA smartPAD |

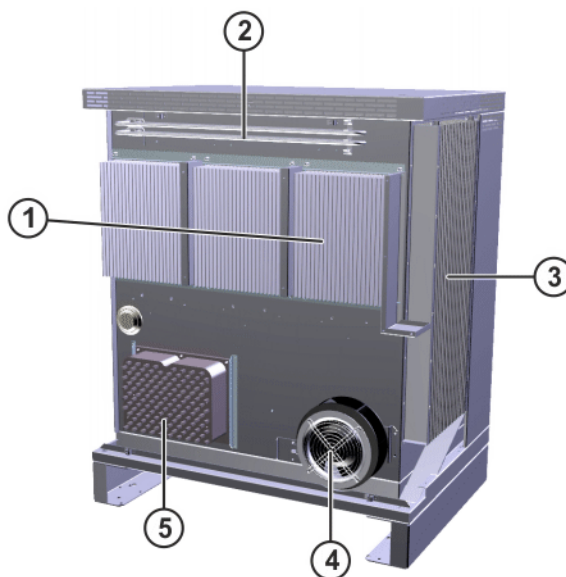

Fig. 3-3: Overview of robot controller, rear view

- | | |
|---------------------|---------------------------------|
| 1 KSP/KPP heat sink | 4 External fan |
| 2 Brake resistor | 5 Low-voltage power supply unit |
| 3 Heat exchanger | |

3.3 KUKA Power Pack

Description	<p>The KUKA Power Pack (KPP) is the drive power supply and generates a rectified intermediate circuit voltage from an AC power supply. This intermediate circuit voltage is used to supply the internal drive controllers and external drives. There are 4 different device variants, all having the same size. There are LEDs on the KPP which indicate the operating state.</p> <ul style="list-style-type: none"> ■ KPP without axis amplifier (KPP 600-20) ■ KPP with amplifier for one axis (KPP 600-20-1x40) Peak output current 1x40 A ■ KPP with amplifier for two axes (KPP 600-20-2x40) Peak output current 2x40 A ■ KPP with amplifier for three axes (KPP 600-20-3x20) Peak output current 3x20 A ■ KPP with amplifier for one axis (KPP 600-20-1x64) Peak output current 1x64 A
Functions	<p>The KPP has the following functions:</p> <ul style="list-style-type: none"> ■ KPP central AC power supply connection in interconnected operation ■ Power output with 400 V supply voltage: 14 kW ■ Rated current: 25 A DC ■ Connection and disconnection of the supply voltage ■ Powering of several axis amplifiers from the DC link ■ Integrated brake chopper through connection of an external ballast resistor ■ Overload monitoring by the ballast resistor ■ Stopping of synchronous servomotors by means of short-circuit braking

3.4 KUKA Servo Pack

Description	<p>The KUKA Servo Pack (KSP) is the drive controller for the manipulator axes. There are 3 different device variants, all having the same size. There are LEDs on the KSP which indicate the operating state.</p> <ul style="list-style-type: none"> ■ KSP for 3 axes (KSP 600-3x40) Peak output current 3x 40 A ■ KSP for 3 axes (KSP 600-3x64) Peak output current 3x 64 A ■ KSP for 3 axes (KSP 600-3x20) Peak output current 3x 20 A
Functions	<p>The KSP has the following functions:</p> <ul style="list-style-type: none"> ■ Power range: 11 kW to 14 kW per axis amplifier ■ Direct infeed of the DC intermediate circuit voltage ■ Field-oriented control for servomotors: Torque control

3.5 Control PC

PC components	<p>The control PC (KPC) includes the following components:</p> <ul style="list-style-type: none"> ■ Power supply unit ■ Motherboard ■ Processor
----------------------	--

- Heat sink
- Memory modules
- Hard drive
- LAN Dual NIC network card (not present on all motherboard variants)
- PC fan
- Optional modules, e.g. field bus cards

Functions

The control PC (KPC) is responsible for the following functions of the robot controller:

- User interface
- Program creation, correction, archiving, and maintenance
- Sequence control
- Path planning
- Control of the drive circuit
- Monitoring
- Safety equipment
- Communication with external periphery (other controllers, host computers, PCs, network)

3.6 Cabinet Control Unit**Description**

The Cabinet Control Unit (CCU) is the central power distributor and communication interface for all components of the robot controller. The CCU consists of the Cabinet Interface Board (CIB) and the Power Management Board (PMB). All data are transferred via this internal communication interface to the controller for further processing. If the mains voltage fails, the control components continue to be powered by batteries until the position data are saved and the controller has shut down. The charge and quality of the batteries are checked by means of a load test.

Functions

- Communication interface for the components of the robot controller
- Safe inputs and outputs
 - Control of main contactors 1 and 2
 - Mastering test
 - KUKA smartPAD plugged in
- 4 Fast Measurement inputs for customer applications
- Monitoring of the fans in the robot controller
 - Fans
 - Control PC fan
- Temperature sensing:
 - Thermostatic switch for transformer
 - Alarm contact for cooling unit
 - Alarm contact for main switch
 - Temperature sensor for ballast resistor
 - Temperature sensor for internal cabinet temperature
- The following components are connected to the KPC via the KUKA Controller Bus:
 - KPP/KSP
 - Resolver Digital Converter
- The following operator panels and service devices are connected to the control PC via the KUKA System Bus:
 - KUKA Operator Panel Interface

- Diagnostic LEDs
- Electronic Data Storage Interface

Power supply with battery backup

- KPP
- KSP
- KUKA smartPAD
- Multi-core control PC
- Controller System Panel (CSP)
- Resolver Digital Converter (RDC)
- Standard SIB or Standard and Extended SIB (optional)

Power supply without battery backup

- Motor brakes
- External fan
- Customer interface

3.7 Safety Interface Board

Description The Safety Interface Board (SIB) is an integral part of the safety interface. 2 different SIBs are used in the robot controller, the Standard SIB and the Extended SIB, depending on the configuration of the safety interface. The Standard SIB and the Extended SIB incorporate sensing, control and switching functions. The Extended SIB can only be operated together with the Standard SIB. The output signals are provided as electrically isolated outputs.

The Standard SIB contains the following safe inputs and outputs:

- 5 safe inputs
- 3 safe outputs

The Extended SIB contains the following safe inputs and outputs:

- 8 safe inputs
- 8 safe outputs

Functions The Standard SIB has the following functions:

- Safe inputs and outputs for the discrete safety interface of the robot controller

The Extended SIB has the following functions:

- Safe inputs and outputs for range selection and range monitoring for the SafeRobot option

or optionally

- Provision of signals for axis range monitoring

3.8 Resolver Digital Converter

Description The Resolver Digital Converter (RDC) is used to detect the motor position data. 8 resolvers can be connected to the RDC. In addition, the motor temperatures are measured and evaluated. For non-volatile data storage, the EDS is located in the RDC box.

2 different RDCs are used in the robot controller according to the specific customer requirements:

- RDC
Temperature range +5 ... 55 °C (278 ... 328 K)

- RDC cool
Temperature range -30 ... +55 °C (243 ... 328 K)

If an RDC cool is used, an EDS cool must also be used.

Functions

The RDC has the following functions:

- Safe acquisition of up to 8 motor position data streams via resolver
- Detection of up to 8 motor operating temperatures
- Communication with the robot controller
- Monitoring of the resolver cables
- The following non-volatile data are stored on the EDS:
 - Position data
 - KUKA configuration

3.9 Controller System Panel

Description

The Controller System Panel (CSP) is a display element for the operating state and has the following connections:

- USB1
- USB2
- KLI (optional)
- KSI (optional)

Overview

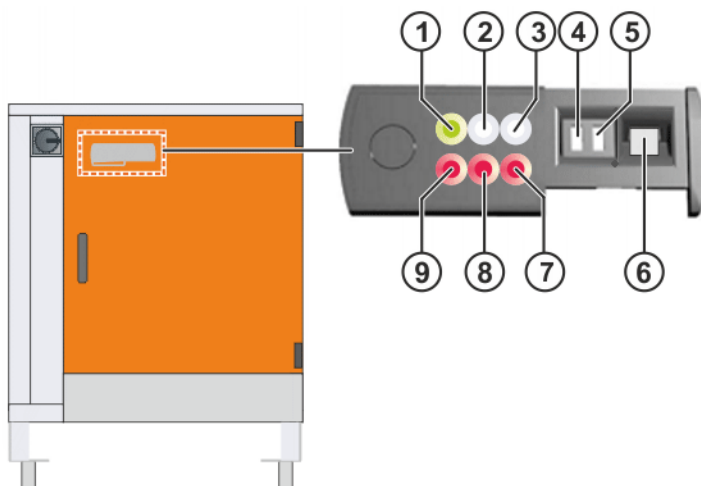

Fig. 3-4: Arrangement of LEDs and connectors on CSP

Item	Component	Color	Meaning
1	LED 1	Green	Operating LED
2	LED 2	White	Sleep LED
3	LED 3	White	Automatic LED
4	USB 1	-	-
5	USB 2	-	-
6	RJ45	-	KLI; KSI
7	LED 6	Red	Error LED 3
8	LED 5	Red	Error LED 2
9	LED 4	Red	Error LED 1

3.10 Low-voltage power supply unit

Description The low-voltage power supply unit provides power to the components of the robot controller.

A green LED indicates the operating state of the low-voltage power supply unit.

3.11 24 V external power supply

External 24 V power supply is possible via the following interfaces:

- RoboTeam X57
- Interface X11
- Connector X55

Power supply to the KLI switch in the robot controller

The external power supply to the SIB and CIB boards cannot be isolated. If the SIB is supplied externally, the CIB is also supplied externally, and vice versa.

3.12 Batteries

Description In the event of a power failure, or if the power is switched off, the batteries enable the robot controller to be shut down in a controlled manner. The batteries are charged via the CCU and the charge is checked and indicated.

3.13 Mains filter

Description The mains filter (interference suppressor filter) suppresses interference voltages on the power cable.

3.14 Bus devices

Overview

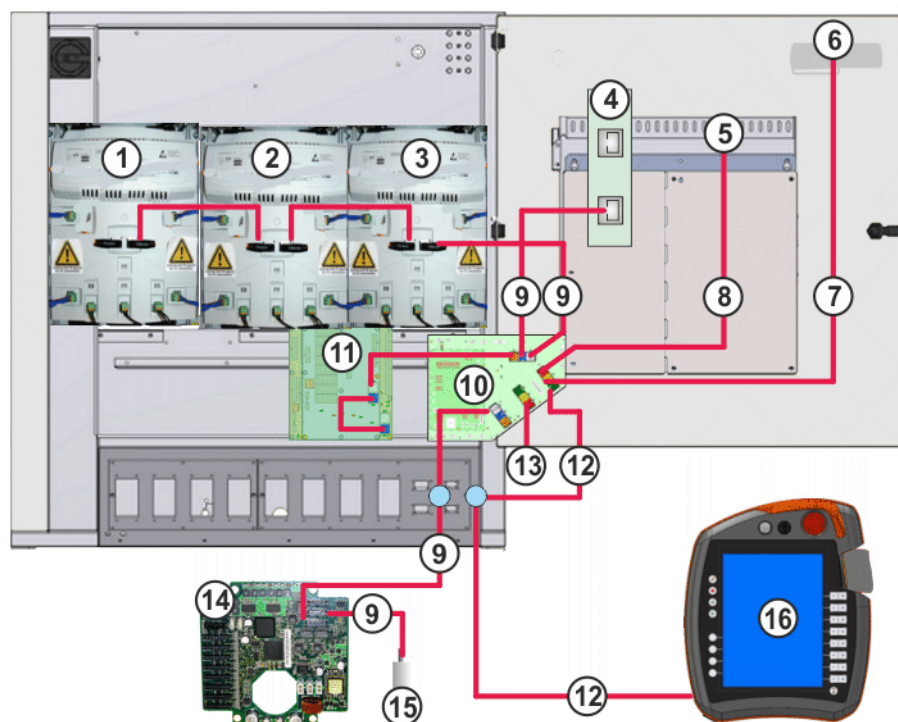

Fig. 3-5: Overview of bus devices

- | | | | |
|---|-----------------------|----|-----------------------------------|
| 1 | KSP, left (optional) | 9 | KUKA Controller Bus (KCB) |
| 2 | KSP, middle | 10 | CCU |
| 3 | KPP | 11 | Standard/Extended SIB (optional) |
| 4 | LAN Dual NIC card | 12 | KOI |
| 5 | Ethernet motherboard | 13 | KUKA Extension Bus (KEB) |
| 6 | CSP | 14 | RDC |
| 7 | KSI/KLI | 15 | Electronic Mastering Device (EMD) |
| 8 | KUKA System Bus (KSB) | 16 | KUKA smartPAD |

3.14.1 KCB devices

KCB devices The KCB includes the following devices:

- KPP
- KSP, middle
- KSP, left
- RDC
- CIB
- EMD

3.14.2 KSB devices and configuration variants

KSB devices The KSB includes the following devices:

- CIB SION
- smartPAD SION
- Standard SIB (optional)
- Standard/Extended SIB (optional)

Configuration variants

Application	Config.	CIB	Standard SIB	Extended SIB
Standard Safety without/with SOP via PROFIsafe	Variant 1	X	-	-
Standard Safety via interface	Variant 2	X	X	-
Standard Safety with SOP via interface	Variant 3	X	X	X
Standard Safety without/with SOP via CIP Safety	Variant 4	X	-	-

3.14.3 KEB devices and configuration variants

KEB devices The following components are KEB devices:

- PROFIBUS master
- PROFIBUS slave
- PROFIBUS master/slave
- Expansion of digital I/Os 16/16
- DeviceNet master
- DeviceNet slave
- DeviceNet master/slave

- Digital I/Os 16/16
- Digital I/Os 16/16/4
- Digital I/Os 32/32/4
- Digital/analog I/Os 16/16/2
 - Additional digital I/Os 16/8, welding cabinet (optional)
- Digital/analog I/Os 32/32/4

Configuration variants

Application	Config.	Bus	
Connection of PROFIBUS devices	Variant 1	PROFIBUS master	
Connection to line PLC with PROFIBUS interface	Variant 2	PROFIBUS slave	
Connection of PROFIBUS devices Connection to line PLC with Profibus interface	Variant 3	PROFIBUS master/slave	
Connection of PROFIBUS devices Connection of 16 dig. inputs and 16 dig. outputs with 0.5 A	Variant 4	PROFIBUS master	Expansion of digital I/Os 16/16
Connection to line PLC with PROFIBUS interface Connection of 16 dig. inputs and 16 dig. outputs with 0.5 A	Variant 5	PROFIBUS slave	
Connection of PROFIBUS devices Connection to line PLC with PROFIBUS interface Connection of 16 dig. inputs and 16 dig. outputs with 0.5 A	Variant 6	PROFIBUS master/slave	
Connection of 16 dig. inputs and 16 dig. outputs with 0.5 A	Variant 7	Digital I/Os 16/16	
Connection of 16 dig. inputs and 16 dig. outputs with 0.5/2 A	Variant 8	Digital I/Os 16/16/4	
Connection of 32 dig. inputs and 32 dig. outputs with 0.5/2 A	Variant 9	Digital I/Os 32/32/4	
VKR C2-compatible interface for connection to line PLC	Variant 10	Retrofit	
Connection of EtherCAT devices	Variant 11	-	
Connection of DeviceNet devices	Variant 12	DeviceNet master	
Connection to line PLC with DeviceNet interface	Variant 13	DeviceNet slave	
Connection of DeviceNet devices Connection to line PLC with DeviceNet interface	Variant 14	DeviceNet master/slave	

Application	Config.	Bus	
Connection of DeviceNet devices Connection of 16 dig. inputs and 16 dig. outputs with 0.5 A.	Variant 15	DeviceNet master	Expansion of digital I/Os 16/16
Connection to line PLC with DeviceNet interface Connection of 16 dig. inputs and 16 dig. outputs with 0.5 A.	Variant 16	DeviceNet slave	
Connection of DeviceNet devices Connection to line PLC with DeviceNet interface Connection of 16 dig. inputs and 16 dig. outputs with 0.5 A.	Variant 17	DeviceNet master/slave	
Connection of 16 dig. inputs and 16 dig. outputs with 0.5/2 A and 2 analog inputs	Variant 18	Expansion of digital and analog I/Os 16/16/2	
Connection of 16 dig. inputs and 16 dig. outputs with 0.5/2 A and 2 analog inputs and an additional 16 digital inputs and 8 digital outputs	Variant 19	Expansion of digital I/Os 16/16/2 with additional 16 digital inputs and 8 digital outputs	
Connection of 32 dig. inputs and 16 dig. outputs with 0.5/4 A and 2 analog inputs	Variant 20	Expansion of digital and analog I/Os 32/32/4	

In the following cases a system modification must be carried out by the customer using WorkVisual after connecting customer-specific devices to the corresponding interfaces:

- Connection of PROFIBUS devices
- Connection of EtherCAT devices

3.15 Connection panel interfaces

Overview

The connection panel of the robot controller consists of connections for the following cables:

- Power cable / infeed
- Motor cables to the manipulator
- Data cables to the manipulator
- KUKA smartPAD cable
- PE cables
- Peripheral cables

The configuration of the connection panel varies according to the customer-specific version and the options required.

Note

The following safety interfaces can be configured in the robot controller:

- Discrete safety interface X11
- Ethernet safety interface X66
 - PROFIsafe KLI or
 - CIP Safety KLI



The discrete safety interface X11 and the Ethernet safety interface X66 cannot be connected and used together.
Only one of the safety interfaces can be used at a time.

The configuration of the connection panel varies according to customer requirements and options. In this documentation, the robot controller is described with the maximum configuration.

Connection panel

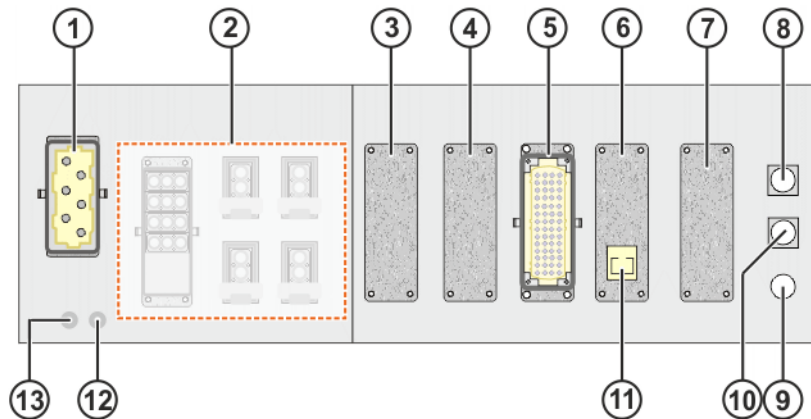

Fig. 3-6: Connection panel overview

- 1 XS1 Power supply connection
- 2 Motor connector interfaces
- 3 Option
- 4 Option
- 5 X11 Safety interface
- 6 Option
- 7 Option
- 8 X19 smartPAD connection
- 9 X42 optional
- 10 X21 RDC connection
- 11 X66 Ethernet safety interface
- 12 PE1 Ground conductor to manipulator
- 13 PE2 Ground conductor to main infeed

i Only safety interface X11 or Ethernet safety interface X66 (PRO-FIsafe/CIP Safety) can be configured.

i The optional interfaces in the connection panel are described in the assembly and operating instructions "Optional Interfaces for KR C4".

i All contactor, relay and valve coils that are connected to the robot controller by the user must be equipped with suitable suppressor diodes. RC elements and VCR resistors are not suitable.

3.16 Motor connector Xxx, external axes X7.1, X7.2, X7.3

Connection panel

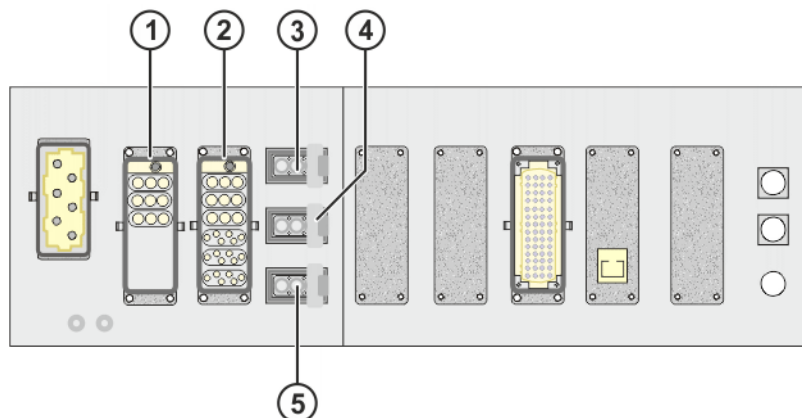

Fig. 3-7: Connection panel

- 1 Slot 1 (>>> "Assignment of slot 1" Page 26)
- 2 Slot 2 (>>> "Assignment of slot 2" Page 26)
- 3 X7.1 Motor connection, external axis 7
- 4 X7.2 Motor connection for external axis 8
- 5 X7.3 Motor connection for external axis 9

Assignment of slot 1

Slot 1 can be assigned the following motor connections:

- X20.1 Motor connector, heavy-duty robot, axes 1-3
- X8 Motor connector, heavy-duty palletizing robot, axes 1-3 and 6
- X81 Motor connector, axes 1 to 4

Assignment of slot 2

Slot 2 can be assigned the following motor connections:

- X20 Motor connector, axes 1 to 6
- X20.4 Motor connector, heavy-duty robot, axes 4 to 6
- X20.4 Motor connector, heavy-duty palletizing robot, axes 5 and 6
- X82 Motor connector, axes 5 to 8

Designations

These designations are used in the following wiring diagrams:

- Mx Motor x
- Br Mx Brake, motor x

3.16.1 Connector pin allocation, motor connector X20

Connector pin
allocation

Fig. 3-8: Connector pin allocation for X20

3.16.2 Connector pin allocation for motor connector X20 with 1 KPP and 1 KSP

Connector pin allocation

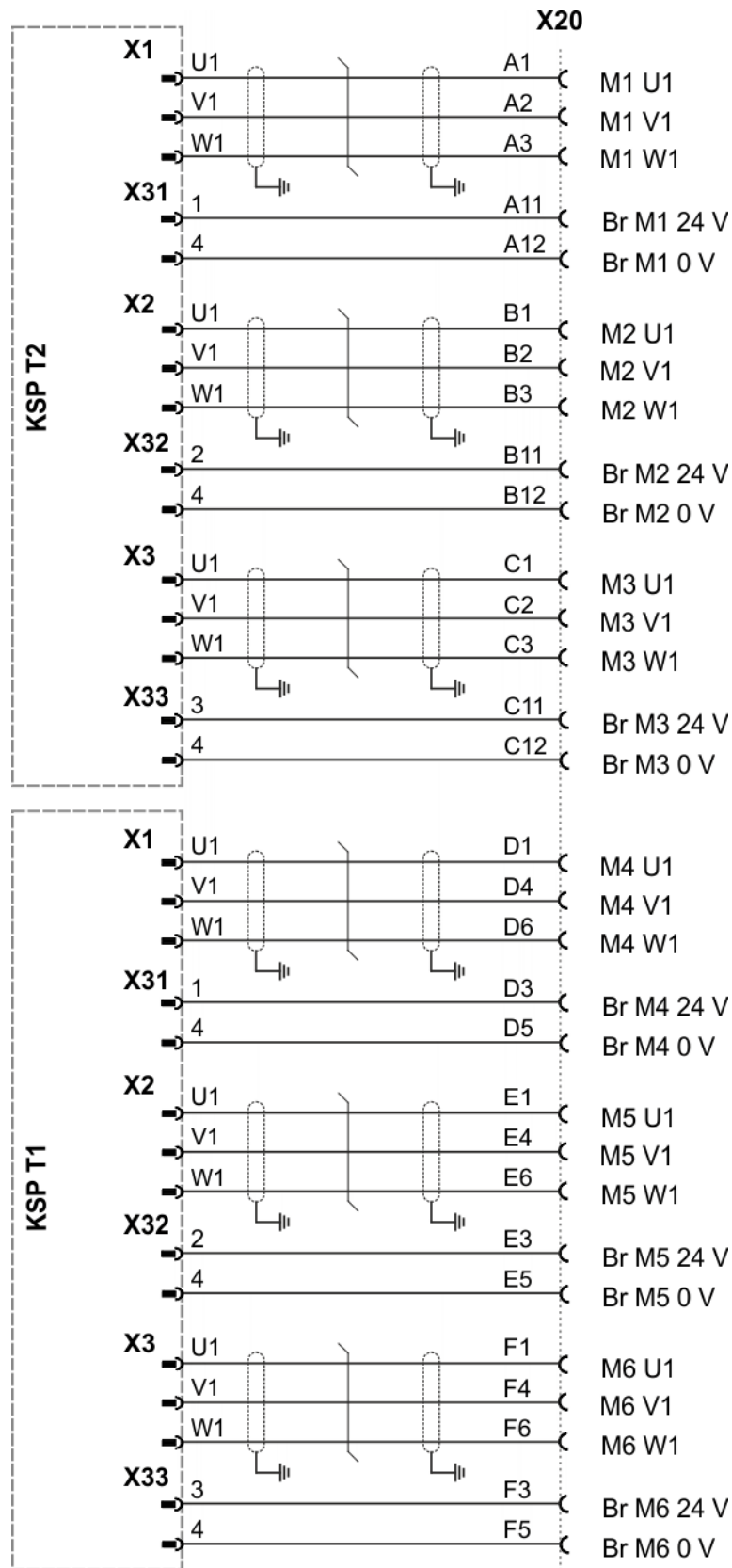
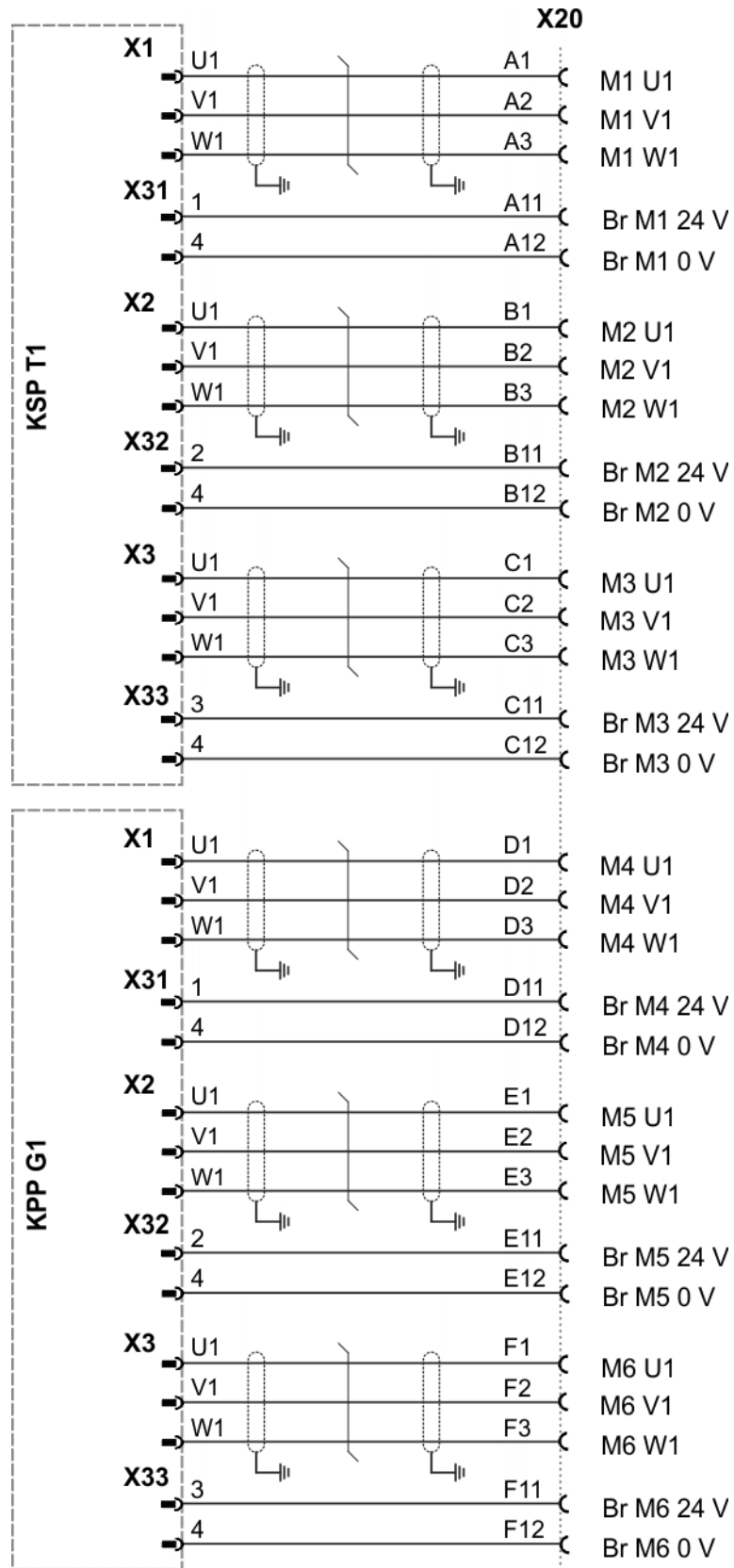

Fig. 3-9: Connector pin allocation for X20

3.16.3 Connector pin allocation X20.1 and X20.4 (heavy-duty robot)

Connector pin allocation

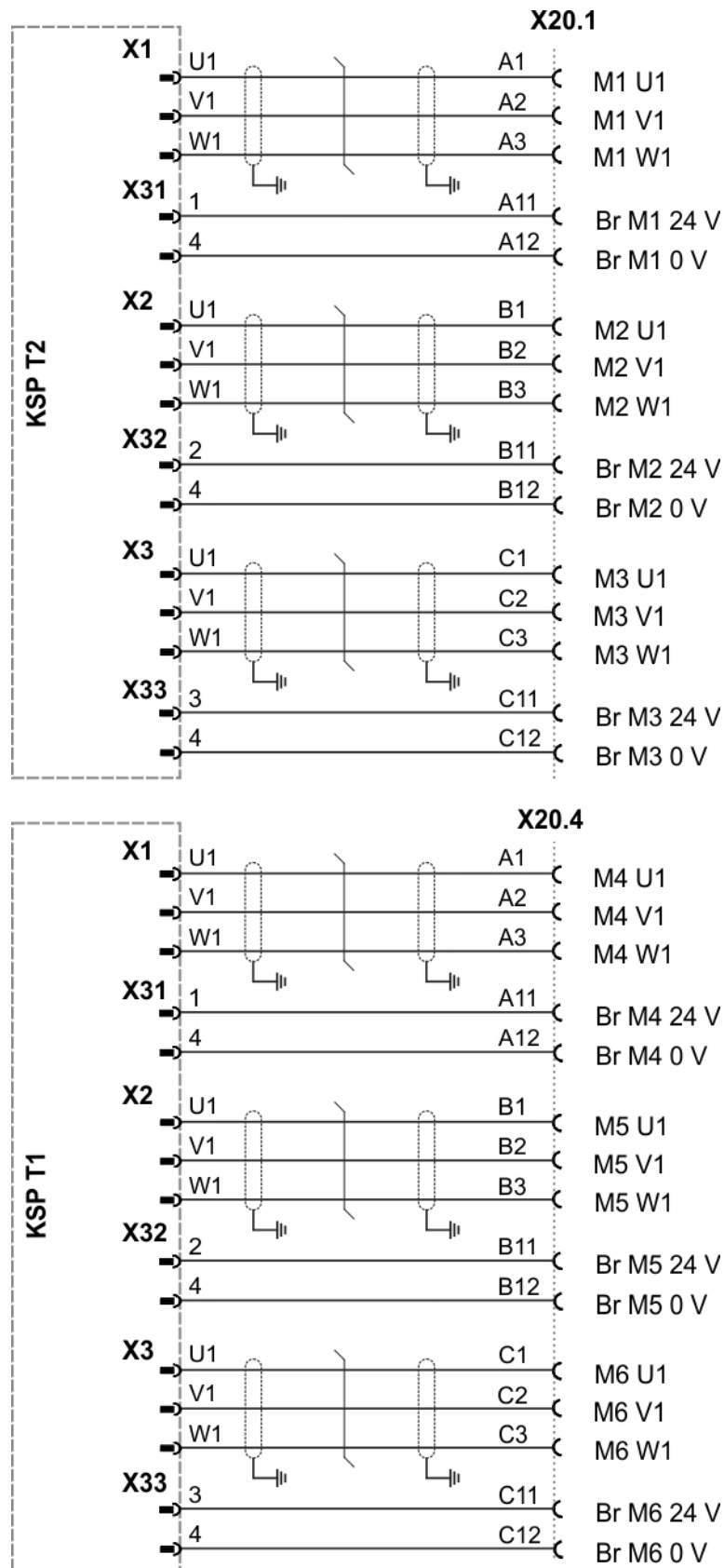

Fig. 3-10: Connector pin allocation X20.1 and X20.4 for heavy-duty robot

3.16.4 Connector pin allocation X7.1 for external axis 1

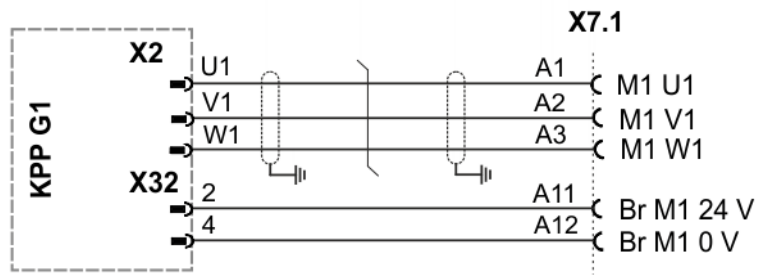

Fig. 3-11: Single connector X7.1

3.16.5 Connector pin allocation X7.1 and X7.2 for external axes 1 and 2

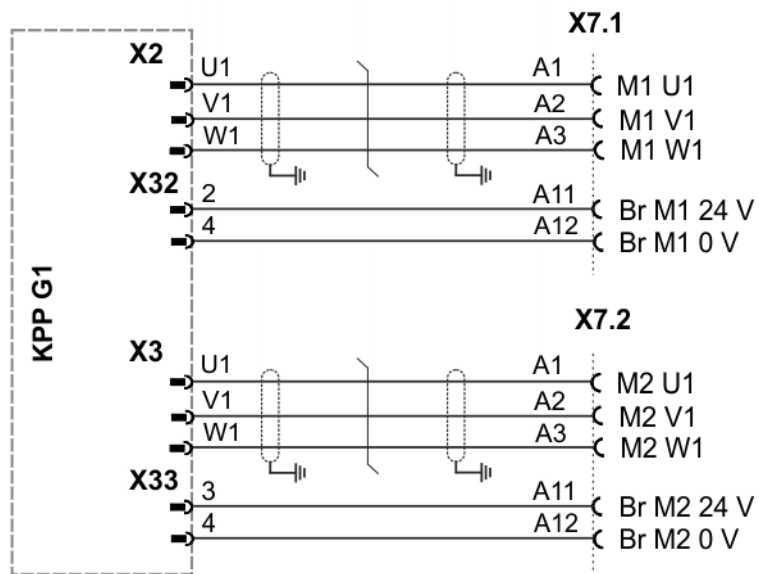

Fig. 3-12: Single connectors X7.1 and X7.2

3.16.6 Connector pin allocation X7.1, X7.2 and X7.3 for external axes 1, 2 and 3

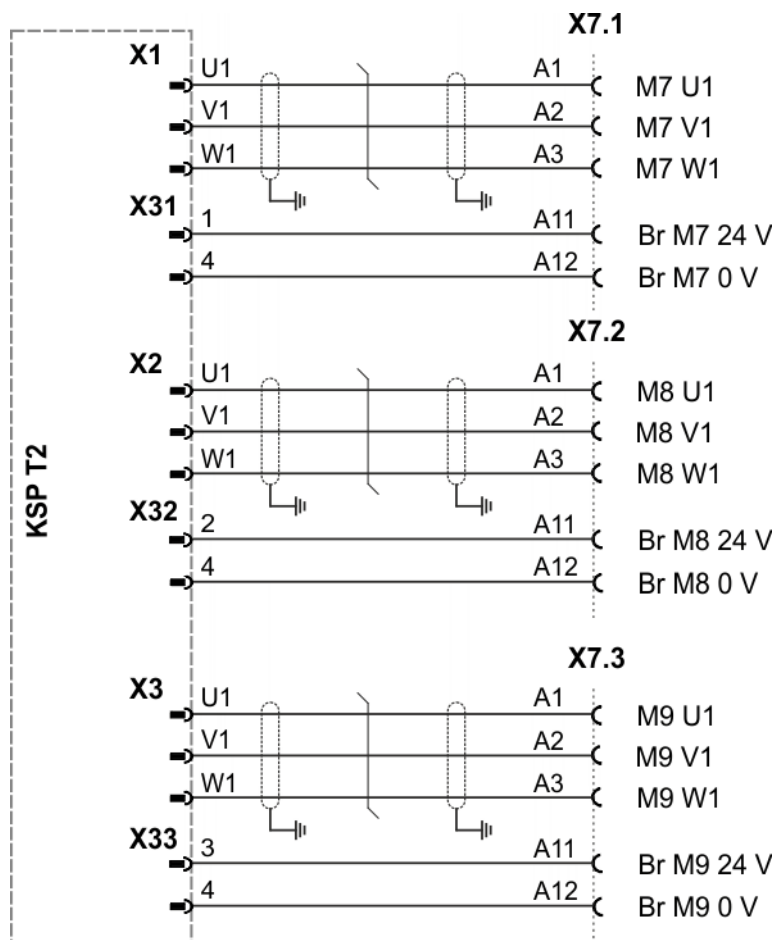

Fig. 3-13: Single connectors X7.1, X7.2 and X7.3

3.16.7 Connector pin allocation X8 (heavy-duty palletizing robot) (4 axes)

Connector pin allocation

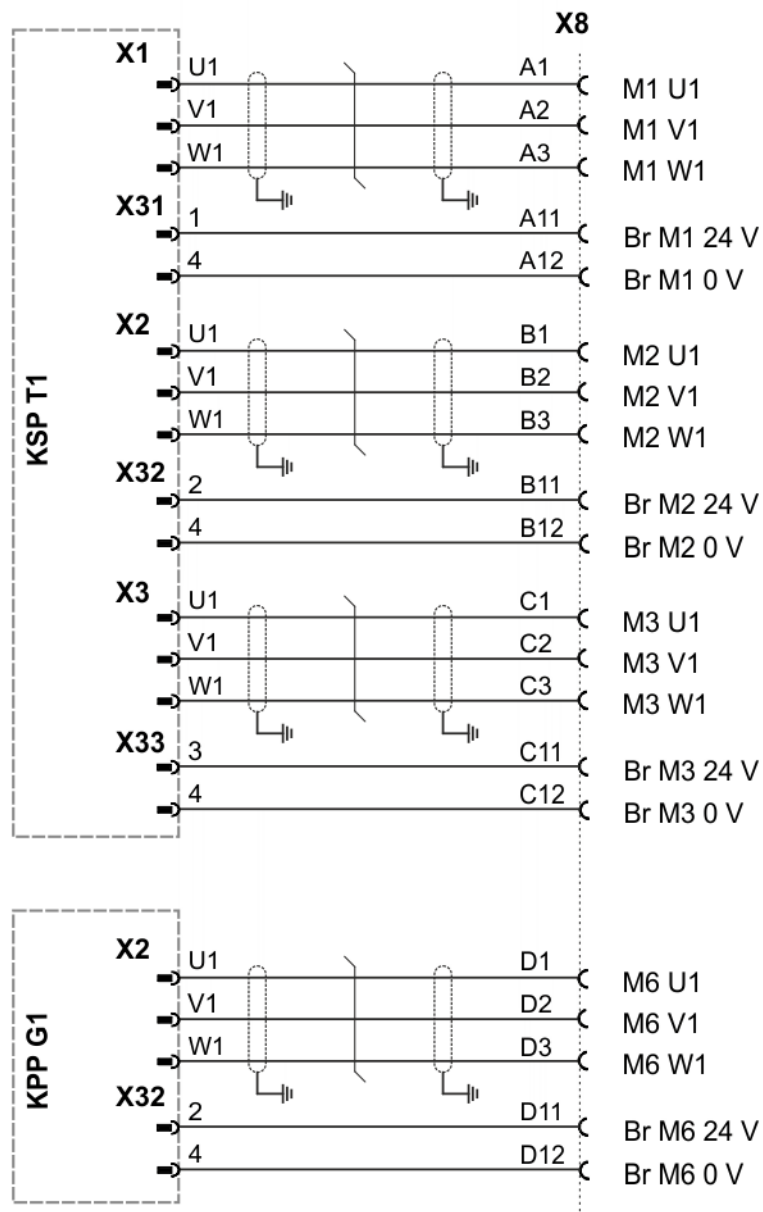

Fig. 3-14: 4-axis heavy-duty palletizing robot, connector pin allocation X8

3.16.8 Connector pin allocation X20 (palletizing robot) (4 axes)

Connector pin allocation

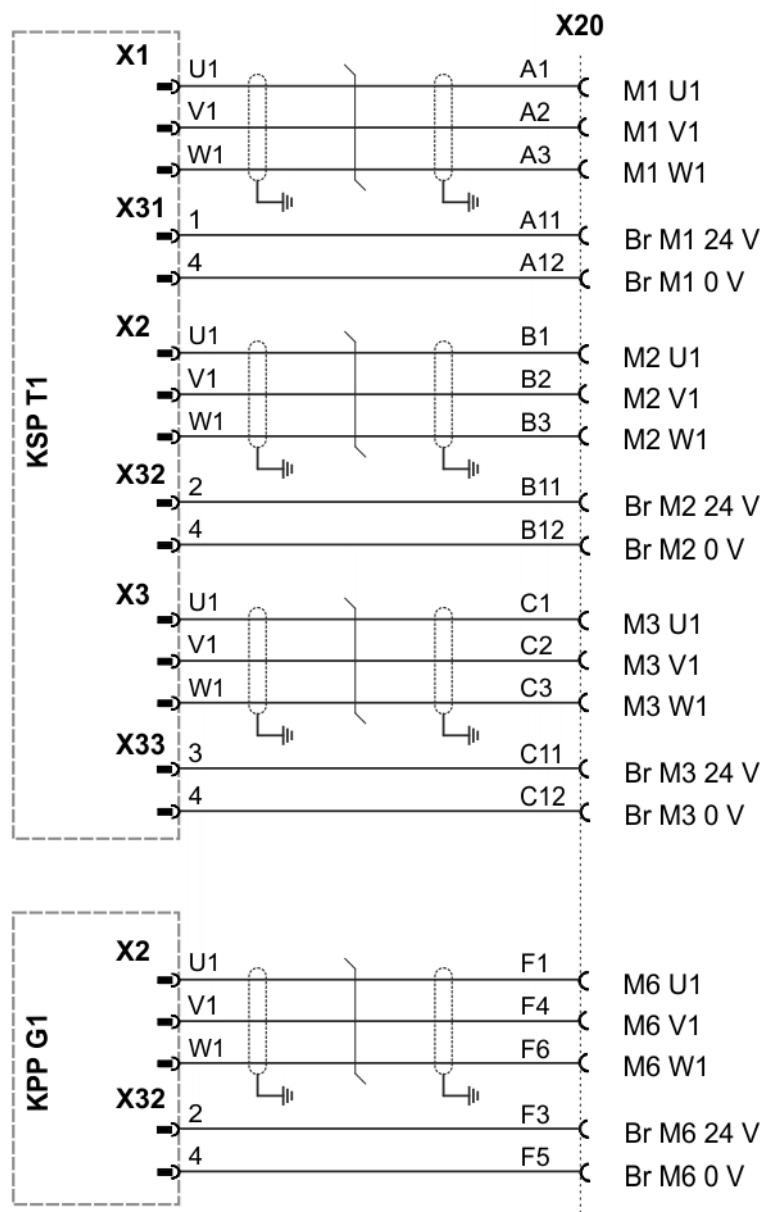

Fig. 3-15: 4-axis palletizing robot, connector pin allocation X20

3.16.9 Connector pin allocation X20.1 and X20.4 (heavy-duty palletizing robot) (5 axes)

Connector pin allocation

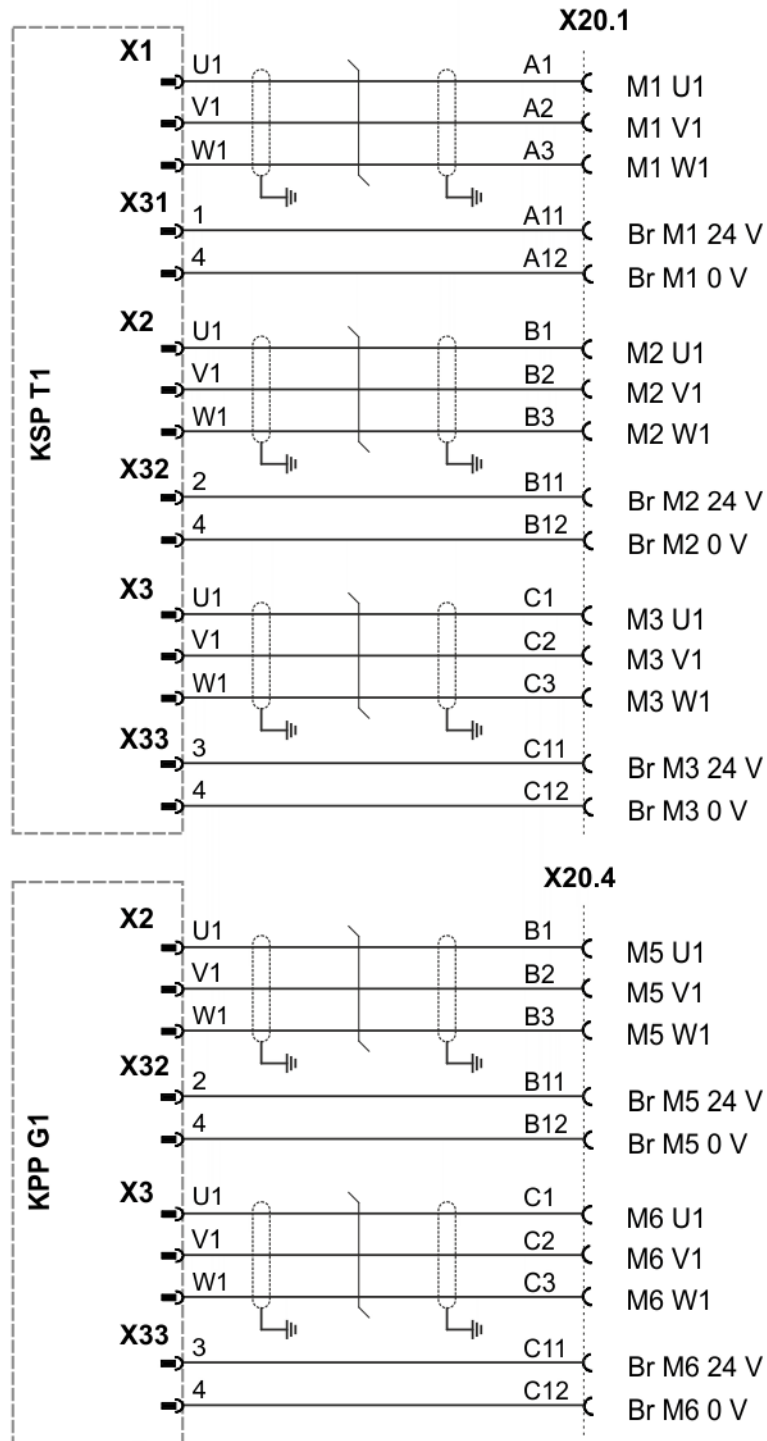

Fig. 3-16: 5-axis heavy-duty palletizing robot, connector pin allocation X20.1 and X20.4

3.16.10 Connector pin allocation X20 (palletizing robot) (5 axes)

Connector pin
allocation

Fig. 3-17: 5-axis palletizing robot, connector pin allocation X20

3.16.11 Connector pin allocation X81 (4 axes)

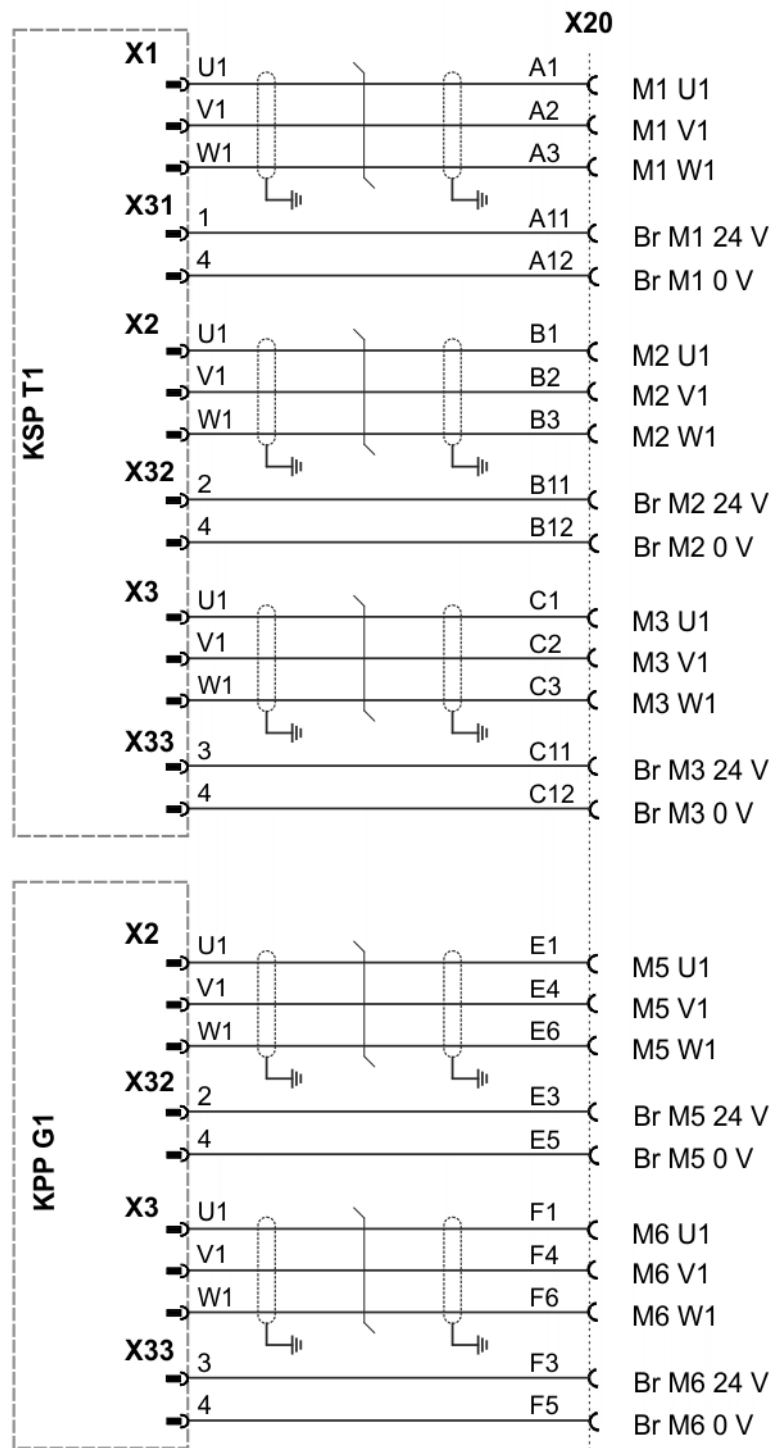
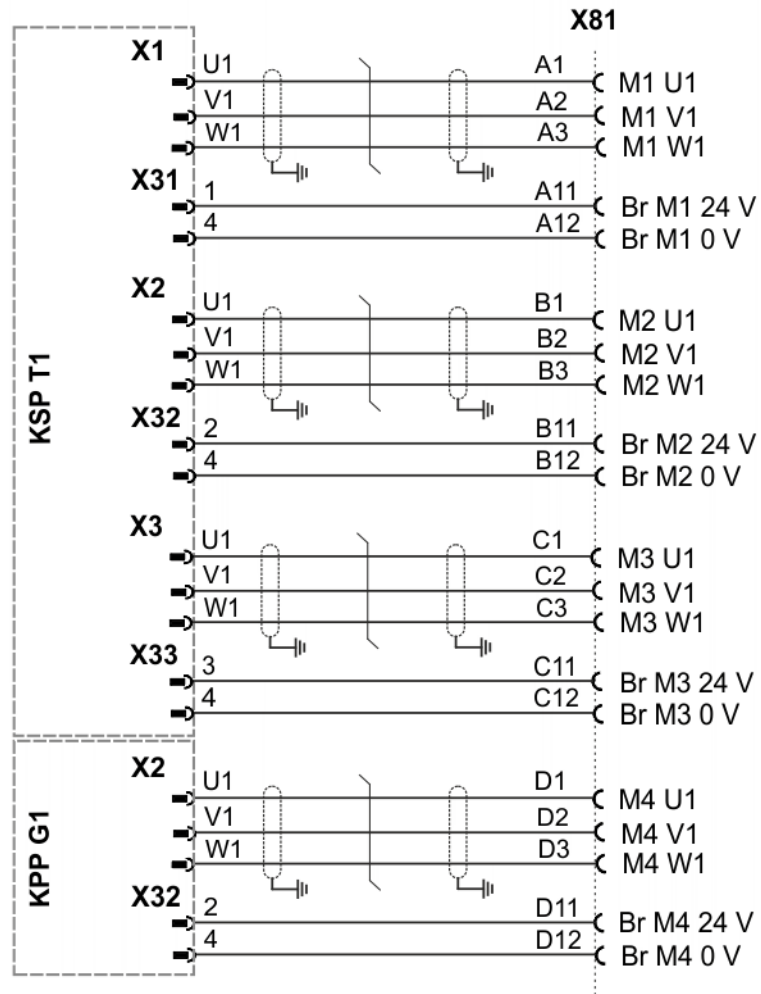

Fig. 3-18: Multiple connector X81

3.16.12 Connector pin allocation X82 (8 axes)

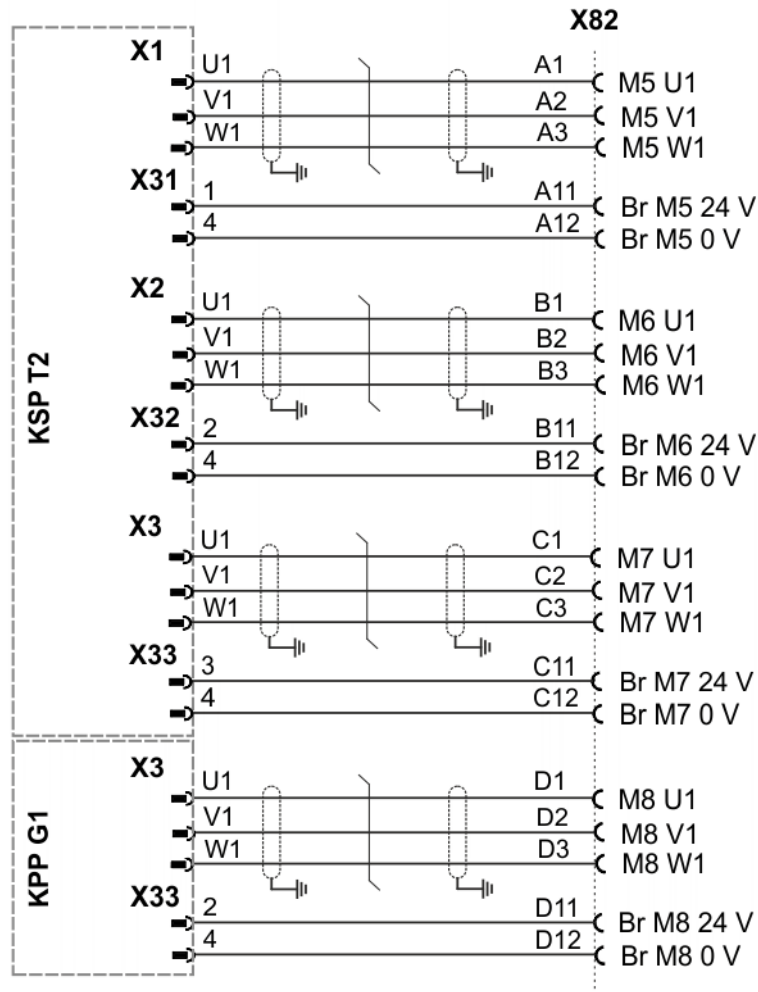

Fig. 3-19: Multiple connector X82

3.16.13 Connector pin allocation X7.1 for palletizing robot, external axis 1

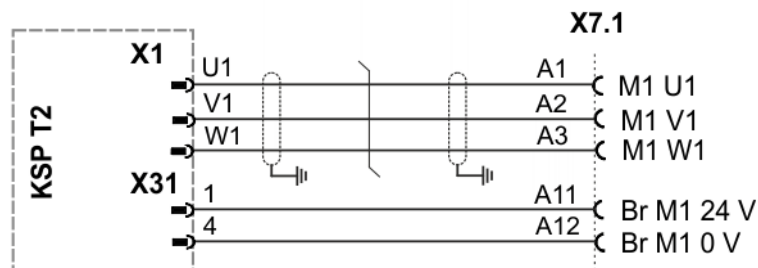

Fig. 3-20: Single connector X7.1

3.16.14 Connector pin allocation X7.1 and X7.2 for palletizing robot, for external axes 1 and 2

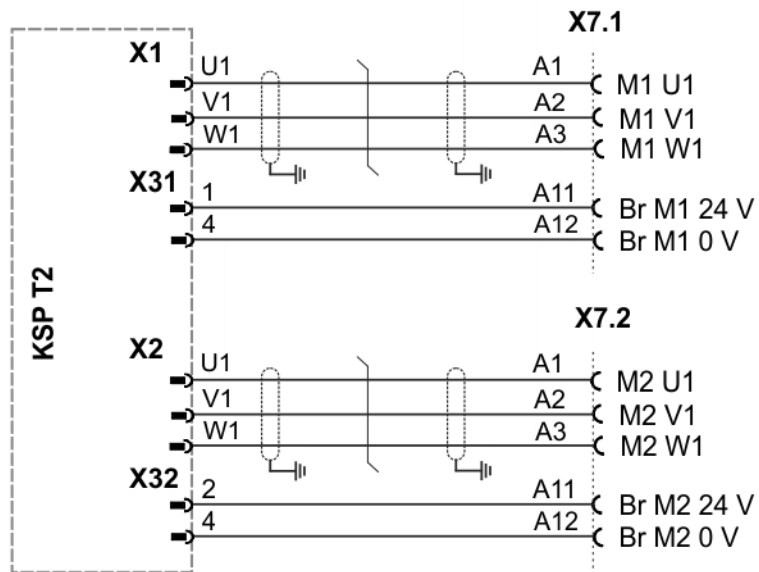

Fig. 3-21: Single connectors X7.1 and X7.2

3.17 Multiple connector X81, single connectors X7.1 to X7.4

Connection panel

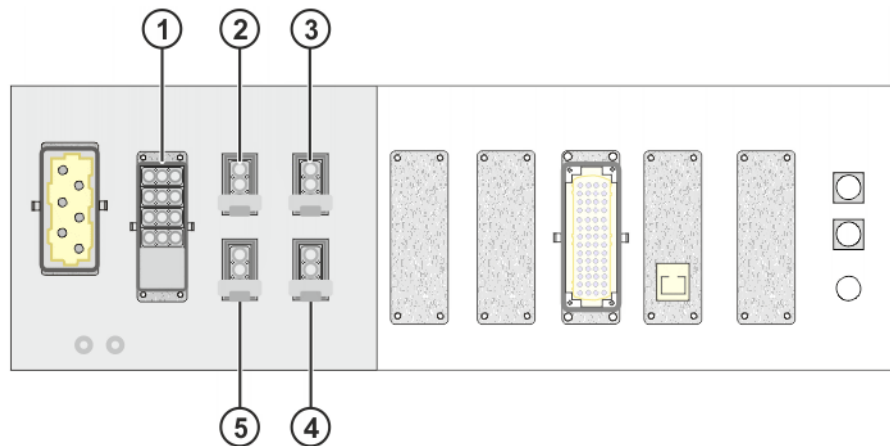

Fig. 3-22: Connection panel with X81 and X7.1 to X7.4

- 1 Multiple connector X81 for axes 1 to 4
- 2 Single connector X7.1 for axis 5
- 3 Single connector X7.3 for axis 7
- 4 Single connector X7.4 for axis 8
- 5 Single connector X7.2 for axis 6

Designations

These designations are used in the following wiring diagrams:

- Mx Motor x
- Br Mx Brake, motor x

3.17.1 Connector pin allocation X81 (3 axes)

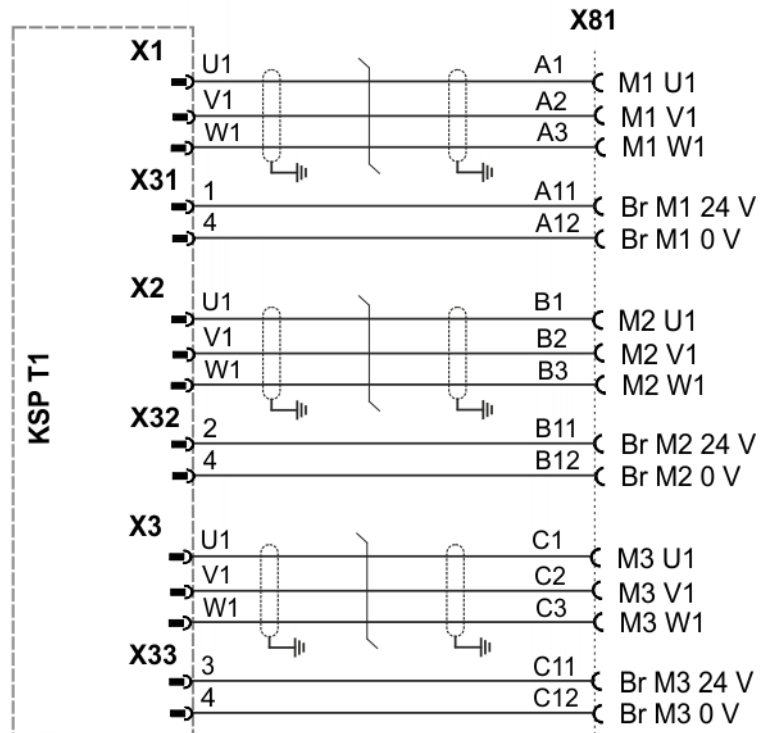

Fig. 3-23: Multiple connector X81

3.17.2 Connector pin allocation X81 (4 axes)

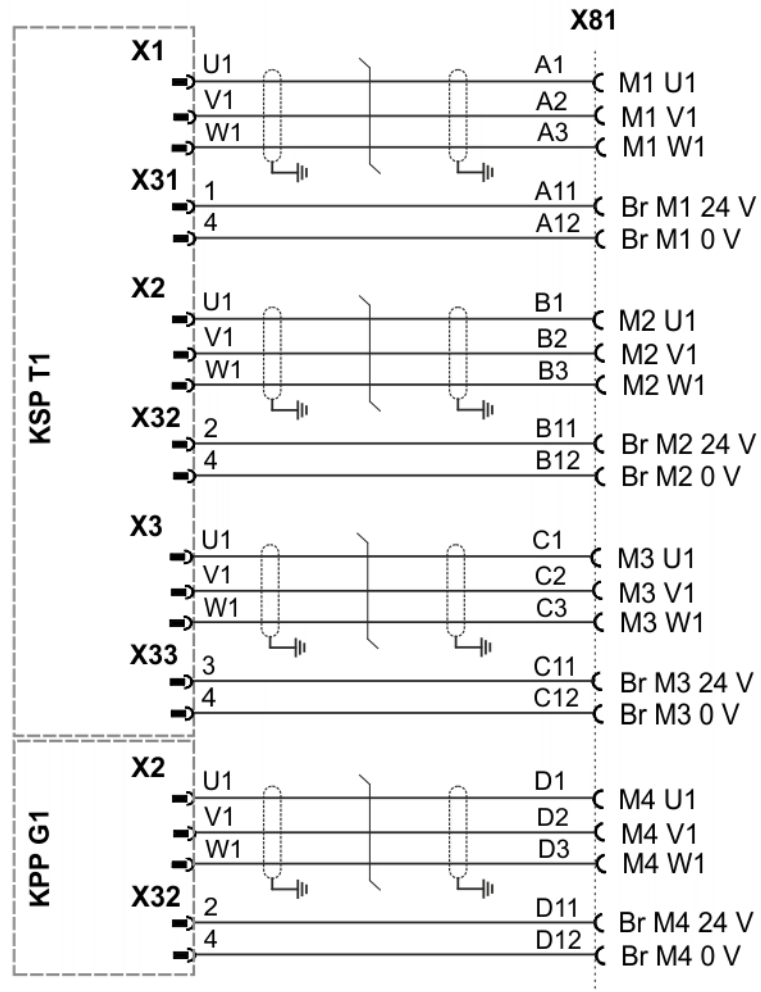

Fig. 3-24: Multiple connector X81

3.17.3 Connector pin allocation X81, X7.1 (5 axes)

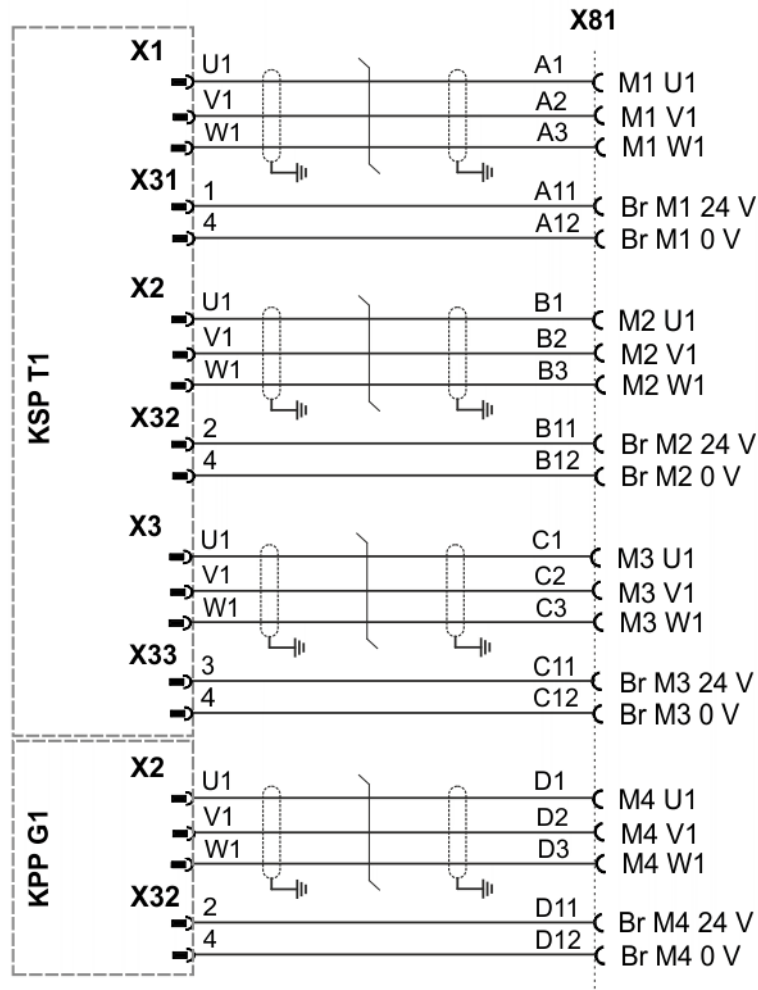

Fig. 3-25: Multiple connector X81

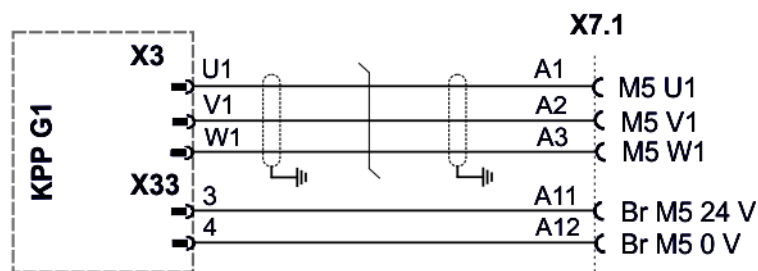

Fig. 3-26: Single connector X7.1

3.17.4 Connector pin allocation X81, X7.1 and X7.2 (6 axes)

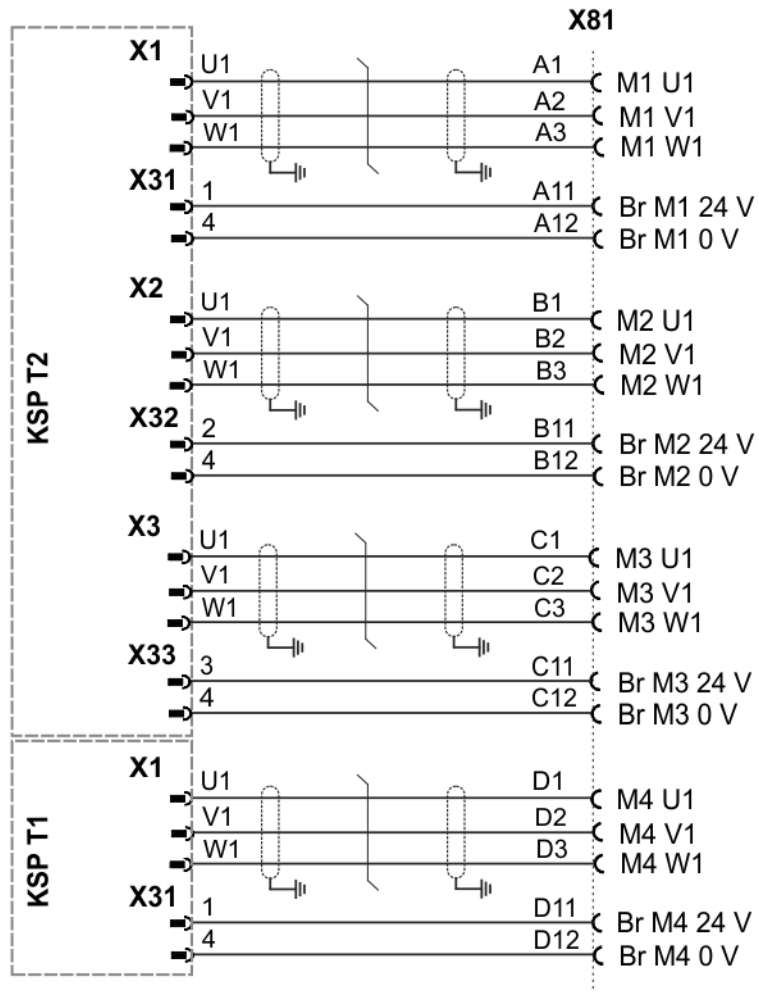

Fig. 3-27: Multiple connector X81

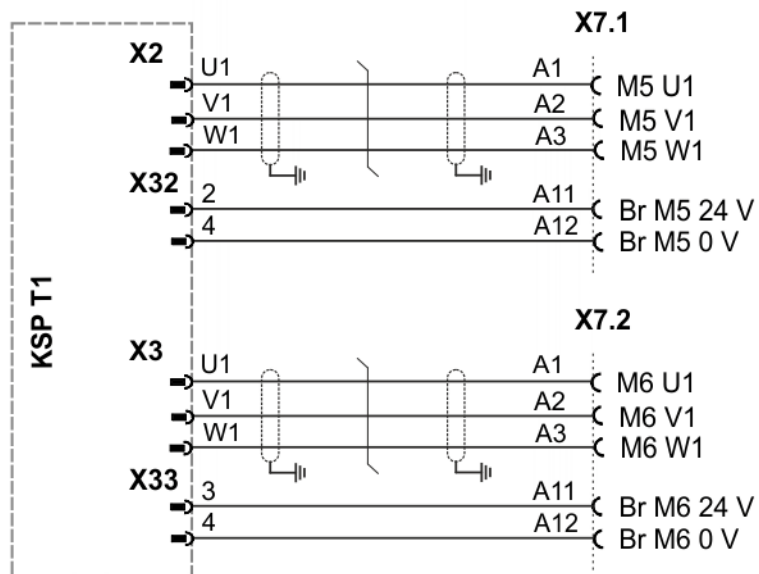

Fig. 3-28: Single connectors X7.1 and X7.2

3.17.5 Connector pin allocation X81, X7.1 to X7.3 (7 axes)

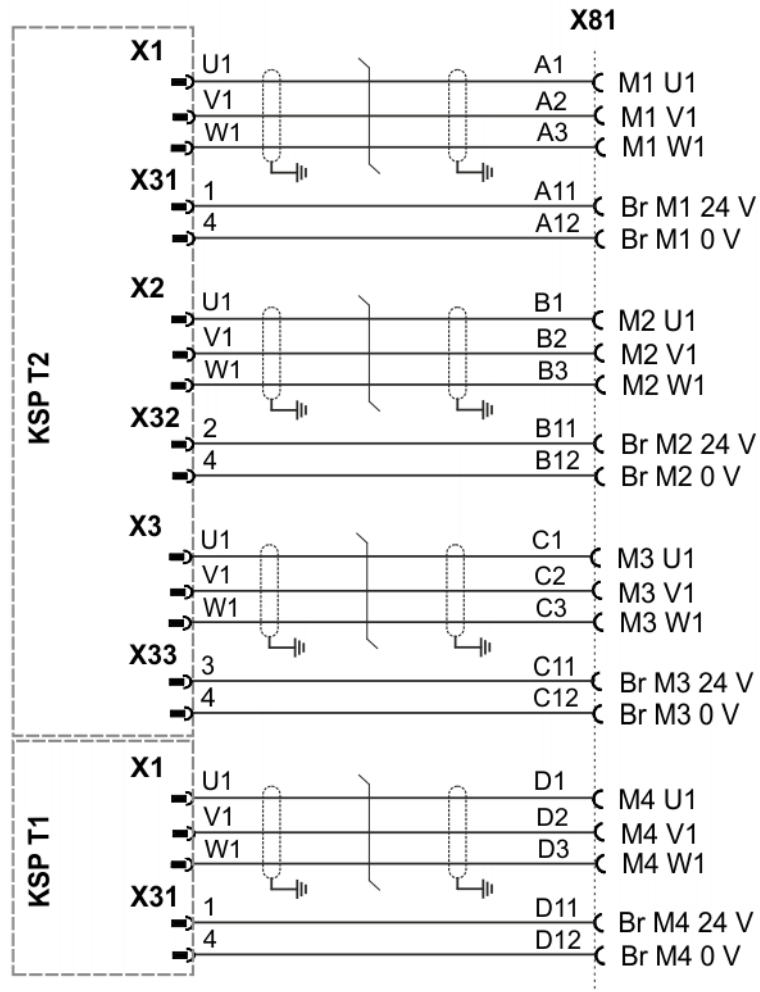

Fig. 3-29: Multiple connector X81

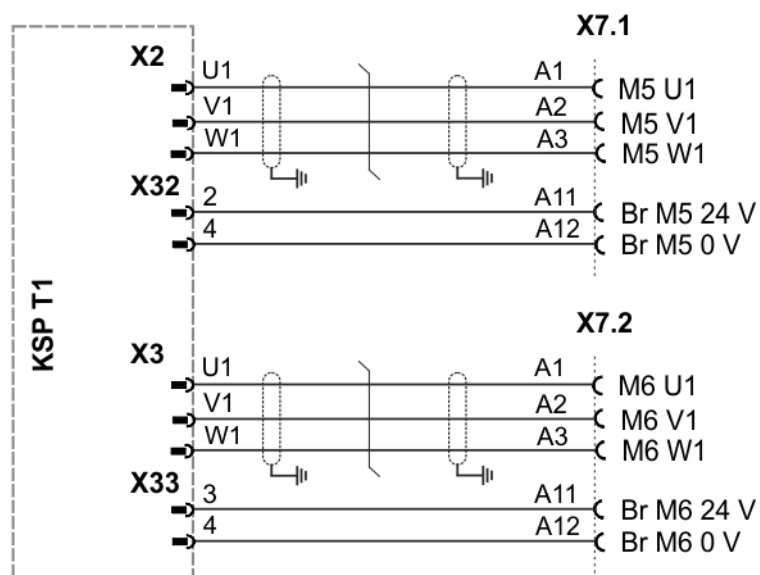

Fig. 3-30: Single connectors X7.1 and X7.2

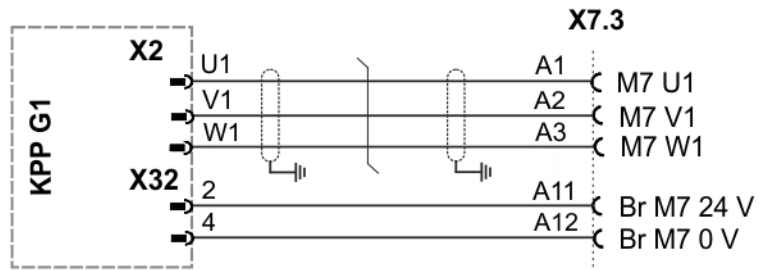

Fig. 3-31: Single connector X7.3

3.17.6 Connector pin allocation X81, X7.1 to X7.4 (8 axes)

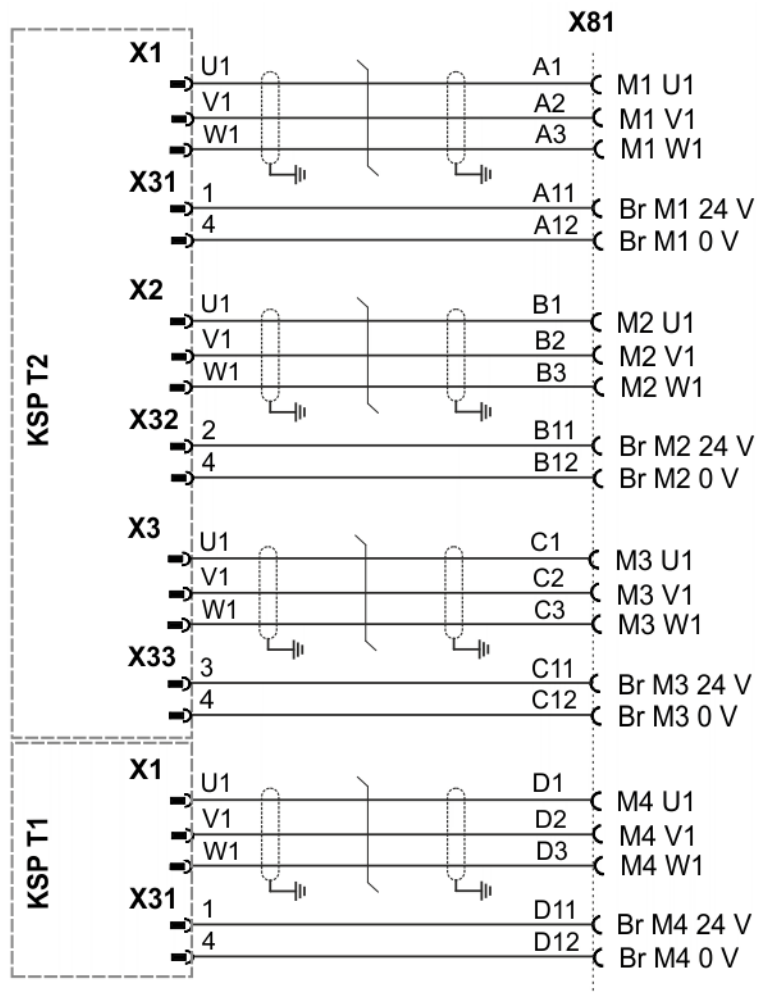

Fig. 3-32: Multiple connector X81

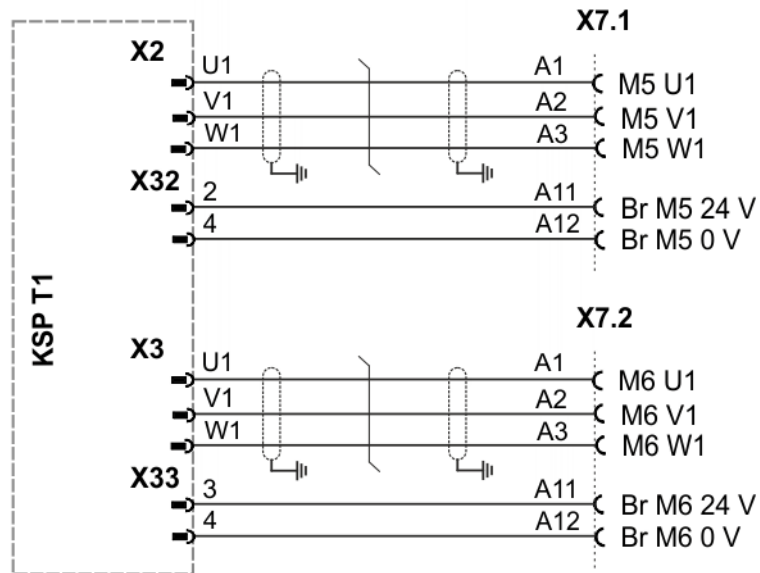

Fig. 3-33: Single connectors X7.1 and X7.2

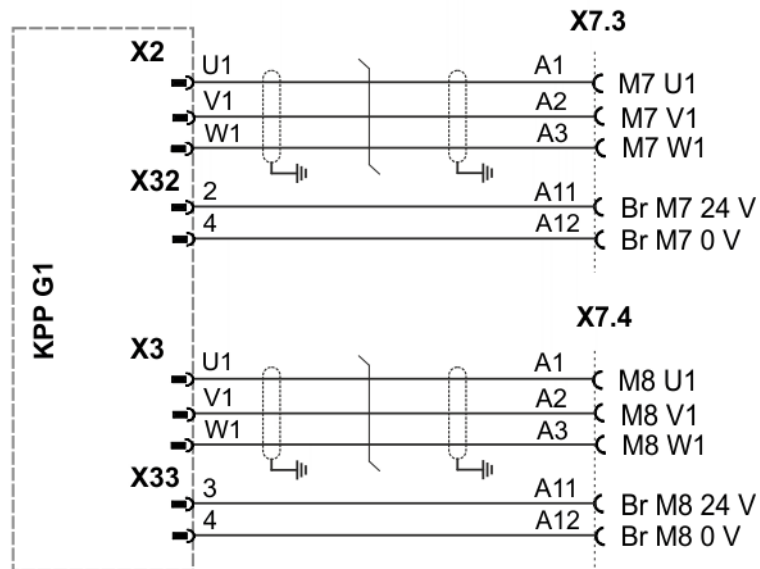

Fig. 3-34: Single connectors X7.3 and X7.4

3.18 Single connectors X7.1 to X7.8

Connector pin allocation

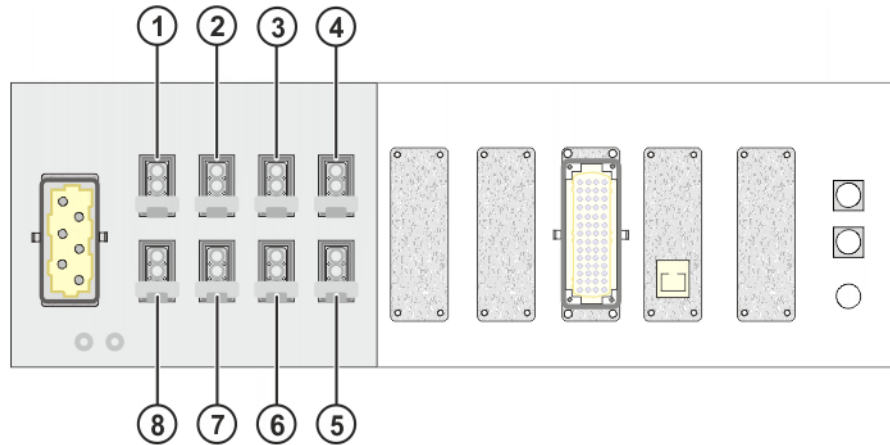

Fig. 3-35: Connection panel with X7.1 to X7.8

- 1 Single connector X7.1 for axis 1
- 2 Single connector X7.3 for axis 3
- 3 Single connector X7.5 for axis 5
- 4 Single connector X7.7 for axis 7
- 5 Single connector X7.8 for axis 8
- 6 Single connector X7.6 for axis 6
- 7 Single connector X7.4 for axis 4
- 8 Single connector X7.2 for axis 2

Designations

These designations are used in the following wiring diagrams:

- Mx Motor x
- Br Mx Brake, motor x

3.18.1 Connector pin allocation X7.1 to X7.3 (3 axes)

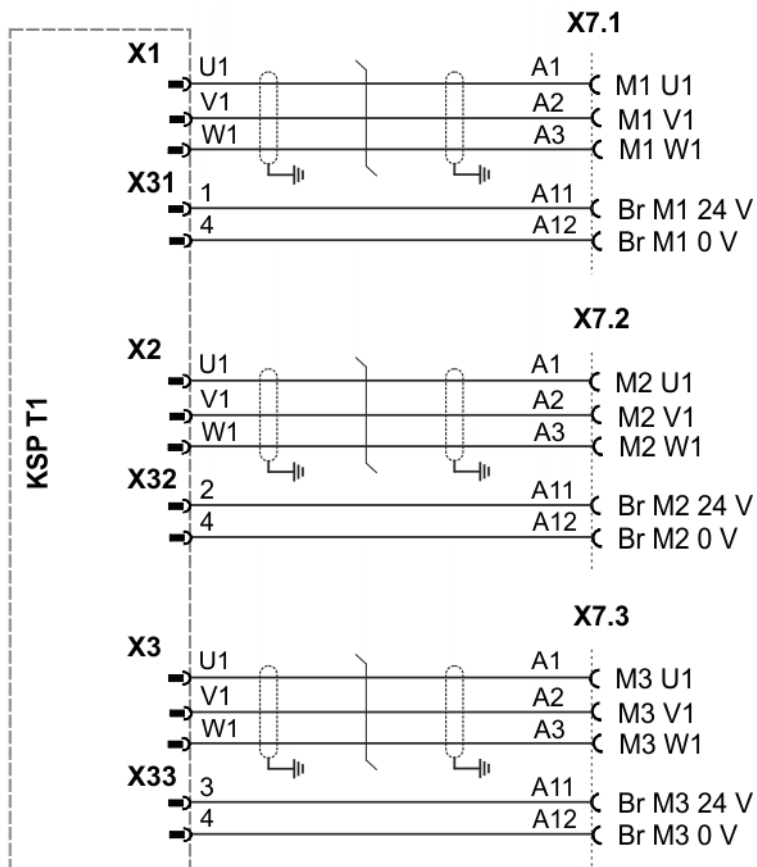

Fig. 3-36: Single connectors X7.1 to X7.3

3.18.2 Connector pin allocation X7.1 to X7.4 (4 axes)

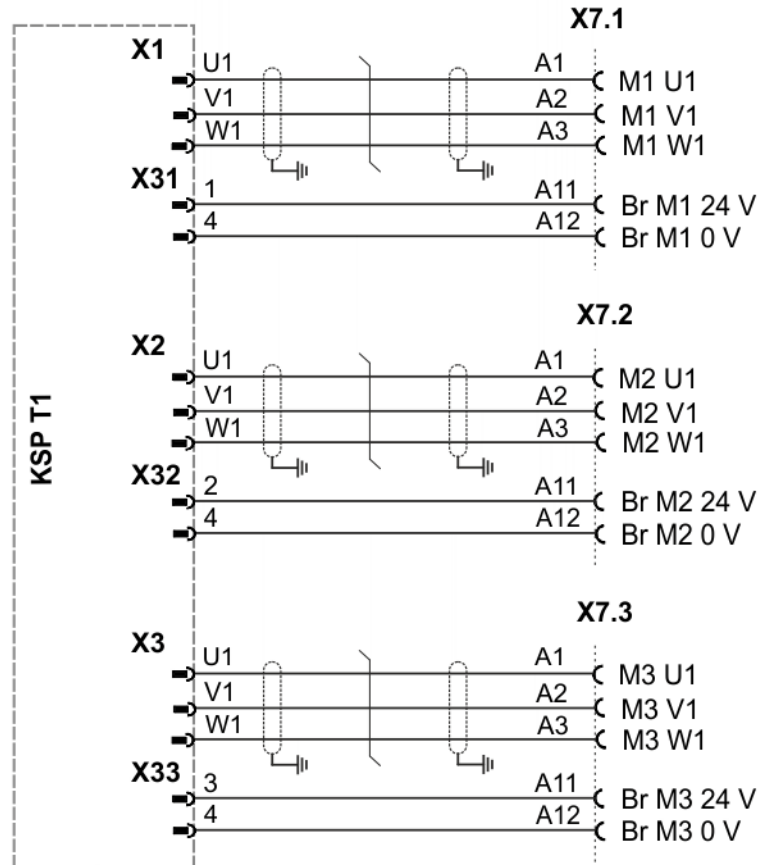

Fig. 3-37: Single connectors X7.1 to X7.3

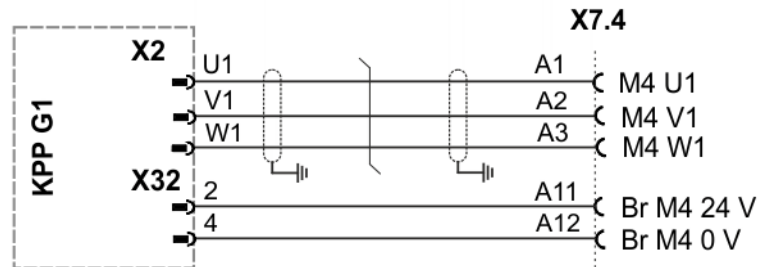

Fig. 3-38: Single connector X7.4

3.18.3 Connector pin allocation X7.1 to X7.5 (5 axes)

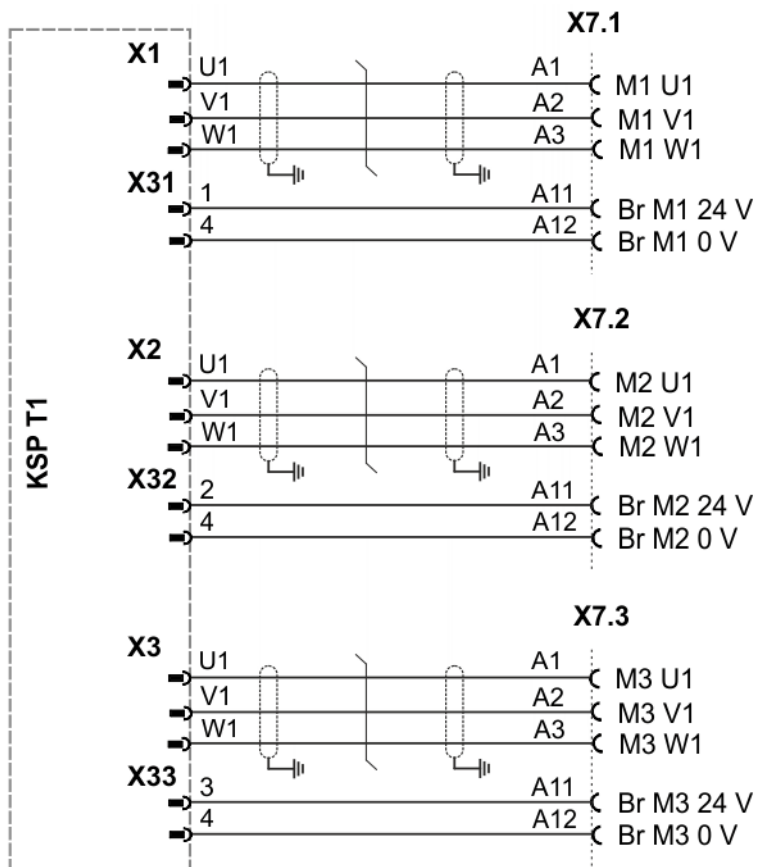

Fig. 3-39: Single connectors X7.1 to X7.3

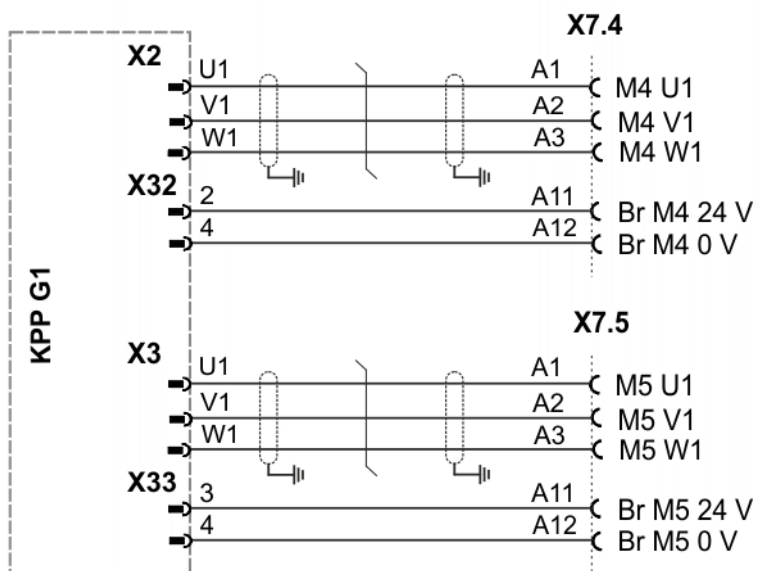

Fig. 3-40: Single connectors X7.4 and X7.5

3.18.4 Connector pin allocation X7.1 to X7.6 (6 axes)

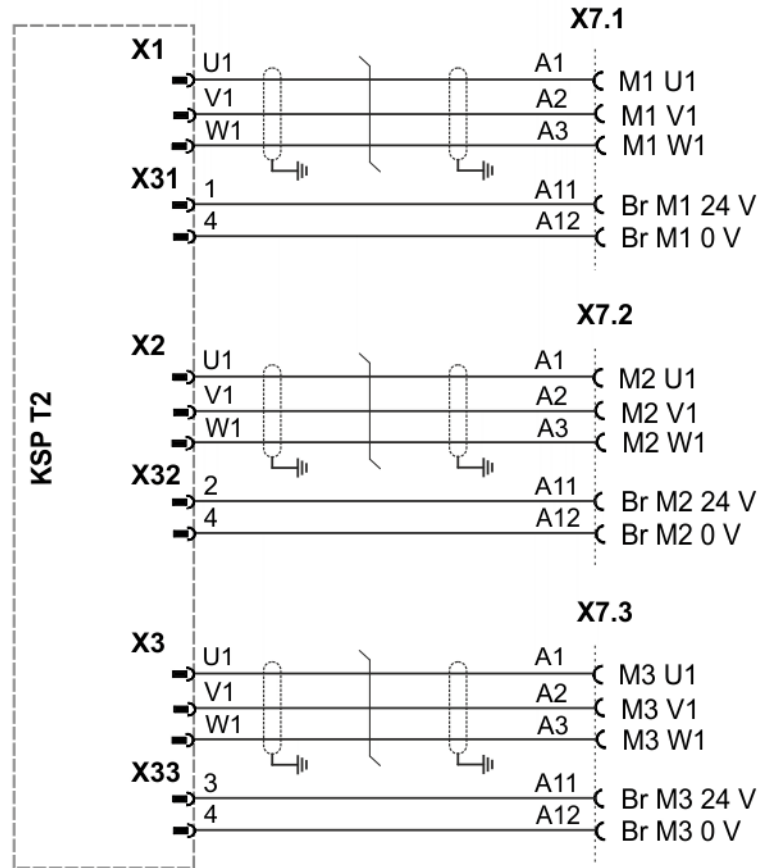

Fig. 3-41: Single connectors X7.1 to X7.3

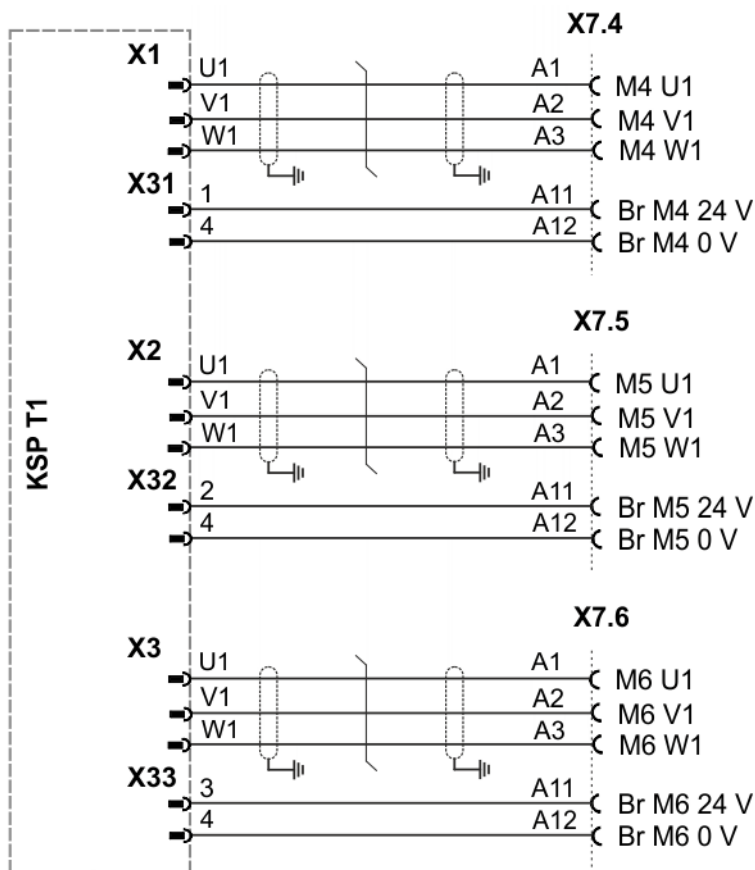

Fig. 3-42: Single connectors X7.4 to X7.6

3.18.5 Connector pin allocation X7.1 to X7.7 (7 axes)

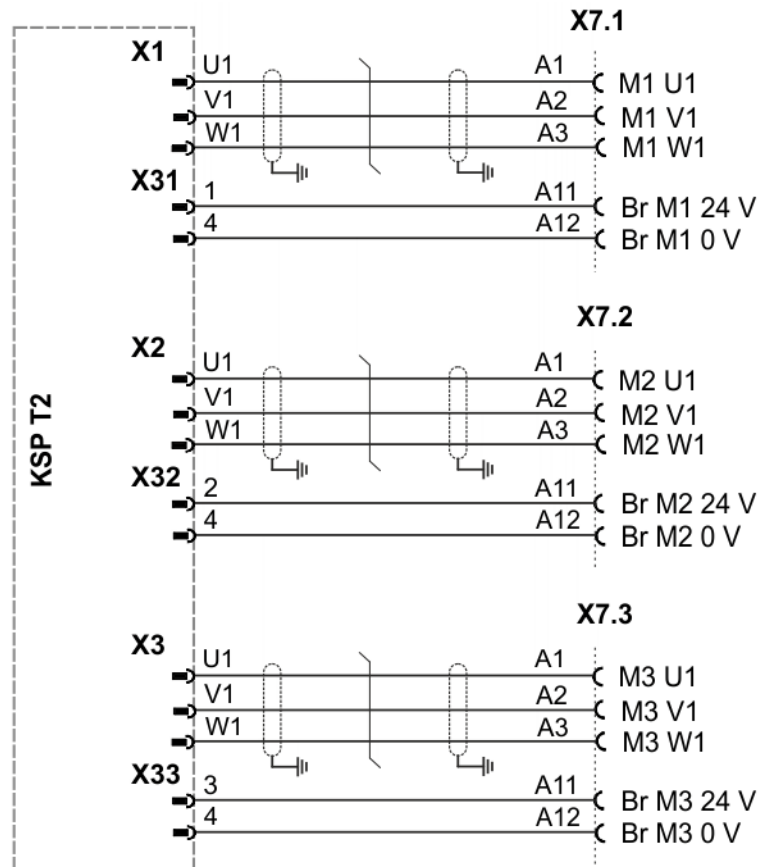

Fig. 3-43: Single connectors X7.1 to X7.3

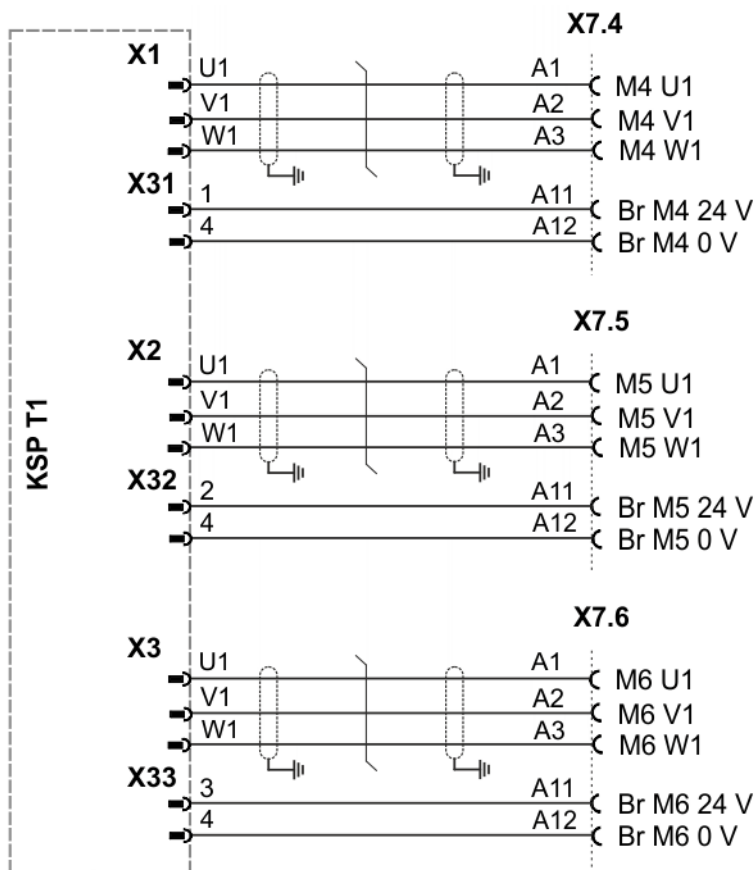

Fig. 3-44: Single connectors X7.4 to X7.6

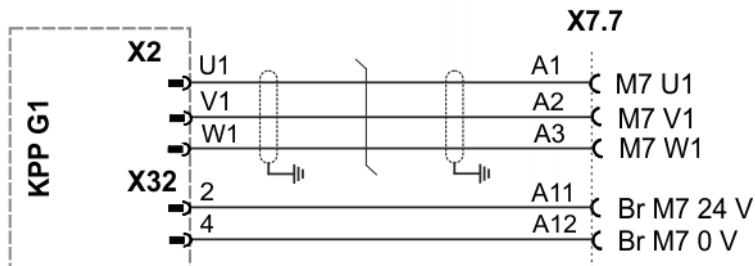

Fig. 3-45: Single connector X7.7

3.18.6 Connector pin allocation X7.1 to X7.8 (8 axes)

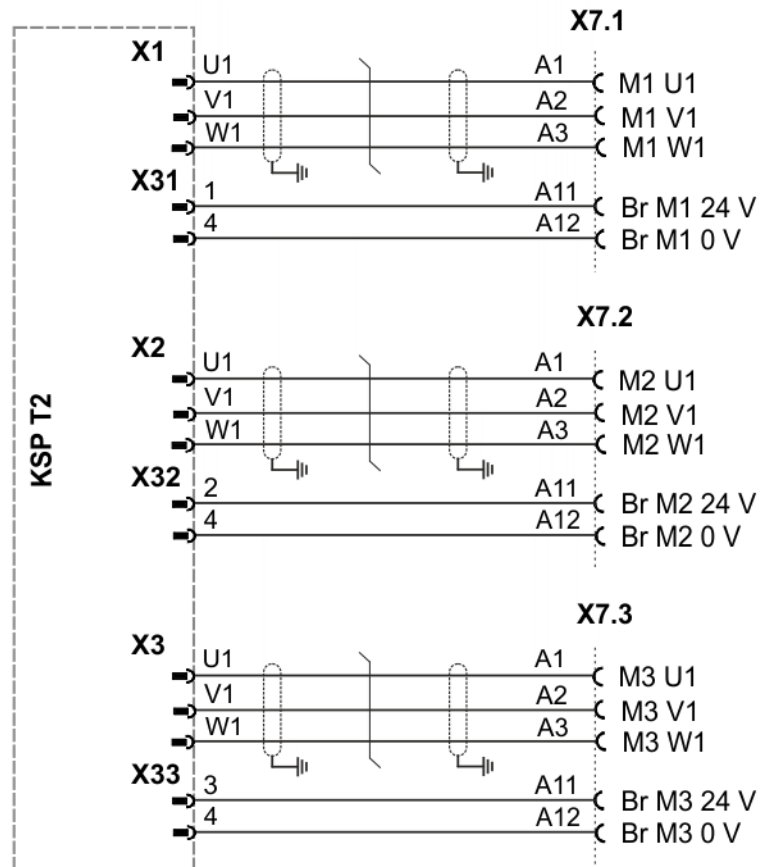

Fig. 3-46: Single connectors X7.1 to X7.3

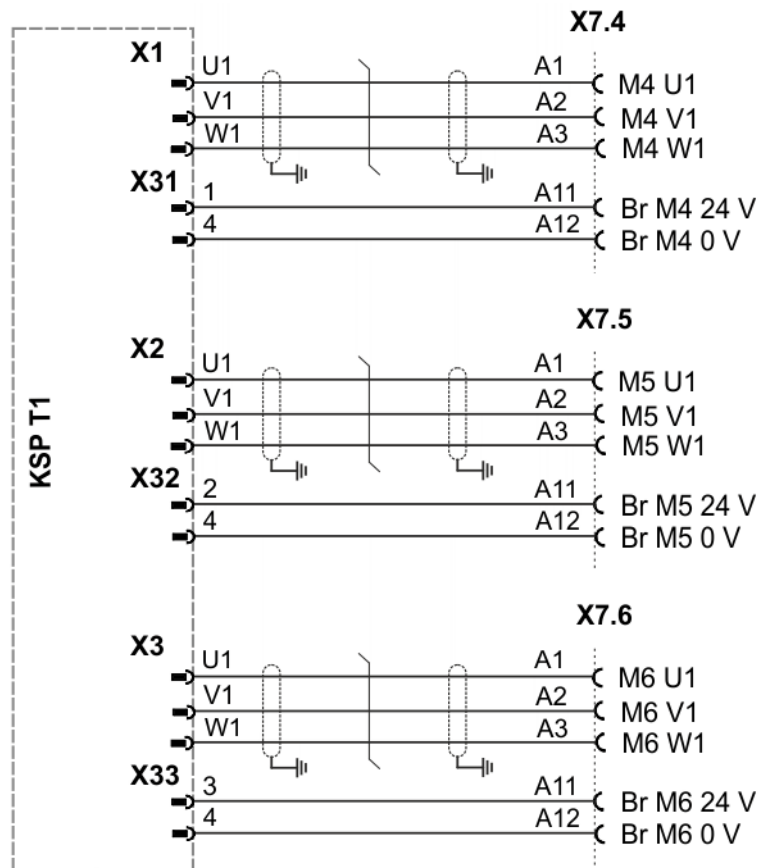

Fig. 3-47: Single connectors X7.4 to X7.6

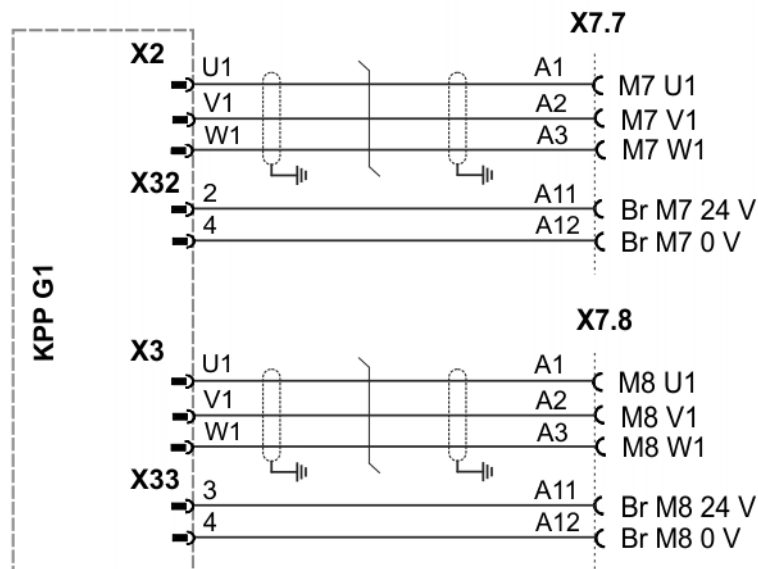

Fig. 3-48: Single connectors X7.7 and X7.8

3.19 Control PC interfaces

Motherboards

The following motherboard variants can be installed in the control PC:

- D2608-K
- D3076-K
- D3236-K

3.19.1 Motherboard D2608-K interfaces

Overview

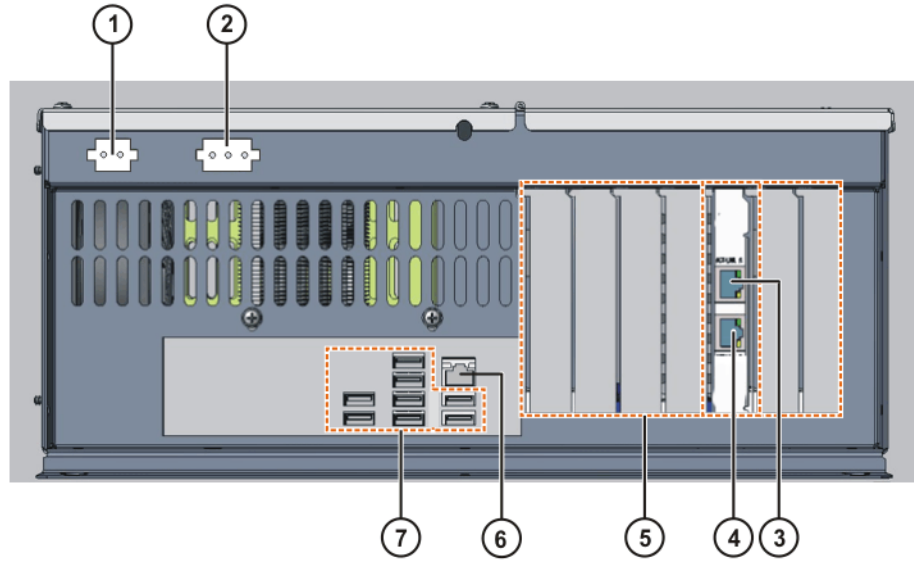

Fig. 3-49: Motherboard D2608-K interfaces

- 1 Connector X961, power supply DC 24 V
- 2 Connector X962, PC fan
- 3 LAN Dual NIC – KUKA Controller Bus
- 4 LAN Dual NIC – KUKA Line Interface
- 5 Field bus cards, slots 1 to 7
- 6 LAN Onboard – KUKA System Bus
- 7 8 USB 2.0 ports

i KUKA Roboter GmbH has assembled, tested and supplied the motherboard with an optimum configuration. No liability will be accepted for modifications to the configuration that have not been carried out by KUKA Roboter GmbH.

Slot assignment

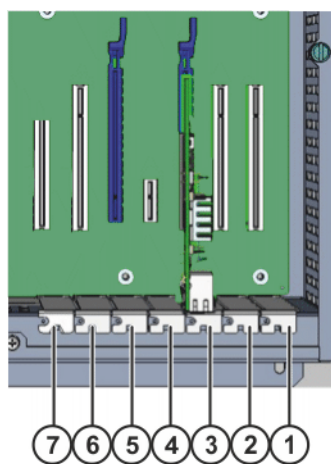

Fig. 3-50: Slot assignment, motherboard D2608-K

Slot	Type	Plug-in card
1	PCI	Field bus
2	PCI	Field bus
3	PCIe	LAN Dual NIC

Slot	Type	Plug-in card
4	PCIe	Not assigned
5	PCIe	Not assigned
6	PCI	Field bus
7	PCIe	Not assigned

3.19.2 Motherboard D3076-K interfaces

Overview

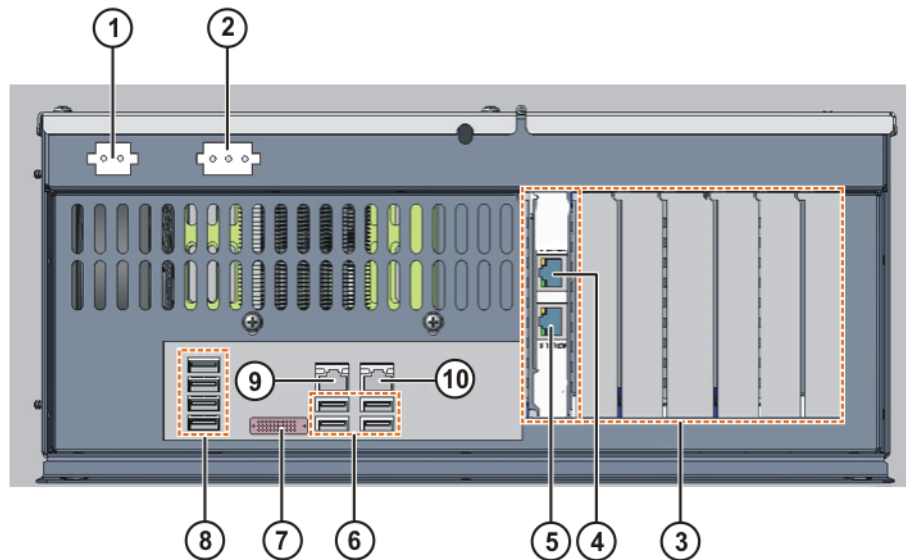

Fig. 3-51: Motherboard D3076-K interfaces

- 1 Connector X961, power supply DC 24 V
- 2 Connector X962, PC fan
- 3 Field bus cards, slots 1 to 7
- 4 LAN Dual NIC – KUKA Controller Bus
- 5 LAN Dual NIC – KUKA System Bus
- 6 4 USB 2.0 ports
- 7 DVI-I (VGA support possible via DVI on VGA adapter). The user interface of the controller can only be displayed on an external monitor if no active operator control device (smartPAD, VRP) is connected to the controller.
- 8 4 USB 2.0 ports
- 9 LAN Onboard – KUKA Option Network Interface.
- 10 LAN Onboard – KUKA Line Interface

i KUKA Roboter GmbH has assembled, tested and supplied the motherboard with an optimum configuration. No liability will be accepted for modifications to the configuration that have not been carried out by KUKA Roboter GmbH.

Slot assignment

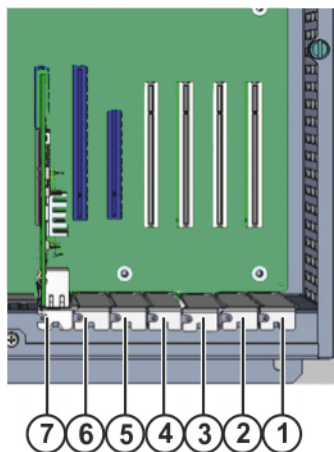

Fig. 3-52: Slot assignment, motherboard D3076-K

Slot	Type	Plug-in card
1	PCI	Field bus
2	PCI	Field bus
3	PCI	Field bus
4	PCI	Field bus
5	PCIe	Not assigned
6	PCIe	Not assigned
7	PCIe	LAN Dual NIC network card

3.19.3 Motherboard D3236-K interfaces

Overview

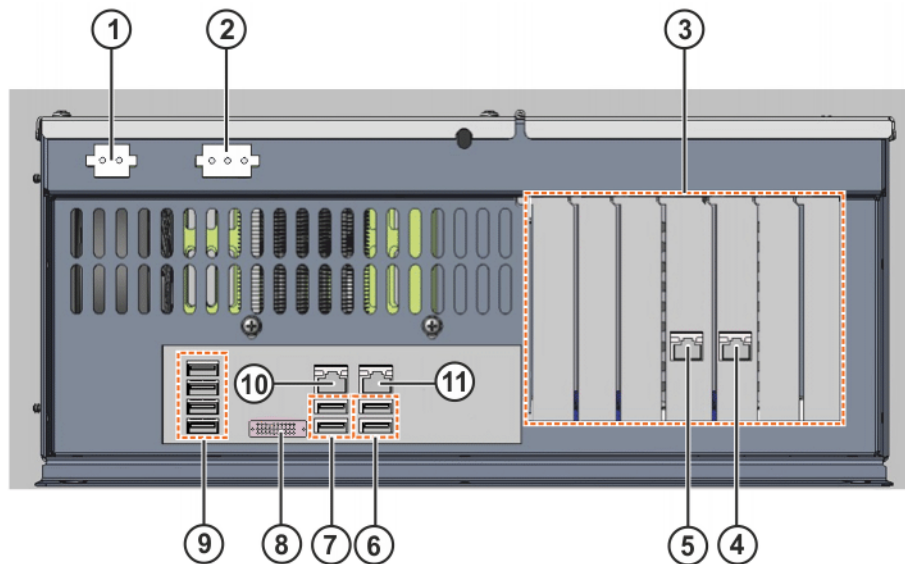

Fig. 3-53: Motherboard D3236-K interfaces

- 1 Connector X961, power supply DC 24 V
- 2 Connector X962, PC fan (optional, inside PC, depending on variant)
- 3 Field bus cards, slots 1 to 7
- 4 LAN Onboard – KUKA Controller Bus
- 5 LAN Onboard – KUKA System Bus
- 6 2 USB 2.0 ports
- 7 2 USB 3.0 ports

- 8 DVI-I (VGA support possible via DVI on VGA adapter). The user interface of the controller can only be displayed on an external monitor if no active operator control device (smartPAD, VRP) is connected to the controller.
- 9 4 USB 2.0 ports
- 10 LAN Onboard – KUKA Option Network Interface
- 11 LAN Onboard – KUKA Line Interface

i KUKA Roboter GmbH has assembled, tested and supplied the motherboard with an optimum configuration. No liability will be accepted for modifications to the configuration that have not been carried out by KUKA Roboter GmbH.

Slot assignment

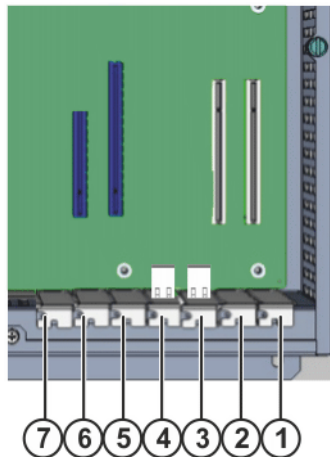

Fig. 3-54: Slot assignment, motherboard D3236-K

Slot	Type	Plug-in card
1	PCI	Field bus
2	PCI	Field bus
3	-	Not available
4	-	Not available
5	PCIe	Not assigned
6	PCIe	Not assigned
7	-	Not available

3.20 KUKA smartPAD holder (optional)

Description

The optional KUKA smartPAD holder can be used to hang up the smartPAD and its connecting cable on the door of the robot controller or on the safety fence.

Overview

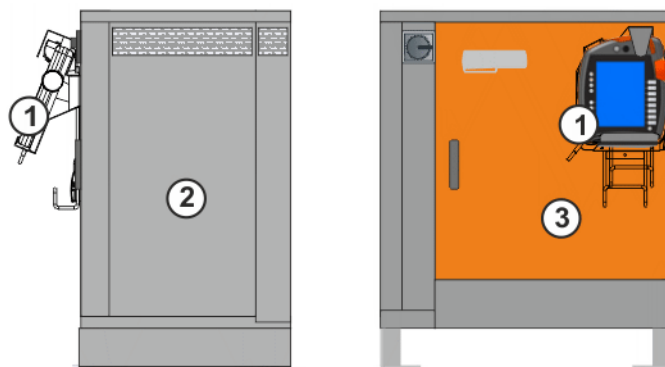

Fig. 3-55: KUKA smartPAD holder

- 1 KUKA smartPAD holder
- 2 Side view
- 3 Front view

3.21 Set of rollers (optional)

Description

The set of rollers is designed for installation on the cabinet base or fork slots of KR C4 robot controllers. The set of rollers enables the robot controller to be easily rolled out of and into a bank of cabinets.

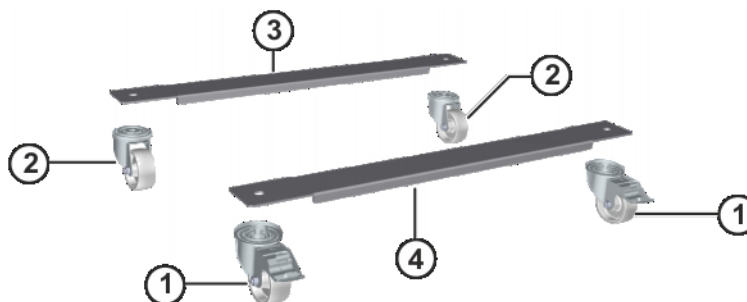

Fig. 3-56: Set of rollers

- 1 Castors with brake
- 2 Castors without brake
- 3 Rear cross-strut
- 4 Front cross-strut

3.22 Cabinet cooling

Description

The control cabinet is divided into two cooling circuits. The inner zone, containing the control and power electronics, is cooled by a heat exchanger. In the outer zone, the ballast resistor and the heat sinks of the KPP and KSP are cooled directly by ambient air.

NOTICE Upstream installation of filter mats at the ventilation slits causes an increase in temperature, leading to a reduction in the service life of the installed devices!

Configuration

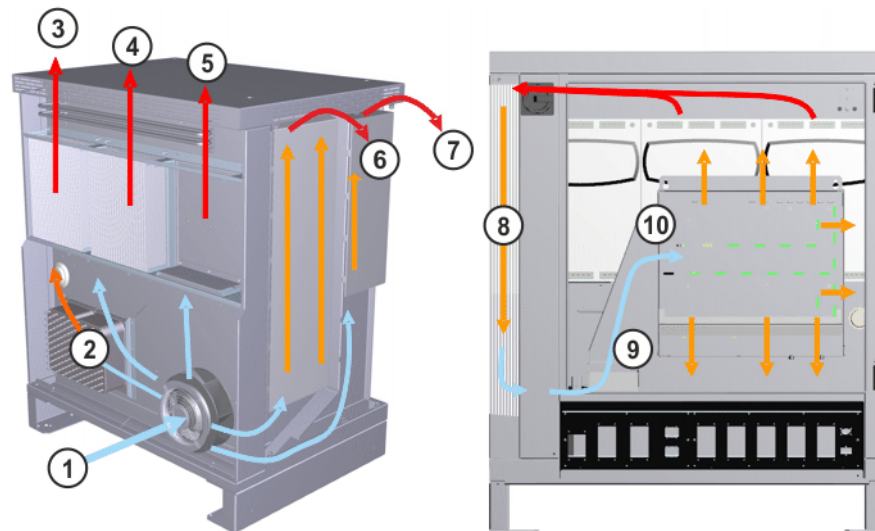

Fig. 3-57: Cooling circuits

- | | | | |
|---|-------------------------------------|----|---------------------------------|
| 1 | Air inlet, external fan | 6 | Air outlet for heat exchanger |
| 2 | Heat sink, low-voltage power supply | 7 | Air outlet for mains filter |
| 3 | Air outlet, KPP | 8 | Heat exchanger |
| 4 | Air outlet, KSP | 9 | KPC intake duct or internal fan |
| 5 | Air outlet, KSP | 10 | PC fan |

3.23 Description of the space for integration of customer options

Overview

The space for integration of customer options can be used for external customer equipment depending on the installed hardware options on the top-hat rail.

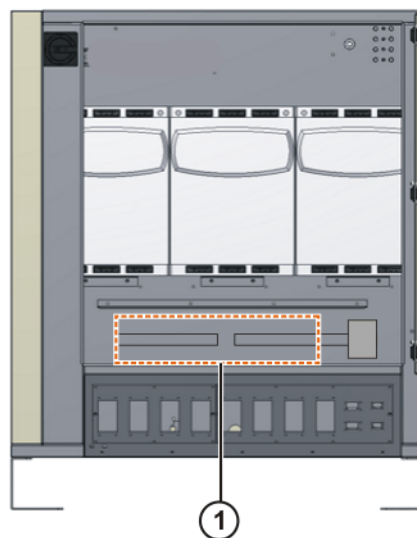

Fig. 3-58: Space for integration of customer options

- | | |
|---|---|
| 1 | Space for integration of customer options |
|---|---|

4 Technical data

Basic data

Cabinet type	KR C4
Number of axes	max. 9
Weight (without transformer)	150 kg
Protection rating	IP 54
Sound level according to DIN 45635-1	average: 67 dB (A)
Installation with other cabinets (with/without cooling unit)	Side-by-side, clearance 50 mm
Load on cabinet roof with even distribution	1,500 N

Power supply connection

 CAUTION	If the robot controller is connected to a power system without a grounded neutral or is operated with incorrect machine data, this may cause malfunctions in the robot controller and material damage to the power supply units. Electrical voltage can cause injuries. The robot controller may only be operated with grounded-neutral power supply systems.
--	---

If no grounded neutral is available, or if the mains voltage differs from those specified here, a transformer must be used.

Rated supply voltage according to the machine data, optionally:	AC 3x380 V, AC 3x400 V, AC 3x440 V or AC 3x480 V
Permissible tolerance of rated supply voltage	Rated supply voltage $\pm 10\%$
Mains frequency	49 ... 61 Hz
System impedance up to the connection point of the robot controller	$\leq 300 \text{ m}\Omega$
Full-load current	See identification plate
Mains-side fusing without transformer	min. 3x25 A, slow-blowing
Mains-side fusing with transformer	min. 3x32 A, slow-blowing, with 13 kVA
Equipotential bonding	The common neutral point for the equipotential bonding conductors and all protective ground conductors is the reference bus of the power unit.

Environmental conditions

Ambient temperature during operation without cooling unit	+5 ... 45 °C (278 ... 318 K)
Ambient temperature during operation with cooling unit	+20 ... 50 °C (293 ... 323 K)
Ambient temperature during storage/transportation with batteries	-25 ... +40 °C (248 ... 313 K)
Ambient temperature during storage/transportation without batteries	-25 ... +70 °C (248 ... 343 K)
Temperature change	max. 1.1 K/min

Humidity class	3k3 acc. to DIN EN 60721-3-3; 1995
Altitude	<ul style="list-style-type: none"> ■ up to 1000 m above mean sea level with no reduction in power ■ 1000 m ... 4000 m above mean sea level with a reduction in power of 5%/1000 m

NOTICE To prevent exhaustive discharge and thus destruction of the batteries, the batteries must be recharged at regular intervals according to the storage temperature.
 If the storage temperature is +20 °C or lower, the batteries must be recharged every 9 months.
 If the storage temperature is between +20 °C and +30 °C, the batteries must be recharged every 6 months.
 If the storage temperature is between +30 °C and +40 °C, the batteries must be recharged every 3 months.

Vibration resistance

Type of loading	During transportation	During continuous operation
r.m.s. acceleration (sustained oscillation)	0.37 g	0.1 g
Frequency range (sustained oscillation)	4 to 120 Hz	
Acceleration (shock in X/Y/Z direction)	10 g	2.5 g
Waveform/duration (shock in X/Y/Z direction)	Half-sine/11 ms	

If more severe mechanical stress is expected, the controller must be installed on anti-vibration components.

Control unit

Supply voltage	DC 27.1 V ± 0.1 V
----------------	-------------------

Control PC

Main processor	See shipping version
DIMM memory modules	See shipping version (min. 2 GB)
Hard disk	See shipping version

KUKA smartPAD

Supply voltage	20 ... 27.1 V DC
Dimensions (WxHxD)	approx. 33x26x8 cm ³
Display	Touch-sensitive color display 600x800 pixels
Display size	8,4 "
Interfaces	USB
Weight	1.1 kg
Protection rating (without USB stick and USB connection closed with a plug)	IP 54

Space for integration of customer options

Designation	Values
Power dissipation of installed components	max. 20 W
Depth of installed components	approx. 200 mm

Designation	Values
Width	300 mm
Height	150 mm

Cable lengths

For cable designations, standard lengths and optional lengths, please refer to the operating instructions or assembly instructions of the manipulator and/or the assembly and operating instructions for KR C4 external cabling for robot controllers.



When using smartPAD cable extensions, only two extensions may be used. An overall cable length of 50 m must not be exceeded.



The difference in the cable lengths between the individual channels of the RDC box must not exceed 10 m.

4.1 External 24 V power supply

PELV external power supply

External voltage	PELV power supply unit acc. to EN 60950 with rated voltage 27 V (18 V ... 30 V), safely isolated
Continuous current	> 8 A
Cable cross-section of power supply cable	$\geq 1 \text{ mm}^2$
Cable length of power supply cable	< 50 m, or < 100 m wire length (outgoing and incoming lines)



The cables of the power supply unit must not be routed together with power-carrying cables.



The minus connection of the external voltage must be grounded by the customer.



Parallel connection of a basic-insulated device is not permitted.

4.2 Safety Interface Board

SIB outputs



The power contacts must only be fed from a safely isolated PELV power supply unit. (>>> 4.1 "External 24 V power supply" Page 65)

Operating voltage, power contacts	$\leq 30 \text{ V}$
Current via power contact	min. 10 mA < 750 mA
Cable lengths (connection of actuators)	< 50 m cable lengths < 100 m wire length (outgoing and incoming lines)
Cable cross-section (connection of actuators)	$\geq 1 \text{ mm}^2$

Switching cycles, Standard SIB	Service life: 20 years < 100,000 (corresponds to 13 switching cycles per day)
Switching cycles, Extended SIB	Service life: 20 years < 780,000 (corresponds to 106 switching cycles per day)

The module must be exchanged when the number of switching cycles is exceeded.

SIB inputs

Switching level of the inputs	The state for the inputs is not defined for the voltage range from 5 V to 11 V (transition range). Either the ON state or the OFF state is set. OFF state for the voltage range from -3 V to 5 V (OFF range). ON state for the voltage range from 11 V to 30 V (ON range).
Load current with 24 V supply voltage	> 10 mA
Load current with 18 V supply voltage	> 6.5 mA
Max. load current	< 15 mA
Cable length, terminal - sensor	< 50 m, or < 100 m wire length (outgoing and incoming lines)
Cable cross-section, test output - input connection	> 0.5 mm ²
Capacitive load for the test outputs per channel	< 200 nF
Resistive load for the test outputs per channel	< 33 Ω



Test outputs A and B are sustained short-circuit proof. The specified currents flow via the contact element connected to the input. This must be rated for the maximum current of 15 mA.

4.3 Dimensions of robot controller

The dimensions of the robot controller are indicated in the diagram (>>> Fig. 4-1).

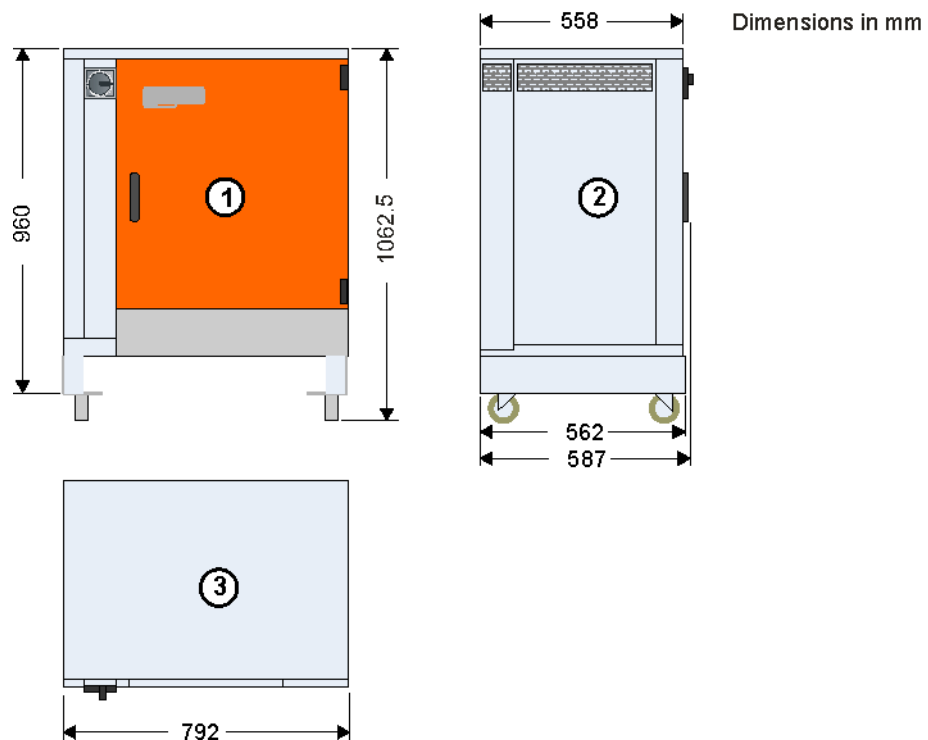

Fig. 4-1: Dimensions

- 1 Front view
- 2 Side view
- 3 Top view

4.4 Minimum clearances, robot controller

The minimum clearances that must be maintained for the robot controller are indicated in the diagram (>>> Fig. 4-2).

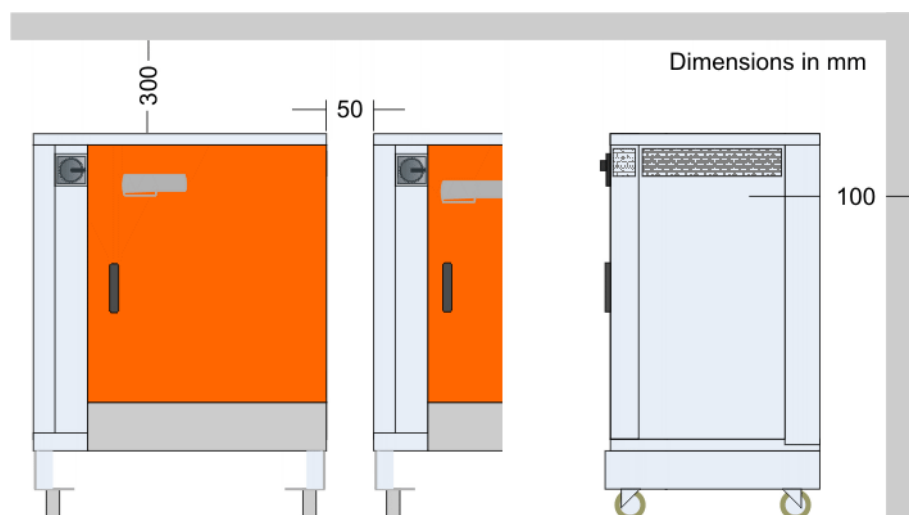

Fig. 4-2: Minimum clearances

NOTICE

If the minimum clearances are not maintained, this can result in damage to the robot controller. The specified minimum clearances must always be observed.

i Certain maintenance and repair tasks on the robot controller (>>> 10 "Maintenance" Page 143) (>>> 11 "Repair" Page 147) must be carried out from the side or from the rear. The robot controller must be accessible for this. If the side or rear panels are not accessible, it must be possible to move the robot controller into a position in which the work can be carried out.

4.5 Swing range for cabinet door

The diagram (>>> Fig. 4-3) shows the swing range for the door.

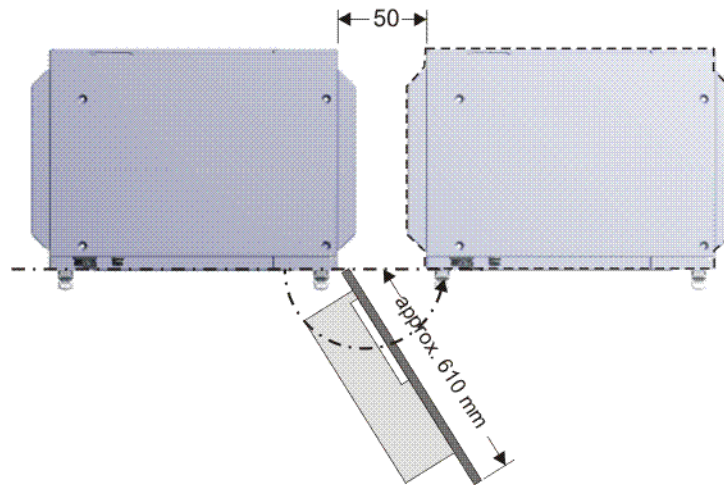

Fig. 4-3: Swing range for cabinet door

Swing range, standalone cabinet:

- Door with computer frame approx. 180°

Swing range, butt-mounted cabinets:

- Door approx. 155°

4.6 Dimensions of the smartPAD holder (optional)

The diagram (>>> Fig. 4-4) shows the dimensions and drilling locations for mounting on the robot controller or safety fence.

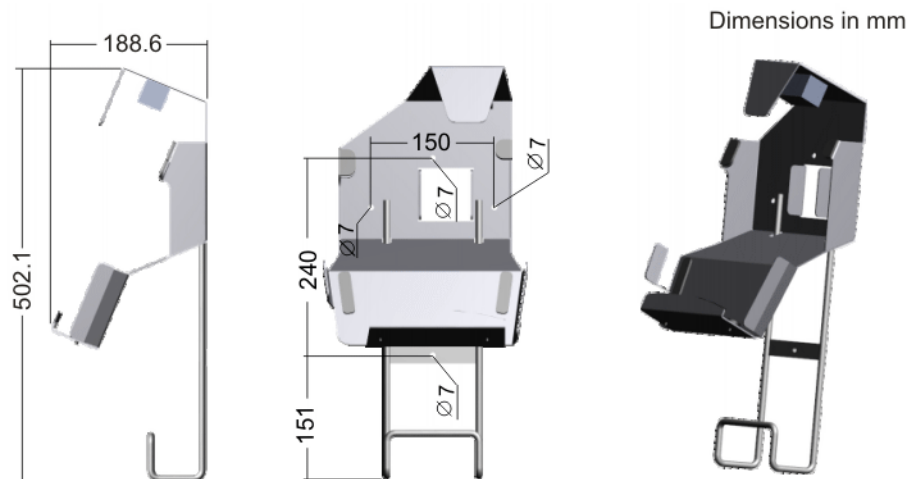

Fig. 4-4: Dimensions and drilling locations for smartPAD holder

4.7 Dimensions of boreholes for floor mounting

The dimensions of the boreholes for floor mounting are indicated in the diagram (>>> Fig. 4-5).

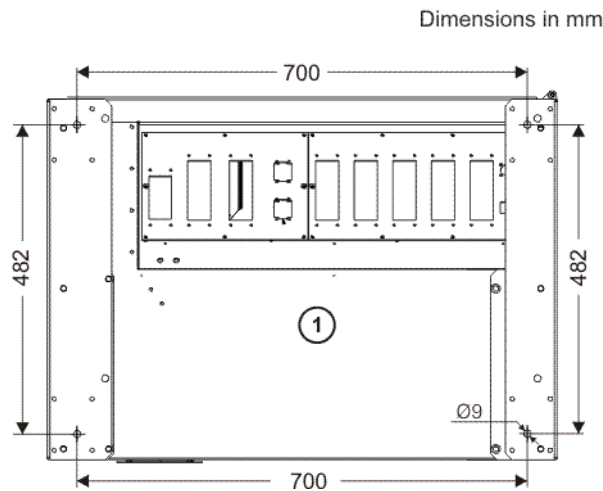

Fig. 4-5: Boreholes for floor mounting

1 View from below

4.8 Dimensions of boreholes for technology cabinet

The diagram (>>> Fig. 4-6) shows the dimensions of the boreholes on the KR C4 for fastening the technology cabinet.

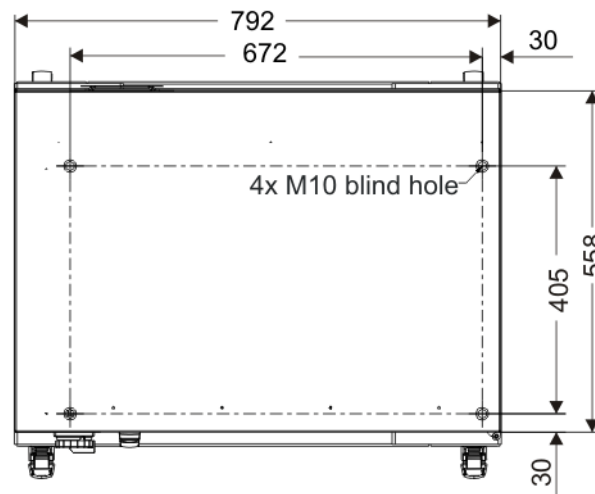

Fig. 4-6: Fastening the technology cabinet

1 View from above

4.9 Plates and labels

Overview

The following plates and labels are attached to the robot controller.

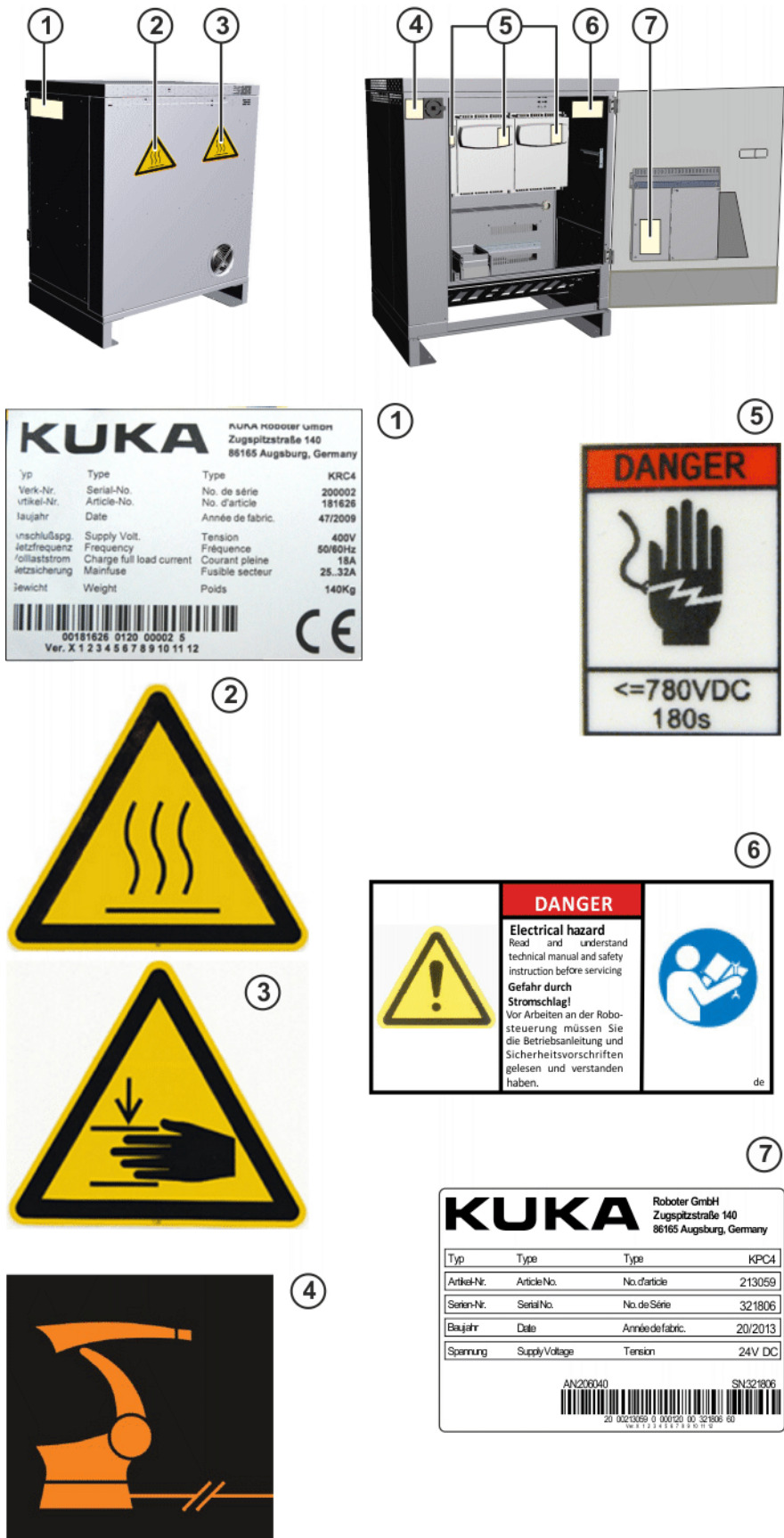



Fig. 4-7: Plates and labels

 The plates may vary slightly from the examples illustrated above depending on the specific cabinet type or as a result of updates.

Designations

Plate no.	Designation
1	Robot controller rating plate
2	Hot surface warning sign
3	Hand injury warning sign
4	Information sign: KR C4 main switch
5	Warning: ≤ 780 VDC / wait 180 s
6	Warning: read manual
7	Control PC rating plate

5 Safety

5.1 General

5.1.1 Liability

The device described in this document is either an industrial robot or a component thereof.

Components of the industrial robot:

- Manipulator
- Robot controller
- Teach pendant
- Connecting cables
- External axes (optional)
e.g. linear unit, turn-tilt table, positioner
- Software
- Options, accessories

The industrial robot is built using state-of-the-art technology and in accordance with the recognized safety rules. Nevertheless, misuse of the industrial robot may constitute a risk to life and limb or cause damage to the industrial robot and to other material property.

The industrial robot may only be used in perfect technical condition in accordance with its designated use and only by safety-conscious persons who are fully aware of the risks involved in its operation. Use of the industrial robot is subject to compliance with this document and with the declaration of incorporation supplied together with the industrial robot. Any functional disorders affecting safety must be rectified immediately.

Safety information

Safety information cannot be held against KUKA Roboter GmbH. Even if all safety instructions are followed, this is not a guarantee that the industrial robot will not cause personal injuries or material damage.

No modifications may be carried out to the industrial robot without the authorization of KUKA Roboter GmbH. Additional components (tools, software, etc.), not supplied by KUKA Roboter GmbH, may be integrated into the industrial robot. The user is liable for any damage these components may cause to the industrial robot or to other material property.

In addition to the Safety chapter, this document contains further safety instructions. These must also be observed.

5.1.2 Intended use of the industrial robot

The industrial robot is intended exclusively for the use designated in the "Purpose" chapter of the operating instructions or assembly instructions.

Any use or application deviating from the intended use is deemed to be misuse and is not allowed. The manufacturer is not liable for any damage resulting from such misuse. The risk lies entirely with the user.

Operation of the industrial robot in accordance with its intended use also requires compliance with the operating and assembly instructions for the individual components, with particular reference to the maintenance specifications.

Misuse

Any use or application deviating from the intended use is deemed to be misuse and is not allowed. This includes e.g.:

- Transportation of persons and animals
- Use as a climbing aid
- Operation outside the specified operating parameters
- Use in potentially explosive environments
- Operation without additional safeguards
- Outdoor operation
- Underground operation

5.1.3 EC declaration of conformity and declaration of incorporation

The industrial robot constitutes partly completed machinery as defined by the EC Machinery Directive. The industrial robot may only be put into operation if the following preconditions are met:

- The industrial robot is integrated into a complete system.
Or: The industrial robot, together with other machinery, constitutes a complete system.
Or: All safety functions and safeguards required for operation in the complete machine as defined by the EC Machinery Directive have been added to the industrial robot.
- The complete system complies with the EC Machinery Directive. This has been confirmed by means of an assessment of conformity.

Declaration of conformity

The system integrator must issue a declaration of conformity for the complete system in accordance with the Machinery Directive. The declaration of conformity forms the basis for the CE mark for the system. The industrial robot must always be operated in accordance with the applicable national laws, regulations and standards.

The robot controller is CE certified under the EMC Directive and the Low Voltage Directive.

Declaration of incorporation

The industrial robot as partly completed machinery is supplied with a declaration of incorporation in accordance with Annex II B of the EC Machinery Directive 2006/42/EC. The assembly instructions and a list of essential requirements complied with in accordance with Annex I are integral parts of this declaration of incorporation.

The declaration of incorporation declares that the start-up of the partly completed machinery is not allowed until the partly completed machinery has been incorporated into machinery, or has been assembled with other parts to form machinery, and this machinery complies with the terms of the EC Machinery Directive, and the EC declaration of conformity is present in accordance with Annex II A.

5.1.4 Terms used

STOP 0, STOP 1 and STOP 2 are the stop definitions according to EN 60204-1:2006.

Term	Description
Axis range	Range of each axis, in degrees or millimeters, within which it may move. The axis range must be defined for each axis.
Stopping distance	Stopping distance = reaction distance + braking distance The stopping distance is part of the danger zone.
Workspace	Area within which the robot may move. The workspace is derived from the individual axis ranges.

Term	Description
User	The user of the industrial robot can be the management, employer or delegated person responsible for use of the industrial robot.
Danger zone	The danger zone consists of the workspace and the stopping distances of the manipulator and external axes (optional).
Service life	The service life of a safety-relevant component begins at the time of delivery of the component to the customer. The service life is not affected by whether the component is used or not, as safety-relevant components are also subject to aging during storage.
KUKA smartPAD	see "smartPAD"
Manipulator	The robot arm and the associated electrical installations
Safety zone	The safety zone is situated outside the danger zone.
Safe operational stop	The safe operational stop is a standstill monitoring function. It does not stop the robot motion, but monitors whether the robot axes are stationary. If these are moved during the safe operational stop, a safety stop STOP 0 is triggered. The safe operational stop can also be triggered externally. When a safe operational stop is triggered, the robot controller sets an output to the field bus. The output is set even if not all the axes were stationary at the time of triggering, thereby causing a safety stop STOP 0 to be triggered.
Safety STOP 0	A stop that is triggered and executed by the safety controller. The safety controller immediately switches off the drives and the power supply to the brakes. Note: This stop is called safety STOP 0 in this document.
Safety STOP 1	A stop that is triggered and monitored by the safety controller. The braking process is performed by the non-safety-oriented part of the robot controller and monitored by the safety controller. As soon as the manipulator is at a standstill, the safety controller switches off the drives and the power supply to the brakes. When a safety STOP 1 is triggered, the robot controller sets an output to the field bus. The safety STOP 1 can also be triggered externally. Note: This stop is called safety STOP 1 in this document.
Safety STOP 2	A stop that is triggered and monitored by the safety controller. The braking process is performed by the non-safety-oriented part of the robot controller and monitored by the safety controller. The drives remain activated and the brakes released. As soon as the manipulator is at a standstill, a safe operational stop is triggered. When a safety STOP 2 is triggered, the robot controller sets an output to the field bus. The safety STOP 2 can also be triggered externally. Note: This stop is called safety STOP 2 in this document.
Safety options	Generic term for options which make it possible to configure additional safe monitoring functions in addition to the standard safety functions. Example: SafeOperation
smartPAD	Teach pendant for the KR C4 The smartPAD has all the operator control and display functions required for operating and programming the industrial robot.

Term	Description
Stop category 0	The drives are deactivated immediately and the brakes are applied. The manipulator and any external axes (optional) perform path-oriented braking. Note: This stop category is called STOP 0 in this document.
Stop category 1	The manipulator and any external axes (optional) perform path-maintaining braking. <ul style="list-style-type: none"> ■ Operating mode T1: The drives are deactivated as soon as the robot has stopped, but no later than after 680 ms. ■ Operating mode T2, AUT, AUT EXT: The drives are switched off after 1.5 s. Note: This stop category is called STOP 1 in this document.
Stop category 2	The drives are not deactivated and the brakes are not applied. The manipulator and any external axes (optional) are braked with a path-maintaining braking ramp. Note: This stop category is called STOP 2 in this document.
System integrator (plant integrator)	The system integrator is responsible for safely integrating the industrial robot into a complete system and commissioning it.
T1	Test mode, Manual Reduced Velocity (≤ 250 mm/s)
T2	Test mode, Manual High Velocity (> 250 mm/s permissible)
External axis	Motion axis which is not part of the manipulator but which is controlled using the robot controller, e.g. KUKA linear unit, turn-tilt table, Posiflex.

5.2 Personnel

The following persons or groups of persons are defined for the industrial robot:

- User
- Personnel



All persons working with the industrial robot must have read and understood the industrial robot documentation, including the safety chapter.

User

The user must observe the labor laws and regulations. This includes e.g.:

- The user must comply with his monitoring obligations.
- The user must carry out instructions at defined intervals.

Personnel

Personnel must be instructed, before any work is commenced, in the type of work involved and what exactly it entails as well as any hazards which may exist. Instruction must be carried out regularly. Instruction is also required after particular incidents or technical modifications.

Personnel includes:

- System integrator
- Operators, subdivided into:
 - Start-up, maintenance and service personnel
 - Operator
 - Cleaning personnel



Installation, exchange, adjustment, operation, maintenance and repair must be performed only as specified in the operating or assembly instructions for the relevant component of the industrial robot and only by personnel specially trained for this purpose.

System integrator The industrial robot is safely integrated into a complete system by the system integrator.

The system integrator is responsible for the following tasks:

- Installing the industrial robot
- Connecting the industrial robot
- Performing risk assessment
- Implementing the required safety functions and safeguards
- Issuing the declaration of conformity
- Attaching the CE mark
- Creating the operating instructions for the complete system

Operator

The operator must meet the following preconditions:

- The operator must be trained for the work to be carried out.
- Work on the industrial robot must only be carried out by qualified personnel. These are people who, due to their specialist training, knowledge and experience, and their familiarization with the relevant standards, are able to assess the work to be carried out and detect any potential hazards.



Work on the electrical and mechanical equipment of the industrial robot may only be carried out by specially trained personnel.

5.3 Workspace, safety zone and danger zone

Workspaces are to be restricted to the necessary minimum size. A workspace must be safeguarded using appropriate safeguards.

The safeguards (e.g. safety gate) must be situated inside the safety zone. In the case of a stop, the manipulator and external axes (optional) are braked and come to a stop within the danger zone.

The danger zone consists of the workspace and the stopping distances of the manipulator and external axes (optional). It must be safeguarded by means of physical safeguards to prevent danger to persons or the risk of material damage.

5.3.1 Determining stopping distances

The system integrator's risk assessment may indicate that the stopping distances must be determined for an application. In order to determine the stopping distances, the system integrator must identify the safety-relevant points on the programmed path.

When determining the stopping distances, the robot must be moved with the tool and loads which are also used in the application. The robot must be at operating temperature. This is the case after approx. 1 h in normal operation.

During execution of the application, the robot must be stopped at the point from which the stopping distance is to be calculated. This process must be repeated several times with a safety stop 0 and a safety stop 1. The least favorable stopping distance is decisive.

A safety stop 0 can be triggered by a safe operational stop via the safety interface, for example. If a safety option is installed, it can be triggered, for instance, by a space violation (e.g. the robot exceeds the limit of an activated workspace in Automatic mode).

A safety stop 1 can be triggered by pressing the EMERGENCY STOP device on the smartPAD, for example.

5.4 Triggers for stop reactions

Stop reactions of the industrial robot are triggered in response to operator actions or as a reaction to monitoring functions and error messages. The following table shows the different stop reactions according to the operating mode that has been set.

Trigger	T1, T2	AUT, AUT EXT
Start key released	STOP 2	-
STOP key pressed	STOP 2	
Drives OFF	STOP 1	
“Motion enable” input drops out	STOP 2	
Power switched off via main switch or power failure	STOP 0	
Internal error in non-safety-oriented part of the robot controller	STOP 0 or STOP 1 (dependent on the cause of the error)	
Operating mode changed during operation	Safety stop 2	
Safety gate opened (operator safety)	-	Safety stop 1
Enabling switch released	Safety stop 2	-
Enabling switch pressed fully down or error	Safety stop 1	-
E-STOP pressed	Safety stop 1	
Error in safety controller or periphery of the safety controller	Safety stop 0	

5.5 Safety functions

5.5.1 Overview of the safety functions

The following safety functions are present in the industrial robot:

- Mode selection
- Operator safety (= connection for the guard interlock)
- EMERGENCY STOP device
- Enabling device
- External safe operational stop
- External safety stop 1 (not for the controller variant “KR C4 compact”)
- External safety stop 2
- Velocity monitoring in T1

The safety functions of the industrial robot meet the following requirements:

- **Category 3** and **Performance Level d** in accordance with EN ISO 13849-1:2008

The requirements are only met on the following condition, however:

- The EMERGENCY STOP device is pressed at least once every 6 months.

The following components are involved in the safety functions:

- Safety controller in the control PC

- KUKA smartPAD
- Cabinet Control Unit (CCU)
- Resolver Digital Converter (RDC)
- KUKA Power Pack (KPP)
- KUKA Servo Pack (KSP)
- Safety Interface Board (SIB) (if used)

There are also interfaces to components outside the industrial robot and to other robot controllers.

 **DANGER** In the absence of operational safety functions and safeguards, the industrial robot can cause personal injury or material damage. If safety functions or safeguards are dismantled or deactivated, the industrial robot may not be operated.

 During system planning, the safety functions of the overall system must also be planned and designed. The industrial robot must be integrated into this safety system of the overall system.

5.5.2 Safety controller

The safety controller is a unit inside the control PC. It links safety-relevant signals and safety-relevant monitoring functions.

Safety controller tasks:

- Switching off the drives; applying the brakes
- Monitoring the braking ramp
- Standstill monitoring (after the stop)
- Velocity monitoring in T1
- Evaluation of safety-relevant signals
- Setting of safety-oriented outputs

5.5.3 Mode selection

The industrial robot can be operated in the following modes:

- Manual Reduced Velocity (T1)
- Manual High Velocity (T2)
- Automatic (AUT)
- Automatic External (AUT EXT)

 Do not change the operating mode while a program is running. If the operating mode is changed during program execution, the industrial robot is stopped with a safety stop 2.

Operating mode	Use	Velocities
T1	For test operation, programming and teaching	<ul style="list-style-type: none"> ■ Program verification: Programmed velocity, maximum 250 mm/s ■ Jog mode: Jog velocity, maximum 250 mm/s
T2	For test operation	<ul style="list-style-type: none"> ■ Program verification: Programmed velocity ■ Jog mode: Not possible
AUT	For industrial robots without higher-level controllers	<ul style="list-style-type: none"> ■ Program mode: Programmed velocity ■ Jog mode: Not possible
AUT EXT	For industrial robots with higher-level controllers, e.g. PLC	<ul style="list-style-type: none"> ■ Program mode: Programmed velocity ■ Jog mode: Not possible

5.5.4 “Operator safety” signal

The “operator safety” signal is used for interlocking physical safeguards, e.g. safety gates. Automatic operation is not possible without this signal. In the event of a loss of signal during automatic operation (e.g. safety gate is opened), the manipulator stops with a safety stop 1.

Operator safety is not active in modes T1 (Manual Reduced Velocity) and T2 (Manual High Velocity).

 WARNING	<p>Following a loss of signal, automatic operation may only be resumed when the safeguard has been closed and when the closing has been acknowledged. This acknowledgement is to prevent automatic operation from being resumed inadvertently while there are still persons in the danger zone, e.g. due to the safety gate closing accidentally.</p> <p>The acknowledgement must be designed in such a way that an actual check of the danger zone can be carried out first. Other acknowledgement functions (e.g. an acknowledgement which is automatically triggered by closure of the safeguard) are not permitted.</p> <p>The system integrator is responsible for ensuring that these criteria are met. Failure to meet them may result in death, severe injuries or considerable damage to property.</p>
--	---

5.5.5 EMERGENCY STOP device

The EMERGENCY STOP device for the industrial robot is the EMERGENCY STOP device on the smartPAD. The device must be pressed in the event of a hazardous situation or emergency.

Reactions of the industrial robot if the EMERGENCY STOP device is pressed:

- The manipulator and any external axes (optional) are stopped with a safety stop 1.

Before operation can be resumed, the EMERGENCY STOP device must be turned to release it.

 **WARNING** Tools and other equipment connected to the manipulator must be integrated into the EMERGENCY STOP circuit on the system side if they could constitute a potential hazard. Failure to observe this precaution may result in death, severe injuries or considerable damage to property.

There must always be at least one external EMERGENCY STOP device installed. This ensures that an EMERGENCY STOP device is available even when the smartPAD is disconnected.

(>>> 5.5.7 "External EMERGENCY STOP device" Page 81)

5.5.6 Logging off from the higher-level safety controller

If the robot controller is connected to a higher-level safety controller, this connection will inevitably be terminated in the following cases:

- Switching off the voltage via the main switch of the robot
Or power failure
- Shutdown of the robot controller via the smartHMI
- Activation of a WorkVisual project in WorkVisual or directly on the robot controller
- Changes to **Start-up > Network configuration**
- Changes to **Configuration > Safety configuration**
- **I/O drivers > Reconfigure**
- Restoration of an archive

Effect of the interruption:

- If a discrete safety interface is used, this triggers an EMERGENCY STOP for the overall system.
- If the Ethernet interface is used, the KUKA safety controller generates a signal that prevents the higher-level controller from triggering an EMERGENCY STOP for the overall system.

 If the Ethernet safety interface is used: In his risk assessment, the system integrator must take into consideration whether the fact that switching off the robot controller does not trigger an EMERGENCY STOP of the overall system could constitute a hazard and, if so, how this hazard can be countered. Failure to take this into consideration may result in death, injuries or damage to property.

 **WARNING** If a robot controller is switched off, the E-STOP device on the smartPAD is no longer functional. The user is responsible for ensuring that the smartPAD is either covered or removed from the system. This serves to prevent operational and non-operational EMERGENCY STOP devices from becoming interchanged. Failure to observe this precaution may result in death, injuries or damage to property.

5.5.7 External EMERGENCY STOP device

Every operator station that can initiate a robot motion or other potentially hazardous situation must be equipped with an EMERGENCY STOP device. The system integrator is responsible for ensuring this.

There must always be at least one external EMERGENCY STOP device installed. This ensures that an EMERGENCY STOP device is available even when the smartPAD is disconnected.

External EMERGENCY STOP devices are connected via the customer interface. External EMERGENCY STOP devices are not included in the scope of supply of the industrial robot.

5.5.8 Enabling device

The enabling devices of the industrial robot are the enabling switches on the smartPAD.

There are 3 enabling switches installed on the smartPAD. The enabling switches have 3 positions:

- Not pressed
- Center position
- Panic position

In the test modes, the manipulator can only be moved if one of the enabling switches is held in the central position.

- Releasing the enabling switch triggers a safety stop 2.
- Pressing the enabling switch down fully (panic position) triggers a safety stop 1.
- It is possible to hold 2 enabling switches in the center position simultaneously for up to 15 seconds. This makes it possible to adjust grip from one enabling switch to another one. If 2 enabling switches are held simultaneously in the center position for longer than 15 seconds, this triggers a safety stop 1.

If an enabling switch malfunctions (jams), the industrial robot can be stopped using the following methods:

- Press the enabling switch down fully
- Actuate the EMERGENCY STOP system
- Release the Start key

 **WARNING** The enabling switches must not be held down by adhesive tape or other means or tampered with in any other way.
Death, injuries or damage to property may result.

5.5.9 External enabling device

External enabling devices are required if it is necessary for more than one person to be in the danger zone of the industrial robot.

External enabling devices are not included in the scope of supply of the industrial robot.

 Which interface can be used for connecting external enabling devices is described in the "Planning" chapter of the robot controller operating instructions and assembly instructions.

5.5.10 External safe operational stop

The safe operational stop can be triggered via an input on the customer interface. The state is maintained as long as the external signal is FALSE. If the

external signal is TRUE, the manipulator can be moved again. No acknowledgement is required.

5.5.11 External safety stop 1 and external safety stop 2

Safety stop 1 and safety stop 2 can be triggered via an input on the customer interface. The state is maintained as long as the external signal is FALSE. If the external signal is TRUE, the manipulator can be moved again. No acknowledgement is required.

 No external safety stop 1 is available for the controller variant "KR C4 compact".

5.5.12 Velocity monitoring in T1

The velocity at the TCP is monitored in T1 mode. If the velocity exceeds 250 mm/s, a safety stop 0 is triggered.

5.6 Additional protective equipment

5.6.1 Jog mode

In the operating modes T1 (Manual Reduced Velocity) and T2 (Manual High Velocity), the robot controller can only execute programs in jog mode. This means that it is necessary to hold down an enabling switch and the Start key in order to execute a program.

- Releasing the enabling switch triggers a safety stop 2.
- Pressing the enabling switch down fully (panic position) triggers a safety stop 1.
- Releasing the Start key triggers a STOP 2.

5.6.2 Software limit switches

The axis ranges of all manipulator and positioner axes are limited by means of adjustable software limit switches. These software limit switches only serve as machine protection and must be adjusted in such a way that the manipulator/positioner cannot hit the mechanical end stops.

The software limit switches are set during commissioning of an industrial robot.

 Further information is contained in the operating and programming instructions.

5.6.3 Mechanical end stops

Depending on the robot variant, the axis ranges of the main and wrist axes of the manipulator are partially limited by mechanical end stops.

Additional mechanical end stops can be installed on the external axes.



WARNING If the manipulator or an external axis hits an obstruction or a mechanical end stop or axis range limitation, the manipulator can no longer be operated safely. The manipulator must be taken out of operation and KUKA Roboter GmbH must be consulted before it is put back into operation (>>> 14 "KUKA Service" Page 207).

5.6.4 Mechanical axis range limitation (optional)

Some manipulators can be fitted with mechanical axis range limitation in axes A1 to A3. The adjustable axis range limitation systems restrict the working range to the required minimum. This increases personal safety and protection of the system.

In the case of manipulators that are not designed to be fitted with mechanical axis range limitation, the workspace must be laid out in such a way that there is no danger to persons or material property, even in the absence of mechanical axis range limitation.

If this is not possible, the workspace must be limited by means of photoelectric barriers, photoelectric curtains or obstacles on the system side. There must be no shearing or crushing hazards at the loading and transfer areas.



This option is not available for all robot models. Information on specific robot models can be obtained from KUKA Roboter GmbH.

5.6.5 Axis range monitoring (optional)

Some manipulators can be fitted with dual-channel axis range monitoring systems in main axes A1 to A3. The positioner axes may be fitted with additional axis range monitoring systems. The safety zone for an axis can be adjusted and monitored using an axis range monitoring system. This increases personal safety and protection of the system.



This option is not available for all robot models. Information on specific robot models can be obtained from KUKA Roboter GmbH.

5.6.6 Options for moving the manipulator without drive energy



The system user is responsible for ensuring that the training of personnel with regard to the response to emergencies or exceptional situations also includes how the manipulator can be moved without drive energy.

Description

The following options are available for moving the manipulator without drive energy after an accident or malfunction:

- Release device (optional)

The release device can be used for the main axis drive motors and, depending on the robot variant, also for the wrist axis drive motors.

- Brake release device (option)

The brake release device is designed for robot variants whose motors are not freely accessible.

- Moving the wrist axes directly by hand
There is no release device available for the wrist axes of variants in the low payload category. This is not necessary because the wrist axes can be moved directly by hand.



Information about the options available for the various robot models and about how to use them can be found in the assembly and operating instructions for the robot or requested from KUKA Roboter GmbH.

NOTICE

Moving the manipulator without drive energy can damage the motor brakes of the axes concerned. The motor must be replaced if the brake has been damaged. The manipulator may therefore be moved without drive energy only in emergencies, e.g. for rescuing persons.

5.6.7 Labeling on the industrial robot

All plates, labels, symbols and marks constitute safety-relevant parts of the industrial robot. They must not be modified or removed.

Labeling on the industrial robot consists of:

- Identification plates
- Warning signs
- Safety symbols
- Designation labels
- Cable markings
- Rating plates



Further information is contained in the technical data of the operating instructions or assembly instructions of the components of the industrial robot.

5.6.8 External safeguards

The access of persons to the danger zone of the industrial robot must be prevented by means of safeguards. It is the responsibility of the system integrator to ensure this.

Physical safeguards must meet the following requirements:

- They meet the requirements of EN 953.
- They prevent access of persons to the danger zone and cannot be easily circumvented.
- They are sufficiently fastened and can withstand all forces that are likely to occur in the course of operation, whether from inside or outside the enclosure.
- They do not, themselves, represent a hazard or potential hazard.
- The prescribed minimum clearance from the danger zone is maintained.

Safety gates (maintenance gates) must meet the following requirements:

- They are reduced to an absolute minimum.
- The interlocks (e.g. safety gate switches) are linked to the operator safety input of the robot controller via safety gate switching devices or safety PLC.

- Switching devices, switches and the type of switching conform to the requirements of Performance Level d and category 3 according to EN ISO 13849-1.
- Depending on the risk situation: the safety gate is additionally safeguarded by means of a locking mechanism that only allows the gate to be opened if the manipulator is safely at a standstill.
- The button for acknowledging the safety gate is located outside the space limited by the safeguards.

 Further information is contained in the corresponding standards and regulations. These also include EN 953.

Other safety equipment

Other safety equipment must be integrated into the system in accordance with the corresponding standards and regulations.

5.7 Overview of operating modes and safety functions

The following table indicates the operating modes in which the safety functions are active.

Safety functions	T1	T2	AUT	AUT EXT
Operator safety	-	-	active	active
EMERGENCY STOP device	active	active	active	active
Enabling device	active	active	-	-
Reduced velocity during program verification	active	-	-	-
Jog mode	active	active	-	-
Software limit switches	active	active	active	active

5.8 Safety measures

5.8.1 General safety measures

The industrial robot may only be used in perfect technical condition in accordance with its intended use and only by safety-conscious persons. Operator errors can result in personal injury and damage to property.

It is important to be prepared for possible movements of the industrial robot even after the robot controller has been switched off and locked out. Incorrect installation (e.g. overload) or mechanical defects (e.g. brake defect) can cause the manipulator or external axes to sag. If work is to be carried out on a switched-off industrial robot, the manipulator and external axes must first be moved into a position in which they are unable to move on their own, whether the payload is mounted or not. If this is not possible, the manipulator and external axes must be secured by appropriate means.

 **DANGER** In the absence of operational safety functions and safeguards, the industrial robot can cause personal injury or material damage. If safety functions or safeguards are dismantled or deactivated, the industrial robot may not be operated.

 **DANGER** Standing underneath the robot arm can cause death or injuries. For this reason, standing underneath the robot arm is prohibited!

CAUTION The motors reach temperatures during operation which can cause burns to the skin. Contact must be avoided. Appropriate safety precautions must be taken, e.g. protective gloves must be worn.

smartPAD

The user must ensure that the industrial robot is only operated with the smartPAD by authorized persons.

If more than one smartPAD is used in the overall system, it must be ensured that each smartPAD is unambiguously assigned to the corresponding industrial robot. They must not be interchanged.

WARNING The operator must ensure that decoupled smartPADs are immediately removed from the system and stored out of sight and reach of personnel working on the industrial robot. This serves to prevent operational and non-operational EMERGENCY STOP devices from becoming interchanged. Failure to observe this precaution may result in death, severe injuries or considerable damage to property.

Modifications

After modifications to the industrial robot, checks must be carried out to ensure the required safety level. The valid national or regional work safety regulations must be observed for this check. The correct functioning of all safety functions must also be tested.

New or modified programs must always be tested first in Manual Reduced Velocity mode (T1).

After modifications to the industrial robot, existing programs must always be tested first in Manual Reduced Velocity mode (T1). This applies to all components of the industrial robot and includes modifications to the software and configuration settings.

Faults

The following tasks must be carried out in the case of faults in the industrial robot:

- Switch off the robot controller and secure it (e.g. with a padlock) to prevent unauthorized persons from switching it on again.
- Indicate the fault by means of a label with a corresponding warning (tag-out).
- Keep a record of the faults.
- Eliminate the fault and carry out a function test.

5.8.2 Transportation**Manipulator**

The prescribed transport position of the manipulator must be observed. Transportation must be carried out in accordance with the operating instructions or assembly instructions of the robot.

Avoid vibrations and impacts during transportation in order to prevent damage to the manipulator.

Robot controller

The prescribed transport position of the robot controller must be observed. Transportation must be carried out in accordance with the operating instructions or assembly instructions of the robot controller.

Avoid vibrations and impacts during transportation in order to prevent damage to the robot controller.

External axis (optional)

The prescribed transport position of the external axis (e.g. KUKA linear unit, turn-tilt table, positioner) must be observed. Transportation must be carried

out in accordance with the operating instructions or assembly instructions of the external axis.

5.8.3 Start-up and recommissioning

Before starting up systems and devices for the first time, a check must be carried out to ensure that the systems and devices are complete and operational, that they can be operated safely and that any damage is detected.

The valid national or regional work safety regulations must be observed for this check. The correct functioning of all safety functions must also be tested.



The passwords for the user groups must be changed in the KUKA System Software before start-up. The passwords must only be communicated to authorized personnel.



The robot controller is preconfigured for the specific industrial robot. If cables are interchanged, the manipulator and the external axes (optional) may receive incorrect data and can thus cause personal injury or material damage. If a system consists of more than one manipulator, always connect the connecting cables to the manipulators and their corresponding robot controllers.



If additional components (e.g. cables), which are not part of the scope of supply of KUKA Roboter GmbH, are integrated into the industrial robot, the user is responsible for ensuring that these components do not adversely affect or disable safety functions.

NOTICE

If the internal cabinet temperature of the robot controller differs greatly from the ambient temperature, condensation can form, which may cause damage to the electrical components. Do not put the robot controller into operation until the internal temperature of the cabinet has adjusted to the ambient temperature.

Function test

The following tests must be carried out before start-up and recommissioning:

General test:

It must be ensured that:

- The industrial robot is correctly installed and fastened in accordance with the specifications in the documentation.
- There are no foreign bodies or loose parts on the industrial robot.
- All required safety equipment is correctly installed and operational.
- The power supply ratings of the industrial robot correspond to the local supply voltage and mains type.
- The ground conductor and the equipotential bonding cable are sufficiently rated and correctly connected.
- The connecting cables are correctly connected and the connectors are locked.

Test of the safety functions:

A function test must be carried out for the following safety functions to ensure that they are functioning correctly:

- Local EMERGENCY STOP device
- External EMERGENCY STOP device (input and output)
- Enabling device (in the test modes)
- Operator safety

- All other safety-relevant inputs and outputs used
- Other external safety functions

5.8.3.1 Checking machine data and safety configuration

 **WARNING** The industrial robot must not be moved if incorrect machine data or an incorrect controller configuration are loaded. Death, severe injuries or considerable damage to property may otherwise result. The correct data must be loaded.

- It must be ensured that the rating plate on the robot controller has the same machine data as those entered in the declaration of incorporation. The machine data on the rating plate of the manipulator and the external axes (optional) must be entered during start-up.
- The practical tests for the machine data must be carried out within the scope of the start-up procedure.
- Following modifications to the machine data, the safety configuration must be checked.
- After activation of a WorkVisual project on the robot controller, the safety configuration must be checked!
- If machine data are adopted when checking the safety configuration (regardless of the reason for the safety configuration check), the practical tests for the machine data must be carried out.
- System Software 8.3 or higher: If the checksum of the safety configuration has changed, the safe axis monitoring functions must be checked.

 Information about checking the safety configuration and the safe axis monitoring functions is contained in the Operating and Programming Instructions for System Integrators.

If the practical tests are not successfully completed in the initial start-up, KUKA Roboter GmbH must be contacted.

If the practical tests are not successfully completed during a different procedure, the machine data and the safety-relevant controller configuration must be checked and corrected.

General practical test

If practical tests are required for the machine data, this test must always be carried out.

The following methods are available for performing the practical test:

- TCP calibration with the XYZ 4-point method
The practical test is passed if the TCP has been successfully calibrated.

Or:

1. Align the TCP with a freely selected point.
The point serves as a reference point. It must be located so that reorientation is possible.
2. Move the TCP manually at least 45° once in each of the A, B and C directions.

The movements do not have to be accumulative, i.e. after motion in one direction it is possible to return to the original position before moving in the next direction.

The practical test is passed if the TCP does not deviate from the reference point by more than 2 cm in total.

Practical test for axes that are not mathematically coupled

If practical tests are required for the machine data, this test must be carried out when axes are present that are not mathematically coupled.

1. Mark the starting position of the axis that is not mathematically coupled.
2. Move the axis manually by a freely selected path length. Determine the path length from the display **Actual position** on the smartHMI.
 - Move linear axes a specific distance.
 - Move rotational axes through a specific angle.
3. Measure the length of the path covered and compare it with the value displayed on the smartHMI.

The practical test is passed if the values differ by no more than 10%.
4. Repeat the test for each axis that is not mathematically coupled.

Practical test for couplable axes

If practical tests are required for the machine data, this test must be carried out when axes are present that can be physically coupled and uncoupled, e.g. a servo gun.

1. Physically uncouple the couplable axis.
2. Move all the remaining axes individually.

The practical test is passed if it has been possible to move all the remaining axes.

5.8.3.2 Start-up mode**Description**

The industrial robot can be set to Start-up mode via the smartHMI user interface. In this mode, the manipulator can be moved in T1 without the external safeguards being put into operation.

When Start-up mode is possible depends on the safety interface that is used.

Discrete safety interface

- System Software 8.2 or earlier:

Start-up mode is always possible if all input signals at the discrete safety interface have the state "logic zero". If this is not the case, the robot controller prevents or terminates Start-up mode.

If an additional discrete safety interface for safety options is used, the inputs there must also have the state "logic zero".

- System Software 8.3 or higher:

Start-up mode is always possible. This also means that it is independent of the state of the inputs at the discrete safety interface.

If an additional discrete safety interface is used for safety options: The states of these inputs are also irrelevant.

Ethernet safety interface

The robot controller prevents or terminates Start-up mode if a connection to a higher-level safety system exists or is established.

Effect

When the Start-up mode is activated, all outputs are automatically set to the state "logic zero".

If the robot controller has a peripheral contactor (US2), and if the safety configuration specifies for this to switch in accordance with the motion enable, then the same also applies in Start-up mode. This means that if motion enable is present, the US2 voltage is switched on – even in Start-up mode.

Hazards

Possible hazards and risks involved in using Start-up mode:

- A person walks into the manipulator's danger zone.
- In a hazardous situation, a disabled external EMERGENCY STOP device is actuated and the manipulator is not shut down.

Additional measures for avoiding risks in Start-up mode:

- Cover disabled EMERGENCY STOP devices or attach a warning sign indicating that the EMERGENCY STOP device is out of operation.
- If there is no safety fence, other measures must be taken to prevent persons from entering the manipulator's danger zone, e.g. use of warning tape.

Use

Intended use of Start-up mode:

- Start-up in T1 mode when the external safeguards have not yet been installed or put into operation. The danger zone must be delimited at least by means of warning tape.
- Fault localization (periphery fault).
- Use of Start-up mode must be minimized as much as possible.

 **WARNING** Use of Start-up mode disables all external safeguards. The service personnel are responsible for ensuring that there is no-one in or near the danger zone of the manipulator as long as the safeguards are disabled. Failure to observe this precaution may result in death, injuries or damage to property.

Misuse

Any use or application deviating from the intended use is deemed to be misuse and is not allowed. KUKA Roboter GmbH is not liable for any damage resulting from such misuse. The risk lies entirely with the user.

5.8.4 Manual mode

Manual mode is the mode for setup work. Setup work is all the tasks that have to be carried out on the industrial robot to enable automatic operation. Setup work includes:

- Jog mode
- Teaching
- Programming
- Program verification

The following must be taken into consideration in manual mode:

- New or modified programs must always be tested first in Manual Reduced Velocity mode (T1).
- The manipulator, tooling or external axes (optional) must never touch or project beyond the safety fence.
- Workpieces, tooling and other objects must not become jammed as a result of the industrial robot motion, nor must they lead to short-circuits or be liable to fall off.
- All setup work must be carried out, where possible, from outside the safeguarded area.

If the setup work has to be carried out inside the safeguarded area, the following must be taken into consideration:

In Manual Reduced Velocity mode (T1):

- If it can be avoided, there must be no other persons inside the safeguarded area.

If it is necessary for there to be several persons inside the safeguarded area, the following must be observed:

- Each person must have an enabling device.
- All persons must have an unimpeded view of the industrial robot.

- Eye-contact between all persons must be possible at all times.
- The operator must be so positioned that he can see into the danger area and get out of harm's way.

In **Manual High Velocity mode (T2)**:

- This mode may only be used if the application requires a test at a velocity higher than Manual Reduced Velocity.
- Teaching and programming are not permissible in this operating mode.
- Before commencing the test, the operator must ensure that the enabling devices are operational.
- The operator must be positioned outside the danger zone.
- There must be no other persons inside the safeguarded area. It is the responsibility of the operator to ensure this.

5.8.5 Simulation

Simulation programs do not correspond exactly to reality. Robot programs created in simulation programs must be tested in the system in **Manual Reduced Velocity mode (T1)**. It may be necessary to modify the program.

5.8.6 Automatic mode

Automatic mode is only permissible in compliance with the following safety measures:

- All safety equipment and safeguards are present and operational.
- There are no persons in the system.
- The defined working procedures are adhered to.

If the manipulator or an external axis (optional) comes to a standstill for no apparent reason, the danger zone must not be entered until an EMERGENCY STOP has been triggered.

5.8.7 Maintenance and repair

After maintenance and repair work, checks must be carried out to ensure the required safety level. The valid national or regional work safety regulations must be observed for this check. The correct functioning of all safety functions must also be tested.

The purpose of maintenance and repair work is to ensure that the system is kept operational or, in the event of a fault, to return the system to an operational state. Repair work includes troubleshooting in addition to the actual repair itself.

The following safety measures must be carried out when working on the industrial robot:

- Carry out work outside the danger zone. If work inside the danger zone is necessary, the user must define additional safety measures to ensure the safe protection of personnel.
- Switch off the industrial robot and secure it (e.g. with a padlock) to prevent it from being switched on again. If it is necessary to carry out work with the robot controller switched on, the user must define additional safety measures to ensure the safe protection of personnel.
- If it is necessary to carry out work with the robot controller switched on, this may only be done in operating mode T1.
- Label the system with a sign indicating that work is in progress. This sign must remain in place, even during temporary interruptions to the work.

- The EMERGENCY STOP systems must remain active. If safety functions or safeguards are deactivated during maintenance or repair work, they must be reactivated immediately after the work is completed.

 **DANGER**

Before work is commenced on live parts of the robot system, the main switch must be turned off and secured against being switched on again. The system must then be checked to ensure that it is deenergized.

It is not sufficient, before commencing work on live parts, to execute an EMERGENCY STOP or a safety stop, or to switch off the drives, as this does not disconnect the robot system from the mains power supply. Parts remain energized. Death or severe injuries may result.

Faulty components must be replaced using new components with the same article numbers or equivalent components approved by KUKA Roboter GmbH for this purpose.

Cleaning and preventive maintenance work is to be carried out in accordance with the operating instructions.

Robot controller

Even when the robot controller is switched off, parts connected to peripheral devices may still carry voltage. The external power sources must therefore be switched off if work is to be carried out on the robot controller.

The ESD regulations must be adhered to when working on components in the robot controller.

Voltages in excess of 50 V (up to 780 V) can be present in various components for several minutes after the robot controller has been switched off! To prevent life-threatening injuries, no work may be carried out on the industrial robot in this time.

Water and dust must be prevented from entering the robot controller.

Counterbalancing system

Some robot variants are equipped with a hydropneumatic, spring or gas cylinder counterbalancing system.

The hydropneumatic and gas cylinder counterbalancing systems are pressure equipment and, as such, are subject to obligatory equipment monitoring and the provisions of the Pressure Equipment Directive.

The user must comply with the applicable national laws, regulations and standards pertaining to pressure equipment.

Inspection intervals in Germany in accordance with Industrial Safety Order, Sections 14 and 15. Inspection by the user before commissioning at the installation site.

The following safety measures must be carried out when working on the counterbalancing system:

- The manipulator assemblies supported by the counterbalancing systems must be secured.
- Work on the counterbalancing systems must only be carried out by qualified personnel.

Hazardous substances

The following safety measures must be carried out when handling hazardous substances:

- Avoid prolonged and repeated intensive contact with the skin.
- Avoid breathing in oil spray or vapors.
- Clean skin and apply skin cream.



To ensure safe use of our products, we recommend that our customers regularly request up-to-date safety data sheets from the manufacturers of hazardous substances.

5.8.8 Decommissioning, storage and disposal

The industrial robot must be decommissioned, stored and disposed of in accordance with the applicable national laws, regulations and standards.

5.8.9 Safety measures for “single point of control”

Overview

If certain components in the industrial robot are operated, safety measures must be taken to ensure complete implementation of the principle of “single point of control” (SPOC).

The relevant components are:

- Submit interpreter
- PLC
- OPC Server
- Remote control tools
- Tools for configuration of bus systems with online functionality
- KUKA.RobotSensorInterface



The implementation of additional safety measures may be required. This must be clarified for each specific application; this is the responsibility of the system integrator, programmer or user of the system.

Since only the system integrator knows the safe states of actuators in the periphery of the robot controller, it is his task to set these actuators to a safe state, e.g. in the event of an EMERGENCY STOP.

T1, T2

In modes T1 and T2, the components referred to above may only access the industrial robot if the following signals have the following states:

Signal	State required for SPOC
\$USER_SAF	TRUE
\$SPOC_MOTION_ENABLE	TRUE

Submit interpreter, PLC

If motions, (e.g. drives or grippers) are controlled with the submit interpreter or the PLC via the I/O system, and if they are not safeguarded by other means, then this control will take effect even in T1 and T2 modes or while an EMERGENCY STOP is active.

If variables that affect the robot motion (e.g. override) are modified with the submit interpreter or the PLC, this takes effect even in T1 and T2 modes or while an EMERGENCY STOP is active.

Safety measures:

- In T1 and T2, the system variable \$OV_PRO must not be written to by the submit interpreter or the PLC.
- Do not modify safety-relevant signals and variables (e.g. operating mode, EMERGENCY STOP, safety gate contact) via the submit interpreter or PLC.

If modifications are nonetheless required, all safety-relevant signals and variables must be linked in such a way that they cannot be set to a dangerous state by the submit interpreter or PLC. This is the responsibility of the system integrator.

OPC server, remote control tools

These components can be used with write access to modify programs, outputs or other parameters of the robot controller, without this being noticed by any persons located inside the system.

Safety measure:

If these components are used, outputs that could cause a hazard must be determined in a risk assessment. These outputs must be designed in such a way that they cannot be set without being enabled. This can be done using an external enabling device, for example.

Tools for configuration of bus systems

If these components have an online functionality, they can be used with write access to modify programs, outputs or other parameters of the robot controller, without this being noticed by any persons located inside the system.

- WorkVisual from KUKA
- Tools from other manufacturers

Safety measure:

In the test modes, programs, outputs or other parameters of the robot controller must not be modified using these components.

5.9 Applied norms and regulations

Name	Definition	Edition
2006/42/EC	Machinery Directive: Directive 2006/42/EC of the European Parliament and of the Council of 17 May 2006 on machinery, and amending Directive 95/16/EC (recast)	2006
2004/108/EC	EMC Directive: Directive 2004/108/EC of the European Parliament and of the Council of 15 December 2004 on the approximation of the laws of the Member States relating to electromagnetic compatibility and repealing Directive 89/336/EEC	2004
97/23/EC	Pressure Equipment Directive: Directive 97/23/EC of the European Parliament and of the Council of 29 May 1997 on the approximation of the laws of the Member States concerning pressure equipment (Only applicable for robots with hydropneumatic counterbalancing system.)	1997
EN ISO 13850	Safety of machinery: Emergency stop - Principles for design	2008
EN ISO 13849-1	Safety of machinery: Safety-related parts of control systems - Part 1: General principles of design	2008
EN ISO 13849-2	Safety of machinery: Safety-related parts of control systems - Part 2: Validation	2012
EN ISO 12100	Safety of machinery: General principles of design, risk assessment and risk reduction	2010

EN ISO 10218-1	Industrial robots: Safety Note: Content equivalent to ANSI/RIA R.15.06-2012, Part 1	2011
EN 614-1	Safety of machinery: Ergonomic design principles - Part 1: Terms and general principles	2009
EN 61000-6-2	Electromagnetic compatibility (EMC): Part 6-2: Generic standards; Immunity for industrial environments	2005
EN 61000-6-4 + A1	Electromagnetic compatibility (EMC): Part 6-4: Generic standards; Emission standard for industrial environments	2011
EN 60204-1 + A1	Safety of machinery: Electrical equipment of machines - Part 1: General requirements	2009

6 Planning

Overview

Step	Description	Information
1	Electromagnetic compatibility (EMC)	(>>> 6.1 "Electromagnetic compatibility (EMC)" Page 97)
2	Installation conditions for robot controller	(>>> 6.2 "Installation conditions" Page 97)
3	Connection conditions	(>>> 6.3 "Connection conditions" Page 100)
4	Mounting the KUKA smart-PAD holder (optional)	(>>> 4.6 "Dimensions of the smartPAD holder (optional)" Page 68)
5	Power supply connection	(>>> 6.5 "Power supply connection via X1 Harting connector" Page 102)
6	Safety interface X11	(>>> 6.6.1 "Safety interface X11" Page 104)
7	Ethernet safety interface X66	(>>> 6.7 "Safety functions via Ethernet safety interface (optional)" Page 112)
8	EtherCAT connection on the CIB	(>>> 6.8 "EtherCAT connection on the CIB" Page 120)
9	PE equipotential bonding	(>>> 6.9 "PE equipotential bonding" Page 120)
10	Modification of the system structure, exchange of devices	(>>> 6.10 "Modifying the system configuration, exchanging devices" Page 122)
11	Acknowledgement of operator safety	(>>> 6.11 "Operator safety acknowledgement" Page 122)
12	Performance Level	(>>> 6.12 "Performance level" Page 122)

6.1 Electromagnetic compatibility (EMC)

Description

If connecting cables (e.g. field buses, etc.) are routed to the control PC from outside, only shielded cables with an adequate degree of shielding may be used. The cable shield must be connected with maximum surface area to the PE rail in the cabinet using shield terminals (screw-type, no clamps).



The robot controller corresponds to EMC class A, Group 1, in accordance with EN 55011 and is intended for use in an **industrial setting**. Ascertaining the electromagnetic compatibility in other environments can result in difficulties due to conducted and radiated disturbance that may occur.

6.2 Installation conditions

The dimensions of the robot controller are indicated in the diagram (>>> Fig. 6-1).

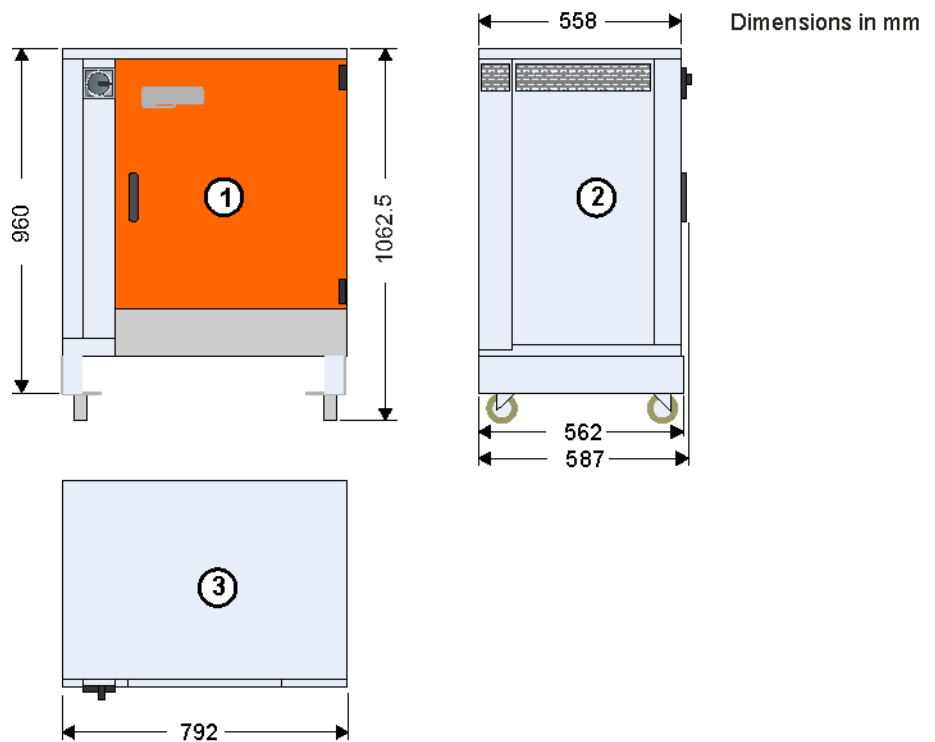

Fig. 6-1: Dimensions

- 1 Front view
- 2 Side view
- 3 Top view

The minimum clearances that must be maintained for the robot controller are indicated in the diagram (>>> Fig. 6-2).

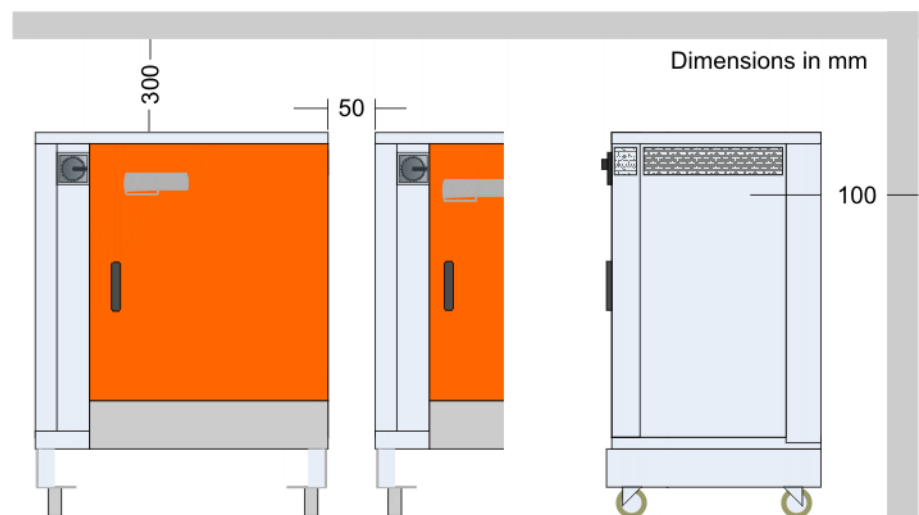

Fig. 6-2: Minimum clearances

NOTICE If the minimum clearances are not maintained, this can result in damage to the robot controller. The specified minimum clearances must always be observed.

i Certain maintenance and repair tasks on the robot controller (>>> 10 "Maintenance" Page 143) (>>> 11 "Repair" Page 147) must be carried out from the side or from the rear. The robot controller must be accessible for this. If the side or rear panels are not accessible, it must be possible to move the robot controller into a position in which the work can be carried out.

The diagram (>>> Fig. 6-3) shows the swing range for the door.

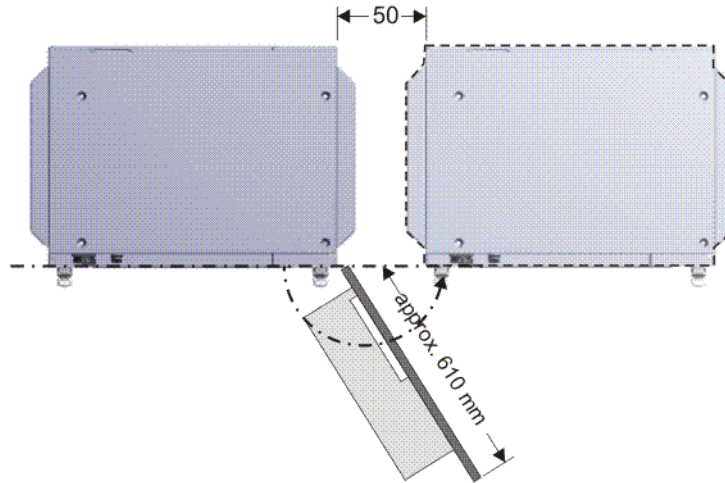

Fig. 6-3: Swing range for cabinet door

Swing range, standalone cabinet:

- Door with computer frame approx. 180°

Swing range, butt-mounted cabinets:

- Door approx. 155°

Robot controller stacked

One robot controller can be stacked on top of another one. The upper robot controller, with standard cabinet base only, must be firmly screwed to the lower one. To do so, the 4 threads of the eyebolts must be used. The lower robot controller must not be mounted on rollers and must be fastened to the floor.

A stacked robot controller is illustrated in the diagram (>>> Fig. 6-4).

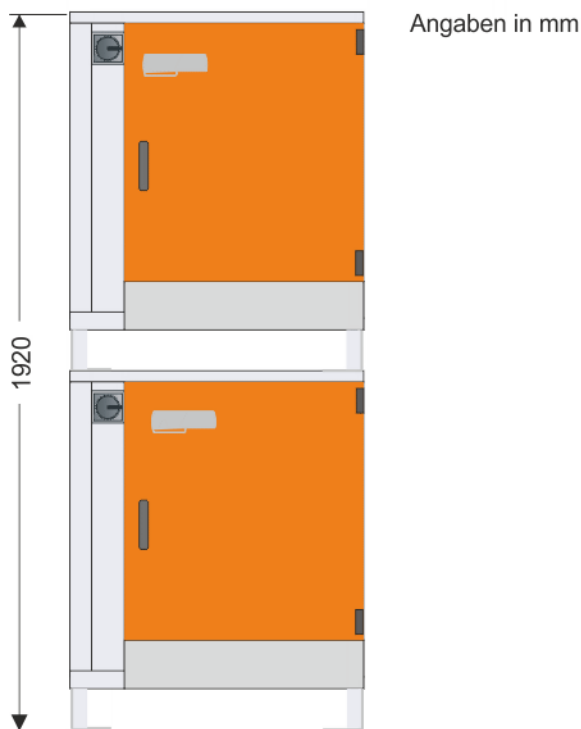

Fig. 6-4: Stacked robot controller

6.3 Connection conditions

Power supply connection

CAUTION If the robot controller is connected to a power system without a grounded neutral or is operated with incorrect machine data, this may cause malfunctions in the robot controller and material damage to the power supply units. Electrical voltage can cause injuries. The robot controller may only be operated with grounded-neutral power supply systems.

If no grounded neutral is available, or if the mains voltage differs from those specified here, a transformer must be used.

Rated supply voltage according to the machine data, optionally:	AC 3x380 V, AC 3x400 V, AC 3x440 V or AC 3x480 V
Permissible tolerance of rated supply voltage	Rated supply voltage $\pm 10\%$
Mains frequency	49 ... 61 Hz
System impedance up to the connection point of the robot controller	$\leq 300 \text{ m}\Omega$
Full-load current	See identification plate
Mains-side fusing without transformer	min. 3x25 A, slow-blowing
Mains-side fusing with transformer	min. 3x32 A, slow-blowing, with 13 kVA
Equipotential bonding	The common neutral point for the equipotential bonding conductors and all protective ground conductors is the reference bus of the power unit.

 **CAUTION** If the robot controller is connected to a power system **without** a grounded neutral, this may cause malfunctions in the robot controller and material damage to the power supply units. Electrical voltage can cause injuries. The robot controller may only be operated with grounded-neutral power supply systems.

 **NOTICE** If the robot controller is operated with a supply voltage other than that specified on the rating plate, this may cause malfunctions in the robot controller and material damage to the power supply units. The robot controller may only be operated with the supply voltage specified on the rating plate.

 The appropriate machine data must be loaded in accordance with the rated supply voltage.

 If use of a residual-current circuit-breaker (RCCB) is planned, we recommend the following RCCB: trip current difference 300 mA per robot controller, universal-current sensitive, selective.

Cable lengths

For cable designations, standard lengths and optional lengths, please refer to the operating instructions or assembly instructions of the manipulator and/or the assembly and operating instructions for KR C4 external cabling for robot controllers.

 When using smartPAD cable extensions, only two extensions may be used. An overall cable length of 50 m must not be exceeded.

 The difference in the cable lengths between the individual channels of the RDC box must not exceed 10 m.

PELV external power supply

External voltage	PELV power supply unit acc. to EN 60950 with rated voltage 27 V (18 V ... 30 V), safely isolated
Continuous current	> 8 A
Cable cross-section of power supply cable	$\geq 1 \text{ mm}^2$
Cable length of power supply cable	< 50 m, or < 100 m wire length (outgoing and incoming lines)

 The cables of the power supply unit must not be routed together with power-carrying cables.

 The minus connection of the external voltage must be grounded by the customer.

 Parallel connection of a basic-insulated device is not permitted.

6.4 Fastening the KUKA smartPAD holder (optional)

Overview

The smartPAD holder can be installed on the door of the robot controller or on the safety fence.

The following diagram (>>> Fig. 6-5) shows the options for fastening the smartPAD holder.

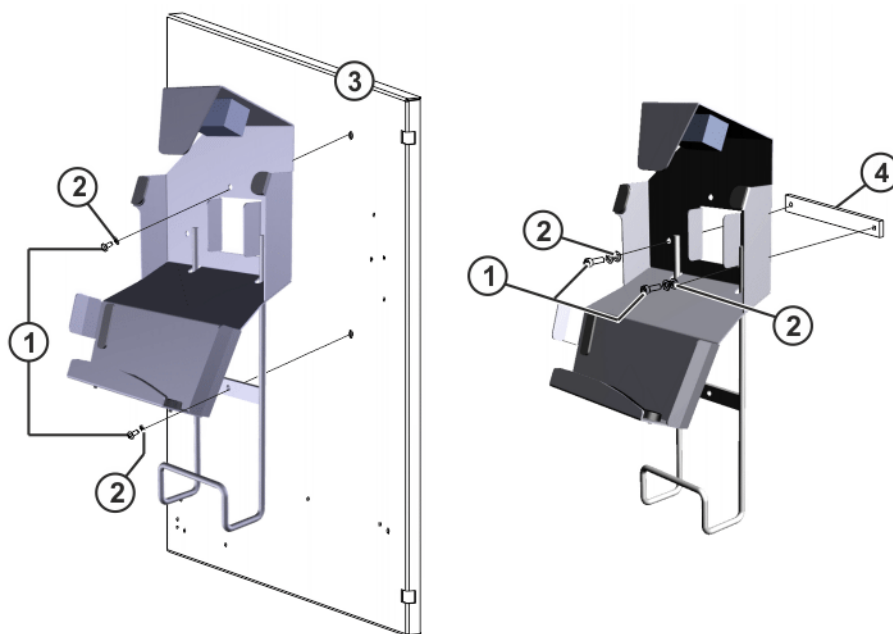

Fig. 6-5: smartPAD holder

- | | |
|--|--------------------------------|
| 1 M6x12 Allen screw | 3 Door of robot controller |
| 2 Spring lock washer A6.1 and plain washer | 4 Iron flat for fence mounting |

6.5 Power supply connection via X1 Harting connector

Description

A Harting connector bypack is supplied with the robot controller. The customer can connect the robot controller to the power supply via connector X1.

i If the robot controller is connected to a rated supply voltage greater than 400 V without a transformer, the power cable to X1 must be shielded. The shield must be connected to ground on at least one side.

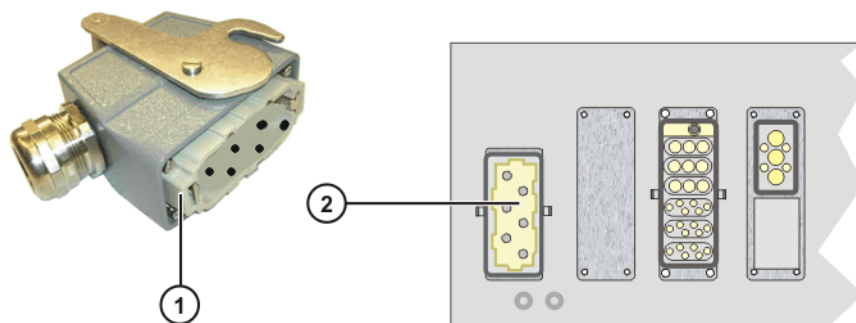

Fig. 6-6: Power supply connection X1

- | |
|---------------------------------------|
| 1 Harting connector bypack (optional) |
| 2 Power supply connection X1 |

6.6 Description of safety interface X11

- Description** EMERGENCY STOP devices must be connected via safety interface X11 or linked together by means of higher-level controllers (e.g. PLC). (>>> "SIB outputs" Page 65)
- Wiring** Take the following points into consideration when wiring safety interface X11:
- System concept
 - Safety concept

6.6.1 Safety interface X11

Connector pin allocation

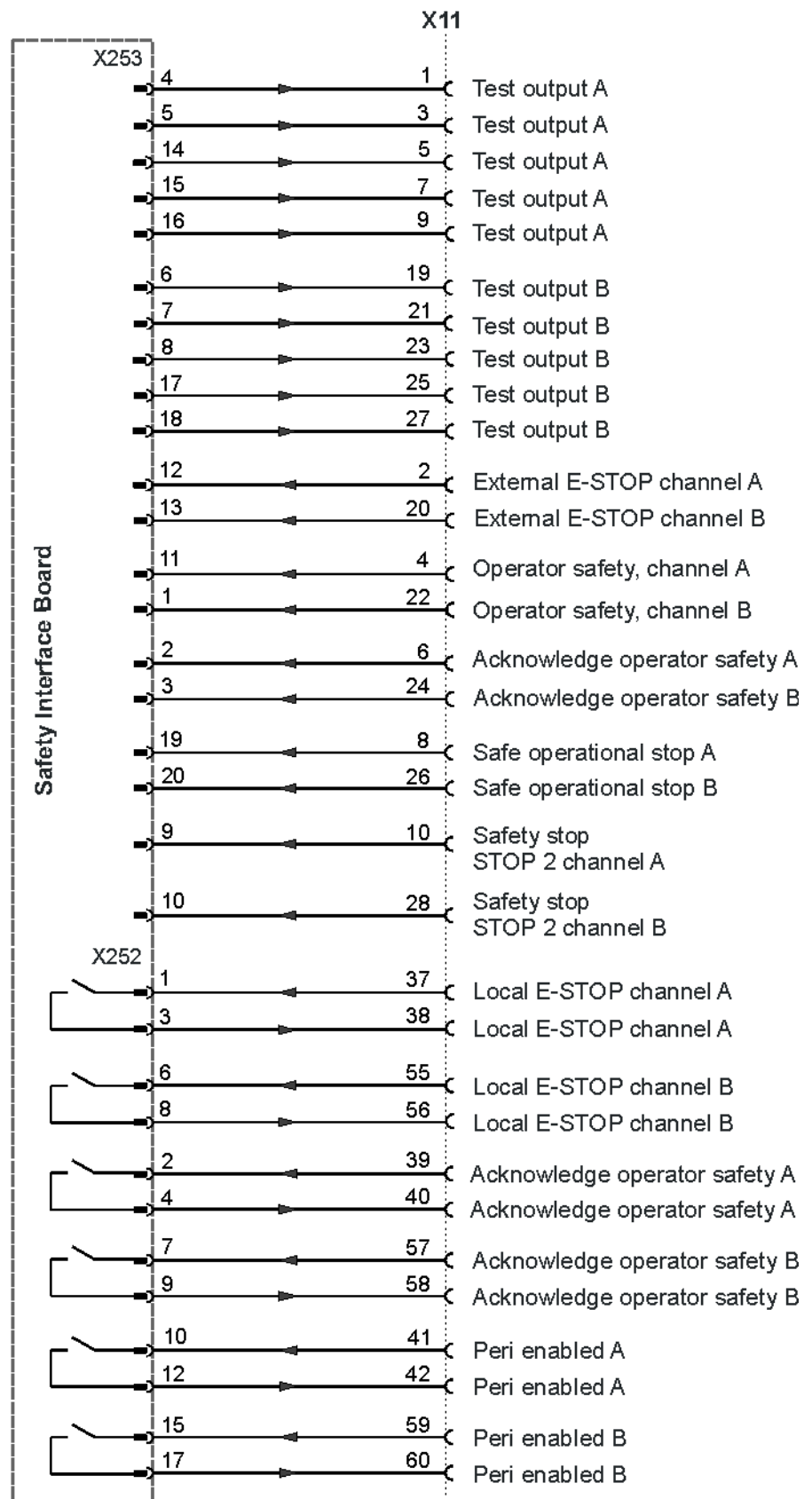

Fig. 6-7: Interface X11, connector pin allocation

Signal	Pin	Description	Note
SIB test output A (test signal)	1	Makes the pulsed voltage available for the individual interface inputs of channel A.	These signals may only be mapped with the SIB.
	3		
	5		
	7		
	9		
SIB test output B (test signal)	19	Makes the clocked voltage available for the individual interface inputs of channel B.	
	21		
	23		
	25		
	27		
Safe operational stop, channel A	8	Safe operational stop input for all axes	Activation of standstill monitoring Stop 0 is initiated if the activated monitoring is violated.
Safe operational stop, channel B	26		
Safety stop, Stop 2 channel A	10	Safety stop (Stop 2) input for all axes	Triggering of Stop 2 and activation of standstill monitoring at standstill of all axes. Stop 0 is initiated if the activated monitoring is violated.
Safety stop, Stop 2 channel B	28		
Local E-STOP channel A	37	Output, floating contacts from internal E-STOP, (>>> "SIB outputs" Page 65)	The contacts are closed if the following conditions are met: <ul style="list-style-type: none"> ■ E-STOP on smartPAD not actuated ■ Controller switched on and operational The contacts open if any condition is not met.
	38		
Local E-STOP channel B	55		
	56		
External E-STOP channel A	2	Dual-channel E-STOP input, (>>> "SIB inputs" Page 66)	Triggering of the E-STOP function in the robot controller.
External E-STOP channel B	20		
Acknowledge operator safety, channel A	6	For connection of a dual-channel input for acknowledging operator safety with floating contacts, (>>> "SIB inputs" Page 66)	The response of the "Operator safety acknowledgement" input can be configured in the KUKA system software. After closing the safety gate (operator safety), manipulator motion can be enabled in the automatic modes using an acknowledge button outside the safety fence. This function is deactivated on delivery.
Acknowledge operator safety, channel B	24		
Operator safety, channel A	4	For 2-channel connection of a safety gate locking mechanism, (>>> "SIB inputs" Page 66)	As long as the signal is active, the drives can be switched on. Only effective in the AUTOMATIC modes.
Operator safety, channel B	22		

Signal	Pin	Description	Note
Peri enabled channel A	41 42	Output, floating contact (>>> "SIB outputs" Page 65)	(>>> "Signal "Peri enabled" (PE)" Page 106)
Peri enabled channel B	59 60	Output, floating contact (>>> "SIB outputs" Page 65)	
Acknowledge operator safety, channel A	39 40	Output, floating contact for operator safety acknowledgement (>>> "SIB outputs" Page 65)	Relaying of the acknowledge operator safety input signal to other robot controllers at the same safety fencing.
Acknowledge operator safety, channel B	57 58	Output, floating contact for operator safety acknowledgement (>>> "SIB outputs" Page 65)	

Signal "Peri enabled" (PE)

The signal "Peri enabled" is set to 1 (active) if the following conditions are met:

- Drives are switched on.
- Safety controller motion enable signal present.
- The message "Operator safety open" must not be active.
This message is only active in the modes T1 and T2.

"Peri enabled" in conjunction with the signal "Safe operational stop"

- In the case of activation of the signal "Safe operational stop" during the motion:
 - Error -> braking with Stop 0. "Peri enabled" eliminated.
- Activation of the signal "Safe operational stop" with the manipulator stationary:

Release the brakes, switch drives to servo-control and monitor for restart. "Peri enabled" remains active.

 - Signal "Motion enable" remains active.
 - US2 voltage (if present) remains active.
 - Signal "Peri enabled" remains active.

"Peri enabled" in conjunction with the signal "Safety stop 2"

- In the case of activation of the signal "Safety stop 2":
 - Stop 2 of the manipulator.
 - Signal "Drive enable" remains active.
 - Brakes remain released.
 - Manipulator remains under servo-control.
 - Monitoring for restart active.
 - Signal "Motion enable" is deactivated.
 - US2 voltage (if present) is deactivated.
 - Signal "Peri enabled" is deactivated.

6.6.2 Interface X11 – external enabling switch

Connector pin allocation

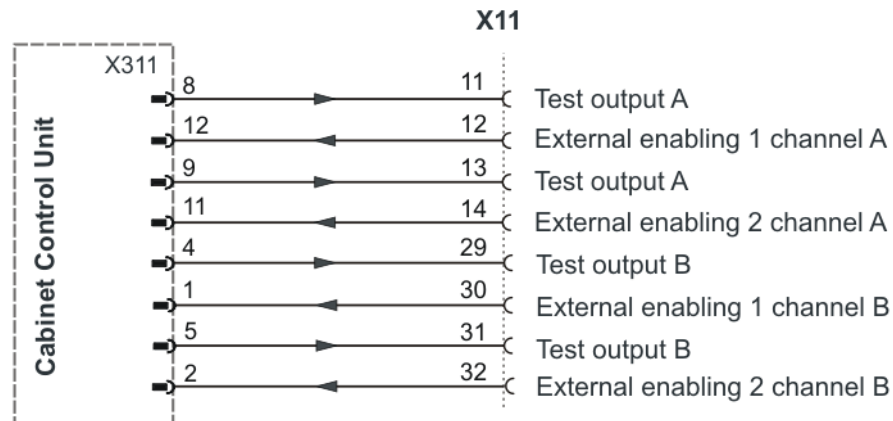

Fig. 6-8: Interface X11, connector pin allocation for external enabling switch

Signal	Pin	Description	Comments
CCU test output A (test signal)	11 13	Makes the pulsed voltage available for the individual interface inputs of channel A.	These signals may only be mapped with the CCU.
CCU test output B (test signal)	29 31	Makes the clocked voltage available for the individual interface inputs of channel B.	
External enabling 1 channel A	12	For connection of an external 2-channel enabling switch 1 with floating contacts.	If no external enabling switch 1 is connected, channel A pins 11/12 and channel B 29/30 must be jumpered. Only effective in TEST modes. (>>> "Function of external axis enabling switch" Page 107)
External enabling 1 channel B	30		
External enabling 2 channel A	14	For connection of an external 2-channel enabling switch 2 with floating contacts.	If no external enabling switch 2 is connected, channel A pins 13/14 and channel B 31/32 must be jumpered. Only effective in TEST modes. (>>> "Function of external axis enabling switch" Page 107)
External enabling 2 channel B	32		

Function of external axis enabling switch

- External enabling 1
Enabling switch must be pressed for jogging in T1 or T2. Input is closed.
- External enabling 2
Enabling switch is not in the panic position. Input is closed.
- If a smartPAD is connected, its enabling switches and the external enabling are ANDed.

Function (only active for T1 and T2)	External enabling 1	External enabling 2	Switch position
Safety stop 1 (drives switched off when axis at standstill)	Input open	Input open	No operational state
Safety stop 2 (safe operational stop, drives switched on)	Input open	Input closed	Not pressed

Function (only active for T1 and T2)	External enabling 1	External enabling 2	Switch position
Safety stop 1 (drives switched off when axis at standstill)	Input closed	Input open	Panic position
Axes enabled (axis jogging possible)	Input closed	Input closed	Center position

6.6.3 Contact diagram for connector X11

Contact diagram, connector X11

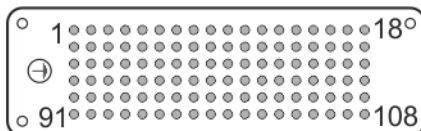



Fig. 6-9: Contact diagram

- X11, mating connector: Han 108DD with a male insert
- Housing size: 24B
- Cable gland M32
- Cable diameter 14-21 mm
- Cable cross-section $\geq 1 \text{ mm}^2$

 In the cabling for the input signals and test signals in the system, suitable measures must be taken to prevent a cross-connection between the voltages (e.g. separate cabling of input signals and test signals).

 In the cabling for the output signals and test signals in the system, suitable measures must be taken to prevent a cross-connection between the output signals of a channel (e.g. separate cabling).

6.6.4 Wiring example for E-STOP circuit and safeguard

Description The EMERGENCY STOP devices are connected to X11 in the robot controller.

EMERGENCY STOP

 **WARNING** The EMERGENCY STOP devices on the robot controller must be integrated into the EMERGENCY STOP circuit of the system by the system integrator. Failure to do this may result in death, severe injuries or considerable damage to property.

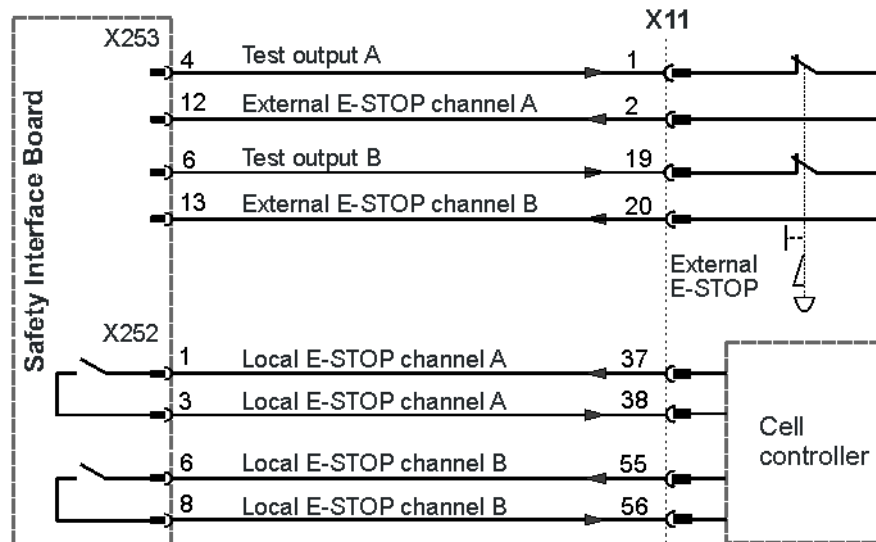

Fig. 6-10: Wiring example: EMERGENCY STOP

Safety gate

A dual-channel acknowledge button must be installed outside the physical safeguard. The closing of the safety gate must be confirmed by pressing the acknowledge button before the industrial robot can be started again in Automatic mode.

⚠ WARNING The safety gate on the robot controller must be integrated into the safeguard circuit of the system by the system integrator. Failure to do this may result in death, severe injuries or considerable damage to property.

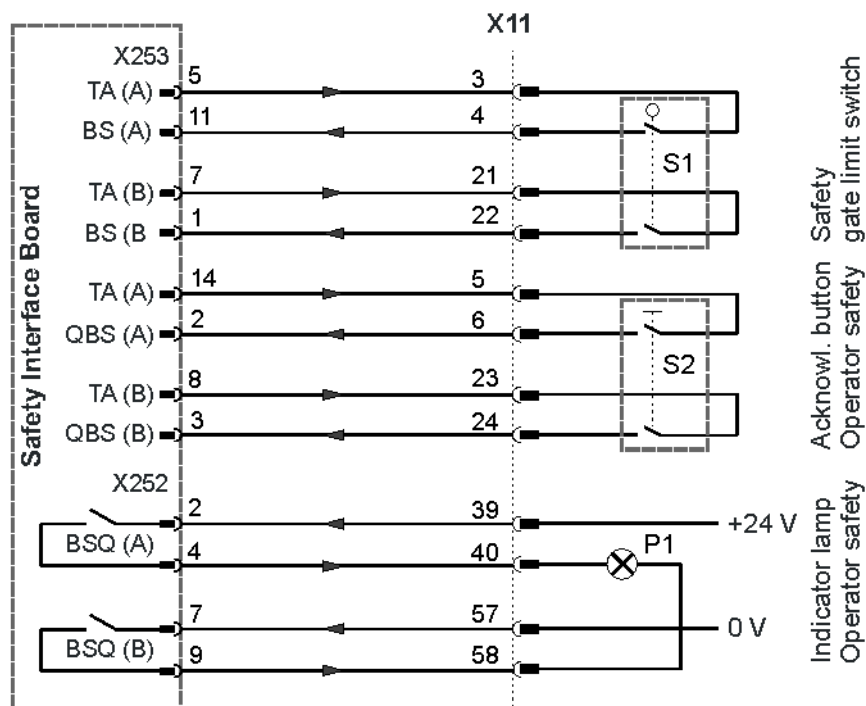

Fig. 6-11: Wiring example: Operator safety with safety gate

6.6.5 Wiring example for safe inputs and outputs

Safe input

The switch-off capability of the inputs is monitored cyclically.

The inputs of the SIB are of dual-channel design with external testing. The dual-channel operation of the inputs is monitored cyclically.

The following diagram illustrates the connection of a safe input to a floating contact provided by the customer.

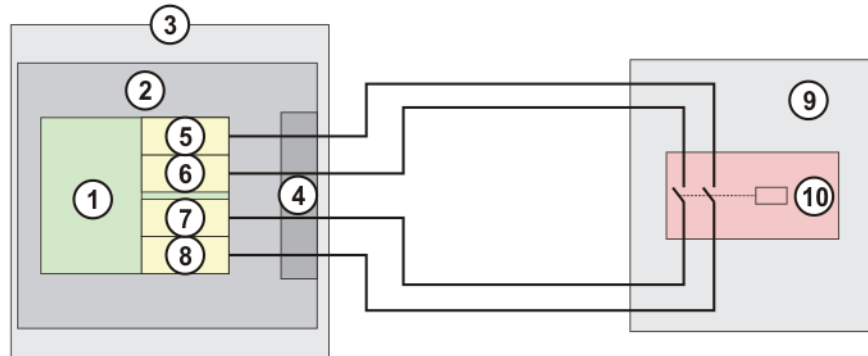

Fig. 6-12: Connection schematic for safe input

- 1 Safe input, SIB
- 2 SIB/CIB
- 3 Robot controller
- 4 Interface X11 (XD211) or X13 (XD213)
- 5 Test output channel B
- 6 Test output channel A
- 7 Input X, channel A
- 8 Input X, channel B
- 9 System side
- 10 Floating contact

Test outputs A and B are fed with the supply voltage of the SIB. Test outputs A and B are sustained short-circuit proof. The test outputs must only be used to supply the SIB inputs, and for no other purpose.

The wiring example described can be used to achieve compliance with Category 3 and Performance Level (PL) d according to EN ISO 13849-1.

Dynamic testing

- The switch-off capability of the inputs is tested cyclically. For this, the test outputs TA_A and TA_B are switched off alternately.
- The switch-off pulse length is defined for the SIBs as $t_1 = 625 \mu\text{s}$ (125 μs – 2.375 ms).
- The duration t_2 between two switch-off pulses on one channel is 106 ms.
- The input channel SIN_x_A must be supplied by the test signal TA_A. The input channel SIN_x_B must be supplied by the test signal TA_B. No other power supply is permissible.
- It is only permitted to connect sensors which allow the connection of test signals and which provide floating contacts.
- The signals TA_A and TA_B must not be significantly delayed by the switching element.

Switch-off pulse diagram

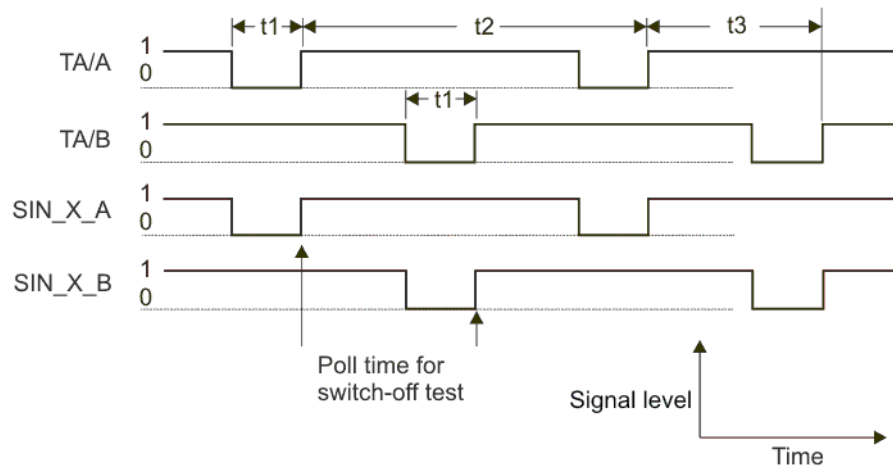

Fig. 6-13: Switch-off pulse diagram, test outputs

- t1 Switch-off pulse length (fixed or configurable)
- t2 Switch-off period per channel (106 ms)
- t3 Offset between switch-off pulses of both channels (53 ms)
- TA/A Test output channel A
- TA/B Test output channel B
- SIN_X_A Input X, channel A
- SIN_X_B Input X, channel B

Safe output

On the SIB, the outputs are provided as dual-channel floating relay outputs.

The following diagram illustrates the connection of a safe output to a safe input provided by the customer with external test facility. The input used by the customer must be monitored externally for cross-connection.

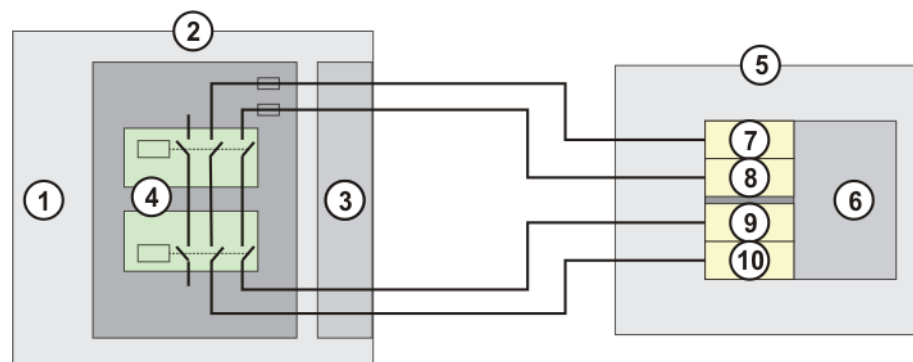

Fig. 6-14: Connection schematic for safe output

- 1 SIB
- 2 Robot controller
- 3 Interface X11 (XD211) or X13 (XD213)
- 4 Output wiring
- 5 System side
- 6 Safe input (Fail Safe PLC, safety switching device)
- 7 Test output channel B
- 8 Test output channel A
- 9 Input X, channel A
- 10 Input X, channel B

The wiring example described can be used to achieve compliance with Category 3 and Performance Level (PL) d according to EN ISO 13849-1.

6.7 Safety functions via Ethernet safety interface (optional)

Description

The exchange of safety-relevant signals between the controller and the system is carried out via the Ethernet safety interface (e.g. PROFIsafe or CIP Safety). The assignment of the input and output states within the Ethernet safety interface protocol are listed below. In addition, non-safety-oriented information from the safety controller is sent to the non-safe section of the higher-level controller for the purpose of diagnosis and control.

Reserved bits

Reserved safe inputs can be pre-assigned by a PLC with the values **0** or **1**. In both cases, the manipulator will move. If a safety function is assigned to a reserved input (e.g. in the case of a software update) and if this input is preset with the value **0**, then the manipulator would either not move or would unexpectedly come to a standstill.



KUKA recommends pre-assignment of the reserved inputs with **1**. If a reserved input has a new safety function assigned to it, and the input is not used by the customer's PLC, the safety function is not activated. This prevents the safety controller from unexpectedly stopping the manipulator.

Input byte 0

Bit	Signal	Description
0	RES	Reserved 1 The value 1 must be assigned to the input.
1	NHE	Input for external Emergency Stop 0 = external E-STOP is active 1 = external E-STOP is not active
2	BS	Operator safety 0 = operator safety is not active, e.g. safety gate open 1 = operator safety is active
3	QBS	Acknowledgement of operator safety Precondition for acknowledgement of operator safety is the signal "Operator safety assured" set in the BS bit. Note: If the "BS" signal is acknowledged by the system, this must be specified under Hardware options in the safety configuration. Information is contained in the Operating and Programming Instructions for System Integrators. 0 = operator safety has not been acknowledged Edge 0 ->1 = operator safety has been acknowledged

Bit	Signal	Description
4	SHS1	<p>Safety STOP 1 (all axes)</p> <ul style="list-style-type: none"> ■ FF (motion enable) is set to 0. ■ Voltage US2 is switched off. ■ AF (drives enable) is set to 0 after 1.5 s. <p>Cancelation of this function does not require acknowledgement.</p> <p>This function is not permissible for the EMERGENCY STOP function.</p> <p>0 = safety stop is active 1 = safety stop is not active</p>
5	SHS2	<p>Safety STOP 2 (all axes)</p> <ul style="list-style-type: none"> ■ FF (motion enable) is set to 0. ■ Voltage US2 is switched off. <p>Cancelation of this function does not require acknowledgement.</p> <p>This function is not permissible for the EMERGENCY STOP function.</p> <p>0 = safety stop is active 1 = safety stop is not active</p>
6	RES	-
7	RES	-

Input byte 1

Bit	Signal	Description
0	US2	<p>Supply voltage US2 (signal for switching the second supply voltage, US2, without battery backup)</p> <p>If this output is not used, it should be set to 0.</p> <p>0 = switch off US2 1 = switch on US2</p> <p>Note: Whether and how input US2 is used must be specified under Hardware options in the safety configuration. Information is contained in the Operating and Programming Instructions for System Integrators.</p>
1	SBH	<p>Safe operational stop (all axes)</p> <p>Precondition: All axes are stationary</p> <p>Cancelation of this function does not require acknowledgement.</p> <p>This function is not permissible for the EMERGENCY STOP function.</p> <p>0 = safe operational stop is active. 1 = safe operational stop is not active.</p>
2	RES	<p>Reserved 11</p> <p>The value 1 must be assigned to the input.</p>
3	RES	<p>Reserved 12</p> <p>The value 1 must be assigned to the input.</p>

Bit	Signal	Description
4	RES	Reserved 13 The value 1 must be assigned to the input.
5	RES	Reserved 14 The value 1 must be assigned to the input.
6	RES	Reserved 15 The value 1 must be assigned to the input.
7	SPA	System Powerdown Acknowledge The system confirms that it has received the power-down signal. A second after the "SP" (System Powerdown) signal has been set by the controller, the requested action is executed, without the need for confirmation from the PLC, and the controller shuts down. 0 = confirmation is not active 1 = confirmation is active

Output byte 0

Bit	Signal	Description
0	NHL	Local E-STOP (local E-STOP triggered) 0 = local E-STOP is active 1 = local E-STOP is not active
1	AF	Drives enable (the internal safety controller in the KRC has enabled the drives so that they can be switched on) 0 = drives enable is not active (the robot controller must switch the drives off) 1 = drives enable is active (the robot controller must switch the drives to servo-control)
2	FF	Motion enable (the internal safety controller in the KRC has enabled robot motions) 0 = motion enable is not active (the robot controller must stop the current motion) 1 = motion enable is active (the robot controller may trigger a motion)
3	ZS	One of the enabling switches is in the center position (enabling in test mode) 0 = enabling is not active 1 = enabling is active
4	PE	The signal "Peri enabled" is set to 1 (active) if the following conditions are met: <ul style="list-style-type: none"> ■ Drives are switched on. ■ Safety controller motion enable signal present. ■ The message "Operator safety open" must not be active. (>>> "Signal "Peri enabled" (PE)" Page 106)
5	AUT	The manipulator is in AUT or AUT EXT mode. 0 = AUT or AUT EXT mode is not active 1 = AUT or AUT EXT mode is active

Bit	Signal	Description
6	T1	The manipulator is in Manual Reduced Velocity mode. 0 = T1 mode is not active 1 = T1 mode is active
7	T2	The manipulator is in Manual High Velocity mode. 0 = T2 mode is not active 1 = T2 mode is active

Output byte 1

Bit	Signal	Description
0	NHE	External E-STOP has been triggered. 0 = external E-STOP is active 1 = external E-STOP is not active
1	BS	Operator safety 0 = operator safety is not assured 1 = operator safety is assured (input BS = 1 and, if configured, input QBS acknowledged)
2	SHS1	Safety stop 1 (all axes) 0 = Safety stop 1 is not active 1 = Safety stop 1 is active (safe state reached)
3	SHS2	Safety stop 2 (all axes) 0 = Safety stop 2 is not active 1 = Safety stop 2 is active (safe state reached)
4	RES	Reserved 13
5	RES	Reserved 14
6	PSA	Safety interface active Precondition: An Ethernet interface must be installed on the controller, e.g. PROFINET or Ethernet/IP 0 = safety interface is not active 1 = safety interface is active
7	SP	System Powerdown (controller will be shut down) One second after the SP signal has been set, the PSA output is reset by the robot controller, without confirmation from the PLC, and the controller is shut down. 0 = controller on safety interface is active. 1 = controller will be shut down

6.7.1 Schematic circuit diagram for enabling switches**Description**

An external enabling switch can be connected to the higher-level safety controller. The signals (ZSE make contact and External panic break contact) must be correctly linked to the Ethernet safety interface signals in the safety controller. The resulting Ethernet safety interface signals must then be routed to the PROFIsafe of the KR C4. The response to the external enabling switch is then identical to that for a discretely connected X11.

Signals

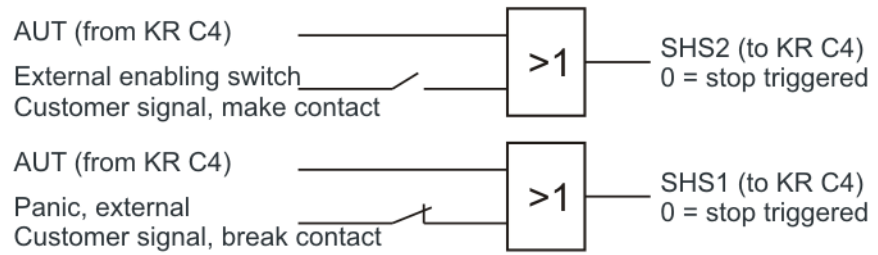

Fig. 6-15: Schematic circuit diagram of external enabling switch

- Enabling switch center position (make contact closed (1) = enabled) OR AUT at SHS2
- Panic (break contact open (0) = panic position) = AND not AUT at SHS1

6.7.2 SafeOperation via Ethernet safety interface (optional)

Description

The components of the industrial robot move within the limits that have been configured and activated. The actual positions are continuously calculated and monitored against the safety parameters that have been set. The safety controller monitors the industrial robot by means of the safety parameters that have been set. If a component of the industrial robot violates a monitoring limit or a safety parameter, the manipulator and external axes (optional) are stopped. The Ethernet safety interface can be used, for example, to signal a violation of safety monitoring functions.

In the case of the KR C4 compact robot controller, safety options such as SafeOperation are only available via the Ethernet safety interface from KSS/ VSS 8.3 onwards.

Reserved bits

Reserved safe inputs can be pre-assigned by a PLC with the values **0** or **1**. In both cases, the manipulator will move. If a safety function is assigned to a reserved input (e.g. in the case of a software update) and if this input is preset with the value **0**, then the manipulator would either not move or would unexpectedly come to a standstill.

i KUKA recommends pre-assignment of the reserved inputs with **1**. If a reserved input has a new safety function assigned to it, and the input is not used by the customer's PLC, the safety function is not activated. This prevents the safety controller from unexpectedly stopping the manipulator.

Input byte 2

Bit	Signal	Description
0	JR	Mastering test (input for the reference switch of the mastering test) 0 = reference switch is active (actuated). 1 = reference switch is not active (not actuated).

Bit	Signal	Description
1	VRED	Reduced axis-specific and Cartesian velocity (activation of reduced velocity monitoring) 0 = reduced velocity monitoring is active. 1 = reduced velocity monitoring is not active.
2 ... 7	SBH1 ... 6	Safe operational stop for axis group 1 ... 6 Assignment: Bit 2 = axis group 1 ... bit 7 = axis group 6 Signal for safe operational stop. The function does not trigger a stop, it only activates the safe standstill monitoring. Cancellation of this function does not require acknowledgement. 0 = safe operational stop is active. 1 = safe operational stop is not active.

Input byte 3

Bit	Signal	Description
0 ... 7	RES	Reserved 25 ... 32 The value 1 must be assigned to the inputs.

Input byte 4

Bit	Signal	Description
0 ... 7	UER1 ... 8	Monitoring spaces 1 ... 8 Assignment: Bit 0 = monitoring space 1 ... bit 7 = monitoring space 8 0 = monitoring space is active. 1 = monitoring space is not active.

Input byte 5

Bit	Signal	Description
0 ... 7	UER9 ... 16	Monitoring spaces 9 ... 16 Assignment: Bit 0 = monitoring space 9 ... bit 7 = monitoring space 16 0 = monitoring space is active. 1 = monitoring space is not active.

Input byte 6

Bit	Signal	Description
0 ... 7	WZ1 ... 8	Tool selection 1 ... 8 Assignment: Bit 0 = tool 1 ... bit 7 = tool 8 0 = tool is not active. 1 = tool is active. Exactly one tool must be selected at all times.

Input byte 7

Bit	Signal	Description
0 ... 7	WZ9 ... 16	Tool selection 9 ... 16 Assignment: Bit 0 = tool 9 ... bit 7 = tool 16 0 = tool is not active. 1 = tool is active. Exactly one tool must be selected at all times.

Output byte 2

Bit	Signal	Description
0	SO	Safety option active Activation status of the safety option 0 = safety option is not active 1 = safety option is active
1	RR	Manipulator referenced Mastering test display 0 = mastering test required. 1 = mastering test performed successfully.
2	JF	Mastering error Space monitoring is deactivated because at least one axis is not mastered. 0 = mastering error. Space monitoring has been deactivated. 1 = no error.
3	VRED	Reduced axis-specific and Cartesian velocity (activation status of reduced velocity monitoring) 0 = reduced velocity monitoring is not active. 1 = reduced velocity monitoring is active.
4 ... 7	SBH1 ... 4	Activation status of safe operational stop for axis group 1 ... 4 Assignment: Bit 4 = axis group 1 ... bit 7 = axis group 4 0 = safe operational stop is not active. 1 = safe operational stop is active.

Output byte 3

Bit	Signal	Description
0 ... 1	SBH5 ... 6	Activation status of safe operational stop for axis group 5 ... 6 Assignment: Bit 0 = axis group 5 ... bit 1 = axis group 6 0 = safe operational stop is not active. 1 = safe operational stop is active.
2 ... 7	RES	Reserved 27 ... 32

Output byte 4

Bit	Signal	Description
0 ... 7	MR1 ... 8	<p>Alarm space 1 ... 8</p> <p>Assignment: Bit 0 = alarm space 1 (associated monitoring space 1) ... bit 7 = alarm space 8 (associated monitoring space 8)</p> <p>0 = monitoring space is violated.</p> <p>1 = monitoring space is not violated.</p> <p>Note: An inactive monitoring space is considered to be violated by default, i.e. in this case the associated safe output MRx has the state "0".</p>

Output byte 5

Bit	Signal	Description
0 ... 7	MR9 ... 16	<p>Alarm space 9 ... 16</p> <p>Assignment: Bit 0 = alarm space 9 (associated monitoring space 9) ... bit 7 = alarm space 16 (associated monitoring space 16)</p> <p>0 = monitoring space is violated.</p> <p>1 = monitoring space is not violated.</p> <p>Note: An inactive monitoring space is considered to be violated by default, i.e. in this case the associated safe output MRx has the state "0".</p>

Output byte 6

Bit	Signal	Description
0 ... 7	RES	Reserved 49 ... 56

Output byte 7

Bit	Signal	Description
0 ... 7	RES	Reserved 57 ... 64

6.7.3 Ethernet interface (1xRJ45) X66

Description

Connector X66 on the connection panel is intended for connecting an external computer for the purpose of installation, programming, debugging and diagnosis.

Connector pin allocation



Fig. 6-16: Connector pin allocation X66

- Recommended connecting cable: Ethernet-compatible, min. category CAT 5
- Maximum cable cross-section: AWG22

6.8 EtherCAT connection on the CIB

Description

Connector X44 on the CIB is the interface for connection of EtherCAT slaves inside the robot controller (on the mounting plate for customer components). The EtherCAT line remains in the robot controller. The EtherCAT line can be routed out of the robot controller via the optional connector X65. Information about connector X65 can be found in the assembly and operating instructions of the optional KR C4 interfaces.

 The EtherCAT devices must be configured with WorkVisual.

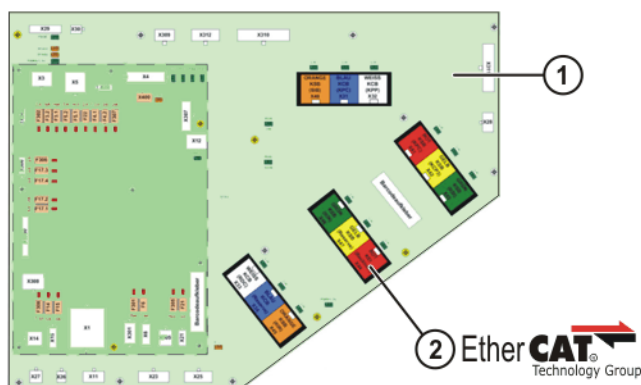

Fig. 6-17: EtherCAT connection X44

- 1 CIB
- 2 EtherCAT connection X44

6.9 PE equipotential bonding

Description

The following cables must be connected before start-up:

- A 16 mm² cable as equipotential bonding between the manipulator/robot kinematic system and the robot controller.
- An additional PE conductor between the central PE rail of the supply cabinet and the PE bolt of the robot controller. A cross section of 16 mm² is recommended.

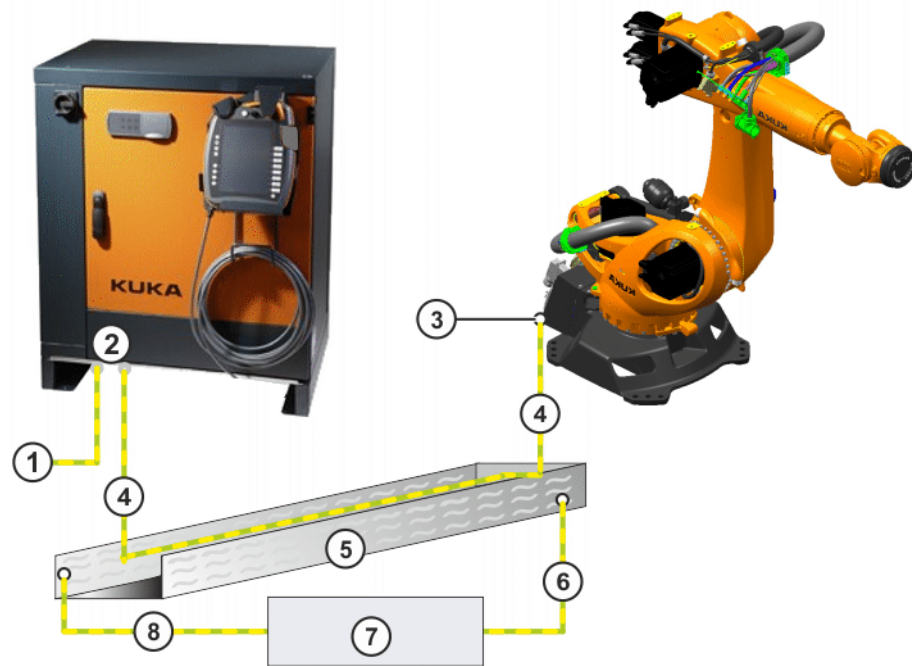

Fig. 6-18: Equipotential bonding from robot controller to manipulator via cable duct

- 1 PE to central PE rail of the supply cabinet
- 2 Connection panel on robot controller
- 3 Equipotential bonding connection on the manipulator
- 4 Equipotential bonding from the robot controller to the manipulator
- 5 Cable duct
- 6 Equipotential bonding from the start of the cable duct to the main equipotential bonding
- 7 Main equipotential bonding
- 8 Equipotential bonding from the end of the cable duct to the main equipotential bonding

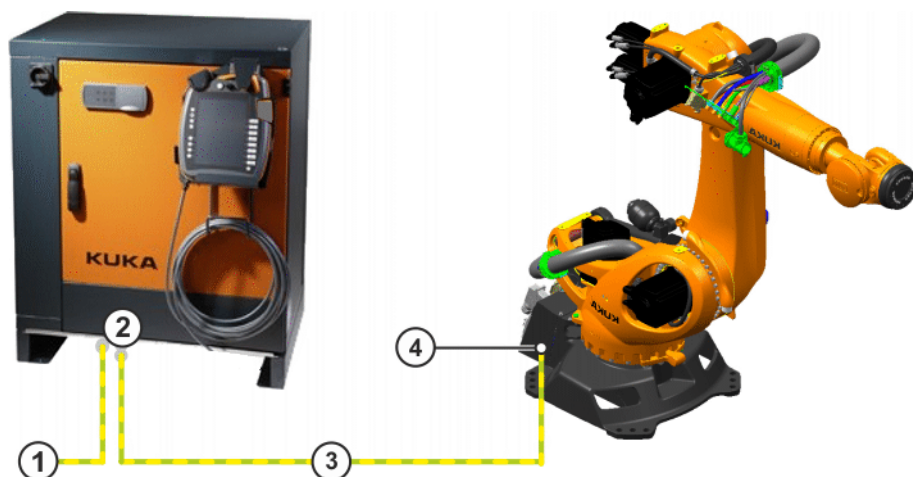

Fig. 6-19: Equipotential bonding, robot controller - manipulator

- 1 PE to central PE rail of the supply cabinet
- 2 Connection panel on robot controller
- 3 Equipotential bonding from the robot controller to the manipulator
- 4 Equipotential bonding connection on the manipulator

6.10 Modifying the system configuration, exchanging devices

Description

The system configuration of the industrial robot must be configured using WorkVisual in the following cases:

- Installation of KSS/VSS 8.2 or higher
This is the case if KSS/VSS 8.2 or higher is installed without KSS/VSS 8.2 or higher already being present (because it has been uninstalled or deleted or has never been installed).
- The hard drive has been exchanged.
- A device has been replaced by a device of a different type.
- More than one device has been replaced by a device of a different type.
- One or more devices have been removed.
- One or more devices have been added.

Exchanging devices

If a device is exchanged, at least one KCB, KSB or KEB device is replaced by a device of the same type. Any number of KCB, KSB and KEB devices can be exchanged until all devices in the KCB, KSB and KEB have been replaced simultaneously by devices of the same type. Simultaneous exchange of two identical components of the KCB is not possible. Only one of the identical components may be exchanged at any one time.



The interchanging of 2 identical devices can only occur in the case of the KSP3x40 if the current system configuration contains 2 KSP3x40.

6.11 Operator safety acknowledgement

A dual-channel acknowledge button must be installed outside the physical safeguard. The closing of the safety gate must be confirmed by pressing the acknowledge button before the industrial robot can be started again in Automatic mode.

6.12 Performance level

The safety functions of the robot controller conform to category 3 and Performance Level d according to EN ISO 13849-1.

6.12.1 PFH values of the safety functions

The safety values are based on a service life of 20 years.

The PFH value classification of the controller is only valid if the E-STOP device is tested at least once every 6 months.

When evaluating system safety functions, it must be remembered that the PFH values for a combination of multiple controllers may have to be taken into consideration more than once. This is the case for RoboTeam systems or higher-level hazard areas. The PFH value determined for the safety function at system level must not exceed the limit for PL d.

The PFH values relate to the specific safety functions of the different controller variants.

Safety function groups:

- Standard safety functions
 - Operating mode selection
 - Operator safety

- EMERGENCY STOP device
- Enabling device
- External safe operational stop
- External safety stop 1
- External safety stop 2
- Velocity monitoring in T1
- Control of the peripheral contactor
- Safety functions of KUKA.SafeOperation (option)
 - Monitoring of axis spaces
 - Monitoring of Cartesian spaces
 - Monitoring of axis velocity
 - Monitoring of Cartesian velocity
 - Monitoring of axis acceleration
 - Safe operational stop
 - Tool monitoring

Overview of controller variant PFH values:

Robot controller variant	PFH value
KR C4; KR C4 CK	$< 1 \times 10^{-7}$
KR C4 midsize; KR C4 midsize CK	$< 1 \times 10^{-7}$
KR C4 extended; KR C4 extended CK	$< 1 \times 10^{-7}$
KR C4 NA; KR C4 CK NA	$< 1 \times 10^{-7}$
KR C4 NA variant: TTE1	$< 1 \times 10^{-7}$
KR C4 NA extended; KR C4 CK NA extended	$< 1 \times 10^{-7}$
KR C4 variant: TBM1	$< 1 \times 10^{-7}$
KR C4 variants: TDA1; TDA2; TDA3; TDA4	$< 1 \times 10^{-7}$
KR C4 variants: TFO1; TFO2	$< 2 \times 10^{-7}$
KR C4 variants: TRE1; TRE2	$< 1.5 \times 10^{-7}$
KR C4 variant: TRE3	$< 1 \times 10^{-7}$
KR C4 variants: TVO1; TVO2; TVO3	$< 1 \times 10^{-7}$
VKR C4 variants: TVW1; TVW2; TVW3; TVW4	$< 1 \times 10^{-7}$
VKR C4 Retrofit	
<ul style="list-style-type: none"> ■ Without external EMERGENCY STOP and operator safety functions ■ External EMERGENCY STOP and operator safety functions 	$< 1 \times 10^{-7}$ 5×10^{-7}
KR C4 panel mounted	$< 1 \times 10^{-7}$



For controller variants that are not listed here, please contact KUKA Roboter GmbH.

7 Transportation

7.1 Transportation using lifting tackle

- Precondition**
- The robot controller must be switched off.
 - No cables may be connected to the robot controller.
 - The door of the robot controller must be closed.
 - The robot controller must be upright.
 - The anti-toppling bracket must be fastened to the robot controller.
- Necessary equipment**
- Lifting tackle
 - 4 eyebolts
- Recommendation:
M10 eyebolts acc. to DIN 580 with the following properties:
- Screw thread: M10
 - Material: C15E
 - Inside/outside diameter: 25 mm/45 mm
 - Thread length: 17 mm
 - Pitch: 1.5 mm
 - Load-bearing capacity: 230 kg
- Procedure**
1. Screw the eyebolts into the robot controller. The eyebolts must be fully screwed in and flush with the mounting surface.
 2. Attach the lifting tackle with or without a lifting frame to all 4 eyebolts on the robot controller.

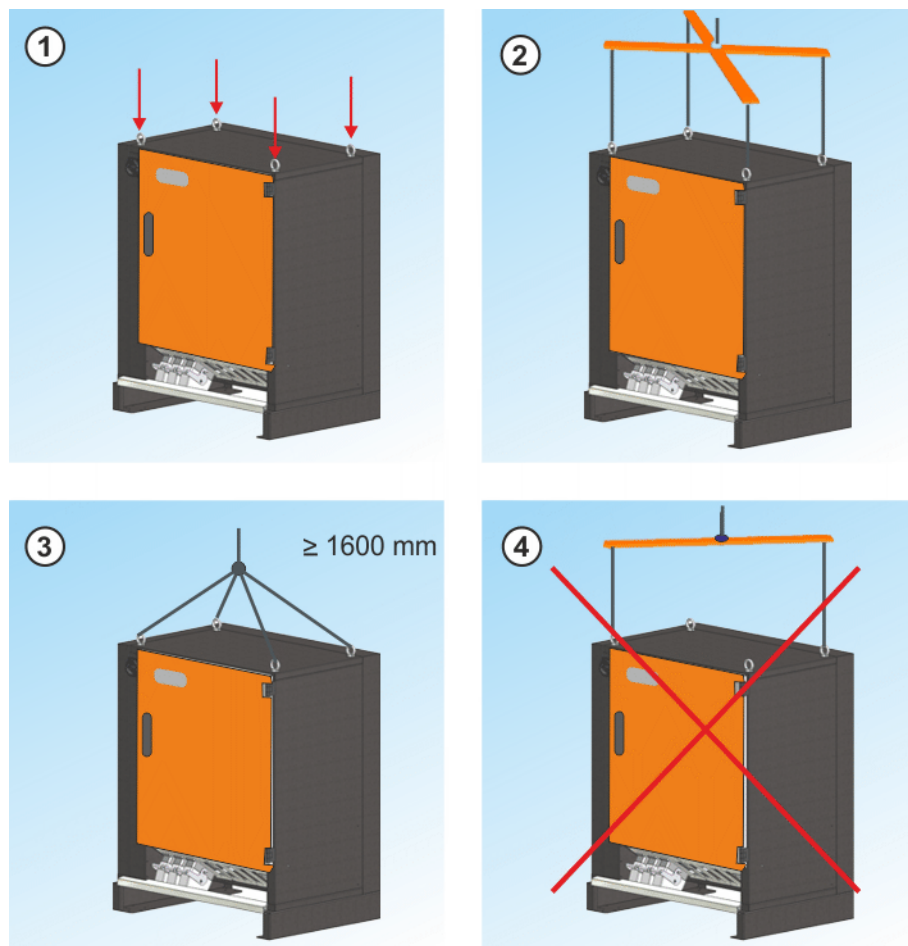

Fig. 7-1: Transportation using lifting tackle

- 1 Eyebolts on the robot controller
- 2 Correctly attached lifting tackle
- 3 Correctly attached lifting tackle
- 4 Incorrectly attached lifting tackle

3. Attach the lifting tackle to the crane.

WARNING If the suspended robot controller is transported too quickly, it may swing and cause injury or damage. Transport the robot controller slowly.

4. Slowly lift and transport the robot controller.
5. Slowly lower the robot controller at its destination.
6. Unhook lifting tackle on the robot controller.

7.2 Transportation by fork lift truck

Precondition

- The robot controller must be switched off.
- No cables may be connected to the robot controller.
- The door of the robot controller must be closed.
- The robot controller must be upright.
- The anti-toppling bracket must be fastened to the robot controller.

WARNING Use of unsuitable handling equipment may result in damage to the robot controller or injury to persons. Only use authorized handling equipment with a sufficient load-bearing capacity. Only transport the robot controller in the manner specified here.

Transportation with standard cabinet base

The robot controller can be picked up using a fork lift truck. The robot controller must not be damaged when inserting the forks beneath the robot controller. After insertion, the forks of the fork lift truck must be opened until they are in contact with the cabinet bases.



Fig. 7-2: Transportation with standard cabinet base

- 1 Standard cabinet base
- 2 Anti-toppling bracket

Transportation using fork slots

The robot controller can be picked up by fork lift truck using two fork slots (option).

NOTICE Avoid excessive loading of the fork slots through undue inward or outward movement of hydraulically adjustable forks of the fork lift truck. Failure to do so may result in material damage.



Fig. 7-3: Transportation with fork slots

- 1 Fork slots

Transportation with transformer

The robot controller with transformer (option) can be picked up by fork lift truck using two fork slots.

NOTICE Avoid excessive loading of the fork slots through undue inward or outward movement of hydraulically adjustable forks of the fork lift truck. Failure to do so may result in material damage.



Fig. 7-4: Transportation with transformer

- 1 Fork slots
- 2 Transformer

Transportation with the set of rollers

The robot controller with the set of rollers (option) can be picked up by fork lift truck. For this, the forks of the fork lift truck must be inserted between the anti-toppling bracket and the cross-strut of the roller set.



Fig. 7-5: Transportation with the set of rollers

- 1 Anti-toppling bracket
- 2 Cross-strut of the roller set

7.3 Transportation by pallet truck

Precondition

- The robot controller must be switched off.
- No cables may be connected to the robot controller.
- The door of the robot controller must be closed.
- The robot controller must be upright.
- The anti-toppling bracket must be fastened to the robot controller.

Transportation by pallet truck



Fig. 7-6: Transportation by pallet truck

1 Anti-toppling bracket

7.4 Transportation with the set of rollers (optional)

Description

The robot controller rollers may only be used to roll the cabinet into and out of a row of cabinets – not to transport the cabinet over longer distances. The floor must be level and free from obstacles, as there is a permanent risk of toppling.

NOTICE

If the robot controller is towed by a vehicle (fork lift truck, electrical vehicle), this can result in damage to the rollers and to the robot controller. The robot controller must not be hitched to a vehicle and transported using its rollers.

8 Start-up and recommissioning

8.1 Start-up overview

i This is an overview of the most important steps during start-up. The precise sequence depends on the application, the manipulator type, the technology packages used and other customer-specific circumstances. For this reason, the overview does not claim to be comprehensive.

i This overview refers to the start-up of the industrial robot. The start-up of the overall system is not within the scope of this documentation.

Manipulator

Step	Description	Information
1	Carry out a visual inspection of the manipulator.	Detailed information is contained in the operating or assembly instructions for the manipulator, in the chapter "Start-up and recommissioning".
2	Install the manipulator mounting base (mounting base, machine frame mounting or booster frame).	
3	Install the manipulator.	

Electrical system

Step	Description	Information
4	Carry out a visual inspection of the robot controller.	-
5	Make sure that no condensation has formed in the robot controller.	-
6	Install the robot controller.	(>>> 8.2 "Installing the robot controller" Page 132)
7	Connect the connecting cables.	(>>> 8.3 "Connecting the connecting cables" Page 133)
8	Plug in the KUKA smartPAD.	(>>> 8.5 "Plugging in the KUKA smartPAD" Page 134)
9	Connect the equipotential bonding between the manipulator and the robot controller.	(>>> 8.6 "Connecting the PE equipotential bonding" Page 135)
10	Connect the robot controller to the power supply.	(>>> 8.7 "Connecting the robot controller to the power supply" Page 135)
11	Reverse the battery discharge protection measures.	(>>> 8.8 "Reversing the battery discharge protection measures" Page 136)
12	Configure and connect safety interface X11.	(>>> 8.9 "Configuring and connecting safety interface X11" Page 136)
13	Configure Ethernet safety interface X66.	(>>> 6.7 "Safety functions via Ethernet safety interface (optional)" Page 112)
14	Drive configuration modified.	(>>> 8.10 "Modifying the system configuration, exchanging devices" Page 137)

Step	Description	Information
15	Start-up mode	(>>> 8.11 "Start-up mode" Page 137)
16	Switch on the robot controller.	(>>> 8.12 "Switching on the robot controller" Page 138)
17	Check the safety equipment.	Detailed information is contained in the operating and assembly instructions for the robot controller, in the "Safety" chapter.
18	Configure the inputs/outputs between the robot controller and the periphery.	Detailed information can be found in the field bus documentation.

Software

Step	Description	Information
19	Check machine data	Detailed information is contained in the operating and programming instructions
20	Master the manipulator without a load.	
21	Mount the tool and master the manipulator with a load.	
22	Check the software limit switches and adapt them if required.	
23	Calibrate the tool. In the case of a fixed tool: calibrate external TCP.	
24	Enter the load data.	
25	Calibrate the base (optional). In the case of a fixed tool: calibrate workpiece (optional).	
26	If the manipulator is to be controlled by a host computer or PLC: configure Automatic External interface.	Detailed information is contained in the Operating and Programming Instructions for System Integrators.

i Long text names of inputs/outputs, flags, etc., can be saved in a text file and imported after a reinstallation. In this way, the long texts do not need to be re-entered manually for each manipulator. Furthermore, the long text names can be updated in application programs.

Accessories

Precondition: the manipulator is ready to move, i.e. the software start-up has been carried out up to and including the item "Master the manipulator without load".

Description	Information
Optional: install and adjust external energy supply system, taking the programming into consideration.	Detailed information can be found in the energy supply system documentation.
Positionally accurate manipulator option: check data.	

8.2 Installing the robot controller

Procedure

1. Install the robot controller. The minimum clearances to walls, other cabinets, etc. must be observed. (>>> 6.2 "Installation conditions" Page 97)
2. Check the robot controller for any damage caused during transportation.

3. Check that fuses, contactors and boards are fitted securely.
4. Secure any modules that have come loose.
5. Check that all screwed and clamped connections are securely fastened.
6. The operator must cover the warning label **Read manual** with the label in the relevant local language. (>>> 4.9 "Plates and labels" Page 69)

8.3 Connecting the connecting cables

Overview

- A connecting cable set is supplied with the industrial robot. In the standard version this consists of:
 - Motor cables to the manipulator
 - Data cables to the manipulator
- The following cables may be provided for additional applications:
 - Motor cables for external axes
 - Peripheral cables



The robot controller is preconfigured for the specific industrial robot. If cables are interchanged, the manipulator and the external axes (optional) may receive incorrect data and can thus cause personal injury or material damage. If a system consists of more than one manipulator, always connect the connecting cables to the manipulators and their corresponding robot controllers.

Bending radius

The following bending radii must be observed:

- Fixed installation: 3 ... 5 x cable diameter.
- Installation in cable carrier: 7 ... 10 x cable diameter (cable must be specified for this).

Procedure

1. Route and connect the motor cables to the manipulator junction box separately from the data cables.
2. Route and connect the motor cables of the external axes.
3. Route the data cables to the manipulator junction box separately from the motor cable. Plug in connector X21.
4. Connect the peripheral cables.

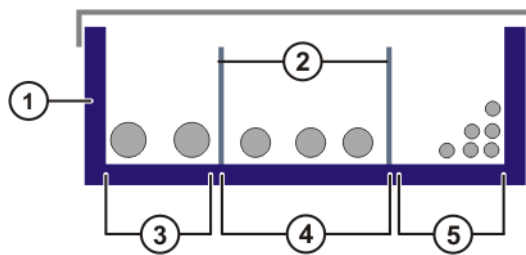

Fig. 8-1: Example: Installing the cables in the cable duct

- | | |
|-------------------|----------------|
| 1 Cable duct | 4 Motor cables |
| 2 Separating webs | 5 Data cables |
| 3 Welding cables | |

8.3.1 Data cables, X21

Connector pin allocation

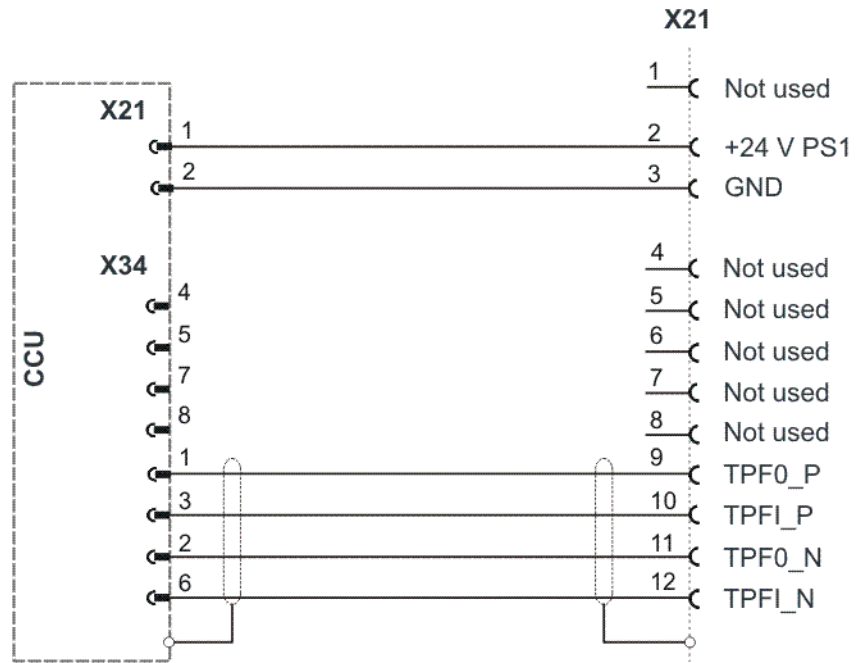

Fig. 8-2: Connector pin allocation for X21

8.4 Fastening the KUKA smartPAD holder (optional)

Procedure

- Fasten the smartPAD holder on the door of the robot controller or on the wall. (>>> 6.4 "Fastening the KUKA smartPAD holder (optional)" Page 101)

8.5 Plugging in the KUKA smartPAD

Procedure

- Plug the KUKA smartPAD to X19 on the robot controller.

WARNING If the smartPAD is disconnected, the system can no longer be switched off by means of the EMERGENCY STOP device on the smartPAD. For this reason, an external EMERGENCY STOP must be connected to the robot controller. The user is responsible for ensuring that the smartPAD is immediately removed from the system when it has been disconnected. The smartPAD must be stored out of sight and reach of personnel working on the industrial robot. This prevents operational and non-operational EMERGENCY STOP devices from becoming interchanged. Failure to observe these precautions may result in death, injuries or damage to property.

Connector pin allocation X19

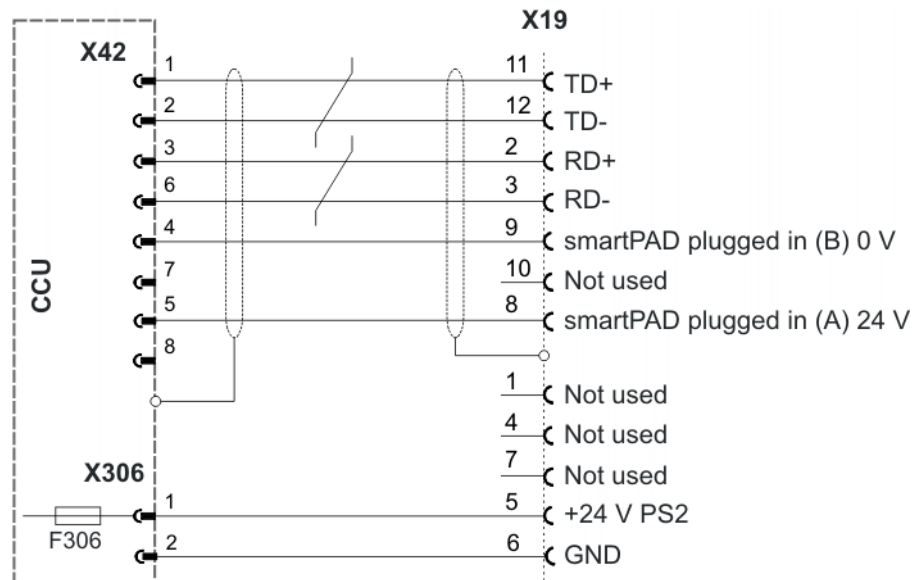

Fig. 8-3: Connector pin allocation X19

8.6 Connecting the PE equipotential bonding

Procedure

1. Connect an additional PE conductor between the central PE rail of the supply cabinet and the PE bolt of the robot controller.
2. Connect a 16 mm² cable as equipotential bonding between the manipulator and the robot controller.
3. Carry out a ground conductor check for the entire industrial robot in accordance with DIN EN 60204-1.

8.7 Connecting the robot controller to the power supply

Description

The robot controller is connected to the mains via a Harting connector X1.

⚠ CAUTION If the robot controller is connected to a power system **without** a grounded neutral, this may cause malfunctions in the robot controller and material damage to the power supply units. Electrical voltage can cause injuries. The robot controller may only be operated with grounded-neutral power supply systems.

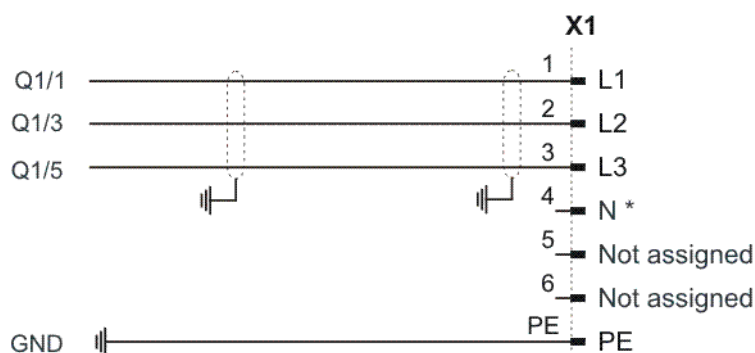

Fig. 8-4: Connector pin allocation X1

N* Option for service socket

Precondition

- Robot controller is switched off.

- The power cable is de-energized.

Procedure

- Connect the robot controller to the power supply via X1.

8.8 Reversing the battery discharge protection measures**Description**

To prevent the batteries from discharging before the controller has been started up for the first time, the robot controller is supplied with connector X305 disconnected from the CCU.

Procedure

- Plug connector X305 into the CCU.

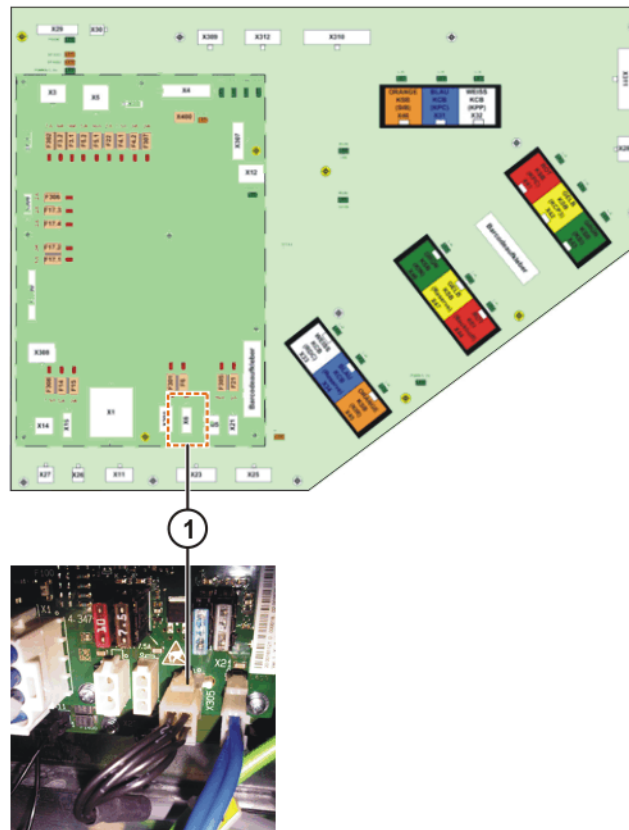

Fig. 8-5: Battery discharge protection X305

- 1 Connector X305 on the CCU

8.9 Configuring and connecting safety interface X11**Precondition**

- The robot controller is switched off.

Procedure

1. Configure connector X11 in accordance with the system and safety concepts. (>>> 6.6 "Description of safety interface X11" Page 103)
2. Connect interface connector X11 to the robot controller.

NOTICE

Connector X11 may only be plugged in or unplugged when the robot controller is switched off. If connector X11 is plugged in or unplugged when energized, damage to property may occur.

8.10 Modifying the system configuration, exchanging devices

- Description** The system configuration of the industrial robot must be configured using WorkVisual in the following cases:
- Installation of KSS/VSS 8.2 or higher

This is the case if KSS/VSS 8.2 or higher is installed without KSS/VSS 8.2 or higher already being present (because it has been uninstalled or deleted or has never been installed).
 - The hard drive has been exchanged.
 - A device has been replaced by a device of a different type.
 - More than one device has been replaced by a device of a different type.
 - One or more devices have been removed.
 - One or more devices have been added.

8.11 Start-up mode

Description The industrial robot can be set to Start-up mode via the smartHMI user interface. In this mode, the manipulator can be moved in T1 without the external safeguards being put into operation.

When Start-up mode is possible depends on the safety interface that is used.

Discrete safety interface

- System Software 8.2 or earlier:

Start-up mode is always possible if all input signals at the discrete safety interface have the state "logic zero". If this is not the case, the robot controller prevents or terminates Start-up mode.

If an additional discrete safety interface for safety options is used, the inputs there must also have the state "logic zero".
- System Software 8.3 or higher:

Start-up mode is always possible. This also means that it is independent of the state of the inputs at the discrete safety interface.

If an additional discrete safety interface is used for safety options: The states of these inputs are also irrelevant.

Ethernet safety interface

The robot controller prevents or terminates Start-up mode if a connection to a higher-level safety system exists or is established.

Hazards Possible hazards and risks involved in using Start-up mode:

- A person walks into the manipulator's danger zone.
- In a hazardous situation, a disabled external EMERGENCY STOP device is actuated and the manipulator is not shut down.

Additional measures for avoiding risks in Start-up mode:

- Cover disabled EMERGENCY STOP devices or attach a warning sign indicating that the EMERGENCY STOP device is out of operation.
- If there is no safety fence, other measures must be taken to prevent persons from entering the manipulator's danger zone, e.g. use of warning tape.



DANGER External safeguards are disabled in Start-up mode. Observe the safety instructions relating to Start-up mode. (>>> 5.8.3.2 "Start-up mode" Page 90)

In Start-up mode, the system switches to the following simulated input image:

- The external EMERGENCY STOP is not active.
- The safety gate is open.
- No safety stop 1 has been requested.
- No safety stop 2 has been requested.
- No safe operational stop has been requested.
- Only for VKR C4: E2 is closed.

If SafeOperation or SafeRangeMonitoring is used, Start-up mode also influences other signals.

	Information about the effects of Start-up mode in conjunction with SafeOperation or SafeRangeMonitoring can be found in the documentation SafeOperation and SafeRangeMonitoring .
---	---

Mapping of standard signals:

Byte 0: 0100 1110

Byte 1: 0100 0000

SafeOperation or SafeRangeMonitoring signal mapping:

Byte 2: 1111 1111

Byte 3: 1111 1111

Byte 4: 1111 1111

Byte 5: 1111 1111

Byte 6: 1000 0000

Byte 7: 0000 0000

8.12 Switching on the robot controller

Preconditions

- The door of the robot controller is closed.
- All electrical connections are correct and the power supply is within the specified limits.
- It must be ensured that no persons or objects are present within the danger zone of the manipulator.
- All safety devices and protective measures are complete and fully functional.
- The internal temperature of the cabinet must have adapted to the ambient temperature.

	We recommend that all motions of the manipulator should be triggered from outside the safety fencing.
---	---

Procedure

1. Switch on the mains power to the robot controller.
2. Release the E-STOP device on the KUKA smartPAD.
3. Switch on the main switch. The control PC begins to run up the operating system and the control software.

9 Operation

9.1 KUKA smartPAD teach pendant

9.1.1 Front view

Function The smartPAD is the teach pendant for the industrial robot. The smartPAD has all the operator control and display functions required for operating and programming the industrial robot.

The smartPAD has a touch screen: the smartHMI can be operated with a finger or stylus. An external mouse or external keyboard is not necessary.

Overview

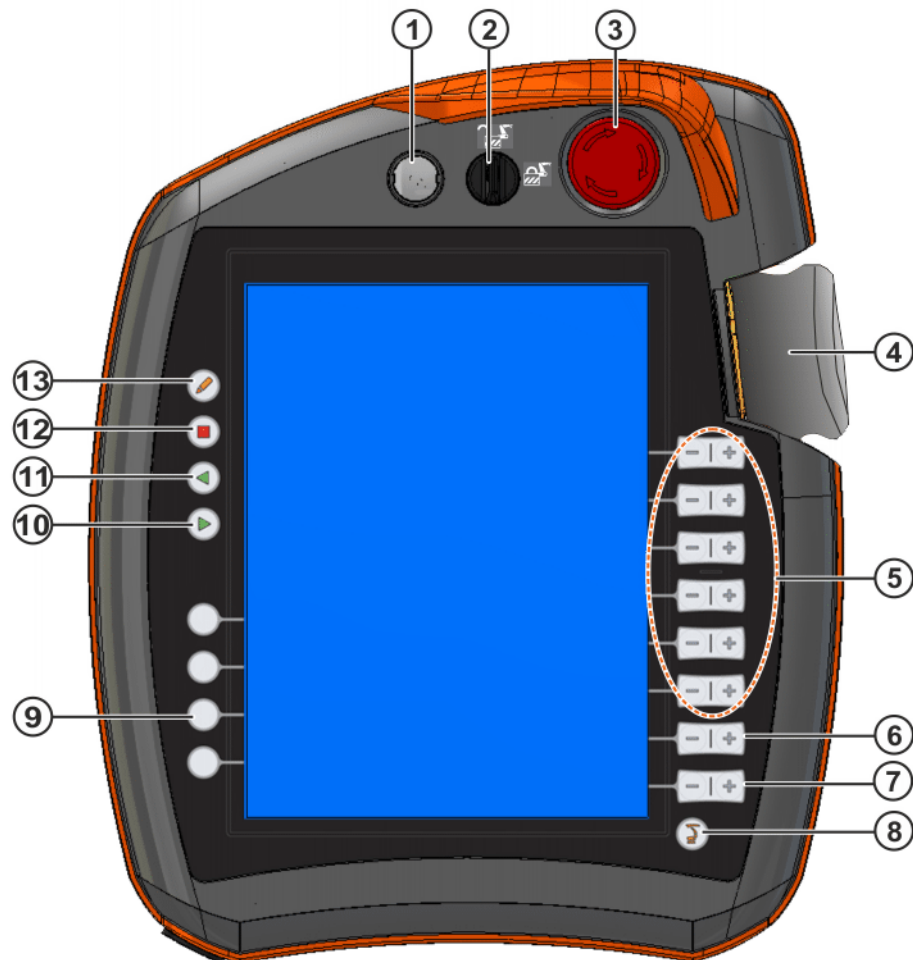

Fig. 9-1: KUKA smartPAD, front view

Item	Description
1	Button for disconnecting the smartPAD
2	Keyswitch for calling the connection manager. The switch can only be turned if the key is inserted. The operating mode can be changed by using the connection manager.

Item	Description
3	EMERGENCY STOP button. Stops the robot in hazardous situations. The EMERGENCY STOP button locks itself in place when it is pressed.
4	Space Mouse: For moving the robot manually.
5	Jog keys: For moving the robot manually.
6	Key for setting the program override
7	Key for setting the jog override
8	Main menu key: Shows the menu items on the smartHMI
9	Status keys. The status keys are used primarily for setting parameters in technology packages. Their exact function depends on the technology packages installed.
10	Start key: The Start key is used to start a program.
11	Start backwards key: The Start backwards key is used to start a program backwards. The program is executed step by step.
12	STOP key: The STOP key is used to stop a program that is running.
13	Keyboard key Displays the keyboard. It is generally not necessary to press this key to display the keyboard, as the smartHMI detects when keyboard input is required and displays the keyboard automatically.

9.1.2 Rear view

Overview



Fig. 9-2: KUKA smartPAD, rear view

- | | | | |
|---|-------------------|---|----------------------|
| 1 | Enabling switch | 4 | USB connection |
| 2 | Start key (green) | 5 | Enabling switch |
| 3 | Enabling switch | 6 | Identification plate |

Description

Element	Description
Identification plate	Identification plate
Start key	The Start key is used to start a program.
Enabling switch	<p>The enabling switch has 3 positions:</p> <ul style="list-style-type: none"> ■ Not pressed ■ Center position ■ Panic position <p>The enabling switch must be held in the center position in operating modes T1 and T2 in order to be able to jog the manipulator.</p> <p>In the operating modes Automatic and Automatic External, the enabling switch has no function.</p>
USB connection	<p>The USB connection is used, for example, for archiving and restoring data.</p> <p>Only for FAT32-formatted USB sticks.</p>

10 Maintenance

Description Maintenance work must be performed at the specified maintenance intervals after commissioning at the customer's plant.

10.1 Maintenance symbols

Maintenance symbols



Oil change



Lubricate with grease gun



Lubricate with brush



Tighten screw/nut



Check component, visual inspection



Clean component



Exchange battery

Preconditions

- The robot controller must be switched off and secured to prevent unauthorized persons from switching it on again.



WARNING

Cables routed from power supply connection X1 to the main switch are energized even when the main switch is switched off! This mains voltage can cause injuries on contact.

- The power cable is de-energized.
- Observe the ESD guidelines.

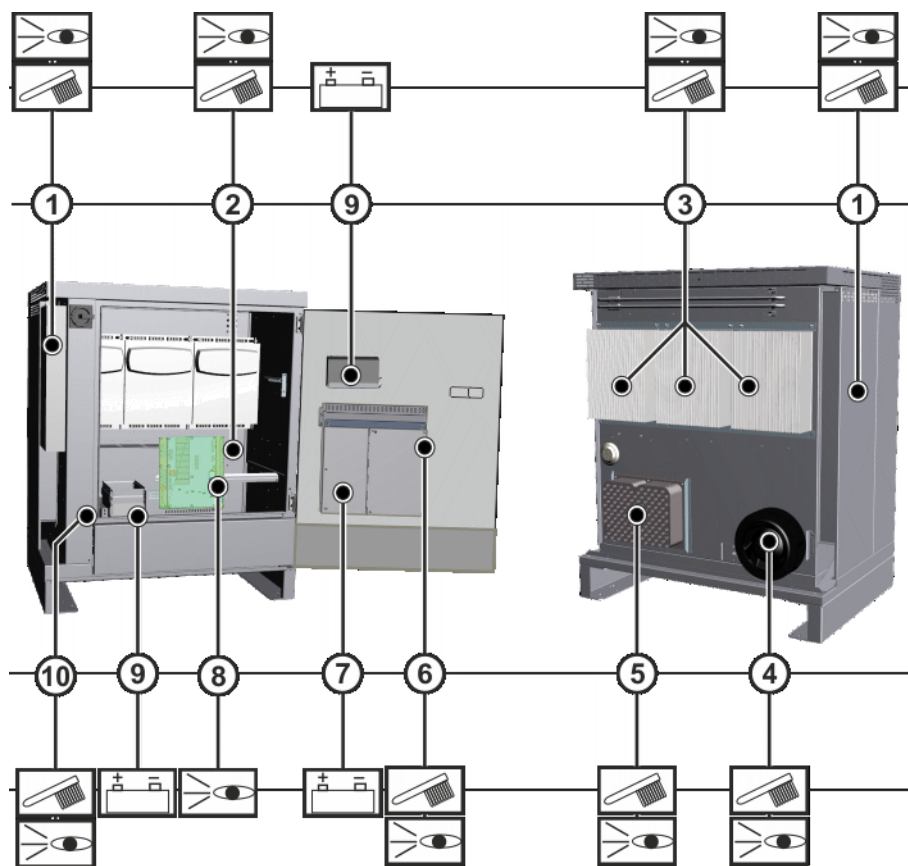

Fig. 10-1: Maintenance points

Interval	Item	Activity
6 months	8	Check the utilized relay outputs of the SIB and/or Extended SIB for correct functioning (>>> 10.2 "Checking SIB relay outputs" Page 145) (>>> 10.3 "Checking Extended SIB relay outputs" Page 145)
	-	Cyclical function test of operator safety and external EMERGENCY STOP devices
1 year at the latest	4	Depending on installation conditions and degree of fouling, clean the protective grille of the external fan with a brush.
2 years at the latest	1	Depending on installation conditions and degree of fouling, clean the heat exchanger with a brush.
	3	Depending on installation conditions and degree of fouling, clean the heat sinks of the KPP and KSPs with a brush.
	4	Depending on installation conditions and degree of fouling, clean the external fan with a brush.
	5	Depending on installation conditions and the degree of fouling, clean the heat sink of the low-voltage power supply unit with a brush.
5 years	7	Exchange the motherboard battery
5 years (with 3-shift operation)	6	Exchange the control PC fan (>>> 11.5.2 "Exchanging the control PC fan" Page 152)
	4	Exchange the external fan (>>> 11.3 "Exchanging the external fan" Page 149)
	10	Exchange the internal fan, if present (>>> 11.4 "Exchanging the internal fan" Page 150)

Interval	Item	Activity
As indicated by the battery monitoring	9	Exchange the batteries (>>> 11.7 "Exchanging the batteries" Page 171)
When pressure relief plug becomes discolored	2	Depends on installation conditions and degree of fouling. Visual inspection of the pressure relief plug: change filter insert if discolored (original color: white) (>>> 11.9 "Exchanging the pressure relief plug" Page 175)

Once an activity from the maintenance list has been carried out, a visual inspection must be made, with special attention to the following points:

- Check that fuses, contactors, plug-in connections and boards are fitted securely.
- Check cabling for damage.
- Check PE equipotential bonding connection.
- Check all system components for wear and damage.

10.2 Checking SIB relay outputs

Activity Check the function of the output "Local Emergency Stop".

Procedure ■ Press the local EMERGENCY STOP device.

Activity Check the function of the output "Operator safety acknowledged".

Procedure 1. Set operating mode to Automatic or Automatic External.
2. Open operator safety (safeguard).

Activity Check the function of the output "Switch on periphery".

Procedure 1. Set operating mode to Automatic or Automatic External.
2. Open operator safety (safeguard).
3. Release enabling switch in "T1" or "T2" mode.

If no error message is displayed, the relay outputs are OK.

10.3 Checking Extended SIB relay outputs

Activity Check the alarm space outputs.

Procedure ■ Violate the corresponding alarm space. Depending on the configuration of the alarm space, the Cartesian or axis-specific alarm space can be violated.

	In normal operation, the alarm space outputs are checked cyclically within the test interval (6 months) by the production operation.
---	--

Activity Check the output "SafeOperation active".

Procedure ■ Deactivate SafeOperation or SafeRangeMonitoring.

Activity Check the output "Robot referenced".

Procedure ■ Switch the drive bus off and back on again.

If no error message is displayed, the relay outputs are OK.

10.4 Cleaning the robot controller

Precondition

- The robot controller must be switched off and secured to prevent unauthorized persons from switching it on again.
- The controller has been shut down.
- The power cable is de-energized.



WARNING Cables routed from power supply connection X1 to the main switch are energized even when the main switch is switched off! This mains voltage can cause injuries on contact.

- Observe the ESD guidelines.

Work regulations

- The manufacturer's instructions must be observed when using cleaning agents for cleaning work.
- It must be ensured that no cleaning agents enter electrical components.
- Do not use compressed air during cleaning work.
- Do not spray with water.

Procedure

1. Loosen and vacuum up any dust deposits.
2. Clean robot controller with a cloth soaked with a mild cleaning agent.
3. Clean cables, plastic parts and hoses with a solvent-free cleaning agent.
4. Replace damaged, illegible or missing inscriptions, labels and plates.

11 Repair

11.1 Repair and procurement of spare parts

Repair

Repairs to the robot controller may only be carried out by KUKA customer support personnel or by customers who have taken part in a relevant course of training held by KUKA Roboter GmbH.

Repairs within modules may only be carried out by specially trained KUKA Roboter GmbH personnel.

Procurement of spare parts

The article numbers of the spare parts are listed in the spare parts catalog.

KUKA Roboter GmbH supplies the following types of spare parts for repairs to the robot controller:

- New parts

Once the new part has been installed, the part that has been removed can be disposed of.

- Exchange parts

Once the exchange part has been installed, the part that has been removed is returned to KUKA Roboter GmbH.



A "Robot Repair Card" is supplied with the exchange parts. The Repair Card must be completed and returned to KUKA Roboter GmbH.

11.2 Wiring example X11

Connector pin allocation

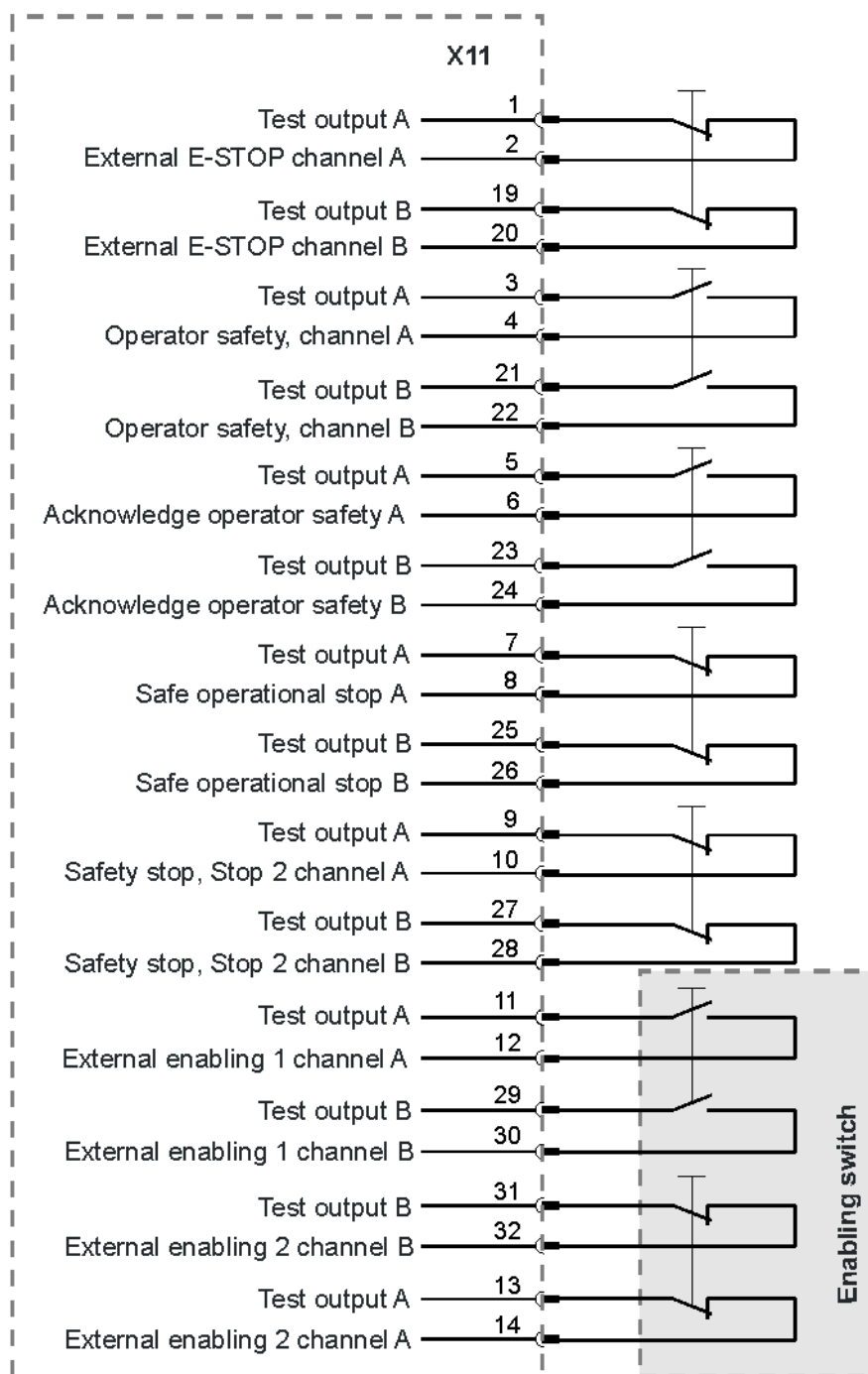

Fig. 11-1: Wiring example X11

The enabling switch is a three-position switch with a panic position.

- Enabling switch center position (make contact closed = enabled)
- Panic (break contact open = panic position)

WARNING If wiring example X11 is used for start-up or trouble-shooting, the connected safety components of the robot system are disabled.



The industrial robot can be set to Start-up mode via the smartHMI user interface. (>>> 8.11 "Start-up mode" Page 137) In this mode, the manipulator can be moved in T1 mode without X11 being wired up.

11.3 Exchanging the external fan

Preconditions

- The robot controller must be switched off and secured to prevent unauthorized persons from switching it on again.
- The power cable must be de-energized.



WARNING Cables routed from power supply connection X1 to the main switch are energized even when the main switch is switched off! This mains voltage can cause injuries on contact.

- Observe the ESD guidelines.

Procedure

1. Unplug fan connector X14 on the CCU.
2. Remove the rear panel.

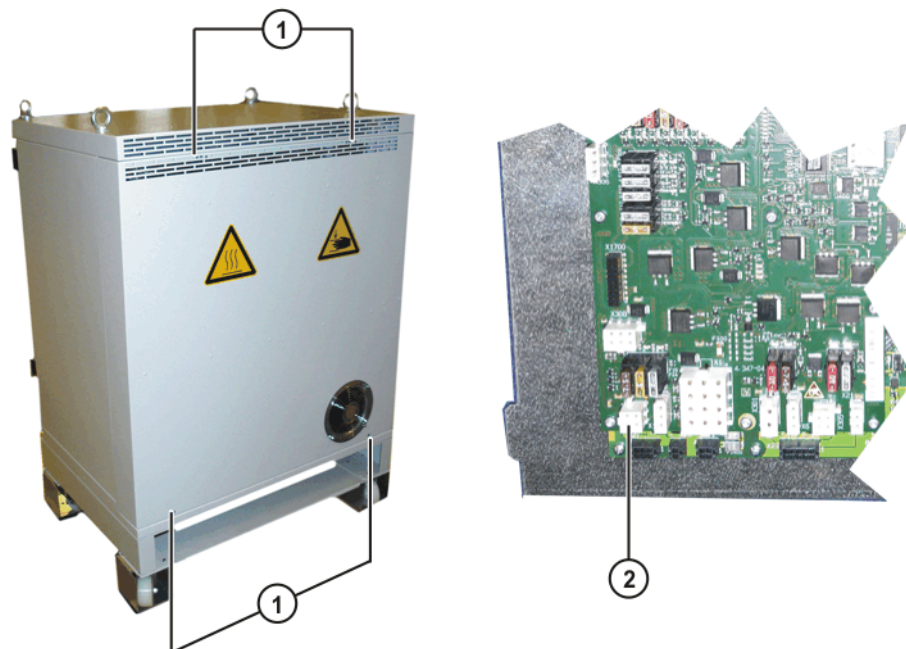

Fig. 11-2: Exchanging the external fan

- 1 Fastening of rear panel
- 2 Fan connector X14 on the CCU
3. Remove the screws of the cable inlet.
4. Swivel back the cable inlet and pull out the connecting cable.

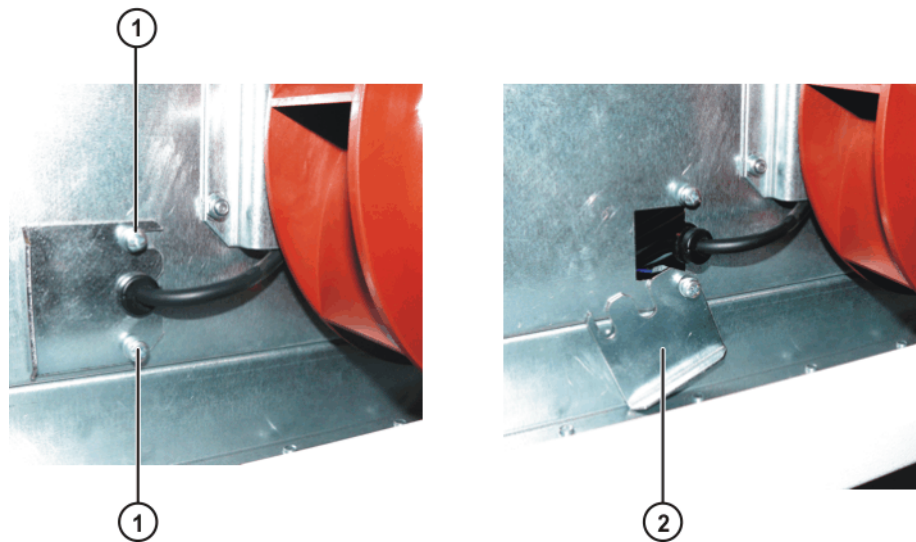

Fig. 11-3: External fan, cable inlet

- 1 Fastening of cable inlet
 - 2 Cover of the cable inlet
5. Remove the fan holder together with the fan.
 6. Install the new fan together with its holder and fasten.

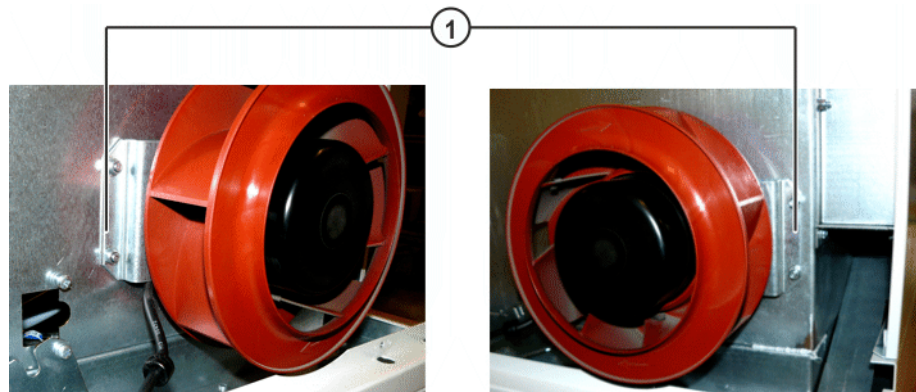

Fig. 11-4: Exchanging the external fan

- 1 Fastening of the fan holder
7. Route the connecting cable in the cabinet.
 8. Mount the cable inlet.
 9. Insert and fasten the rear panel
 10. Plug in fan connector X14 on the CCU.

11.4 Exchanging the internal fan

Description

The internal fan is not installed in all cabinet variants. As an alternative to the internal fan, a KPC cooling duct may be installed. (>>> 3.22 "Cabinet cooling" Page 60) The internal fan is located in the lower left-hand corner of the control cabinet.

Preconditions

- The robot controller must be switched off and secured to prevent unauthorized persons from switching it on again.
- The power cable must be de-energized.

⚠ WARNING Cables routed from power supply connection X1 to the main switch are energized even when the main switch is switched off! This mains voltage can cause injuries on contact.

- Observe the ESD guidelines.

Procedure

1. Unplug fan connector X962 from the fan module.

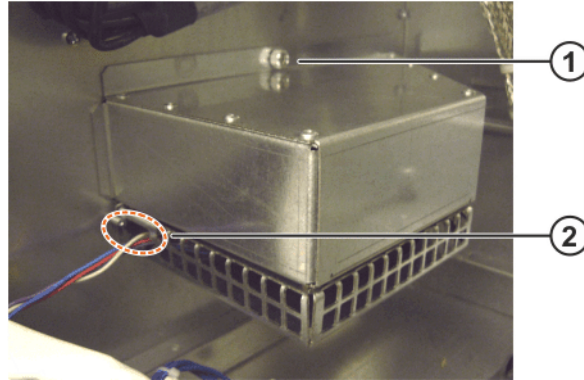

Fig. 11-5: Removing the fan module

- | | | | |
|---|-----------------|---|----------------|
| 1 | Fastening screw | 2 | Connector X962 |
|---|-----------------|---|----------------|
2. Loosen the fastening screw of the fan module.
 3. Take off fan module.
 4. Insert the new fan module and fasten it with the fastening screw.
 5. Plug fan connector X962 into the fan module.

11.5 Exchanging control PC components

11.5.1 Exchanging the control PC

Precondition

- Observe the ESD guidelines.
- From KSS 8.3 and from motherboard D3236-K onwards:
 - Board Package USB stick in the USB port.

Procedure

1. Shut down the robot controller with the settings **Cold start** and **Reload files**.
2. Turn off the robot controller using the main switch and take measures to prevent it from being turned on again unintentionally.
3. Disconnect the power cable from the supply.

⚠ WARNING Cables routed from power supply connection X1 to the main switch are energized even when the main switch is switched off! This mains voltage can cause injuries on contact.

4. Unplug the power supply and all connections to the control PC.
5. Slacken the knurled nuts.
6. Remove the control PC and lift it out towards the top.

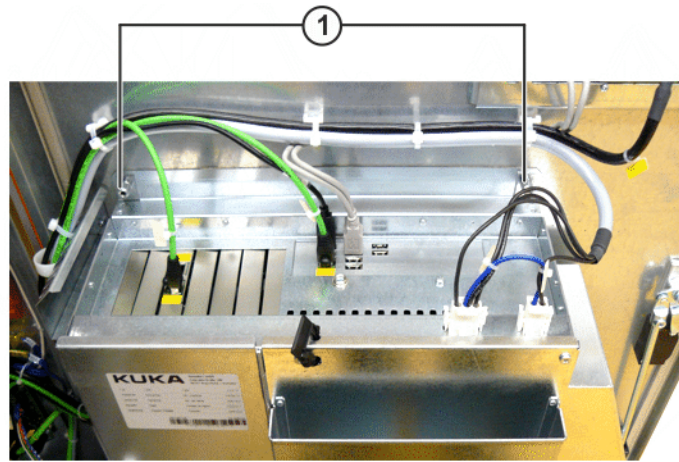

Fig. 11-6: Fastening of control PC

- 1 Knurled nut
7. Insert the new control PC and fasten.
8. Plug in the connections.
For network cable connection, see (>>> 3.19 "Control PC interfaces" Page 55)
9. Switch on the robot controller.
From KSS 8.3 and from motherboard D3236-K onwards:
 - Once the controller has been successfully started, disconnect the Board Package USB stick and carefully store it.
Starting and installing the drivers may take some time.

11.5.2 Exchanging the control PC fan

- Preconditions**
- The robot controller must be switched off and secured to prevent unauthorized persons from switching it on again.
 - The power cable must be de-energized.

WARNING Cables routed from power supply connection X1 to the main switch are energized even when the main switch is switched off! This mains voltage can cause injuries on contact.

- Observe the ESD guidelines.

Procedure

1. Remove the control PC. (>>> 11.5.1 "Exchanging the control PC" Page 151)
2. Remove air duct, if present.
3. Remove the control PC cover.
4. Release and unplug the fan connector. Depending on the variant, the fan connector is located either on the housing or directly on the motherboard.

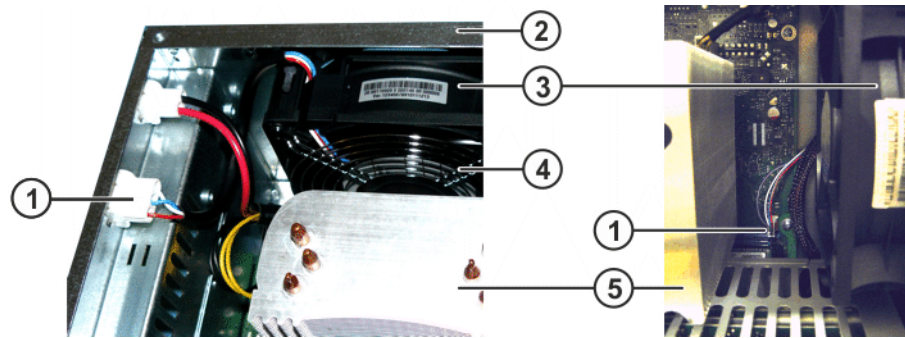

Fig. 11-7: Disconnect control PC fan from housing or motherboard

- | | |
|----------------------|--------------|
| 1 Fan connector | 4 Fan grille |
| 2 Control PC housing | 5 CPU fan |
| 3 Fan | |

5. Remove outer fan grille.
6. Pull the fan inwards off the mounting plugs.
7. If the fan is designed with an inner fan grille: remove the expanding rivets and take off the inner fan grille.

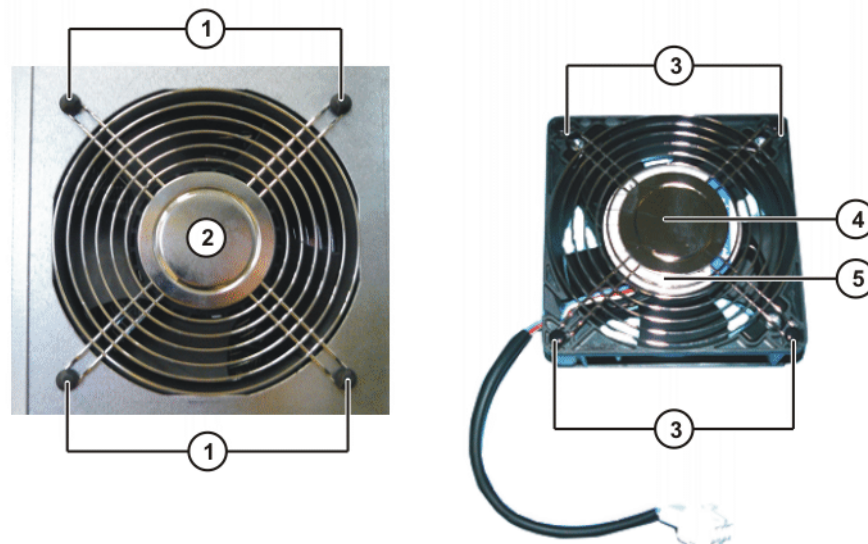

Fig. 11-8: PC fan configuration

- | | |
|--|---|
| 1 Mounting plugs | 4 Fan grille (optional, depending on variant) |
| 2 Outer fan grille | 5 Fan identification plate |
| 3 Fastening of fan grille (expanding rivets) | |

8. If the fan is designed with an inner fan grille: fasten the inner fan grille to the new fan with the expanding rivets.

i The fan grille must be fastened to the side with the identification plate. See (>>> Fig. 11-8).

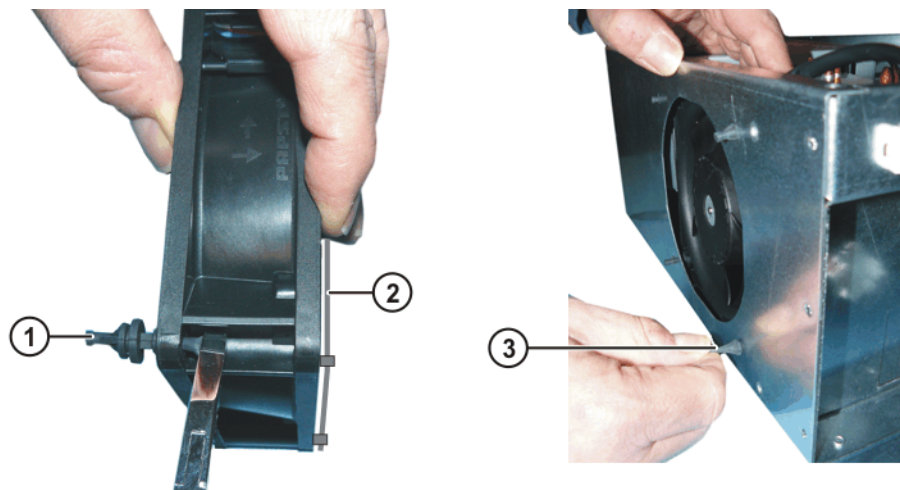

Fig. 11-9: Installing the control PC fan

- | | |
|--|---|
| <p>1 Mounting plugs on the fan</p> <p>2 Fan grille</p> | <p>3 Mounting plugs on the PC housing</p> |
|--|---|
9. Install the mounting plugs in the fan.
 10. Insert the fan into the PC housing and pull the mounting plugs through the PC housing.
 11. Reattach outer fan grille.
 12. Install the air duct.

11.5.3 Exchanging the motherboard

A defective motherboard is not exchanged separately, but together with the control PC.

11.5.4 Exchanging the motherboard battery

The battery on the motherboard of the control PC may only be exchanged by authorized maintenance personnel in consultation with the KUKA customer support service.

11.5.5 Exchanging the LAN Dual NIC network card

Description

Depending on the control PC variant, the LAN Dual NIC network card is permanently integrated into the motherboard. In this case, if the LAN Dual NIC network card is defective, the entire control PC must be exchanged.

If the LAN Dual NIC network card is plugged onto the motherboard, it can be exchanged separately.

Preconditions

- The robot controller must be switched off and secured to prevent unauthorized persons from switching it on again.
- The power cable must be de-energized.

WARNING Cables routed from power supply connection X1 to the main switch are energized even when the main switch is switched off! This mains voltage can cause injuries on contact.

- Observe the ESD guidelines.

Procedure

1. Open the PC chassis.

2. Unplug the connections to the LAN Dual NIC network card.
3. Release the fastenings of the card and pull the card out of the slot.
4. Inspect the new LAN Dual NIC network card for mechanical damage.
5. Plug the LAN Dual NIC network card into its slot and tighten the fastening screw.
6. Plug in the connections to the card.

11.5.6 Exchanging the hard drive

Preconditions

- The robot controller must be switched off and secured to prevent unauthorized persons from switching it on again.
- The power cable must be de-energized.

WARNING Cables routed from power supply connection X1 to the main switch are energized even when the main switch is switched off! This mains voltage can cause injuries on contact.

- Observe the ESD guidelines.

Procedure

1. Release and unplug the SATA connector.
2. Unplug power supply connector.
3. Depending on the variant, unscrew knurled screws or remove hard drive from retaining clip.
4. Exchange the hard drive for a new one.
5. Plug in the SATA and power supply connectors.
6. Fasten the hard drive with the knurled screws or in the retaining clip.
7. Install the operating system and the KUKA System Software (KSS).
8. The system configuration of the industrial robot must be configured using WorkVisual.

i Once the hard drive has been exchanged, the following options are available in addition to configuration using WorkVisual:

- Load the archive of the previous installation.
- Restore the complete image using the KUKA Recovery Tool.

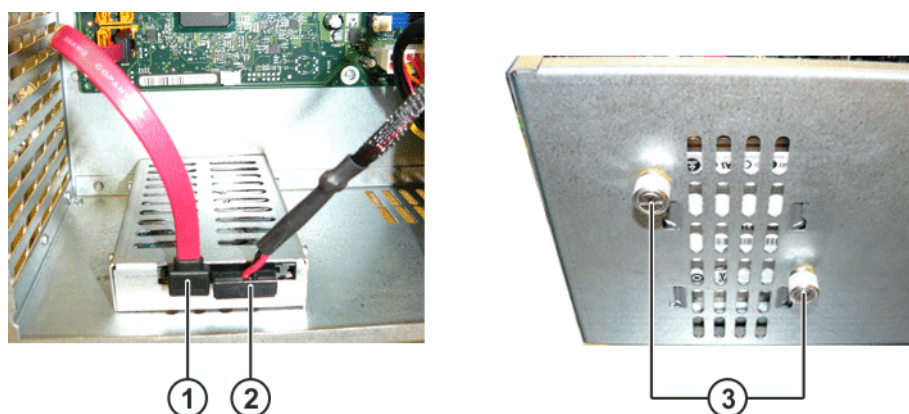

Fig. 11-10: Exchanging the hard drive

- 1 SATA connector
- 2 Power supply connector
- 3 Knurled screws on the underside

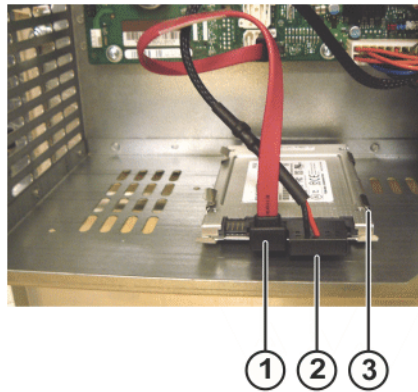

Fig. 11-11: Exchanging the hard drive, variant with retaining clip

- 1 SATA connection
- 2 Power supply connector
- 3 Retaining clip

11.6 Modifying the system configuration, exchanging devices

Description

The system configuration of the industrial robot must be configured using WorkVisual in the following cases:

- Installation of KSS/VSS 8.2 or higher
This is the case if KSS/VSS 8.2 or higher is installed without KSS/VSS 8.2 or higher already being present (because it has been uninstalled or deleted or has never been installed).
- The hard drive has been exchanged.
- A device has been replaced by a device of a different type.
- More than one device has been replaced by a device of a different type.
- One or more devices have been removed.
- One or more devices have been added.

Exchanging devices

If a device is exchanged, at least one KCB, KSB or KEB device is replaced by a device of the same type. Any number of KCB, KSB and KEB devices can be exchanged until all devices in the KCB, KSB and KEB have been replaced simultaneously by devices of the same type. Simultaneous exchange of two identical components of the KCB is not possible. Only one of the identical components may be exchanged at any one time.

i The interchanging of 2 identical devices can only occur in the case of the KSP3x40 if the current system configuration contains 2 KSP3x40.

11.6.1 Exchanging the KUKA Power Pack

Connections

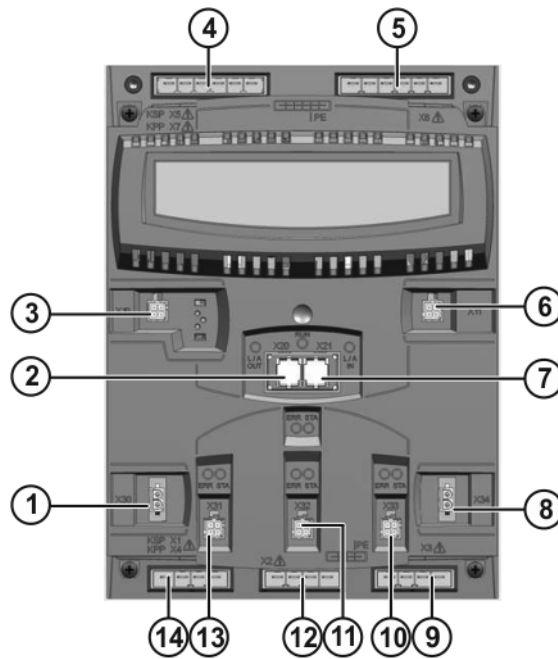

Fig. 11-12: KPP connections

Item	Connector	Description
1	X30	Brakes power supply OUT
2	X20	Drive bus OUT
3	X10	Control electronics power supply OUT
4	X7	Ballast resistor
5	X6	DC link OUT
6	X11	Control electronics power supply IN
7	X21	Drive bus IN
8	X34	Brakes power supply IN
9	X3	Motor connection 3, axis 8
10	X33	Brake connection 3, axis 8
11	X32	Brake connection 2, axis 7
12	X2	Motor connection 2, axis 7
13	-	Not used
14	X4	AC power supply connection and PE

KPP 3 connections

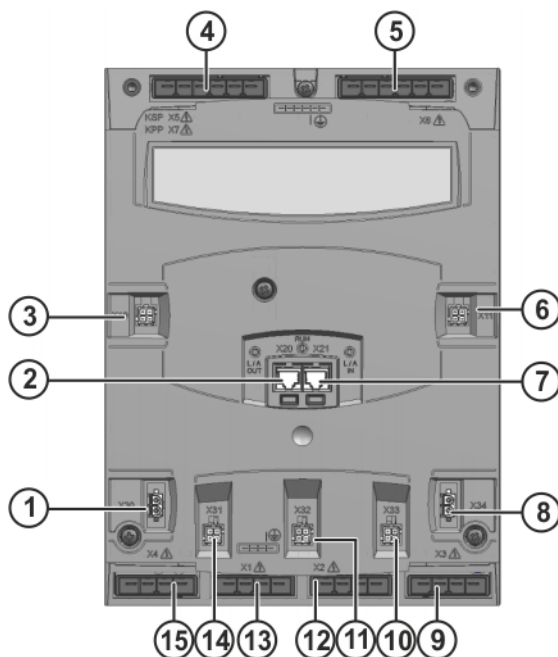

Fig. 11-13: KPP 3 connections

Item	Connector	Description
1	X30	Brakes power supply OUT
2	X20	Drive bus OUT
3	X10	Control electronics power supply OUT
4	X7	Ballast resistor
5	X6	DC link OUT
6	X11	Control electronics power supply IN
7	X21	Drive bus IN
8	X34	Brakes power supply IN
9	X3	Motor connection 3
10	X33	Connection, brake 3
11	X32	Connection, brake 2
12	X2	Motor connection 2
13	X1	Motor connection 1
14	X31	Connection, brake 1
15	X4	AC power supply connection and PE

Precondition

- The robot controller must be switched off and secured to prevent unauthorized persons from switching it on again.

CAUTION If removal is performed immediately after the robot controller has been shut down, the heat sink surface temperatures are likely to be high and could result in burn injuries. Protective gloves must be worn.

- The power cable is de-energized.

WARNING Cables routed from power supply connection X1 to the main switch are energized even when the main switch is switched off! This mains voltage can cause injuries on contact.

- Observe the ESD guidelines.
- Wait 5 minutes until the intermediate circuit has discharged.

⚠ WARNING The following components may remain energized (50-780 V) up to 5 minutes after the robot controller has been switched off:

- the KPP
- the KSPs
- connections for motor connector X20 and connected motor cables
- the intermediate circuit connecting cables

This voltage can cause life-threatening injuries.

Procedure

1. Unlock connectors X20 and X21 of the data cables. Unplug all connections to the KPP.

NOTICE Unplugging the data cable connectors without first unlocking them damages the connectors. Unlock the connectors before unplugging them.

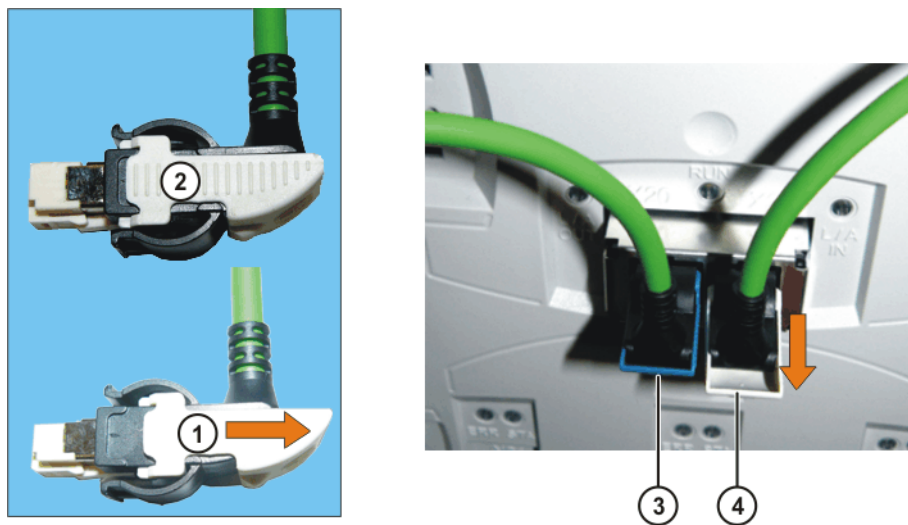

Fig. 11-14: Unlocking connectors X20 and X21

- | | |
|----------------------|-------------------------------------|
| 1 Connector unlocked | 3 Connector plugged in and locked |
| 2 Connector locked | 4 Connector plugged in and unlocked |

2. Slacken the Allen screws.

⚠ CAUTION The KPP weighs approx. 10 kg. When removing or installing the KPP, care must be taken to avoid injury by crushing. Protective gloves must be worn.

3. Lift the KPP slightly, tilt the top forwards and lift the KPP out of the support bracket.
4. Insert the new KPP into the support bracket, hook it on at the top and tighten the fastening screws (tightening torque 4 Nm).
5. Plug in all the connections in accordance with the connector and cable labeling. Lock connectors X20 and X21.
6. If exchanging the device resulted in a system modification, the system configuration of the industrial robot must be configured using WorkVisual.

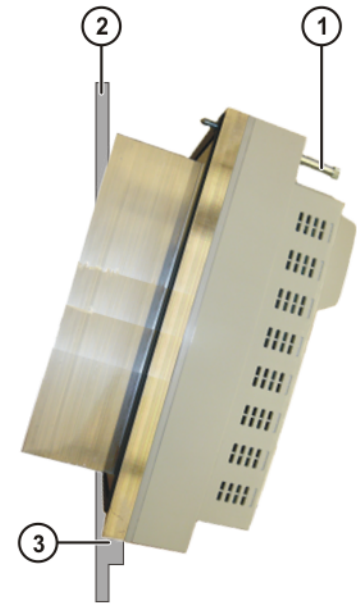

Fig. 11-15: KPP fastening

- 1 Allen screws
- 2 Rear panel of cabinet
- 3 Support bracket

11.6.2 Exchanging the KUKA Servo Pack

Connections

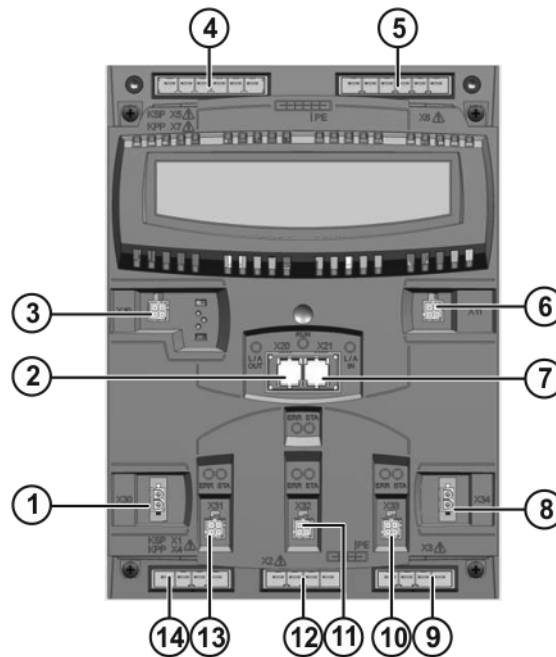

Fig. 11-16: KSP connection with amplifiers for 3 axes

Item	Connector	Description
1	X30	Brakes power supply OUT
2	X20	Drive bus OUT
3	X10	Control electronics power supply OUT
4	X5	DC link OUT
5	X6	DC link IN
6	X11	Control electronics power supply IN

Item	Connector	Description
7	X21	Drive bus IN
8	X34	Brakes power supply IN
9	X3	Motor connection 3
10	X33	Connection, brake 3
11	X32	Connection, brake 2
12	X2	Motor connection 2
13	X31	Connection, brake 1
14	X1	Motor connection 1

Precondition

- The robot controller must be switched off and secured to prevent unauthorized persons from switching it on again.

CAUTION If removal is performed immediately after the robot controller has been shut down, the heat sink surface temperatures are likely to be high and could result in burn injuries. Protective gloves must be worn.

- The power cable is de-energized.

WARNING Cables routed from power supply connection X1 to the main switch are energized even when the main switch is switched off! This mains voltage can cause injuries on contact.

- Observe the ESD guidelines.
- Wait 5 minutes until the intermediate circuit has discharged.

WARNING The following components may remain energized (50-780 V) up to 5 minutes after the robot controller has been switched off:

- the KPP
- the KSPs
- connections for motor connector X20 and connected motor cables
- the intermediate circuit connecting cables

This voltage can cause life-threatening injuries.

Procedure

1. Unlock connectors X20 and X21 of the data cables. Unplug all connections to the KSP.

NOTICE Unplugging the data cable connectors without first unlocking them damages the connectors. Unlock the connectors before unplugging them.

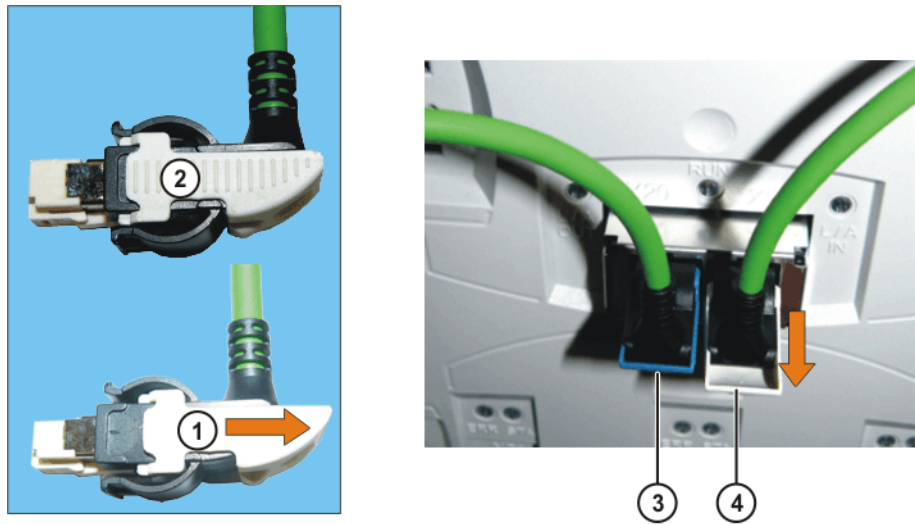

Fig. 11-17: Unlocking connectors X20 and X21

- | | |
|----------------------|---|
| 1 Connector unlocked | 3 Connector X21 plugged in and locked |
| 2 Connector locked | 4 Connector X20 plugged in and unlocked |

2. Slacken the Allen screws.

CAUTION The KSP weighs approx. 10 kg. When removing or installing the KSP, care must be taken to avoid injury by crushing. Protective gloves must be worn.

- Lift the KSP slightly, tilt the top forwards and lift the KPP out of the support bracket.
- Insert the new KSP into the support bracket, hook it on at the top and tighten the fastening screws (tightening torque 4 Nm).
- Plug in all the connections in accordance with the connector and cable labeling. Lock connectors X20 and X21.
- If exchanging the device resulted in a system modification, the system configuration of the industrial robot must be configured using WorkVisual.

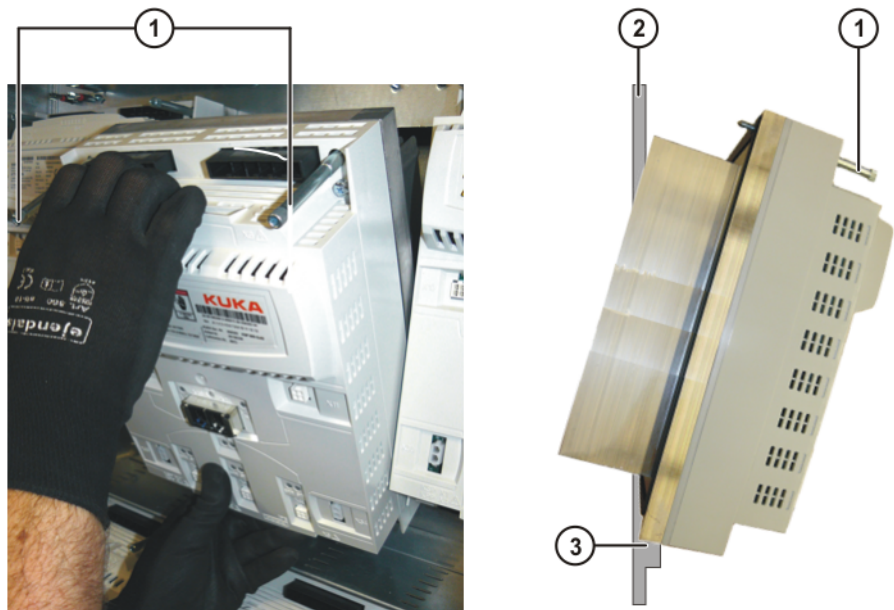

Fig. 11-18: KSP fastening

- 1 Allen screws
- 2 Rear panel of cabinet
- 3 Support bracket

11.6.3 Exchanging the Cabinet Control Unit

Connections

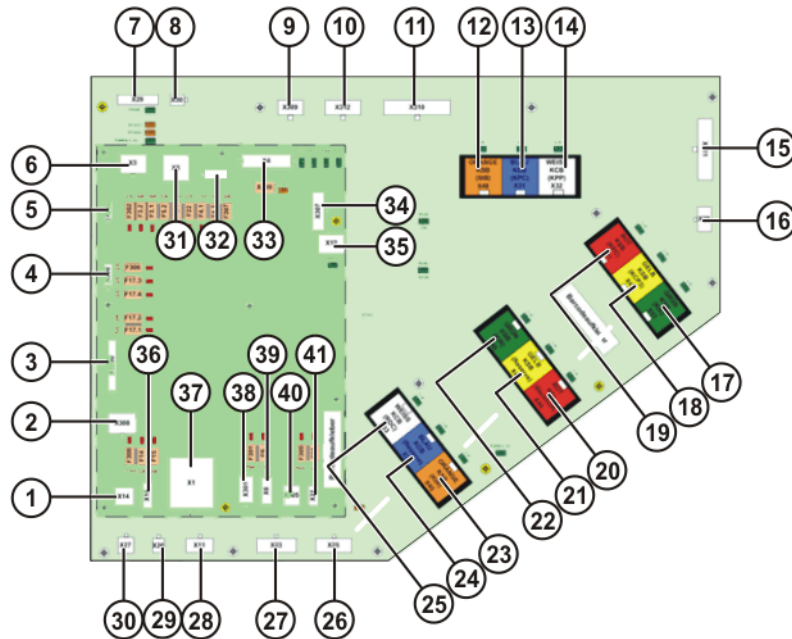

Fig. 11-19: Connections on the CCU

Item	Connector	Description
1	X14	External fan connection
2	X308	External power supply, safety circuit
3	X1700	Board connection
4	X306	smartPAD power supply
5	X302	SIB power supply
6	X3	KPP1 power supply
7	X29	EDS connection, memory card
8	X30	Ballast resistor temperature monitoring
9	X309	Main contactor 1 (HSn, HSRn)
10	X312	Main contactor 2 (HSn, HSRn)
11	X310	Spare (safe input 2/3, safe output 2/3)
12	X48	Safety Interface Board SIB (orange)
13	X31	Controller bus, KPC (blue)
14	X32	Controller bus, KPP (white)
15	X311	Safe inputs, ZSE1, ZSE2; NHS (jumper plug)
16	X28	Mastering test
17	X43	KUKA Service Interface (KSI) (green)
18	X42	KUKA Operator Panel Interface smartPAD (yellow)
19	X41	KUKA System Bus, KPC (red)
20	X44	EtherCAT Interface (KUKA Extension Bus) (red)
21	X47	Spare (yellow)
22	X46	KUKA System Bus, RoboTeam (green)
23	X45	KUKA System Bus, RoboTeam (orange)

Item	Connector	Description
24	X34	Controller bus, RDC (blue)
25	X33	Controller bus, spare (white)
26	X25	Fast Measurement inputs 7 ... 8
27	X23	Fast Measurement inputs 1 ... 6
28	X11	Alarm contact for main switch
29	X26	Thermostatic switch for transformer
30	X27	Alarm contact for cooling unit
31	X5	KPP2 power supply
32	X22	Options power supply
33	X4	KPC, KPP, internal fan power supply
34	X307	CSP power supply
35	X12	USB
36	X15	Internal cabinet fan (optional)
37	X1	Infeed from low-voltage power supply
38	X301	24 V without battery backup (F301)
39	X6	24 V without battery backup (F6)
40	X305	Battery
41	X21	RDC power supply

Precondition

- The robot controller must be switched off and secured to prevent unauthorized persons from switching it on again.
- The power cable is de-energized.

WARNING

Cables routed from power supply connection X1 to the main switch are energized even when the main switch is switched off! This mains voltage can cause injuries on contact.

- Observe the ESD guidelines.
- Wait 5 minutes until the intermediate circuit has discharged.

WARNING

The following components may remain energized (50-780 V) up to 5 minutes after the robot controller has been switched off:

- the KPP
- the KSPs
- connections for motor connector X20 and connected motor cables
- the intermediate circuit connecting cables

This voltage can cause life-threatening injuries.

Procedure

1. Unlock the data cable connectors. Unplug all connections to the CCU.

NOTICE

Unplugging the data cable connectors without first unlocking them damages the connectors. Unlock the connectors before unplugging them.

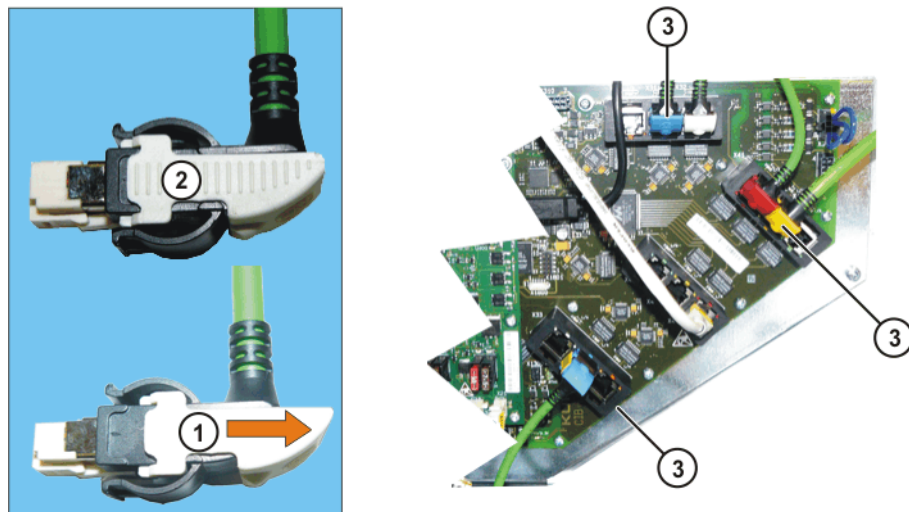

Fig. 11-20: Unlocking the data cable connectors

- | | | | |
|---|--------------------|---|---------------------------------|
| 1 | Connector unlocked | 3 | Connector plugged in and locked |
| 2 | Connector locked | | |
2. Remove the screw on the fastening plate and pull the plate with the CCU out of the tab slots.
 3. Check the new CCU for mechanical damage. Insert the fastening plate with the CCU into the tab slots and screw it firmly in place.
 4. Plug in all the connections in accordance with the connector and cable labeling. Lock the data cable connectors.

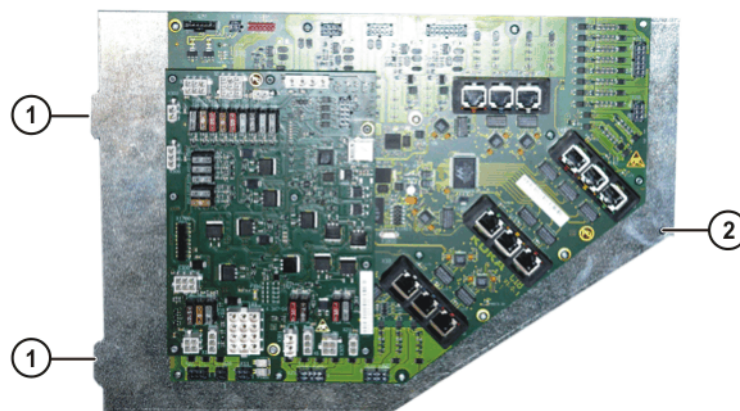

Fig. 11-21: CCU fastening

- | | |
|---|-----------------|
| 1 | Tabs |
| 2 | Fastening screw |

11.6.4 Exchanging the Safety Interface Board

Standard connections

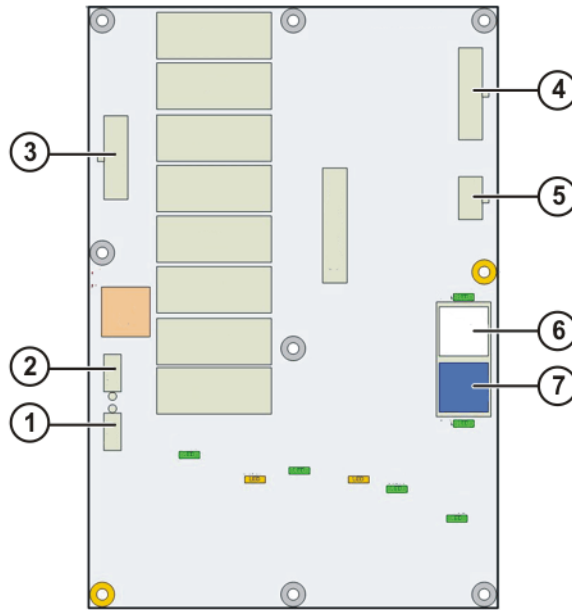

Fig. 11-22: Standard SIB connections

Item	Connector	Description
1	X250	SIB power supply
2	X251	Power supply for additional components
3	X252	Safe outputs
4	X253	Safe inputs
5	X254	Safe inputs
6	X258	KUKA System Bus IN
7	X259	KUKA System Bus OUT

Extended connections

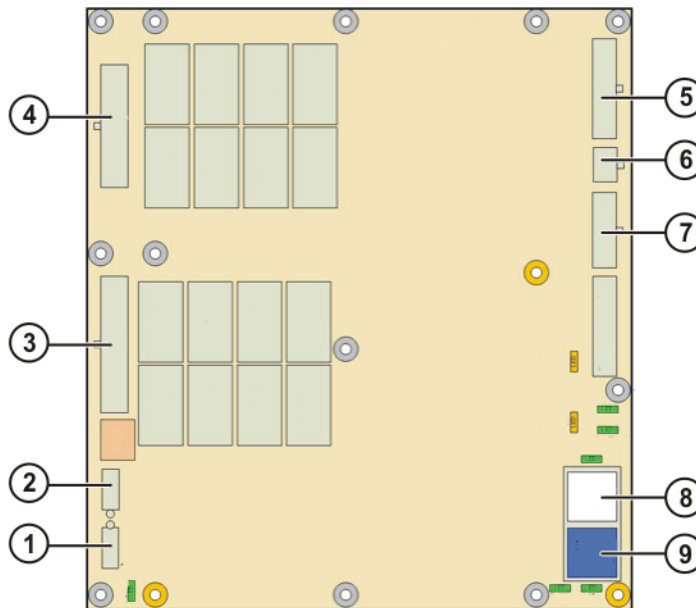

Fig. 11-23: Extended SIB connections

Item	Connector	Description
1	X260	Extended SIB power supply
2	X261	Power supply for additional components
3	X264	Safe outputs 1 and 4
4	X266	Safe outputs 5 to 8
5	X262	Safe inputs
6	X263	Safe inputs
7	X267	Safe inputs
8	X268	KUKA System Bus IN
9	X269	KUKA System Bus OUT

Precondition

- The robot controller must be switched off and secured to prevent unauthorized persons from switching it on again.
- The power cable is de-energized.

⚠ WARNING Cables routed from power supply connection X1 to the main switch are energized even when the main switch is switched off! This mains voltage can cause injuries on contact.

- Observe the ESD guidelines.
- Wait 5 minutes until the intermediate circuit has discharged.

⚠ WARNING The following components may remain energized (50-780 V) up to 5 minutes after the robot controller has been switched off:

- the KPP
- the KSPs
- connections for motor connector X20 and connected motor cables
- the intermediate circuit connecting cables

This voltage can cause life-threatening injuries.

Procedure

1. Unlock the data cable connectors. Unplug all connections to the SIB.

NOTICE Unplugging the data cable connectors without first unlocking them damages the connectors. Unlock the connectors before unplugging them.

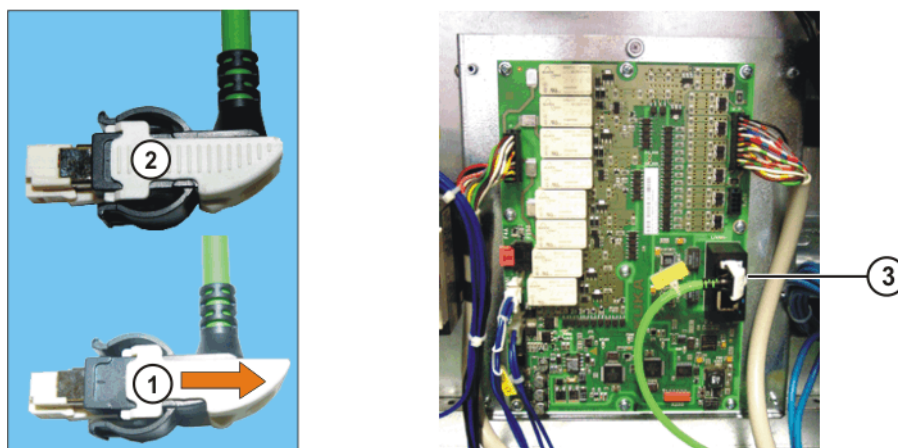

Fig. 11-24: Unlocking the data cable connectors

- 1 Connector unlocked
 - 2 Connector locked
 - 3 Connector plugged in and locked
2. Remove the screw on the fastening plate and pull the plate with the SIB out of the tab slots.
 3. Check the new SIB for mechanical damage. Insert the fastening plate with the SIB into the tab slots and screw it firmly in place.
 4. Plug in all the connections in accordance with the connector and cable labeling. Lock the data cable connectors.
 5. If exchanging the SIB resulted in a system modification, the system configuration of the industrial robot must be configured using WorkVisual.

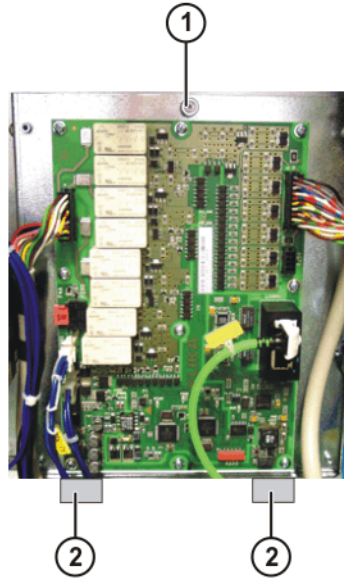

Fig. 11-25: SIB with fastening plate

- 1 Fastening screw
- 2 Tabs

11.6.5 Exchanging the Resolver Digital Converter

Connections

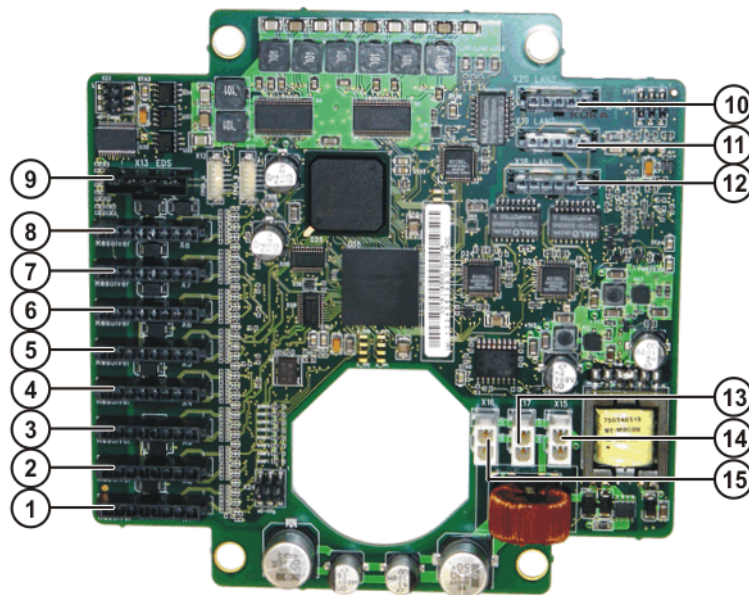

Fig. 11-26: Overview of RDC connections

Item	Connector	Description
1	X1	Resolver connection, axis 1
2	X2	Resolver connection, axis 2
3	X3	Resolver connection, axis 3
4	X4	Resolver connection, axis 4
5	X5	Resolver connection, axis 5
6	X6	Resolver connection, axis 6
7	X7	Resolver connection, axis 7
8	X8	Resolver connection, axis 8
9	X13	EDS connection, memory card, RDC
10	X20	EMD
11	X19	KCB OUT
12	X18	KCB IN
13	X17	EMD power supply
14	X15	Power supply IN
15	X16	Power supply OUT (next KCB device)

Preconditions

- The robot controller must be switched off and secured to prevent unauthorized persons from switching it on again.
- The power cable must be de-energized.

⚠ WARNING Cables routed from power supply connection X1 to the main switch are energized even when the main switch is switched off! This mains voltage can cause injuries on contact.

- Observe the ESD guidelines.

Procedure

1. Remove the screws from the lid of the RDC box.

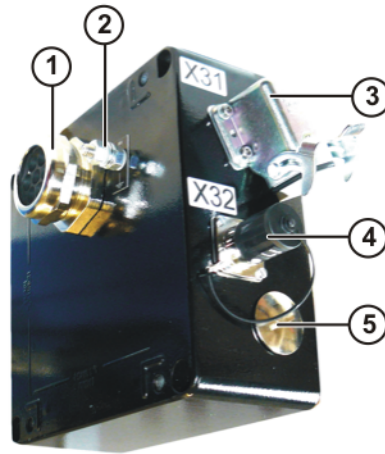

Fig. 11-27: RDC box connections

- 1 Union for 2 external axis control cables X7 and X8
 - 2 Bolt for ground conductor connection
 - 3 Data cable X31
 - 4 EMD connection X32
 - 5 Cable inlet for resolver connections X1-X6
2. Carefully disconnect all cables and bend them out of the way to the sides.
 3. Carefully unplug the EDS connection.

i The EDS memory is not removed and remains in the RDC box when the RDC is exchanged.

4. Remove the fastening screws of the RDC module.

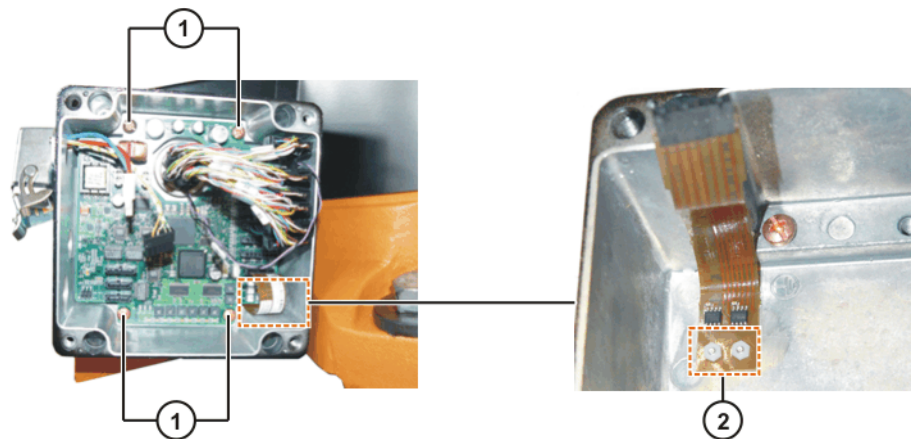

Fig. 11-28: RDC fastening

- 1 Fastening the RDC module: M6x10
Tightening torque: 2.0 Nm
 - 2 Fastening the EDS: M2.5 plastic nuts
Tightening torque: 0.1 Ncm
5. Carefully remove the RDC module from the RDC box without tilting it.
 6. Insert and fasten the new RDC module.

i If an RDC cool was installed, an RDC cool must be installed here as well.

7. Connect all cables.
8. Plug in the EDS connection.
9. Close the lid of the RDC box and screw it firmly in place.

11.7 Exchanging the batteries

The procedure for exchanging the batteries depends on the variant:

Variant	Information
Batteries inside cabinet, behind cooling duct	(>>> 11.7.1 "Exchanging the batteries behind the cooling duct" Page 171)
Batteries in cabinet door	(>>> 11.7.2 "Exchanging the batteries in the cabinet door" Page 173)

11.7.1 Exchanging the batteries behind the cooling duct

Procedure

1. Shut down the robot controller by means of the main menu item **Shut-down**. [Further information is contained in the operating and programming instructions for the KUKA System Software.]
2. Turn off the robot controller and take measures to prevent it from being turned on again unintentionally.
3. Disconnect the power cable from the supply.

⚠ WARNING Cables routed from power supply connection X1 to the main switch are energized even when the main switch is switched off! This mains voltage can cause injuries on contact.

4. Remove the fastening screws of the cooling duct with a 7 mm socket wrench. Lift the cooling duct out vertically.

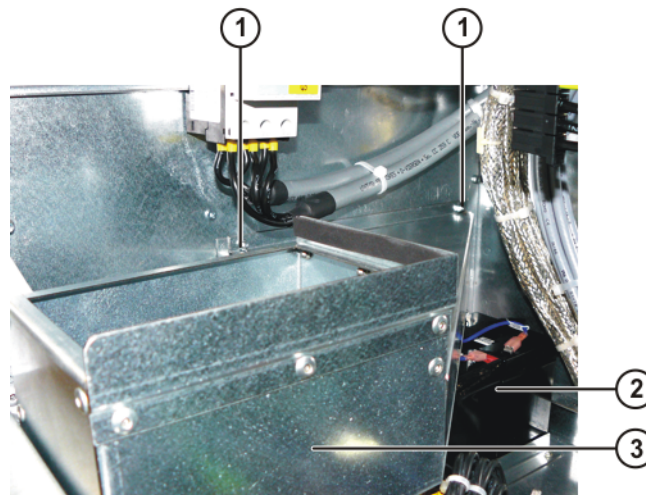

Fig. 11-29: Removing the cooling duct

- 1 Cooling duct fastening screws
 - 2 Batteries
 - 3 Cooling duct
5. Unplug the battery connection cables.

⚠ WARNING

A short-circuit or short to ground at the battery poles causes a very high short-circuit current. This short-circuit current can cause severe injury and substantial damage to property. It must be ensured that no short-circuit or short to ground is caused at the battery poles.

⚠ WARNING

A short-circuit or short to ground at the battery poles can trip the higher-level fuse. The batteries have no fuse of their own. It must be ensured that no short-circuit or short to ground is caused at the battery poles.

6. Remove the Velcro strip.

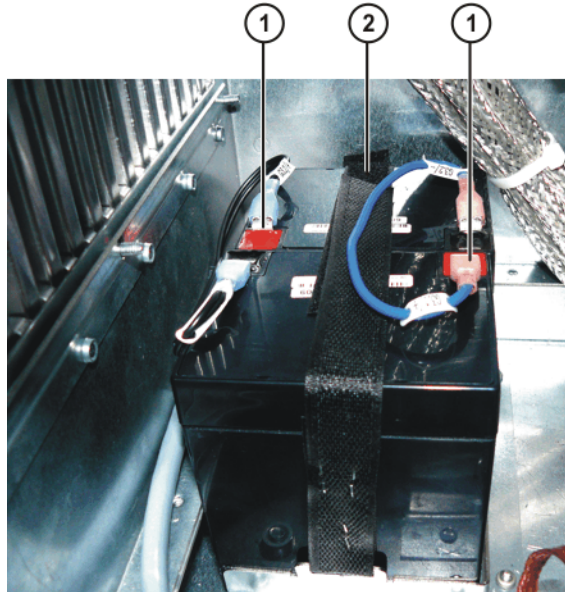

Fig. 11-30: Fastening and connections of the batteries

- 1 Battery connection cables
 - 2 Velcro strip
7. Take out both battery blocks.



The battery blocks must both be exchanged together.

8. Insert the new battery blocks and plug in the battery connection cables.

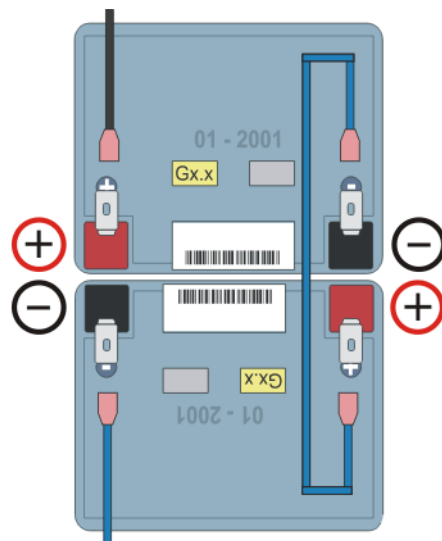

Fig. 11-31: Battery polarity

WARNING Observe the illustrated battery polarity. Installing the batteries in the wrong position or with reversed polarity can generate a high short-circuit current and trip the higher-level fuse.

9. Fasten the battery blocks with the Velcro strip.
10. Install the cooling duct and screw it firmly in place.

Storage

NOTICE To prevent exhaustive discharge and thus destruction of the batteries, the batteries must be recharged at regular intervals according to the storage temperature.

If the storage temperature is +20 °C or lower, the batteries must be recharged every 9 months.

If the storage temperature is between +20 °C and +30 °C, the batteries must be recharged every 6 months.

If the storage temperature is between +30 °C and +40 °C, the batteries must be recharged every 3 months.

11.7.2 Exchanging the batteries in the cabinet door

Procedure

1. Shut down the robot controller by means of the main menu item **Shut-down**. [Further information is contained in the operating and programming instructions for the KUKA System Software.]
2. Turn off the robot controller and take measures to prevent it from being turned on again unintentionally.
3. Disconnect the power cable from the supply.

WARNING Cables routed from power supply connection X1 to the main switch are energized even when the main switch is switched off! This mains voltage can cause injuries on contact.

4. Unplug the battery connection cables.

WARNING A short-circuit or short to ground at the battery poles causes a very high short-circuit current. This short-circuit current can cause severe injury and substantial damage to property. It must be ensured that no short-circuit or short to ground is caused at the battery poles.

⚠ WARNING A short-circuit or short to ground at the battery poles can trip the higher-level fuse. The batteries have no fuse of their own. It must be ensured that no short-circuit or short to ground is caused at the battery poles.

5. Remove both battery blocks from the battery holder in the cabinet door.

i The battery blocks must both be exchanged together.

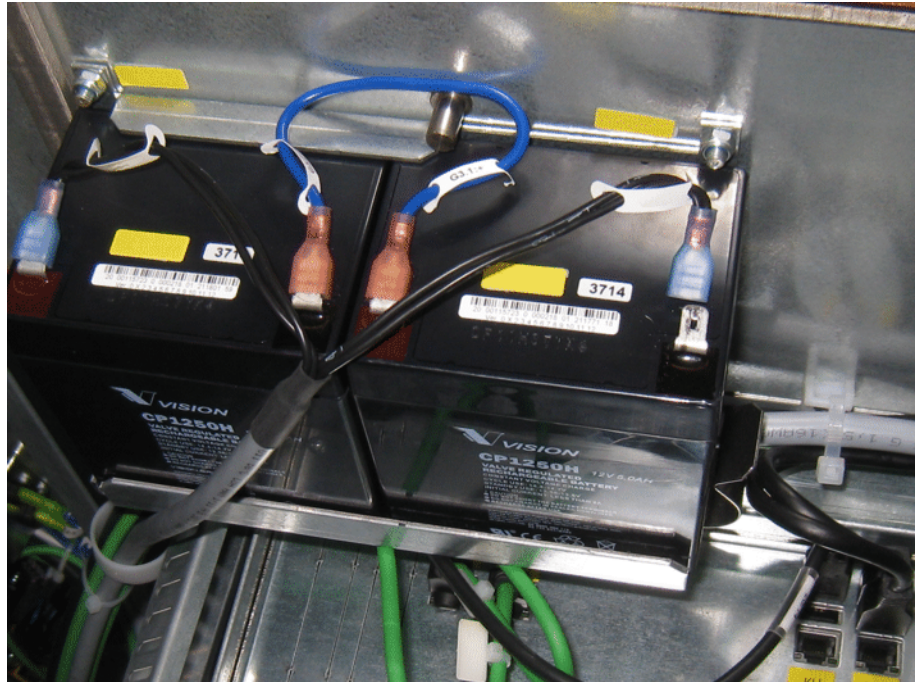

Fig. 11-32: Battery fastening in the cabinet door

6. Insert the new battery blocks and plug in the battery connection cables.

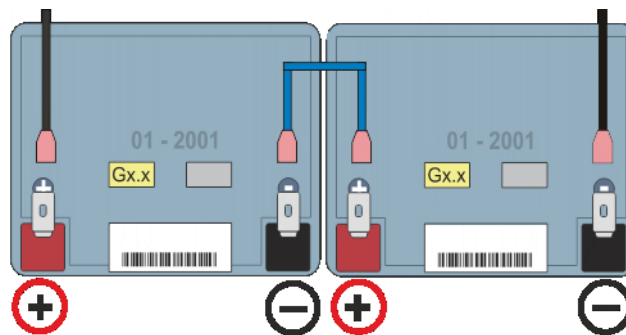

Fig. 11-33: Battery polarity

⚠ WARNING Observe the illustrated battery polarity. Installing the batteries in the wrong position or with reversed polarity can generate a high short-circuit current and trip the higher-level fuse.

11.8 Exchanging the low-voltage power supply unit

Precondition

- Robot controller is shut down.
- The robot controller is switched off and secured to prevent unauthorized persons from switching it on again.
- The power cable is de-energized.

⚠ WARNING Cables routed from power supply connection X1 to the main switch are energized even when the main switch is switched off! This mains voltage can cause injuries on contact.

Procedure

1. Remove the rear panel.
2. Unplug the connections.
3. Loosen the fastening screws.
4. Tilt the low-voltage power supply unit forward and lift it out vertically.

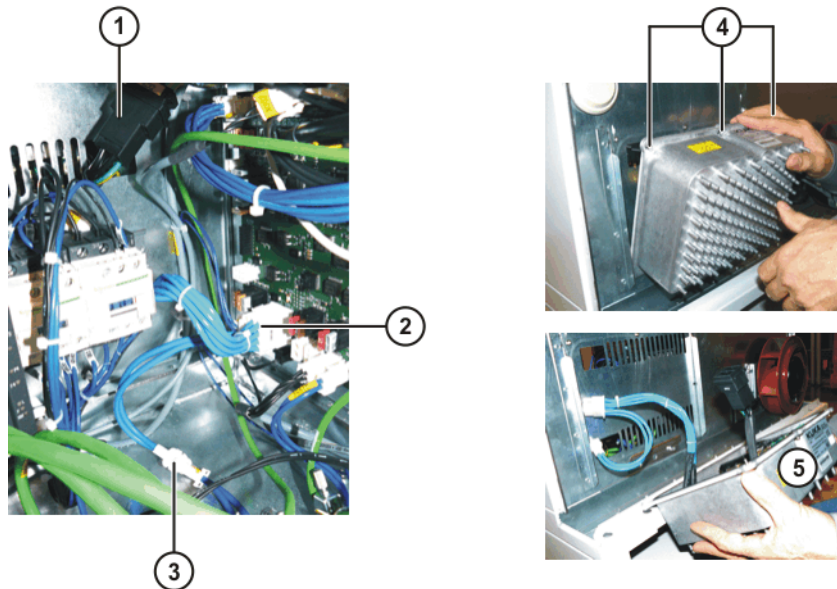

Fig. 11-34: Low-voltage power supply unit

- | | |
|---------------------------------|---|
| 1 Power supply connector X2 | 4 Fastening screws |
| 2 CCU power infeed connector X1 | 5 Low-voltage power supply unit removed |
| 3 XPE connector | |

5. Insert and fasten the new low-voltage power supply unit.
6. Plug in the connectors; insert and fasten the rear panel.

11.9 Exchanging the pressure relief plug

Description The pressure relief plug is used to generate an overpressure inside the cabinet. This prevents excessive fouling of the cabinet.

- Preconditions**
- The robot controller must be switched off and secured to prevent unauthorized persons from switching it on again.
 - The power cable must be de-energized.

⚠ WARNING Cables routed from power supply connection X1 to the main switch are energized even when the main switch is switched off! This mains voltage can cause injuries on contact.

- Observe the ESD guidelines.

Procedure

1. Remove the foam ring.
2. Exchange the filter insert.
3. Insert the foam ring so that it is flush with the pressure relief plug.

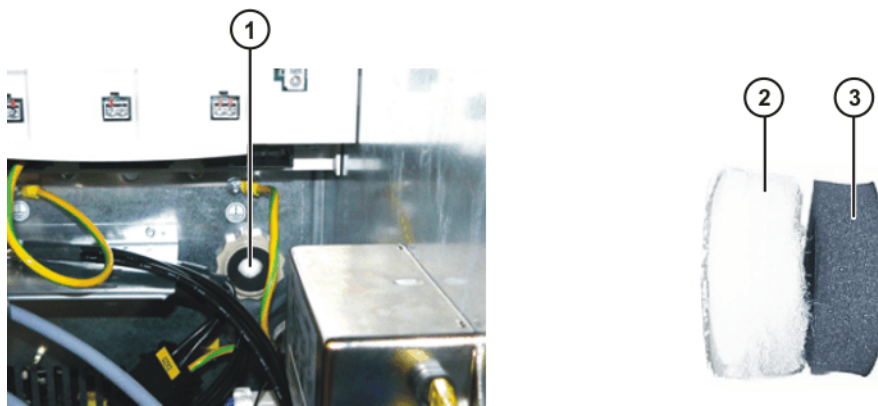

Fig. 11-35: Exchanging the pressure relief plug

- | | | | |
|---|----------------------|---|-----------|
| 1 | Pressure relief plug | 3 | Foam ring |
| 2 | Filter insert | | |

11.10 Installing the KUKA System Software (KSS)



Further information is contained in the operating and programming instructions for the KUKA System Software (KSS).

12 Troubleshooting

12.1 Cabinet Control Unit LED display

Overview

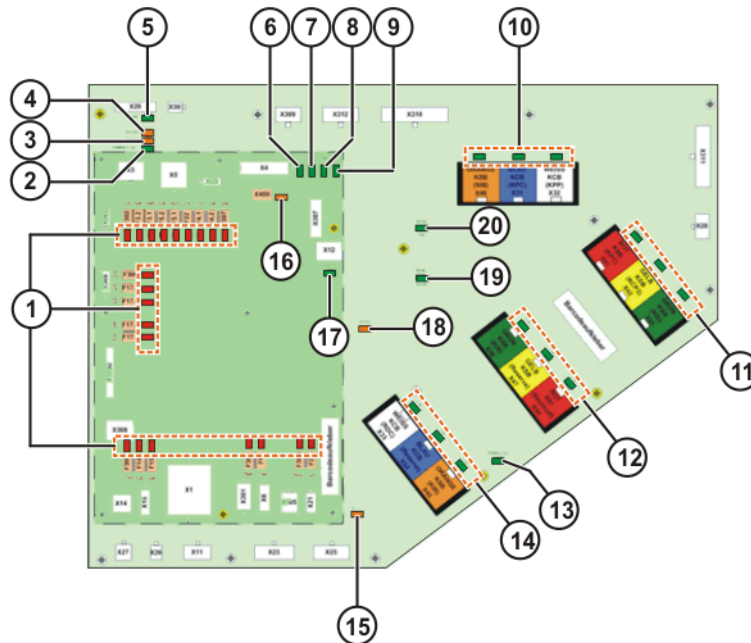

Fig. 12-1: CCU LED display

Item	Designation	Color	Description	Remedy
1	Fuse LEDs The LEDs indicate the status of the fuses.	Red	On = fuse defective	Exchange defective fuse
			Off = fuse OK	-
2	PWRS/3.3V	Green	On = power supply present	-
			Off = no supply voltage present	<ul style="list-style-type: none"> ■ Check fuse F17.3 ■ If the LED PWR/3.3V lights up, exchange the CCU module
3	STAS2 Safety node B	Orange	Off = no supply voltage present	<ul style="list-style-type: none"> ■ Check fuse F17.3 ■ If the LED PWR/3.3V lights up, exchange the CCU module
			Flashing at 1 Hz = normal state	-
			Flashing at 10 Hz = boot phase	-
			Flashing = fault code (internal)	Check cabling at X309, X310, X312. For test purposes, disconnect the cables at X309, X310, X312 and switch the controller off and back on again. If the error recurs, exchange the module.

Item	Designation	Color	Description	Remedy
4	STAS1 Safety node A	Orange	Off = no supply voltage present	<ul style="list-style-type: none"> ■ Check fuse F17.3 ■ If the LED PWR/3.3V lights up, exchange the CCU module
			Flashing at 1 Hz = normal state	-
			Flashing at 10 Hz = boot phase	-
			Flashing = fault code (internal)	Check cabling at X309, X310, X312. For test purposes, disconnect the cables at X309, X310, X312 and switch the controller off and back on again. If the error recurs, exchange the module.
5	FSoE Safety protocol of the EtherCat connection	Green	Off = not active	-
			On = operational	-
			Flashing = fault code (internal)	-
6	27 V Voltage, main power supply unit, without battery backup	Green	Off = no supply voltage present	Check infeed at X1 (rated voltage 27.1 V)
			On = power supply present	-
7	PS1 Voltage, Power Supply 1 (short battery backup)	Green	Off = no supply voltage present	<ul style="list-style-type: none"> ■ Check infeed at X1 (rated voltage 27.1 V) ■ Drive bus switched off (BusPowerOff state)
			On = power supply present	-
8	PS2 Voltage, Power Supply 2 (medium battery backup)	Green	Off = no supply voltage present	<ul style="list-style-type: none"> ■ Check infeed at X1. ■ Controller in Sleep state
			On = power supply present	-
9	PS3 Voltage, Power Supply 3 (long battery backup)	Green	Off = no supply voltage present	Check infeed at X1.
			On = power supply present	-

Item	Designation	Color	Description	Remedy
10	L/A KSB (SIB)	Green	<ul style="list-style-type: none"> ■ On = physical connection. Network cable plugged in ■ Off = no physical connection. Network cable not plugged in ■ Flashing = data traffic on the line 	-
	L/A KCB (KPC)	Green		
	L/A KCB (KPP)	Green		
11	L/A	Green		
	L/A	Green		
	L/A	Green		
12	L/A	Green		
	L/A	Green		
	L/A	Green		
13	PWR/3.3V Power for the CIB	Green	Off = no supply voltage present	<ul style="list-style-type: none"> ■ Check fuse F17.3 ■ Jumper plug X308 present ■ Check fuse F308 ■ In the case of external supply via X308: check external supply voltage (rated voltage 24 V)
	On = supply voltage present		-	
14	L/A	Green	<ul style="list-style-type: none"> ■ On = physical connection ■ Off = no physical connection. Network cable not plugged in. ■ Flashing = data traffic on the line 	-
	L/A	Green		
	L/A	Green		
15	STA1 (CIB) µC I/O node	Orange	Off = no supply voltage present	<ul style="list-style-type: none"> ■ Check fuse F17.3 ■ If the LED PWR/3.3V lights up, exchange the CCU module
			Flashing at 1 Hz = normal state	-
			Flashing at 10 Hz = boot phase	-
			Flashing = fault code (internal)	Exchange CCU module
16	STA1 (PMB) µC USB	Orange	Off = no supply voltage present	<ul style="list-style-type: none"> ■ Check infeed at X1 ■ If the LED PWR/5V lights up, exchange the CCU module
			Flashing at 1 Hz = normal state	-
			Flashing at 10 Hz = boot phase	-
			Flashing = fault code (internal)	Exchange CCU module

Item	Designation	Color	Description	Remedy
17	PWR/5V Power supply for PMB	Green	Off = no supply voltage present	Check infeed at X1 (rated voltage 27.1 V)
			Flashing at 1 Hz = normal state	-
			Flashing at 10 Hz = boot phase	-
			Flashing = fault code (internal)	-
18	STA2 FPGA node	Orange	Off = no supply voltage present	<ul style="list-style-type: none"> ■ Check infeed at X1 ■ If the LED PWR/3.3V lights up, exchange the CCU module
			Flashing at 1 Hz = normal state	-
			Flashing at 10 Hz = boot phase	-
			Flashing = fault code (internal)	Exchange CCU module
19	RUN SION EtherCat Safety nodes	Green	On = operational (normal state)	-
			Off = Init (after switching on)	-
			Flashing at 2.5 Hz = Pre-Op (intermediate state on startup)	-
			Single signal = Safe Op	-
			Flashing at 10 Hz = boot (for firmware update)	-
20	RUN CIB EtherCat ATμC I/O node	Green	On = operational (normal state)	-
			Off = Init (after switching on)	-
			Flashing at 2.5 Hz = Pre-Op (intermediate state on startup)	-
			Single signal = Safe Op	-
			10 Hz = boot (for firmware update)	-

12.2 Cabinet Control Unit fusing

Overview

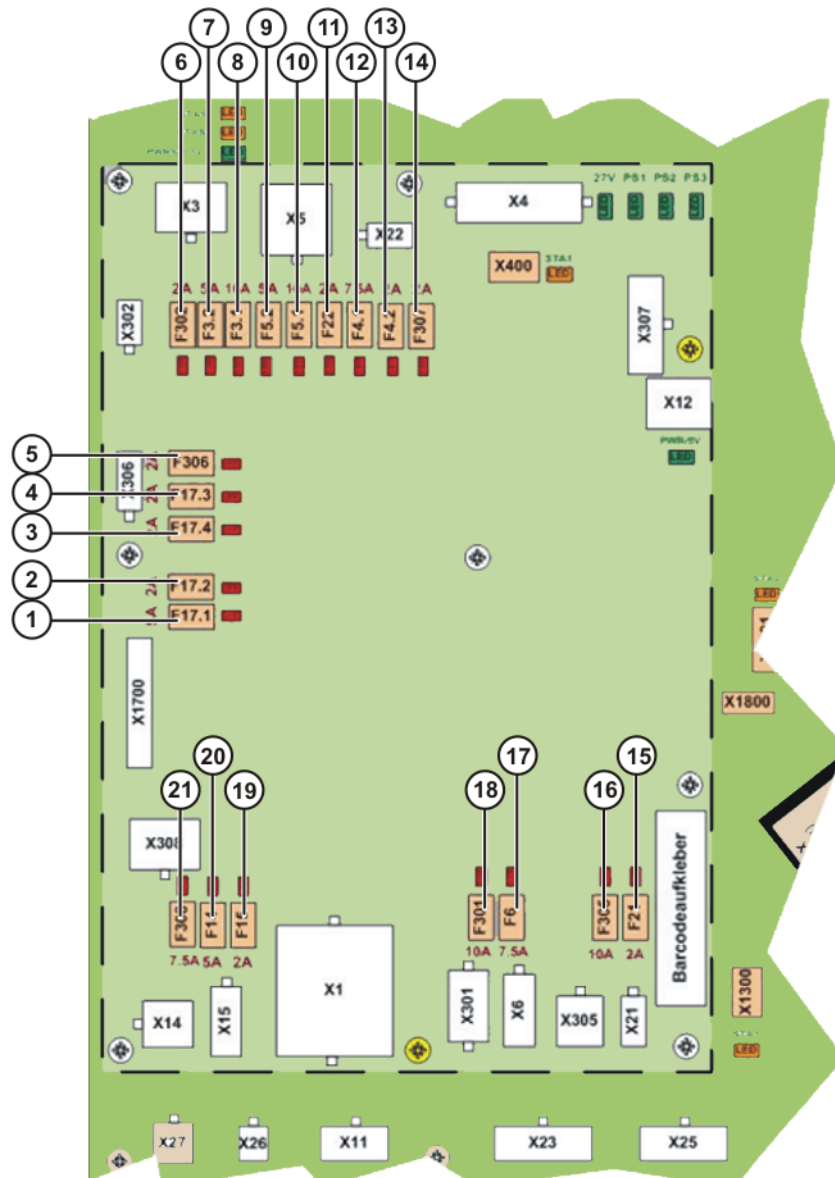

Fig. 12-2: Arrangement of the fuses



A defective fuse is indicated by a red LED next to the fuse. Once the cause of the fault has been eliminated, defective fuses must be replaced with fuses with the value specified in the operating instructions or printed on the module.

Item	Designation	Description	Fusing
1	F17.1	Contactors outputs 1 ... 4 CCU	5 A
2	F17.2	CCU inputs	2 A
3	F17.4	CCU safe inputs	2 A
4	F17.3	CCU logic	2 A
5	F306	smartPAD power supply	2 A
6	F302	SIB power supply	5 A
7	F3.2	KPP1 logic with battery backup	7.5 A
8	F3.1	KPP1 brakes without battery backup	15 A

Item	Designation	Description	Fusing
9	F5.2	KPP2 logic without battery backup/switch	7.5 A
10	F5.1	KPP2 brakes without battery backup	15 A
11	F22	Options power supply with battery backup	7.5 A
12	F4.1	KPC with battery backup	10 A
13	F4.2	KPC fan/internal fan with battery backup	2 A
14	F307	CSP power supply	2 A
15	F21	RDC power supply	2 A
16	F305	Battery infeed	15 A
17	F6	24 V without battery backup US1 (optional)	7.5 A
18	F301	24 V without battery backup, spare, US2	10 A
19	F15	Internal fan (optional)	2 A
20	F14	External fan	7.5 A
21	F308	Internal power supply, external infeed with battery backup	7.5 A

12.3 Resolver Digital Converter LED display

Overview

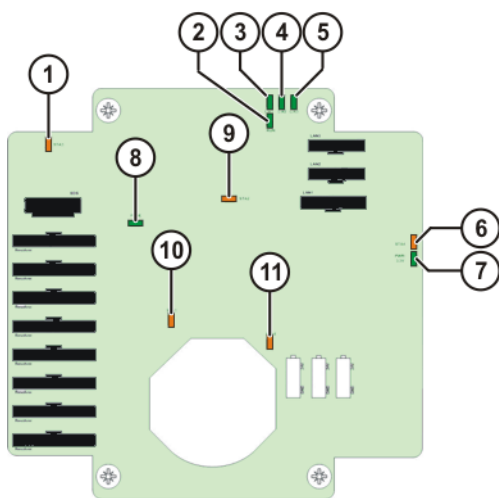

Fig. 12-3: RDC LED display

Item	Designation	Color	Description
1	STA3 Motor temperature micro-controller	Yellow	<ul style="list-style-type: none"> ■ Off = fault ■ Flashing at 1 Hz = normal state ■ Flashing = fault code (internal)
2	RUN EtherCAT AT bus	Green	<ul style="list-style-type: none"> ■ Off = Init ■ On = normal state ■ Flashing at 2.5 Hz = Pre-Op ■ Single signal = Safe Op ■ Flashing = fault code (internal) ■ Flashing at 10 Hz = boot

Item	Designation	Color	Description
3	L/A1 Input of the KCB (X18)	Green	<ul style="list-style-type: none"> ■ Off = no physical connection. Network cable not plugged in. ■ On = network cable plugged in ■ Flashing = data traffic on the line
4	L/A2 Output of the KCB (X19)	Green	<ul style="list-style-type: none"> ■ Off = no physical connection. Network cable not plugged in. ■ On = network cable plugged in ■ Flashing = data traffic on the line
5	L/A3 Output of the KCB to the EMD (X20)	Green	<ul style="list-style-type: none"> ■ Off = no physical connection. Network cable not plugged in. ■ On = network cable plugged in ■ Flashing = data traffic on the line
6	STA4 VMT microcontroller	Yellow	<ul style="list-style-type: none"> ■ Off = fault ■ Flashing at 1 Hz = normal state ■ Flashing = fault code (internal)
7	PWR/3.3V RDC power supply	Green	<ul style="list-style-type: none"> ■ Off = no power ■ On = power supply connected
8	FSOE Safety protocol of the EtherCat connection	Green	<ul style="list-style-type: none"> ■ Off = not active ■ On = operational ■ Flashing = fault code (internal)
9	STA2 FPGA B integrated circuit	Yellow	<ul style="list-style-type: none"> ■ Off = fault ■ Flashing at 1 Hz = normal state ■ Flashing = fault code (internal)
10	STA1 FPGA A integrated circuit	Yellow	<ul style="list-style-type: none"> ■ Off = fault ■ Flashing at 1 Hz = normal state ■ Flashing = fault code (internal)
11	STA0 configuration microcontroller	Yellow	<ul style="list-style-type: none"> ■ Off = fault ■ Flashing at 1 Hz = normal state ■ Flashing = fault code (internal)

12.4 Controller System Panel LED display

Overview

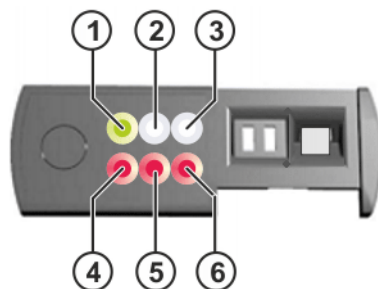



Fig. 12-4

Item	Designation	Description
1	LED1	Operating LED
2	LED2	Sleep LED
3	LED3	Automatic LED
4	LED4	Error LED

Item	Designation	Description
5	LED5	Error LED
6	LED6	Error LED



Controller state

Display	Description	State
	LED1 flashes slowly LED2...LED6 = off Main switch = on	Controller boots
	LED1 flashes slowly LED2...LED6 = off Main switch = on PM service started	HMI not yet loaded and/or RTS not "RUNNING"
	LED1 = on LED3 = any LED2; LED4...LED6 = off Booting completed, no error	SM in "Running" state, HMI and Cross running
	LED1 = on LED3 = any LED2; LED4...LED6 = off Main switch = off Powerfail timeout not yet occurred	Controller does not yet shut down
	LED1 flashes slowly LED2...LED6 = off Main switch = off Powerfail timeout has occurred	Controller shuts down
	LED1 flashes slowly LED2...LED6 = off SoftPowerDown	Controller shuts down



CSP test

Display	Description
	If all LEDs light up for 3 s after the CSP is switched on, it is working correctly

Automatic mode

Display	Description
	LED1 = on LED3 = on Controller is in Automatic mode
	LED1 = on Controller is not in Automatic mode

Sleep mode

Display	Description
	LED2 flashes slowly Controller is in Sleep mode.
	LED1 flashes slowly Controller is coming out of Sleep mode.





ProfiNet ping

Display	Description
	LED1 = on LED4 flashes slowly LED5 flashes slowly LED6 flashes slowly ProfiNet ping is being executed

Maintenance

Display	Description
	LED1 = on LED4 flashes slowly LED2; LED3; LED5; LED6 = off Maintenance mode active (robot controller maintenance due)

12.4.1 Controller System Panel LED error display**Error states**

Display	Description	Remedy
	LED1 flashes slowly LED4 = on Problem with boot device or BIOS error	<ul style="list-style-type: none"> ■ Check the HDD/SSD ■ Check the USB stick ■ Exchange the PC
	LED1 flashes slowly LED5 = on Timeout booting Windows or starting the PMS	<ul style="list-style-type: none"> ■ Exchange the hard drive ■ Reload the image
	LED1 flashes slowly LED6 = on Timeout waiting for RTS "RUNNING"	<ul style="list-style-type: none"> ■ Reload the image ■ Run setup
	LED1 flashes slowly Timeout waiting for HMI Ready	-

12.5 Control PC interfaces**Motherboards**

The following motherboard variants can be installed in the control PC:

- D2608-K
- D3076-K
- D3236-K

12.5.1 LAN Onboard LED display on motherboard D2608-K

Overview

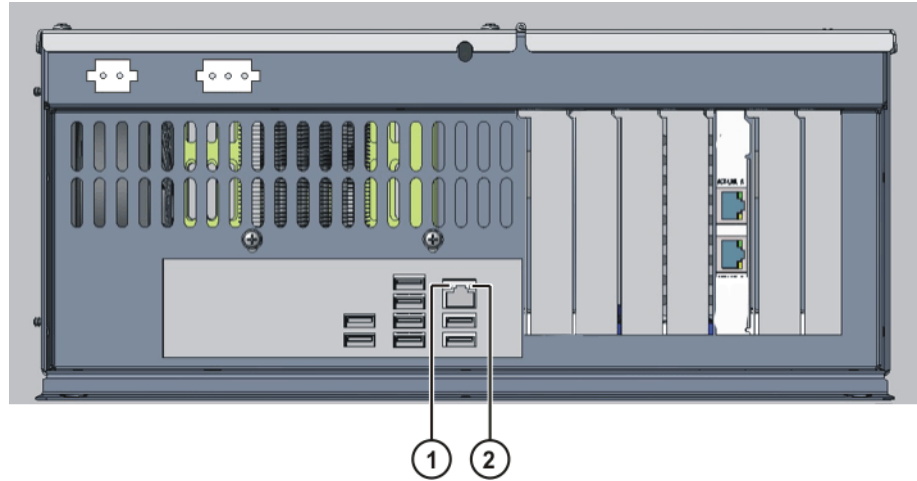

Fig. 12-5: LAN Onboard LED display

Item	Designation	Color	Description
1	Activity/Link	Green	<ul style="list-style-type: none"> ■ Off = no connection ■ On = connection established ■ Flashing = connection active
2	Speed	Yellow/ green	<ul style="list-style-type: none"> ■ Off = 10 Mb ■ Green = 100 Mb ■ Yellow = 1000 Mb

12.5.2 LAN Onboard LED display on motherboard D3076-K

Overview

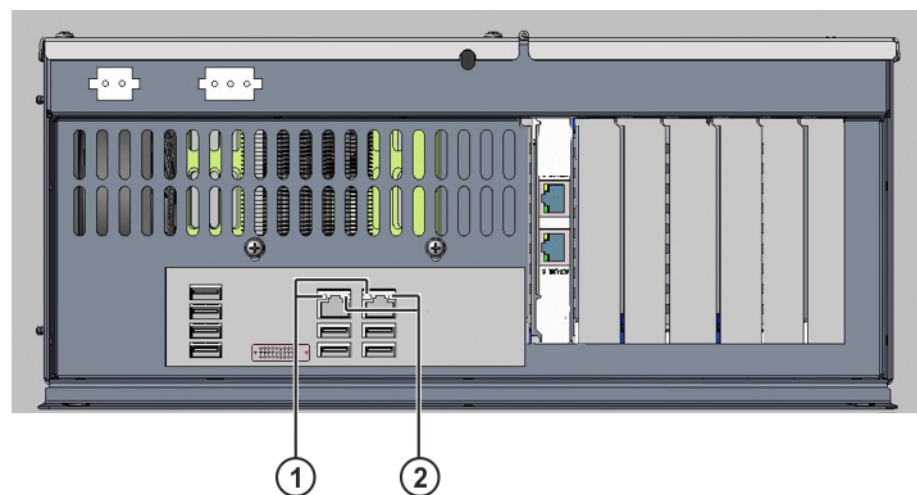

Fig. 12-6: LAN Onboard LED display

Item	Designation	Color	Description
1	Activity/Link	Green	<ul style="list-style-type: none"> ■ Off = no connection ■ On = connection established ■ Flashing = connection active
2	Speed	Yellow/ green	<ul style="list-style-type: none"> ■ Off = 10 Mb ■ Green = 100 Mb ■ Yellow = 1000 Mb

12.5.3 LAN Onboard LED display on motherboard D3236-K

Overview

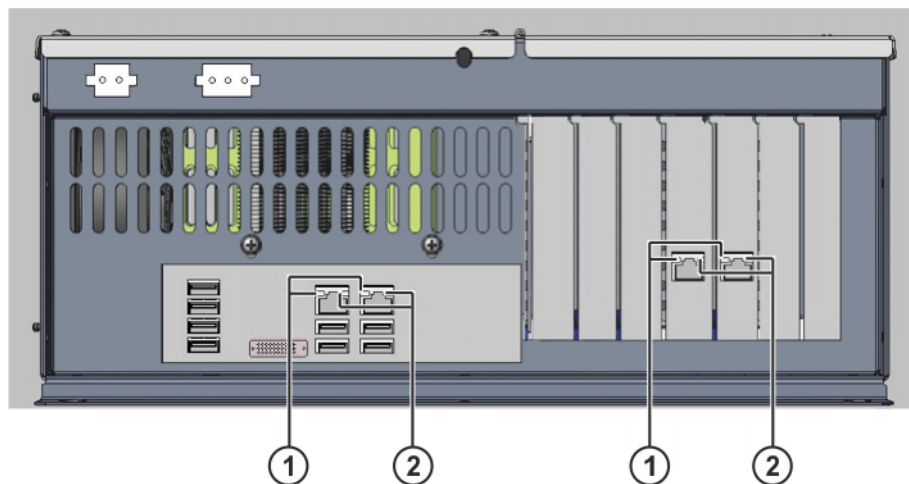

Fig. 12-7: LAN Onboard LED display

Item	Designation	Color	Description
1	Activity/Link	Green	<ul style="list-style-type: none"> ■ Off = no connection ■ On = connection established ■ Flashing = connection active
2	Speed	Yellow/ green	<ul style="list-style-type: none"> ■ Off = 10 Mb ■ Green = 100 Mb ■ Yellow = 1000 Mb

12.6 Safety Interface Board LED display

Standard

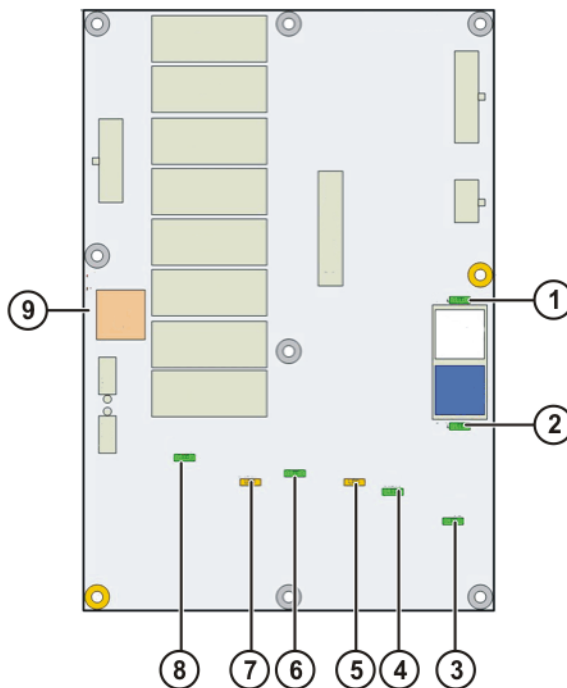

Fig. 12-8: Standard SIB LED display

Item	Designation	Color	Description	Remedy
1	L/A	Green	<ul style="list-style-type: none"> ■ On = physical connection ■ Off = no physical connection. Network cable not plugged in. ■ Flashing = data traffic on the line 	-
2	L/A	Green		-
3	PWR_3V3 Power for the SIB	Green		Off = no supply voltage present
			On = supply voltage present	-
4	RUN EtherCat Safety nodes	Green	On = operational (normal state)	-
			Off = Init (after switching on)	-
			Flashing at 2.5 Hz = Pre-Op (intermediate state on startup)	-
			Single signal = Safe Op	-
			Flashing at 10 Hz = boot (for firmware update)	-

Item	Designation	Color	Description	Remedy
5	STAS2 Safety node B	Orange	Off = no supply voltage present	<ul style="list-style-type: none"> ■ Check fuse F302 ■ If the LED PWR_3V3 lights up, exchange the SIB board
			Flashing at 1 Hz = normal state	-
			Flashing at 10 Hz = boot phase	-
			Flashing = fault code (internal)	-
6	FSoE Safety protocol of the EtherCat connection	Green	Off = not active	-
			On = operational	-
			Flashing = fault code (internal)	-
7	STAS1 Safety node A	Orange	Off = no supply voltage present	<ul style="list-style-type: none"> ■ Check fuse F302 ■ If the LED PWR_3V3 lights up, exchange the SIB board
			Flashing at 1 Hz = normal state	-
			Flashing at 10 Hz = boot phase	-
			Flashing = fault code (internal)	-
8	PWRS 3.3V	Green	On = supply voltage present	-
			Off = no supply voltage present	<ul style="list-style-type: none"> ■ Check fuse F302 ■ If the LED PWR_3V3 lights up, exchange the SIB board
9	Fuse LED The LED indicates the status of the fuse	Red	On = fuse defective	Exchange defective fuse
			Off = fuse OK	-

Extended

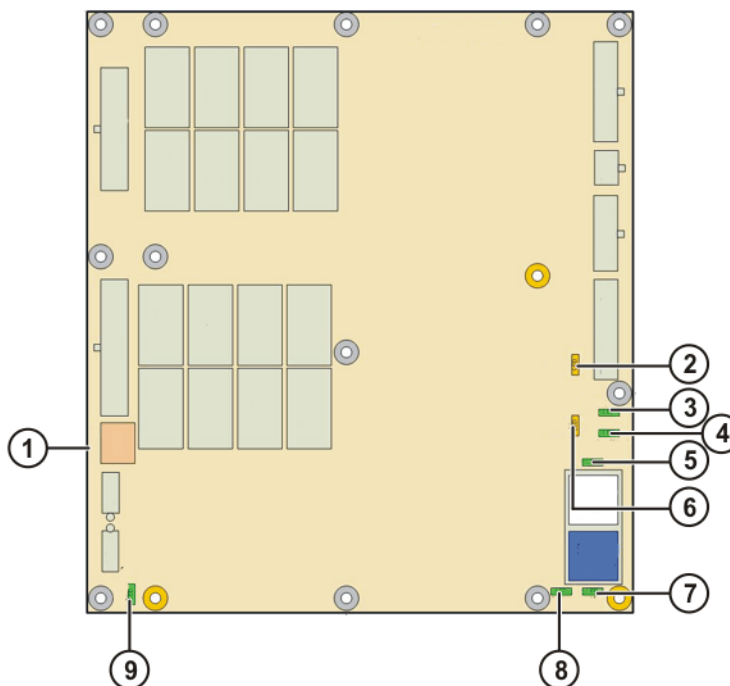

Fig. 12-9: Extended SIB LED display

Item	Designation	Color	Description	Remedy
1	Fuse LED The LED indicates the status of the fuse	Red	On = fuse defective	Exchange defective fuse
			Off = fuse OK	-
2	STAS1 Safety node A	Orange	Off = no supply voltage present	<ul style="list-style-type: none"> ■ Check fuse F302 ■ If the LED PWR +3V3 lights up, exchange the SIB board
			Flashing at 1 Hz = normal state	-
			Flashing at 10 Hz = boot phase	-
			Flashing = fault code (internal)	-
3	FSoE Safety protocol of the EtherCat connection	Green	Off = not active	-
			On = operational	-
			Flashing = fault code (internal)	-
4	PWRS_+3V3 V	Green	On = supply voltage present	-
			Off = no supply voltage present	<ul style="list-style-type: none"> ■ Check fuse F302 ■ If the LED PWR +3V3 lights up, exchange the SIB board

Item	Designation	Color	Description	Remedy
5	L/A	Green	<ul style="list-style-type: none"> ■ On = physical connection ■ Off = no physical connection. Network cable not plugged in. ■ Flashing = data traffic on the line 	-
6	STAS2 Safety node B	Orange	Off = no supply voltage present	<ul style="list-style-type: none"> ■ Check fuse F302 ■ If the LED PWR +3V3 lights up, exchange the SIB board
			Flashing at 1 Hz = normal state	-
			Flashing at 10 Hz = boot phase	-
			Flashing = fault code (internal)	-
7	L/A	Green	<ul style="list-style-type: none"> ■ On = physical connection ■ Off = no physical connection. Network cable not plugged in. ■ Flashing = data traffic on the line 	-
8	RUN EtherCat Safety nodes	Green	On = operational (normal state)	-
			Off = Init (after switching on)	-
			Flashing at 2.5 Hz = Pre-Op (intermediate state on startup)	-
			Single signal = Safe Op	-
			Flashing at 10 Hz = boot (for firmware update)	-
9	PWR +3V3 Power for the SIB	Green	Off = no supply voltage present	<ul style="list-style-type: none"> ■ Check fuse F260 ■ Jumper plug X308 present
			On = supply voltage present	-

12.7 Safety Interface Board fuses

Semiconductor fuse

Every output channel is fitted with self-resetting semiconductor fuses to guard against short-circuits.

To reset the semiconductor fuse, the following steps are to be carried out:

- Eliminate the cause of the error
- De-energize the semiconductor fuse for 5 s



The semiconductor fuses are not rated for frequent use and should not be tripped intentionally, as this will reduce their service life.

Standard SIB

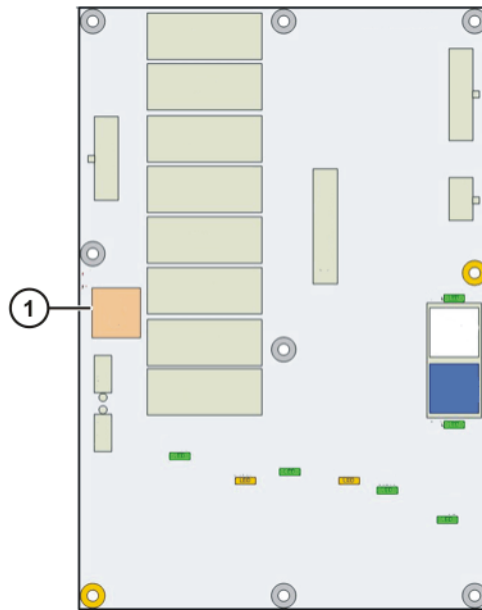

Fig. 12-10: Standard SIB fuse

i A defective fuse is indicated by a red LED next to the fuse. Once the cause of the fault has been eliminated, defective fuses must be replaced with fuses with the value specified in the operating instructions or printed on the module.

Item	Designation	Description	Fusing
1	F250	Test signal power supply, safe inputs and relay activation	4 A

Extended SIB

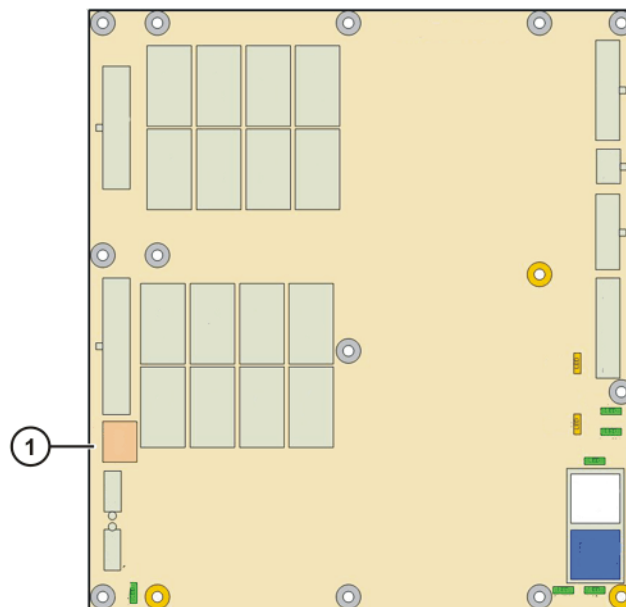

Fig. 12-11: Extended SIB fuse

i A defective fuse is indicated by a red LED next to the fuse. Once the cause of the fault has been eliminated, defective fuses must be replaced with fuses with the value specified in the operating instructions or printed on the module.

Item	Designation	Description	Fusing
1	F260	Test signal power supply, safe inputs and relay activation	4 A

12.8 Checking the KUKA Servo Pack

Description The KSP LED display consists of the following LED groups:

- KSP device status
- Axis control
- Communication status

If faults occur during the initialization phase, the middle axis control LEDs flash. All other LEDs are off. The red axis control LED is lit continuously and the green axis control LED flashes at 2 to 16 Hz, followed by a pause.

If defective firmware is detected during the initialization phase, the red device status LED is lit and the green device status LED is dimmed.

Precondition

⚠ WARNING The robot controller is energized (50-600 V) when it is switched on. This voltage can cause life-threatening injuries on contact. Work and measurements on the electrical equipment may only be carried out by specially trained personnel.

Procedure

1. Check communication status LED group.
2. Check KSP device status LED group.
3. Check axis control LED group.

Overview

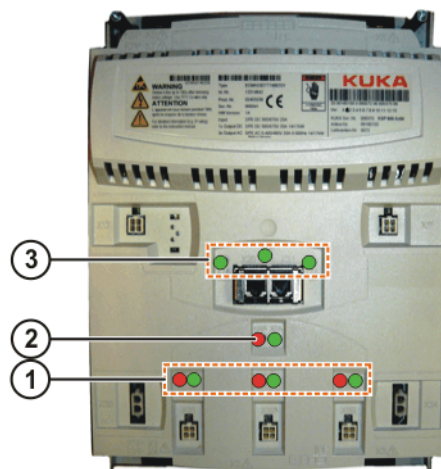

Fig. 12-12: KSP LED display

- | | |
|--|--|
| <p>1 LED group: axis control</p> <p>2 LED group: KSP device status</p> | <p>3 LED group: communication status</p> |
|--|--|

Device status

Red LED	Green LED	Meaning
Off	Off	No power supply to the control electronics
On	Off	Fault in the KSP

Red LED	Green LED	Meaning
Off	Flashing	No communication with the controller
Off	On	Communication with the controller

Axis control

Red LED	Green LED	Meaning
Off	Off	No power supply to the control electronics Axis not present
On	Off	Fault in the axis
Off	Flashing	No servo enable
Off	On	Servo enable

Communication The green communication LEDs indicate the status of the bus connection.

12.9 Checking the KUKA Power Pack

Description

The KPP LED display consists of the following LED groups:

- Power supply
- KPP device status
- Axis control
- Communication status

If faults occur during the initialization phase, the middle axis control LEDs flash. All other LEDs are off. The red axis control LED is lit continuously and the green axis control LED flashes at 2 to 16 Hz, followed by a pause.

If defective firmware is detected during the initialization phase, the red device status LED is lit and the green device status LED is dimmed.

Precondition

WARNING The robot controller is energized (50-600 V) when it is switched on. This voltage can cause life-threatening injuries on contact. Work and measurements on the electrical equipment may only be carried out by specially trained personnel.

Procedure

1. Check power supply LED group.
2. Check communication status LED group.
3. Check KSP device status LED group.
4. Check axis control LED group.

Overview

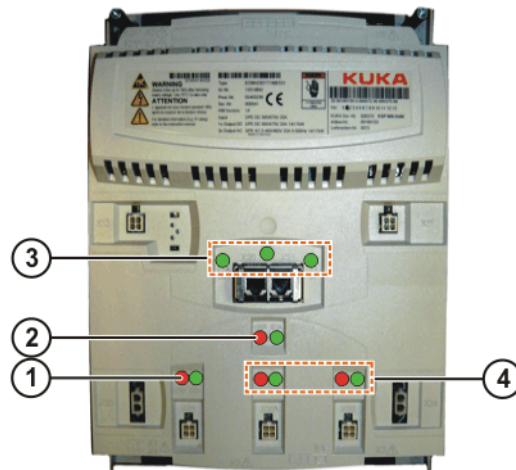

Fig. 12-13: KPP LED display

- | | |
|--------------------------------|-----------------------------------|
| 1 LED group: power supply | 3 LED group: communication status |
| 2 LED group: KPP device status | 4 LED group: axis control |

Power supply

Red LED	Green LED	Meaning
Off	Off	No power supply to the control electronics
On	Off	Fault in the power supply
Off	Flashing	Intermediate circuit voltage out of the permitted range
Off	On	Intermediate circuit voltage within the permitted range

Device status

Red LED	Green LED	Meaning
Off	Off	No power supply to the control electronics
On	Off	Fault in the KPP
Off	Flashing	No communication with the controller
Off	On	Communication with the controller

Axis control

Red LED	Green LED	Meaning
Off	Off	No power supply to the control electronics Axis not present
On	Off	Fault in the axis
Off	Flashing	No servo enable
Off	On	Servo enable

Communication

The green communication LEDs indicate the status of the bus connection:

LED	Description
On	Connected, no data transfer
Flashing	Connected, data transfer
Off	No connection

12.10 Checking the KUKA Power Pack 3

Description The LED display on the KPP indicates the communication status of the bus connection.

Precondition

⚠ WARNING The robot controller is energized (50-600 V) when it is switched on. This voltage can cause life-threatening injuries on contact. Work and measurements on the electrical equipment may only be carried out by specially trained personnel.

Overview

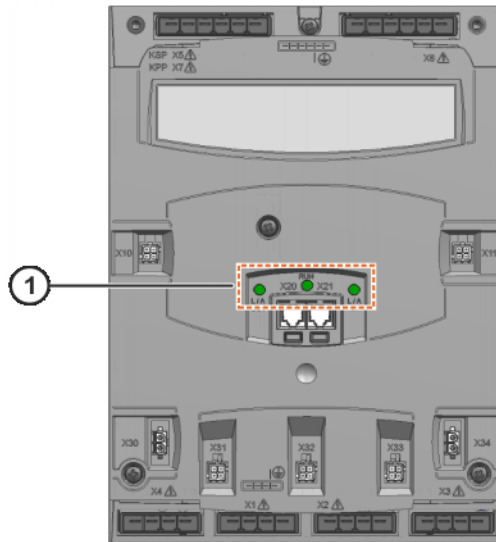

Fig. 12-14: KPP 3x20 A LED display

1 LED group: communication status

Communication The green communication LEDs indicate the status of the bus connection:

LED	Description
On	Connected, no data transfer
Flashing	Connected, data transfer
Off	No connection

12.11 KPP and KSP error messages

Description The error messages have corresponding acknowledgement messages.

- In these messages, %1 stands for the device type (KSP or KPP).
- In these messages, %2 stands for the number of the drive or power supply (KSP or KPP).
- %3 stands for error codes for further differentiation of the cause of the error.

Error no.	Error	Cause	Remedy
26030	Device state: OK	-	-
26031	Internal error, KPP/KSP (axis)	The device has detected an internal error.	<ul style="list-style-type: none"> ■ Reinitialize the drive bus: Power Off / Power On ■ Check KPP (see LEDs)

Error no.	Error	Cause	Remedy
26032	IxT overload error, KPP/KSP (axis)	Axis overloaded	<ul style="list-style-type: none"> ■ During start-up => excessive load in program ■ Reinitialize the drive bus: Power Off / Power On ■ During operation <ul style="list-style-type: none"> ■ Modifications to system ■ Check machine ■ Temperature influences ■ Check trace recording of axis/ current ■ Adapt program velocity ■ Check CBS pressure ■ Check gear unit
		Mean continuous current too high	
		Power	
		Excessive load	
26033	Ground fault, KPP/KSP (axis)	Power unit overcurrent (ground fault)	<ul style="list-style-type: none"> ■ Check motor cable ■ Check motor ■ Reinitialize the drive bus: Power Off / Power On ■ Check KSP ■ Check KPP
26034	Overcurrent, KPP/KSP (axis)	Fault that briefly results in an overcurrent that exceeds the maximum current of the KPP (short-circuit,...)	<ul style="list-style-type: none"> ■ Check trace recording of axis/ current ■ Check motor ■ Check motor cable ■ Reinitialize the drive bus: Power Off / Power On ■ Check KSP ■ Check KPP
26035	Intermediate circuit voltage too high, KPP/KSP (axis)	Overvoltage in intermediate circuit during operation	<ul style="list-style-type: none"> ■ Check trace recording of the intermediate circuit ■ Check mains voltage ■ Check ballast switch ■ Excessive load during braking => reduce ■ Reinitialize the drive bus: Power Off / Power On ■ Check KSP ■ Check KPP
26036	Intermediate circuit voltage too low, KPP/KSP (axis)	Undervoltage in intermediate circuit during operation	<ul style="list-style-type: none"> ■ Check trace recording of the intermediate circuit ■ Check mains voltage ■ Check intermediate circuit cabling ■ Reinitialize the drive bus: Power Off / Power On ■ Check KSP ■ Check KPP charging circuit

Error no.	Error	Cause	Remedy
26037	Logic supply voltage too high, KPP/KSP (axis)	Overvoltage in 27 V supply	<ul style="list-style-type: none"> ■ Check 27 V supply ■ Check power supply to 27 V power supply unit ■ Reinitialize the drive bus: Power Off / Power On ■ Check KSP ■ Check KPP
26038	Logic supply voltage too low, KPP/KSP (axis)	Undervoltage in 27 V supply	<ul style="list-style-type: none"> ■ Check 27 V supply ■ Check power supply to 27 V power supply unit ■ Check battery ■ Reinitialize the drive bus: Power Off / Power On ■ Check KSP ■ Check KPP
26039	Device temperature too high, KPP/KSP (axis)	Overtemperature	<ul style="list-style-type: none"> ■ Check cabinet fan ■ Check ambient temperature ■ Load in program too high, check load ■ Dirt in cooling circuit => clean ■ Check PC fan ■ Reinitialize the drive bus: Power Off / Power On ■ Check KSP ■ Check KPP
26040	Heat sink temperature too high, KPP/KSP (axis)	Overtemperature, heat sink	<ul style="list-style-type: none"> ■ Check cabinet fan ■ Check ambient temperature ■ Load in program too high, check and reduce load ■ Dirt in cooling circuit => clean ■ Check installation site, ventilation slits and clearance ■ Reinitialize the drive bus: Power Off / Power On ■ Check KSP ■ Check KPP
26041	Motor phase failure, KPP/KSP (axis)	Failure of motor phase	<ul style="list-style-type: none"> ■ Check motor cable ■ Check motor ■ Reinitialize the drive bus: Power Off / Power On ■ Check KSP
26042	Communication error, KPP/KSP (axis)	Communication error on the controller bus	<ul style="list-style-type: none"> ■ Reinitialize the drive bus: Power Off / Power On ■ Check EtherCat cabling ■ Check EtherCat stack ■ Check CCU ■ Check KPP ■ Check KSP

Error no.	Error	Cause	Remedy
26043	Unknown status flag received, KPP/KSP (axis)	Software error, Ether-Cat master	-
26044	Unknown device status, KPP/KSP (axis)	-	-
26045	Hardware fault, KPP/KSP (axis)	The device has detected an internal hardware fault.	<ul style="list-style-type: none"> ■ Reinitialize the drive bus: Power Off / Power On ■ Check device (see LEDs) ■ Exchange device
26046	Mains phase failure, KPP/KSP (axis)	Failure of mains phase	<ul style="list-style-type: none"> ■ Check power lead ■ Check KPP cabling ■ Reinitialize the drive bus: Power Off / Power On ■ Check KPP
26047	Power supply failure, KPP/KSP (axis)	Failure, supply voltage below 300 V	<ul style="list-style-type: none"> ■ Check power lead ■ Check KPP cabling ■ Reinitialize the drive bus: Power Off / Power On ■ Check KPP
26048	Overvoltage during charging, KPP/KSP (axis)	-	<ul style="list-style-type: none"> ■ Mains voltage too high ■ Too few capacitors connected (too few modules) ■ Reinitialize the drive bus: Power Off / Power On ■ Check KPP
26050	Fault in brake resistor, KPP/KSP (axis)	KPP has detected an error in the ballast circuit	<ul style="list-style-type: none"> ■ Check ballast resistor ■ Check cabling between KPP and ballast resistor ■ Reinitialize the drive bus: Power Off / Power On ■ Check KPP
26051	Ballast circuit overload, KPP/KSP (axis)	Braking energy permanently too high	<ul style="list-style-type: none"> ■ Reduce heavy loads that are braked too frequently ■ Check ballast resistor ■ Check cabling between KPP and ballast resistor ■ Reinitialize the drive bus: Power Off / Power On ■ Check KPP

Error no.	Error	Cause	Remedy
26130	Intermediate circuit charging failed, KPP/KSP (axis)	-	<ul style="list-style-type: none"> ■ Check intermediate circuit cabling ■ Reinitialize the drive bus: Power Off / Power On ■ Check KSP ■ Check KPP
26132	Collective brake fault, KPP/KSP (axis)	Brake cable monitoring device has signaled short-circuit, overloading or break in connection. / short-circuit / overcurrent / no brake connected	<ul style="list-style-type: none"> ■ Check brake voltage => fault in all axes ■ Check motor / brake (measure) ■ Check brake cable / motor cable ■ Reinitialize the drive bus: Power Off / Power On ■ Check KSP

12.12 KPP and KSP warning messages

Description

The warning messages have corresponding acknowledgement messages.

- In these messages, %1 stands for the device type (KSP or KPP).
- In these messages, %2 stands for the number of the drive or power supply (KSP or KPP).
- %3 stands for error codes for further differentiation of the cause of the error.

Error no.	Warning	Cause	Remedy
26102	Device state: OK	-	-
26103	Internal error, KPP/KSP (axis)	The device has detected an internal error.	<ul style="list-style-type: none"> ■ Reinitialize the drive bus: Power Off / Power On ■ Check KPP (see LEDs)
26104	IxT overload error, KPP/KSP (axis)	Axis overloaded	<ul style="list-style-type: none"> ■ During start-up => excessive load in program ■ Reinitialize the drive bus: Power Off / Power On ■ During operation <ul style="list-style-type: none"> ■ Modifications to system ■ Check machine ■ Temperature influences ■ Check trace recording of axis/ current ■ Adapt program velocity ■ Check CBS pressure ■ Check gear unit
		Mean continuous current too high	
		Power	
		Excessive load	
26105	Ground fault, KPP/KSP (axis)	Power unit overcurrent (ground fault)	<ul style="list-style-type: none"> ■ Check motor cable ■ Check motor ■ Reinitialize the drive bus: Power Off / Power On ■ Check KSP ■ Check KPP

Error no.	Warning	Cause	Remedy
26106	Overcurrent, KPP/KSP (axis)	Fault that briefly results in an overcurrent that exceeds the maximum current of the KPP (short-circuit,...)	<ul style="list-style-type: none"> ■ Check trace recording of axis/ current ■ Check motor ■ Check motor cable ■ Reinitialize the drive bus: Power Off / Power On ■ Check KSP ■ Check KPP
26107	Intermediate circuit voltage too high, KPP/KSP (axis)	Overvoltage in intermediate circuit during operation	<ul style="list-style-type: none"> ■ Check trace recording of the intermediate circuit ■ Check mains voltage ■ Check ballast switch ■ Excessive load during braking => reduce ■ Reinitialize the drive bus: Power Off / Power On ■ Check KSP ■ Check KPP
26108	Intermediate circuit voltage too low, KPP/KSP (axis)	Undervoltage in intermediate circuit during operation	<ul style="list-style-type: none"> ■ Check trace recording of the intermediate circuit ■ Check mains voltage ■ Check intermediate circuit cabling ■ Reinitialize the drive bus: Power Off / Power On ■ Check KSP ■ Check KPP charging circuit
26109	Logic supply voltage too high, KPP/KSP (axis)	Overvoltage in 27 V supply	<ul style="list-style-type: none"> ■ Check 27 V supply ■ Check power supply to 27 V power supply unit ■ Reinitialize the drive bus: Power Off / Power On ■ Check KSP ■ Check KPP
26110	Logic supply voltage too low, KPP/ KSP (axis)	Undervoltage in 27 V supply	<ul style="list-style-type: none"> ■ Check 27 V supply ■ Check power supply to 27 V power supply unit ■ Check battery ■ Reinitialize the drive bus: Power Off / Power On ■ Check KSP ■ Check KPP

Error no.	Warning	Cause	Remedy
26111	Device temperature too high, KPP/KSP (axis)	Overtemperature	<ul style="list-style-type: none"> ■ Check cabinet fan ■ Check ambient temperature ■ Load in program too high, check load ■ Dirt in cooling circuit => clean ■ Check PC fan ■ Reinitialize the drive bus: Power Off / Power On ■ Check KSP ■ Check KPP
26112	Heat sink temperature too high, KPP/KSP (axis)	Overtemperature, heat sink	<ul style="list-style-type: none"> ■ Check cabinet fan ■ Check ambient temperature ■ Load in program too high, check and reduce load ■ Dirt in cooling circuit => clean ■ Check installation site, ventilation slits and clearance ■ Reinitialize the drive bus: Power Off / Power On ■ Check KSP ■ Check KPP
26113	Motor phase failure, KPP/KSP (axis)	Failure of motor phase	<ul style="list-style-type: none"> ■ Check motor cable ■ Check motor ■ Reinitialize the drive bus: Power Off / Power On ■ Check KSP
26114	Communication error, KPP/KSP (axis)	Communication error on the controller bus	<ul style="list-style-type: none"> ■ Reinitialize the drive bus: Power Off / Power On ■ Check EtherCat cabling ■ Check EtherCat stack ■ Check CCU ■ Check KPP ■ Check KSP
26115	Unknown status flag received, KPP/KSP (axis)	Software error, EtherCat master	-
26116	Unknown device status, KPP/KSP (axis)	-	-
26117	Hardware fault, KPP/KSP (axis)	The device has detected an internal hardware fault.	<ul style="list-style-type: none"> ■ Reinitialize the drive bus: Power Off / Power On ■ Check device (see LEDs) ■ Exchange device
26118	Mains phase failure, KPP/KSP (axis)	Failure of mains phase	<ul style="list-style-type: none"> ■ Check power lead ■ Check KPP cabling ■ Reinitialize the drive bus: Power Off / Power On ■ Check KPP

Error no.	Warning	Cause	Remedy
26119	Power supply failure, KPP/KSP (axis)	Failure, supply voltage below 300 V	<ul style="list-style-type: none"> ■ Check power lead ■ Check KPP cabling ■ Reinitialize the drive bus: Power Off / Power On ■ Check KPP
26120	Overvoltage during charging, KPP/KSP (axis)	-	<ul style="list-style-type: none"> ■ Mains voltage too high ■ Too few capacitors connected (too few modules) ■ Reinitialize the drive bus: Power Off / Power On ■ Check KPP ■ Check KSP, improbable
26122	Fault in brake resistor, KPP/KSP (axis)	KPP has detected an error in the ballast circuit	<ul style="list-style-type: none"> ■ Check ballast resistor ■ Check cabling between KPP and ballast resistor ■ Reinitialize the drive bus: Power Off / Power On ■ Check KPP
26123	Ballast circuit overload, KPP/KSP (axis)	Braking energy permanently too high	<ul style="list-style-type: none"> ■ Reduce heavy loads that are braked too frequently ■ Check ballast resistor ■ Check cabling between KPP and ballast resistor ■ Reinitialize the drive bus: Power Off / Power On ■ Check KPP
26131	Intermediate circuit charging failed, KPP/KSP (axis)	-	<ul style="list-style-type: none"> ■ Check intermediate circuit cabling ■ Reinitialize the drive bus: Power Off / Power On ■ Check KSP ■ Check KPP
26133	Collective brake fault, KPP/KSP (axis)	Brake cable monitoring device has signaled short-circuit, overloading or break in connection. / short-circuit / overcurrent / no brake connected	<ul style="list-style-type: none"> ■ Check brake voltage => fault in all axes ■ Check motor / brake (measure) ■ Check brake cable / motor cable ■ Reinitialize the drive bus: Power Off / Power On ■ Check KSP

13 Decommissioning, storage and disposal

13.1 Decommissioning

Description	<p>This section describes all the work required for decommissioning the robot controller if the robot controller is to be removed from the system. After decommissioning, it is prepared for storage or for transportation to a different location.</p> <p>Following its removal, the robot controller may only be transported with lifting tackle and a fork lift truck or pallet truck.</p>
Precondition	<ul style="list-style-type: none"> ■ The removal site must be accessible with a crane or with a fork lift truck for transportation. ■ The crane and fork lift truck have an adequate carrying capacity. ■ There is no hazard posed by system components.
Procedure	<ol style="list-style-type: none"> 1. Release and unplug all peripheral connections. 2. Release and unplug motor cable connector and control cable connector. 3. Disconnect the ground conductor. 4. Prepare the robot controller for storage.

13.2 Storage

Preconditions	<p>If the robot controller is to be put into long-term storage, the following points must be observed:</p> <ul style="list-style-type: none"> ■ The place of storage must be as dry and dust-free as possible. ■ Avoid temperature fluctuations. ■ Avoid wind and drafts. ■ Avoid condensation. ■ Observe and comply with the permissible temperature ranges for storage. (>>> 4 "Technical data" Page 63) ■ Select a storage location in which the packaging materials cannot be damaged. ■ Only store the robot controller indoors.
Procedure	<ol style="list-style-type: none"> 1. Clean robot controller. No dirt may remain on or in the robot controller. 2. Inspect the robot controller, both internally and externally, for damage. 3. Remove batteries and store in accordance with the manufacturer's instructions. 4. Remove any foreign bodies. 5. Remove any corrosion expertly. 6. Attach all covers to the robot controller and check that the seals are correctly in place. 7. Seal off electrical connections with suitable covers. 8. Cover the robot controller with plastic film and seal it against dust. If necessary, add a desiccant beneath the sheeting.

13.3 Disposal

When the robot controller reaches the end of its useful life, it can be dismantled, and the materials can be disposed of properly by type.

The following table provides an overview of the materials used in the robot controller. Some of the plastic components are marked with a material designation and must be disposed of accordingly.



As the end user, the customer is legally required to return depleted batteries. Used batteries can be returned to the vendor or brought to the designated collection points (e.g. in communal refuse collection facilities or commercial centers) free of charge. The batteries can also be sent to the vendor by post.

The following symbols can be found on the batteries:

- Crossed-out garbage can: battery must not be disposed of with ordinary household refuse.



- Pb: battery contains more than 0.004 lead by weight.
- Cd: battery contains more than 0.002 cadmium by weight.
- Hg: battery contains more than 0.0005 mercury by weight.

Material, designation	Subassembly, component	Note
Steel	Screws and washers, robot controller housing	-
PUR	Cable sheaths	-
ETFE	Flexible tube	-
Copper	Electrical cables, wires	-
EPDM	Seals and covers	-
CuZn (gold-plated)	Connectors, contacts	Dispose of without dismantling
Steel (ST 52-3)	Allen screws, washers	-
PE	Cable straps	-
Electrical components	Bus modules, boards, sensors	Dispose of as electrical scrap without disassembling

14 KUKA Service

14.1 Requesting support

Introduction	This documentation provides information on operation and operator control, and provides assistance with troubleshooting. For further assistance, please contact your local KUKA subsidiary.
Information	<p>The following information is required for processing a support request:</p> <ul style="list-style-type: none"> ■ Description of the problem, including information about the duration and frequency of the fault ■ As comprehensive information as possible about the hardware and software components of the overall system <p>The following list gives an indication of the information which is relevant in many cases:</p> <ul style="list-style-type: none"> ■ Model and serial number of the kinematic system, e.g. the manipulator ■ Model and serial number of the controller ■ Model and serial number of the energy supply system ■ Designation and version of the system software ■ Designations and versions of other software components or modifications ■ Diagnostic package KrcDiag: Additionally for KUKA Sunrise: Existing projects including applications For versions of KUKA System Software older than V8: Archive of the software (KrcDiag is not yet available here.) ■ Application used ■ External axes used

14.2 KUKA Customer Support

Availability	KUKA Customer Support is available in many countries. Please do not hesitate to contact us if you have any questions.
Argentina	<p>Ruben Costantini S.A. (Agency) Luis Angel Huergo 13 20 Parque Industrial 2400 San Francisco (CBA) Argentina Tel. +54 3564 421033 Fax +54 3564 428877 ventas@costantini-sa.com</p>
Australia	<p>KUKA Robotics Australia Pty Ltd 45 Fennell Street Port Melbourne VIC 3207 Australia Tel. +61 3 9939 9656 info@kuka-robotics.com.au www.kuka-robotics.com.au</p>

Belgium	KUKA Automatisering + Robots N.V. Centrum Zuid 1031 3530 Houthalen Belgium Tel. +32 11 516160 Fax +32 11 526794 info@kuka.be www.kuka.be
Brazil	KUKA Roboter do Brasil Ltda. Travessa Claudio Armando, nº 171 Bloco 5 - Galpões 51/52 Bairro Assunção CEP 09861-7630 São Bernardo do Campo - SP Brazil Tel. +55 11 4942-8299 Fax +55 11 2201-7883 info@kuka-roboter.com.br www.kuka-roboter.com.br
Chile	Robotec S.A. (Agency) Santiago de Chile Chile Tel. +56 2 331-5951 Fax +56 2 331-5952 robotec@robotec.cl www.robotec.cl
China	KUKA Robotics China Co., Ltd. No. 889 Kungang Road Xiaokunshan Town Songjiang District 201614 Shanghai P. R. China Tel. +86 21 5707 2688 Fax +86 21 5707 2603 info@kuka-robotics.cn www.kuka-robotics.com
Germany	KUKA Roboter GmbH Zugspitzstr. 140 86165 Augsburg Germany Tel. +49 821 797-4000 Fax +49 821 797-1616 info@kuka-roboter.de www.kuka-roboter.de

France KUKA Automatismes + Robotique SAS
Techvallée
6, Avenue du Parc
91140 Villebon S/Yvette
France
Tel. +33 1 6931660-0
Fax +33 1 6931660-1
commercial@kuka.fr
www.kuka.fr

India KUKA Robotics India Pvt. Ltd.
Office Number-7, German Centre,
Level 12, Building No. - 9B
DLF Cyber City Phase III
122 002 Gurgaon
Haryana
India
Tel. +91 124 4635774
Fax +91 124 4635773
info@kuka.in
www.kuka.in

Italy KUKA Roboter Italia S.p.A.
Via Pavia 9/a - int.6
10098 Rivoli (TO)
Italy
Tel. +39 011 959-5013
Fax +39 011 959-5141
kuka@kuka.it
www.kuka.it

Japan KUKA Robotics Japan K.K.
YBP Technical Center
134 Godo-cho, Hodogaya-ku
Yokohama, Kanagawa
240 0005
Japan
Tel. +81 45 744 7691
Fax +81 45 744 7696
info@kuka.co.jp

Canada KUKA Robotics Canada Ltd.
6710 Maritz Drive - Unit 4
Mississauga
L5W 0A1
Ontario
Canada
Tel. +1 905 670-8600
Fax +1 905 670-8604
info@kukarobotics.com
www.kuka-robotics.com/canada

Korea	KUKA Robotics Korea Co. Ltd. RIT Center 306, Gyeonggi Technopark 1271-11 Sa 3-dong, Sangnok-gu Ansan City, Gyeonggi Do 426-901 Korea Tel. +82 31 501-1451 Fax +82 31 501-1461 info@kukakorea.com
Malaysia	KUKA Robot Automation (M) Sdn Bhd South East Asia Regional Office No. 7, Jalan TPP 6/6 Taman Perindustrian Puchong 47100 Puchong Selangor Malaysia Tel. +60 (03) 8063-1792 Fax +60 (03) 8060-7386 info@kuka.com.my
Mexico	KUKA de México S. de R.L. de C.V. Progreso #8 Col. Centro Industrial Puente de Vigas Tlalnepantla de Baz 54020 Estado de México Mexico Tel. +52 55 5203-8407 Fax +52 55 5203-8148 info@kuka.com.mx www.kuka-robotics.com/mexico
Norway	KUKA Sveiseanlegg + Roboter Sentrumsvegen 5 2867 Hov Norway Tel. +47 61 18 91 30 Fax +47 61 18 62 00 info@kuka.no
Austria	KUKA Roboter CEE GmbH Gruberstraße 2-4 4020 Linz Austria Tel. +43 7 32 78 47 52 Fax +43 7 32 79 38 80 office@kuka-roboter.at www.kuka.at

Poland KUKA Roboter Austria GmbH
Spółka z ograniczoną odpowiedzialnością
Oddział w Polsce
Ul. Porcelanowa 10
40-246 Katowice
Poland
Tel. +48 327 30 32 13 or -14
Fax +48 327 30 32 26
ServicePL@kuka-roboter.de

Portugal KUKA Sistemas de Automatización S.A.
Rua do Alto da Guerra n° 50
Armazém 04
2910 011 Setúbal
Portugal
Tel. +351 265 729780
Fax +351 265 729782
kuka@mail.telepac.pt

Russia KUKA Robotics RUS
Werbnaja ul. 8A
107143 Moskau
Russia
Tel. +7 495 781-31-20
Fax +7 495 781-31-19
info@kuka-robotics.ru
www.kuka-robotics.ru

Sweden KUKA Svetsanläggningar + Robotar AB
A. Odhners gata 15
421 30 Västra Frölunda
Sweden
Tel. +46 31 7266-200
Fax +46 31 7266-201
info@kuka.se

Switzerland KUKA Roboter Schweiz AG
Industriestr. 9
5432 Neuenhof
Switzerland
Tel. +41 44 74490-90
Fax +41 44 74490-91
info@kuka-roboter.ch
www.kuka-roboter.ch

Spain	KUKA Robots IBÉRICA, S.A. Pol. Industrial Torrent de la Pastera Carrer del Bages s/n 08800 Vilanova i la Geltrú (Barcelona) Spain Tel. +34 93 8142-353 Fax +34 93 8142-950 Comercial@kuka-e.com www.kuka-e.com
South Africa	Jendamark Automation LTD (Agency) 76a York Road North End 6000 Port Elizabeth South Africa Tel. +27 41 391 4700 Fax +27 41 373 3869 www.jendamark.co.za
Taiwan	KUKA Robot Automation Taiwan Co., Ltd. No. 249 Pujong Road Jungli City, Taoyuan County 320 Taiwan, R. O. C. Tel. +886 3 4331988 Fax +886 3 4331948 info@kuka.com.tw www.kuka.com.tw
Thailand	KUKA Robot Automation (M)SdnBhd Thailand Office c/o Maccall System Co. Ltd. 49/9-10 Soi Kingkaew 30 Kingkaew Road Tt. Rachatheva, A. Bangpli Samutprakarn 10540 Thailand Tel. +66 2 7502737 Fax +66 2 6612355 atika@ji-net.com www.kuka-roboter.de
Czech Republic	KUKA Roboter Austria GmbH Organisation Tschechien und Slowakei Sezemická 2757/2 193 00 Praha Horní Počernice Czech Republic Tel. +420 22 62 12 27 2 Fax +420 22 62 12 27 0 support@kuka.cz

Hungary KUKA Robotics Hungaria Kft.
Fő út 140
2335 Taksony
Hungary
Tel. +36 24 501609
Fax +36 24 477031
info@kuka-robotics.hu

USA KUKA Robotics Corporation
51870 Shelby Parkway
Shelby Township
48315-1787
Michigan
USA
Tel. +1 866 873-5852
Fax +1 866 329-5852
info@kukarobotics.com
www.kukarobotics.com

UK KUKA Automation + Robotics
Hereward Rise
Halesowen
B62 8AN
UK
Tel. +44 121 585-0800
Fax +44 121 585-0900
sales@kuka.co.uk

Index

Numbers

2004/108/EC 95
 2006/42/EC 95
 24 V external power supply 21
 89/336/EEC 95
 95/16/EC 95
 97/23/EC 95

A

Accessories 15, 73
 Altitude 64
 Ambient temperature 63
 ANSI/RIA R.15.06-2012 96
 Applied norms and regulations 95
 Automatic mode 92
 Axis range 74
 Axis range limitation 84
 Axis range monitoring 84

B

Basic data 63
 Batteries 15, 21
 Batteries behind the cooling duct, exchanging 171
 Batteries, exchanging 171
 Battery discharge protection, reversing 136
 BR M 10
 Brake defect 86
 Brake release device 84
 Braking distance 74
 Bus devices 21

C

Cabinet Control Unit 15, 18
 Cabinet Control Unit LED display 177
 Cabinet Control Unit, exchanging 163
 Cabinet Control Unit, fusing 181
 Cabinet cooling 60
 Cabinet Interface Board 18
 Cabinet type 63
 Cable lengths 65, 101
 CCU 10, 18
 CCU functions 18
 CCU LED display, overview 177
 CE mark 74
 Charge 21
 CIB 10, 18
 CIP Safety 10
 CK 10
 Cleaning work 93
 Configuration of cooling circuit 61
 Connecting cables 15, 73
 Connecting cables, connecting 133
 Connection conditions 100
 Connection manager 139
 Connection panel 15
 Connector pin allocation X11 104
 Connector pin allocation X20 27, 28

Connector pin allocation X66 119
 Connector pin allocation X7.1 and X7.2 30
 Connector pin allocation X7.1, X7.2 and X7.3 31
 Connector pin allocation, heavy-duty robot 29
 Control PC 15, 17
 Control PC components, exchanging 151
 Control PC, exchanging 151
 Control PC, functions 18
 Control unit 64
 Controller state 184
 Controller System Panel 15, 20
 Controller System Panel LED display 183
 Controller System Panel LED error display 185
 Cooling circuits 60
 Counterbalancing system 93
 CSP 10, 20
 CSP LED display 183
 CSP LED error display 185
 CSP overview 20
 Customer equipment 61

D

Danger zone 75
 Data cables 24, 134
 Declaration of conformity 74
 Declaration of incorporation 73, 74
 Decommissioning 94, 205
 defective fuses 181, 192
 Dimensions of boreholes 69
 Dimensions of robot controller 66
 Dimensions, smartPAD holder 68
 Disposal 94, 205
 Documentation, industrial robot 9
 Drive controller 15
 Drive power supply 15
 Dual NIC 10
 Dynamic testing 110

E

EA 11
 EC declaration of conformity 74
 EDS 10
 EDS cool 10
 Electromagnetic compatibility (EMC) 96
 Electromagnetic compatibility, EMC 97
 EMC 10
 EMC Directive 74, 95
 EMD 10
 EMERGENCY STOP 140
 EMERGENCY STOP device 80, 81, 86
 EMERGENCY STOP devices to X11 108
 EMERGENCY STOP wiring example 108
 EMERGENCY STOP, external 81, 88
 EMERGENCY STOP, local 88
 EN 60204-1 + A1 96
 EN 61000-6-2 96
 EN 61000-6-4 + A1 96
 EN 614-1 96

- EN ISO 10218-1 96
 - EN ISO 12100 95
 - EN ISO 13849-1 95
 - EN ISO 13849-2 95
 - EN ISO 13850 95
 - Enabling device 82, 86
 - Enabling device, external 82
 - Enabling switch 141
 - Enabling switches 82, 115
 - Environmental conditions 63
 - Equipotential bonding 63, 100
 - Error states, CSP 185
 - EtherCAT connection on the CIB 120
 - Ethernet interface (1xRJ45) X66 119
 - Ethernet/IP 10
 - Exchanging devices 122, 137, 156
 - Exhaustive discharge of battery 64, 173
 - Extended SIB relay outputs, checking 145
 - Extended SIB, connections 166
 - Extended SIB, fuse 192
 - Extended SIB, LED display 190
 - External axes 73, 76
 - External axes 1 and 2 30
 - External axes 1, 2 and 3 31
 - External axis 1 30
 - External axis X7.1 26
 - External axis X7.2 26
 - External axis X7.3 26
 - External enabling switch, function 107
 - External fan, exchange 149
 - External voltage 65, 101
- F**
- Fans 15
 - Faults 87
 - Filter mats 60
 - Floor mounting 69
 - Full-load current 63, 100
 - Function test 88
 - Fuse elements 15
- G**
- General safety measures 86
 - Guard interlock 80
- H**
- Handling equipment 127
 - Hard drive, exchanging 155
 - Hazardous substances 93
 - HMI 10
 - Humidity class 64
- I**
- Identification plate 141
 - Industrial robot 15, 73
 - Infeed 24
 - Installation, KUKA System Software 176
 - Intended use 13, 73
 - Interfaces, connection panel 24
 - Interfaces, control PC 55, 185
 - Interfaces, motherboard D2608-K 56
 - Interfaces, motherboard D3076-K 57
 - Interfaces, motherboard D3236-K 58
 - Internal fan, exchanging 150
 - Introduction 9
- J**
- Jog keys 140
 - Jog mode 83, 86
- K**
- KCB 10
 - KCB devices 22
 - KEB 10
 - KEB configuration variants 22
 - KEB devices 22
 - Keyboard 140
 - Keyboard key 140
 - KLI 10
 - KOI 10
 - KONI 10
 - KPC 10
 - KPP 10, 17
 - KPP and KSP warning messages 200
 - KPP error messages 196
 - KPP, exchanging 157
 - KRL 10
 - KSB 10
 - KSB configuration variants 22
 - KSB devices 22
 - KSI 10
 - KSP 11, 17
 - KSP error messages 196
 - KSP, exchanging 160
 - KSS 11
 - KUKA Customer Support 207
 - KUKA Power Pack 15, 17
 - KUKA Power Pack, 3x20 A, checking 196
 - KUKA Power Pack, checking 194
 - KUKA Servo Pack 15, 17
 - KUKA Servo Pack, checking 193
 - KUKA smartPAD 64, 75, 139
 - KUKA smartPAD cable 24
 - KUKA smartPAD holder (optional) 59
 - KUKA smartPAD holder, fastening 101
- L**
- Labeling 85
 - LAN Dual NIC network card, exchanging 154
 - LAN Onboard LED display 186, 187
 - LED group KPP axis control 195
 - LED group KPP communication 195, 196
 - LED group KPP device status 195
 - LED group KPP power supply 195
 - LED group KSP axis control 194
 - LED group KSP communication 194
 - LED group KSP device status 193
 - Liability 73
 - Lifting frame 125
 - Linear unit 73
 - Low Voltage Directive 74
 - Low-voltage power supply unit 15, 21

Low-voltage power supply unit, exchanging 174

M

Machine data 89
 Machinery Directive 74, 95
 Mains filter 21
 Mains frequency 63, 100
 Mains-side fusing 63, 100
 Maintenance 92, 143, 185
 Maintenance symbols 143
 Manipulator 11, 15, 73, 75
 Manual mode 91
 Material designation 206
 Mechanical axis range limitation 84
 Mechanical end stops 83
 Minimum clearances, robot controller 67
 Mode selection 78, 79
 Monitoring, velocity 83
 Motherboard battery, exchange 154
 Motherboard D2608-K 56
 Motherboard D3076-K 57, 58
 Motherboard D3236-K 58, 59
 Motherboard, exchange 154
 Motherboards 55, 185
 Motor cables 24
 Motor connector X20 27, 28
 Motor connector Xxx 26
 Multiple connector X81 38

N

NA 11

O

Operation 139
 Operator 77
 Operator safety 78, 80, 86
 Operator safety acknowledgement 122
 Options 15, 73
 Overload 86
 Overview of robot controller 15
 Overview of the industrial robot 15
 Overview, start-up 131

P

Palletizing robot, connector pin allocation X7.1 37
 Palletizing robot, connector pin allocation X7.1 and X7.2 38
 Palletizing robot, external axes 1 and 2 38
 Palletizing robot, external axis 1 37
 Panic position 82
 PC fan, exchanging 152
 PE cables 24
 PE equipotential bonding 120
 PE equipotential bonding, connecting 135
 PELV 11
 PELV power supply unit 65, 101
 Performance level 122
 Performance Level 78
 Peripheral cables 24
 Peripheral contactor 90

Permissible tolerance of rated voltage 63, 100
 Personnel 76
 PFH values 122
 PL 122
 Planning 97
 Plant integrator 76
 Plates and labels 69
 PLC 11
 PMB 18
 Positioner 73
 Power cable 24
 Power cable, connecting 135
 Power failure 21
 Power Management Board 18
 Power supply connection X1 Harting connector 102
 Power supply connection, technical data 63, 100
 Power supply with battery backup 19
 Power supply without battery backup 19
 Power switched off 21
 Pressure Equipment Directive 93, 95
 Pressure relief plug, exchanging 175
 Preventive maintenance work 93
 Procurement of spare parts 147
 Product description 15
 Protection rating 63
 Protective equipment 83
 Purpose 13

Q

QBS 11

R

Rated supply voltage 63, 100
 RDC 11
 RDC cool 11
 RDC functions 20
 RDC LED display, overview 182
 Reaction distance 74
 Recommissioning 88, 131
 Release device 84
 Repair 92, 147
 Resolver cable, length difference 65, 101
 Resolver Digital Converter 19
 Resolver Digital Converter, exchanging 169
 Resolver Digital Converter, LED display 182
 Robot controller 15, 73
 Robot controller stacked 99
 Robot controller, cleaning 146
 Robot controller, installing 132
 RTS 11

S

Safe operational stop 75, 82
 Safeguard to X11 108
 Safeguards, external 85
 Safely isolated 65, 101
 SafeOperation via Ethernet safety interface 116
 Safety 73
 Safety controller 79
 Safety functions 78, 86

- Safety functions, Ethernet safety interface 112
 - Safety functions, overview 78
 - Safety gate, wiring example 109
 - Safety instructions 9
 - Safety Interface Board 15, 19, 65
 - Safety Interface Board, exchanging 166
 - Safety Interface Board, fuses 191
 - Safety Interface Board, LED display 188
 - Safety interface X11, description 103
 - Safety of machinery 95
 - Safety options 75
 - Safety STOP 0 75
 - Safety STOP 1 75
 - Safety STOP 2 75
 - Safety STOP 0 75
 - Safety STOP 1 75
 - Safety STOP 2 75
 - Safety stop, external 83
 - Safety zone 75, 77
 - Safety, general 73
 - SATA connections 11
 - Semiconductor fuse 191
 - Service life 75
 - Service, KUKA Roboter 207
 - SG FC 11
 - SIB 11, 19, 65
 - SIB description 19
 - SIB functions 19
 - SIB inputs 66
 - SIB LED display, overview 188
 - SIB outputs 65
 - SIB relay outputs, checking 145
 - SIB wiring 103
 - SIB, safe input 109
 - SIB, safe output 111
 - Signal "Peri enabled" 106
 - Simulation 92
 - Single connectors X7.1 to X7.4 38
 - Single connectors X7.1 to X7.8 46
 - Single point of control 94
 - SION 11
 - Sleep mode, CSP 185
 - Slot assignment, motherboard D2608-K 56
 - Slot assignment, motherboard D3076-K 58
 - Slot assignment, motherboard D3236 59
 - smartPAD 75, 87, 139
 - smartPAD cable extensions 65, 101
 - smartPAD holder, fastening 134
 - smartPAD, plugging in 134
 - Software 15, 73
 - Software limit switches 83, 86
 - SOP 11
 - Sound level 63
 - Space for integration of customer options 61
 - Space Mouse 140
 - SPOC 94
 - SRM 11
 - SSB 11
 - Standard SIB, connections 166
 - Standard SIB, fuses 192
 - Start backwards key 140
 - Start key 140, 141
 - Start-up 88, 131
 - Start-up mode 90, 137
 - Start-up overview 131
 - Status keys 140
 - STOP 0 74, 76
 - STOP 1 74, 76
 - STOP 2 74, 76
 - Stop category 0 76
 - Stop category 1 76
 - Stop category 2 76
 - STOP key 140
 - Stop reactions 78
 - Stopping distance 74, 77
 - Storage 94, 205
 - Storage of batteries 173
 - Support request 207
 - Swing range for cabinet door 68
 - Switching on the robot controller 138
 - System configuration, modifying 122, 137, 156
 - System integrator 74, 76, 77
- T**
- T1 76
 - T2 76
 - Target group 13
 - Teach pendant 15, 73
 - Technical data 63
 - Technology cabinet 69
 - Terms used 10
 - Terms used, safety 74
 - Test output A 105, 107
 - Test output B 105, 107
 - Touch screen 139
 - Trademarks 9
 - Training 13
 - Transportation 87, 125
 - Transportation by fork lift truck 126
 - Transportation using fork slots 127
 - Transportation with standard cabinet base 127
 - Transportation with transformer 127
 - Transportation, lifting tackle 125
 - Transportation, pallet truck 128
 - Transportation, set of rollers 129
 - Troubleshooting 177
 - Turn-tilt table 73
- U**
- US1 11
 - US2 11, 90
 - USB 11
 - USB connection 141
 - Use, contrary to intended use 73
 - Use, improper 73
 - User 75, 76
- V**
- Velocity monitoring 83
 - Vibration resistance 64

W

Warnings 9

Weight 63

Wiring example X11 148

Working range limitation 84

Workspace 74, 77

X

X11, configuring 136

X11, contact diagram 108

X19 connector pin allocation 135

X20, palletizing robot, 4 axes 33

X20, palletizing robot, 5 axes 35

X20.1 and X20.4, palletizing robot, 5 axes 34

X20.1 connector pin allocation 29

X20.4 connector pin allocation 29

X21 connector pin allocation 134

X66 119

X7.1 to X7.3, 3 axes 47

X7.1 to X7.4, 4 axes 48

X7.1 to X7.5, 5 axes 49

X7.1 to X7.6, 6 axes 50

X7.1 to X7.7, 7 axes 52

X7.1 to X7.8, 8 axes 54

X7.1, connector pin allocation 30

X8, palletizing robot, 4 axes 32

X81, 3 axes 39

X81, 4 axes 36, 40

X81, X7.1 and X7.2, 6 axes 42

X81, X7.1 to X7.3, 7 axes 43

X81, X7.1 to X7.4, 8 axes 44

X81, X7.1, 5 axes 41

X82, 8 axes 37

