

Automation PC 680

User's Manual

Version: **1.3 Preliminary (December 2005)**

Model No.:-

We reserve the right to change the contents of this manual without warning. The information contained herein is believed to be accurate as of the date of publication; however, Bernecker + Rainer Industrie-Elektronik Ges.m.b.H. makes no warranty, expressed or implied, with regards to the products or the documentation contained within this book. In addition, Bernecker + Rainer Industrie-Elektronik Ges.m.b.H. shall not be liable in the event of incidental or consequential damages in connection with or resulting from the furnishing, performance, or use of these products. The software names, hardware names, and trademarks used in this document are registered by the respective companies.





Chapter 1: General information

Chapter 2: Technical data

Chapter 3: Mounting

Chapter 4: Software

Chapter 5: Accessories

Chapter 6: Maintenance / servicing





Figure index

Table index

Index

Model number index



Chapter 1: General information	13
1. Manual history	13
2. Safety guidelines	15
2.1 Intended use	15
2.2 Policy and procedures	15
2.3 Transport and storage	15
2.4 Mounting	16
2.5 Operation	16
2.5.1 Protection against touching electrical parts	16
2.5.2 Programs, viruses and dangerous programs	16
3. Organization of safety notices	16
4. Guidelines	17
5. General information	17
5.1 Contents of delivery	17
6. Model numbers	18
6.1 Housing	18
6.2 Slot CPU	18
6.3 Backplane / bus board	18
6.4 Power supply	18
6.5 Graphics adapter	18
6.6 Processors	19
6.7 Main memory	19
6.8 Mass memory	19
6.9 Accessories	20
6.10 Documentation	21
6.11 Software	21
7. Environmental temperatures	23
7.1 Example of environmental temperature determination	23
8. Performance data	24
8.1 Example of power calculation	24
9. Typical topologies	25
9.1 The Automation PC as central controller and visualization	25
9.2 The Automation PC as a classic visualization device	26
9.3 Automation PC as server	27
Chapter 2: Technical data	29
1. General information	29
2. Housing	30
2.1 Housing 5HS680.1000-01	30
2.1.1 Features	30
2.1.2 Technical data	31
2.1.3 Dimensions	31
3. Slot CPU	32
3.1 Slot CPU 5SC680.815E-00	32
3.1.1 Features	32
3.1.2 Technical data	32

Table of Contents

3.1.3 Dimensions	35
3.1.4 Interface description	35
3.1.5 Connector / plug descriptions	40
4. Backplane / bus board	51
4.1 7-slot backplane 5BP680.1000-00	51
4.1.1 Technical data	52
4.1.2 Connector / plug descriptions	52
4.2 1-slot backplane 5BP680.1000-01	56
4.2.1 Technical data	56
4.2.2 Connector / plug descriptions	56
4.3 7-slot backplane 5BP680.1000-02	57
4.3.1 Technical data	57
4.3.2 Connector / plug descriptions	58
5. Power supply	62
5.1 Power supply 5PS680.AC01-01	62
5.1.1 Technical data	62
6. Graphics adapter	64
6.1 Graphics adapter 5GA680.1000-01	64
6.1.1 General information	64
6.1.2 Technical data	64
6.1.3 Dimensions	65
6.1.4 Interface descriptions	66
6.1.5 Connector / plug descriptions	67
7. Processors	68
7.1 Technical data	68
7.2 Cooling systems	69
8. Main memory	70
8.1 Technical data	70
9. Mass memory	70
9.1 CompactFlash cards 5CFCRD.0xxx-01	71
9.1.1 General information	71
9.1.2 Order data	72
9.1.3 Technical data	72
9.2 CompactFlash cards 5CFCRD.xxxx-02	73
9.2.1 General information	73
9.2.2 Order data	73
9.2.3 Technical data	73
9.3 Hard disk 5HD680.0020-00	74
9.3.1 General information	74
9.3.2 Technical data	75
9.4 Hard disk 5HD680.0030-00	76
9.4.1 General information	76
9.4.2 Technical data	77
9.5 Hard disk 5HD680.2x20-00	78
9.5.1 General information	78
9.5.2 Technical data	79
9.5.3 Hard disk switch	80

9.6 Hard disk 5HD680.2x30-00	82
9.6.1 General information	82
9.6.2 Technical data	82
9.6.3 Hard disk switch	83
Chapter 3: Mounting	87
1. Mounting instructions	87
2. Mounting options	88
2.1 Vertical	88
2.2 Horizontal	89
2.3 Lying down	90
Chapter 4: Software	91
1. BIOS	91
1.1 General information	91
1.2 BIOS setup	91
1.3 BIOS setup keys	92
2. BIOS settings	93
2.1 BIOS setup - main menu	93
2.2 Standard CMOS features	95
2.3 Advanced BIOS features	101
2.4 Advanced chipset features	104
2.5 Integrated peripherals	107
2.6 Special OEM features	111
2.7 Power management setup	114
2.8 Load fail safe defaults	122
2.9 Load optimized defaults	122
2.10 Set supervisor password	122
2.11 Set user password	123
2.12 Save & exit setup	123
2.13 Exit without saving	123
3. BIOS upgrade	124
4. Load optimized default settings	125
4.1 Profile 0	125
4.1.1 Standard CMOS features	125
4.1.2 Advanced BIOS features	126
4.1.3 Advanced chipset features	126
4.1.4 Integrated peripherals	127
4.1.5 Special OEM feature	128
4.1.6 Statistics motherboard	128
4.1.7 Power management setup	128
4.1.8 PnP/PCI configuration	130
4.1.9 Frequency / voltage control	130
4.2 Profile 1	131
4.2.1 Standard CMOS features	131
4.2.2 Advanced BIOS features	131

Table of Contents

4.2.3 Advanced chipset features	132
4.2.4 Integrated peripherals	132
4.2.5 Special OEM features	133
4.2.6 Statistics motherboard	134
4.2.7 Power management setup	134
4.2.8 PnP/PCI configuration	135
4.2.9 Frequency / voltage control	135
5. B&R IPC Diagnostics Utility	136
5.1 Info tab	136
5.2 Controller	137
5.2.1 Controller - type	137
5.2.2 Controller - temperature	138
5.2.3 Controller - alarms	139
5.2.4 Controller - voltages	140
5.2.5 Controller - fan	141
5.2.6 Controller - user serial ID	141
5.3 Version	142

Chapter 5: Accessories 143

1. Overview	143
2. Replacement CMOS batteries	144
2.1 General information	144
2.2 Order data	144
2.3 Technical data	144
3. Filter kit 5AC680.1000-00	145
3.1 Order data	145
3.2 Dimensions	145
4. Replacement filter 5AC680.1000-01	146
4.1 Order data	146
5. USB port adapter 5AC680.USB3-00	146
5.1 Order data	147
6. DVI - monitor adapter 5AC900.1000-00	147
6.1 Order data	147
7. DVI cable 5CADVI.0xxx-00	147
7.1 Order data	148
8. CompactFlash slot adapter 5CFADA.SL01-00	149
8.1 Technical data	149
8.2 Dimensions	150
9. CD-ROM FDD combo 5DD680.CRFD-00	151
9.1 Mounting instructions	151
9.2 Technical data	152
10. DVD-ROM/CD-RW FDD combo 5DD680.DCFD-00	153
10.1 Mounting instructions	153
10.2 Technical data	154
11. RS232 adapter 5SA680.0232-00	156
11.1 Technical data	156

11.2 Interface description	157
11.2.1 RS232	157
11.3 Connector / plug descriptions	158
11.3.1 Connection - Slot CPU	158
12. RS422 adapter 5SA680.0422-01	159
12.1 Technical data	159
12.2 Interface description	160
12.2.1 RS232/RS422	160
12.3 Connector / plug descriptions	161
12.3.1 Connection - Slot CPU	161
13. Sound adapter 5SO680.1000-00	162
13.1 General information	162
13.2 Jumper	162
13.3 Technical data	163
13.4 Interface description	163
13.4.1 Parallel interface	163
13.4.2 Microphone in	164
13.4.3 Line in	164
13.4.4 Line out	164
13.4.5 Headphones out	164
13.5 Connector / plug descriptions	164
13.5.1 LPT connection	164
13.5.2 AC97 connection	164
13.5.3 Video in	165
13.5.4 AUX in	165
13.5.5 CD in	165
14. Hardware security key	166

Chapter 6: Maintenance / servicing 167

1. Changing the battery	167
1.1 Procedure for changing the battery	167
2. Changing the fuse	168
2.1 Power supply	168
2.2 Graphics adapter	169
3. Filter kit exchange / cleaning	170
3.1 Procedure	170
4. FAQ	171
4.1 How do I change the battery in the Slot CPU?	171
4.2 What does it mean when the Slot CPU's red alarm LED lights up or blinks?	171
4.3 How do I perform a BIOS upgrade?	171
4.4 Where can I find drivers for the hardware?	171
4.5 How do I open the housing?	171
4.6 How do I exchange the air filter?	171
4.7 How do I mount the filter kit set?	171
4.8 How do I exchange the graphics adapter fuse?	171
4.9 What can I plug in where?	172

Table of Contents

4.10 What all do I need for an Automation PC?	172
4.11 How far away can DVI displays be placed?	172
4.12 Which driver do I need and where can I find it?	172
4.13 Which touch driver do I need and how do I install it?	173
4.14 What interface is where?	173

Chapter 1 • General information

Information:

B&R does its best to keep the printed versions of its user's manuals as current as possible. However, sometimes a newer version of the user's manual can be downloaded in electronic form (pdf) from the B&R homepage www.br-automation.com.

1. Manual history

Version	Date	Comment
1.0	03 June 2002	Changes / new features - First version
1.1	18 Sept. 2002	Changes / new features - Error correction: touch screen / power interface pin assignments - Model numbers added - Dimension diagram for entire device revised - Image of the industry power supply added - New image of the slot CPU with new labels and descriptions of new functions - New image of the backplane with new labels and descriptions of new functions - Technical data added for the 20GB HDD, the CMOS battery and the dongle - Temperature specifications added
1.2	31 Oct. 2002	Changes / new features - Manual structure revised - New figure of Slot CPU components - New "Software" chapter has been added. - 1-slot backplane (0I/1M/0P), model number 5BP680.1000-01 added - Sound adapter 5SO680.1000-00 description added - Safety guidelines updated

Table 1: Manual history

General information • Manual history

Version	Date	Comment
1.3	13 Oct. 2004	<p>Changes / new features</p> <ul style="list-style-type: none">- BIOS profile - load optimized default settings revised- Changeover to a new A5 book template V3.3, restructuring- Mounting options for the entire APC680 device specified in detail- Changes to the BIOS descriptions due to the BIOS Version 1.01- Power consumption with specification example added- Operating temperatures with calculation example added- USB 3-port PC slot 5AC680.USB3-00 added- Technical data for all components revised- "Maintenance / servicing chapter" added- Description of B&R IPC diagnostic utilities V2.00 added- New CompactFlash cards -02 (Athena controller) added- FAQ area added- New processor cooler variant added- Note regarding insertion of additional standard full-size 32 PCI interface cards added- Information regarding figures and descriptions for BIOS Version 1.01 added- Safety guidelines revised

Table 1: Manual history

2. Safety guidelines

2.1 Intended use

Programmable logic controllers (PLCs, etc.), operating and monitoring devices (industrial PCs, Power Panels, Mobile Panels, etc.) as well as the B&R uninterruptible power supplies have been designed, developed or manufactured for conventional use in industry. They were not designed, developed and manufactured for any use involving serious risks or hazards that could lead to death, injury, serious physical damage, or loss of any kind without the implementation of exceptionally stringent safety precautions. In particular, such risks and hazards include the use of these devices to monitor nuclear reactions in nuclear power plants, as well as flight control systems, flight safety, the control of mass transportation systems, medical life support systems, and the control of weapons systems.

2.2 Policy and procedures

Electronic devices are generally not failsafe. In the event of a failure on the programmable control system, operating or monitoring device, or uninterruptible power supply, the user is responsible for ensuring that other devices that may be connected, e.g. motors, are in a secure state.

Both when using programmable logic controllers and when using operating and monitoring devices as control systems in conjunction with a Soft PLC (e.g. B&R Automation Runtime or comparable products) or a Slot PLC (e.g. B&R LS251 or comparable products), the safety precautions applying to industrial control systems (e.g. the provision of safety devices such as emergency stop circuits, etc.) in accordance with applicable national and international regulations must be observed. The same applies for all other devices connected to the system, such as drives.

All tasks such as installation, commissioning, and service may only be carried out by qualified personnel. Qualified personnel are persons who are familiar with the transport, mounting, installation, commissioning, and operation of the product and who have the appropriate qualifications (e.g. IEC 60364). National accident prevention guidelines must be followed.

The safety guidelines, connection descriptions (rating plate and documentation) and limit values listed in the technical data must be read carefully and must be observed before installation and commissioning.

2.3 Transport and storage

During transport and storage, devices must be protected from excessive stress (mechanical load, temperature, humidity, aggressive atmosphere, etc.).

2.4 Mounting

- Installation must take place according to the documentation using suitable equipment and tools.
- Devices may only be installed without voltage applied and by qualified personnel.
- General safety regulations and nationally applicable accident prevention guidelines must be observed.
- Electrical installation must be carried out according to the relevant guidelines (e.g. line cross section, fuse, protective ground connection).

2.5 Operation

2.5.1 Protection against touching electrical parts

To operate programmable logic controllers, operating and monitoring devices, and uninterruptible power supplies, certain components must carry dangerous voltage levels of over 42 VDC. A life-threatening electrical shock could occur if you come into contact with these parts. This could result in death, severe injury, or material damage.

Before turning on the programmable logic controller, the operational and monitoring devices and the uninterruptible power supply, ensure that the housing is properly grounded (PE rail). The ground connection must be established when testing the operating and monitoring devices or the uninterruptible power supply, even when operating them for only a short time.

Before turning the device on, make sure that all voltage-carrying parts are securely covered. During operation, all covers must remain closed.

2.5.2 Programs, viruses and dangerous programs

The system is subject to a potential danger each time data is exchanged or software is installed using data media (e.g. diskette, CD-ROM, USB memory stick, etc.), a network connection or the Internet. The user is responsible for assessing these dangers, implementing preventative measures such as virus protection programs, firewalls, etc. and obtaining software from reliable sources.

3. Organization of safety notices

The safety notices in this manual are organized as follows:

Safety notice	Description
Danger!	Disregarding the safety regulations and guidelines can be life-threatening.
Caution!	Disregarding the safety regulations and guidelines can result in severe injury or major damage to material.
Warning!	Disregarding the safety regulations and guidelines can result in injury or damage to material.

Table 2: Organization of safety notices

Safety notice	Description
Information:	Important information for preventing errors.

Table 2: Organization of safety notices

4. Guidelines

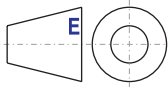

European dimension standards apply to all dimension diagrams (e.g. dimension diagrams, etc.).

5. General information

The Automation PC 680 is an industrial PC based on a Slot CPU. Through the addition of various additional components (graphics adapter, sound adapter, interface adapter, etc.) it becomes a powerful Automation PC (APC).

5.1 Contents of delivery

All components and accessories (processors, RAM, graphics adapter, sound adapter, interface adapter, software, documentation, etc.) must be ordered separately from B&R. This means, for example, that a user manual is not delivered with the IPC unless it is ordered separately. This measure is taken to prevent bulk purchasers from automatically receiving a large amount of unwanted manuals. In this way, extra financial and logistical expenses can be avoided.

6. Model numbers

6.1 Housing

Model number	Short description	Note
5HS680.1000-01	Housing w/ fan CD/FD Housing with two built-in fans (120 mm diameter) for connection to the backplane.	

Table 3: Model numbers - housing

6.2 Slot CPU

Model number	Short description	Note
5SC680.815E-00	Slot CPU 815E 2DIMM Slot CPU with universal socket 370 for Intel Celeron und Pentium III processors, chipset 815E, 2 DIMM slots, graphics memory up to 32 MB shared memory, AWARD modular BIOS 6.0, connections for PS/2 AT keyboard, PS/2 mouse, USB and 2 Ethernet 10/100 (Twisted Pair), without processor	

Table 4: Model numbers - Slot CPU

6.3 Backplane / bus board

Model number	Short description	Note
5BP680.1000-00	7-slot backplane (1U/2M/4P) APC680 backplane with total 7 slots: 1 ISA, 2 PICMG and 4 PCI slots. Supplied via APC680 power supply or via ATX power supply.	
5BP680.1000-01	1-slot backplane (0U/1M/0P) APC680 backplane with one PICMG slot, to be mounted in the housing	
5BP680.1000-02	7-slot backplane (1U/2M/4P) 3V3 APC680 backplane with total 7 slots: 1 ISA, 2 PICMG and 4 PCI slots. (with onboard 3,3 V power supply for the PCI slots)	

Table 5: Model numbers - backplane

6.4 Power supply

Model number	Short description	Note
5PS680.AC01-01	Power supply 115/230 VAC w/24V Supply voltage 85-132 VAC / 170-264 VAC autoselect, 47-63 Hz, max. 110 Watt at 55°C	

Table 6: Model numbers - power supply

6.5 Graphics adapter

Model number	Short description	Note
5GA680.1000-01	Graphics adapter DVI RS232 24V Outputs: DVI-I, COM and 24 VDC	

Table 7: Model numbers - graphics adapter

6.6 Processors

Model number	Short description	Note
5CPICP.0566-00	Processor ICP 566/66 128k H1 Intel Celeron® processor 566/66, 32 kB L1 cache, 128 kB L2 cache. Only available with an APC680 Slot CPU.	
5CPICP.0733-00	Processor ICP 733/66 128k H1 Intel Celeron® processor 733 MHz with 66 MHz FSB, 32 kB L1 cache, 128 kB L2 cache. Only available with an APC680 Slot CPU.	
5CPICP.0850-00	Processor ICP 850/100 128k H1 Intel Celeron® processor 850 MHz with 100 MHz FSB, 32 kB L1 cache, 128 kB L2 cache. Only available with an APC680 Slot CPU.	
5CPICP.1200-00	ICP processor 1.2/100 256k F2 Intel Celeron® processor 1.2 GHz with 100 MHz FSB, 32 kB L1 cache, 256 kB L2 cache, with active fan. Only available with an APC680 Slot CPU.	
5CPIP3.1260-00	IP3 processor 1.26/133 512k F2 Intel Pentium® processor 1.26 GHz with 133 MHz FSB, 32 kB L1 cache, 512 kB L2 cache, with active fan. Only available with an APC680 Slot CPU.	

Table 8: Model numbers - processors

6.7 Main memory

Model number	Short description	Note
5MMSDR.0128-00	DIMM SDRAM - 128MB PC133 CL2 16Mx64 (168-pin) DIMM module - 128MB,133MHZ 168-pin ORIGINAL CL2	
5MMSDR.0256-00	DIMM SDRAM - 256MB PC133 CL2 16Mx64 (168-pin) DIMM module - 256MB,133MHZ 168-pin ORIGINAL CL2	
9A0004.11	DIMM SDRAM - PC100 64 MB 8 MB x 64 (168-pin) DIMM module - 64 MB, 100MHz 168-pin	
9A0004.12	DIMM SDRAM - PC100 128 MB 16 MB x 64 (168-pin) DIMM module - 128 MB, 100MHz 168-pin	
9A0004.14	DIMM SDRAM - PC100 256 MB 32 MB x 64 DIMM module - 256 MB, 100MHz 168-pin	

Table 9: Model numbers - main memory

6.8 Mass memory

Model number	Short description	Note
5CFCRD.0032-01	CompactFlash 32 MB True IDE SanDisk/R2 CompactFlash card with 32 MB Flash PROM, and true IDE/ATA interface	<i>Cancelled since 12/03</i>
5CFCRD.0032-02	CompactFlash 32 MB True IDE SanDisk/A CompactFlash card with 32 MB Flash PROM, and true IDE/ATA interface	<i>Replacement type for 5CFCRD.0032-01</i>
5CFCRD.0064-01	CompactFlash 64 MB True IDE SanDisk/R2 CompactFlash card with 64 MB Flash PROM, and true IDE/ATA interface	<i>Cancelled since 12/03</i>
5CFCRD.0064-02	CompactFlash 64 MB True IDE SanDisk/A CompactFlash card with 64 MB Flash PROM, and true IDE/ATA interface	<i>Replacement type for 5CFCRD.0064-01</i>

Table 10: Model numbers - mass memory

General information • Model numbers

Model number	Short description	Note
5CFCRD.0128-01	CompactFlash 128 MB True IDE SanDisk/R2 CompactFlash card with 128 MB Flash PROM, and true IDE/ATA interface	<i>Cancelled since 12/03</i>
5CFCRD.0128-02	CompactFlash 128 MB True IDE SanDisk/A CompactFlash card with 128 MB Flash PROM, and true IDE/ATA interface	<i>Replacement type for 5CFCRD.0128-01</i>
5CFCRD.0128-01	CompactFlash 196 MB True IDE SanDisk/R2 CompactFlash card with 196 MB Flash PROM, and true IDE/ATA interface	<i>Cancelled since 07/03</i>
5CFCRD.0256-01	CompactFlash 256 MB True IDE SanDisk/R2 CompactFlash card with 256 MB Flash PROM, and true IDE/ATA interface	<i>Cancelled since 12/03</i>
5CFCRD.0256-02	CompactFlash 256 MB True IDE SanDisk/A CompactFlash card with 256 MB Flash PROM, and true IDE/ATA interface	<i>Replacement type for 5CFCRD.0256-01</i>
5CFCRD.0384-01	CompactFlash 384 MB True IDE SanDisk/R2 CompactFlash card with 384 MB Flash PROM, and true IDE/ATA interface	<i>Cancelled since 07/03</i>
5CFCRD.0512-01	CompactFlash 512 MB True IDE SanDisk/R2 CompactFlash card with 512 MB Flash PROM, and true IDE/ATA interface	<i>Cancelled since 12/03</i>
5CFCRD.0512-02	CompactFlash 512 MB True IDE SanDisk/A CompactFlash card with 512 MB Flash PROM, and true IDE/ATA interface	<i>Replacement type for 5CFCRD.0512-01</i>
5CFCRD.1024-02	CompactFlash 1024 MB True IDE SanDisk/A CompactFlash card with 1024 MB Flash PROM and true IDE/ATA interface	
5CFCRD.2048-02	CompactFlash 2024 MB True IDE SanDisk/A CompactFlash card with 2024 MB Flash PROM and true IDE/ATA interface	
5HD680.0020-00	Hard disk 20 GB UDMA100 Hard disk - 20 GB 2.5" (63.5 mm) practical slide-in design, permanently mounted, UDMA100	<i>Cancelled since 10/03</i>
5HD680.0030-00	Hard disk - 30 GB UDMA100 (MHT2030AR) Hard disk - 30 GB 2.5" (63.5 mm) practical slide-in design, permanently mounted, UDMA100	
5HD680.2x20-00	Hard disk - 2x20 GB M/S 2 Hard disk - 20 GB 2.5" (63.5 mm) practical slide-in design, permanently mounted, UDMA33; delivered with matching hard disk switch to be inserted in a free slot on the APC, and the required cables.	<i>Cancelled since 10/03</i>
5HD680.2x30-00	Hard Disk 2x30GB M/S (MHT2030AR) 2 Hard disk - 30 GB 2.5" (63.5 mm) practical slide-in design, permanently mounted, UDMA33; delivered with matching hard disk switch to be inserted in a free slot on the APC, and the required cables.	

Table 10: Model numbers - mass memory (cont.)

6.9 Accessories

Model number	Short description	Note
0AC201.9	Lithium batteries (5 pcs.) Lithium batteries, 5 pcs., 3 V / 950 mAh, button cell	
4A0006.00-000	Accessory - Lithium battery Lithium battery, 1 piece, 3 V / 950 mAh, button cell	
5AC680.1000-00	Filter kit Filter set for connecting to the housing fans	
5AC680.1000-01	Replacement filter - 5 pieces Replacement filter for the filter kit - 5pcs.	

Table 11: Model numbers - accessories

Model number	Short description	Note
5AC680.USB3-00	USB 3 port PC slot USB adapter 3 port	
5AC900.1000-00	Adapter DVI-A/m to CRT DB15HD/f Adapter DVI (plug) to CRT (socket), for connecting a standard monitor to a DVI-I interface.	
5CADVI.0018-00	DVI-D cable 1.8 m/single DVI-D cable 1.8 m / single	
5CADVI.0050-00	DVI-D cable 5 m/single DVI-D cable 5 m / single	
5CADVI.0100-00	DVI-D cable 10 m/single DVI-D cable 10 m / single	
5CFADA.SL01-00	CompactFlash adapter IDE 2mm PC slot For operating a CompactFlash card on the IDE interface. To be inserted in a free slot.	
5DD680.CRFD-00	CD-ROM FDD Combo Drive combination: CD-ROM drive and FDD.	
5DD680.DCFD-00	DVD-ROM/CD-RW FDD Combo Drive combination: DVD-ROM with integrated CD-RW and FDD.	
5SA680.0232-00	Serial adapter RS232 RS232 interface, not electrically isolated up to 115 kbaud. For connection to the Slot CPU.	
5SA680.0422-01	Serial adapter RS422 RS422 interface	
5SO680.1000-00	Sound adapter AC97 LPT Inputs: Line in, microphone Outputs: Headphones, line out, parallel interface	

Table 11: Model numbers - accessories (cont.)

6.10 Documentation

Model number	Short description	Note
5MA680.00DE-00	APC680 User's Manual, German	<i>In preparation</i>

Table 12: Model numbers - documentation

6.11 Software

Model number	Short description	Note
5S0000.01-090	HMI Drivers & Utilities CD HMI drivers & utilities CD ROM, contains driver (touch screen, graphics, etc.) and the latest BIOS upgrades for all B&R Panel system devices	
5SWUTI.0000-00	OEM Nero CD-RW software Delivery only available with a CD-RW drive.	
9S0000.06-010	OEM MS-Win2000 Professional, German CD OEM MS Windows 2000, German CD Only available with an APC680.	
9S0000.06-020	OEM MS-Win2000 Professional, English CD OEM MS Windows 2000, English CD Only available with an APC680.	

Table 13: Model numbers - software

General information • Model numbers

Model number	Short description	Note
9S0000.08-010	OEM MS-Win XP Professional, German CD OEM MS-Win XP Professional, German CD; Only available with an APC680.	
9S0000.08-020	OEM MS-Win XP Professional, English CD OEM MS-Win XP Professional, English CD; Only available with an APC680.	
9S0001.11-090	OEM MS Windows XP Embedded Runtime Only available with an APC680.	
9S0001.15-020	MS-WinXP-E APC680 image Only available with an APC680.	

Table 13: Model numbers - software (cont.)

7. Environmental temperatures

When determining the environmental temperature specifications for an entire APC680 system, it is necessary to consider the individual components used (processor, RAM, mass memory, etc.).

Guidelines:

- Of the minimum environmental temperatures for the individual components, the highest one is the minimum environmental temperature for the entire device.
- Of the maximum environmental temperatures for the individual components, the lowest one is the maximum environmental temperature for the entire device.

The necessary data can be found in the technical data for the components being used.

7.1 Example of environmental temperature determination

For the example we will assume that the device is composed of the following components.

Model number	Short text	Environmental temperature	
		Min.	Max.
5HS680.1000-01	Housing/fan CD/FD	1)	1)
5PS680.AC01-01	Power supply 115/230 VAC w/24V	0 °C	50 °C
5SC680.815E-00	Slot CPU 815E 2 DIMM	0 °C	60 °C
5GA680.1000-01	Graphics adapter DVI RS232 24V	0 °C	60 °C
5BP680.1000-00	7-slot backplane (1U/2M/4P)	0 °C	60 °C
5HD680.0020-00 (standard operation)	Hard disk - 20GB UDMA100	5 °C	55 °C
5CPIP3.1260-00 (without filter kit)	Pentium III 1260/133	5 °C	45 °C
5MMSDR.0256-00	DIMM SDRAM 256MB PC133	0 °C	70 °C
5SA680.0232-00	Serial adapter RS232	0 °C	60 °C
5DD680.DCFD-00	DVD-ROM/CD-RW FDD Combo	5 °C	45 °C
Specified environmental temperature for entire device		5 °C	45 °C

Table 14: Configuration example

1) Not relevant for determining the minimum and maximum environmental temperature.

As can be seen in the table, the minimum and maximum environmental temperature for the entire device is determined by the combination drive 5DD680.DCFD-00 and the processor 5CPIP3.1260-00. Therefore, the minimum environmental temperature for this APC680 configuration is **5 °C** and the maximum is **45 °C**.

8. Performance data

Depending on the type of power supply, the following maximum currents and output power apply.

Model number	Short text	Max. current consumption [A]				Max. output power[W]
		+ 5 Volts	+ 12 Volts	- 12 Volts	+ 24 Volts	
5HS680.1000-01	Housing/fan CD/FD	22	8	2	2	125 ¹⁾

Table 15: Maximum current/power consumption - power supplies

1) With operating housing fans on housing 5HS680.1000-01 and at 55 °C

The necessary data can be found in the technical data for the components being used.

When configuring a system, make sure that the power consumption of all components used is not larger than the output power of the power supply.

8.1 Example of power calculation

For the example we will assume that the device is composed of the following components.

Model number	Short text	Max. current consumption [A]				Max. power consumption [W]
		+ 5 Volts	+ 12 Volts	- 12 Volts	+ 24 Volts	
5HS680.1000-01	Housing/fan CD/FD	-	0.75	-	-	9
5SC680.815E-00	Slot CPU 815E 2 DIMM	Σ 8	Σ 0.5	-	-	Σ 36
5GA680.1000-01	Graphics adapter DVI RS232 24V					
5BP680.1000-00	7-slot backplane (1U/2M/4P)					
5SO680.1000-00	Sound adapter AC97 LPT1					
5CPIP3.1260-00	Pentium III 1260/133					
5MMSDR.0256-00	DIMM SDRAM 256 MB PC133					
5HD680.0020-00	Hard disk 20 GB UDMA100	Σ 3	-	-	-	Σ 10 ¹⁾
5DD680.DCFD-00	DVD-ROM/CD-RW FDD Combo					
5AP920.1505-00	AP920 TFT C XGA 15" T	-	-	-	1.7	40
-	PS/2 and USB	2	-	-	-	
-	PCI or ISA interface card	Σ 6	Σ 2	Σ 0.5	-	Σ 20 ²⁾
Total		19	3.35	0.5	1.7	115

Table 16: Configuration example

1) All installed drives cannot be accessed simultaneously at maximum power consumption. Therefore the value for the power calculation has been set at 10 Watts.

2) A maximum of 5 watts can be consumed per slot. For the calculation, 4 cards were used that together required 20 Watts.

The example shows that this system can utilize the APC680 power supply (model number 5HS680.1000-01).

9. Typical topologies

9.1 The Automation PC as central controller and visualization

The control program runs on an Automation PC. The visualization project is integrated with Visual Components.

A display unit is connected to the PC either locally or remotely. The PC is networked over Ethernet TCP/IP; additional Power Panel-based operator terminals can be also connected via Ethernet. Communication to I/O systems with axes is made using fieldbus systems (CAN, ETHERNET Powerlink).

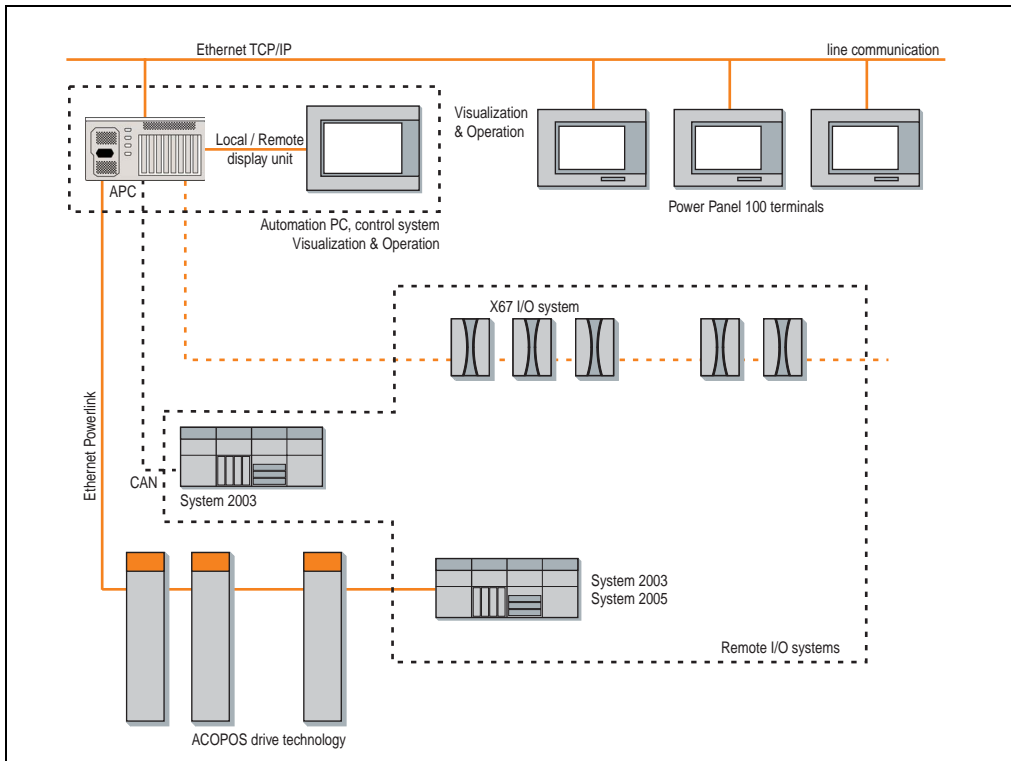

Figure 1: Automation PC as central controller and visualization

9.2 The Automation PC as a classic visualization device

The visualization runs as a SCADA application on the APC680. The display unit is connected to the APC either locally or remotely. The control tasks interact with one or more underlying PLC stations where I/O systems and drives are connected locally or remotely over fieldbus systems. Additional SCADA stations can be networked via Ethernet TCP/IP.

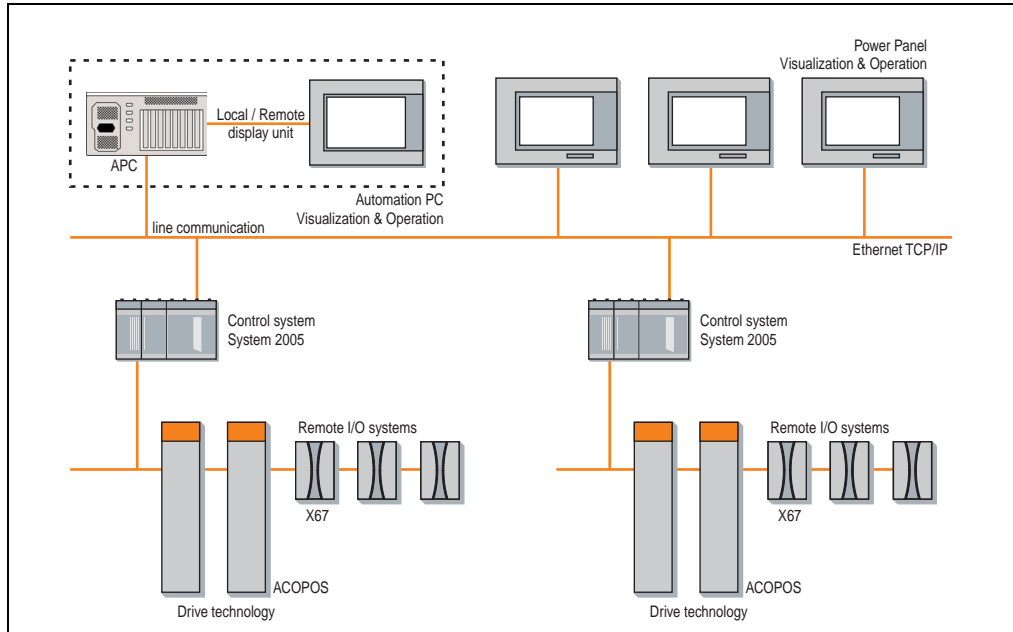

Figure 2: Automation PC as classic visualization device

9.3 Automation PC as server

Windows XP Professional or Embedded runs on the Automation PC with real-time expansion for control and drive technology. Automation Runtime AR010 takes over the control. Mobile Panel and Power Panel operate on Windows CE as thin clients. Communication to the Automation PC occurs via Ethernet TCP/IP and the remote desktop protocol.

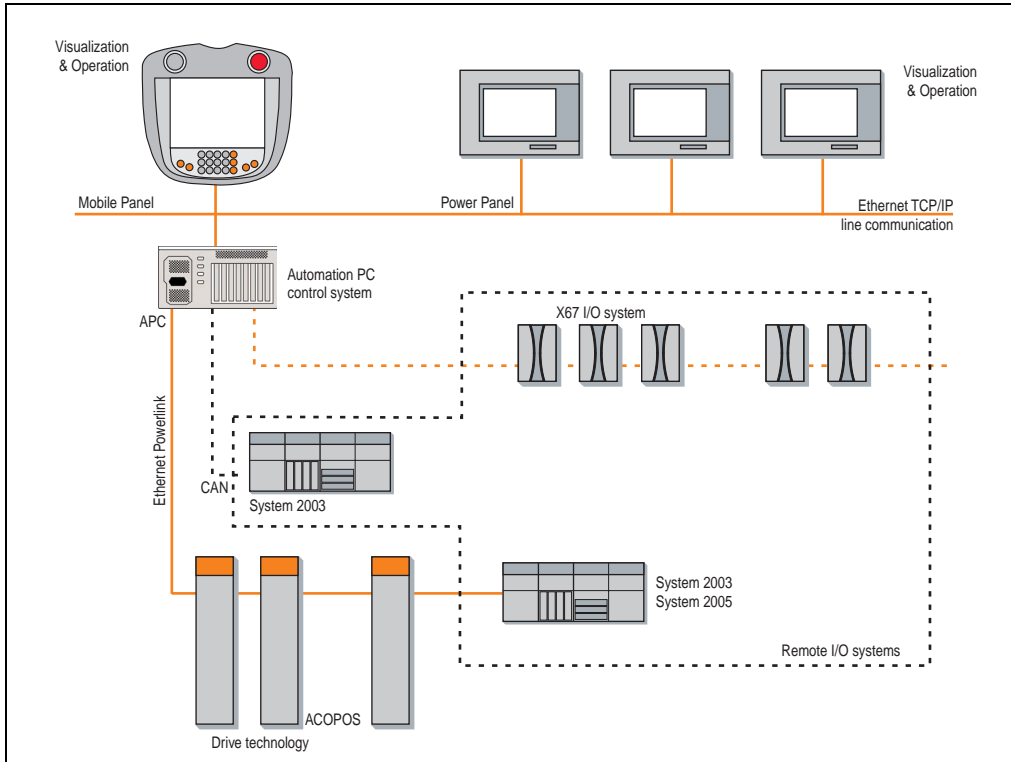

Figure 3: Automation PC as server

Chapter 2 • Technical data

1. General information

Developed specifically for demanding controller and visualization tasks, the APC680 highlights the upper end of B&R's industrial PC spectrum. Thanks to its modular construction, the APC680, based on a Slot CPU, can be adapted to the requirements of the application. Fastened plug connectors and durable mechanics ensure problem-free use in rough industrial environments.



Figure 1: Entire APC680 device (example configuration)

Features:

- Intel Celeron or Intel Pentium III Tualatin up to 1.26 GHz
- Up to 512 MB RAM
- 2 x 100 Mbps Ethernet
- 4 x USB (USB 1.1, max. 12 MBit)
- DVI-I for flat displays
- 4 PCI, 1 ISA and 2 PICMG slots
- 4 serial interfaces

2. Housing

All components of an APC680 system are combined in the housing. B&R currently offers the following housing variants:

Model number	Short description	Note
5HS680.1000-01	Housing w/ fan CD/FD Housing with two built-in fans (120 mm diameter) for connection to the backplane.	

2.1 Housing 5HS680.1000-01

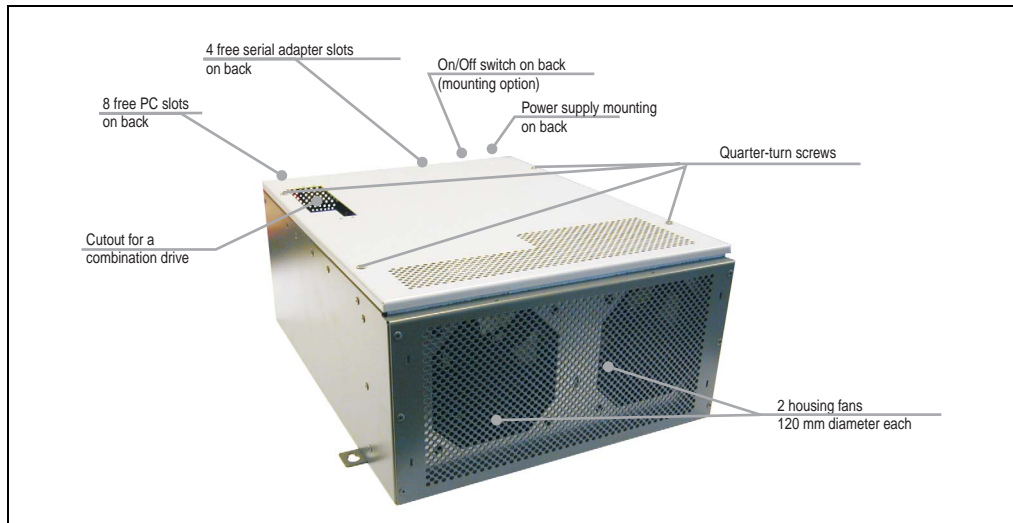

Figure 2: Components - 5HS680.1000-01

2.1.1 Features

- Eight PC slots
- Simple power supply mounting
- Backplane mounting
- Simple hard disk mounting using plug-in technology
- Temperature controlled fans with 120 mm diameter each
- Optional installation of additional drives (CD/CD-RW/DVD/FDD) - if no additional drives are installed, the opening is closed using the appropriate cover.

2.1.2 Technical data

Features	5HS680.1000-01
Supply range	+ 12 VDC for the housing fans
Power consumption	Fan wattage (0.75 A at +12 VDV)
Weight	Approx. 7 kg

Table 1: Technical data - 5HS680.1000-01

2.1.3 Dimensions

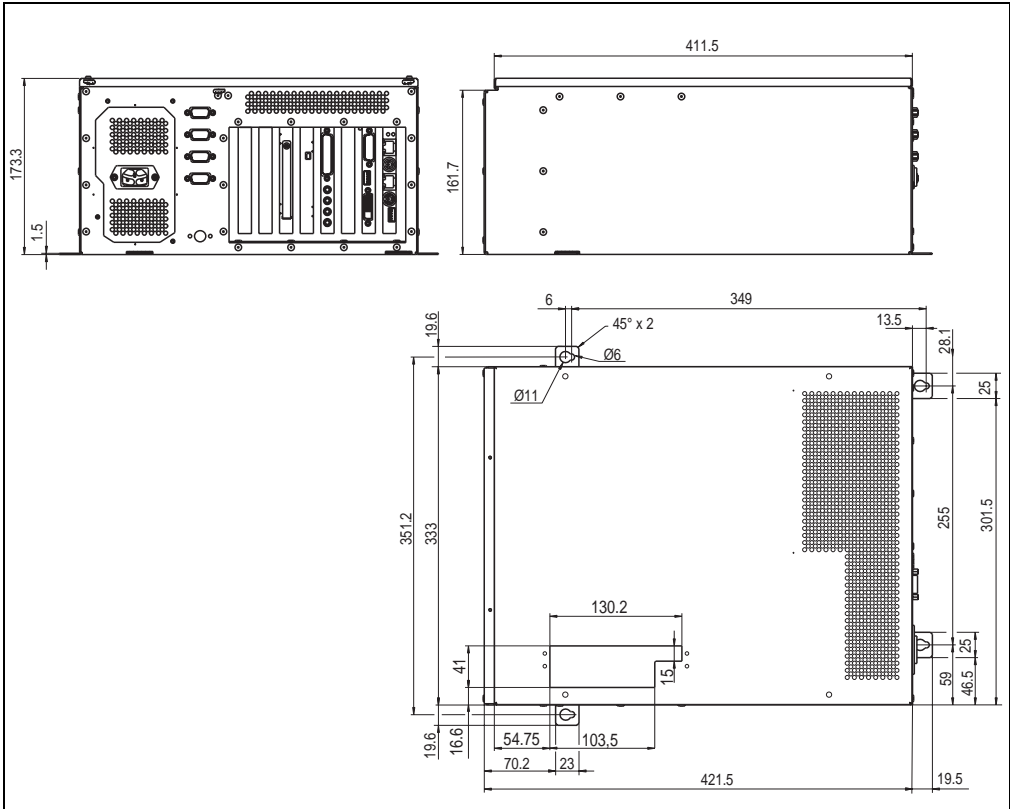

Figure 3: Dimensions - 5HS680.1000-01

3. Slot CPU

Model number	Short description	Note
5SC680.815E-00	Slot CPU 815E 2DIMM Slot CPU with universal socket 370 for Intel Celeron und Pentium III processors, chipset 815E, 2 DIMM slots, graphics memory up to 32 MB shared memory, AWARD modular BIOS 6.0, connections for PS/2 AT keyboard, PS/2 mouse, USB and 2 Ethernet 10/100 (Twisted Pair), without processor	

3.1 Slot CPU 5SC680.815E-00

3.1.1 Features

Full-size Slot CPU corresponding to the PICMG standard

- Universal socket 370
- Intel 815E chipset with integrated graphic controller
- Two DIMM sockets
- Four serial interfaces (using interface adapter)
- PS/2 mouse and keyboard
- Two UDMA 100 controllers (max 4 devices)
- One IEEE 1284 parallel interface
- 1.44 MB floppy interface
- Hardware security key
- Two 10/100 Mbit Ethernet interfaces
- Four USB interfaces (USB 1.1, max. 12 MB)
- Plug-in graphics adapter with DVI-I and RS232 with +12 VDC power supply
- Plug-in AC97 compatible sound adapter (optional)
- Temperature regulated device fans (optional)

3.1.2 Technical data

Features	5SC680.815E-00
Supply range	+ 5V, + 12V, - 12V via ATX power plug from the APC680 power supply
Power consumption	Depending on the components used for PS/2 or USB devices max. 2 A at +5 VDC
Environmental temperature	
Operation	0 °C to +60 °C
Storage	-30 °C to +80 °C
Transport	-30 °C to +80 °C

Table 2: Technical data - 5SC680.815E-00

Features	5SC680.815E-00
Humidity	
Operation	5 - 95 % non-condensing
Storage	5 - 95 % non-condensing
Transport	5 - 95 % non-condensing
Weight	Approx. 0.4 kg

Table 2: Technical data - 5SC680.815E-00 (cont.)

The Slot CPU occupies from one to three slots on the backplane, depending on the configuration (with/without graphics adapter or sound adapter):

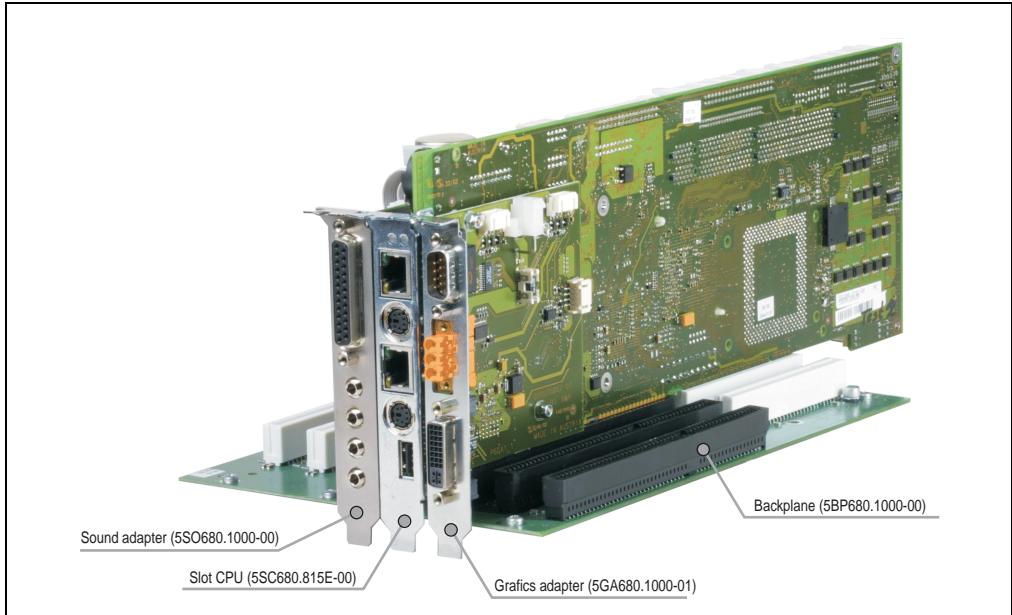

Figure 4: Configuration example - Slot CPU

Information:

If the Slot CPU is inserted in the inner PICMG slot, no standard PCI 32-bit full-size card can be inserted in the next two PCI slots due to the size of the CPU's heat sink. Standard PCI 32-bit half-size cards can be inserted without a problem.

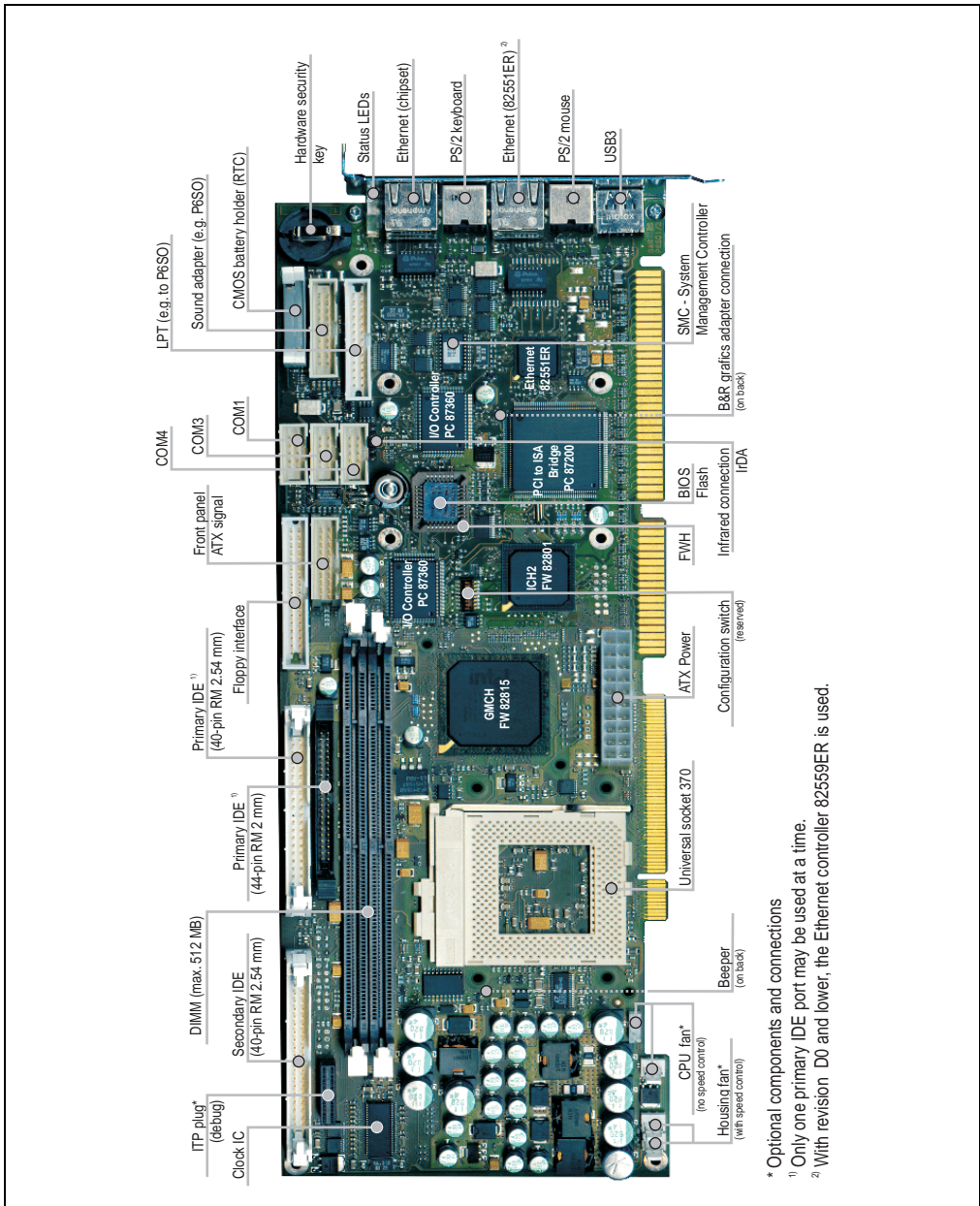

Figure 5: Components - Slot CPU

* Optional components and connections

¹⁾ Only one primary IDE port may be used at a time.

²⁾ With revision D0 and lower, the Ethernet controller 82559ER is used.

3.1.3 Dimensions

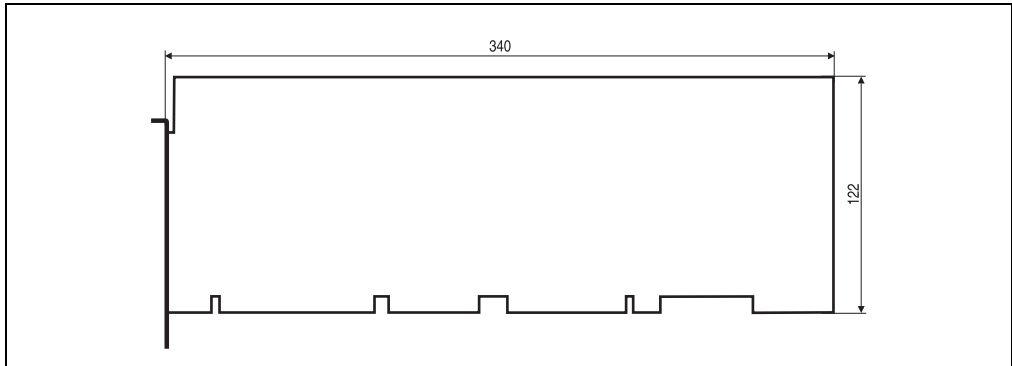

Figure 6: Dimensions - Slot CPU

3.1.4 Interface description

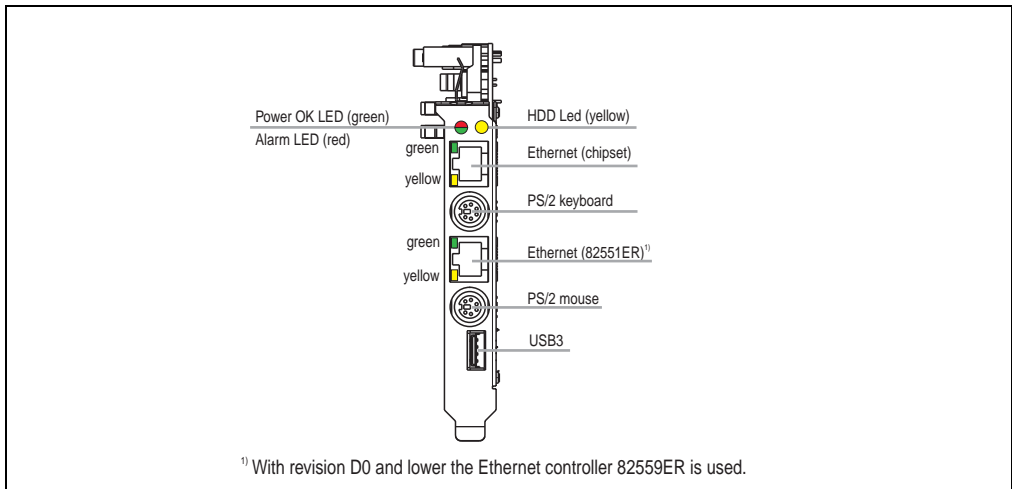

Figure 7: Interfaces - Slot CPU

Status LEDs

The status LEDs indicate the current status of the Slot CPU (See figure "Interfaces - Slot CPU" on page 35 for their positions).

A dual LED is used for the status "Power OK" and "Alarm", which is lit green, red, or alternating green-red.

- Green means that everything is OK.
- Red indicates an alarm (processor temperature, board I/O temperature, board socket

temperature, CPU fan, or housing fan alarm). The type of alarm can be checked using the B&R diagnostics utility for Win 9x/ME/NT4.0/2000/XP. The B&R IPC Diagnostics Utility can be found on the HMI Drivers & Utilities CD ROM (model number 5S0000.01-090) V1.49 and up. It can also be downloaded from the B&R homepage (www.br-automation.com) under the name MTC & Mkey Utilities V2.00 (Category: Panel Systems - Automation PC680 - Utilities).

- Blinking green/red means that an alarm has occurred but is no longer active, and that no other alarm is pending. Using the B&R IPC Diagnostics Utility you can reset the status of all activated alarms (shown in purple) to OK with the button "Acknowledge all alarms". This will change the green/red blinking status LED back to a steady green OK LED.

No alarm (green)	Active alarm (red)
	
Unacknowledged alarm (purple)	No alarm (green) - after acknowledgement
	

Table 3: B&R IPC Diagnostics Utility - alarm acknowledgement

If a hard disk is being accessed (reading or writing), this is indicated by the HDD LED (yellow).

Ethernet (chipset)

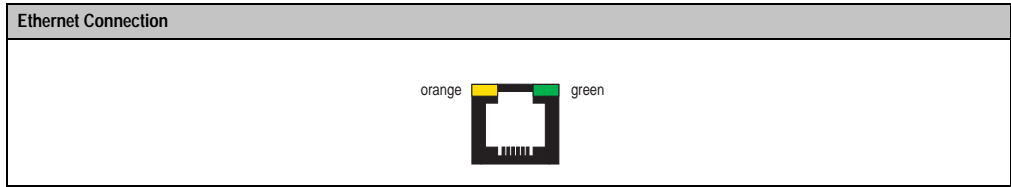

Ethernet	10/100 MBit/s ¹⁾
Connection	RJ45 Twisted Pair (10BaseT/100BaseT)
Controller	Integrated in the 815E chipset - 82562ET (82559 compatible)
Cabling	S/STP (category 5)

Table 4: Ethernet controller

1) Both operating modes possible. Change-over takes place automatically.

The onboard Ethernet (chipset) controller on the Slot CPU provides an RJ45 Twisted Pair connection, to which 2 LEDs are attached for status control:

LED	On	Off
Green	100 MBit/s	10 MBit/s
Orange	Link	Activity (blinking)

Table 5: Status LEDs - Ethernet controller

PS/2 keyboard

A PS/2 socket is used to connect an external AT enhanced keyboard.

(PS/2) AT keyboard connection	
Pin	Assignment
1	KBDATA
2	N.C.
3	GND
4	+5 V ¹⁾
5	KBCLK
6	N.C.

The diagram shows a circular PS/2 keyboard socket with six pins. The pins are numbered 1 through 6. Pin 1 is at the bottom, pin 2 is at the bottom-left, pin 3 is at the right, pin 4 is at the left, pin 5 is at the top-left, and pin 6 is at the top-right.

Table 6: Pin assignments - (PS/2) AT keyboard

1) protected by a 1.5A multifuse

Warning!

Because of general PC specifications, this interface should be handled with extreme care with regard to EMC, location of cables etc. It should therefore only be used for service.

Make sure the connections for the PS/2 keyboard and PS/2 mouse are not swapped.

No devices are allowed to be connected that use the PS/2 mouse supply as a power source.

Ethernet (82551ER)

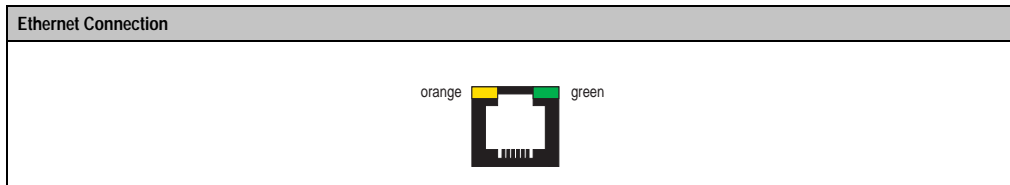

Ethernet	10/100 MBit/s ¹⁾
Connection	RJ45 Twisted Pair (10 BaseT/100 BaseT)
Controller	Intel 82551ER ²⁾
Cabling	S/STP (category 5)

Table 7: Ethernet controller

1) Both operating modes possible. Change-over takes place automatically

2) With a revision < D0 use Ethernet controller 82559ER.

The onboard Ethernet (82551ER) controller on the Slot CPU provides an RJ45 Twisted Pair connection, to which 2 LEDs are attached for status control:

LED	On	Off
Green	100 MBit/s	10 MBit/s
Orange	Link	Activity (blinking)

Table 8: Status LEDs - Ethernet controller

PS/2 mouse

An interface for the connecting a standard PS/2 mouse is provided on the Slot CPU.

Connection for mouse (PS/2)	
Pin	Assignment
1	MOUSE DATA
2	N.C.
3	GND
4	+5 V ¹⁾
5	MOUSE CLK
6	N.C.

PS/2 socket

Table 9: Pin assignments - mouse interface (PS/2)

1) protected by a 1.5A multifuse

Warning!

Because of general PC specifications, this interface should be handled with extreme care with regard to EMC, location of cables etc. It should therefore only be used for service.

Make sure the connections for the PS/2 keyboard and PS/2 mouse are not swapped.

No devices are allowed to be connected that use the PS/2 mouse supply as a power source.

USB3

The Slot CPU has a USB host controller (USB 1.1, max. 12 MBit) with a USB port (number 3) to connect, for example, a USB keyboard, USB mouse, or USB drive (floppy, CD ROM, etc.).

Warning!

Because of general PC specifications this interface should be handled with extreme care with regard to EMC, location of cables etc.

3.1.5 Connector / plug descriptions

ITP plug (debug)

The In Target Probe (ITP) plug is used by BIOS functions for testing and error searches and is an optional component.

Secondary IDE (40-pin, RM 2.54 mm)

Pin	Assignment	Pin	Assignment
1	RESET	21	DREQ
2	GND	22	GND
3	DATA 7	23	IOW
4	DATA 8	24	GND
5	DATA 6	25	IOR
6	DATA 9	26	GND
7	DATA 5	27	IOCHRDY
8	DATA 10	28	GND
9	DATA 4	29	DACK
10	DATA 11	30	GND
11	DATA 3	31	IRQ 15
12	DATA 12	32	ATA66 cable detect
13	DATA 2	33	ADDR1
14	DATA 13	34	N.C.
15	DATA 1	35	ADDR0
16	DATA 14	36	ADDR2
17	DATA 0	37	CS1
18	DATA 15	38	CS3
19	GND	39	ACTIVE
20	KEY	40	GND



Table 10: Pin assignments - secondary IDE (40-pin, RM 2.54 mm)

RAM (DIMM modules)

The Intel 825E chipset supports a maximum memory of 512 MByte. Memory chips can be added from 8 - 512 MByte PC100 or PC133 SDRAM (64-bit) DIMM modules.

Primary IDE (40-pin, RM 2.54 mm)

When connecting a device to this 40-pin primary IDE port, be sure that no other device is connected to the second 44-pin primary IDE port, as this can cause a conflict.

Pin	Assignment	Pin	Assignment
1	RESET	21	DREQ
2	GND	22	GND
3	DATA 7	23	IOW
4	DATA 8	24	GND
5	DATA 6	25	IOR
6	DATA 9	26	GND
7	DATA 5	27	IOCHRDY
8	DATA 10	28	GND
9	DATA 4	29	DACK
10	DATA 11	30	GND
11	DATA 3	31	IRQ 14
12	DATA 12	32	N.C.
13	DATA 2	33	ADDR1
14	DATA 13	34	ATA66 cable detect
15	DATA 1	35	ADDR0
16	DATA 14	36	ADDR2
17	DATA 0	37	CS1
18	DATA 15	38	CS3
19	GND	39	ACTIVE
20	KEY	40	GND



Table 11: Pin assignments - primary IDE (40-pin, RM 2.54 mm)

Primary IDE (44-pin, RM 2 mm)

When connecting a device to this 44-pin primary IDE port, be sure that no other device is connected to the second 40-pin primary IDE port, as this can cause a conflict.

Pin	Assignment	Pin	Assignment
1	RESET	23	IOW
2	GND	24	GND
3	DATA 7	25	IOR
4	DATA 8	26	GND
5	DATA 6	27	IOCHRDY
6	DATA 9	28	GND
7	DATA 5	29	DACK
8	DATA 10	30	GND
9	DATA 4	31	IRQ 14
10	DATA 11	32	N.C.
11	DATA 3	33	ADDR1
12	DATA 12	34	ATA66 cable detect
13	DATA 2	35	ADDR0
14	DATA 13	36	ADDR2
15	DATA 1	37	CS1
16	DATA 14	38	CS3
17	DATA 0	39	ACTIVE
18	DATA 15	40	GND
19	GND	41	VCC
20	N.C.	42	VCC
21	DREQ	43	GND
22	GND	44	N.C.



Table 12: Pin assignments - primary IDE (44-pin, RM 2mm)

Floppy interface

Is a standard floppy interface. If a floppy/CD-ROM/CD-RW/DVD etc. combination is installed on the APC, the floppy drive can be connected here.

Pin	Assignment	Pin	Assignment
1	GND	18	$\overline{\text{DIR}}$
2	DENSEL	19	GND
3	GND	20	$\overline{\text{STEP}}$
4	N.C.	21	GND
5	GND	22	$\overline{\text{WDATA}}$
6	DRH0	23	GND
7	GND	24	$\overline{\text{WGATE}}$
8	$\overline{\text{INDEX}}$	25	GND
9	GND	26	$\overline{\text{TRK00}}$
10	$\overline{\text{MOTEO}}$	27	GND
11	GND	28	WP
12	$\overline{\text{DRVS1}}$	29	DETECT
13	GND	30	$\overline{\text{RDATA}}$
14	$\overline{\text{DRVS0}}$	31	GND
15	GND	32	$\overline{\text{SIDE}}$
16	$\overline{\text{MOTET}}$	33	N.C.
17	GND	34	$\overline{\text{DSKCHG}}$

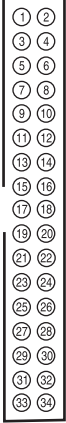

Table 13: Pin assignments - floppy interface

Front panel, ATX signals

With this plug option, various status displays for the Slot CPU can be visualized externally (e.g. on a Panel), and buttons/keys can be added to control various functions.

Pin	Assignment
1	GND
2	+ 5 V
3	Reset button
4	Alarm LED + (pull up)
5	Pull up - power ON
6	Alarm LED control
7	Power-on
8	Speaker
9	Power supply LED
10	Power supply LED
11	Power LED control
12	HDD LED control
13	Supply ON
14	5 V standby
15	Power OK
16	Reserved
17	Speed indicator pulse 1
18	PWM fan out 1
19	Speed indicator pulse 2
20	PWM fan out 2

The diagram shows a 20-pin connector with the following connections:

- Reset button: Pins 3 and 4
- Power ON button: Pins 5 and 6
- Power LED: Pins 9 and 10
- Alarm LED: Pins 4 and 6
- Speaker: Pins 8 and 10
- HDD LED: Pins 11 and 12

Table 14: Pin assignments - front panel

COM1

Warning

Only B&R interface adapters can be connected to this plug.

Uses a TTL level.

Pin	Assignment	
1	DCD	
2	RXD	
3	TXD	
4	DTR	
5	GND	
6	DSR	
7	RTS	
8	CTS	
9	RI	
10	+ 12 V	

Table 15: Pin assignments - COM1

COM3

Warning

Only B&R interface adapters can be connected to this plug.

Uses a TTL level.

Pin	Assignment	
1	DCD	
2	RXD	
3	TXD	
4	DTR	
5	GND	
6	DSR	
7	RTS	
8	CTS	
9	RI	
10	+ 12 V	

Table 16: Pin assignments - COM3

COM4

Warning

Only B&R interface adapters can be connected to this plug.

Uses a TTL level.

Pin	Assignment	
1	DCD	
2	RXD	
3	TXD	
4	DTR	
5	GND	
6	DSR	
7	RTS	
8	CTS	
9	RI	
10	+ 12 V	

Table 17: Pin assignments - COM4

LPT

Standard parallel port connection.

Pin	Assignment	Pin	Assignment	
1	STROBE	14	GND	
2	AUTOFD	15	DATA6	
3	DATA0	16	GND	
4	ERROR	17	DATA7	
5	DATA1	18	GND	
6	INIT	19	ACK	
7	DATA2	20	GND	
8	SEL in	21	BUSY	
9	DATA3	22	GND	
10	GND	23	PE	
11	DATA4	24	GND	
12	GND	25	SEL Out	
13	DATA5	26	N.C. (optional + 5 V)	

Table 18: Pin assignments - LPT

Sound adapter

The optional B&R sound adapter AC97 LPT (model number 5SO680.1000-00) can be plugged in here.

Pin	Assignment	Pin	Assignment
1	AC reset	11	Speaker
2	GND	12	+ 5 V
3	AC SDOOUT	13	AC SDIN1
4	GND	14	+ 5 V
5	AC SDINO	15	+ 3.3 V
6	GND	16	+ 12 V
7	AC SYNC	17	+ 3.3 V
8	GND	18	+ 12 V
9	AC CLOCK	19	SMBCLK
10	GND	20	SMBDATA

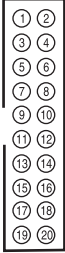

Table 19: Pin assignments - APC sound adapter

CMOS battery holder (RTC)

A lithium battery (3 V, 950 mAh) is plugged in here, which keeps the CMOS memory and real-time clock (RTC) running when the supply voltage for the IPC680 has been switched off. The buffer duration of the battery is at least 4 years (at 55 °C, 8.5 µA current requirements of the supplied components and a self discharge of 40%). The battery status (good or bad) can be queried using software. From the time the battery voltage is recognized as insufficient (2.50 volts), data buffering is guaranteed for approximately another 170 hours.

When changing or removing the battery, data is buffered for approximately another 5 hours by a gold leaf capacitor.

Hardware security key

The Slot CPU has a slot for a hardware security key (dongle), which is required for software protection.

SMC - System Management Controller

The Slot CPU has a **S**ystem **M**anagement **C**ontroller (SMC), which monitors reset information. When the reset button is pressed, or a power failure is detected, a **N**on **M**askable **I**nterrupt (NMI) is generated with NMI status. After the tReset time (can be set under the OEM features in BIOS) the CPU reset is then triggered. This function is not required by B&R Automation Runtime™ at the moment.

Features

- Configuration via serial I²C bus
- Watchdog deactivated after reset
- NMI status generated after SMC reset event (due to reset button or power failure)
- Defined time (0-63 ms) between the 1st alarm event and the processor reset

Graphics adapter connection

On the back side of the Slot CPU there is a plug for connecting the DVI/COM/12V graphics adapter (model number 5GA680.1000-00). The materials needed for mounting are included with the graphic adapter.

Infrared connection

Standard infrared connection.

Pin	Assignment	
1	+ 5 V	
2	N.C.	
3	IRRX	
4	GND	
5	IRTX	

Table 20: Pin assignments - infrared connection

BIOS

The AWARD Modular BIOS 6.0 is used. More detailed description of the BIOS setup pages can be found in the "Software" chapter.

Configuration switch

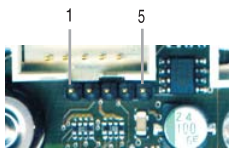
Reserved. Must not be changed.

ATX power

Optional connection for an ATX power supply.

Pin	Assignment	Pin	Assignment
1	+ 3.3 V	11	+ 3.3 V
2	+ 3.3 V	12	- 12 V
3	GND	13	GND
4	+ 5 V	14	PS ON
5	GND	15	GND
6	+ 5 V	16	GND
7	GND	17	GND
8	Power OK	18	- 5 V
9	5 V standby	19	+ 5 V
10	+ 12 V	20	+ 5 V

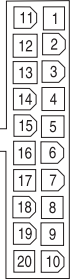

Table 21: Pin assignments - ATX power

Universal socket 370

A universal socket 370 enables use of the following processors:

- FC-PGA Celeron processors with 128 kByte cache 566 MHz with 66 MHz and 100 MHz FSB
- FC-PGA2 Celeron processors with 256 kByte cache and 100 MHz FSB
- FC-PGA Pentium 3 processors with 256 kByte cache from 600 MHz up to 1 GHz with 100 MHz FSB and 133 MHz FSB
- FC-PGA2 Pentium 3 processors with 512 kByte cache (Tualatin) with 133 MHz FSB

Beeper

There is a beeper on the back side of the Slot CPU that reports BIOS status and error messages acoustically.

CPU fan

Optional component.

An optional CPU fan can be connected that does not operate with speed control, but rather runs full speed all the time.

The speed of the fan is monitored in order to be able to react should it ever break down. An alarm is triggered when the speed falls below approx. 2650 rpm.

To activate this function, in the BIOS menu "Special OEM Features" under item "Statistics Motherboard" switch the "CPU Fan Alarm" function to "Enabled".

Housing fan

Optional component.

The two housing fans can be connected here directly. These have speed control and the speed is monitored. Speed configurations can be set under the BIOS menu "Special OEM Features" under the item "Fan speed max by".

4. Backplane / bus board

Model number	Short description	Note
5BP680.1000-00	7-slot backplane (1I/2M/4P) APC680 backplane with total 7 slots: 1 ISA, 2 PICMG and 4 PCI slots. Supplied via APC680 power supply or via ATX power supply.	
5BP680.1000-01	1-slot backplane (0I/1M/0P) APC680 backplane with one PICMG slot, to be mounted in the housing	
5BP680.1000-02	7-slot backplane (1I/2M/4P) 3V3 APC680 backplane with total 7 slots: 1 ISA, 2 PICMG and 4 PCI slots. (with onboard 3.3 V power supply for the PCI slots)	

4.1 7-slot backplane 5BP680.1000-00

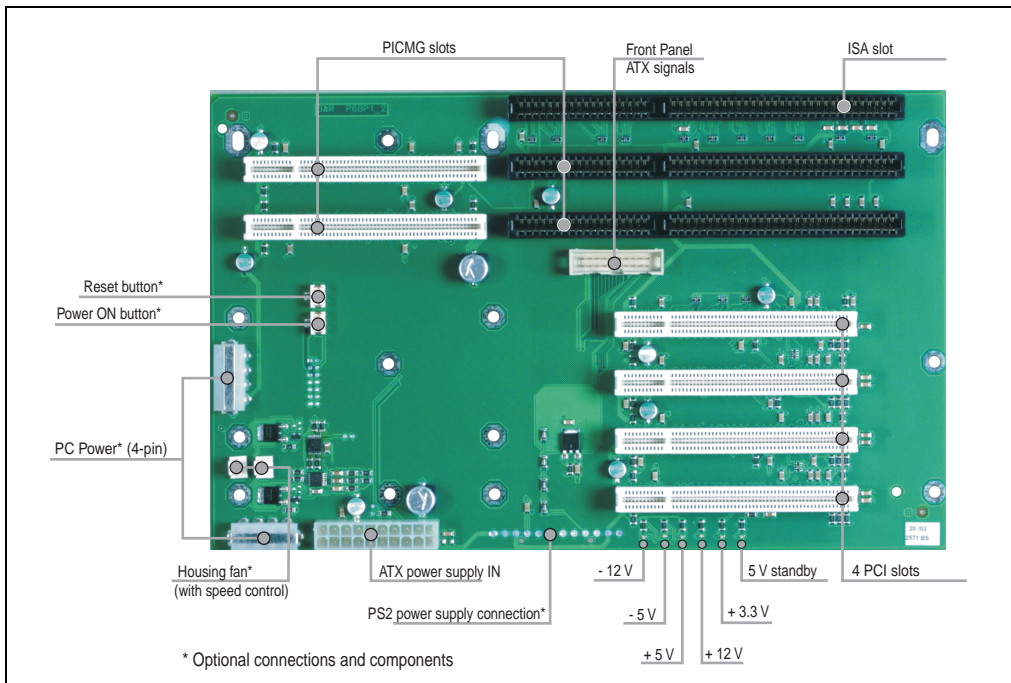

Figure 8: Components - 35BP680.1000-00

4.1.1 Technical data

Features	5BP680.1000-00
Environmental temperature Operation Storage Transport	0 °C to +60 °C -30 °C to +80 °C -30 °C to +80 °C
Humidity Operation Storage Transport	5 - 95 % non-condensing 5 - 95 % non-condensing 5 - 95 % non-condensing
Weight	Approx. 0.4 kg

Table 22: Technical data - 5BP680.1000-00

4.1.2 Connector / plug descriptions

PICMG slots

These slots are reserved for the Slot CPU.

Information:

If the Slot CPU is inserted in the inner PICMG slot, no standard PCI 32-bit full-size card can be inserted in the next two PCI slots due to the size of the CPU's heat sink. Standard PCI 32-bit half-size cards can be inserted without a problem.

Front panel, ATX signals

With this plug option, various status displays for the Slot CPU can be visualized externally (e.g. on a Panel), and buttons/keys can be added to control various functions (e.g. fan control). This plug connects the backplane to the Slot CPU.

Pin	Assignment
1	GND
2	+ 5 V
3	Reset button
4	Alarm LED + (pull up)
5	Pull up - power ON
6	Alarm LED control
7	Power-on
8	Speaker
9	Power supply LED
10	Power supply LED
11	Power LED control
12	HDD LED control
13	Supply ON
14	5 V standby
15	Power OK
16	Reserved
17	Speed indicator pulse 1
18	PWM fan out 1
19	Speed indicator pulse 2
20	PWM fan out 2

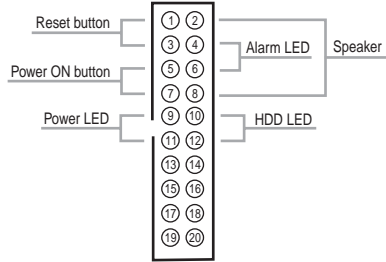

Table 23: Pin assignments - front panel

The front panel ATX signals (reset button, alarm LED, HDD LED, power ON button and Speaker) can be called up via an optional 14-pin plug.

ISA slot

An ISA card can be inserted.

PCI slot

Up to 4 PCI cards can be inserted.

Status LEDs for the supply voltage

The 6 red control LEDs indicate the available voltages on the backplane (see figure "Components - 35BP680.1000-00", on page 51).

PS2 power supply connection

Optional component for connecting a PS2 power supply.

ATX power

Optional connection for an ATX power supply.

Pin	Assignment	Pin	Assignment
1	+ 3.3 V ¹⁾	11	+ 3.3 V ¹⁾
2	+ 3.3 V ¹⁾	12	- 12 V
3	GND	13	GND
4	+ 5 V	14	PS ON ³⁾
5	GND	15	GND
6	+ 5 V	16	GND
7	GND	17	GND
8	Power OK	18	- 5 V ²⁾
9	5 V standby ³⁾	19	+ 5 V
10	+ 12 V	20	+ 5 V

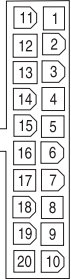

Table 24: Pin assignments - ATX power backplane

1) Not necessary, only for backplane PCI plug

2) Not necessary, as it is generated on the backplane

3) Only necessary for ATX Power ON

Housing fan

Optional component.

The two ball-bearing housing fans (\varnothing 120 mm each) can be connected here, which are then speed controlled based on temperature.

PC power (4-pin)

Optional component.

2 optional devices (such as 3.5" HDD, B&R hard disk adapter, FDD/CD combination) can be supplied here.

Optional backplane PC power connection

Table 25: Pin assignments - PC power (4-pin)

Power ON button

Optional component.

A power on button can be connected.
This function is only supported by an ATX power supply.

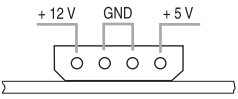
Reset button

Optional component.

An optional reset button can be connected here.

4.2 1-slot backplane 5BP680.1000-01

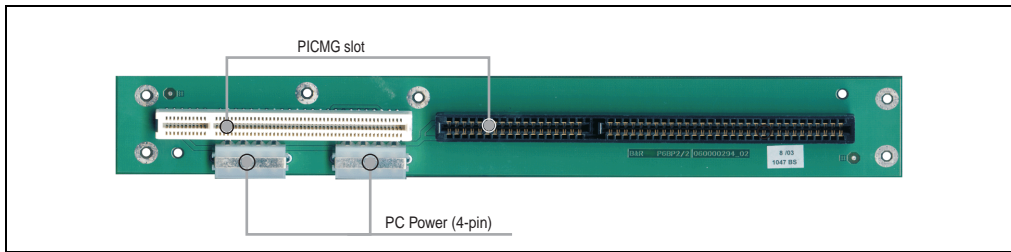

Figure 9: Components - 5BP680.1000-01

This 1-slot backplane can be easily mounted in the housing and creates a standard PICMG slot and additional supply voltage connections (PC power) for the Slot CPU.

4.2.1 Technical data

Features	5BP680.1000-01
Environmental temperature	
Operation	0 °C to +60 °C
Storage	-30 °C to +80 °C
Transport	-30 °C to +80 °C
Humidity	
Operation	5 - 95 % non-condensing
Storage	5 - 95 % non-condensing
Transport	5 - 95 % non-condensing
Weight	Approx. 0.1 kg

Table 26: Technical data - 5BP680.1000-01

4.2.2 Connector / plug descriptions

PICMG slots

This slot is reserved for the Slot CPU.

PC power (4-pin)

Optional component.

2 optional devices (such as 3.5" HDD, B&R hard disk adapter, FDD/CD combination) can be supplied here.

Optional backplane PC power connection

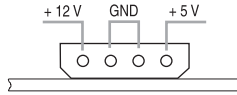

Table 27: Pin assignments - PC power (4-pin)

4.3 7-slot backplane 5BP680.1000-02

This backplane is identical to the 5BP680.1000-00 backplane, except that it has a power supply for the PCI slots with 3.3V onboard.

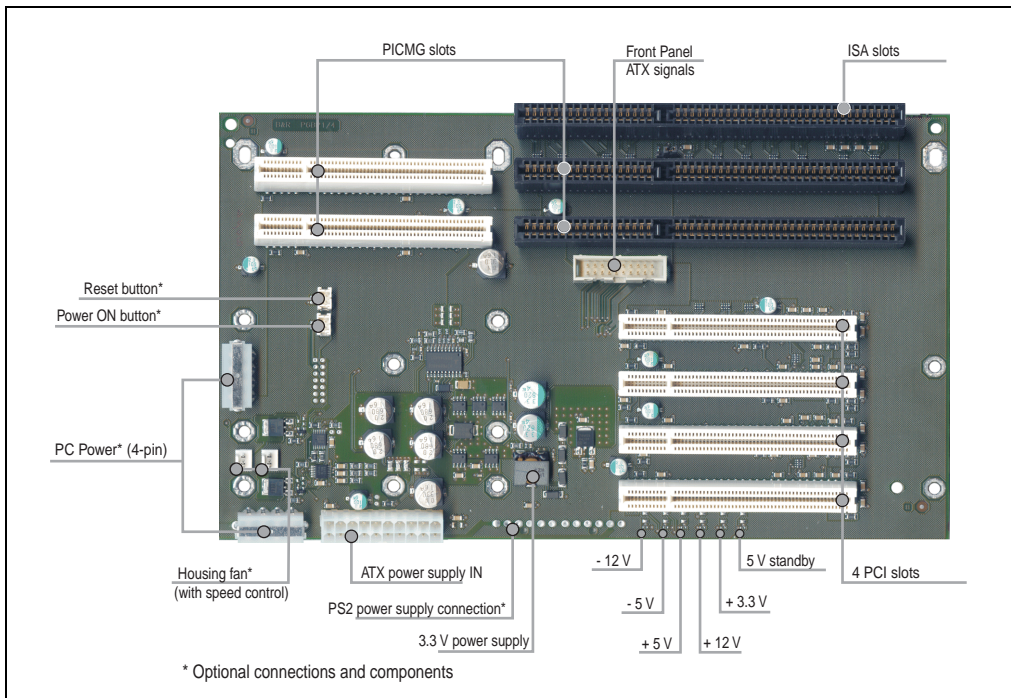

Figure 10: Components - 5BP680.1000-02

4.3.1 Technical data

Features	5BP680.1000-02
Environmental temperature	
Operation	0 °C to +60 °C
Storage	-30 °C to +80 °C
Transport	-30 °C to +80 °C

Table 28: Technical data - 5BP680.1000-02

Features	5BP680.1000-02
Humidity	
Operation	5 - 95 % non-condensing
Storage	5 - 95 % non-condensing
Transport	5 - 95 % non-condensing
Weight	Approx. 0.4 kg

Table 28: Technical data - 5BP680.1000-02 (cont.)

4.3.2 Connector / plug descriptions

PICMG slots

These slots are reserved for the Slot CPU.

Information:

If the Slot CPU is inserted in the inner PICMG slot, no standard PCI 32-bit full-size card can be inserted in the next two PCI slots due to the size of the CPU's heat sink. Standard PCI 32-bit half-size cards can be inserted without a problem.

Front panel, ATX signals

With this plug option, various status displays for the Slot CPU can be visualized externally (e.g. on a Panel), and buttons/keys can be added to control various functions (e.g. fan control). This plug connects the backplane to the Slot CPU.

Pin	Assignment
1	GND
2	+ 5 V
3	Reset button
4	Alarm LED + (pull up)
5	Pull up - power ON
6	Alarm LED control
7	Power-on
8	Speaker
9	Power supply LED
10	Power supply LED
11	Power LED control
12	HDD LED control
13	Supply ON
14	5 V standby
15	Power OK
16	Reserved
17	Speed indicator pulse 1
18	PWM fan out 1
19	Speed indicator pulse 2
20	PWM fan out 2

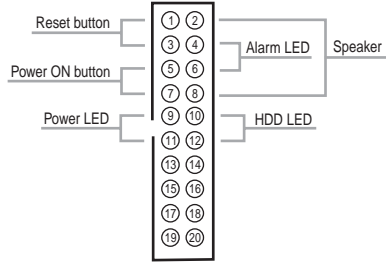

Table 29: Pin assignments - front panel

The front panel ATX signals (Reset button, Alarm LED, HDD LED, Power ON button and Speaker) can be called up via an optional 14-pin plug.

ISA slot

An ISA card can be inserted.

PCI slot

Up to 4 PCI cards can be inserted.

3.3 V power supply

The 3.3 V onboard power supply feeds the PCI slots.

Status LEDs for the supply voltage

The 6 red control LEDs indicate the available voltages on the backplane (see figure "Components - 5BP680.1000-02", on page 57).

PS2 power supply connection

Optional component for connecting a PS2 power supply.

ATX power

Optional connection for an ATX power supply.

Pin	Assignment	Pin	Assignment
1	+ 3.3 V ¹⁾	11	+ 3.3 V ¹⁾
2	+ 3.3 V ¹⁾	12	- 12 V
3	GND	13	GND
4	+ 5 V	14	PS ON ³⁾
5	GND	15	GND
6	+ 5 V	16	GND
7	GND	17	GND
8	Power OK	18	- 5 V ²⁾
9	5 V standby ³⁾	19	+ 5 V
10	+ 12 V	20	+ 5 V



Table 30: Pin assignments - ATX power backplane

1) Not necessary, only for backplane PCI plug

2) Not necessary, as it is generated on the backplane

3) Only necessary for ATX Power ON

Housing fan

Optional component.

The two ball-bearing housing fans (Ø 120 mm each) can be connected here, which are then speed controlled based on temperature.

PC power (4-pin)

Optional component.

2 optional devices (such as 3.5" HDD, B&R hard disk adapter, FDD/CD combination) can be supplied here.

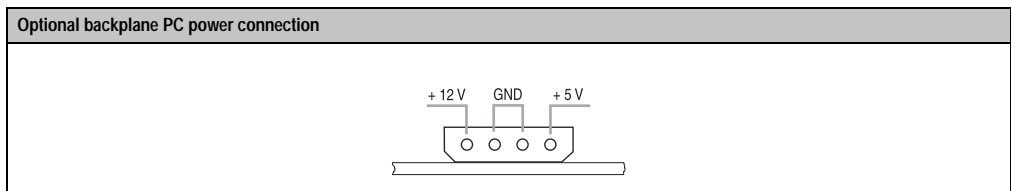

Table 31: Pin assignments - PC power (4-pin)

Power ON button

Optional component.

A Power ON button can be connected.
This function is only supported by an ATX power supply.

Reset button

Optional component.

An optional Reset button can be connected here.

5. Power supply

A standard PC power supply (PS2 or ATX) and an open frame industrial power supply can be mounted in the housing.

One industrial power supply is installed standard:

Model number	Short description	Note
5PS680.AC01-01	Power supply 115/230 VAC w/24V Supply voltage 85 - 132 VAC / 170-264 VAC autoselect, 47-63 Hz, max. 110 Watts at 55 °C, additional 24 VDC plug for the graphics adapter 5GA680.1000-01	

5.1 Power supply 5PS680.AC01-01

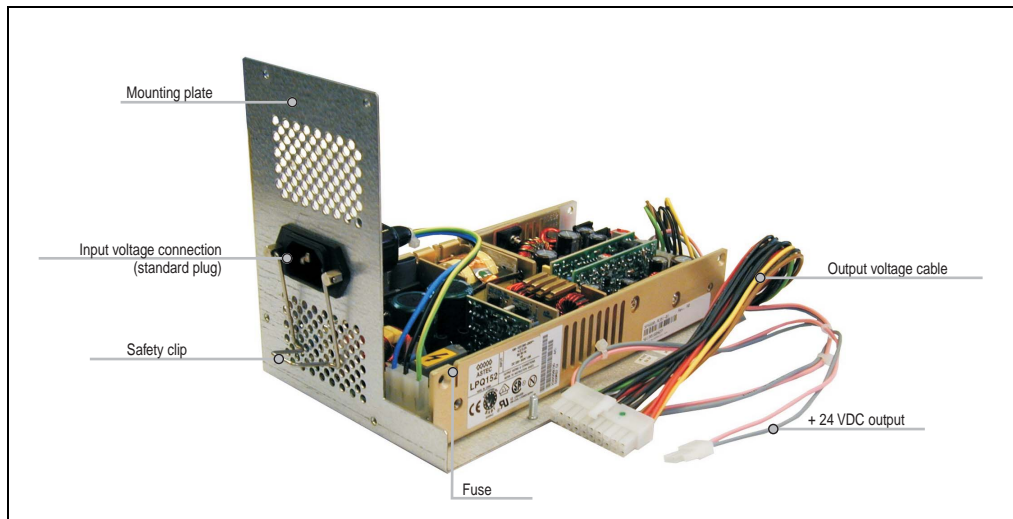

Figure 11: Components - 5PS680.AC01-01

5.1.1 Technical data

Features	5PS680.AC01-01
Supply voltage	85-132 VAC / 170-264 VAC autoselect - the middle range cannot be used! 220 - 370 VDC
Frequency	47-63 Hz
Power consumption	Approx. 175 watts supply voltage side with fully equipped APC680
Power consumption	Max. 125 watts (with housing fans operating in the 5HS680.1000-01 housing) at 55 °C

Table 32: Technical data - 5PS680.AC01-01

Features	5PS680.AC01-01
Output voltages	+ 5 volts (2-22 amps) + 12 volts (0.1 - 8 amps) - 12 volts (0.1 - 2 amps) + 24 volts (0 - 2 amps)
Environmental temperature Operation Storage Transport	0 °C to +50 °C -40 °C to +85 °C -40 °C to +85 °C
Humidity Operation Storage Transport	5 - 95 % (non-condensing)
Weight	Approx. 1.4 kg
MTBF	> 550,000 hours

Table 32: Technical data - 5PS680.AC01-01 (cont.)

Power is supplied by the included standard plug. The safety clip only fits the included standard plug.

The power supply has a built-in fuse (Type: F5A H250V), which is not accessible from outside.

6. Graphics adapter

Model number	Short description	Note
5GA680.1000-01	Graphics adapter DVI RS232 24V Outputs: DVI-I, COM and 24 VDC	

6.1 Graphics adapter 5GA680.1000-01

6.1.1 General information

The graphics adapter 5GA680.1000-01 is an addition to the APC680 Slot CPU and makes the graphics interface more adaptable. The connector on the graphics adapter is connected with the appropriate plug on the Slot CPU and fastened with screws.

6.1.2 Technical data

Features	5GA680.1000-01
Environmental temperature	
Operation	0 °C to +60 °C
Storage	-30 °C to +80 °C
Transport	-30 °C to +80 °C
Humidity	
Operation	5 - 95 % non-condensing
Storage	5 - 95 % non-condensing
Transport	5 - 95 % non-condensing
Weight	Approx. 0.1 kg

Table 33: Technical data - 5GA680.1000-01

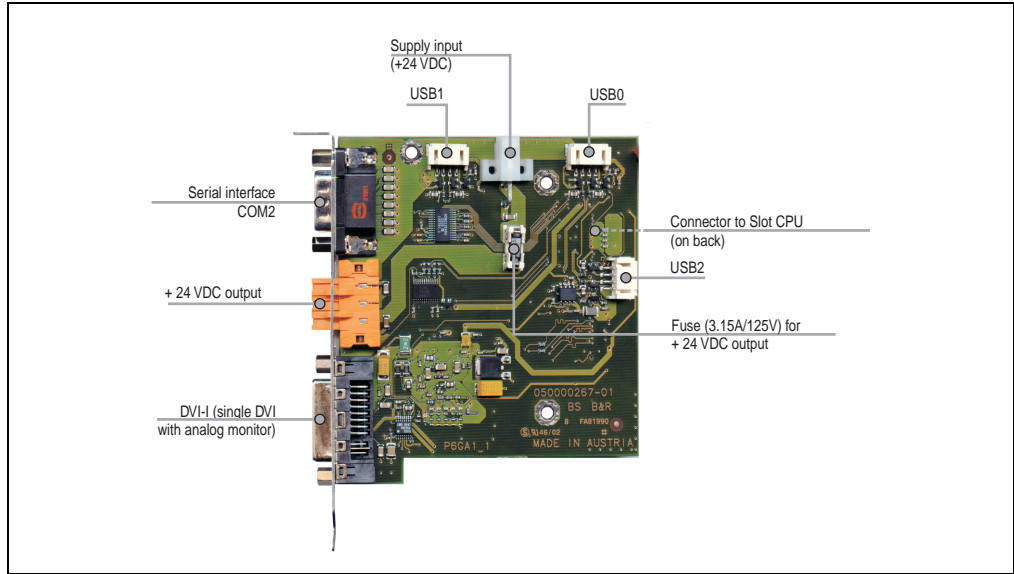

Figure 12: Components - 5GA680.1000-01

The graphics adapter has a 3.15 A/125 V fuse (type: small fuse for surface mounting, type OMF 125 fast-acting F) This fuse protects the +24 VDC output (e.g. for an Automation Panel).

6.1.3 Dimensions

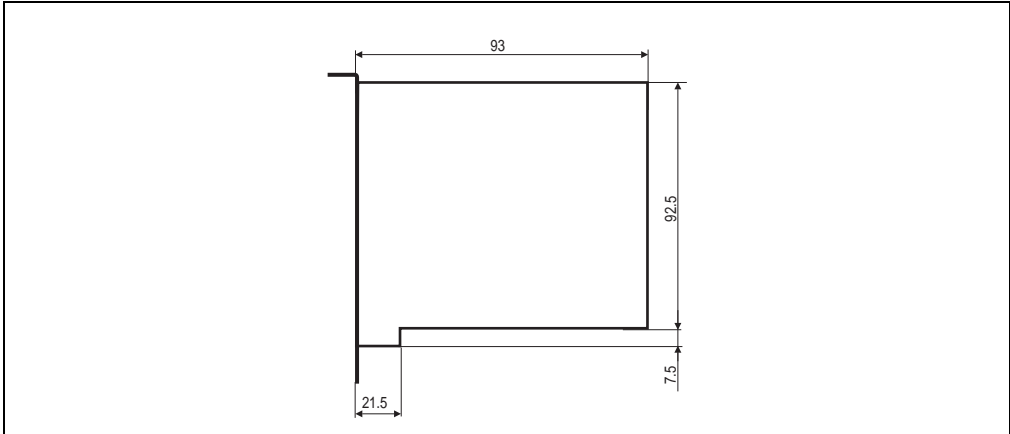

Figure 13: Dimensions - graphics adapter

6.1.4 Interface descriptions

Serial interface COM2

This interface serves for the connection of, for example, the serial interface of a touch screen display unit. The connection is established via a 9-pin DSUB plug.

Pin	Assignment	
1	DCD	
2	RXD	
3	TXD	
4	DTR	
5	GND	
6	DSR	
7	RTS	
8	CTS	
9	RI	

Table 34: Pin assignments - touch / supply interfaces

+24 VDC output

A remote Automation Panel that requires +24 VDC, for example, could be connected here.

Pin	Assignment	
1	-	
2	Ground	
3	+	

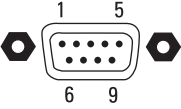
Table 35: Pin assignments - +24VDC output

Maximum current consumption: 2 A

Warning!

This output is supplied by the Automation PC power supply along with other components. It is therefore important to be sure that the total power consumption of all components (e.g. hard drive, other drives, etc.) does not exceed the MAXIMUM rated value for the power supply.

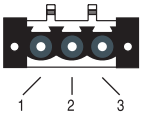
The plug required to connect the cable is NOT delivered with the device.

DVI-I (single DVI with analog monitor)

Pin	Assignment	Pin	Assignment
1	T.M.D.S. DATA 2-	13	N.C.
2	T.M.D.S. DATA 2+	14	+ 5V power
3	T.M.D.S. DATA 2/4 shield	15	Ground (return for + 5V, HSync and VSync)
4	N.C.	16	Hot Plug detect
5	N.C.	17	T.M.D.S. DATA 0-
6	DDC CLOCK	18	T.M.D.S. DATA 0+
7	DDC DATA	19	T.M.D.S. DATA 0/5 shield
8	Analog vertical sync	20	N.C.
9	T.M.D.S. DATA 1-	21	N.C.
10	T.M.D.S. DATA 1+	22	T.M.D.S. clock shield
11	T.M.D.S. DATA 1/3 shield	23	T.M.D.S. clock +
12	N.C.	24	T.M.D.S. clock -
c1	Analog RED	c4	Analog horizontal sync
c2	Analog GREEN	c5	Analog ground (analog R, G and B return)
c3	Analog BLUE		

Table 36: Pin assignments - DVI-I (single DVI with analog monitor) 5GA680.1000-01

6.1.5 Connector / plug descriptions

USB0, USB1, USB2

The graphics adapter 5GA680.1000-01 has 3 optional USB connections (numbers 0, 1 and 2, USB 1.1, max. 12 MBit), which can be utilized for USB devices with the appropriate adapter (see chapter 5 "Accessories" section 5 "USB port adapter 5AC680.USB3-00" on page 146).

Warning!

Because of general PC specifications, this interface should be handled with extreme care with regard to EMC, location of cables etc.

Supply input (+ 24 VDC)

The 2-pin cable from the power supply 5PS680.AC01-01 is connected to this 2-pin plug.

7. Processors

The following processors are available from B&R for use with the Slot CPU:

Model number	Short description	Note
5CPICP.0566-00	Processor ICP 566/66 128k H1 Intel Celeron® processor 566/66, 32 kB L1 cache, 128 kB L2 cache. Only available with an APC680 Slot CPU.	
5CPICP.0733-00	Processor ICP 733/66 128k H1 Intel Celeron® processor 733 MHz with 66 MHz FSB, 32 kB L1 cache, 128 kB L2 cache. Only available with an APC680 Slot CPU.	
5CPICP.0850-00	Processor ICP 850/100 128k H1 Intel Celeron® processor 850 MHz with 100 MHz FSB, 32 kB L1 cache, 128 kB L2 cache. Only available with an APC680 Slot CPU.	
5CPICP.1200-00	ICP processor 1.2/100 256k F2 Intel Celeron® processor 1.2 GHz with 100 MHz FSB, 32 kB L1 cache, 256 kB L2 cache, with active fan. Only available with an APC680 Slot CPU.	
5CPIP3.1260-00	IP3 processor 1.26/133 512k F2 Intel Pentium® processor 1.26 GHz with 133 MHz FSB, 32 kB L1 cache, 512 kB L2 cache, with active fan. Only available with an APC680 Slot CPU.	

7.1 Technical data

Information:

The specified limits listed here like for example, environmental temperature, power consumption, and current consumption, only apply to his accessory and do not also automatically apply to the whole terminal.

	5CPICP.0566-00	5CPICP.0733-00	5CPICP.0850-00	5CPICP.1200-00	5CPIP3.1260-00
Max. power consumption with 128 MB RAM [W]	22	25	27	31	32
Max. power consumption with 512 MB RAM [W]	25	28	30	34	35
Max. current consumption with 128 MB RAM [A] at +5 volts	6	6	6	6	6
Max. current consumption with 512 MB RAM [A] at + 5 volts	8	8	8	8	8
Max. current consumption with 128 MB RAM [A] at + 12 volts	0.5	0.5	0.5	0.5	0.5
Max. current consumption with 512 MB RAM [A] at + 12 volts	0.5	0.5	0.5	0.5	0.5

Table 37: Technical data - processors

	5CPICP.0566-00	5CPICP.0733-00	5CPICP.0850-00	5CPICP.1200-00	5CPIP3.1260-00
Environmental temperature					
Operation ¹⁾	+5 °C to +55 °C	+5 °C to +55 °C	+5 °C to +50 °C	+5 °C to +45 °C	+5 °C to +45 °C
Operation with filter kit ¹⁾	+5 °C to +50 °C	+5 °C to +50 °C	+5 °C to +45 °C	+5 °C to +40 °C	+5 °C to +40 °C
Storage	-40 °C to +85 °C	-40 °C to +85 °C	-40 °C to +85 °C	-40 °C to +85 °C	-40 °C to +85 °C
Transport	-40 °C to +85 °C	-40 °C to +85 °C	-40 °C to +85 °C	-40 °C to +85 °C	-40 °C to +85 °C
Weight	Approx. 0.12 kg	Approx. 0.12 kg	Approx. 0.15 kg	Approx. 0.16 kg	Approx. 0.16 kg

Table 37: Technical data - processors (cont.)

1) The maximum environmental temperatures listed here were determined under worst-case conditions using the application software HiPower 3.0 from Intel and B&R Automation Runtime. Experience has shown, however, that higher environmental temperatures can be reached under typical conditions, e.g. using Microsoft Windows. The testing and evaluation is to be done on-site by the user (reading the temperatures in BIOS - see chapter 4 "Software", section 4.1.5 "Special OEM feature" on page 128, or in Windows - see chapter 4 "Software", section 5 "B&R IPC Diagnostics Utility" on page 136).

7.2 Cooling systems

Depending on version (H1 or F2) the processors have either an active heat sink (with fan) or a passive heat sink.

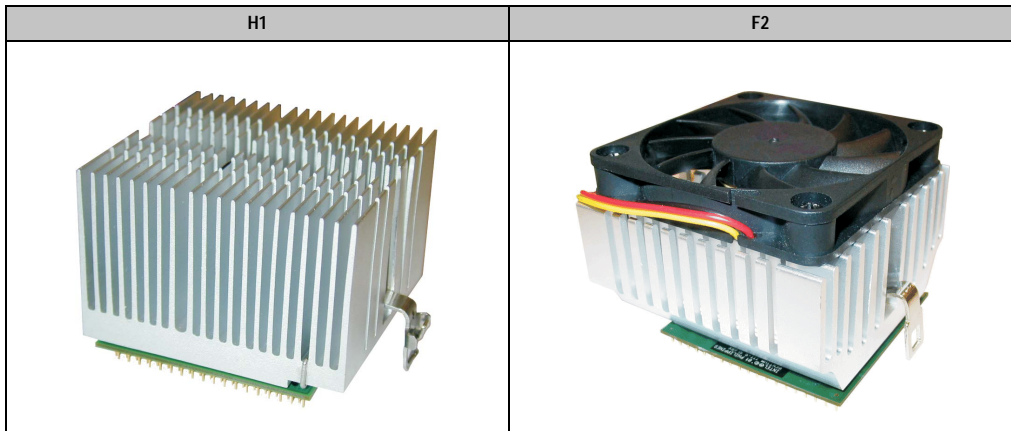

Table 38: Heat sink types

Information:

If the Slot CPU is inserted in the inner PICMG slot, no standard PCI 32-bit full-size card can be inserted in the next two PCI slots due to the size of the CPU's heat sink. Standard PCI 32-bit half-size cards can be inserted without a problem.

8. Main memory

The RAM modules are available from B&R for use with the Slot CPU:

Model number	Description	Image
5MMSDR.0128-00	DIMM SDRAM - 128 MB PC133 CL2 16Mx64 (168-pin) DIMM module - 128 MB, 133 MHz 168-pin ORIGINAL CL2	
5MMSDR.0256-00	DIMM SDRAM - 256 MB PC133 CL2 16Mx64 (168-pin) DIMM module - 256 MB, 133 MHz 168-pin ORIGINAL CL2	
9A0004.11	DIMM SDRAM - PC100 64 MB 8 MB x 64 (168-pin) DIMM module - 64 MB, 100 MHz 168-pin	
9A0004.12	DIMM SDRAM - PC100 128 MB 16 MB x 64 (168-pin) DIMM module - 128 MB, 100 MHz 168-pin	
9A0004.14	DIMM SDRAM - PC100 256 MB 32 MB x 64 DIMM module - 256 MB, 100 MHz 168-pin	

Table 39: Order data - RAM

8.1 Technical data

Information:

The specified limits listed here only apply to his accessory and do not also automatically apply to the whole terminal.

	5MMSDR.0128-00	5MMSDR.0128-00	9A0004.11	9A0004.12	9A0004.14
Environmental temperature					
Operation	0 °C to +70 °C	0 °C to +70 °C	0 °C to +70 °C	0 °C to +70 °C	0 °C to +70 °C
Storage	-55 °C to +155 °C	-55 °C to +155 °C	-55 °C to +155 °C	-55 °C to +155 °C	-55 °C to +155 °C
Transport	-55 °C to +155 °C	-55 °C to +155 °C	-55 °C to +155 °C	-55 °C to +155 °C	-55 °C to +155 °C
Humidity					
Operation	5 - 95 % non-condensing				
Storage	5 - 95 % non-condensing				
Transport	5 - 95 % non-condensing				
Weight	Approx. 0.02 kg	Approx. 0.02 kg	Approx. 0.02 kg	Approx. 0.02 kg	Approx. 0.02 kg

Table 40: Technical data - processors

Information:

For the Slot CPU the memory can be expanded to a maximum of 512 MB!

9. Mass memory

Model number	Short description	Note
5CFCRD.0032-01	CompactFlash 32 MB True IDE SanDisk/R2 CompactFlash card with 32 MB Flash PROM, and true IDE/ATA interface	<i>Cancelled since 12/03</i>

Model number	Short description	Note
5CFCRD.0032-02	CompactFlash 32 MB True IDE SanDisk/A CompactFlash card with 32 MB Flash PROM, and true IDE/ATA interface	<i>Replacement type for 5CFCRD.0032-01</i>
5CFCRD.0064-01	CompactFlash 64 MB True IDE SanDisk/R2 CompactFlash card with 64 MB Flash PROM, and true IDE/ATA interface	<i>Cancelled since 12/03</i>
5CFCRD.0064-02	CompactFlash 64 MB True IDE SanDisk/A CompactFlash card with 64 MB Flash PROM, and true IDE/ATA interface	<i>Replacement type for 5CFCRD.0064-01</i>
5CFCRD.0128-01	CompactFlash 128 MB True IDE SanDisk/R2 CompactFlash card with 128 MB Flash PROM, and true IDE/ATA interface	<i>Cancelled since 12/03</i>
5CFCRD.0128-02	CompactFlash 128 MB True IDE SanDisk/A CompactFlash card with 128 MB Flash PROM, and true IDE/ATA interface	<i>Replacement type for 5CFCRD.0128-01</i>
5CFCRD.0128-01	CompactFlash 196 MB True IDE SanDisk/R2 CompactFlash card with 196 MB Flash PROM, and true IDE/ATA interface	<i>Cancelled since 07/03</i>
5CFCRD.0256-01	CompactFlash 256 MB True IDE SanDisk/R2 CompactFlash card with 256 MB Flash PROM, and true IDE/ATA interface	<i>Cancelled since 12/03</i>
5CFCRD.0256-02	CompactFlash 256 MB True IDE SanDisk/A CompactFlash card with 256 MB Flash PROM, and true IDE/ATA interface	<i>Replacement type for 5CFCRD.0256-01</i>
5CFCRD.0384-01	CompactFlash 384 MB True IDE SanDisk/R2 CompactFlash card with 384 MB Flash PROM, and true IDE/ATA interface	<i>Cancelled since 07/03</i>
5CFCRD.0512-01	CompactFlash 512 MB True IDE SanDisk/R2 CompactFlash card with 512 MB Flash PROM, and true IDE/ATA interface	<i>Cancelled since 12/03</i>
5CFCRD.0512-02	CompactFlash 512 MB True IDE SanDisk/A CompactFlash card with 512 MB Flash PROM, and true IDE/ATA interface	<i>Replacement type for 5CFCRD.0512-01</i>
5CFCRD.1024-02	CompactFlash 1024 MB True IDE SanDisk/A CompactFlash card with 1024 MB Flash PROM, and true IDE/ATA interface	
5CFCRD.2048-02	CompactFlash 2048 MB True IDE SanDisk/A CompactFlash card with 2048 MB Flash PROM, and true IDE/ATA interface	
5HD680.0020-00	Hard disk 20 GB UDMA100 Hard disk - 20 GB 2.5" (63.5 mm) practical slide-in design, permanently mounted, UDMA100	<i>Cancelled since 10/03</i>
5HD680.0030-00	Hard disk - 30 GB UDMA100 (MHT2030AR) Hard disk - 30 GB 2.5" (63.5 mm) practical slide-in design, permanently mounted, UDMA100	
5HD680.2x20-00	Hard disk - 2x20 GB M/S 2 hard disks - 20 GB 2.5" (63.5 mm) practical slide-in design, permanently mounted, UDMA33; delivered with matching hard disk switch to be inserted in a free slot on the APC, and the required cables.	<i>Cancelled since 10/03</i>
5HD680.2x30-00	Hard disk 2x30GB M/S (MHT2030AR) 2 hard disks - 30 GB 2.5" (63.5 mm) practical slide-in design, permanently mounted, UDMA33; delivered with matching hard disk switch to be inserted in a free slot on the APC, and the required cables.	

9.1 CompactFlash cards 5CFCRD.0xxx-01

9.1.1 General information

CompactFlash cards are easy-to-exchange memory media. Due to their robustness against environmental influences (e.g. temperature, shock, vibration, etc.), CompactFlash cards are ideal for use as memory media in industrial environments.

9.1.2 Order data

Model number	Description	Image
5CFCRD.0032-01	CompactFlash 32 MB ATA/True IDE	
5CFCRD.0064-01	CompactFlash 64 MB ATA/True IDE	
5CFCRD.0128-01	CompactFlash 128 MB ATA/True IDE	
5CFCRD.0128-01	CompactFlash 192 MB ATA/True IDE	
5CFCRD.0256-01	CompactFlash 256 MB ATA/True IDE	
5CFCRD.0384-01	CompactFlash 384 MB ATA/True IDE	
5CFCRD.0512-01	CompactFlash 512 MB ATA/True IDE	

Table 41: Order data - CompactFlash cards

9.1.3 Technical data

Information:

The specified limits listed here, like environmental temperature, relative humidity, shock and vibration, only apply to this accessory and do not also necessarily apply to the whole device.

Features	5CFCRD.0xxx-01
Environmental temperature Operation Storage Transport	0 °C to +60 °C -25 °C to +85 °C -25 °C to +85 °C
Humidity Operation/Storage	8% to 95%, non-condensing
Vibration Operation/Storage	Maximal 30 G peak to peak
Shock Operation/Storage	Maximal 3,000 G
Altitude	24,000 meters
MTBF (@ 25°C)	> 3,000,000 hours
Maintenance	None
Data reliability	<1 non-recoverable error in 10 ¹⁴ bits read <1 erroneous correction in 10 ²⁰ bits read
Clear/write procedures	> 2,000,000
Weight	11.4 g

Table 42: Technical data - CompactFlash cards 5CFCRD.0xxx-01

Features	5CFCRD.0xxx-01
Dimensions	
Length	36.4 ± 0.15 mm
Width	42.8 ± 0.10 mm
Thickness	3.3 mm ± 0.10 mm

Table 42: Technical data - CompactFlash cards 5CFCRD.0xxx-01 (cont.)

9.2 CompactFlash cards 5CFCRD.xxxx-02

9.2.1 General information

CompactFlash cards are easy-to-exchange memory media. Due to their robustness against environmental influences (e.g. temperature, shock, vibration, etc.), CompactFlash cards are ideal for use as memory media in industrial environments.

9.2.2 Order data

Model number	Description	Image
5CFCRD.0032-02	CompactFlash 32 MB True IDE SanDisk/A	
5CFCRD.0064-02	CompactFlash 64 MB True IDE SanDisk/A	
5CFCRD.0128-02	CompactFlash 128 MB True IDE SanDisk/A	
5CFCRD.0256-02	CompactFlash 256 MB True IDE SanDisk/A	
5CFCRD.0512-02	CompactFlash 512 MB True IDE SanDisk/A	
5CFCRD.1024-02	CompactFlash 1024 MB True IDE SanDisk/A	
5CFCRD.2048-02	CompactFlash 2048 MB True IDE SanDisk/A	

Table 43: Order data - CompactFlash cards

9.2.3 Technical data

Information:

The following defined characteristics, features and limit values are only valid for this accessory and can deviate from those of the entire device. For the entire device in which this accessory is installed, refer to the data given specifically for the entire device.

Technical data • Mass memory

Features	5CFCRD.xxxx-02
Environmental temperature Operation Storage Transport	0 °C to +70 °C -25 °C to +85 °C -25 °C to +85 °C
Humidity Operation/Storage	8% to 95%, non-condensing
Vibration Operation/Storage	Maximum 30 G (point to point)
Shock Operation/Storage	Maximum 3,000 G
Altitude	24,000 meters
MTBF (@ 25°C)	> 3,000,000 hours
Maintenance	None
Data reliability	< 1 unrecoverable error in 10 ¹⁴ bit read accesses < 1 faulty correction in 10 ²⁰ bit read accesses
Clear/write procedures	> 2,000,000 times
Weight	11.4 g
Dimensions Length Width Thickness	36.4 ± 0.15 mm 42.8 ± 0.10 mm 3.3 mm ± 0.10 mm

Table 44: Technical data - CompactFlash cards 5CFCRD.xxxx-02

9.3 Hard disk 5HD680.0020-00

9.3.1 General information

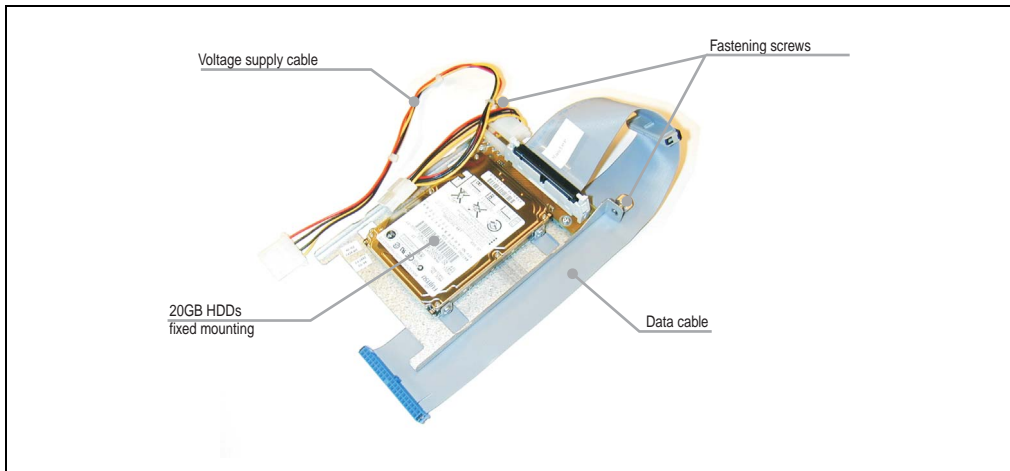

Figure 14: Components - 5HD680.0020-00

The hard disk is mounted on a practical slide-in frame for easy exchange. The frame is easily mounted in the APC680 housing with two mounting screws.

9.3.2 Technical data

Information:

The specified limits listed here, like environmental temperature, relative humidity, shock and vibration, only apply to this accessory and do not also necessarily apply to the whole device.

Features	5HD680.0020-00
Manufacturer's product ID	Fujitsu MHS2020AT-ED
Capacity	20 GB
Number of heads	2
Number of sectors (user)	39,070,080
Bytes per sector	512
Memory types	48 / 50 RLL
Track density	79,800 TPI
Bit density	550 kbp
Revolution speed	4,200 rpm ±1%
Access time (average)	7.14 ms
Positioning time (seek, typical values)	
Minimum (track to track)	1.5 ms
Average	12 ms
Maximum	22 ms
Starting time (0 rpm to read access)	3.5 seconds (typically)
Mounted on insert plate	Fixed
Interface	ATA-6
Data transfer rate	
To the medium	26.1 to 32.1 MB/s
To / from host	Max. 100 MB/s (Ultra-DMA Mode 5)
Cache	2 MB
Noise level (idle mode)	Approx. 24 dBA at 30 cm
MTBF (hours)	300,000
lifespan	5 years or 20,000 POH
Environmental temperature	
Operation - standard ¹⁾	+5 °C to +55 °C
Operation - 24 Hour	+5 °C to +45 °C
Storage	-40 °C to +60 °C
Transport	-40 °C to +60 °C

Table 45: Technical data - 20 GB hard disk

Technical data • Mass memory

Features	5HD680.0020-00
Humidity Operation Storage Transport	8 - 90 % non-condensing 5 - 95 % non-condensing 5 - 95 % non-condensing
Vibration Operation Storage	No non-recovered errors at max. 5 -500 Hz and 1.0 G (9.8 m/s ² 0-peak) No damage at max. 5 -500 Hz and 5 G (49 m/s ² 0-peak)
Shock (pulse with a sinus half-wave) Operation Storage	No non-recovered errors at max. 225 G (2207 m/s ² 0-peak) and 2 ms duration No damage at max. 900 G (8820 m/s ² 0-peak) and 1 ms duration No damage at max. 120 G (1176 m/s ² 0-peak) and 11 ms duration
Altitude Operation Storage	- 300 to 3,000 meters - 300 to 12,000 meters

Table 45: Technical data - 20 GB hard disk (cont.)

1) "Standard operation" of a hard disk assumes that it is turned on or off once every 12 hours.

9.4 Hard disk 5HD680.0030-00

9.4.1 General information

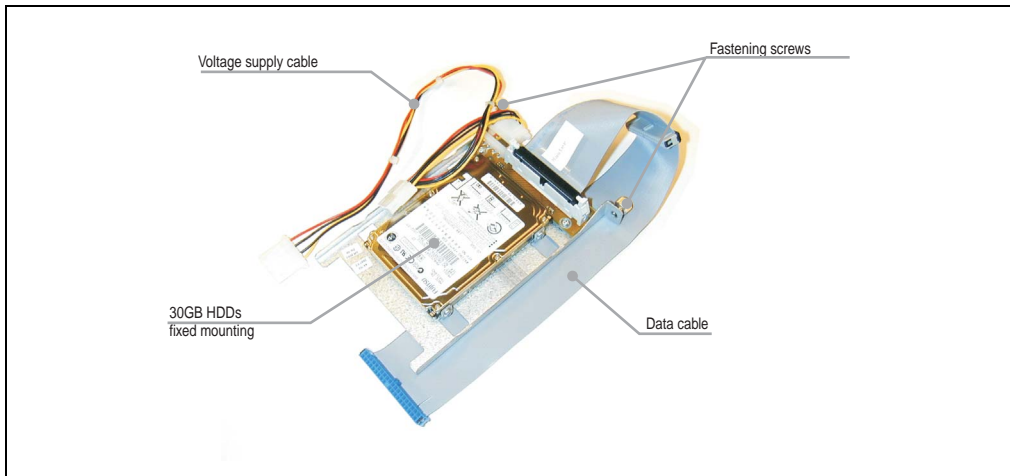

Figure 15: Components - 5HD680.0030-00

The hard disk is mounted on a practical slide-in frame for easy exchange. The frame is easily mounted in the APC680 housing with two mounting screws.

9.4.2 Technical data

Information:

The specified limits listed here, like environmental temperature, relative humidity, shock and vibration, only apply to this accessory and do not also necessarily apply to the whole device.

Features	5HD680.0030-00
Manufacturer's product ID	Fujitsu MHT2030AR
Capacity	30 GB
Number of heads	2
Number of sectors (user)	58,605,120
Bytes per sector	512
Memory types	48 / 50 RLL
Track density	79,800 TPI
Bit density	550 kbp
Revolution speed	4,200 rpm ±1%
Access time (average)	7.14 ms
Positioning time (seek, typical values)	
Minimum (track to track)	1.5 ms
Average	12 ms
Maximum	22 ms
Starting time (0 rpm to read access)	3.5 seconds (typically)
Mounted on insert plate	Fixed
Interface	ATA-6
Data transfer rate	
To the medium	26.1 to 32.1 MB/s
To / from host	Max. 100 MB/s (Ultra-DMA Mode 5)
Cache	2 MB
Noise level (idle mode)	Approx. 24 dBA at 30 cm
MTBF (hours)	300,000
lifespan	5 years or 20,000 POH
Environmental temperature	
Operation - standard ¹⁾	+5 °C to +55 °C
Operation - 24 Hour	+5 °C to +45 °C
Storage	-40 °C to +60 °C
Transport	-40 °C to +60 °C
Humidity	
Operation	8 - 90 % non-condensing
Storage	5 - 95 % non-condensing
Transport	5 - 95 % non-condensing

Table 46: Technical data - 30 GB hard disk

Technical data • Mass memory

Features	5HD680.0030-00
Vibration Operation Storage	No non-recovered errors at max. 5 -500 Hz and 1.0 G (9.8 m/s ² 0-peak) No damage at max. 5 -500 Hz and 5 G (49 m/s ² 0-peak)
Shock (pulse with a sinus half-wave) Operation Storage	No non-recovered errors at max. 225 G (2207 m/s ² 0-peak) and 2 ms duration No damage at max. 900 G (8820 m/s ² 0-peak) and 1 ms duration No damage at max. 120 G (1176 m/s ² 0-peak) and 11 ms duration
Altitude Operation Storage	- 300 to 3,000 meters - 300 to 12,000 meters

Table 46: Technical data - 30 GB hard disk (cont.)

1) "Standard operation" of a hard disk assumes that it is turned on or off once every 12 hours.

9.5 Hard disk 5HD680.2x20-00

9.5.1 General information

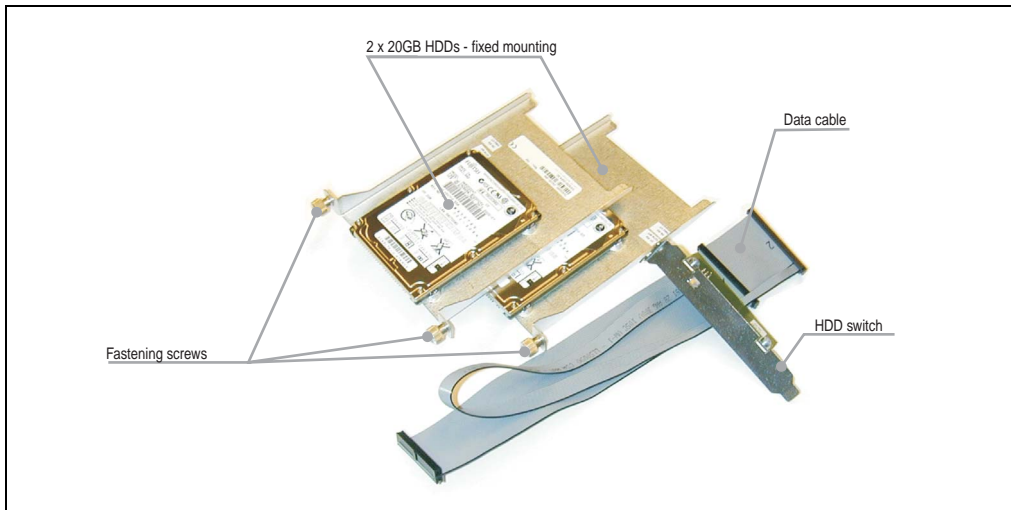

Figure 16: Components - 5HD680.2x20-00

The hard disks are mounted on a practical slide-in frame for easy exchange. The frame is easily mounted in the APC680 housing with two mounting screws.

9.5.2 Technical data

Information:

The specified limits listed here, like environmental temperature, relative humidity, shock and vibration, only apply to this accessory and do not also necessarily apply to the whole device.

Features	5HD680.2x20-00
Manufacturer's product ID	Fujitsu MHS2020AT-ED
Capacity	20 GB
Number of heads	2
Number of sectors (user)	39.070.080
Bytes per sector	512
Memory types	48 / 50 RLL
Track density	79,800 TPI
Bit density	550 kbp
Revolution speed	4,200 rpm ±1%
Access time (average)	7.14 ms
Positioning time (seek, typical values)	
Minimum (track to track)	1.5 ms
Average	12 ms
Maximum	22 ms
Starting time (0 rpm to read access)	3.5 seconds (typically)
Mounted on insert plate	Fixed
Interface	ATA-6
Data transfer rate	
To the medium	26.1 to 32.1 MB/s
To / from host	Max. 100 MB/s (Ultra-DMA Mode 5)
Cache	2 MB
Noise level (idle mode)	Approx. 24 dBA at 30 cm
MTBF (hours)	300.000
lifespan	5 years or 20,000 POH
Environmental temperature	
Operation - standard ¹⁾	+5 °C to +55 °C
Operation - 24 Hour	+5 °C to +45 °C
Storage	-40 °C to +60 °C
Transport	-40 °C to +60 °C
Humidity	
Operation	8 - 90 % non-condensing
Storage	5 - 95 % non-condensing
Transport	5 - 95 % non-condensing

Table 47: Technical data - 20 GB hard disk

Features	5HD680.2x20-00
Vibration Operation Storage	No non-recovered errors at max. 5 -500 Hz and 1.0 G (9.8 m/s ² 0-peak) No damage at max. 5 -500 Hz and 5 G (49 m/s ² 0-peak)
Shock (pulse with a sinus half-wave) Operation Storage	No non-recovered errors at max. 225 G (2207 m/s ² 0-peak) and 2 ms duration No damage at max. 900 G (8820 m/s ² 0-peak) and 1 ms duration No damage at max. 120 G (1176 m/s ² 0-peak) and 11 ms duration
Altitude Operation Storage	- 300 to 3,000 meters - 300 to 12,000 meters

Table 47: Technical data - 20 GB hard disk (cont.)

1) "Standard operation" of a hard disk assumes that it is turned on or off once every 12 hours.

9.5.3 Hard disk switch

Caution!

Turn off power before switching between hard disks.

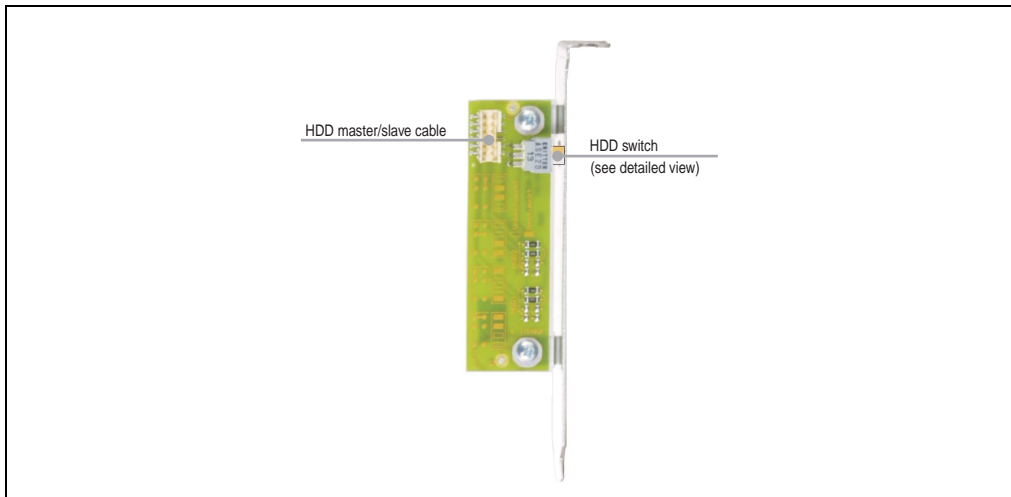

Figure 17: Components - hard disk switch

The adapter is connected using an adapter cable that is connected to the two hard disks, the hard disk switch, and with the Slot CPU 44-pin primary IDE plug.

With the hard disk switch, the hard disks can be assigned as either the master or slave for the primary IDE ports (44-pin primary IDE connector only), depending on the switch position for the hard disk.

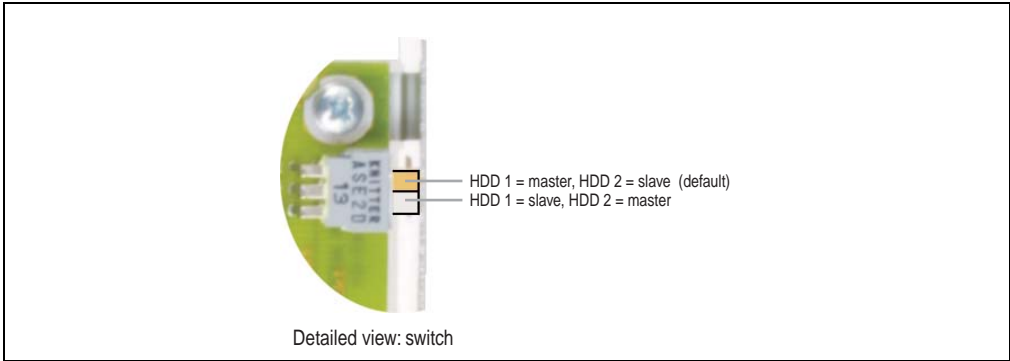

Figure 18: Detailed view - hard disk switch

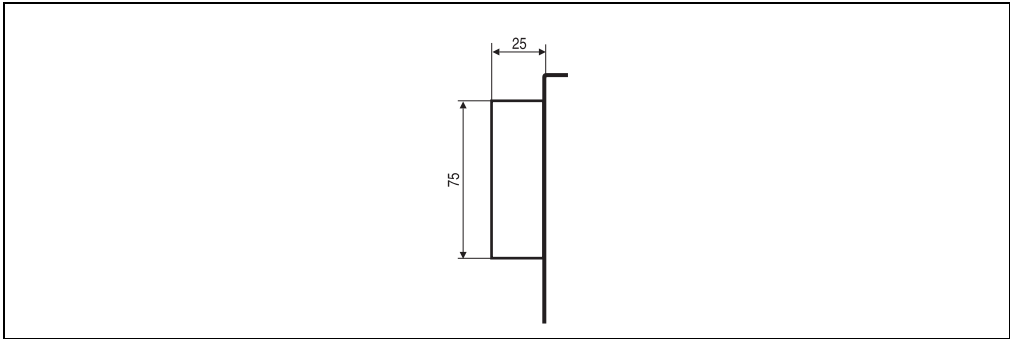

Figure 19: Dimensions - hard disk switch

9.6 Hard disk 5HD680.2x30-00

9.6.1 General information

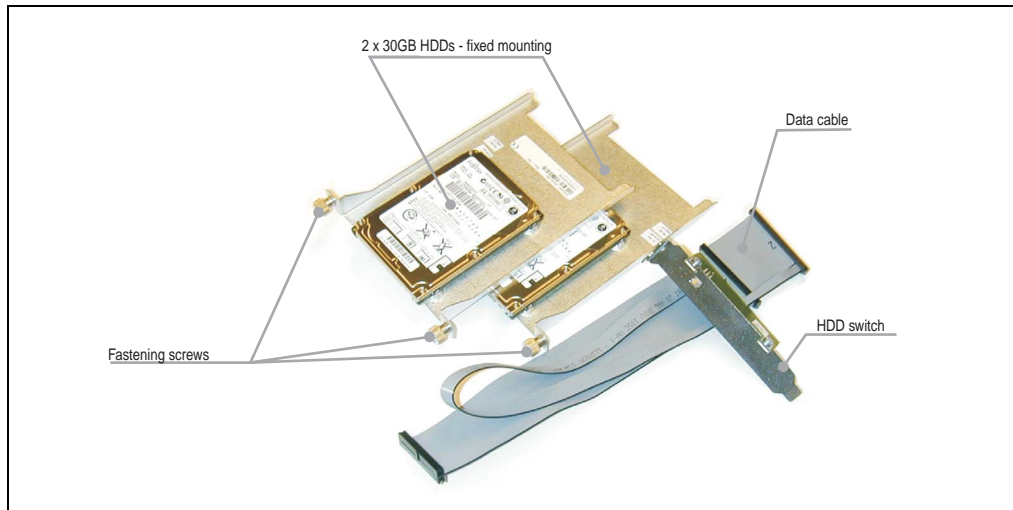

Figure 20: Components - 5HD680.2x30-00

The hard disks are mounted on a practical slide-in frame for easy exchange. The frame is easily mounted in the APC680 housing with two mounting screws.

9.6.2 Technical data

Information:

The specified limits listed here, like environmental temperature, relative humidity, shock and vibration, only apply to this accessory and do not also necessarily apply to the whole terminal.

Features	5HD680.2x30-00
Manufacturer's product ID	Fujitsu MHT2030AR
Capacity	30 GB
Number of heads	2
Number of sectors (user)	58,605,120
Bytes per sector	512
Memory types	48 / 50 RLL
Track density	79,800 TPI

Table 48: Technical data - 20 GB hard disk

Features	5HD680.2x30-00
Bit density	550 kbp
Revolution speed	4,200 rpm ±1%
Access time (average)	7.14 ms
Positioning time (seek, typical values)	
Minimum (track to track)	1.5 ms
Average	12 ms
Maximum	22 ms
Starting time (0 rpm to read access)	3.5 seconds (typically)
Mounted on insert plate	Fixed
Interface	ATA-6
Data transfer rate	
To the medium	26.1 to 32.1 MB/s
To / from host	Max. 100 MB/s (Ultra-DMA Mode 5)
Cache	2 MB
Noise level (idle mode)	Approx. 24 dBA at 30 cm
MTBF (hours)	300,000
lifespan	5 years or 20,000 POH
Environmental temperature	
Operation - standard ¹⁾	+5 °C to +55 °C
Operation - 24 Hour	+5 °C to +45 °C
Storage	-40 °C to +60 °C
Transport	-40 °C to +60 °C
Humidity	
Operation	8 - 90 % non-condensing
Storage	5 - 95 % non-condensing
Transport	5 - 95 % non-condensing
Vibration	
Operation	No non-recovered errors at max. 5 -500 Hz and 1.0 G (9.8 m/s ² 0-peak)
Storage	No damage at max. 5 -500 Hz and 5 G (49 m/s ² 0-peak)
Shock (pulse with a sinus half-wave)	
Operation	No non-recovered errors at max. 225 G (2207 m/s ² 0-peak) and 2 ms duration
Storage	No damage at max. 900 G (8820 m/s ² 0-peak) and 1 ms duration No damage at max. 120 G (1176 m/s ² 0-peak) and 11 ms duration
Altitude	
Operation	- 300 to 3,000 meters
Storage	- 300 to 12,000 meters

Table 48: Technical data - 20 GB hard disk (cont.)

1) "Standard operation" of a hard disk assumes that it is turned on or off once every 12 hours.

9.6.3 Hard disk switch

Caution!

Turn off power before switching between hard disks.

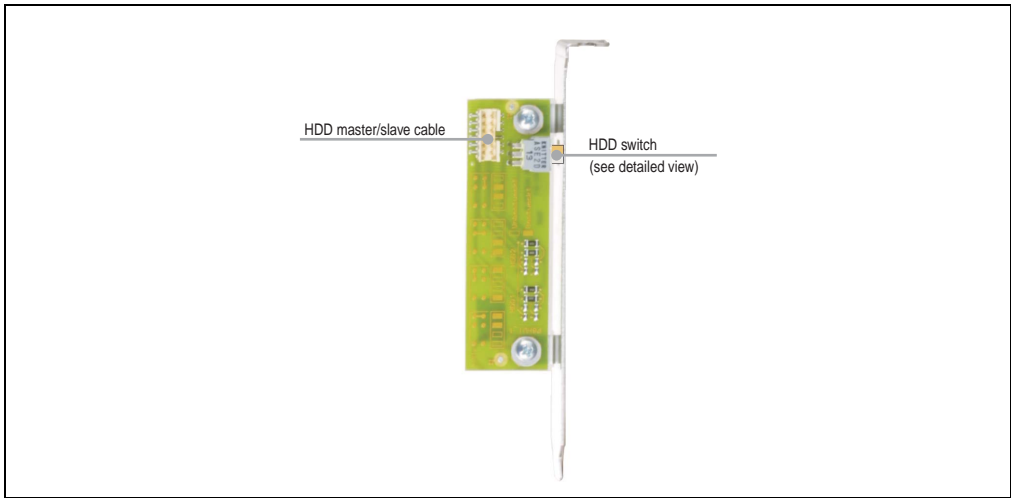

Figure 21: Components - hard disk switch

The adapter is connected using an adapter cable that is connected to the two hard disks, the hard disk switch, and with the Slot CPU 44-pin primary IDE plug.

With the hard disk switch, the hard disks can be assigned as either the master or slave for the primary IDE ports (44-pin primary IDE connector only), depending on the switch position for the hard disk.

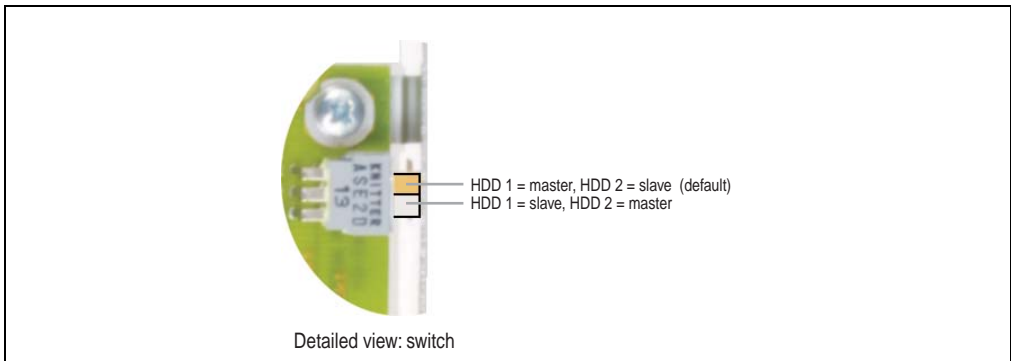

Figure 22: Detailed view - hard disk switch

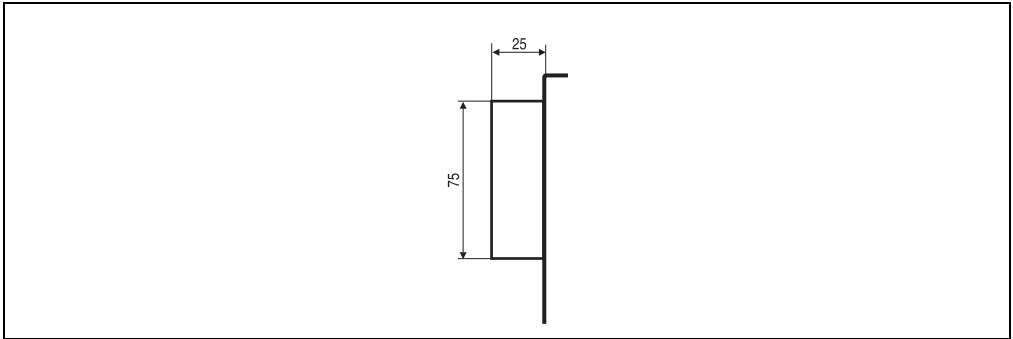

Figure 23: Dimensions - hard disk switch

Chapter 3 • Mounting

1. Mounting instructions

- The device is mounted with the four mounting plates found on the housing.

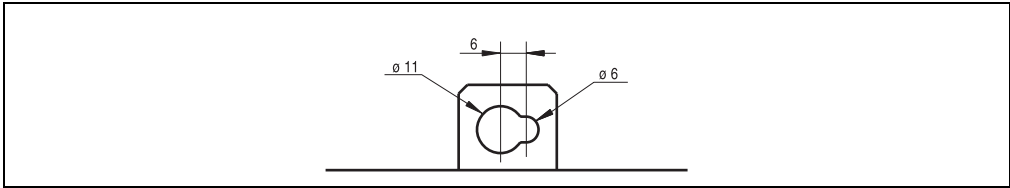

Figure 24: Mounting plates

The exact positioning of the mounting holes can be taken from the dimension diagram for the housing (see chapter 2 "Technical data", section "Housing", on page 30).

- In order to guarantee proper air circulation, allow the specified amount of space above, below, to the side and behind the APC680. The minimum specified free space can be found in section "Mounting options", on page 88.

2. Mounting options

The following diagrams show the specified mounting orientations for the APC680 and the spacing required for air circulation.

2.1 Vertical

Information:

Vertical mounting is the ideal orientation for the APC680. The combination of the housing fans blowing up and the natural air circulation results in maximum cooling.

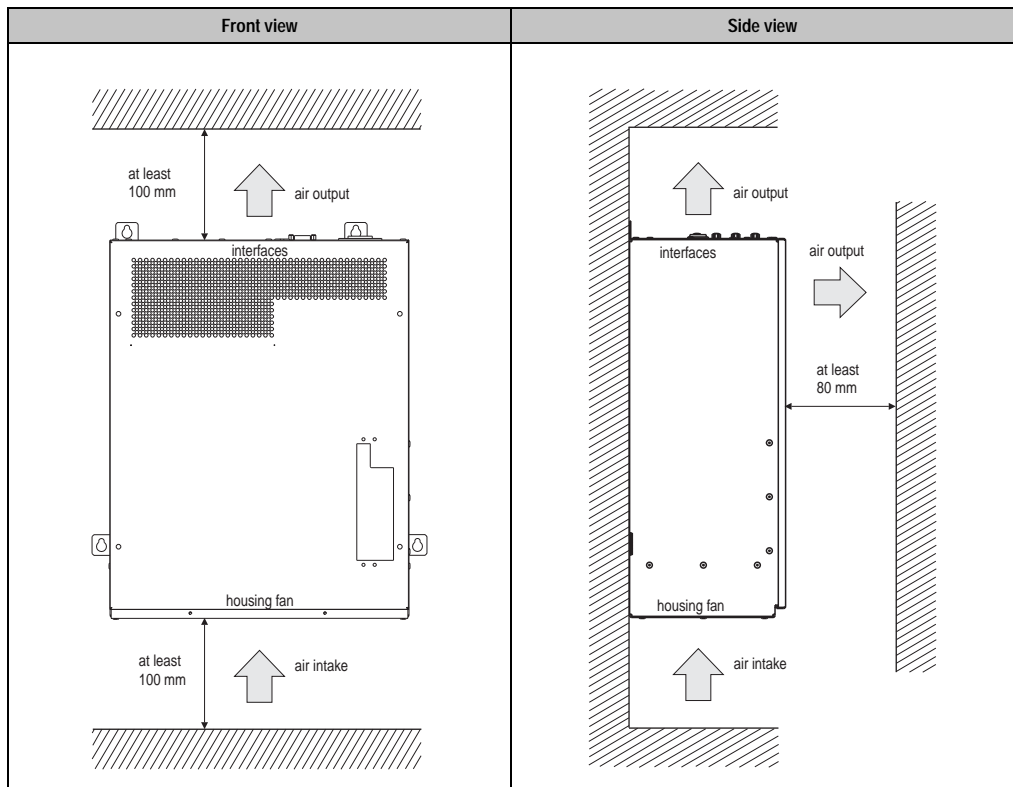

Figure 25: Mounting orientation - vertical

Approximately 120 mm free air space is required on the interface side of the APC680 to prevent cabling problems.

2.2 Horizontal

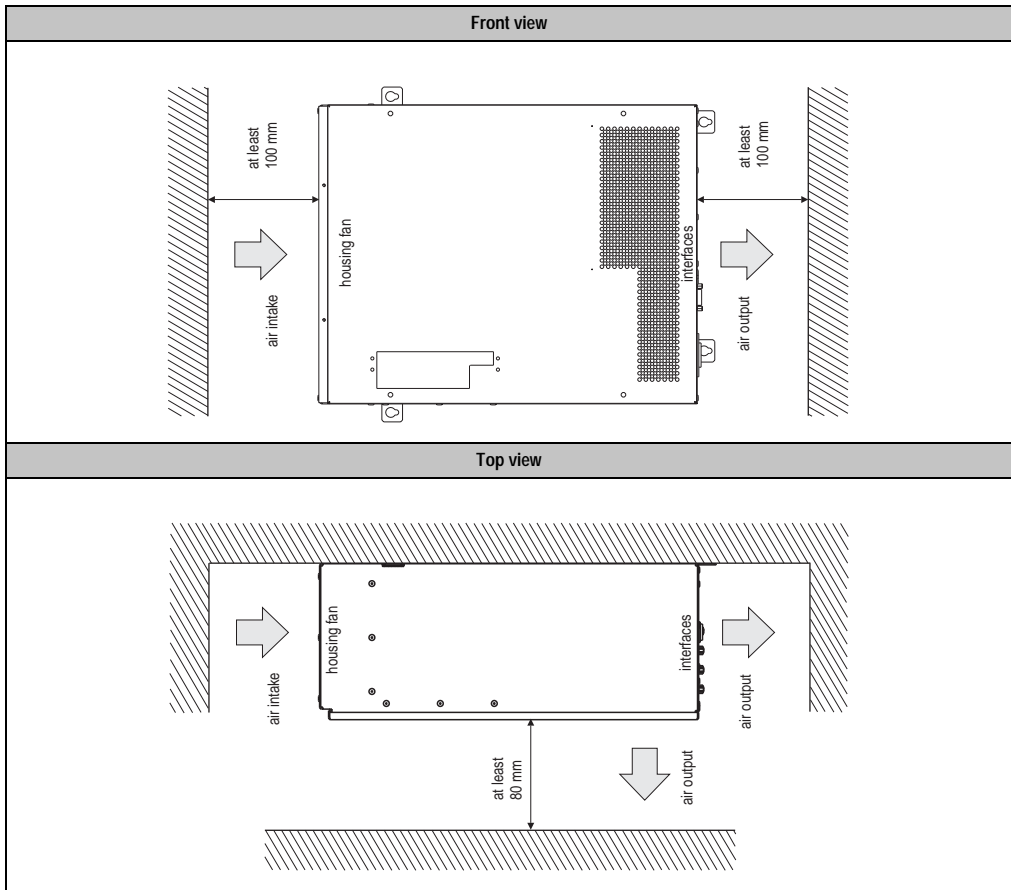

Figure 26: Mounting orientation - horizontal

Approximately 120 mm free space is required on the interface side of the APC680 to prevent cabling problems.

2.3 Lying down

Warning!

When mounted horizontally, drive combinations 5DD680.CRFD-00 and 5DD680.DCFD-00 are not permitted due to specified mounting orientation specifications (see chapter 5 "Accessories", sections 9 "CD-ROM FDD combo 5DD680.CRFD-00" on page 151 and 10 "DVD-ROM/CD-RW FDD combo 5DD680.DCFD-00" on page 153).

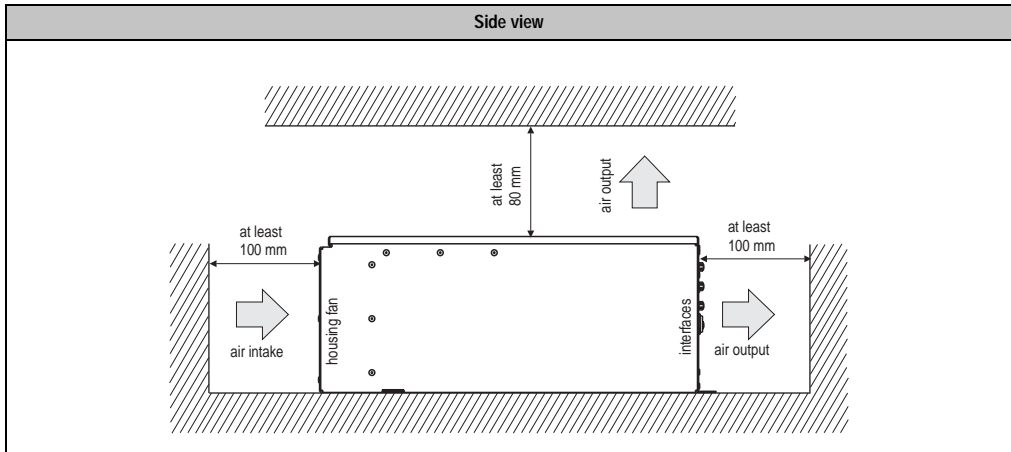

Figure 27: Mounting orientation - lying down

Approximately 120 mm free space is required on the interface side of the APC680 to prevent cabling problems.

Chapter 4 • Software

1. BIOS

1.1 General information

BIOS is an abbreviation for "**B**asic **I**nput and **O**utput **S**ystem". It is the most basic standardized communication between the user and the system (hardware). EliteBIOS from Award Software is used on all Automation PCs.

The BIOS Setup Utility lets you modify basic system configuration settings. These settings are stored in CMOS RAM and in FEPROM (as a backup).

The CMOS RAM is a nonvolatile battery backed memory which retains information when the power is turned off on the IPC.

The EliteBIOS used is a customized version of an industry-standard BIOS for IBM PC AT-compatible personal computers. It supports Intel x86 and compatible processors. BIOS provides critical low-level support for the central processing unit, memory and I/O subsystems.

It has been customized by B&R through the addition of important, but non standard, features such as virus and password protection, power management, and detailed fine-tuning of the chipset controlling the system.

1.2 BIOS setup

The EliteBIOS is immediately activated when you switch on the power supply of the Automation PC.

BIOS reads system configuration information in CMOS RAM, compares it with the CMOS backup in FEPROM and begins the process of checking the system and configuring it through the power-on self test (POST).

When these "preliminaries" are finished, BIOS seeks an operating system in the data storage devices available (hard drive, floppy drive, etc.). BIOS launches the operating system and hands over control of system operations to it.

To enter setup, the delete key must be pressed as soon as the following message appears on the lower margin of the display (during POST):

"Press DEL to enter SETUP"

If the message disappears before DEL was pressed, then the system must be booted again in order to enter BIOS setup.

Warning

Generally: The best advice is to alter only those settings that you thoroughly understand. On no account should settings be changed in the chipset screen without a good reason. Chipset defaults have been carefully chosen by Award or B&R to guarantee ideal performance and reliability. Even a seemingly minor change to the chipset setup may cause the system to become unstable.

1.3 BIOS setup keys

The following keys help you navigate in BIOS setup:

Key	Function
Cursor ↑	Move to previous item
Cursor ↓	Move to next item
Cursor ←	Move to the item on the left
Cursor →	Move to the item on the right
ESC	Main menu: Quit without saving changes to the CMOS RAM. Exit current page and return to Main Menu
PgUp↑	Increase the value / make changes
PgDn↓	Decrease the value / make changes
+	Increase the value / make changes
-	Decrease the value / make changes
F1	A help window pops up that describes the appropriate keys to use and the possible selections for the highlighted item. Press F1 or ESC to exit the help window.
F2	"Item Help" - If a detailed help is available for a BIOS setting, pushing this key will display it in the right half of the BIOS screen.
F5	"Load previous values for this page" - This option will load all settings that were in place when BIOS setup was opened. This key is only available in the individual setup screens, and only the values for these screens are loaded.
F6	"Load fail-safe defaults for this page" - Default parameters are loaded, ensuring a stable system. This key is only available in the individual setup screens, and only the values for these screens are loaded.
F7	"Load optimized default for this page" - Factory settings are loaded into the system for optimal configuration. This key is only available in the individual setup screens, and only the values for these screens are loaded.
F10	"Save to CMOS and exit" - Save all changes to CMOS and exit setup.

Table 49: Keys relevant to BIOS

2. BIOS settings

Information:

- The following diagrams and BIOS menu items including descriptions refer to BIOS Version 1.01. Therefore, it is possible that the diagrams and BIOS descriptions might not correspond with the installed BIOS version.
- B&R recommends selection of "Load optimized defaults".

2.1 BIOS setup - main menu

The BIOS setup main menu appears immediately by pressing the DEL button:

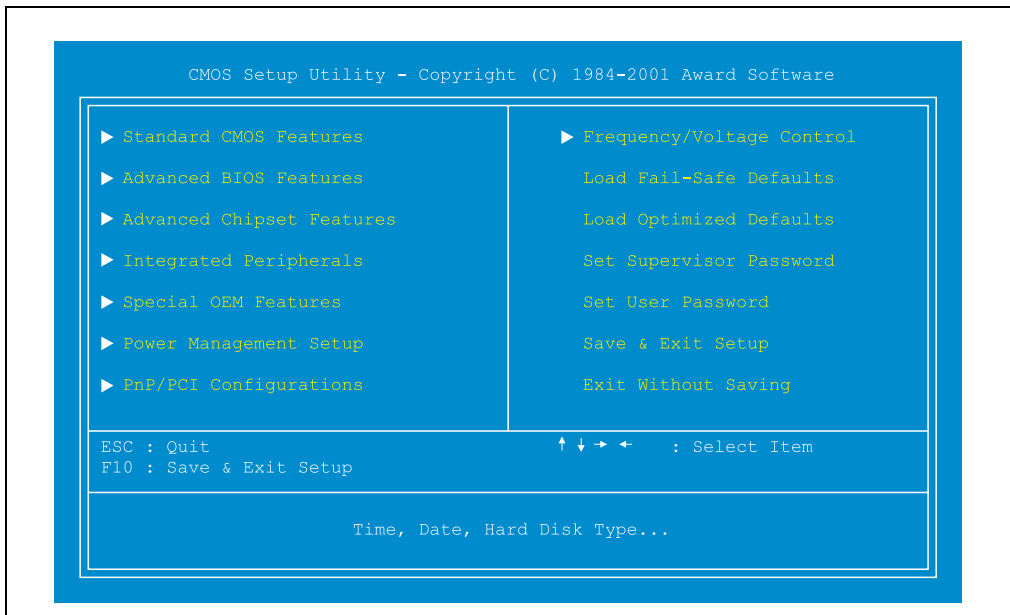

Figure 28: BIOS setup main menu

The individual menu points are explained in detail in the following sections.

BIOS setup menu	Function
Standard CMOS features	The basic system configurations (e.g. time, date, disk drives, hard disk parameters) can be set in this menu.
Advanced BIOS features	Advanced BIOS options such as cache areas and keyboard repeat rate, boot order etc. can be configured here.
Advanced chipset features	Specific BIOS options for the system chipset can be changed here.

Table 50: Overview of BIOS main menu functions

BIOS setup menu	Function
Integrated peripherals	Controller and interface settings for onboard peripheral subsystems.
Special OEM features	B&R specific settings for integrated peripheral devices.
Power management setup	Setup of various APM (Advanced Power Management) options.
PnP/PCI configuration	Setup of interrupts for PnP, PCI and ISA components.
Frequency / voltage control	These settings are helpful for the monitoring of all important system parameters.
Load fail-safe defaults	Load predefined settings to guarantee system operation.
Load optimized defaults	<p>Load the optimal BIOS settings for best performance.</p> <p>Information:</p> <p>The "Load optimized default" values depend on the positions of the configuration switches. For configuration switch settings and predefined values, see section 4 "Load optimized default settings" on page 125.</p> <p>To redefine the "Load optimized default" values, you must contact B&R.</p>
Set supervisor password	Here you can identify a password for the supervisor.
Set user password	Here you can identify a password for the user.
Save & exit setup	Settings are saved and the BIOS setup is ended.
Exit without saving	End the setup without saving changes.

Table 50: Overview of BIOS main menu functions (cont.)

2.2 Standard CMOS features

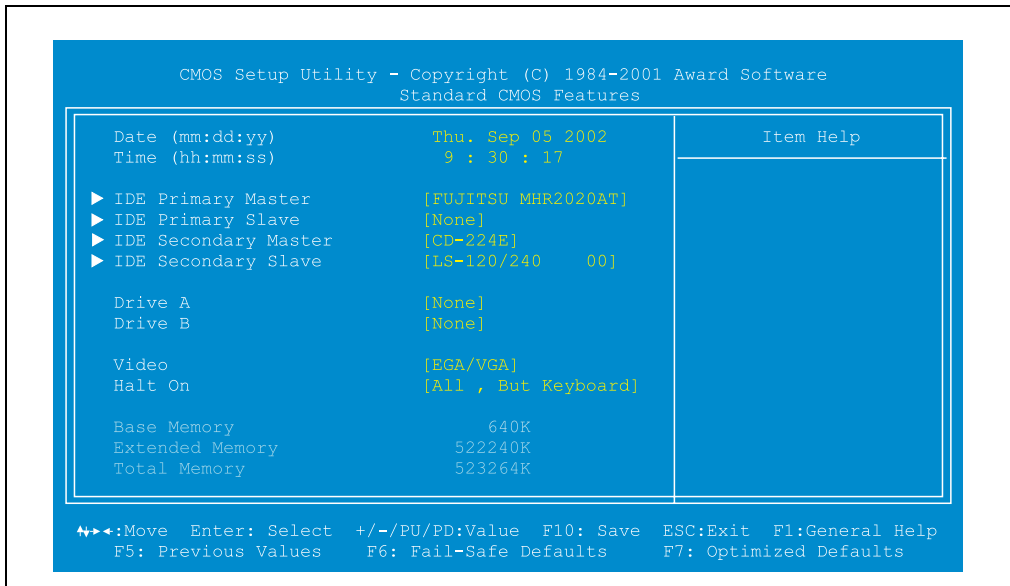

Figure 29: Standard CMOS features

BIOS setting	Description	Setting options	Effect
Date (mm:dd:yy)	This is the current system date setting. The time is buffered by a battery (CMOS battery) after the system has been switched off.	Changes to the system date	Individual setting of the system date
Time (hh:mm:ss)	This is the current system time setting. The time is buffered by a battery (CMOS battery) after the system has been switched off.	Adjustment of the system time	Individual setting of the system time
IDE primary master	The drives in the system that are connected to the IDE primary master port are configured here.	See "IDE primary master" on page 97	Pressing "ENTER" takes you to the configuration screen for the "IDE primary master" on page 97
IDE primary slave	The drives in the system that are connected to the IDE primary slave port are configured here.	See "IDE primary slave" on page 98	Pressing "ENTER" takes you to the configuration screen for the "IDE primary slave" on page 98
IDE secondary master	The drives in the system that are connected to the IDE secondary master port are configured here.	See "IDE secondary master" on page 99	Pressing "ENTER" takes you to the configuration screen for the "IDE secondary master" on page 99
IDE secondary slave	The drives in the system that are connected to the IDE secondary slave port are configured here.	See "IDE secondary slave" on page 100	Pressing "ENTER" takes you to the configuration screen for the "IDE secondary slave" on page 100
Drive A	Set the largest amount of memory permitted for a connected disk drive.	None 1.44M, 3.5 in	No diskette drive installed 3½" disk drive, 1.44MB ¹⁾ capacity

Table 51: Standard CMOS features - description of setting options

Software • BIOS settings

BIOS setting	Description	Setting options	Effect
Drive B	Set the largest amount of memory permitted for a connected disk drive.	None 1.44M, 3.5 in	No diskette drive installed 3½" disk drive, 1.44MB ¹⁾ capacity
Video	The primary graphics subsystem can be setup here. BIOS usually detects the correct video type automatically.	EGA/VGA	Enhanced Graphics Adapter / Video Graphics Array For EGA, VGA, SAGA, SVGA or PGA monitor adapters
		CGA 40	Color graphics adapter, power up in 40 column mode
		CGA 80	Color graphics adapter, power up in 80 column mode
		Mono	Monochrome adapter includes high resolution monochrome adapters
Halt on	This option sets whether the system should pause the Power On Self Test (POST) when it encounters an error, and after which non-fatal errors the POST should be continued.	No errors	All errors are ignored.
		All errors	The system pauses every time an error is encountered.
		All but keyboard	System pauses for all errors except keyboard errors
		All but diskette	System pauses for all errors except disk drive errors
		All but disk/key	System pauses for all errors except keyboard or drive errors

Table 51: Standard CMOS features - description of setting options (cont.)

1) Only HD diskettes (1.44 MB) are still supported by BIOS.

IDE primary master

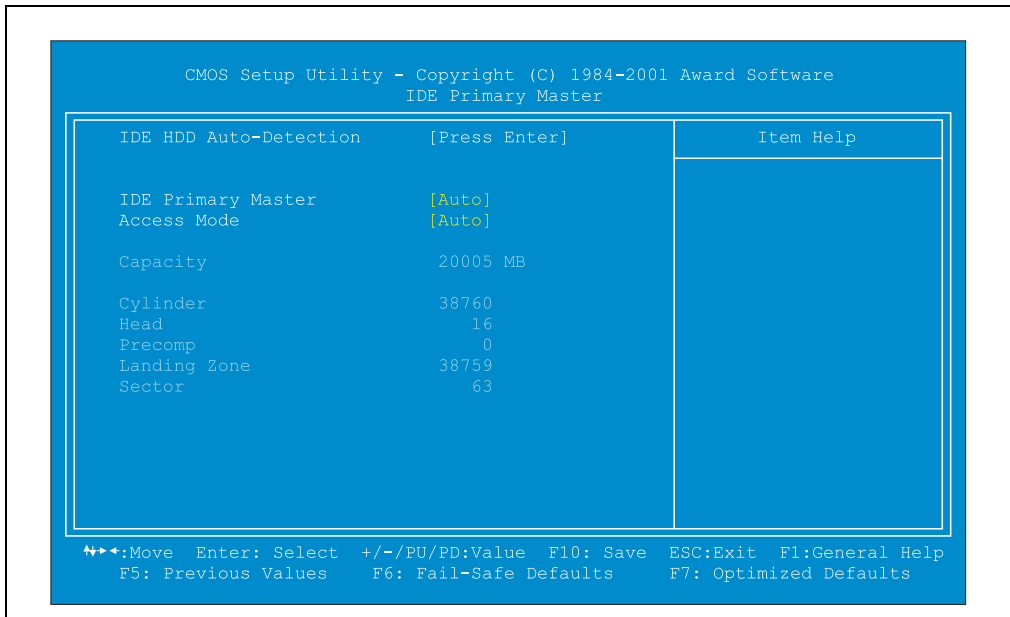

Figure 30: IDE primary master setup

BIOS setting	Description	Setting options	Effect
IDE HDD auto-detection	Automatic recognition of hard disk or drive.	Press Enter	Automatic recognition of hard drive and application of settings to BIOS.
IDE primary master	Determine here which PIO or DMA mode should be used for the IDE hard drive. Incorrect settings can lead to data loss. It is therefore recommended to make this setting with the option "Auto", or to closely follow the manufacturer's instructions.	None	No drive is connected.
		Auto	Automatic drive detection.
		Manual	Manual drive configuration.
Access mode	Determine here the type of access to the hard drive or CD ROM drive.	Auto	The access type is controlled automatically.
		CHS	CHS access is used
		LBA	LBA access is used: This option activates the Logical Block Addressing for IDE. For hard drives larger than 528 MB, this option must be selected.
		Large	Large access is used: If the hard drive has more than 1024 cylinders (CYLs) and DOS cannot support them, or if the operating system does not support LBA mode, select this option.

Table 52: IDE primary master setup - description of setting options

IDE primary slave

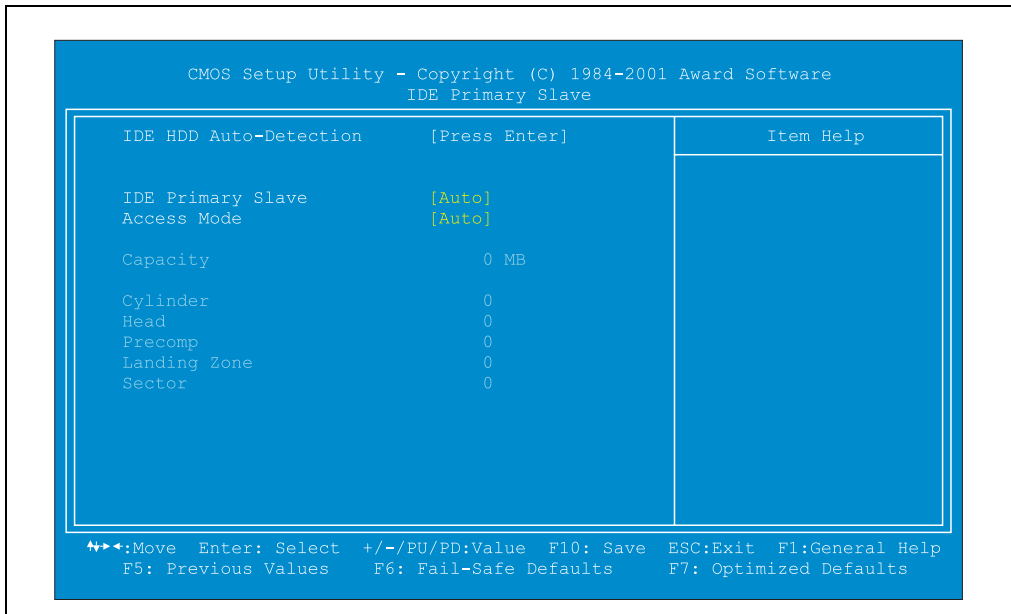

Figure 31: IDE primary slave setup

BIOS setting	Description	Setting options	Effect
IDE HDD auto-detection	Automatic recognition of hard disk or drive.	Press Enter	Automatic recognition of hard drive and application of settings to BIOS.
IDE primary slave	Determine here which PIO or DMA mode should be used for the IDE hard drive. Incorrect settings can lead to data loss. It is therefore recommended to make this setting with the option "Auto", or to closely follow the manufacturer's instructions.	None	No drive is connected.
		Auto	Automatic drive detection.
		Manual	Manual drive configuration.
Access mode	Determine here the type of access to the hard drive or CD ROM drive.	Auto	The access type is controlled automatically.
		CHS	CHS access is used
		LBA	LBA access is used: This option activates the Logical Block Addressing for IDE. For hard drives larger than 528 MB, this option must be selected.
		Large	Large access is used: If the hard drive has more than 1024 cylinders (CYLs) and DOS cannot support them, or if the operating system does not support LBA mode, select this option.

Table 53: IDE primary slave setup - description of setting options

IDE secondary master

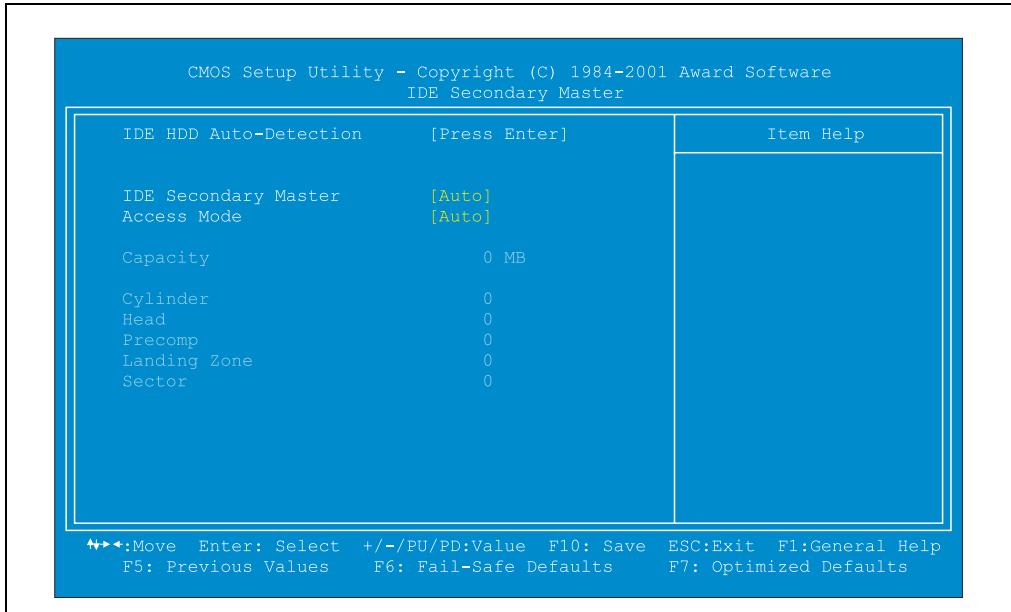

Figure 32: IDE secondary master setup

BIOS setting	Description	Setting options	Effect
IDE HDD auto-detection	Automatic recognition of hard disk or drive.	Press Enter	Automatic recognition of hard drive and application of settings to BIOS.
IDE secondary master	Determine here which PIO or DMA mode should be used for the IDE hard drive. Incorrect settings can lead to data loss. It is therefore recommended to make this setting with the option "Auto", or to closely follow the manufacturer's instructions.	None	No drive is connected.
		Auto	Automatic drive detection.
		Manual	Manual drive configuration.
Access mode	Determine here the type of access to the hard drive or CD ROM drive.	Auto	The access type is controlled automatically.
		CHS	CHS access is used
		LBA	LBA access is used: This option activates the Logical Block Addressing for IDE. For hard drives larger than 528 MB, this option must be selected.
		Large	Large access is used: If the hard drive has more than 1024 cylinders (CYLs) and DOS cannot support them, or if the operating system does not support LBA mode, select this option.

Table 54: IDE secondary master setup - description of setting options

IDE secondary slave

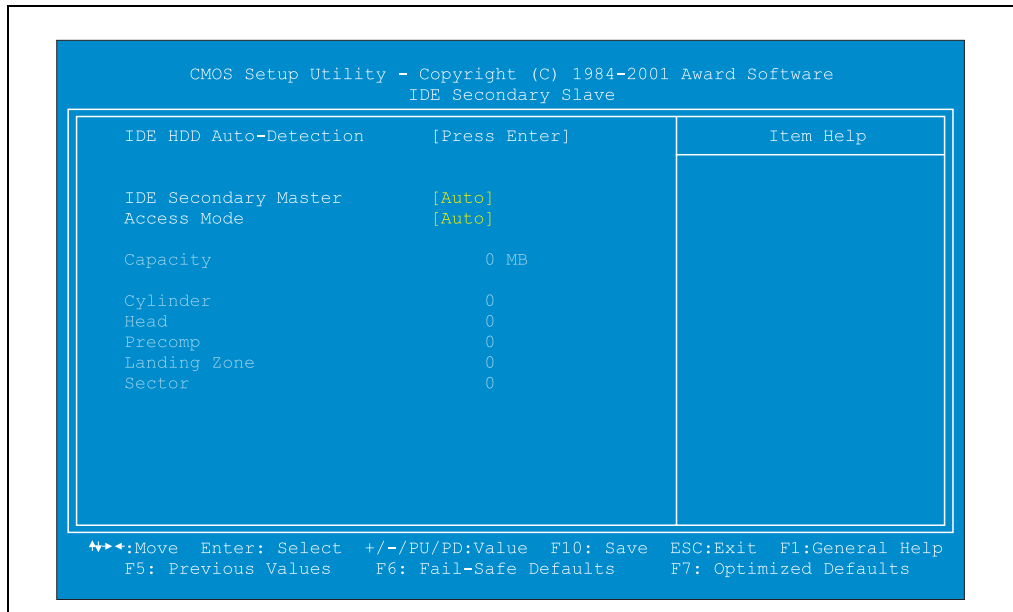

Figure 33: IDE secondary slave setup

BIOS setting	Description	Setting options	Effect
IDE HDD auto-detection	Automatic recognition of hard disk or drive.	Press Enter	Automatic recognition of hard drive and application of settings to BIOS.
IDE secondary slave	Determine here which PIO or DMA mode should be used for the IDE hard drive. Incorrect settings can lead to data loss. It is therefore recommended to make this setting with the option "Auto", or to closely follow the manufacturer's instructions.	None	No drive is connected.
		Auto	Automatic drive detection.
		Manual	Manual drive configuration.
Access mode	Determine here the type of access to the hard drive or CD ROM drive.	Auto	The access type is controlled automatically.
		CHS	CHS access is used
		LBA	LBA access is used: This option activates the Logical Block Addressing for IDE. For hard drives larger than 528 MB, this option must be selected.
		Large	Large access is used: If the hard drive has more than 1024 cylinders (CYLs) and DOS cannot support them, or if the operating system does not support LBA mode, select this option.

Table 55: IDE secondary slave setup - description of setting options

2.3 Advanced BIOS features

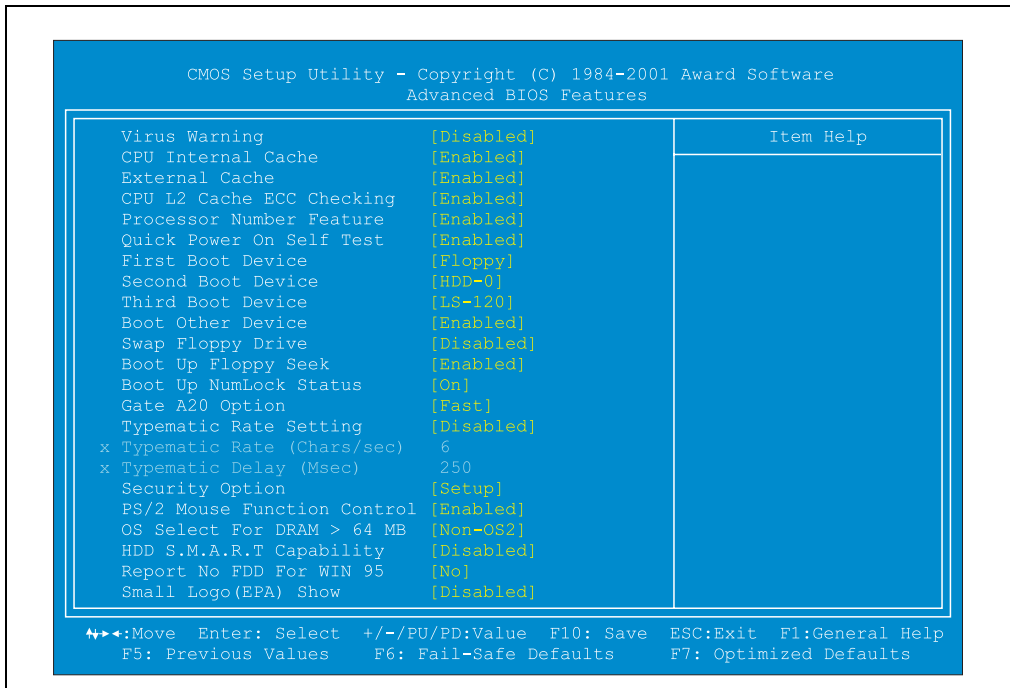

Figure 34: Advanced BIOS features

BIOS setting	Description	Setting options	Effect
Virus warning	When enabled, you receive a warning message if a program (especially a virus) attempts to alter the boot sector or the partition table of the boot drive (not the rest of the hard drive).	Disabled	Function is deactivated.
		Enabled	Function is activated.
CPU internal cache	Switching the L1 cache of the processor, on or off. Switching off the internal cache slows down the system to below 65%, and therefore is not advisable.	Enabled	Use of the L1 cache is activated.
		Disabled	No L1 cache is used.
External cache	Makes it possible to prevent the use of the integrated second level cache on the mainboard. Switching off the external cache slows down the system considerably, and is therefore not advisable.	Enabled	Use of the second level cache is activated.
		Disabled	No second level cache is used.

Table 56: Advanced BIOS features - description of setting options

BIOS setting	Description	Setting options	Effect
CPU L2 cache ECC checking	With this option, error recognition and correction for the processor's L2 cache is continuously checked using ECC (Error Checking and Correction). Activating this option effects the systems speed. Deactivating it makes the system theoretically less reliable. With the Error Correction Code individual faulty Bits are automatically corrected when reading/writing the L2 cache memory.	Enabled	Function is activated.
		Disabled	Function is deactivated.
Processor number feature	This option, which controls access to the processor's serial number, can only be used with Intel® Pentium® III processors.	Enabled	Access allowed for other programs.
		Disabled	Access blocked for other programs.
Quick Power On Self Test	Enabling this option speeds up the booting process. Up to 10 seconds can be taken off the booting process with 64 MB RAM or more. However, not all POST tests are carried out.	Enabled	Speeds up POST considerably by skipping the full memory test.
		Disabled	All self tests are carried out.
First boot device	Determine here which drive should be booted from first.	Floppy:, LS120, HDD-0, SCSI, CDROM, HDD-1, HDD-2, HDD-3, ZIP100, USB-FDD, USB-ZIP, USB-CDROM, USB-HDD, LAN, Disabled	An attempt is made to boot from this configured drive first.
Second boot device	Determine here which drive should be booted from second.	Floppy:, LS120, HDD-0, SCSI, CDROM, HDD-1, HDD-2, HDD-3, ZIP100, USB-FDD, USB-ZIP, USB-CDROM, USB-HDD, LAN, Disabled	An attempt is made to boot from this configured drive second.
Third boot device	Determine here which drive should be booted from third.	Floppy:, LS120, HDD-0, SCSI, CDROM, HDD-1, HDD-2, HDD-3, ZIP100, USB-FDD, USB-ZIP, USB-CDROM, USB-HDD, LAN, Disabled	An attempt is made to boot from this configured drive third.
Boot other device	Option for booting another drive other than the standard boot drives (first, second, and third).	Enabled	Enables BIOS to try booting from the first, second, and third boot devices, and then to boot from a bootable drive.
		Disabled	Deactivates the function
Swap floppy drive	Here you can switch floppy drives without moving the cable. This field is effective only in systems with two floppy drives.	Enabled	The drive letter B is assigned to the physical drive A and the drive letter A to the physical drive B.
		Disabled	When disabled, drive letter assignments are not changed.
Boot up floppy seek	When the PC is started, the disk drive is searched for the number of tracks (40 or 80). Note: Only 360 KByte diskettes have 40 tracks. All diskettes with 720 KByte, 1.2 MByte and 1.44 MByte have 80 tracks.	Enabled	BIOS searches the disk drives during POST.
		Disabled	Saves several seconds boot time.

Table 56: Advanced BIOS features - description of setting options (cont.)

BIOS setting	Description	Setting options	Effect
Boot up NumLock status	With this field you can define the state of the NumLock key when booting.	On	The numeric keypad generates numbers instead of controlling cursor operations.
		Off	The control fields are used for the keys (cursor keys, Pos1, End, etc.).
Gate A20 option	Determines how the memory above 1MB is accessed.	Fast	Gate A20 is controlled by the system chipset.
		Normal	Gate A20 is controlled by the keyboard controller.
Typematic rate setting	Determines the typematic rate of the keyboard controller.	Disabled	When disabled, the next two options "typematic rate (char/sec)" and "typematic delay (Msec)" are irrelevant.
		Enabled	When enabled, you can select a typematic rate and typematic delay. This setting can also be made in Windows.
Typematic rate (chars/sec)	Can only be selected when typematic rate setting is enabled. Determines the speed that characters are repeated when a key is pressed and held down.	6, 8, 10, 12, 15, 20, 24 or 30	Number of characters repeated per second. The accuracy of this setting is ±20%.
Typematic delay (ms)	Can only be selected when typematic rate setting is enabled. Sets the value for the delay between when a key is pressed and when its function takes effect.	250, 500, 750 or 1000	Delay setting in milliseconds. The accuracy of this setting is ±20%.
Security option	Select when a password is required.	System	Every time the system is booted, a defined password must be entered.
		Setup	A password is only needed when entering the BIOS setup menu (e.g. with the DEL key during startup).
PS/2 mouse function control	Switches the PS/2 connection on or off when using a PS/2 mouse.	Enabled	The data flow is increased, but you need your own IRQ.
		Disabled	No IRQ is reserved for a PS/2 mouse, and it cannot be operated with this setting.
OS Select for DRAM > 64 MB	Only relevant when the operating system OS/2 is installed with more than 64 MB RAM.	OS2	OS/2 is installed on the device, and it has 64 MB RAM.
		Non-OS2	An operating system other than OS/2 is installed on the device.
HDD S.M.A.R.T Capability	S.M.A.R.T. (Self Monitoring Analysis and Reporting Technology) is implemented in the today's hard drives. With the appropriate software, this technology allows you to determine problems with reading or spinning the hard drive, and much more. For example, if this option is enabled a message is given to notify the user about an impending crash. Norton Utilities 3.0 evaluates these results.	Enabled	Turns the function on.
		Disabled	Turns the function off.
Report no FDD for WIN 95	Set whether or not a floppy drive is present in the system. If no floppy drive is installed this option should be set to Yes.	Yes	This frees up the IRQ6 and the Windows logo is skipped.
		No	A floppy drive is present in the system. IRQ6 is used.

Table 56: Advanced BIOS features - description of setting options (cont.)

BIOS setting	Description	Setting options	Effect
Small logo (EPA) show	With this option you can set whether the EPA logo is displayed or not.	Enabled	The EPA logo is displayed every time the system starts up.
		Disabled	The EPA logo is not displayed.

Table 56: Advanced BIOS features - description of setting options (cont.)

2.4 Advanced chipset features

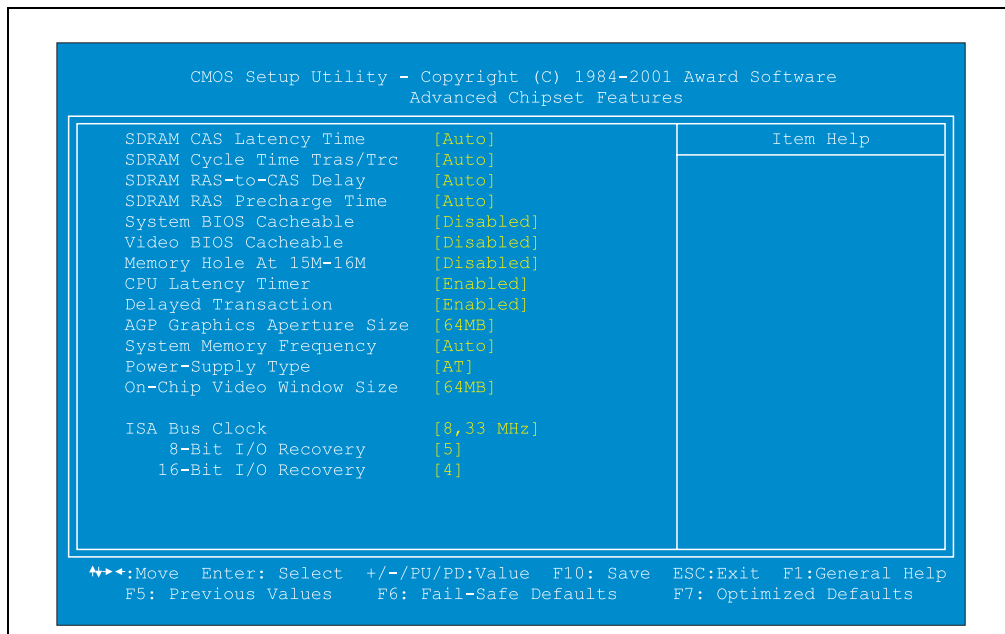

Figure 35: Advanced chipset features

Warning!

The parameters in this screen are for system designers, service personnel, and technically competent users only. The best advice is to alter only those settings that you thoroughly understand.

BIOS setting	Description	Setting options	Effect
SDRAM CAS latency time	With this option you can set the length of time after the SDRAM read command before the data are actually available for the processor.	Auto	Offers the best possible system stability.
		2 or 3	Manual configuration of the cycle time.

Table 57: Advanced chipset features - description of setting options

BIOS setting	Description	Setting options	Effect
SDRAM cycle time Tras/Trc	With this option (RAS Active Time) you can enter the length of time that an RAS is kept open for multiple accesses.	Auto	Offers the best possible system stability.
		7 / 9 or 5 / 7	Manual configuration of the cycle time.
SDRAM RAS to CAS delay	Determines the time span between when a RAS (Row Address Strobe) and a CAS (Column Address Strobe) is performed.	Auto	Offers the best possible system stability.
		3 or 2	Manual configuration of the cycle time.
SDRAM RAS precharge time	The precharge time is the number of cycles it takes for the RAS to accumulate its charge before DRAM refresh. If insufficient time is allowed, refresh may be incomplete and the DRAM may fail to retain data.	Auto	Offers the best possible system stability.
		3 or 2	Manual configuration of the cycle time.
BIOS cacheable	Enabling this allows caching of the BIOS ROM at F0000h-FFFFh, resulting in better system performance. However, if any program writes to this memory area, a system error may result.	Enabled	Activates this function.
		Disabled	Deactivates this function.
Video BIOS cacheable	Enabling this setting allows caching of the Video BIOS ROM at C0000h-C7FFFh, resulting in better graphic performance. However, if any program writes to this memory area, a system error may result.	Enabled	Activates this function.
		Disabled	Deactivates this function.
Memory hole at 15M-16M	You can reserve this area of system memory for ROM memory on ISA cards. When this area is reserved, it cannot be cached. The user information for peripherals that need to use this area of system memory usually describes their memory requirements. Memory over 16 MByte is no longer available.	Enabled	Activates this function.
		Disabled	Deactivates this function.
CPU latency timer	Use this option to control how the processor handles deferrable cycles. Setting options: Enabled, Disabled.	Enabled	Activates this function.
		Disabled	Deactivates this function.
Delayed transaction	The 32-bit write buffer, which functions like a cache during PCI transfers, is activated or deactivated here. To be fully compatible with PCI-1.2, this option should be enabled. This speeds up PCI access. This option should only be disabled when an older card is causing problems.	Enabled	Activates this function.
		Disabled	Deactivates this function.
AGP graphics aperture size	Reserves a memory location in the RAM for AGP (accelerated graphic port), into which the memory access will be directed. AGP memory access (host cycles) to the reserved area are passed on without delay. The larger the value, the faster the textures stored in the main memory can be displayed. The value can be 4, 8, 16, 32, 64, 128 or 256 MB. The default value is 64 MB. The aperture size is a virtual size. It does not require the set amount of memory continuously, but only as required by the graphics card.	64 MB	A 64 MB memory location is reserved in the main memory for graphic access.
		32 MB	A 32 MB memory location is reserved in the main memory for graphic access.

Table 57: Advanced chipset features - description of setting options (cont.)

BIOS setting	Description	Setting options	Effect
System memory frequency	The operating frequency for the main system memory can be set here. Setting options: 100 MHz and 133 MHz (default).	100	100 MHz operating frequency.
		133	133 MHz operating frequency.
		Auto	The operating frequency is set automatically. This is determined by the processor being used.
Power supply type	The type of power supply being used can be entered here.	AT	If using B&R power supply 5PS680.AC01-00 or 5PS680.AC01-01
		ATX	Only if using an ATX power supply.
On-chip video window size	This option determines the amount of the system memory that should be used by AGP cards. Setting options: 64MB, 32MB, Disabled, and Back to 64MB.	64 MB	Uses 64 MB
		Disabled	Deactivates the function
ISA bus clock	This determines the clock ratio between PCI and ISA bus.	11 MHz	Clock frequency setting
		8.33 MHz	Clock frequency setting
8-bit I/O recovery		1 - 16	
16-bit I/O recovery		1 - 16	

Table 57: Advanced chipset features - description of setting options (cont.)

2.5 Integrated peripherals

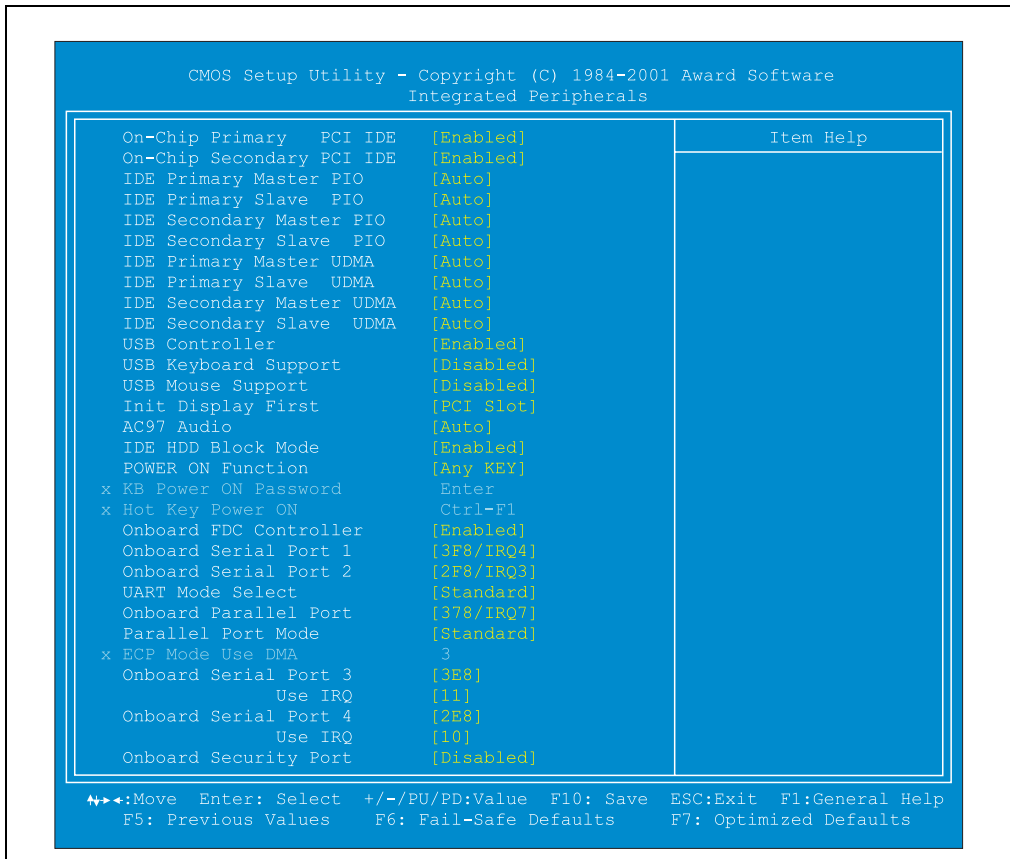

Figure 36: Integrated peripherals

BIOS setting	Description	Setting options	Effect
On-chip primary PCI IDE	Enable or disable the primary PCI IDE controller.	Enabled	Activates the controller.
		Disabled	Deactivates the controller.
On-chip secondary PCI IDE	Enable or disable the secondary PCI IDE controller.	Enabled	Activates the controller.
		Disabled	Deactivates the controller.
IDE primary master PIO	Determine here which PIO mode should be used by the primary master IDE drive.	Auto	Automatic recognition of PIO mode.
		Mode 0 - Mode 4	Manual configuration of PIO mode.
IDE primary slave PIO	Determine here which PIO mode should be used by the primary slave IDE drive.	Auto	Automatic recognition of PIO mode.
		Mode 0 - Mode 4	Manual configuration of PIO mode.

Table 58: Integrated peripherals - description of setting options

BIOS setting	Description	Setting options	Effect
IDE secondary master PIO	Determine here which PIO mode should be used by the secondary master IDE drive.	Auto	Automatic recognition of PIO mode.
		Mode 0 - Mode 4	Manual configuration of PIO mode.
IDE secondary slave PIO	Determine here which PIO mode should be used by the secondary slave IDE drive.	Auto	Automatic recognition of PIO mode.
		Mode 0 - Mode 4	Manual configuration of PIO mode.
IDE primary master UDMA	This option allows you to switch UDMA mode (Ultra DMA) on or off for a primary master drive. If the drives support this mode, this option should definitely be enabled to take advantage of the higher transfer speed.	Auto	Automatic recognition of UDMA mode.
		Disabled	Do not use UDMA mode.
IDE primary slave UDMA	This option allows you to switch UDMA mode (Ultra DMA) on or off for a primary slave drive. If the drives support this mode, this option should definitely be enabled to take advantage of the higher transfer speed.	Auto	Automatic recognition of UDMA mode.
		Disabled	Do not use UDMA mode.
IDE secondary master UDMA	This option allows you to switch UDMA mode (Ultra DMA) on or off for a secondary master drive. If the drives support this mode, this option should definitely be enabled to take advantage of the higher transfer speed.	Auto	Automatic recognition of UDMA mode.
		Disabled	Do not use UDMA mode.
IDE secondary slave UDMA	This option allows you to switch UDMA mode (Ultra DMA) on or off for a secondary slave drive. If the drives support this mode, this option should definitely be enabled to take advantage of the higher transfer speed.	Auto	Automatic recognition of UDMA mode.
		Disabled	Do not use UDMA mode.
USB controller	Here you can activate or deactivate the USB port (Universal Serial Bus). The USB controller requires and occupies one IRQ.	Enabled	The system BIOS determines which system resources (IRQ and addresses) are used.
		Disabled	Turns off the USB controller.
USB keyboard support	Activate/deactivate BIOS USB keyboard driver, if present. This makes it possible to operate the USB keyboard during and after startup, even if the operating system does not have a USB driver.	Enabled	Activates the function.
		Disabled	Deactivates the function.
USB mouse support	If using a USB mouse, this function must be enabled.	Enabled	Activates the function.
		Disabled	Deactivates the function.
Init display first	This option allows you to set which graphics card should be initialized first. Either the PCI slot or the AGP card.	PCI slot	The graphics card in the PCI slot is initialized first.
		AGP	The graphics card in the AGP slot is initialized first.
AC97 audio	If an AC97 audio controller is present, this function allows it to be turned on or off.	Auto	BIOS looks for an AC97 controller.
		Disabled	Deactivates the function.

Table 58: Integrated peripherals - description of setting options (cont.)

BIOS setting	Description	Setting options	Effect
IDE HDD block mode	This option activates the block mode for IDE hard drives. If the drive supports this mode and it is enabled, the number of blocks per request from the configuration sector of the hard drive is read. The recommended setting is enabled. Only old hard drives do not support this mode.	Enabled	Activates the function.
		Disabled	Deactivates the function.
POWER ON function Information: This function is only supported with an ATX power supply.	This option gives you seven choices for how the system should be turned on. The mouse functions only work with PS/2 mice.	Any key (default)	Uses the default startup setting.
Button only			
Keyboard 98			
Password			
Hot key			
KB power on password	If the setting "password" is selected under the BIOS option "POWER ON function", you can enter a password for booting with keyboard operation.	Enter	Enter a password. Enter a password to turn on the system.
Hot key power ON Information: This function is only supported with an ATX power supply.	If the setting "hot key" is selected under the BIOS option "POWER ON function", you can set one of twelve hot keys for turning on the system.	CTRL + F1 to CTRL + F12	This key combination can be used to turn on the system.
Onboard FDC controller	Switches the integrated floppy disk controller on/off.	Enabled	Activates this function.
		Disabled	No disk drives will function.
Onboard serial port 1 and 2	Here you can set the I/O addresses and interrupts of COM1 or COM2 interfaces. The options to choose from are Auto, Disabled, and some settings with predefined parameters. Normally the Auto setting is recommended. Default assignment for the Auto setting:	Disabled 3F8h / IRQ4 2F8h / IRQ3 3E8h / IRQ4 2E8h / IRQ3	Address / interrupt to be used.
UART mode select	This option can only be used if the option "Onboard UART2" is enabled.	Default	RS232 Interface
		Sharp IRrDA	Compatible serial infrared interface
		IrDA SIRrDA	1.0 compatible serial infrared interface.
Onboard parallel port	The settings for the parallel interface LPT1 cannot be automatically detected. They should be selected from a row of predefined values or arbitrarily set with Manual.	Disabled	Deactivates the parallel port.
		378h / IRQ7 278h / IRQ5 3BCh / IRQ7	Select the values to be used from a predefined list of values.

Table 58: Integrated peripherals - description of setting options (cont.)

BIOS setting	Description	Setting options	Effect
Parallel port mode	Here you can set the operating mode of the parallel interface. Please take note that the EPP and ECP modes must be supported by connected devices.	Default	
		SPP	Standard Parallel Port (max. 64 kByte/s unidirectional)
		EPP 1.7	Enhanced Parallel Port v1.7 (max. 2 MByte/s bidirectional)
		EPP 1.9	Enhanced Parallel Port v1.9 (max. 2 MByte/s bidirectional)
		ECP	Enhanced Capability Port (max. 2 MByte/s bidirectional)
		EPP+ECP	Combined EPP/ECP transfer
ECP mode use DMA	This option is only available if, under "Parallel port mode", either ECP or ECP/EPP was selected.	1	DMA mode 1
		3	DMA mode 3
Onboard serial port 3	Here you can identify the address for the third serial connection.	3P8, 3E8, 2F8, 2E8	The third serial interface uses this address.
		Disabled	Deactivates the port.
Use IRQ	Here you can identify the interrupt for the third serial connection.	3, 4, 5, 9, 10, 11, 12, 15	The third serial interface uses this IRQ.
Onboard serial port 4	Here you can identify the address for the fourth serial connection.	3P8, 3E8, 2F8, 2E8	The fourth serial interface uses this address.
		Disabled	Deactivates the port.
Use IRQ	Here you can identify the interrupt for the third serial connection.	3, 4, 5, 9, 10, 11, 12, 15	The fourth serial interface uses this IRQ.
Onboard security port	Here you can identify the address for the security port connection. Only one onboard LPT can be turned on in the system.	378, 3BC, 278	The onboard security port uses this address.
		Disabled	Deactivates this port.

Table 58: Integrated peripherals - description of setting options (cont.)

2.6 Special OEM features

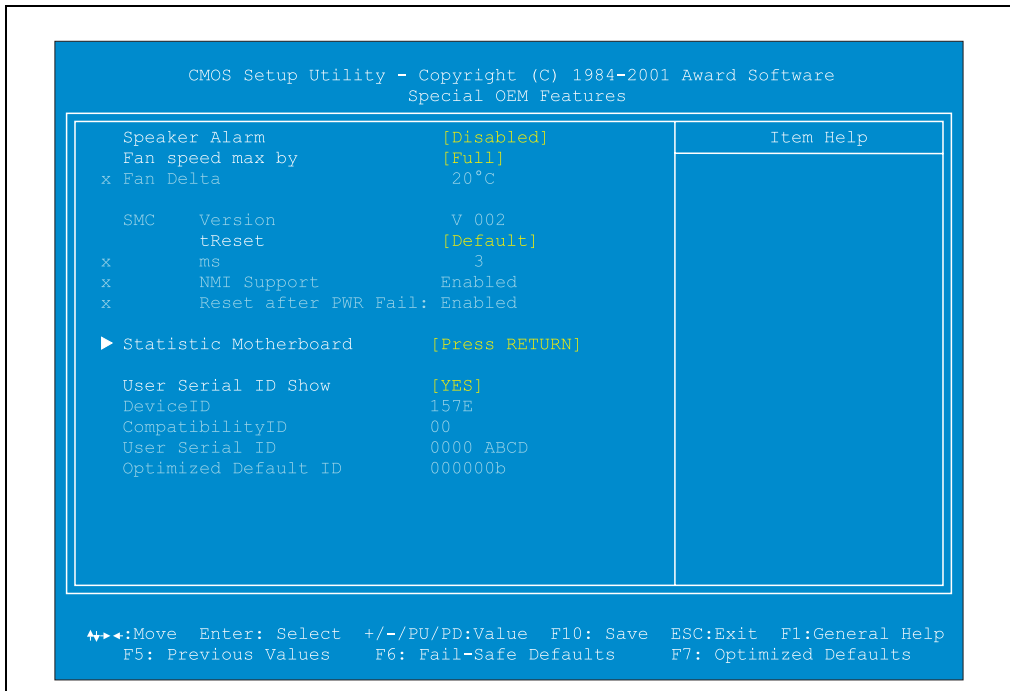

Figure 37: Special OEM features

BIOS setting	Description	Setting options	Effect
Speaker alarm	This function controls the alarm beeper.	Disabled	Beeper does not sound when an alarm is triggered.
		4.4 kHz or 8.7 kHz	Beeper sounds in given frequency range.
Fan speed max by	This function controls the speed of the housing fan in relation to the temperature. The upper limit of the temperature range depends on the processor .	Full	The fans operate at full speed at every temperature.
		Auto	The fan speed is controlled by the processor.
		40, 44, 48, 52, 56, 60, 64, 68, 72, 76, 80, 84, 88, 92, 96 °C	When this temperature is reached, the housing fans operate at full speed.
Fan delta	Only activated when the "Fan speed max by" temperature is set manually. Specifies the control range of the fan in degrees.	20 °C	Fan turns on at "Fan speed max by" temperature minus 20°C.
		40 °C	Fan turns on at "Fan speed max by" temperature minus 40°C.
SMC version	Displays the SMC version.	---	Format V0.xx
tReset	SMC time setting between "Power Good" or reset button and CPU reset.	Default	Default tReset value is 3 ms.
		Manual	Setting of the tReset time.

Table 59: Special OEM features - description of setting options

Software • BIOS settings

BIOS setting	Description	Setting options	Effect
ms	Only activated when tReset is set to Manual.	Possible values between 0 and 63 ms (SMC version V0.05 and up).	tReset time in ms
NMI support	Only activated when tReset is set to Manual. This function triggers a non-maskable interrupt to which application programs can react.	Enabled	Activates the function.
		Disabled	Deactivates the function.
Statistics motherboard	B&R specific parameters such as temperature, fan RPM, and various voltages are displayed here.	Press return	Pressing "ENTER" takes you to the configuration screen for the "Statistics motherboard" on page 113
User serial ID show	A user serial number can be displayed in the device listing window upon system startup. This number can be changed with the B&R APC diagnostic utility via the MTC library.	YES	Activates this function = show user serial number
		No	Deactivates this function.
DeviceID	Hex value of the hardware device ID 157E hex = 5502 for APC680	None	Is shown in the device listing window on system start.
CompatibilityID	Hardware device revision (e.g. 00)	None	Is shown in the device listing window on system start.
User serial ID	0000 ABCD This number can be changed with the B&R APC diagnostic utility.	None	Is shown in the device listing window on system start.
Optimized default ID	Displays the positions of the configuration switches.	None	Depending on the switch position, several optimized setup defaults can be loaded.

Table 59: Special OEM features - description of setting options (cont.)

Statistics motherboard

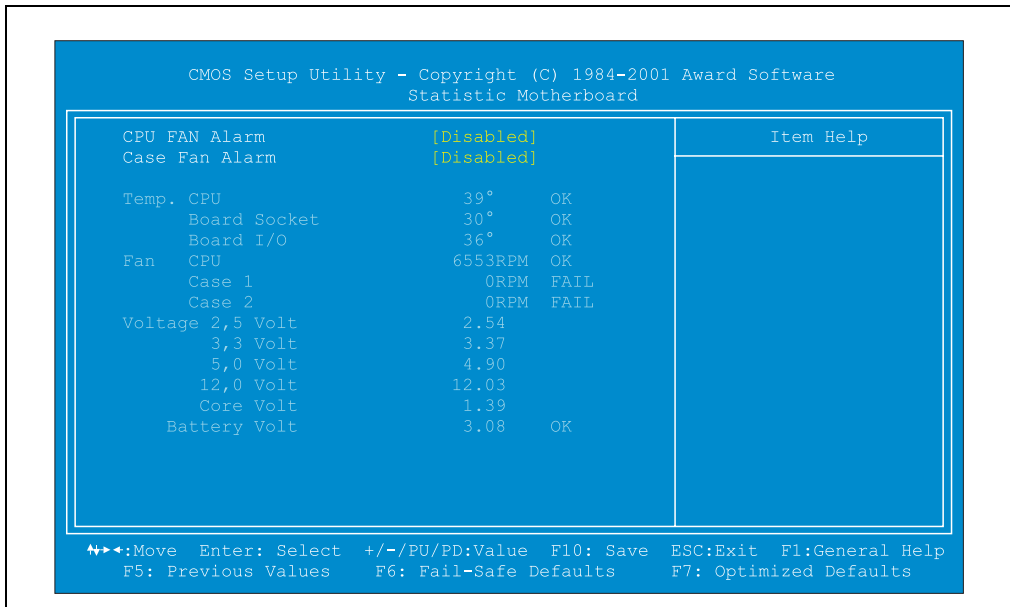

Figure 38: Statistics motherboard

BIOS setting	Description	Setting options	Effect
CPU fan alarm	Monitors the RPM of a connected processor fan.	Disabled	Deactivates the function.
		Enabled	Activates the function.
Case fan alarm	Monitors the RPM of two connected housing fans.	Disabled	Deactivates the function.
		Enabled	Activates the function.
Temp. CPU	Indicates the current processor temperature.	None	-
Temp. board socket	Indicates the current processor board socket temperature.	None	-
Temp. I/O	Indicates the current temperature of the I/O area.	None	-
Fan CPU	Indicates the current RPM of a connected processor fan.	None	-
Case 1	Indicates the current RPM of the first connected housing fan.	None	-
Case 2	Indicates the current RPM of the second connected housing fan.	None	-
Voltage 2.5 volts	Displays the current voltage of the 2.5 volt supply.	None	-
Voltage 3.3 volts	Displays the current voltage of the 3.3 volt supply.	None	-

Table 60: Statistics motherboard - description of setting options

BIOS setting	Description	Setting options	Effect
Voltage 5.0 volts	Displays the current voltage of the 5 volt supply.	None	-
Voltage 12.0 volts	Displays the current voltage of the 12 volt supply.	None	-
Core volt	Displays the processor's core voltage.	None	
Battery volt	Displays the battery voltage.	None	

Table 60: Statistics motherboard - description of setting options (cont.)

2.7 Power management setup

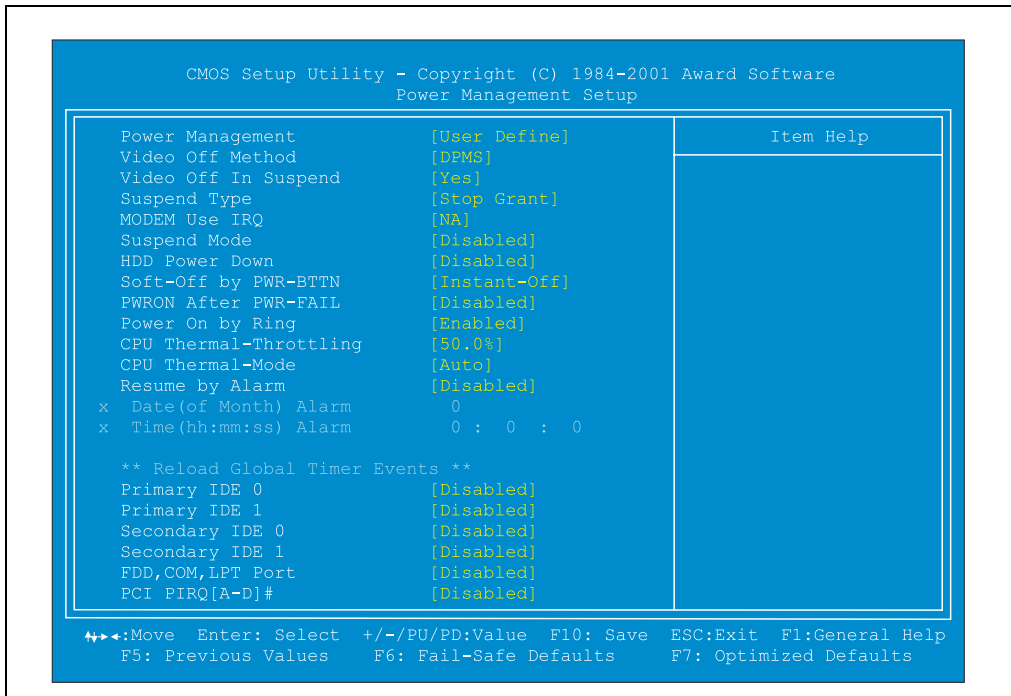

Figure 39: Power management setup

BIOS setting	Description	Setting options	Effect
Power management	This option allows you to define the type (or degree) of power saving, meaning that after a certain period of inactivity certain components of the system are switched off.	User define	The values for Doze, Standby, Suspend and HDD power down mode can be set individually.
		Min saving	After an inactivity period of one hour, all system components that can be switched off go into energy saving mode.
		Max saving	This setting activates the highest level of energy savings. This mode is only available on SL-CPU's.

Table 61: Power management setup - description of setting options

BIOS setting	Description	Setting options	Effect
Video off method	Determines the condition of the monitor when it is in Standby mode.	Blank screen	This option causes older monitors to shut off.
		V/H sync+blank	Especially old monitors that have no energy saving function are switched to black.
		DPMS	With this option the energy saving mode is controlled by the graphics card, according to the VESA DPMS standard (Display Power Management Signaling).
Video off in suspend	These settings allow you to determine how the monitor is turned off.	Yes	In suspend mode, the monitor switches to standby mode.
		No	Monitor continues to run.
Suspend type	This option has two possible settings: Stop grant and PwrOn suspend.	Stop grant	The processor is stopped completely.
		PwrOn suspend	Processor continues to run.
Modem use IRQ	The interrupt line (IRQ) of a modem, if one is present, can be entered here. Activities on this line can, for example, prepare the computer for fax reception.	NA	No interrupt is assigned.
		3, 4, 5, 7, 9, 10 or 11	One of these interrupts is assigned.
Suspend mode	With this option you can determine after which time of user inactivity all the system components (apart from the processor) should be switched off.	Disabled	Deactivates the function.
		1 min , 2 min , 4 min, 8 min , 12 min , 20 min , 30 min , 40 min , 1 hour	After this amount of time has elapsed the system BIOS switches to suspend mode.
HDD power down	With this option you can determine after which time of user inactivity the hard disk should be switched off (if there are a number of hard disks in the IPC, then all are switched off). Can only be set when the function "Power management" is set to "User define".	Disabled	Deactivates the function.
		1 to 15 min	The hard disk is turned off after this time has passed.
Soft-off by PWR-BTTN	This option determines how the PC behaves when the operating system is turned off.	Instant-off	PC turns off automatically after being shut down. This function must be supported by the hardware.
		Delay 4 sec.	ATX switch must be held for 4 seconds to turn off the PC.
PWRON after PWR-fail	This option controls how the PC restarts after a power failure.	Off	After a power failure the PC does not turn back on automatically.
		On	After a power failure the PC turns back on automatically.
		Former sts.	Remembers the last status of the power on button and reacts accordingly.
Power on by ring	If an external modem is connected to the onboard serial port and the telephone rings, the system starts up.	Enabled	Function is activated.
		Disabled	Function is deactivated.
CPU thermal throttling	This option allows you to set the percentage of performance the CPU drops to at a defined temperature limit (can be set under the BIOS parameter "CPU thermal mode"). This BIOS function is also referred to as "Throttle duty cycle".	87.5%, 75.0%, 62.5%, 50.0%, 37.5%, 25.0%, 12.5%	The CPU drops to this percentage of performance when it reaches a defined temperature (can be set under the BIOS parameter "CPU thermal throttling").

Table 61: Power management setup - description of setting options (cont.)

BIOS setting	Description	Setting options	Effect
CPU thermal mode	Here you can set the processor temperature at which the CPU performance is reduced to the percentage set under the BIOS parameter "CPU thermal throttling".	Auto	The temperature setting is controlled automatically by the processor.
		50 °C, 51 °C ... 89 °C and 90 °C	The upper limit of the temperature range depends on the processor .
Resume by alarm	If this option is activated and the ring indicator line shows an incoming call on the modem, the PC is brought out of power saving mode. On a computer with a software controlled ATX power supply it is awoken out of standby/suspend mode. The date and time this occurs can also be set. Entering 0 for the date tells the system to start at the same time every day.	Disabled	Deactivates the function.
		Enabled	Activates the function.
Date (of month) alarm	This function is only active if the function "Resume by alarm" is set to enabled.	Date	BIOS starts up the system on this date. Can only be used with an ATX power supply.
Time (hh:mm:ss) alarm	This function is only active if the function "Resume by alarm" is set to enabled.	Time	BIOS starts up the system at this time. Can only be used with an ATX power supply.
Reload global timer events	There are a number of interrupts available whose activity wakes the PC from doze or standby mode.	None	-
Primary IDE 0	If this option is enabled, the system activates the energy saving timer when there is no activity on the first drive of the first IDE/EIDE port. Setting options: Enabled, Disabled.	Disabled	Deactivates the function.
		Enabled	Activates the function.
Primary IDE 1	If this option is enabled, the system activates the energy saving timer when there is no activity on the second drive of the first IDE/EIDE port. Setting options: Enabled, Disabled.	Disabled	Deactivates the function.
		Enabled	Activates the function.
Secondary IDE 0	If this option is enabled, the system activates the energy saving timer when there is no activity on the first drive of the second IDE/EIDE port. Setting options: Enabled, Disabled.	Disabled	Deactivates the function.
		Enabled	Activates the function.
Secondary IDE 1	If this option is enabled, the system activates the energy saving timer when there is no activity on the second drive of the second IDE/EIDE port. Setting options: Enabled, Disabled.	Disabled	Deactivates the function.
		Enabled	Activates the function.
FDD,COM,LPT port	Activate/deactivate the ports that can cause the system to switch into or out of energy saving mode. The system will continue to monitor the activity on all enabled devices. Setting options: Enabled, Disabled.	Disabled	Deactivates the function.
		Enabled	Activates the function.
PCI PIRQ[A-D]#	This option influences the time control for power management. When this option is enabled a countdown begins that is interrupted as soon as the INTA-INTD signal becomes active. It is reset to zero.	Disabled	Deactivates the function.
		Enabled	Activates the function.

Table 61: Power management setup - description of setting options (cont.)

PnP/PCI configuration

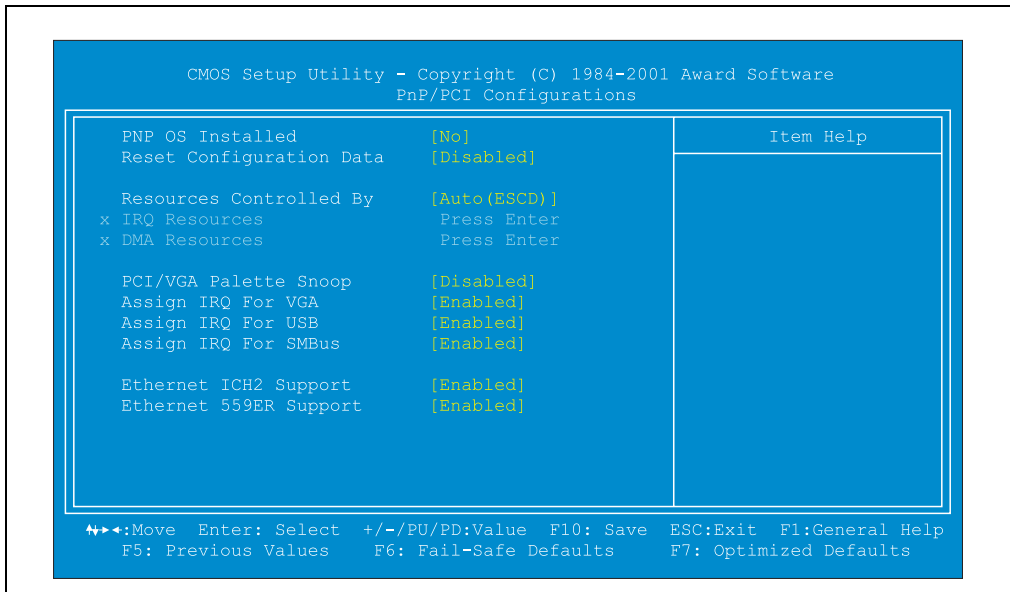

Figure 40: PnP/PCI configuration setup

BIOS setting	Description	Setting options	Effect
PNP OS installed	If the operating system is plug & play capable, the resources are distributed automatically.	Yes	The ISA PnP resources are not assigned. The resource assignment sequence is as follows: 1. Motherboard devices 2. PCI devices
		No	The resource assignment sequence is as follows: 1. Motherboard devices 2. ISA PnP devices 3. PCI devices
Reset configuration data	During booting, the assigned resources are stored in the Flash (ESCD).	Disabled	Deactivates the function.
		Enabled	When the system is reset after leaving the BIOS setup, all ESCD entries (extended system configuration data) are deleted.
Resources controlled by	Determines whether individual resources (IRQ, DMA) are reserved.	Auto (ESCD)	When set to "Auto (ESCD)", BIOS can automatically configure all Plug and Play compatible and bootable devices.
		Manual	When set to Manual, all IRQ and DMA resource settings can be reserved.
IRQ resources	Only active when "Resources controlled by" is set to Manual.	Press Enter	Pressing "ENTER" takes you to the configuration screen for the "IRQ resources" on page 119
DMA resources	Only active when "Resources controlled by" is set to Manual.	Press Enter	Pressing "ENTER" takes you to the configuration screen for the "DMA resources" on page 121

Table 62: PnP/PCI configuration setup - description of setting options

Software • BIOS settings

BIOS setting	Description	Setting options	Effect
PCI/VGA palette snoop	This function enables BIOS to display the color table of a PCI graphics card and then, if necessary, to transmit this information to the video card.	Disabled	Deactivates the function.
		Enabled	Activates the function.
Assign IRQ for VGA	Assignment of an interrupt for the VGA controller integrated in the chipset.	Disabled	Deactivates the function.
		Enabled	Activates the function.
Assign IRQ for USB	Assignment of an interrupt for the USB controller.	Disabled	Deactivates the function.
		Enabled	Activates the function.
Assign IRQ for SM bus	Assignment of an interrupt for the system management bus.	Disabled	Deactivates the function.
		Enabled	Activates the function.
Ethernet ICH2 support	Assignment of an interrupt for the Ethernet controller integrated in the chipset.	Disabled	Deactivates the function.
		Enabled	Activates the function.
Ethernet 55xER support	Assignment of an interrupt for the Intel Ethernet controller used in the Slot CPU.	Disabled	Deactivates the function.
		Enabled	Activates the function.

Table 62: PnP/PCI configuration setup - description of setting options (cont.)

IRQ resources

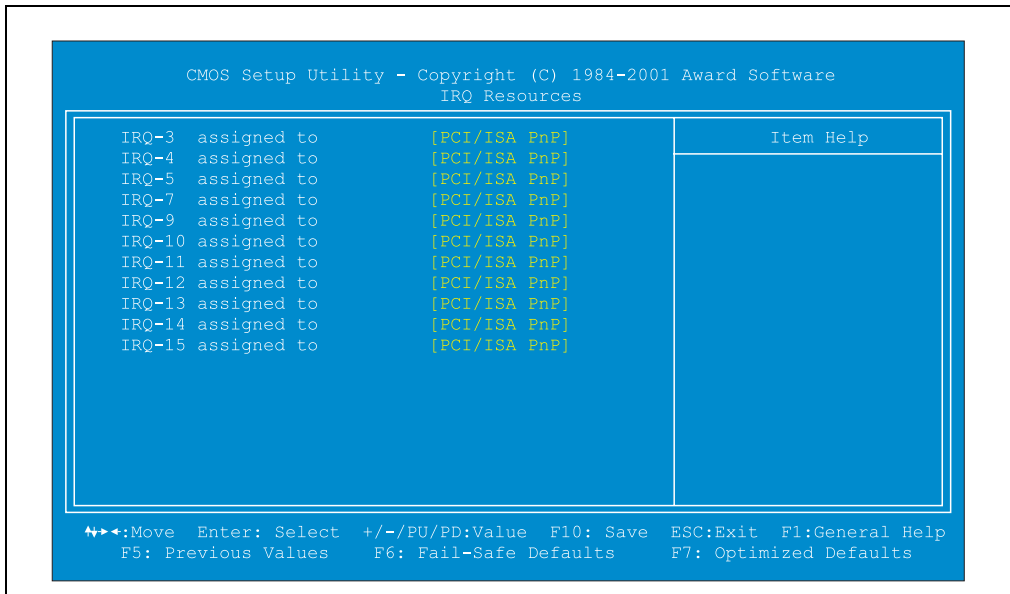

Figure 41: IRQ resources setup

BIOS setting	Description	Setting options	Effect
IRQ-3 assigned to	Assign an ISA or PCI slot to the IRQ 3.	PCI/ISA PnP	This resource is free for PCI or ISA-PnP.
		Legacy ISA	This resource is reserved for ISA.
IRQ-4 assigned to	Assign an ISA or PCI slot to the IRQ 4.	PCI/ISA PnP	This resource is free for PCI or ISA-PnP.
		Legacy ISA	This resource is reserved for ISA.
IRQ-5 assigned to	Assign an ISA or PCI slot to the IRQ 5.	PCI/ISA PnP	This resource is free for PCI or ISA-PnP.
		Legacy ISA	This resource is reserved for ISA.
IRQ-7 assigned to	Assign an ISA or PCI slot to the IRQ 7.	PCI/ISA PnP	This resource is free for PCI or ISA-PnP.
		Legacy ISA	This resource is reserved for ISA.
IRQ-9 assigned to	Assign an ISA or PCI slot to the IRQ 9.	PCI/ISA PnP	This resource is free for PCI or ISA-PnP.
		Legacy ISA	This resource is reserved for ISA.
IRQ-10 assigned to	Assign an ISA or PCI slot to the IRQ 10.	PCI/ISA PnP	This resource is free for PCI or ISA-PnP.
		Legacy ISA	This resource is reserved for ISA.
IRQ-11 assigned to	Assign an ISA or PCI slot to the IRQ 11.	PCI/ISA PnP	This resource is free for PCI or ISA-PnP.
		Legacy ISA	This resource is reserved for ISA.
IRQ-12 assigned to	Assign an ISA or PCI slot to the IRQ 12.	PCI/ISA PnP	This resource is free for PCI or ISA-PnP.
		Legacy ISA	This resource is reserved for ISA.

Table 63: IRQ resources setup - description of setting options

BIOS setting	Description	Setting options	Effect
IRQ-13 assigned to	Assign an ISA or PCI slot to the IRQ 13.	PCI/ISA PnP	This resource is free for PCI or ISA-PnP.
		Legacy ISA	This resource is reserved for ISA.
IRQ-14 assigned to	Assign an ISA or PCI slot to the IRQ 14.	PCI/ISA PnP	This resource is free for PCI or ISA-PnP.
		Legacy ISA	This resource is reserved for ISA.
IRQ-15 assigned to	Assign an ISA or PCI slot to the IRQ 15.	PCI/ISA PnP	This resource is free for PCI or ISA-PnP.
		Legacy ISA	This resource is reserved for ISA.

Table 63: IRQ resources setup - description of setting options (cont.)

DMA resources

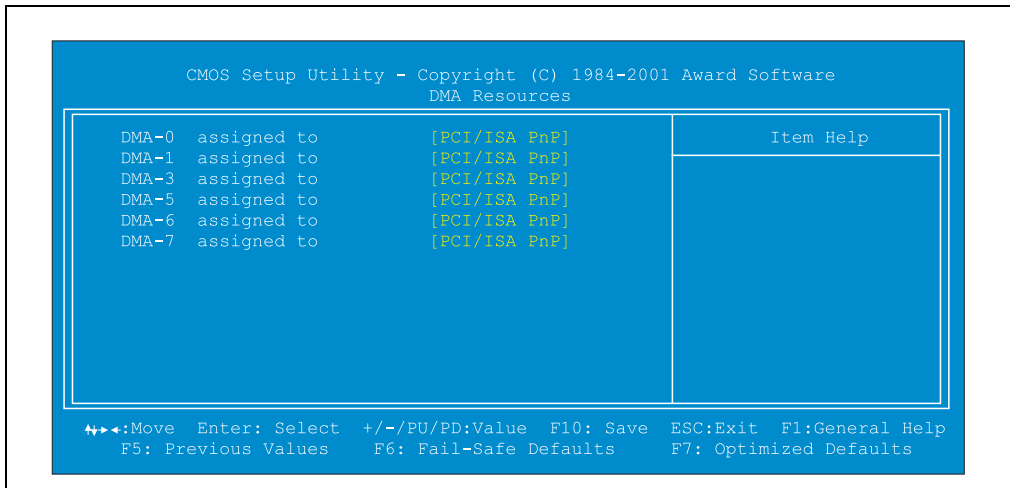

Figure 42: DMA resources setup

BIOS setting	Description	Setting options	Effect
DMA-0 assigned to	Assign an ISA or PCI slot to the DMA 0.	PCI/ISA PnP	This resource is free for PCI or ISA-PnP.
		Legacy ISA	This resource is reserved for ISA.
DMA-1 assigned to	Assign an ISA or PCI slot to the DMA 0.	PCI/ISA PnP	This resource is free for PCI or ISA-PnP.
		Legacy ISA	This resource is reserved for ISA.
DMA-3 assigned to	Assign an ISA or PCI slot to the DMA 3.	PCI/ISA PnP	This resource is free for PCI or ISA-PnP.
		Legacy ISA	This resource is reserved for ISA.
DMA-5 assigned to	Assign an ISA or PCI slot to the DMA 5.	PCI/ISA PnP	This resource is free for PCI or ISA-PnP.
		Legacy ISA	This resource is reserved for ISA.
DMA-6 assigned to	Assign an ISA or PCI slot to the DMA 6.	PCI/ISA PnP	This resource is free for PCI or ISA-PnP.
		Legacy ISA	This resource is reserved for ISA.
DMA-7 assigned to	Assign an ISA or PCI slot to the DMA 7.	PCI/ISA PnP	This resource is free for PCI or ISA-PnP.
		Legacy ISA	This resource is reserved for ISA.

Table 64: DMA resources setup - description of setting options

Frequency / voltage control

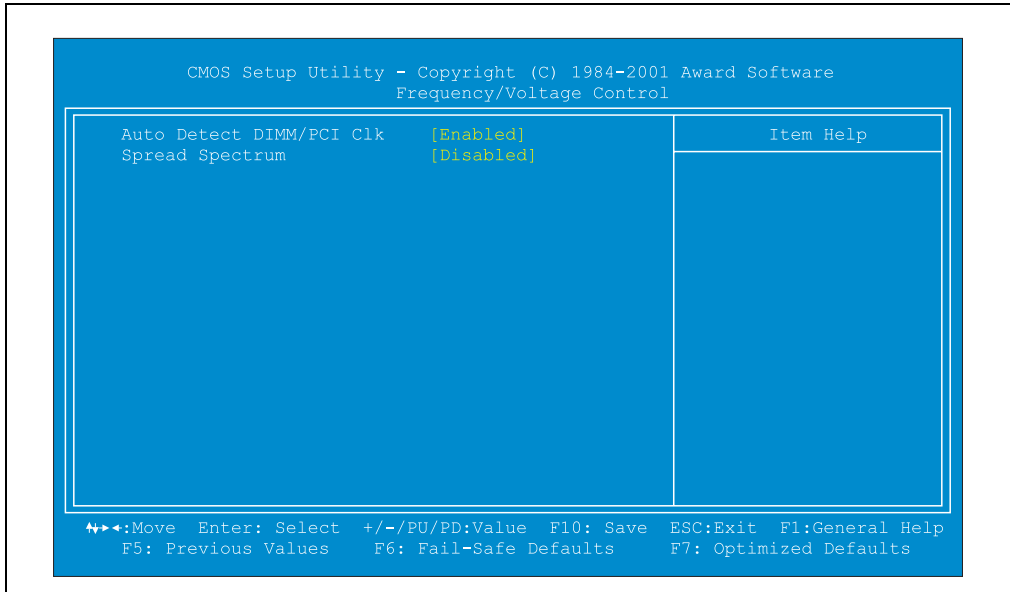

Figure 43: Frequency / voltage control setup

BIOS setting	Description	Setting options	Effect
Auto-detect DIMM/ PCI Clk	Unoccupied DIMM and PCI slots are separated from the clock generator with this option. This option influences the Automation PCs electromagnetic emissions.	Enabled	Activates the function.
		Disabled	Deactivates the function
Spread spectrum	Changes the disturbances emitted from the APC. The APC reduces the amount of disturbances that affect other devices.	Enabled	Activates the function.
		Disabled	Deactivates the function

Table 65: Frequency / voltage control setup - description of setting options

2.8 Load fail safe defaults

Load the minimum settings needed just to get the system running.

2.9 Load optimized defaults

Load specific BIOS defaults, depending on the positions of the configuration switches.

2.10 Set supervisor password

A supervisor password for BIOS setup can be set here.

2.11 Set user password

Here you can set up a password for the user.

2.12 Save & exit setup

BIOS Setup Utility is closed with this item. Changes made are saved in CMOS after confirmation.

Note: In order to confirm, the z key must be pressed when using a German keyboard (US keyboard layout).

2.13 Exit without saving

With this item you can close the BIOS Setup Utility without saving the changes made in the CMOS.

Information:

If using a German keyboard layout, press the "z" key to enter the "y".

3. BIOS upgrade

A BIOS upgrade might be necessary for the following reason:

- To update implemented functions or to add newly implemented functions or components in the BIOS setup (information about changes can be found in the readme files of the BIOS upgrade).

A current BIOS upgrade can be found on the HMI Drivers & Utilities CD-ROM (model number 5S0000.01-090 starting from version 1.49) or can be directly downloaded from the download area on the B&R homepage (www.br-automation.com).

Complete the following steps to perform a BIOS upgrade:

- First, an empty diskette must be made bootable (commando line "sys a:" or "format a: /s")
- Copy the content of the *.zip file to this diskette.
- Insert the diskette in the floppy drive and reboot the system.
- After booting from the diskette (and making the correct BIOS settings) start the upgrade by entering "update" and confirming it with "Return".
- It is then possible to save the current BIOS. By answering the question "Do you want to save BIOS (y/n)" you can choose to save the current BIOS.

Information:

If using a German keyboard layout, press the "z" key to enter the "y".

- A name (max. 8 char.) can now be assigned to the BIOS data with "Save current BIOS as:". Due to the size of the BIOS data, an empty and formatted HD diskette must be in the disk drive before confirming with Return. After saving the data, the BIOS upgrade must be started from the beginning (by entering "update").
- To start the upgrade, enter "y" in response to the choice Press "y" to program or "n" to exit .
- The system must be rebooted by pressing "F1" after a successful upgrade.

4. Load optimized default settings

Information:

If the function "Load optimized defaults" is chosen in BIOS version 1.01, the following settings will be used. For this reason, the settings may not match with the BIOS version installed on your device.

It is possible to load various profiles with the "optimized default" settings by setting the configuration switches accordingly. For the positioning of the configuration switches see figure 5 "Components - Slot CPU" on page 34.

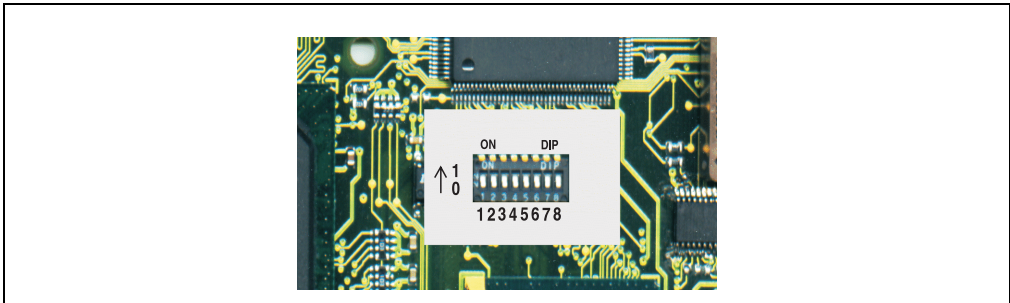

Figure 44: Configuration switches - detailed view

4.1 Profile 0

The first six DIP switches (1-6) are in position zero. The rest (7,8) are reserved.

Configuration switch positioning								
chipset DIP switches		Profile DIP switches						
8 ¹⁾	7 ¹⁾	6	5	4	3	2	1	Configuration
X	X	OFF	OFF	OFF	OFF	OFF	OFF	Load optimized default - profile 0

Table 66: Configuration switch positioning - profile 0

1) Reserved for chipset specific settings. Must not be changed.

4.1.1 Standard CMOS features

BIOS setting	BIOS version A016
Drive A	1.44 MB
Drive B	None
Video	EGA/VGA

Table 67: Standard CMOS features - load optimized defaults, profile 0

Software • Load optimized default settings

BIOS setting	BIOS version A016
Halt on	All but keyboard

Table 67: Standard CMOS features - load optimized defaults, profile 0

4.1.2 Advanced BIOS features

BIOS setting	BIOS version A016
Virus warning	Disabled
CPU internal cache	Enabled
External cache	Enabled
CPU L2 cache ECC checking	Enabled
Processor number feature	Enabled
Quick Power On Self Test	Enabled
First boot device	Floppy
Second boot device	HDD-0
Third boot device	CDROM
Boot other device	Enabled
Swap floppy drive	Disabled
Boot up floppy seek	Enabled
Boot up NumLock status	On
Gate A20 option	Fast
Typematic rate setting	Disabled
Security option	Setup
PS/2 mouse function control	Enabled
OS Select for DRAM > 64 MB	Non-OS2
HDD S.M.A.R.T capability	Disabled
Report no FDD for WIN 95	No
Small logo (EPA) show	Disabled

Table 68: Advanced BIOS features - load optimized defaults, profile 0

4.1.3 Advanced chipset features

BIOS setting	BIOS version A016
SDRAM CAS latency time	Auto
SDRAM cycle time Tras/Trc	Auto
SDRAM RAS to CAS delay	Auto
SDRAM RAS precharge time	Auto
BIOS cacheable	Enabled
Video BIOS cacheable	Enabled

Table 69: Advanced chipset features - load optimized defaults, profile 0

BIOS setting	BIOS version A016
Memory hole at 15M-16M	Disabled
CPU latency timer	Enabled
Delayed transaction	Disabled
AGP graphics aperture size	64 MB
System memory frequency	Auto
Power supply type	AT
On-chip video window size	64 MB
ISA bus clock	8.33 MHz
8-bit I/O recovery	5
16-bit I/O recovery	4

Table 69: Advanced chipset features - load optimized defaults, profile 0 (cont.)

4.1.4 Integrated peripherals

BIOS setting	BIOS version A016
On-chip primary PCI IDE	Enabled
On-chip secondary PCI IDE	Enabled
IDE primary master PIO	Auto
IDE primary slave PIO	Auto
IDE secondary master PIO	Auto
IDE secondary slave PIO	Auto
IDE primary master UDMA	Auto
IDE primary slave UDMA	Auto
IDE secondary master UDMA	Auto
IDE secondary slave UDMA	Auto
USB controller	Enabled
USB keyboard support	Enabled
USB mouse support	Disabled
Init display first	PCI slot
AC97 audio	Auto
IDE HDD block mode	Enabled
POWER ON function	Button only
KB power on password	Enter
Hot key power ON	Ctrl + F1
Onboard FDC controller	Enabled
Onboard serial port 1	3F8/IRQ4
Onboard serial port 2	2F8 / IRQ3
UART mode select	Default

Table 70: Integrated peripherals - load optimized defaults, profile 0

Software • Load optimized default settings

BIOS setting	BIOS version A016
Onboard parallel port	Disabled
Parallel port mode	Default
ECP mode use DMA	3
Onboard serial port 3	3E8
Use IRQ	11
Onboard serial port 4	2E8
Use IRQ	10
Onboard security port	278

Table 70: Integrated peripherals - load optimized defaults, profile 0 (cont.)

4.1.5 Special OEM feature

BIOS setting	BIOS version A016
Speaker alarm	4.4 kHz
Fan speed max by	Auto
Fan delta	20 °C
SMC version	V xxx
tReset	Default
ms	3
NMI support	Enabled
Statistics motherboard	Press return
User serial ID show	Yes
DeviceID	157E
CompatibilityID	xx
User serial ID	xxxx yyyy
Optimized default ID	000000b

Table 71: Special OEM features - load optimized defaults, profile 0

4.1.6 Statistics motherboard

BIOS setting	BIOS version A016
CPU fan alarm	Disabled
Case fan alarm	Enabled

Table 72: Statistics motherboard - load optimized defaults, profile 0

4.1.7 Power management setup

BIOS setting	BIOS version A016
Power management	User define

Table 73: Power management setup - load optimized defaults, profile 0

BIOS setting	BIOS version A016
Video off method	DPMS
Video off in suspend	Yes
Suspend type	Stop grant
Modem use IRQ	NA
Suspend mode	Disabled
HDD power down	Disabled
Soft-off by PWR-BTTN	Instant-off
PWRON after PWR-fail	On
Power on by ring	Disabled
CPU thermal throttling	75 %
CPU thermal mode	Auto
Resume by alarm	Disabled
Date (of month) alarm	0
Time (hh:mm:ss) alarm	0 : 0 : 0
Reload global timer events	-
Primary IDE 0	Disabled
Primary IDE 1	Disabled
Secondary IDE 0	Disabled
Secondary IDE 1	Disabled
FDD,COM,LPT port	Disabled
PCI PIRQ[A-D]#	Disabled

Table 73: Power management setup - load optimized defaults, profile 0 (cont.)

4.1.8 PnP/PCI configuration

BIOS setting	BIOS version A016
PNP OS installed	Yes
Reset configuration data	Disabled
Resources controlled by	Auto (ESCD)
IRQ resources	Press Enter
DMA resources	Press Enter
PCI/VGA palette snoop	Disabled
Assign IRQ for VGA	Enabled
Assign IRQ for USB	Enabled
Assign IRQ for SM bus	Disabled
Ethernet ICH2 support	Enabled
Ethernet 559ER support	Enabled

Table 74: PnP/PCI configurations - load optimized defaults, profile 0

4.1.9 Frequency / voltage control

BIOS setting	BIOS version A016
Auto-detect DMI/PCI Clk	Enabled
Spread spectrum	Enabled

Table 75: Frequency / voltage control - load optimized defaults, profile 0

4.2 Profile 1

The first configuration switch (1) is in position one. The other five DIP switches (2-5) are in position zero. The rest (7,8) are reserved.

Configuration switch positioning								
chipset DIP switches		Profile DIP switches						
8 ¹⁾	7 ¹⁾	6	5	4	3	2	1	Configuration
X	X	OFF	OFF	OFF	OFF	OFF	ON	Load optimized default - profile 1

Table 76: Configuration switch positioning - profile 1

1) Reserved for chipset specific settings. Must not be changed.

4.2.1 Standard CMOS features

BIOS setting	BIOS version A016
Drive A	None
Drive B	None
Video	EGA/VGA
Halt on	No errors

Table 77: Standard CMOS features - load optimized defaults, profile 1

4.2.2 Advanced BIOS features

BIOS setting	BIOS version A016
Virus warning	Disabled
CPU internal cache	Enabled
External cache	Enabled
CPU L2 cache ECC checking	Enabled
Processor number feature	Enabled
Quick Power On Self Test	Enabled
First boot device	HDD-0
Second boot device	Disabled
Third boot device	Disabled
Boot other device	Disabled
Swap floppy drive	Disabled
Boot up floppy seek	Disabled
Boot up NumLock status	On
Gate A20 option	Fast
Typematic rate setting	Disabled
Security option	Setup

Table 78: Advanced BIOS features - load optimized defaults, profile 1

Software • Load optimized default settings

BIOS setting	BIOS version A016
PS/2 mouse function control	Enabled
OS Select for DRAM > 64 MB	Non-OS2
HDD S.M.A.R.T capability	Disabled
Report no FDD for WIN 95	Yes
Small logo (EPA) show	Disabled

Table 78: Advanced BIOS features - load optimized defaults, profile 1 (cont.)

4.2.3 Advanced chipset features

BIOS setting	BIOS version A016
SDRAM CAS latency time	Auto
SDRAM cycle time Tras/Trc	Auto
SDRAM RAS to CAS delay	Auto
SDRAM RAS precharge time	Auto
BIOS cacheable	Enabled
Video BIOS cacheable	Enabled
Memory hole at 15M-16M	Disabled
CPU latency timer	Enabled
Delayed transaction	Disabled
AGP graphics aperture size	64 MB
System memory frequency	Auto
Power supply type	AT
On-chip video window size	64 MB
ISA bus clock	8.33 MHz
8-bit I/O recovery	5
16-bit I/O recovery	4

Table 79: Advanced chipset features - load optimized defaults, profile 1

4.2.4 Integrated peripherals

BIOS setting	BIOS version A016
On-chip primary PCI IDE	Enabled
On-chip secondary PCI IDE	Disabled
IDE primary master PIO	Auto
IDE primary slave PIO	Auto
IDE secondary master PIO	Auto
IDE secondary slave PIO	Auto
IDE primary master UDMA	Auto

Table 80: Integrated peripherals - load optimized defaults, profile 1

BIOS setting	BIOS version A016
IDE primary slave UDMA	Auto
IDE secondary master UDMA	Auto
IDE secondary slave UDMA	Auto
USB controller	Enabled
USB keyboard support	Disabled
USB mouse support	Disabled
Init display first	PCI slot
AC97 audio	Auto
IDE HDD block mode	Enabled
POWER ON function	Button only
KB power on password	Enter
Hot key power ON	Ctrl + F1
Onboard FDC controller	Disabled
Onboard serial port 1	3F8/IRQ4
Onboard serial port 2	2F8 / IRQ3
UART mode select	Default
Onboard parallel port	Disabled
Parallel port mode	Default
ECP mode use DMA	3
Onboard serial port 3	3E8
Use IRQ	10
Onboard serial port 4	2E8
Use IRQ	11
Onboard security port	Disabled

Table 80: Integrated peripherals - load optimized defaults, profile 1 (cont.)

4.2.5 Special OEM features

BIOS setting	BIOS version A016
Speaker alarm	Disabled
Fan speed max by	Full
Fan delta	20 °C
SMC version	V xxx
IReset	Manual
ms	0
NMI support	Disabled
Statistics motherboard	Press RETURN
User serial ID show	YES

Table 81: Special OEM features - load optimized defaults, profile 1

Software • Load optimized default settings

BIOS setting	BIOS version A016
DeviceID	157E
CompatibilityID	xx
User serial ID	xxxx yyyy
Optimized default ID	000001b

Table 81: Special OEM features - load optimized defaults, profile 1 (cont.)

4.2.6 Statistics motherboard

BIOS setting	BIOS version A016
CPU fan alarm	Disabled
Case fan alarm	Enabled

Table 82: Statistics motherboard - load optimized defaults, profile 1

4.2.7 Power management setup

BIOS setting	BIOS version A016
Power management	User define
Video off method	DPMS
Video off in suspend	Yes
Suspend type	Stop grant
Modem use IRQ	NA
Suspend mode	Disabled
HDD power down	Disabled
Soft-off by PWR-BTTN	Instant-off
PWRON after PWR-fail	On
Power on by ring	Disabled
CPU thermal throttling	75 %
CPU thermal mode	Auto
Resume by alarm	Disabled
Date (of month) alarm	0
Time (hh:mm:ss) alarm	0 : 0 : 0
Reload global timer events	-
Primary IDE 0	Disabled
Primary IDE 1	Disabled
Secondary IDE 0	Disabled
Secondary IDE 1	Disabled
FDD,COM,LPT port	Disabled
PCI PIRQ[A-D]#	Disabled

Table 83: Power management setup - load optimized defaults, profile 1

4.2.8 PnP/PCI configuration

BIOS setting	BIOS version A016
PNP OS installed	Yes
Reset configuration data	Disabled
Resources controlled by	Auto (ESCD)
IRQ resources	Press Enter
DMA resources	Press Enter
PCI/VGA palette snoop	Disabled
Assign IRQ for VGA	Enabled
Assign IRQ for USB	Enabled
Assign IRQ for SM bus	Disabled
Ethernet ICH2 support	Enabled
Ethernet 559ER support	Enabled

Table 84: PnP/PCI configurations - load optimized defaults, profile 1

4.2.9 Frequency / voltage control

BIOS setting	BIOS version A016
Auto-detect DMI/PCI Clk	Enabled
Spread spectrum	Enabled

Table 85: Frequency / voltage control - load optimized defaults, profile 1

5. B&R IPC Diagnostics Utility

The following information about the APC can be retrieved using the "IPC Diagnostics Utility":

- Type
- Temperatures
- Alarms
- Voltage
- Fan information
- User serial ID

The B&R IPC Diagnostics Utility can be found on the HMI Drivers & Utilities CD ROM (model number 5S0000.01-090) V1.49 and up. It can also be downloaded from the B&R homepage (www.br-automation.com) under the name MTC & Mkey Utilities V2.00 (Category: Panel Systems - Automation PC680 - Utilities).

Info, controller, and version pages are called up by selecting the appropriate tab.

5.1 Info tab

The Info tab provides information about the program being used. This can include the version and build numbers as well as the copyright. The controller being used is pictured on the left side.

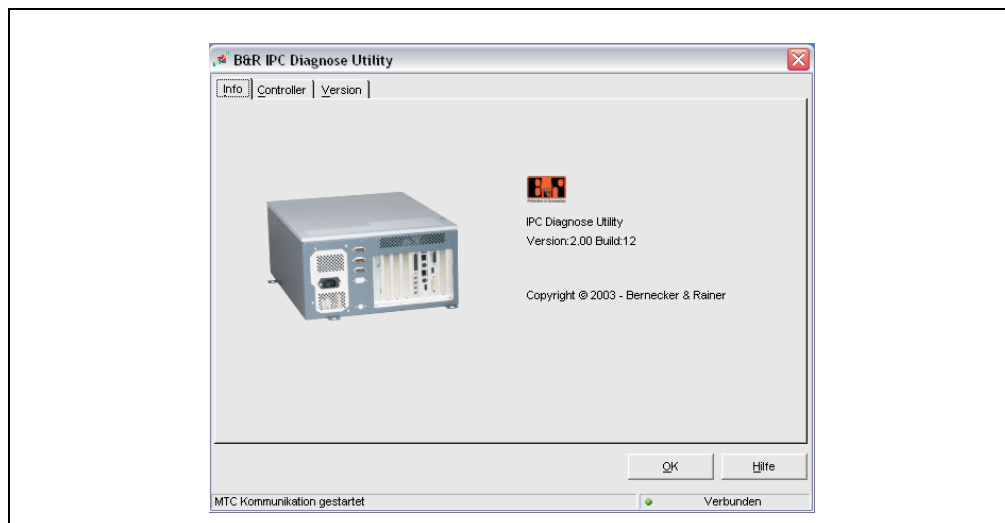

Figure 45: B&R IPC Diagnostics Utility - tab info

5.2 Controller

On the controller tab you will find additional information about the type, temperature, alarms, voltages, fans and user serial ID.

5.2.1 Controller - type

Shows the type and ID of the controller used.

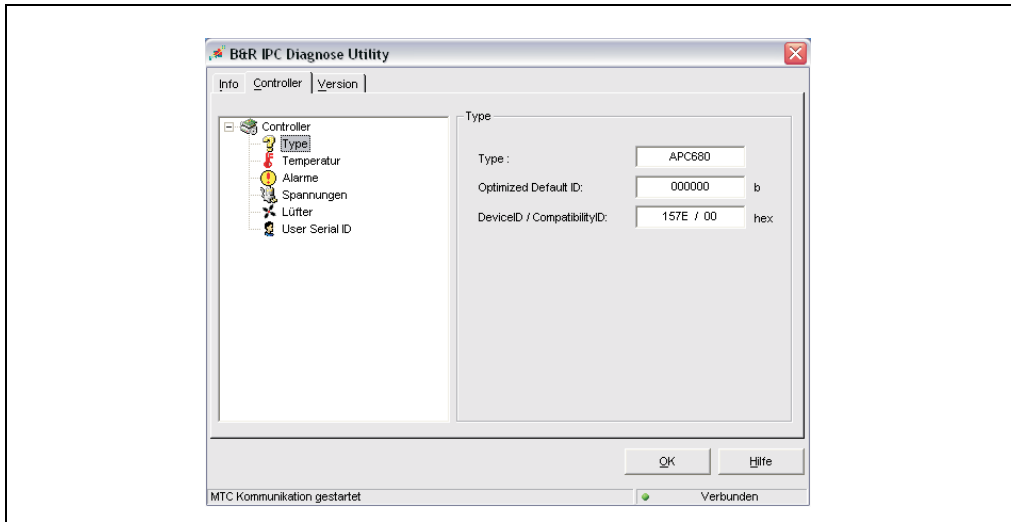

Figure 46: B&R IPC Diagnostics Utility - controller tab - info

Information about	Description
Type	APC680 for B&R slot CPU.
Optimized default ID	Displays the positions of the configuration switches.
Device ID	Displays the hexadecimal value of the hardware device ID, e.g.: 157E Hex = 5502 for APC680.
Compatibility ID	Hardware device revision (e.g. 00) .

Table 86: Information shown on the controller tab - type

5.2.2 Controller - temperature

Shows the most important temperatures for the Slot CPU.

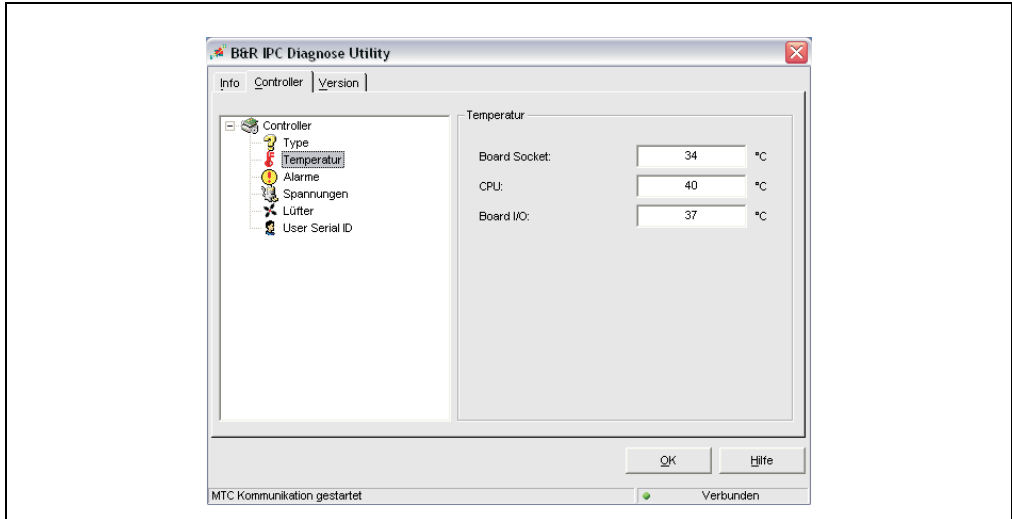

Figure 47: B&R IPC Diagnostics Utility - controller tab - temperature

The temperature sensors are located in the following positions on the Slot CPU.

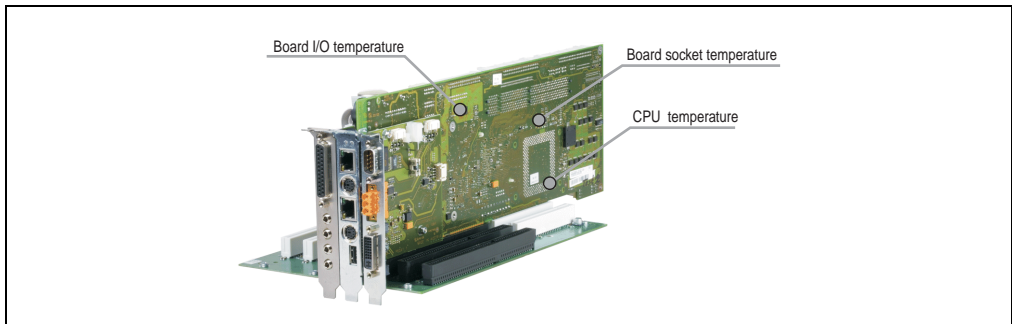

Figure 48: Slot CPU temperature sensors

Information about	Description
Board socket	Indicates the current processor board socket temperature.
CPU	Indicates the current processor temperature.
Board I/O	Indicates the current temperature of the I/O area

Table 87: Information shown on the controller tab - temperature

5.2.3 Controller - alarms

Shows the current controller alarms.

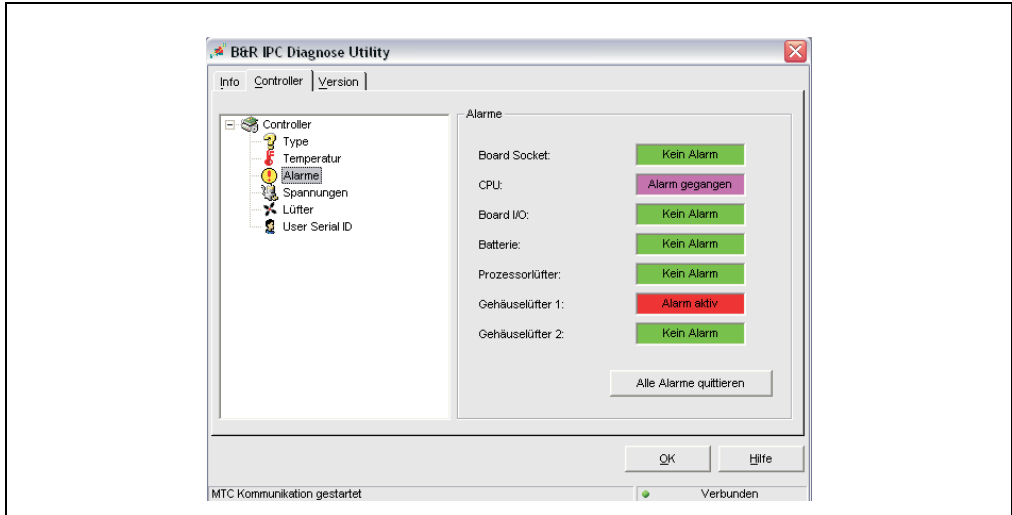

Figure 49: B&R IPC Diagnostics Utility - controller tab - alarms

Color	Text shown	Description
Green	No alarm	Green means that everything is OK.
Violet	Alarm reset.	Purple means that an alarm has occurred, but is no longer active. Past alarms are shown in purple until they are acknowledged with the button "acknowledge all alarms". Then the color changes to green.
Red	Alarm activated	Red indicates an alarm (processor temperature, board I/O temperature, board socket temperature, CPU fan, or housing fan alarm).

Table 88: Alarm color codes for the B&R IPC Diagnostics Utility

Alarm activation depends on the processor being used:

Alarm range	Processor	Measurement area		Alarm on at	Alarm LED of the Slot CPU lit
		Min. ¹⁾	Max.		
Board socket	Intel Celeron® 566 MHz processor	0 °C	127 °C	94 °C	Yes
	Intel Celeron® 733 MHz processor			84 °C	
	Intel Celeron® 850 MHz processor			84 °C	
	Intel Celeron® 1.2 GHz processor			78 °C	
	Intel Pentium® III 1.26 GHz processor			77 °C	
CPU	Intel Celeron® 566 MHz processor	0 °C	127 °C	94 °C	Yes
	Intel Celeron® 733 MHz processor			84 °C	
	Intel Celeron® 850 MHz processor			84 °C	
	Intel Celeron® 1.2 GHz processor			78 °C	
	Intel Pentium® III 1.26 GHz processor			77 °C	

Table 89: Alarm ranges - processor differences

Alarm range	Processor	Measurement area		Alarm on at	Alarm LED of the Slot CPU lit
		Min. ¹⁾	Max.		
Board I/O	processor independent	0 °C	127 °C	70 °C	Yes
Battery ²⁾	processor independent				No
Processor fans	processor independent	0 RPM	6100 RPM	approx. 70% - 71%	Yes
Housing fan 1	processor independent	0 RPM	6100 RPM	approx. 70% - 71%	Yes
Housing fan 2	processor independent	0 RPM	6100 RPM	approx. 70% - 71%	Yes

Table 89: Alarm ranges - processor differences (cont.)

1) Negative temperatures are set to 0°.

2) The CMOS battery can be evaluated (good or bad) using software.

5.2.4 Controller - voltages

The actual values of the APC's power supply for 2.5 V, 3.3 V, 5.0 V, 12.0 V, processor core and the CMOS battery are shown.

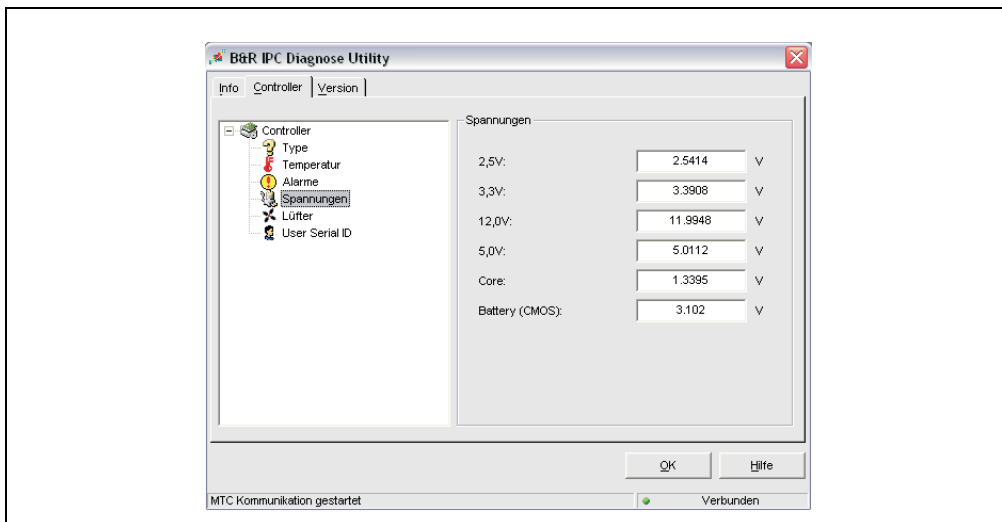

Figure 50: B&R IPC Diagnostics Utility - controller tab - voltages

5.2.5 Controller - fan

Shows the current RPM of the fans in the APC.

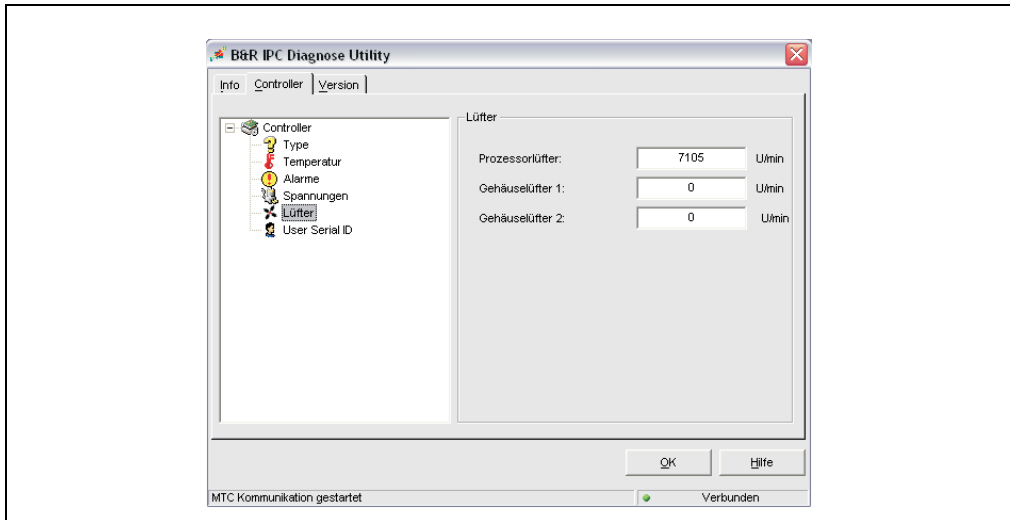

Figure 51: B&R IPC Diagnostics Utility - controller tab - fans

5.2.6 Controller - user serial ID

This tab displays the current user serial ID of the controller being used.

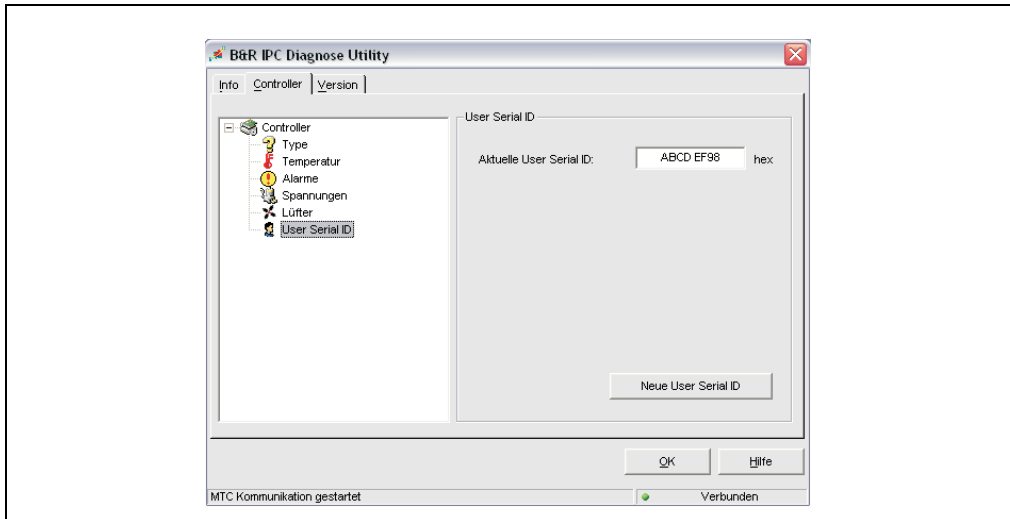

Figure 52: B&R IPC Diagnostics Utility - controller tab - user serial ID

Change user serial ID

Clicking on the "Change user serial ID" button opens a dialog box where you can enter a new ID:

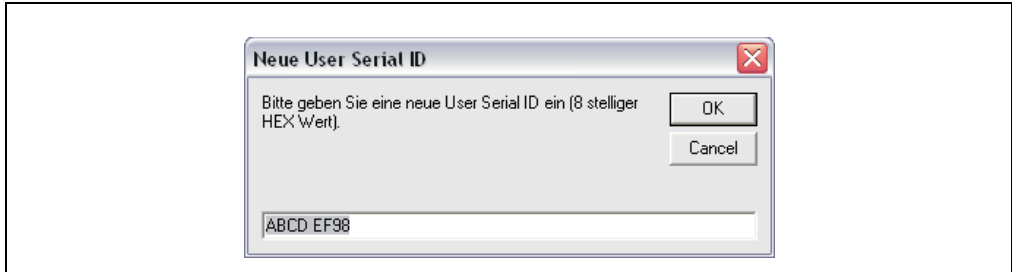

Figure 53: B&R IPC Diagnostics Utility - controller tab - enter new user serial ID

5.3 Version

This tab shows the version numbers of Mkey, MTC, and IPC software components installed on the system.

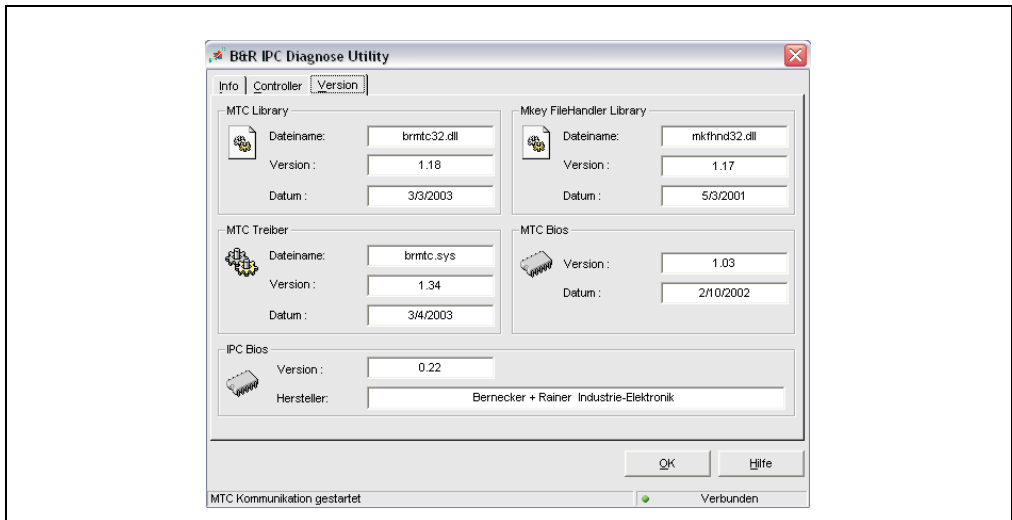

Figure 54: B&R IPC Diagnostics Utility - version tab

Chapter 5 • Accessories

1. Overview

Model number	Short description	Note
0AC201.9	Lithium batteries (5 pcs.) Lithium batteries, 5 pcs., 3 V / 950 mAh, button cell	
4A0006.00-000	Accessory - Lithium battery Lithium battery, 1 piece, 3 V / 950 mAh, button cell	
5AC680.1000-00	Filter kit Filter set for connecting to the housing fans	
5AC680.1000-01	Replacement filter - 5 pieces Replacement filter for the filter kit - 5pcs.	
5AC680.USB3-00	USB 3 port PC slot	
5AC900.1000-00	Adapter DVI-A/m to CRT DB15HD/f Adapter DVI (connector) to CRT (socket), for connecting a standard monitor to a DVI-I interface.	
5CADVI.0018-00	DVI-D cable 1.8 m/single DVI-D cable 1.8 m / single	
5CADVI.0050-00	DVI-D cable 5 m/single DVI-D cable 5 m / single	
5CADVI.0100-00	DVI-D cable 10 m/single DVI-D cable 10 m / single	
5CFADA.SL01-00	CompactFlash adapter IDE 2mm PC slot For operating a CompactFlash card on the IDE interface. To be inserted in a free slot.	
5DD680.CRFD-00	CD-ROM FDD Combo APC680 FDD/CD-ROM drive	
5DD680.DCFD-00	DVD-ROM/CD-RW FDD Combo APC680 DVD-ROM/CD-RW/FDD drive Drive combination: DVD-ROM with integrated CD-RW and FDD.	
5SA680.0232-00	Serial adapter RS232 RS232 interface, not electrically isolated up to 115 kbaud. For connection to the Slot CPU.	
5SA680.0422-01	Serial adapter RS422 RS422 interface	
5SO680.1000-00	Sound adapter AC97 LPT Inputs: Line in, microphone Outputs: Headphones, line out, parallel interface	

2. Replacement CMOS batteries

2.1 General information

The lithium battery is needed by the Slot CPU for buffering BIOS and the real-time clock. The buffer duration of the battery is at least 4 years (at 50°C, 8.5 mA current requirements of the supplied components and a self discharge of 40%).

2.2 Order data

Model number	Description	Image
0AC201.9	Lithium batteries, 5 pcs., 3 V / 950 mAh button cell	
4A0006.00-000	Lithium battery, 1 piece, 3 V / 950 mAh, button cell	

Table 90: Lithium battery order data

2.3 Technical data

Information:

The specified limits listed here, like temperature, relative humidity, shock and vibration, only apply to this accessory and do not also necessarily apply to the whole device.

Name	0AC201.9, 4A0006.00-000
Capacity	950 mAh
Voltage	3 V
Self discharge at 23°C	< 1% per year
Storage time	Max. 3 years at 30° C
Storage temperature	-20 °C to +60 °C
Humidity	0 to 95 % (non-condensing)

Table 91: Technical data - Lithium battery

3. Filter kit 5AC680.1000-00

If the APC680 is operated in a dusty environment, the interior must be protected by a filter kit. The APC680 filter kit is easily mounted over the two housing fans and fastened with the included screws.

Information:

The addition of a filter kit reduces the air flow provided by the fans. Therefore, the maximum environmental temperature for the processor should be reduced by 5°C (see technical data for individual processors).

Depending on the work environment, the filter should be checked with appropriate frequency to determine whether it allows sufficient air flow.

3.1 Order data

Model number	Description	Image
5AC680.1000-00	Filter kit Filter set for connecting to the housing fans	
	Note: The filter kit includes one dust filter and the required mounting materials.	

Table 92: Order data - filter kit

3.2 Dimensions

The addition of a filter kit causes only minimal changes to the dimensions of the APC680 housing.

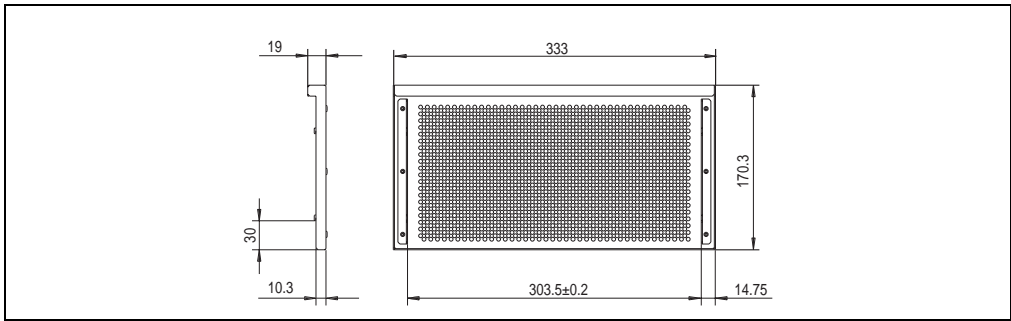

Figure 55: Dimensions - 5AC680.1000-00

4. Replacement filter 5AC680.1000-01

The APC680 replacement filter set contains 5 replacement filters for the APC680 filter kit.

4.1 Order data

Model number	Description	Image
5AC680.1000-01	Replacement filter - 5 pieces Replacement filter for the filter kit - 5pcs.	

Table 93: Order data - replacement filter

5. USB port adapter 5AC680.USB3-00

The 3 USB connections (numbers 0, 1 and 2, USB 1.1, max. 12 MBit), on the graphics adapter plate 5GA680.1000-01 (see chapter 2 "Technical data" section 6.1 "Graphics adapter 5GA680.1000-01" on page 64) can be made accessible from the outside using the USB port adapter.

The assignment of USB numbers to the outside can be configured freely due to the internal wiring to the graphics adapter.

5.1 Order data

Model number	Description	Image
5AC680.USB3-00	USB 3 port PC slot	
	<p>Note:</p> <p>The cables for connecting to the graphics adapter are contained in the delivery.</p>	

Table 94: Order data - USB port face plate

6. DVI - monitor adapter 5AC900.1000-00

This adapter enables a standard monitor to be connected to the DVI-I interface of a graphics adapter.

6.1 Order data

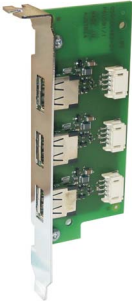
Model number	Description	Image
5AC900.1000-00	Adapter DVI-A/m to CRT DB15HD/f Adapter DVI (plug) to CRT (socket), for connecting a standard monitor to a DVI-I interface.	

Table 95: Order data - DVI/CRT adapter

7. DVI cable 5CADVI.0xxx-00

The connection between the graphics adapter and the Automation Panel's DVI link card is made with a DVI cable. The following B&R DVI cables can be used.

7.1 Order data

Model number	Description	Image
5CADVI.0018-00	DVI cable 1.8 m	
5CADVI.0050-00	DVI cable 5 m	
5CADVI.0100-00	DVI cable 10 m	

Table 96: Order data - DVI cable

8. CompactFlash slot adapter 5CFADA.SL01-00

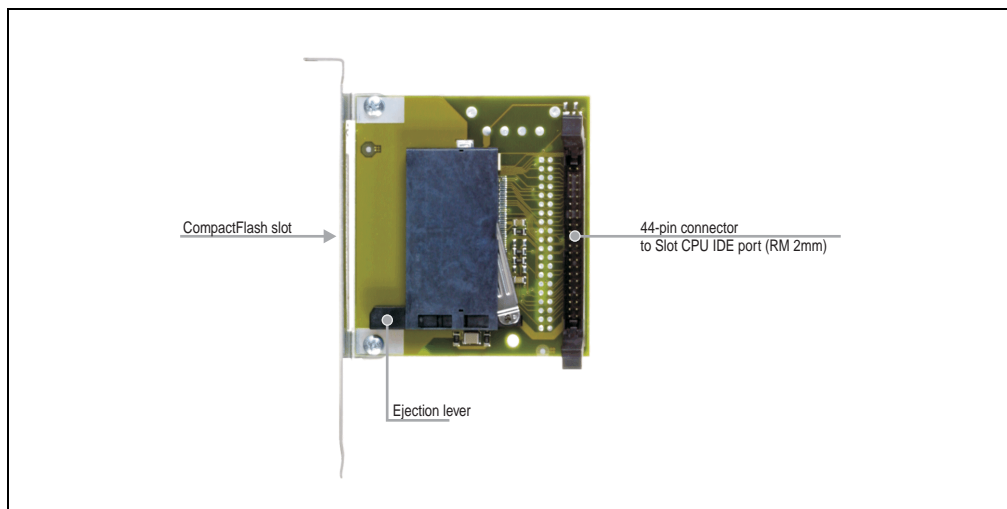

Figure 56: Components - CompactFlash adapter

The CompactFlash adapter allows for simple operation of CompactFlash cards. The adapter is connected to the Slot CPU at the 44-pin primary IDE connection using the included cable, and can then be operated as a normal HDD. Primary master/slave automatically configured via "Cable select (CSEL)" (depends on which plug is used).

8.1 Technical data

Features	5CFADA.SL01-00
Environmental temperature	
Operation	0 °C to +60 °C
Storage	-30 °C to +80 °C
Transport	-30 °C to +80 °C
Humidity	
Operation	5 - 95 % non-condensing
Storage	5 - 95 % non-condensing
Transport	5 - 95 % non-condensing
Weight	Approx. 0.1 kg

Table 97: Technical data - 5CFADA.SL01-00

8.2 Dimensions

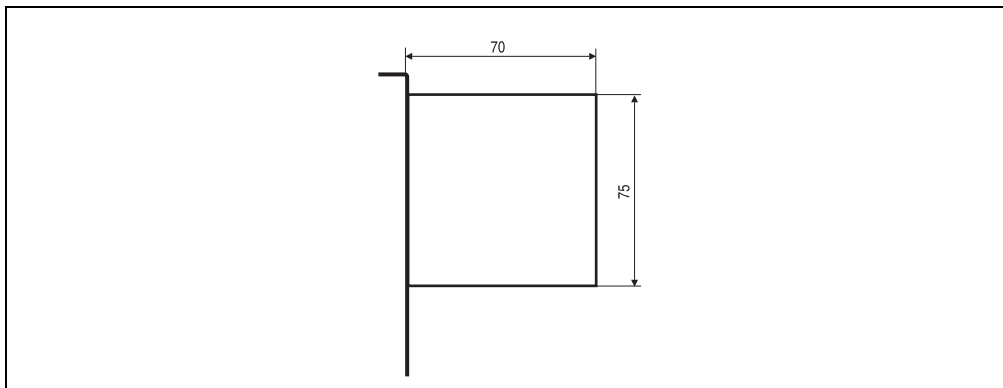

Figure 57: Dimensions - CompactFlash adapter

The CompactFlash can be exchanged relatively easily (narrow object needed to press the ejection button, as it is flush with the surface when a card is inserted). It can also be easily secured with a cover plate.

Warning!

The CompactFlash card should never be changed with the power on!

9. CD-ROM FDD combo 5DD680.CRFD-00

This drive combination consists of one 3.5" floppy and one CD-ROM drive. Upon request, this drive can be completely pre-mounted at B&R. Otherwise, the connection to the Slot CPU is made using the included cables (IDE, floppy, and power supply). The drive combination is mounted in the APC680 housing using the two mounting screws.

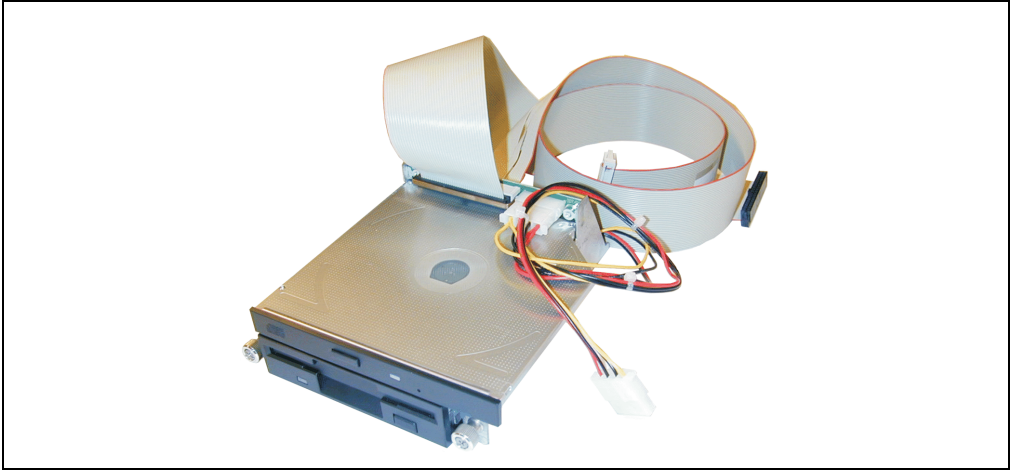

Figure 58: 5DD680.CRFD-00

9.1 Mounting instructions

Information:

The mounting instructions specified here only apply to this accessory and do not also necessarily apply to the device as a whole.

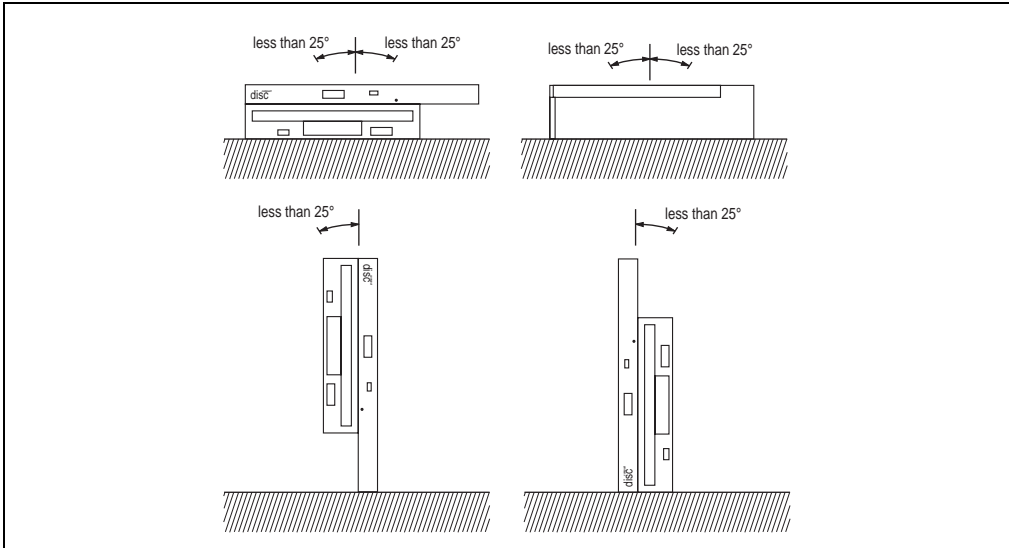

Figure 59: Mounting instructions - 5DD680.CRFD-00

9.2 Technical data

Information:

The specified limits listed here, like temperature, relative humidity, shock and vibration, only apply to this accessory and do not also necessarily apply to the whole device.

5DD680.CRFD-00	
Disk drive	3.5" drive 1.44 MB data carrier
CD-ROM	24x
Color	black
Drivers	Drivers can be found on the HMI Drivers & Utilities CD-ROM 5S0000.01-090 or can be downloaded directly from B&R's homepage (www.br-automation.com).
Environmental temperature	
Operation	5 °C to +51 °C
Storage	-20 °C to +60 °C
Transport	-20 °C to +60 °C
Humidity	
Operation	20 - 80 % non-condensing
Storage	5 - 95 % non-condensing
Transport	5 - 95 % non-condensing
Vibration	
Operation	Max. 0.3 G at 5 - 500 Hz, 1 octave/min
Storage	Max. 2 G at 5 - 500 Hz, 1 octave/min

Table 98: Technical data - 5DD680.CRFD-00

5DD680.CRFD-00	
Shock Operation Storage	Max. 5 G for 11 ms (half sine wave) Max. 60 G for 11 ms (half sine wave)

Table 98: Technical data - 5DD680.CRFD-00 (cont.)

10. DVD-ROM/CD-RW FDD combo 5DD680.DCFD-00

This drive combination consists of one 3.5" floppy and one CD-RW / DVD combination drive. Upon request, this drive can be completely pre-mounted at B&R. Otherwise, the connection to the Slot CPU is made using the included cables (IDE, floppy, and power supply). The drive combination is mounted in the APC680 housing using the two mounting screws.

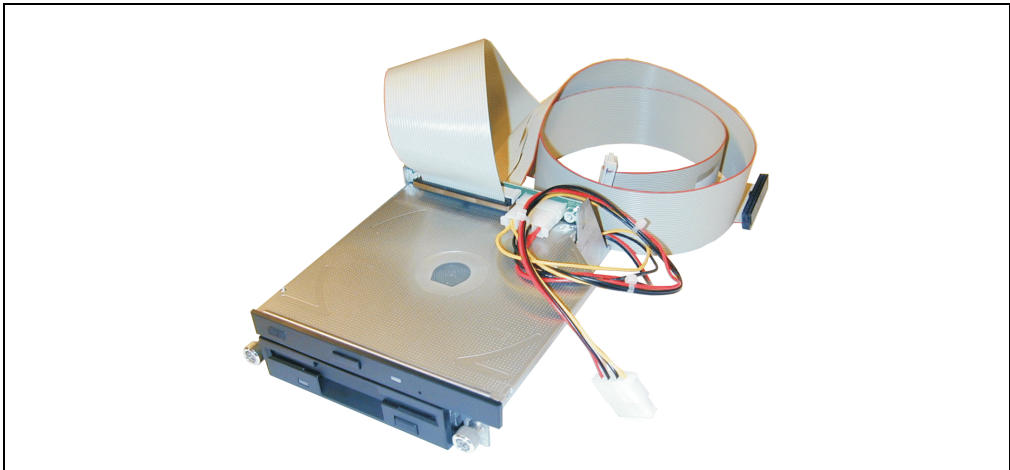

Figure 60: 5DD680.DCFD-00

10.1 Mounting instructions

Information:

The mounting instructions specified here only apply to his accessory and do not also automatically apply to the device as a whole.

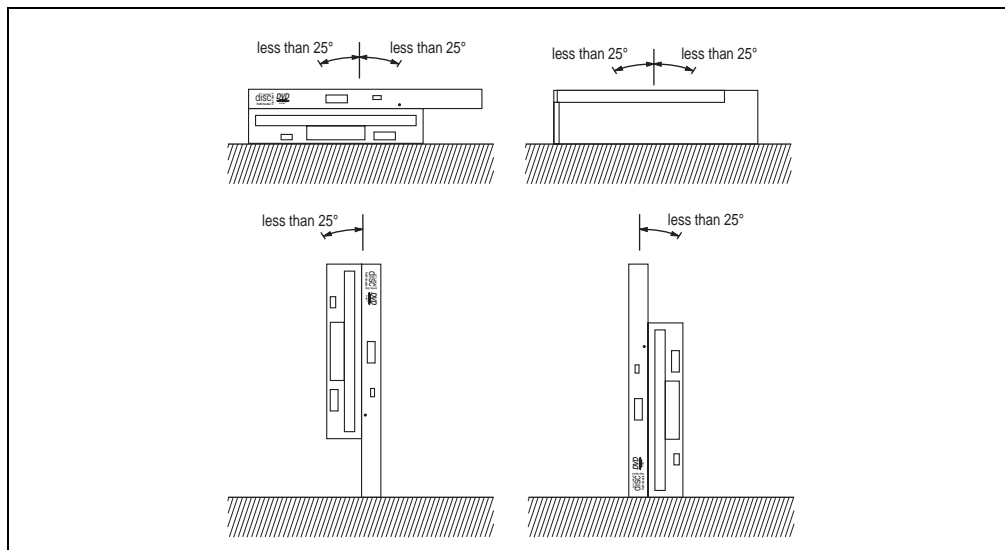

Figure 61: Mounting instructions - 5DD680.DCFD-00

10.2 Technical data

Information:

The specified limits listed here, like temperature, relative humidity, shock and vibration, only apply to this accessory and do not also necessarily apply to the whole device.

Disk drive	3.5" drive 1.44 MB data carrier
CD - RW / DVD drive	See technical data CD - RW drive (see Table 100 on page 155)
Color	black
Drivers	Drivers can be found on the HMI Drivers & Utilities CD-ROM 5S0000.01-090 or can be downloaded directly from B&R's homepage (www.br-automation.com).
Environmental temperature	
Operation	5 °C to +45 °C
Storage	-20 °C to +60 °C
Transport	-20 °C to +60 °C
Humidity	
Operation	20 - 80 % non-condensing
Storage	5 - 90 % non-condensing
Transport	5 - 90 % non-condensing

Table 99: 5DD680.DCFD-00

Vibration Operation Storage	Max. 0.2 G at 5 - 500 Hz, 1 octave/min Max. 2 G at 5 - 500 Hz, 1 octave/min
Shock Operation Storage	Max. 5 G for 11 ms (half sine wave) Max. 60 G for 11 ms (half sine wave)

Table 99: 5DD680.DCFD-00 (cont.)

Technical data - CD - RW / DVD drive	
Write speed	Recordable: 24x, 16x, 10x and 4x Rewritable: 10x and 4x
Reading rate CD-ROM DVD-ROM	24x 8x
Color	black
Readable CD/DVD formats	CD/CD-ROM, CD-R, CD-RW, DVD-ROM, DVD-R, DVD-RW, DVD-RAM
Writeable CD formats	CD-DA, CD-ROM (mode 1), CD-ROM XA mode 2 (form 1, form 2), photo CD (multisession) CD-I, video CD, CD-text, CD extra (CD plus)
Recording technique	Disc at once, session at once, track at once, packet write
CD diameter	12 cm, 8 cm
Rotation rate (24 x CAV)	max. 5.140 min ⁻¹ (rpm)
Interface	IDE / ATAPI (UDMA33)
Data transfer rate CD-ROM DVD-ROM	1.5 to 3.7 MB/s 4.4 to 10.8 MB/s
Access time CD-ROM DVD-ROM	85 ms typically 110 ms typically
Data buffer capacity	2 MB
Charge mechanism	Drawer procedure
Power consumption	Standby: 0.25 Watt Write 24x: 5.5 Watt
MTBF	60,000 POH

Table 100: Technical data - CD RW / DVD drive

11. RS232 adapter 5SA680.0232-00

The interface adapter is connected to the TTL input on the Slot CPU via a 10-pin ribbon cable, and can be mounted directly in the APC680 housing or on a slot bracket with the DSUB plugs. The 10-pin cable is delivered along with the adapter.

A maximum of 3 interface adapters can be connected to a Slot CPU.

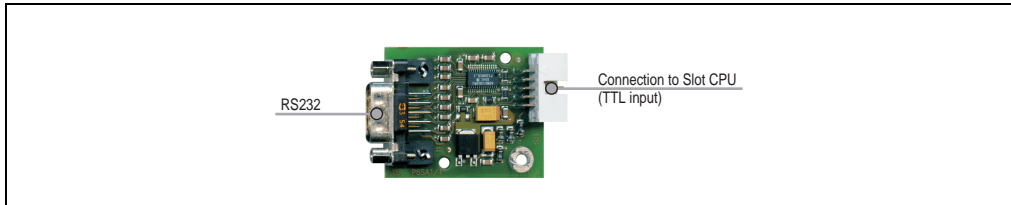

Figure 62: Components - 5SA680.0232-00

11.1 Technical data

Features	5SA680.0232-00
Environmental temperature	
Operation	0 °C to +60 °C
Storage	-30 °C to +80 °C
Transport	-30 °C to +80 °C
Humidity	
Operation	5 - 95 % non-condensing
Storage	5 - 95 % non-condensing
Transport	5 - 95 % non-condensing
Weight	Approx. 0.04 kg

Table 101: Technical data - 5SA680.0232-00

11.2 Interface description

11.2.1 RS232

Serial interfaces	
RS232 interface Not electrically isolated Up to 115 kBaud	
Pin	Assignment
1	DCD
2	RXD
3	TXD
4	DTR
5	GND
6	DSR
7	RTS
8	CTS
9	RI

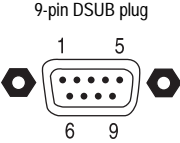

9-pin DSUB plug

The diagram shows a standard 9-pin D-sub connector. The pins are arranged in a 3x3 grid. The top-left pin is labeled '1', the top-right pin is labeled '5', the bottom-left pin is labeled '6', and the bottom-right pin is labeled '9'. The connector is shown with two screws on the sides.

Table 102: Pin assignments - RS232

11.3 Connector / plug descriptions

11.3.1 Connection - Slot CPU

Pin	Assignment	
1	DCD	
2	RXD	
3	TXD	
4	DTR	
5	GND	
6	DSR	
7	RTS	
8	CTS	
9	RI	
10	+ 12 V	

Table 103: Pin assignments - RS232 interface card

12. RS422 adapter 5SA680.0422-01

The interface adapter is connected to the TTL input on the Slot CPU via a 10-pin ribbon cable, and can be mounted directly in the APC680 housing or on a slot bracket with the DSUB plugs. The 10-pin cable is delivered along with the adapter. Two combined RS232/RS422 interfaces are available on the adapter. The operating mode (RS232/RS422) is selected automatically, depending on the electrical connection. Both interfaces are equipped with a 16 Byte FIFO memory and are Plug & Play and UART16550 compatible.

A maximum of 3 interface adapters can be connected to a Slot CPU.

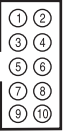
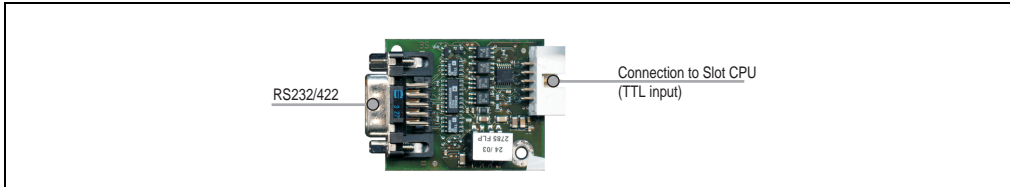

Figure 63: Components - 5SA680.0422-01

12.1 Technical data

Features	5SA680.0422-01
Environmental temperature	
Operation	0 °C to +60 °C
Storage	-30 °C to +80 °C
Transport	-30 °C to +80 °C
Humidity	
Operation	5 - 95 % non-condensing
Storage	5 - 95 % non-condensing
Transport	5 - 95 % non-condensing
Weight	Approx. 0.04 kg

Table 104: Technical data - 5SA680.0422-01

12.2 Interface description

12.2.1 RS232/RS422

Combined RS232/RS422 interface		
RS232/RS422 interface electrically isolated RS232 to 115 kBaud, RS422 to 19,200 Baud		
Pin	Assignment RS232	Assignment RS422
1		nTXD
2	RXD	
3	TXD	
4		TXD
5	GND (electrically isolated)	GND (electrically isolated)
6		nRXD
7	RTS	
8	CTS	
9		RXD

9-pin DSUB connector

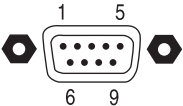

Table 105: Pin assignments - combined RS232/RS422 interface

The interface can also operate in RS422 mode. This is possible by a TriState switching, which is made using RTS.

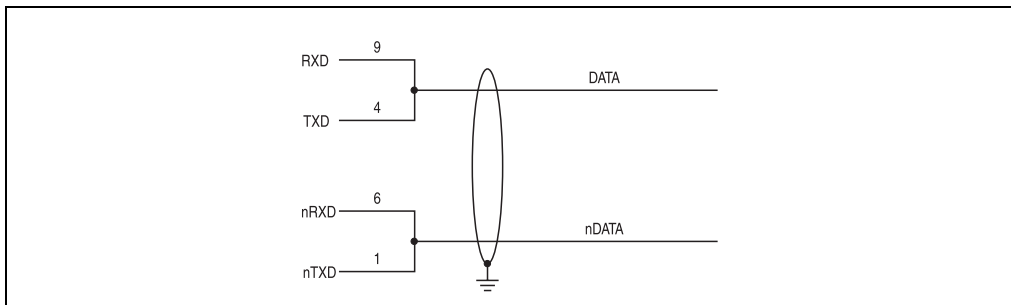

Figure 64: Operation of interface in RS422 mode

12.3 Connector / plug descriptions

12.3.1 Connection - Slot CPU

Pin	Assignment	
1	n.c.	<p style="text-align: center;">10-pin connector</p> 
2	RXD	
3	TXD	
4	n.c.	
5	GND	
6	n.c.	
7	RTS	
8	CTS	
9	n.c.	
10	+ 12 V	

Table 106: Pin assignments - RS422 interface card

13. Sound adapter 5SO680.1000-00

13.1 General information

The sound adapter makes the APC680 multimedia capable. It is mounted on and connected to the Slot CPU with the included materials (cable, screws, etc.). It is then possible to utilize the various inputs and outputs.

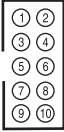
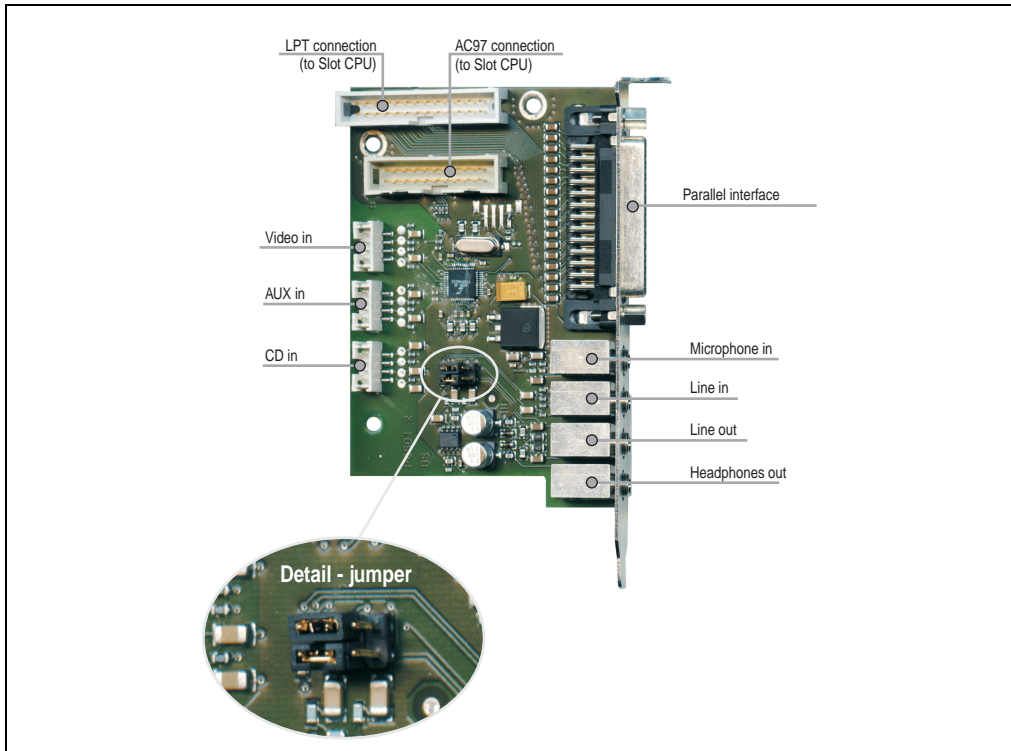

Figure 65: Components - sound adapter 5SO680.1000-00

13.2 Jumper

The sound adapter has two jumpers, which allow two different configurations depending on their position.

Configuration	Description
<p>Default</p> 	<p>This jumper setting is also the default setting when the sound adapter is delivered. The same amplified signal at the line out output is also produced at the headphone output.</p>
<p>Position 1</p> 	<p>When installing the appropriate driver an option is opened. This allows you to control the volume of the headphone output with the software volume control (radio button, slide control, etc.) An appropriate driver can be found on the HMI Drivers & Utilities CD-ROM (model number 5S0000.01-090) or downloaded directly from the support area of the B&R Homepage (www.br-automation.com).</p>

Table 107: Jumper settings - sound adapter 5SO680.1000-00

13.3 Technical data

Features	5SO680.1000-00
Environmental temperature	
Operation	0 °C to +60 °C
Storage	-30 °C to +80 °C
Transport	-30 °C to +80 °C
Humidity	
Operation	5 - 95 % non-condensing
Storage	5 - 95 % non-condensing
Transport	5 - 95 % non-condensing
Weight	Approx. 0.6 kg

Table 108: Technical data - 5SO680.1000-00

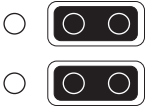
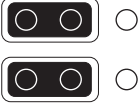
13.4 Interface description

13.4.1 Parallel interface

To be able to use the standard parallel interface, the LPT connection must be established with the Slot CPU. This can be done using the included cable.

The parallel interface LPT is a 25-pin DSUB socket. It supports EPP and ECP operating modes (Plug & Play compatible) as well as the standard SPP mode.

Parallel interface LPT1			
Pin	Assignment	Pin	Assignment
1	Data strobe	14	Auto-feed
2	Data 0	15	Error
3	Data 1	16	Printer init
4	Data 2	17	Printer select input
5	Data 3	18	GND
6	Data 4	19	GND
7	Data 5	20	GND
8	Data 6	21	GND
9	Data 7	22	GND
10	Acknowledge	23	GND
11	Busy	24	GND
12	Paper end	25	GND
13	Printer select status		

25-pin DSUB socket

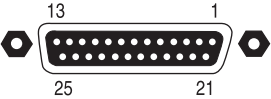

Table 109: Pin assignments - LPT

13.4.2 Microphone in

Connection of a mono microphone with a 3.5 mm plug.

13.4.3 Line in

Connection for a stereo line in signal with a 3.5 mm plug.

13.4.4 Line out

Connection of a sound reader (e.g. amplifier) with the 3.5 mm jack output.

13.4.5 Headphones out

Connection for stereo headphones. Maximum 2 x 250 mWatt output power.

13.5 Connector / plug descriptions

13.5.1 LPT connection

This plug is used to connect to the Slot CPU in order to be able to use the parallel interface on the sound adapter.

13.5.2 AC97 connection

The sound adapter must be connected to the plug on the Slot CPU.

13.5.3 Video in

Input for an audio signal (e.g. audio output from a video card).

Pin	Assignment	
1	Video in (left)	4-pin connector 
2	GND	
3	GND	
4	Video in (right)	

Table 110: Pin assignments - video in 5SO680.1000-00

13.5.4 AUX in

Input for e.g. DAT (Digital Audio Tape) drive.

Pin	Assignment	
1	AUX in (left)	4-pin connector 
2	GND	
3	GND	
4	AUX in (right)	

Table 111: Pin assignments - AUX in 5SO680.1000-00

13.5.5 CD in

Connection for the audio output of a CD-ROM drive

Pin	Assignment	
1	CD GND	4-pin connector 
2	CD in (left)	
3	CD GND	
4	CD in (right)	

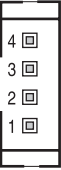
Table 112: Pin assignments - CD in 5SO680.1000-00

14. Hardware security key

The Hardware security key (dongle) protects the software. B&R recommends the DS1425 security key from Dallas Semiconductors.

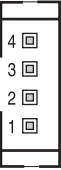
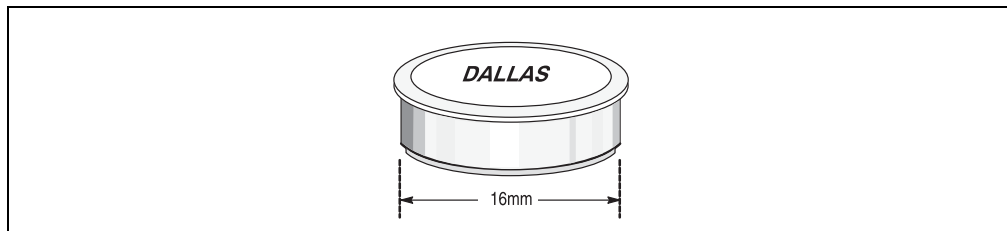

Figure 66: Dallas security key

Properties:

- Requires no external energy supply
- Universally applicable with different platforms
- Contains an intelligent reaction generator
- Has a unique 64-bit serial number and three 384-bit fields from a password protected RAM

Chapter 6 • Maintenance / servicing

The following section describes service/maintenance work which can be carried out by a trained, qualified user.

1. Changing the battery

The lithium battery guarantees buffering of the internal real-time clock (RTC) as well as individually saved BIOS settings. The buffer duration of the battery is at least 4 years (at 50°C, 8.5 mA current requirements of the supplied components and a self discharge of 40%).

When changing the battery, data is buffered for approximately another 10 hours by a gold leaf capacitor.

Information:

The battery should only be changed by qualified personnel.

1.1 Procedure for changing the battery

- Disconnect the power supply to the Automation PC.
- Touch the housing or ground connection (not the power supply!) in order to discharge any electrostatic charge from your body
- Remove the housing cover. To do this, loosen the circled quarter-turn screws. After removing the housing cover, the battery is easily accessible from above.



Figure 67: Loosen housing cover

- Remove the battery from the holder (don't use uninsulated tools >- risk of short circuiting).

The battery should not be held by its edges. Insulated tweezers may also be used for removing the battery.

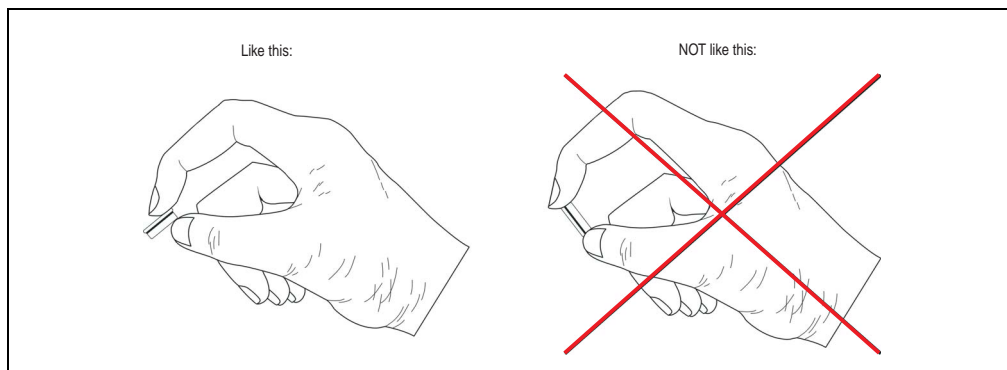

Figure 68: Handling the battery

- After removing the battery, the data is buffered for at least another 10 hours by a gold leaf capacitor so that data is not lost.
- Insert the new battery with correct polarity.
- Put on the housing cover and fasten the screws.
- Reconnect the power supply to the Automation PC.
- Date and time in BIOS might need to be set again.

Warning!

Lithium batteries are considered hazardous waste. Used batteries should be disposed of accordingly.

2. Changing the fuse

2.1 Power supply

- Disconnect the power supply to the Automation PC.
- Touch the housing or ground connection (not the power supply!) in order to discharge any electrostatic charge from your body
- Remove the housing cover. To do this, loosen the circled quarter-turn screws.



Figure 69: Loosen housing cover

- The position of the fuse can be seen in the figure for the power supply being used. Since the fuse is not easily accessible, depending on the configuration of the Automation PC it may be advantageous to remove some components while the fuse is being changed.
- Remove old fuse from the holder. A small flat head screwdriver works best.
- Insert replacement fuse into holder. For the fuse type needed see technical data for the power supply being used.
- Put on the housing cover and fasten the screws.

2.2 Graphics adapter

- Disconnect the power supply to the Automation PC.
- Touch the housing or ground connection (not the power supply!) in order to discharge any electrostatic charge from your body
- Remove the housing cover. To do this, loosen the circled quarter-turn screws.



Figure 70: Loosen housing cover

- The position of the fuse can be seen in the figure for the graphics adapter being used. Since the fuse is not easily accessible, depending on the configuration of the Automation PC it may be advantageous to remove some components while the fuse is being changed.
- Remove old fuse from the holder. A small flat head screwdriver works best.

- Insert replacement fuse into holder. For the fuse type needed see technical data for the graphics adapter being used.
- Put on the housing cover and fasten the screws.

3. Filter kit exchange / cleaning

Depending on the work environment, the filter should be checked with appropriate frequency to determine whether the air flow provides sufficient cooling. An exchange or cleaning of the filter kit is appropriate at that time.

3.1 Procedure

- Disconnect the power supply to the Automation PC.
- Touch the housing or ground connection (not the power supply!) in order to discharge any electrostatic charge from your body
- Remove filter kit cover. To do this, loosen the circled M3 Torx screws. Then the cover can be slid up and removed.

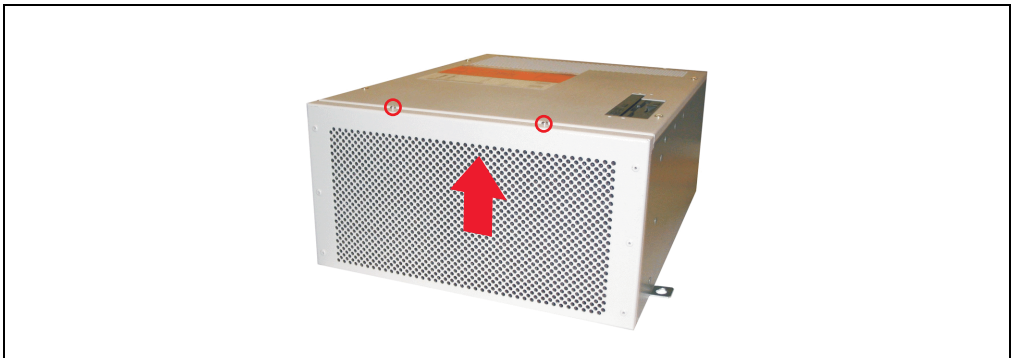

Figure 71: Remove filter kit

- Replace dirty filters.
- Insert filter kit over the fan housing. The filter kit should slide in so that the holes line up. Fasten with the two screws.

4. FAQ

The FAQ section answers the most common questions regarding the Automation PC.

4.1 How do I change the battery in the Slot CPU?

See section "Changing the battery", on page 167.

4.2 What does it mean when the Slot CPU's red alarm LED lights up or blinks?

A lit up or blinking red alarm LED indicates that an alarm (processor temperature, board I/O temperature, board socket temperature, CPU fan, or housing fan alarm) is occurring or has occurred. More detailed information can be found in chapter 2 "Technical data", section 3 "Slot CPU" on page 32.

4.3 How do I perform a BIOS upgrade?

See chapter 4 "Software", section 3 "BIOS upgrade" on page 124

4.4 Where can I find drivers for the hardware?

The latest drivers and utilities for the Automation PC are found on the HMI Drivers & Utilities CD ROM (model number 5S0000.01-090) version 1.49 and up. They can also be downloaded from the download area of the B&R homepage (www.br-automation.com).

4.5 How do I open the housing?

To remove the housing cover, loosen the circled quarter-turn screws (see figure 67 "Loosen housing cover" on page 167).

4.6 How do I exchange the air filter?

More detailed information on this topic in section 3 "Filter kit exchange / cleaning" on page 170.

4.7 How do I mount the filter kit set?

The filter kit set is delivered with the required mounting material. More detailed information on this topic in section 3 "Filter kit exchange / cleaning" on page 170.

4.8 How do I exchange the graphics adapter fuse?

More detailed information on this topic in section 2 "Changing the fuse" on page 168.

4.9 What can I plug in where?

The interfaces accessible from the outside and the internal connections can be seen in the figures and technical data for the individual components. Vary depending on configuration of the Automation PC.

4.10 What all do I need for an Automation PC?

The following components are needed for a running system:

- Housing/fan CD/FD
- Power supply
- Backplane
- Slot CPU
- Processor
- Main memory
- Mass memory
- Graphics adapter
- Software in the form of an operating system

The Automation PC can also be equipped with the following optional components:

- Up to 3 serial interfaces (RS232, RS422)
- FDD-CD or FDD-CD-RW / DVD drive
- Sound adapter
- CompactFlash adapter
- Filter kit
- USB port adapter

More detailed information can be found in the sections devoted to the individual components.

4.11 How far away can DVI displays be placed?

DVI displays can be operated at distances equal to the length of the DVI cables available from B&R. Available DVI cables and lengths - see table 96 "Order data - DVI cable" on page 148.

4.12 Which driver do I need and where can I find it?

The latest drivers and utilities for the Automation PC are found on the HMI Drivers & Utilities CD ROM (model number 5S0000.01-090) version 1.49 and up. They can also be downloaded from the download area of the B&R homepage (www.br-automation.com).

4.13 Which touch driver do I need and how do I install it?

Touch screen drivers for the Automation Panel display units are found on the HMI Drivers & Utilities CD ROM (model number 5S0000.01-090) version 1.49 and up. They can also be downloaded from the download area of the B&R homepage (www.br-automation.com).

4.14 What interface is where?

The positions of the interfaces and connections can be found in the figures and technical data for the individual components.

Figure 1:	Automation PC as central controller and visualization	25
Figure 2:	Automation PC as classic visualization device.....	26
Figure 3:	Automation PC as server	27
Figure 4:	Entire APC680 device (example configuration).....	29
Figure 5:	Components - 5HS680.1000-01.....	30
Figure 6:	Dimensions - 5HS680.1000-01	31
Figure 7:	Configuration example - Slot CPU	33
Figure 8:	Components - Slot CPU.....	34
Figure 9:	Dimensions - Slot CPU.....	35
Figure 10:	Interfaces - Slot CPU.....	35
Figure 11:	Components - 35BP680.1000-00.....	51
Figure 12:	Components - 5BP680.1000-01	56
Figure 13:	Components - 5BP680.1000-02.....	57
Figure 14:	Components - 5PS680.AC01-01.....	62
Figure 15:	Components - 5GA680.1000-01	65
Figure 16:	Dimensions - graphics adapter.....	65
Figure 17:	Components - 5HD680.0020-00	74
Figure 18:	Components - 5HD680.0030-00	76
Figure 19:	Components - 5HD680.2x20-00.....	78
Figure 20:	Components - hard disk switch	80
Figure 21:	Detailed view - hard disk switch	81
Figure 22:	Dimensions - hard disk switch.....	81
Figure 23:	Components - 5HD680.2x30-00.....	82
Figure 24:	Components - hard disk switch	84
Figure 25:	Detailed view - hard disk switch	84
Figure 26:	Dimensions - hard disk switch.....	85
Figure 27:	Mounting plates	87
Figure 28:	Mounting orientation - vertical	88
Figure 29:	Mounting orientation - horizontal.....	89
Figure 30:	Mounting orientation - lying down.....	90
Figure 31:	BIOS setup main menu	93
Figure 32:	Standard CMOS features	95
Figure 33:	IDE primary master setup.....	97
Figure 34:	IDE primary slave setup	98
Figure 35:	IDE secondary master setup	99
Figure 36:	IDE secondary slave setup.....	100
Figure 37:	Advanced BIOS features.....	101
Figure 38:	Advanced chipset features	104
Figure 39:	Integrated peripherals	107
Figure 40:	Special OEM features	111
Figure 41:	Statistics motherboard.....	113
Figure 42:	Power management setup	114
Figure 43:	PnP/PCI configuration setup	117
Figure 44:	IRQ resources setup	119
Figure 45:	DMA resources setup.....	121
Figure 46:	Frequency / voltage control setup	122
Figure 47:	Configuration switches - detailed view	125

Figure Index

Figure 48:	B&R IPC Diagnostics Utility - tab info.....	136
Figure 49:	B&R IPC Diagnostics Utility - controller tab - info.....	137
Figure 50:	B&R IPC Diagnostics Utility - controller tab - temperature.....	138
Figure 51:	Slot CPU temperature sensors.....	138
Figure 52:	B&R IPC Diagnostics Utility - controller tab - alarms.....	139
Figure 53:	B&R IPC Diagnostics Utility - controller tab - voltages.....	140
Figure 54:	B&R IPC Diagnostics Utility - controller tab - fans.....	141
Figure 55:	B&R IPC Diagnostics Utility - controller tab - user serial ID.....	141
Figure 56:	B&R IPC Diagnostics Utility - controller tab - enter new user serial ID.....	142
Figure 57:	B&R IPC Diagnostics Utility - version tab.....	142
Figure 58:	Dimensions - 5AC680.1000-00.....	146
Figure 59:	Components - CompactFlash adapter.....	149
Figure 60:	Dimensions - CompactFlash adapter.....	150
Figure 61:	5DD680.CRFD-00.....	151
Figure 62:	Mounting instructions - 5DD680.CRFD-00.....	152
Figure 63:	5DD680.DCFD-00.....	153
Figure 64:	Mounting instructions - 5DD680.DCFD-00.....	154
Figure 65:	Components - 5SA680.0232-00.....	156
Figure 66:	Components - 5SA680.0422-01.....	159
Figure 67:	Operation of interface in RS422 mode.....	160
Figure 68:	Components - sound adapter 5SO680.1000-00.....	162
Figure 69:	Dallas security key.....	166
Figure 70:	Loosen housing cover.....	167
Figure 71:	Handling the battery.....	168
Figure 72:	Loosen housing cover.....	169
Figure 73:	Loosen housing cover.....	169
Figure 74:	Remove filter kit.....	170

Table 1:	Manual history	13
Table 2:	Organization of safety notices	16
Table 3:	Model numbers - housing	18
Table 4:	Model numbers - Slot CPU	18
Table 5:	Model numbers - backplane	18
Table 6:	Model numbers - power supply	18
Table 7:	Model numbers - graphics adapter	18
Table 8:	Model numbers - processors	19
Table 9:	Model numbers - main memory	19
Table 10:	Model numbers - mass memory	19
Table 11:	Model numbers - accessories	20
Table 12:	Model numbers - documentation	21
Table 13:	Model numbers - software	21
Table 14:	Configuration example	23
Table 15:	Maximum current/power consumption - power supplies	24
Table 16:	Configuration example	24
Table 17:	Technical data - 5HS680.1000-01	31
Table 18:	Technical data - 5SC680.815E-00	32
Table 19:	B&R IPC Diagnostics Utility - alarm acknowledgement	36
Table 20:	Ethernet controller	37
Table 21:	Status LEDs - Ethernet controller	37
Table 22:	Pin assignments - (PS/2) AT keyboard	37
Table 23:	Ethernet controller	38
Table 24:	Status LEDs - Ethernet controller	38
Table 25:	Pin assignments - mouse interface (PS/2)	39
Table 26:	Pin assignments - secondary IDE (40-pin, RM 2.54 mm)	40
Table 27:	Pin assignments - primary IDE (40-pin, RM 2.54 mm)	41
Table 28:	Pin assignments - primary IDE (44-pin, RM 2mm)	42
Table 29:	Pin assignments - floppy interface	43
Table 30:	Pin assignments - front panel	44
Table 31:	Pin assignments - COM1	45
Table 32:	Pin assignments - COM3	45
Table 33:	Pin assignments - COM4	46
Table 34:	Pin assignments - LPT	46
Table 35:	Pin assignments - APC sound adapter	47
Table 36:	Pin assignments - infrared connection	48
Table 37:	Pin assignments - ATX power	49
Table 38:	Technical data - 5BP680.1000-00	52
Table 39:	Pin assignments - front panel	53
Table 40:	Pin assignments - ATX power backplane	54
Table 41:	Pin assignments - PC power (4-pin)	54
Table 42:	Technical data - 5BP680.1000-01	56
Table 43:	Pin assignments - PC power (4-pin)	57
Table 44:	Technical data - 5BP680.1000-02	57
Table 45:	Pin assignments - front panel	59
Table 46:	Pin assignments - ATX power backplane	60
Table 47:	Pin assignments - PC power (4-pin)	60

Table index

Table 48:	Technical data - 5PS680.AC01-01	62
Table 49:	Technical data - 5GA680.1000-01	64
Table 50:	Pin assignments - touch / supply interfaces	66
Table 51:	Pin assignments - +24VDC output	66
Table 52:	Pin assignments - DVI-I (single DVI with analog monitor) 5GA680.1000-01	67
Table 53:	Technical data - processors	68
Table 54:	Heat sink types	69
Table 55:	Order data - RAM	70
Table 56:	Technical data - processors	70
Table 57:	Order data - CompactFlash cards	72
Table 58:	Technical data - CompactFlash cards 5CFCRD.0xxx-01	72
Table 59:	Order data - CompactFlash cards	73
Table 60:	Technical data - CompactFlash cards 5CFCRD.xxxx-02	74
Table 61:	Technical data - 20 GB hard disk	75
Table 62:	Technical data - 30 GB hard disk	77
Table 63:	Technical data - 20 GB hard disk	79
Table 64:	Technical data - 20 GB hard disk	82
Table 65:	Keys relevant to BIOS	92
Table 66:	Overview of BIOS main menu functions	93
Table 67:	Standard CMOS features - description of setting options	95
Table 68:	IDE primary master setup - description of setting options	97
Table 69:	IDE primary slave setup - description of setting options	98
Table 70:	IDE secondary master setup - description of setting options	99
Table 71:	IDE secondary slave setup - description of setting options	100
Table 72:	Advanced BIOS features - description of setting options	101
Table 73:	Advanced chipset features - description of setting options	104
Table 74:	Integrated peripherals - description of setting options	107
Table 75:	Special OEM features - description of setting options	111
Table 76:	Statistics motherboard - description of setting options	113
Table 77:	Power management setup - description of setting options	114
Table 78:	PnP/PCI configuration setup - description of setting options	117
Table 79:	IRQ resources setup - description of setting options	119
Table 80:	DMA resources setup - description of setting options	121
Table 81:	Frequency / voltage control setup - description of setting options	122
Table 82:	Configuration switch positioning - profile 0	125
Table 83:	Standard CMOS features - load optimized defaults, profile 0	125
Table 84:	Advanced BIOS features - load optimized defaults, profile 0	126
Table 85:	Advanced chipset features - load optimized defaults, profile 0	126
Table 86:	Integrated peripherals - load optimized defaults, profile 0	127
Table 87:	Special OEM features - load optimized defaults, profile 0	128
Table 88:	Statistics motherboard - load optimized defaults, profile 0	128
Table 89:	Power management setup - load optimized defaults, profile 0	128
Table 90:	PnP/PCI configurations - load optimized defaults, profile 0	130
Table 91:	Frequency / voltage control - load optimized defaults, profile 0	130
Table 92:	Configuration switch positioning - profile 1	131
Table 93:	Standard CMOS features - load optimized defaults, profile 1	131
Table 94:	Advanced BIOS features - load optimized defaults, profile 1	131

Table 95:	Advanced chipset features - load optimized defaults, profile 1	132
Table 96:	Integrated peripherals - load optimized defaults, profile 1	132
Table 97:	Special OEM features - load optimized defaults, profile 1	133
Table 98:	Statistics motherboard - load optimized defaults, profile 1	134
Table 99:	Power management setup - load optimized defaults, profile 1	134
Table 100:	PnP/PCI configurations - load optimized defaults, profile 1	135
Table 101:	Frequency / voltage control - load optimized defaults, profile 1	135
Table 102:	Information shown on the controller tab - type	137
Table 103:	Information shown on the controller tab - temperature	138
Table 104:	Alarm color codes for the B&R IPC Diagnostics Utility.....	139
Table 105:	Alarm ranges - processor differences	139
Table 106:	Lithium battery order data	144
Table 107:	Technical data - Lithium battery	144
Table 108:	Order data - filter kit	145
Table 109:	Order data - replacement filter	146
Table 110:	Order data - USB port face plate.....	147
Table 111:	Order data - DVI/CRT adapter	147
Table 112:	Order data - DVI cable	148
Table 113:	Technical data - 5CFADA.SL01-00.....	149
Table 114:	Technical data - 5DD680.CRFD-00	152
Table 115:	5DD680.DCFD-00.....	154
Table 116:	Technical data - CD RW / DVD drive	155
Table 117:	Technical data - 5SA680.0232-00.....	156
Table 118:	Pin assignments - RS232.....	157
Table 119:	Pin assignments - RS232 interface card.....	158
Table 120:	Technical data - 5SA680.0422-01.....	159
Table 121:	Pin assignments - combined RS232/RS422 interface	160
Table 122:	Pin assignments - RS422 interface card.....	161
Table 123:	Jumper settings - sound adapter 5SO680.1000-00	163
Table 124:	Technical data - 5SO680.1000-00	163
Table 125:	Pin assignments - LPT	164
Table 126:	Pin assignments - video in 5SO680.1000-00.....	165
Table 127:	Pin assignments - AUX in 5SO680.1000-00	165
Table 128:	Pin assignments - CD in 5SO680.1000-00	165

Numerics

3.3 V power supply59

A

Accessories 143

Advanced BIOS features 101

ATX power 49, 54, 60

ATX signals 44, 52, 58

AUX in 165

B

Backplane 51

Beeper 49

BIOS 48

Advanced BIOS features 101

Advanced chipset features 104

DMA resources 121

Exit without saving 123

Frequency / voltage control 122

IDE primary master 97

IDE primary slave 98

IDE secondary master 99

IDE secondary slave 100

Integrated peripherals 107

IRQ resource 119

Load fail safe defaults 122

Load optimized defaults 122

PnP/PCI configuration 117

Power management setup 114

Profile 0 125

Profile 1 131

Save & exit setup 123

Set supervisor password 122

Set user password 123

setup 91

Setup - main menu 93

Setup keys 92

Special OEM features 111

Standard CMOS features 95

Statistics motherboard 113

BIOS settings 93

Bus board 51

C

CD in 165

CD-ROM drive 151

CD-RW / DVD 153

CMOS battery holder 47

COM1 45

COM3 45

COM4 46

CompactFlash adapter 149

CompactFlash cards 71, 73

Technical data 72, 73

Configuration switch 48

Contents of delivery 17

Cooling systems 69

CPU fan 49

D

Dimension standards 17

DMA resources 121

Dongle 47, 166

DVI - CRT adapter 147

DVI cable 147

E

Environmental temperatures 23

Ethernet 37, 38

Exit without saving 123

F

Filter kit 145

Floppy interface 43

Frequency / voltage control 122

Front panel 44, 52, 58

G

Graphics adapter 64

Graphics adapter connection 48

H

Hard disk 75, 76

Index

Technical data	75, 77, 79, 82
Hard disk switch adapter	80, 83
Hardware security key	47, 166
Headphones out	164
Housing	30
Power supply	62
Housing fan	50, 54, 60

I

IDE primary master	97
IDE primary slave	98
IDE secondary master	99
IDE secondary slave	100
Infrared	48
Integrated peripherals	107
IRQ resources	119
ISA slot	53, 59
ITP plug	40

L

Line in	164
Line out	164
Lithium battery	144
Load fail safe defaults	122
Load optimized defaults	122
LPT	46

M

Main memory	70
Manual history	13
Mass memory	70
Microphone in	164
Model numbers	18
Accessories	20
Backplane / bus board	18
Documentation	21
Graphics adapter	18
Housing	18
Main memory	19
Mass memory	19
Power supply	18
Processors	19
Slot CPU	18

Software	21
Mounting instructions	87
Mounting options	88
Vertical	88

P

Parallel interface	163
PC power (optional)	54, 60
PCI slot	53, 59
Performance data	24
PICMG slot	52, 58
PnP/PCI configuration	117
Power management setup	114
Power ON button	54, 61
Primary IDE	41, 42
Processors	68
Profile 0	125
Advanced BIOS features	126
Advanced chipset features	126
Frequency / voltage control	130
Integrated peripherals	127
PnP/PCI configuration	130
Power management setup	128
Special OEM feature	128
Standard CMOS features	125
Statistics motherboard	128
Profile 1	131
Advanced BIOS features	131
Advanced chipset features	132
Frequency / voltage control	135
Integrated peripherals	132
PnP/PCI configuration	135
Power management setup	134
Special OEM features	133
Standard CMOS features	131
Statistics motherboard	134
PS/2 keyboard	37
PS/2 mouse	39
PS2 power supply connection	53, 60

R

RAM	40
Replacement filter set	146
Reset button	55, 61

RS232	157	Sound adapter	47, 162
RS232/RS422	160	Special OEM features	111
S			
Safety notices	15	Standard CMOS features	95
Intended use	15	Statistics motherboard	113
Mounting	16	Status LED	35
Operation	16	Status LEDs	53, 59
Organization	16	T	
Policy and procedures	15	Temperature sensors	138
Transport and storage	15	U	
Save & exit setup	123	Universal socket 370	49
Secondary IDE	40	USB3	39
Set supervisor password	122	V	
Set user password	123	Video in	165
Slot CPU	32		
Interface description	35		
SMC	48		
Software	91		
General information	91		

0

0AC201.9..... 20, 143, 144

4

4A0006.00-000 20, 143, 144

5

5AC680.1000-00..... 20, 143, 145
 5AC680.1000-01..... 20, 143, 146
 5AC680.USB3-00 21, 143, 147
 5AC900.1000-00..... 21, 143, 147
 5BP680.1000-00..... 18, 51
 5BP680.1000-01..... 18, 56
 5BP680.1000-02..... 18, 57
 5CADVI.0018-00..... 21, 143, 148
 5CADVI.0050-00..... 21, 143, 148
 5CADVI.0100-00..... 21, 143, 148
 5CFADA.SL01-00 21, 143
 5CFCRD.0032-01 19, 70, 72
 5CFCRD.0032-02 19, 71, 73
 5CFCRD.0064-01 19, 71, 72
 5CFCRD.0064-02 19, 71, 73
 5CFCRD.0128-01 20, 71, 72
 5CFCRD.0128-02 20, 71, 73
 5CFCRD.0192-01 20, 71, 72
 5CFCRD.0256-01 20, 71, 72
 5CFCRD.0256-02 20, 71, 73
 5CFCRD.0384-01 20, 71, 72
 5CFCRD.0512-01 20, 71, 72
 5CFCRD.0512-02 20, 71, 73
 5CFCRD.1024-02 20, 71, 73
 5CFCRD.2048-02 20, 71, 73

5CPICP.0566-00 19, 68
 5CPICP.0733-00 19, 68
 5CPICP.0850-00 19, 68
 5CPICP.1200-00 19, 68
 5CPIP3.1260-00 19, 68
 5DD680.CRFD-00 21, 143, 152
 5DD680.DCFD-00 21, 143, 153
 5GA680.1000-01 18, 64
 5HD680.0020-00 20, 71, 74
 5HD680.0030-00 20, 71, 76
 5HD680.2x20-00 20, 71, 78
 5HD680.2x30-00 20, 71, 82
 5HS680.1000-01 18, 30
 5MA680.00DE-00 21
 5MMSDR.0128-00..... 19, 70
 5MMSDR.0256-00..... 19, 70
 5PS680.AC01-01..... 18, 62
 5S0000.01-090..... 21
 5SA680.0232-00..... 21, 143, 156
 5SA680.0422-01..... 21, 143, 159
 5SC680.815E-00 18, 32
 5SO680.1000-00 21, 143, 162
 5SWUTI.0000-00..... 21

9

9A0004.11 19, 70
 9A0004.12 19, 70
 9A0004.14 19, 70
 9S0000.06-010 21
 9S0000.06-020 21
 9S0000.08-010 22
 9S0000.08-020 22
 9S0001.11-090 22
 9S0001.15-020 22

