



System manual

Servo Drives AX5000

Version: 2.5
Date: 2018-12-06

BECKHOFF

Table of contents

1 Foreword	9
1.1 Notes on the documentation.....	9
1.2 Documentation issue status	10
1.2.1 Scope of the documentation	10
1.3 Appropriate use	12
1.3.1 Dual Use (EU 1382/2014).....	13
2 Guidelines and Standards	14
2.1 EC declaration of conformity	14
2.2 UL approval for devices up to 40 A for the US and Canada.....	15
2.2.1 UL-specific chapter changes	15
2.2.2 UL-specific chapter	16
2.2.3 UL-specific notes	17
2.3 UL approval for devices above 60A for the US and Canada.....	17
2.3.1 UL-specific chapter changes	17
2.3.2 UL-specific chapter	18
2.3.3 UL-specific notes	18
2.4 Electrical isolation according to EN 50178 / VDE 0160.....	18
3 Safety	19
3.1 Safety instructions	19
3.2 Special safety notes for servo drives	20
4 Handling	22
4.1 Transport and storage	22
4.2 Maintenance	22
4.3 Cleaning	23
4.4 Disposal.....	23
5 Product overview	24
5.1 Scope of supply	24
5.2 Name plate	24
5.3 Type key	26
5.4 Image showing AX5101 - AX5112 and AX520x.....	27
5.5 Image showing AX5118, AX5125 and AX5140	28
5.6 Image showing AX5160 - AX5172.....	29
5.7 Image showing AX5190 - AX5191.....	30
5.8 Image showing AX5192 - AX5193.....	31
6 Technical description	32
6.1 Configuration of the servo drives.....	32
6.2 General technical data.....	33
6.2.1 Permissible ambient and operating conditions	33
6.2.2 Electrical data - servo drive (AX5101 - AX5140)	34
6.2.3 Electrical data - servo drive (AX52xx).....	35
6.2.4 Electrical data - servo drive (AX5160 - AX5193)	36
6.2.5 Mechanical data - servo drive (AX5101-AX5140).....	38
6.2.6 Mechanical data - servo drive (AX52xx).....	38

6.2.7	Mechanical data - servo drive (AX5160 - AX5193).....	38
6.3	Dimensions.....	39
6.3.1	AX5000 as single device (1.5 A - 40 A).....	39
6.3.2	AX5000 as single device (60 A - 170 A).....	40
6.4	Properties.....	41
6.5	Wide voltage range.....	41
6.6	Variable motor interface.....	42
6.7	Multi-feedback interface.....	42
7	Mechanical installation.....	43
7.1	Installation examples (1.5 A - 40 A devices).....	43
7.2	Installation examples (60 A - 170 A devices).....	45
8	Electrical installation.....	48
8.1	Connection of several servo drives to form a drive system.....	49
8.1.1	Connection example - module AX5901 and AX5911 (AX Bridge).....	50
8.1.2	Connection example - wiring in series without AX bridge.....	51
8.1.3	Connection example – DC link group (60 A to 170 A devices).....	52
8.1.4	UL drive system - configuration example.....	56
8.2	Connection example AX5101 - AX5112 and AX520x.....	57
8.3	Connection example AX5118 - AX5125 and AX5140.....	58
8.4	Connection example AX5160 - AX5172.....	59
8.5	Connection example AX5190 - AX5191.....	60
8.6	Connection example AX5192 - AX5193.....	61
8.7	Power supply (1.5 A - 40 A devices).....	62
8.7.1	X01: Main supply connection.....	62
8.7.2	Fuse protection.....	65
8.7.3	X02: DC Link (AX5101 - AX5125 und AX520x).....	67
8.7.4	X02: DC Link (only AX5140).....	67
8.7.5	X03: 24 VDC supply.....	68
8.7.6	Safe system stop in the event of power failure.....	68
8.8	Power supply (60 A - 170 A devices).....	69
8.8.1	X01 - Voltage input.....	69
8.8.2	Fusing.....	70
8.8.3	X02: DC link.....	71
8.8.4	X03: 24 VDC supply.....	72
8.8.5	Safe system stop in the event of power failure.....	72
8.9	Leakage currents.....	73
8.10	EtherCAT.....	76
8.10.1	X04, X05: EtherCAT connection.....	76
8.11	Digital I/Os.....	77
8.11.1	X06: Digital I/Os.....	77
8.11.2	Technical data.....	78
8.11.3	Ordering information for I/O plug connectors.....	78
8.11.4	Connection of digital sensors/actuators.....	79
8.12	Feedback.....	80
8.12.1	Rotational encoders.....	81

8.12.2	Linear encoders	83
8.12.3	X11 and X21: Feedback, high-resolution.....	84
8.12.4	Resolver.....	84
8.12.5	X12 and X22: Feedback, resolver / Hall	85
8.12.6	X14 and X24: Feedback, OCT (1.5 A - 40 A devices).....	85
8.13	Motors.....	86
8.13.1	Concept	86
8.13.2	Motor data set.....	86
8.13.3	TwinCAT Drive Manager	87
8.13.4	Motor types.....	88
8.13.5	Motor connections (1.5 A - 40 A devices).....	102
8.13.6	Motor connections (60 A - 170 A devices).....	104
8.14	External brake resistor.....	105
8.14.1	X02 - AX5101-AX5125 and AX520x.....	105
8.14.2	X07 - AX5140	105
8.14.3	AX5160 and AX5172	106
8.14.4	AX5190 and AX5191	106
8.14.5	AX5192 and AX5193	106
8.15	Motors and cables for servo drives AX5101 - AX5140.....	107
8.16	Motors and cables for servo drives AX5160 - AX5193.....	107
9	Advanced system characteristics.....	109
9.1	Commissioning	109
9.1.1	Important information for commissioning.....	109
9.1.2	Software requirements	109
9.1.3	Rotary motors	112
9.1.4	Linear motors.....	151
9.1.5	Third-party motors	170
9.1.6	Homing	174
9.1.7	Error messages during commissioning.....	182
9.2	EtherCAT.....	188
9.2.1	Parameter handling	188
9.2.2	EtherCAT synchronization	189
9.3	Operation modes	195
9.3.1	Mode parameterisation according to SoE.....	195
9.4	Display and navigation rocker	197
9.4.1	Navigation rocker.....	197
9.4.2	Display	197
9.5	Motor brake management	203
9.5.1	IDNs involved.....	203
9.5.2	Functioning	203
9.6	Commutation methods	203
9.6.1	Rotary servomotors	203
9.6.2	Linear motors.....	212
9.6.3	Commutation error "F2A0".....	213
9.6.4	Commutation error during regular operation (very rare).....	214
9.7	OCT	214

9.7.1	Precondition for operation.....	214
9.8	Decommissioning	216
9.9	Integrated safety	217
9.9.1	Safety-Card AX5801	217
9.9.2	Intended use	217
9.9.3	Scope of supply	217
9.9.4	Safety regulations	217
9.9.5	Personnel qualification.....	218
9.9.6	Product description	218
9.9.7	Technical data	218
9.9.8	Installation of the AX5801 Safety Card.....	219
9.9.9	Application example (emergency stop – stop category 1).....	220
9.9.10	Application example with several AX5000.....	222
10	Project planning.....	223
10.1	Important information for project planning	223
10.2	Drive train design.....	223
10.3	Energy management	223
10.4	EMC, earthing, shield connection and potential	223
10.5	Control cabinet	223
11	Accessories	224
11.1	AX-Bridge - quick connection system	225
11.1.1	Supply module for multi-axis system	225
11.1.2	AX-Bridge connection module (AX5x01 - AX5112)	225
11.1.3	AX-Bridge connection module (AX5118 and AX5125)	225
11.2	Brake module - AX5021-0000	226
11.2.1	Electrical data	226
11.2.2	Mechanical data.....	227
11.2.3	General overview	227
11.2.4	Pin strip assignment of X51 and X52.....	228
11.2.5	Electrical connection (example).....	228
11.2.6	Integration into TwinCAT	229
11.2.7	DC link (only for 60A-170A devices).....	230
11.2.8	Operation modes of the AX5021	230
11.2.9	Braking power diagnosis.....	230
11.3	Optional encoder card - AX5701 / AX5702	231
11.3.1	Intended use	231
11.3.2	Safety regulations	231
11.3.3	Product identification	232
11.3.4	Installation of the optional encoder card	234
11.3.5	Sample: Renishaw RGH 22Z30D00	234
11.4	Optional encoder card - AX5721 / AX5722	235
11.4.1	Intended use	235
11.4.2	Safety regulations	235
11.4.3	Product identification	237
11.4.4	Installation of the optional encoder card	238

11.4.5	Error messages	238
11.5	External Brake Resistor AX2090-BW5x	239
11.5.1	Appropriate use	239
11.5.2	Safety rules	240
11.5.3	Product identification	241
11.5.4	Mechanical installation	242
11.5.5	Electrical installation	242
11.5.6	Technical data	247
11.6	Cables	248
11.6.1	General specification	248
11.6.2	Order key for motor and feedback cables	249
11.6.3	SEW motors from the “DFS / CFM” range with stopping brake	249
11.6.4	Special motor connections	250
11.7	Motor chokes AX2090-MD50	251
11.7.1	Electrical connection	251
11.7.2	Technical data	251
11.7.3	Installation of the motor choke AX2090-MD50-0012	253
11.7.4	Dimensions	255
11.8	Mains choke AX2090-ND50	257
11.8.1	Technical data	257
11.8.2	Installing the mains chokes	257
11.9	Mains filter - AX2090-NF50	259
11.9.1	Technical data	259
11.9.2	Installing the mains filter	259
11.10	Transient voltage suppressor - AX2090-TS50	263
11.10.1	Guidelines and Standards	263
11.10.2	Technical data	264
11.10.3	Installation of the transient box	265
12	Appendix	267
12.1	Error management	267
12.1.1	General	267
12.1.2	Requirement	267
12.1.3	Parameterization	267
12.1.4	SyncUnit diagnostics	268
12.1.5	Reinitialization, troubleshooting and reset	269
12.2	Firmware Update	269
12.2.1	Firmware version on the AX5000	269
12.2.2	Update to a new firmware version	270
13	Support and Service	272

1 Foreword

1.1 Notes on the documentation

This description is only intended for the use of trained specialists in control and automation engineering who are familiar with the applicable national standards.

It is essential that the documentation and the following notes and explanations are followed when installing and commissioning the components.

It is the duty of the technical personnel to use the documentation published at the respective time of each installation and commissioning.

The responsible staff must ensure that the application or use of the products described satisfy all the requirements for safety, including all the relevant laws, regulations, guidelines and standards.

Disclaimer

The documentation has been prepared with care. The products described are, however, constantly under development.

We reserve the right to revise and change the documentation at any time and without prior announcement. No claims for the modification of products that have already been supplied may be made on the basis of the data, diagrams and descriptions in this documentation.

Trademarks

Beckhoff®, TwinCAT®, EtherCAT®, EtherCAT P®, Safety over EtherCAT®, TwinSAFE®, XFC® and XTS® are registered trademarks of and licensed by Beckhoff Automation GmbH.

Other designations used in this publication may be trademarks whose use by third parties for their own purposes could violate the rights of the owners.

Patent Pending

The EtherCAT Technology is covered, including but not limited to the following patent applications and patents:

EP1590927, EP1789857, DE102004044764, DE102007017835

with corresponding applications or registrations in various other countries.

The TwinCAT Technology is covered, including but not limited to the following patent applications and patents:

EP0851348, US6167425 with corresponding applications or registrations in various other countries.

EtherCAT 

EtherCAT® is registered trademark and patented technology, licensed by Beckhoff Automation GmbH, Germany

Copyright

© Beckhoff Automation GmbH & Co. KG, Germany.

The reproduction, distribution and utilization of this document as well as the communication of its contents to others without express authorization are prohibited.

Offenders will be held liable for the payment of damages. All rights reserved in the event of the grant of a patent, utility model or design.

1.2 Documentation issue status

Origin of the document

This documentation was originally written in German. All other languages are derived from the German original.

Product features

Only the product features specified in the current user documentation are valid. Further information given on the product pages of the Beckhoff homepage, in emails or in other publications is not authoritative.

This documentation specifically refers to AX5000 hardware version 2

Version	Comment
2.5	<p>Chapter update: UL approval for devices up to 40 A for US and Canada 3.2; UL approval for devices above 60 A for US and Canada 3.3; Feedback system 9.12.3 and 9.12.5; Electrical data 7.2.1 – 7.2.3; Determining the mechanical commutation offset 10.1.5.1.4; Technical data mains choke 12.9.1</p> <p>New chapter: Motors and cables for servo drives AX5101 – AX5140 9.15; Motors and cables for servo drives AX5160 – AX5193 9.16</p>
2.4	<p>Chapter update: Disposal 5.2</p> <p>New chapter: EU Declaration of Conformity 3.1</p> <p>Delete chapter: EU Conformity 3.1 (see: „New Chapter“); Electromagnetic compatibility 3.2; Asynchronous motors – Special functions 10.8</p>
2.3	<p>Chapter update: Name plate 6.2; Permissible ambient and operating conditions 7.2.1; Rotational encoders 9.12.1; OCT 10.7.1; Rotational encoders 9.12.1; External brake resistor 12.5.3; Motor chokes 12.7.1 and 12.7.2</p>
2.2	<p>Chapter update: 1.0; 3.0; 6.4 – 6.8; 7.2.2; 7.2.3; 7.2.4; 9.1.3; 9.1.4; 9.3 – 9.7; 9.8.4; 9.11.1; 9.12; 9.14.1; 10.1.6.3; 11.4</p> <p>New Chapter: Third party motors 10.1.5</p> <p>General update: Accessoires 12.0; Appendix 13.0</p>
2.1	<p>Chapter update: 2.3.1; 7.2.4; 8.2; 9.1.3; 9.1.4; 9.3; 9.12.1; 10.4.1; 10.4.2; 10.5; 12.2.1.1; 12.3.5.3</p> <p>Delete Chapter: 10.7.2</p>
2.0	General update
1.1	<p>Chapter update: 9.7.5; 9.8.1; 9.8.4; 14.2.1.1; 14.2.1.2</p> <p>New chapter: 9.8.2</p>
1.0	First published

1.2.1 Scope of the documentation

The overall documentation package for the AX5000 is comprised of the following manuals:

- This system manual

- Function manual
- Description of the drive parameters (S-IDN and P-IDN)
- Description of diagnostic messages
- Description of the TCDriveManager
- Description of the accessories

1.3 Appropriate use

The servo drives of the AX5000 series are exclusively designed for torque, speed and position control of suitable asynchronous and synchronous three-phase current motors. The maximum permissible effective motor voltage must be at least equal the effective mains voltage fed into the servo drive.

The servo drives from the AX5000 series are designed for installation as components in electrical systems or machines and may be operated only as integrated system components.

WARNING

Caution - Risk of injury!

Electronic equipment is not fail-safe. The machine manufacturer is responsible for ensuring that the connected motors and the machine are brought into a safe state in the event of a fault in the drive system.

The servo drives may only be operated in enclosed control cabinets and in accordance with the conditions described in the "Technical data" chapter.

1.3.1 Dual Use (EU 1382/2014)

According to EU Regulation 1382/2014 (published on 30.12.2014), standard frequency converters, including the Beckhoff AX5000 product range, are now classified as dual-use products. The list of goods in Annex I of Dual-Use Regulation 428/2009 was amended accordingly; frequency converters (listed under item 3A225) with an "operating frequency greater than or equal to 600 Hz" are now subject to export control. Note the following changes.

Firmware versions without the supplement (Dual Use compliant) can only be operated on the following devices, taking into account the hardware versions:

- HW Version 1.0 (AX5xxx-0000-00xx): serial number < 68.000
- HW Version 1.0 (AX5xxx-0000-001x)
- HW Version 2.0 (AX5xxx-0000-02xx): serial number < 140.000
- HW Version 2.0 (AX5xxx-0000-021x)

Firmware versions with the supplement (Dual Use compliant) can continue to be operated on all devices, irrespective of the hardware versions. These versions support both rotary field frequency ranges (< 600 Hz, >= 600 Hz), depending on the device.

Devices with optional ID "001x" and "021x": shipping as individual part may require official approval.

2 Guidelines and Standards

2.1 EC declaration of conformity

**Provision of EU Declaration of Conformity:**

Beckhoff Automation GmbH & Co. KG will be glad to provide you with EU declarations of conformity and manufacturer's declarations for all products upon request to info@beckhoff.com.

2.2 UL approval for devices up to 40 A for the US and Canada

	<p>The German translation of this section is intended for information only! The English version of this section is binding.</p>
---	--

The following servo drives from the AX5000 series have a UL-Listing and must bear the CUS symbol

	<p>AX5000 with UL approval AX5101, AX5103, AX5106, AX5112, AX5118, AX5125, AX5140, AX5201, AX5203 and AX5206.</p>
---	--

on the name plate. If you intend to operate an AX5000 in the US or Canada, please check whether the name plate shows the CUS label.

Below is a list of the relevant chapters that are amended with respect to the UL-Listing. Furthermore, UL-specific remarks are listed.

2.2.1 UL-specific chapter changes

“Mains supply connection (X01)”

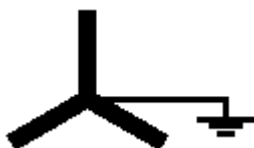

AX5000 shall be connected only to a **grounded wye-source** where the maximum voltage does not exceed 277 V to ground.

“Connection of several servo drives to form a drive system”

	<p>Drive system with UL-Listing! Please consult our Application Department with respect to the requirements for a drive system with UL-Listing.</p>
---	--

2.2.2 UL-specific chapter

“External protection, UL-compliant”

Integral solid state short circuit protection does not provide branch circuit protection. Branch circuit protection must be provided in accordance with the Manufacture Instructions, National Electrical Code and any additional local codes.

Suitable for use on a circuit capable of delivering not more than 18 kA (SCCR value) symmetrical amperes, 480 V maximum, when protected by RK5 class fuses.

Single-phase:

	AX5101	AX5103	AX5106	AX5201	AX5203	AX5206
AC-supply (max.) *)	6 A	12 A	20 A	12 A	20 A	20 A
24 V-supply (max.)	3 A					
Brake resistor	electronic					

*) Mains fuses according to type “RK5” must be used.

Three-phase:

	AX5101	AX5103	AX5106	AX5112	AX5118	AX5125
AC-supply (max.) *)	6 A	12 A	20 A	20 A	35 A	45 A
24 V-supply (max.)	3 AT					
Brake resistor	electronic					

	AX5140	AX5201	AX5203	AX5206		
AC-supply (max.) *)	80 A	12 A	20 A	20 A		
24 V-supply (max.)	3 AT					
Brake resistor	electronic					

*) Mains fuses according to type “RK5” must be used.

	<p>When protected by RK5 class fuses:</p> <p>AX5112: Rated 20 A, min. 480 V</p> <p>AX5118: Rated 35 A, min. 480 V</p> <p>AX5125: Rated 45 A, min. 480 V</p> <p>AX5140: Rated 80 A, min. 480 V</p>
---	--

2.2.3 UL-specific notes

Use in a Pollution Degree 2 environment
 Use 75 °C Copper Conductors min.
 Control Board rating = 24 V

Drive intended for use over a range of motor sizes. Internal motor overload protection level is adjustable:

The internal motor protection is parameterised via the IDN P-0-0062 “Thermal motor model”, based on the value of the IDN S-0-0111 “Motor continuous stall current”. The IDN P-0-0062 “Time constant” is specified by the motor manufacturer and must be entered here. The IDN P-0-0062 “Warning limit” (Default) is responsible for deciding when a warning is to be generated. The IDN P-0-0062 “Error limit” (Default) is responsible for deciding when the motor is to be switched off. The default values take into account the specific characteristics of the servomotors.

	<p>Canada! In Canada use only in combination with unit AX2090-TS50-3000, manufactured by Beckhoff Automation.</p>
---	---

2.3 UL approval for devices above 60A for the US and Canada

	<p>The German translation of this section is intended for information only! The English version of this section is binding.</p>
--	---

The following servo drives from the AX5000 series have a UL-Listing and must bear the CUS symbol

	<p>AX5000 with UL approval AX5160, AX5172, AX5190, AX5191, AX5192 and AX5193.</p>
---	---

on the name plate. If you intend to operate an AX5000 in the US or Canada, please check whether the name plate shows the CUS label.

Below is a list of the relevant chapters that are amended with respect to the UL-Listing. Furthermore, UL-specific remarks are listed.

2.3.1 UL-specific chapter changes

“Mains supply connection (X01)”

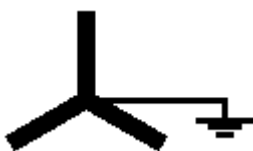

AX5000 shall be connected only to a **grounded wye-source** where the maximum voltage does not exceed 277 V to ground.

“Connection of several servo drives to form a drive system”

	<p>Drive system with UL-Listing! Please consult our Application Department with respect to the requirements for a drive system with UL-Listing.</p>
---	---

2.3.2 UL-specific chapter

“External protection, UL-compliant”

Integral solid state short circuit protection does not provide branch circuit protection. Branch circuit protection must be provided in accordance with the Manufacture Instructions, National Electrical Code and any additional local codes.

AX5160 and AX5172:

Suitable for use on a circuit capable of delivering not more than 5 kA (SCCR value) symmetrical amperes, 480 V maximum. When protected by RK5 class fuses, rated 100 A maximum.

AX5190 - AX5193:

Suitable for use on a circuit capable of delivering not more than 10 kA (SCCR value) symmetrical amperes, 480 V maximum. When protected by RK5 class fuses, rated 225 A maximum.

	AX5160	AX5172	AX5190	AX5191	AX5192	AX5193
AC-supply (max.) *)						
24 V-supply (max.)	4 AT		10 AT			
Brake resistor	electronic					

*) Mains fuses according to type “RK5” min. 480 V must be used.

2.3.3 UL-specific notes

Use in a Pollution Degree 2 environment

Use 75 °C Copper Conductors min.

Control Board rating = 24 V

Drive intended for use over a range of motor sizes. Internal motor overload protection level is adjustable:

The internal motor protection is parameterised via the IDN P-0-0062 “Thermal motor model”, based on the value of the IDN S-0-0111 “Motor continuous stall current”. The IDN P-0-0062 “Time constant” is specified by the motor manufacturer and must be entered here. The IDN P-0-0062 “Warning limit” (Default) is responsible for deciding when a warning is to be generated. The IDN P-0-0062 “Error limit” (Default) is responsible for deciding when the motor is to be switched off. The default values take into account the specific characteristics of the servomotors.

	<p>Canada!</p> <p>In Canada use only in combination with unit AX2090-TS50-3000, manufactured by Beckhoff Automation.</p>
---	---

2.4 Electrical isolation according to EN 50178 / VDE 0160

The power section (motor connection, DC link connection and mains connection) and the control unit are **doubly** insulated against each other, so that safe protection against accidental contact is ensured at all terminals of the control unit without additional measures. The air and creepage distances also meet the requirements of the above standard.

3 Safety

3.1 Safety instructions

Safety regulations

Please note the following safety instructions and explanations!
 Product-specific safety instructions can be found on following pages or in the areas mounting, wiring, commissioning etc.

Exclusion of liability

All the components are supplied in particular hardware and software configurations appropriate for the application. Modifications to hardware or software configurations other than those described in the documentation are not permitted, and nullify the liability of Beckhoff Automation GmbH & Co. KG.

Personnel qualification

This description is only intended for trained specialists in control, automation and drive engineering who are familiar with the applicable national standards.

Description of symbols

In this documentation the following symbols are used with an accompanying safety instruction or note. The safety instructions must be read carefully and followed without fail!

⚠ DANGER
<p>Serious risk of injury!</p> <p>Failure to follow the safety instructions associated with this symbol directly endangers the life and health of persons.</p>

⚠ WARNING
<p>Risk of injury!</p> <p>Failure to follow the safety instructions associated with this symbol endangers the life and health of persons.</p>

⚠ CAUTION
<p>Personal injuries!</p> <p>Failure to follow the safety instructions associated with this symbol can lead to injuries to persons.</p>

NOTE
<p>Damage to the environment or devices</p> <p>Failure to follow the instructions associated with this symbol can lead to damage to the environment or equipment.</p>



Tip or pointer

This symbol indicates information that contributes to better understanding.

	<p>UL pointer</p> <p>This symbol indicates important information about the UL-compliant.</p>
--	---

3.2 Special safety notes for servo drives

The safety instructions are designed to avert danger and must be followed during installation, commissioning, production, troubleshooting, maintenance and trial or test assemblies.

The servo drives of the AX5000 series are not designed for stand-alone operation and must always be installed in a machine or system. After installation the additional documentation and safety instructions provided by the machine manufacturer must be read and followed.

WARNING

Serious risk of injury through high electrical voltage!

- Never open the servo drive when it is live. Wait until the DC link capacitors are discharged. The measured voltage between the terminals "DC+ and DC-" and "RB+ and RB-" must have dropped below 50 V. Opening the device (with the exception of expansion card slots) invalidates all warranty and liability claims against Beckhoff Automation GmbH & Co. KG.
- Negligent, improper handling of the servo drive and bypassing of the safety devices can lead to personal injury or death through electric shock.
- Ensure that the protective conductor is connected properly.
- Disconnect the servo drive from the mains supply and secure it against reconnection before connecting or disconnecting the pluggable terminals.
- Disconnect the servo drive from the mains supply and secure it against reconnection before working on electrical parts with a voltage > 50 V.
- Due to the DC link capacitors, the DC link terminal points "ZK+ and ZK- (DC+ and DC-)" and "RB+ and RB-" may be subject to dangerous voltages exceeding $875 V_{DC}$, even after the servo drive was disconnected from the mains supply. Wait 5 minutes for the AX5101 - AX5125 and AX520x; 15 minutes for the AX5140/AX5160/AX5172; 30 minutes for the AX5190/AX5191; 45 minutes for the AX5192/AX5193 after disconnecting, and measure the voltage at the DC link terminal points "ZK+ and ZK- (DC+ and DC-)". The device is safe once the voltage has fallen below 50 V.

WARNING

Serious risk of injury through hot surfaces!

- The surface temperature may exceed 50 °C, resulting in a risk of burns.
- Avoid touching the housing during or shortly after operation.
- Leave the servo drive to cool down for at least 15 minutes after it is switched off.
- Use a thermometer to check whether the surface has cooled down sufficiently.

WARNING

High risk of injury through uncontrolled movements!

- Read and take note of chapter "Important information for commissioning" each time before commissioning the AX5000

CAUTION

Personal injuries

- Carefully read this manual before using the servo drive thoroughly, paying particular attention to the safety instructions. In the event of any uncertainties please notify your sales office immediately and refrain from working on the servo drive.
- Only well trained, qualified electricians with sound knowledge of drive equipment may work on the device.
- During the electrical installation it is essential to ensure that the correct fuses/protective circuit breakers are used between the mains supply and the servo drive. Further information can be found in the "Electrical installation" section.
- If a servo drive is installed in a machine it must not be commissioned until proof of compliance of the machine with the latest version of the EC Machinery Directive has been provided. This includes all relevant harmonized standards and regulations required for implementation of this Directive in national legislation.

NOTE**Damage to the environment or devices**

- During installation it is essential to ensure that the specified ventilation clearances and climatic conditions are adhered to. Further information can be found in the "Technical data" and "Mechanical installation" sections.
- If the servo drive is operated in contaminated ambient air, the cooling openings must be checked regularly for blockage. These checks should be carried out several times per day.
- The servo drives contain components at risk from electrostatic discharge caused by improper handling:
 - ⇒ Please ensure you are electrostatically discharged before touching the servo drive directly.
 - ⇒ Avoid contact with highly insulating materials (synthetic fibers, plastic film etc.).
 - ⇒ Place the servo drive on a conductive surface.
 - ⇒ Do not touch the motor connector while the AX5000 is in operation.

4 Handling

4.1 Transport and storage

Transport

- Only by qualified personnel
- Only in recyclable original manufacturer's packaging
- Avoid sharp impacts
- Temperature: -40...+70°C, varying no faster than 20K / hour
- Air humidity: relative humidity max. 95%, non-condensing
- The servo drives contain components at risk from electrostatic discharge caused by improper handling.
 - Please ensure you are electrostatically discharged before touching the servo drive directly.
 - Avoid contact with highly insulating materials (synthetic fibers, plastic film etc.).
 - Place the servo drive on a conductive surface.
- If the packaging is damaged, check the uprighter and any included accessories for visible damage. Inform the transport company and, if necessary, the manufacturer.

Storage

- The AX5000 and its accessories must not be stored outdoors. The storage space must be adequately ventilated and dry.
- The devices must be stored in the recyclable original manufacturer's packaging.
- The servo drives contain components at risk from electrostatic discharge caused by improper handling.
 - Please ensure you are electrostatically discharged before touching the servo drive directly.
 - Avoid contact with highly insulating materials (synthetic fibers, plastic film etc.).
 - Place the servo drive on a conductive surface.
- Max. stack height 8 cartons
- Storage temperature: - 40...+ 55° C, varying no faster than 20 K / hour
- Air humidity: relative humidity max. 95%, non-condensing
- Storage time:
 - < 5 years: without limitation

NOTE

Destruction of the equipment

On no account must the device be connected to 400 V if the DC link capacitors have lost their **forming**. The capacitors must be reformed (see below).

> 5 years: The dielectric (an oxidation layer with a thickness of approx. 1 μ) in the DC link capacitors degrades over time, and the capacitors lose their **forming**.

Prior to commissioning of the servo drive the capacitors must be **reformed**. Release all electrical connections and feed the servo drive for about 30 minutes with 230 V_{AC} (single-phase) at terminals L1/L2 or L2/L3.

Packaging

- Recyclable carton with inserts
- Dimensions:
 - (H x W x D) 348 x 324 x 175 mm
 - Identification: Device name plate on the outside of the carton

4.2 Maintenance

- The devices are maintenance-free

- Opening the devices invalidates the warranty

4.3 Cleaning

- Soiled housing: Clean with isopropanol or similar
Do not immerse or spray!
- Contamination inside the device: Cleaning by the manufacturer
- Soiled fan guard: Clean with (dry) brush

4.4 Disposal

- Screw connections enable the servo drives to be dismantled into main components (aluminum heat sink, steel cases, PCBs)
- The device should be disposed of by a certified disposal company. You can obtain addresses from us. Housing components (polycarbonate, polyamide (PA6.6)) are suitable for plastic recycling.
- Metal parts can be sent for metal recycling.
- Electronic parts such as circuit boards and terminals must be disposed of in accordance with national electronics scrap regulations.

In accordance with the WEEE 2012/96/EG Directives we take old devices and accessories back for professional disposal, provided the transport costs are taken over by the sender.

Send the devices with the note "For disposal" to:

Beckhoff Automation GmbH & Co. KG
Huelshorstweg 20
D-33415 Verl

5 Product overview

5.1 Scope of supply

The AX5000 is supplied as follows:

- AX5000 in the performance class according to the order
- Connector
 X01: for mains input
 X02: for DC link (not for AX5140)
 X03: for DC power supply (24 V)
 X06: for digital inputs and outputs
 X07: external brake resistor (only AX5140)
- Quick reference guide (Startup)
- Documentation on CD-ROM

Connector

The D-SUB connectors X11, X12, X21, X22 (for feedback cable and resolver/Hall) and the motor and sensor connectors X13, X14, X23, X24 are not part of the scope of delivery of the servo drive. However, they are included with pre-assembled motor and feedback cables.

5.2 Name plate

The servo drive features two name plates.

- Large name plate: The large name plate attached at the side of the servo drive and includes the following information:
- Small name plate: The second name plate is attached to the upper mounting flange mounted and is designed to show the main, even if several AX5000 are installed directly side by side. The small name plate contains the following information.

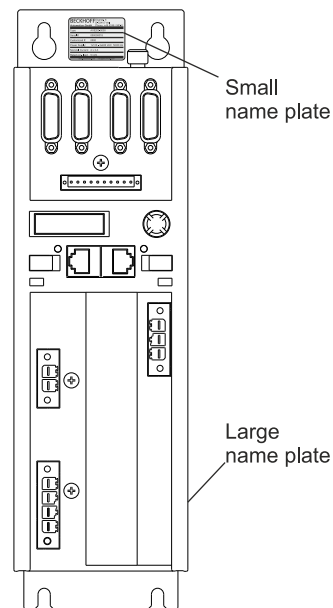
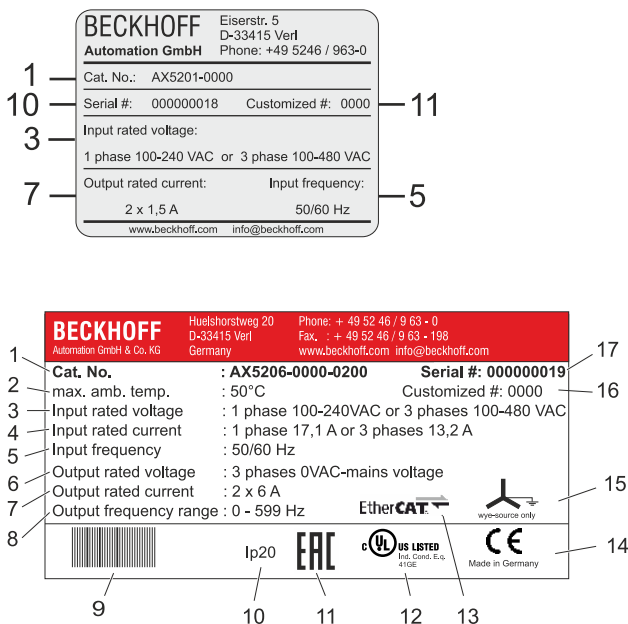

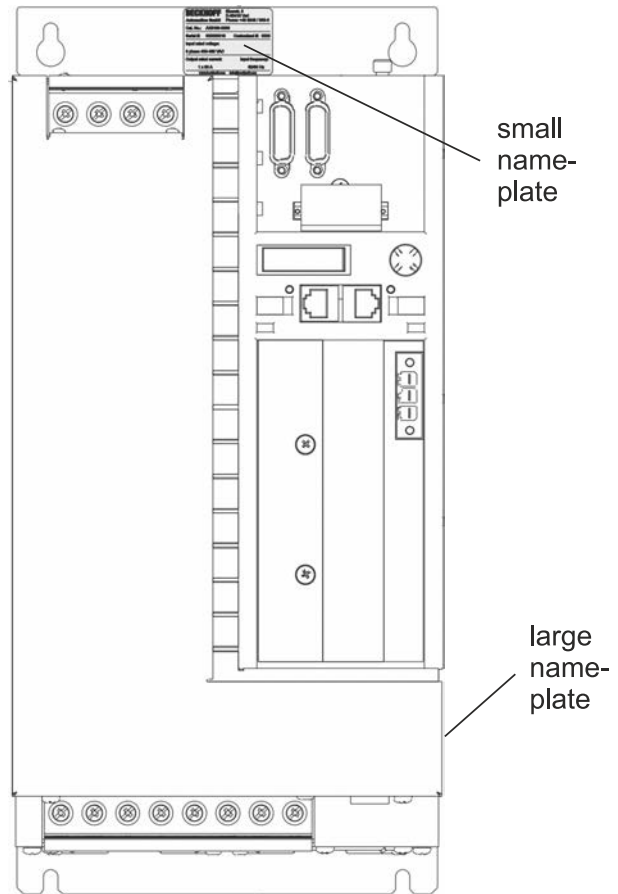
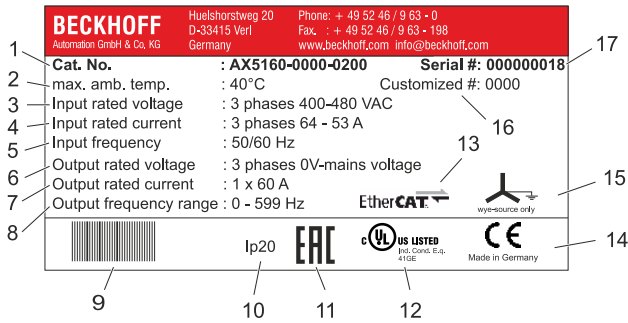
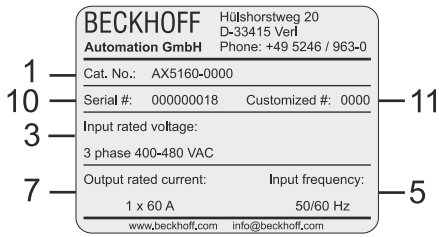

1	Order number	7	Rated output current	13	EtherCAT compliant
2	Max. ambient temperature	8	Output frequency range	14	CE compliant
3	Rated input voltage	9	Barcode	15	Standard mains supply with earthed center
4	Rated input current	10	Protection class	16	Customer-specific
5	Input frequency	11	EAC compliant	17	Serial number
6	Rated output voltage	12	cULus approval		

5.3 Type key

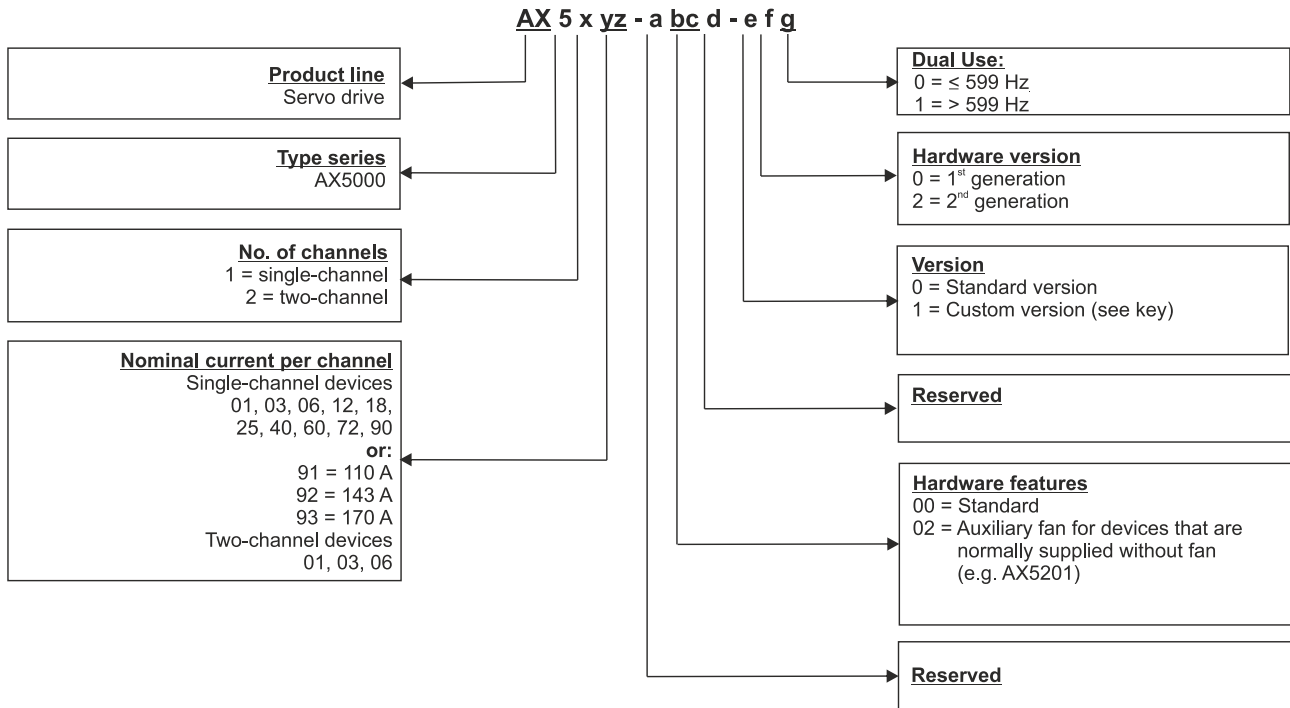

5.4 Image showing AX5101 - AX5112 and AX520x

The servo drive shown below is a two-channel device designed for a maximum current of 12 A. Components that are only available for the second channel are identified in the item description.

Item descriptions:

No.	Name	
1	X11 - feedback connection, encoder	
2	X12 - feedback connection, resolver	
3	X21 - feedback connection, encoder channel B (only for two-channel unit)	
4	X22 - feedback connection, resolver channel B (only for two-channel unit)	
5	X3x - optional slot for safety card X4x - optional slot for expansion cards	
6	Navigation rocker	
7	Status LED for EtherCAT output	
8	Labelling field	
9	X05 - socket for EtherCAT output	
10	X03 - power supply 24 V DC input	
11	X14 – sensor for motor temperature, brake and OCT	
12	X24 – sensor for motor temperature, brake and OCT channel B (only for two-channel unit)	
13	X23 - motor connection (U, V, W, PE) channel B (only for two-channel unit)	
14	X13 - motor connection (U, V, W, PE)	
15	X01 - mains supply 100 - 480 V	
16	X02 - DC link output (max. voltage 875 V DC) Connection for the external brake resistor	
17	 DANGER	Max. voltage 875 V DC at the DC link terminal points (X02). Once the device has been switched off dangerous voltage will still be present for a further 5 minutes. The device is safe once the voltage has fallen below 50 V.
18	X04 - socket for EtherCAT input	
19	Labelling field	
20	Status LED for EtherCAT input	
21	Display	
22	X06 - connection for digital inputs and outputs	

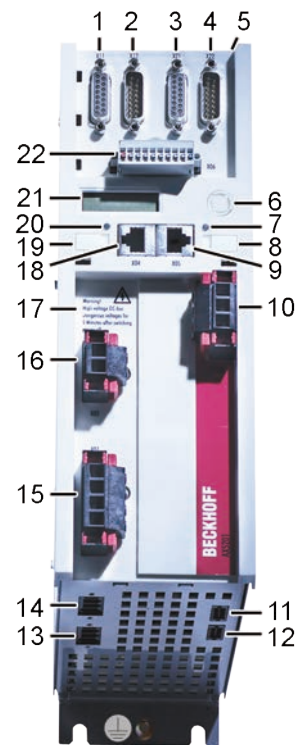

5.5 Image showing AX5118, AX5125 and AX5140

The servo drive illustrated below is an AX5140; the devices with 18 A or 25 A are structurally similar apart from pos. 11 "X07" (external brake resistor).

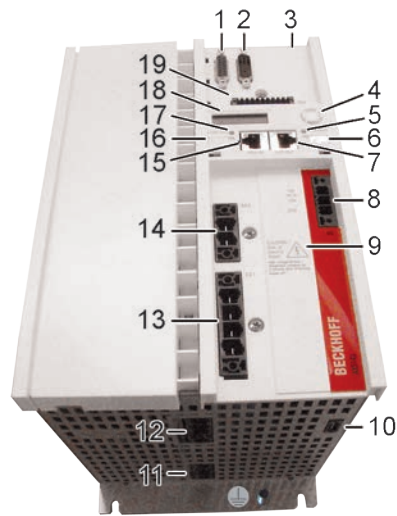

Pos.	Name	Pos.	Name
1	X11 - feedback connection, encoder	11	X07 - external brake resistor (only AX5140)
2	X12 - feedback connection, resolver	12	X13 - motor connection (U, V, W, PE)
3	X3x - optional slot for safety card X4x - optional slot for expansion cards	13	X01 - mains supply 100 - 480 V
4	Navigation rocker	14	X02 – DC link output (max. voltage 875 V DC), connection for external brake resistor (only AX5118 and AX5125)
5	Status LED for EtherCAT output	15	X04 - socket for EtherCAT input
6	Labelling field	16	Labelling field
7	X05 - socket for EtherCAT output	17	Status LED for EtherCAT input
8	X03 - power supply 24 V DC input	18	Display
9	 DANGER Max. voltage 875 V DC at the DC link terminals (X02). Dangerous voltage continues to be present for around 5 minutes after the device has been switched off (AX5140 = 15 min.). The device is safe once the voltage has fallen below 50 V.	19	X06 - connection for digital inputs and outputs
10	X14 – sensor for motor temperature, brake and OCT		

5.6 Image showing AX5160 - AX5172

The servo drive shown below is a AX5172; the AX5160 is identical.

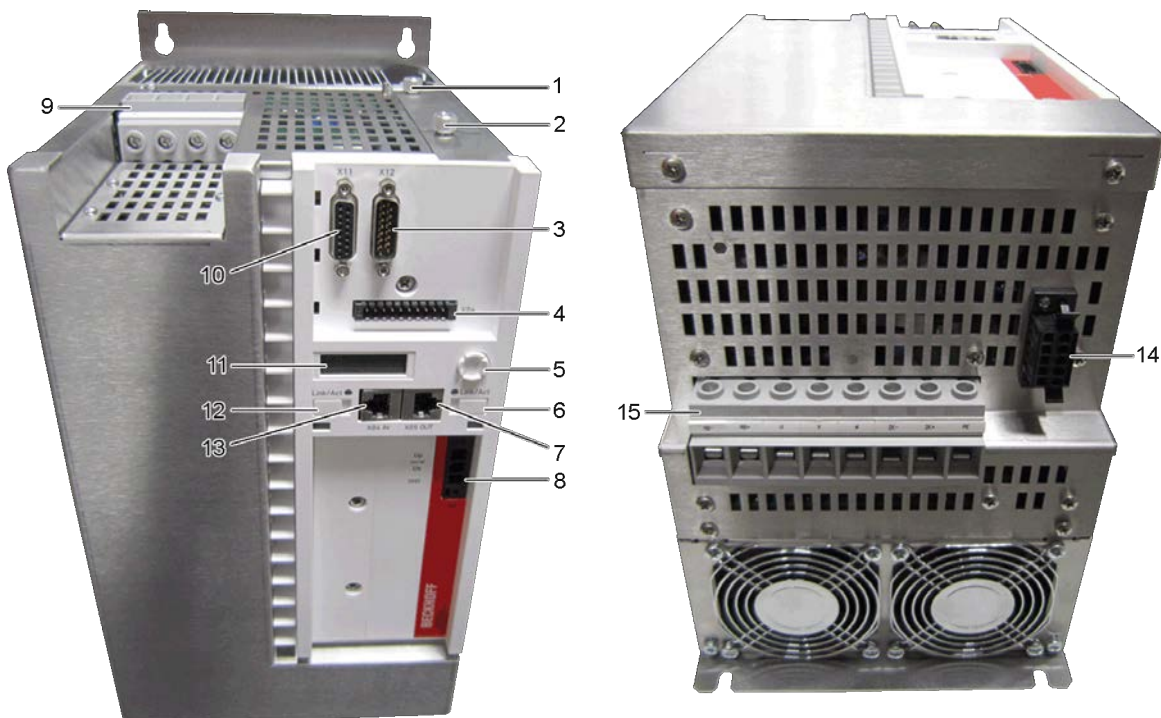

Item descriptions:

No.	Name	No.	Name
1	X4x - optional slot for expansion cards	9	X01 – mains supply 400 V – 480 V
2	X3x - optional slot for safety card	10	X11 - feedback connection, resolver
3	X12 - feedback connection, encoder	11	Display
4	X06 - connection for digital inputs and outputs	12	Labelling field
5	Navigation rocker	13	X04 - socket for EtherCAT input
6	Labelling field	14	X14 - sensor for motor temperature and brake
7	X05 - socket for EtherCAT output	15	Connection for the external brake resistor DC link output (875 V DC voltage). Motor connection (U, V, W, PE)
8	X03 - power supply 24 V DC input		

⚠ DANGER

Serious risk of injury through high electrical voltage!

Due to the DC link capacitors, the DC link terminal points "DC+ and DC-" and "RB+ and RB-" may be subject to dangerous voltages exceeding 875 V_{DC}, even after the servo drive was disconnected from the mains supply.

After disconnection, wait for 15 minutes (AX5160/AX5172), 30 minutes (AX5190/AX5191) or 45 minutes (AX5192/AX5193) and measure the voltage at the DC link-terminal points DC+ and DC-. The device is safe once the voltage has fallen below 50 V.

5.7 Image showing AX5190 - AX5191

The servo drive shown below is a AX5190; the AX5191 is identical.



Item descriptions:

No.	Name	No.	Name
1	X4x - optional slot for expansion cards	9	X14 - sensor for motor temperature and brake
2	X3x - optional slot for safety card	10	DC link output (875 V DC voltage), connection for the external brake resistor
3	X12 - feedback connection, encoder	11	Motor connection (U, V, W, PE)
4	X06 - connection for digital inputs and outputs	12	X04 - socket for EtherCAT input
5	Navigation rocker	13	Labelling field
6	Labelling field	14	Display
7	X05 - socket for EtherCAT output	15	X11 - feedback connection, resolver
8	X03 - power supply 24 V DC input	16	X01 - mains supply

⚠ DANGER

Serious risk of injury through high electrical voltage!

Due to the DC link capacitors, the DC link terminal points "DC+ and DC-" and "RB+ and RB-" may be subject to dangerous voltages exceeding 875 V_{DC}, even after the servo drive was disconnected from the mains supply.

After disconnection, wait for 15 minutes (AX5160/AX5172), 30 minutes (AX5190/AX5191) or 45 minutes (AX5192/AX5193) and measure the voltage at the DC link-terminal points DC+ and DC-. The device is safe once the voltage has fallen below 50 V.

5.8 Image showing AX5192 - AX5193

The servo drive shown below is a AX5192; the AX5193 is identical.



Item descriptions:

No.	Name	No.	Name
1	X4x - optional slot for expansion cards	9	X14 - sensor for motor temperature and brake
2	X3x - optional slot for safety card	10	X07 – external brake resistor
3	X12 - feedback connection, encoder	11	DC link output (875 V DC voltage).
4	X06 - connection for digital inputs and outputs	12	Motor connection (U, V, W, PE)
5	Navigation rocker	13	X04 - socket for EtherCAT input
6	Labelling field	14	Labelling field
7	X05 - socket for EtherCAT output	15	Display
8	X03 - power supply 24 V DC input	16	X11 - feedback connection, resolver
		17	X01 – mains supply 400 V – 480 V

⚠ DANGER

Serious risk of injury through high electrical voltage!

Due to the DC link capacitors, the DC link terminal points "DC+ and DC-" and "RB+ and RB-" may be subject to dangerous voltages exceeding 875 V_{DC}, even after the servo drive was disconnected from the mains supply.

After disconnection, wait for 15 minutes (AX5160/AX5172), 30 minutes (AX5190/AX5191) or 45 minutes (AX5192/AX5193) and measure the voltage at the DC link-terminal points DC+ and DC-. The device is safe once the voltage has fallen below 50 V.

6 Technical description

6.1 Configuration of the servo drives



The servo drives of the AX5000 series are available as single- or multi-channel versions and are optimized in terms of function and cost-effectiveness. Integrated control technology supports fast and highly dynamic positioning tasks. EtherCAT as a high-performance system communication enables ideal interfacing with PC-based control technology.

The single-channel AX51xx servo drives are designed for rated motor currents up to 170 A. The AX52xx two-channel servo drive enables operation of two motors with identical or even with different capacity, up to a total current of 12 A. The multi-axis drives with variable motor output allocation optimize packaging density and the cost per drive channel.

The AX5000 system enables simple and fast connection of several AX5000 devices to form a multi-axis system through the AX-Bridge quick connection system. The pluggable supply and connection module combines power supply, DC link, and control ($24 V_{DC}$) and braking voltage.

A wide range of motor types can be connected to the AX5000. Motors of different size and type can be connected without additional measures. Examples include synchronous, linear, torque and asynchronous motors. The multi-feedback interface supports all common feedback standards, such as: OCT, BiSS, EnDat, 1 Vss, Resolver.

The AX5000 was developed specifically for the EtherCAT real-time Ethernet system. The outstanding features of EtherCAT are particularly beneficial for drive technology. They include short cycle time, synchronicity and simultaneity. EtherCAT enables very short cycle times, even in networks containing a large number of devices.

6.2 General technical data

	<p>UL approval</p> <p>If you intend to operate an AX5000 in a region that requires UL approval, please refer to the chapter "Guidelines and Standards".</p>
---	--

6.2.1 Permissible ambient and operating conditions

Technical data	AX5000
Ambient temperature during operation	0 °C to +50 °C (1.5 A – 40 A devices) 0 °C to +40 °C (60 A – 170 A devices), up to 55 °C with power derating (2% / °C)
Ambient temperature during transport	-25 °C to +70 °C
Ambient temperature during storage	-25 °C to +70 °C (1.5 A – 40 A devices) -25 °C to +55 °C (60 A – 170 A devices)
Air humidity	5% to 95%, non-condensing (1.5 A – 40 A units) 5% to 85 %, non-condensing (60 A – 170 A units)
Level of contamination	Contamination level 2 according to EN 60204 / EN 50178
Corrosion protection	Normally not required. Under extreme operating conditions, special measures must be agreed with the manufacturer, and implemented by the user.
Operating altitude	up to 1000 m above sea level without restrictions 60 A to 170 A devices – from 1000 m up to 3000 m above sea level with power derating (1.5% per 100 m)
Permissible installation position	vertical
Ventilation	Total rated device current ≤3 A: free convection, Total rated device current >3 A: built-in temperature-controlled fan
Protection class	IP20
Vibration test (EN 60068-2-6)	Frequency range: 10 - 500 Hz Amplitude: 10 - 58 Hz = 0.075mm pk-pk 59 - 500 Hz = 1 g
Shock test (EN 60068-2-27)	Half sine wave amplitude: 5 g Duration: 30 ms Number of shocks: 3 per axis and direction (total 18)
Shock test (EN 60068-2-27)	Half sine wave amplitude: 5 g Duration: 30 ms Number of shocks: 1000 per axis and direction (total 6000)
EMC	Category C3 - standard Category C1, C2 - auxiliary filter required
Approvals	CE
Special operating conditions	The usability of Beckhoff servo drives from the AX5000 series under harsh operating conditions or other unfavorable conditions must be ascertained individually in consultation between the manufacturer and the user.

6.2.2 Electrical data - servo drive (AX5101 - AX5140)

Single-phase connection

Technical data	AX5101	AX5103	AX5106
Rated output current	1.5 A	3 A	4.5 A
Minimum rated channel current at full current resolution	0.35 A	1 A	1 A
Peak output current ¹⁾	4.5 A	7.5 A	13 A
Rated supply voltage	1 x 100 _{-10%} - 240 _{+10%} V _{AC}		
Max. DC link voltage	875 V _{DC}		
Rated apparent power S1 operation (selection)			
120 V	0.3 kVA	0.6 kVA	1.2 kVA
230 V	0.6 kVA	1.2 kVA	2.4 kVA
Power loss ²⁾	35 W	50 W	85 W
Continuous braking power (internal brake resistor)	50 W	50 W	150 W
Max. braking power (internal brake resistor)	14 kW		
Min. brake resistance (external brake resistor)	47 Ω		
Max. braking power (external brake resistor)	15 kW		
DC link capacity	235 μF		
SCCR value	18 kA		

¹⁾ I_{eff} for max. 7 s, by switching frequency of 8 kHz (IDN P-0-0001)

²⁾ S1 mode, including power supply unit, without brake chopper

Three-phase connection

Electrical data	AX5101	AX5103	AX5106	AX5112	AX5118	AX5125	AX5140
Rated output current	1.5 A	3 A	6 A	12 A	18 A	25 A ¹⁾	40 A
Minimum rated channel current at full current resolution	0.35 A	1 A	1 A	6 A	12 A	12 A	18 A
Peak output current ³⁾	4.5 A	7.5 A	13 A	26 A	36 A	50 A	80 A ⁴⁾
Rated supply voltage	3 x 100 _{-10%} - 480 _{+10%} V _{AC} ²⁾						
Max. DC link voltage	875 V _{DC}						
Rated apparent power S1 operation (selection)							
120 V	0.3 kVA	0.6 kVA	1.2 kVA	2.5 kVA	3.4 kVA	4.8 kVA	8.3 kVA
230 V	0.6 kVA	1.2 kVA	2.4 kVA	4.8 kVA	7.2 kVA	10 kVA	16 kVA
400 V	1.0 kVA	2.1 kVA	4.2 kVA	8.3 kVA	12.5 kVA	17.3 kVA	28 kVA
480 V	1.2 kVA	2.5 kVA	5.0 kVA	10 kVA	15 kVA	20.8 kVA	33 kVA
Power loss ⁵⁾	35 W	50 W	85 W	160 W	255 W	340 W	510 W
Max. continuous braking power (internal brake resistor)	50 W	50 W	150 W	90 W	200 W	200 W	150 W
Braking power (internal brake resistor)	14 kW				26 kW	26 kW	26 kW
Min. brake resistance (external brake resistor)	47 Ω	47 Ω	47 Ω	30 Ω	22 Ω	22 Ω	22 Ω ⁶⁾
Max. braking power (external brake resistor)	15 kW	15 kW	15 kW	23.5 kW	32 kW	32 kW	32 kW
DC link capacity	235 μF			470 μF	940 μF	1175 μF	1485 μF
SCCR value	18 kA						

¹⁾ cULus = 24 A

²⁾ cULus = AX5118 and AX5125 = 3 x 480 V_{AC} ± 10%

³⁾ I_{eff} for max. 7 s, by switching frequency of 8 kHz (IDN P-0-0001)

- 4) I_{eff} for max. 7 s, if rotary field frequency > 3 Hz at max. 40 °C
- 5) S1 mode, including power supply unit, without brake chopper
- 6) Brake resistor < 22 Ω → Please consult our support

6.2.3 Electrical data - servo drive (AX52xx)

Single-phase connection

Electrical data	AX5201	AX5203	AX5206
Rated output current / channel	1.5 A	3 A	6 A
Minimum rated channel current at full current resolution	0.35 A	1 A	1 A
Maximum rated channel current at full current resolution	3 A	4.5 A	9 A
Total rated current with full current resolution	3 A	4.5 A	9 A
Max. peak output current ¹⁾ /channel	5 A	10 A	13 A
Peak output current ¹⁾ total device current	10 A	20 A	26 A
Rated supply voltage	1 x 100 _{-10%} - 240 _{+10%} V _{AC}		
Max. DC link voltage	875 V _{DC}		
Rated apparent power S1 operation (selection)			
120 V	0.6 kVA	1.2 kVA	2.5 kVA
230 V	1.2 kVA	2.4 kVA	4.8 kVA
Power loss ²⁾	55 W	85 W	160 W
Max. continuous braking power (internal brake resistor)	50 W	150 W	90 W
Max. braking power (internal brake resistor)	14 kW		
Min. brake resistance (external brake resistor)	47 Ω		
Max. braking power (external brake resistor)	15 kW		
DC link capacity	235 μF		470 μF
SCCR value	18 kA		

¹⁾ I_{eff} for max. 7 s, by switching frequency of 8 kHz (IDN P-0-0001)

²⁾ S1 mode, including power supply unit, without brake chopper

Three-phase connection

Electrical data	AX5201	AX5203	AX5206
Rated output current / channel	1.5 A	3 A	6 A
Minimum rated channel current at full current resolution	0.35 A	1 A	1 A
Maximum rated channel current at full current resolution	3 A	6 A	9 A
Total rated current with full current resolution	3 A	6 A	12 A
Max. peak output current ⁽¹⁾ /channel	5 A	10 A	13 A
Peak output current ⁽¹⁾ total device current	10 A	20 A	26 A
Rated supply voltage	3 x 100 _{-10%} - 480 _{+10%} V _{AC}		
Max. DC link voltage	875 V _{DC}		
Rated apparent power S1 operation (selection)			
120 V	0.6 kVA	1.2 kVA	2.5 kVA
230 V	1.2 kVA	2.4 kVA	4.8 kVA
400 V	2.1 kVA	4.2 kVA	8.3 kVA
480 V	2.5 kVA	5.0 kVA	10.0 kVA
Power loss ⁽²⁾	55 W	85 W	160 W
Max. continuous braking power (internal brake resistor)	50 W	150 W	90 W
Max. braking power (internal brake resistor)	14 kW		
Min. brake resistance (external brake resistor)	47 Ω		
Max. braking power (external brake resistor)	15 kW		
DC link capacity	235 μF		470 μF
SCCR value	18 kA		

¹⁾ I_{eff} for max. 7 s, by switching frequency of 8 kHz (IDN P-0-0001)

²⁾ S1 mode, including power supply unit, without brake chopper

6.2.4 Electrical data - servo drive (AX5160 - AX5193)

Electrical data	AX5160	AX5172	AX5190	AX5191	AX5192	AX5193
Rated output current ¹⁾	60 A	72 A	90 A	110 A	143 A	170 A
Minimum rated motor current at full current resolution	16 A	20 A	25 A	30 A	35 A	40 A
Peak output current ²⁾	120 ²⁾ A	144 ²⁾ A	180 ²⁾ A	180 ²⁾ A	215 ²⁾ A	221 ²⁾ A
Rated supply voltage	3x 400 _{-10%} - 480 _{+10%} V _{AC}					
Max. DC link voltage	875 V _{DC}					
Rated apparent power S1 operation (selection)						
400 V	42 kVA	50 kVA	62 kVA	76 kVA	99 kVA	118 kVA
480 V	45 kVA	54 kVA	67 kVA	82 kVA	107 kVA	127 kVA
Power loss ³⁾	830 W	1010 W	1300 W	1600 W	2100 W	2500 W
Min. brake resistor (external brake resistor)	13 Ω	13 Ω	10 Ω	10 Ω	6.5 Ω	6.5 Ω
Max. braking power (external brake resistor)	52 kW	52 kW	67 kW	67 kW	103 kW	103 kW
Continuous braking power ⁵⁾	37 kW	52 kW	56 kW	65 kW	65 kW	65 kW
Mains chokes ⁴⁾ AX2090-ND50	---	---	0090	0110	0143	0170
Mains filters ⁴⁾ AX2090-NF50	integrated	integrated	0100	0150	0150	0180
DC link capacity	900 μF		1060 μF	2120 μF	3180 μF	4240 μF
SCCR value	5 kA		10 kA			

¹⁾With a rated supply voltage of 480 V, the rated current must be reduced by 10%.

The specified values apply for an initial rotational frequency > 3 Hz

²⁾ I_{eff} for max. 3 s with a preload of max. 70% of the rated output current, a mains voltage of 400 V_{AC} and a switching frequency by 8 kHz (P-0-0001).

³⁾ S1 mode, including power supply unit, without brake chopper

⁴⁾ Required for compliance with EN 61800-3 (EMC product standard) C3 (industrial environment) with max. 25 m motor cable length.

⁵⁾ Based on a mains voltage of 3 x 400 V_{eff} and a frequency of 8 kHz.

● **Derating and switching frequency of the servo drive!**

i For further information of the Derating and the switching frequency from the servo drive AX5000, please look at the english version of the IDN-Description (P-0-0001 Switching frequency of the IGBT module).

6.2.5 Mechanical data - servo drive (AX5101-AX5140)

Mechanical data	AX5101	AX5103	AX5106	AX5112	AX5118	AX5125	AX5140
Weight	approx. 4 kg	approx. 4 kg	approx. 5 kg	approx. 5 kg	approx. 11 kg	approx. 11 kg	approx. 13 kg
Width	92 mm				185 mm	185 mm	185 mm
Height without plugs	274 mm						
Depth without connectors / accessories	232 mm						

6.2.6 Mechanical data - servo drive (AX52xx)

Mechanical data	AX5201	AX5203	AX5206
Weight	approx. 5 kg	approx. 6 kg	approx. 6 kg
Width	92 mm		
Height without plugs	274 mm		
Depth without connectors / accessories	232 mm		

6.2.7 Mechanical data - servo drive (AX5160 - AX5193)

Mechanical data	AX5160	AX5172	AX5190	AX5191	AX5192	AX5193
Weight	approx. 14 kg	approx. 14 kg	approx. 31 kg	approx. 31 kg	approx. 38 kg	approx. 38 kg
Width	190 mm	283 mm	283 mm			
Height without plugs	345 mm		540 mm			
Depth without connectors / accessories	259 mm		253 mm		334 mm	

6.3 Dimensions

6.3.1 AX5000 as single device (1.5 A - 40 A)

All dimensions in millimeters.

AX5118 / AX5125 / AX5140

AX5101-AX5112 / AX5201-AX5206

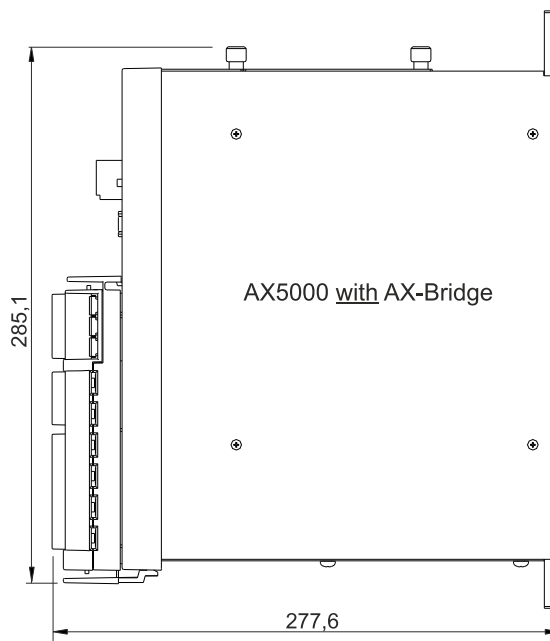
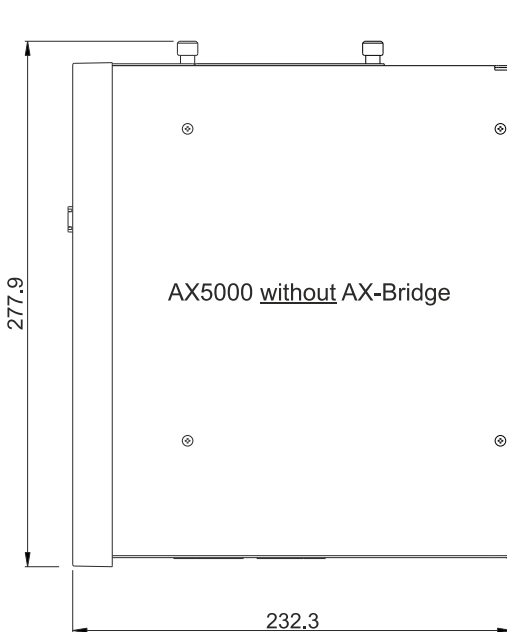
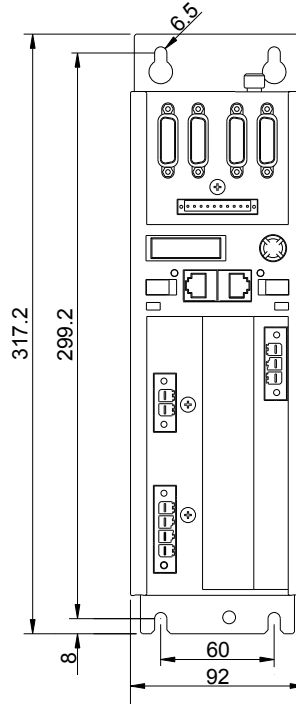
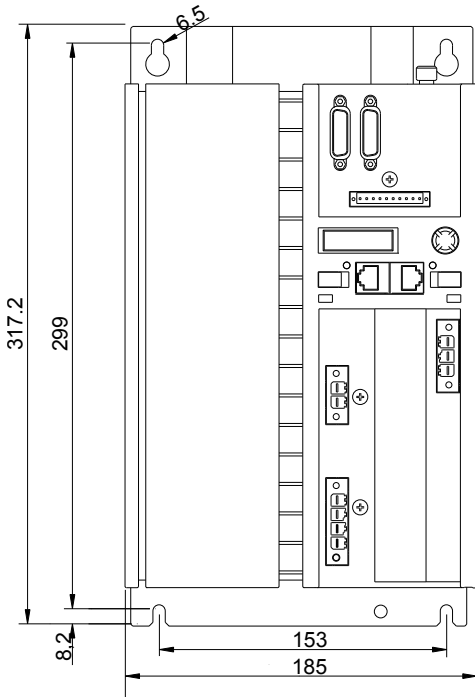

6.3.2 AX5000 as single device (60 A - 170 A)

The specified measurements relate to the actual device, without connectors and cables.

AX5160, AX5172, AX5190, AX5191, AX5192, AX5193

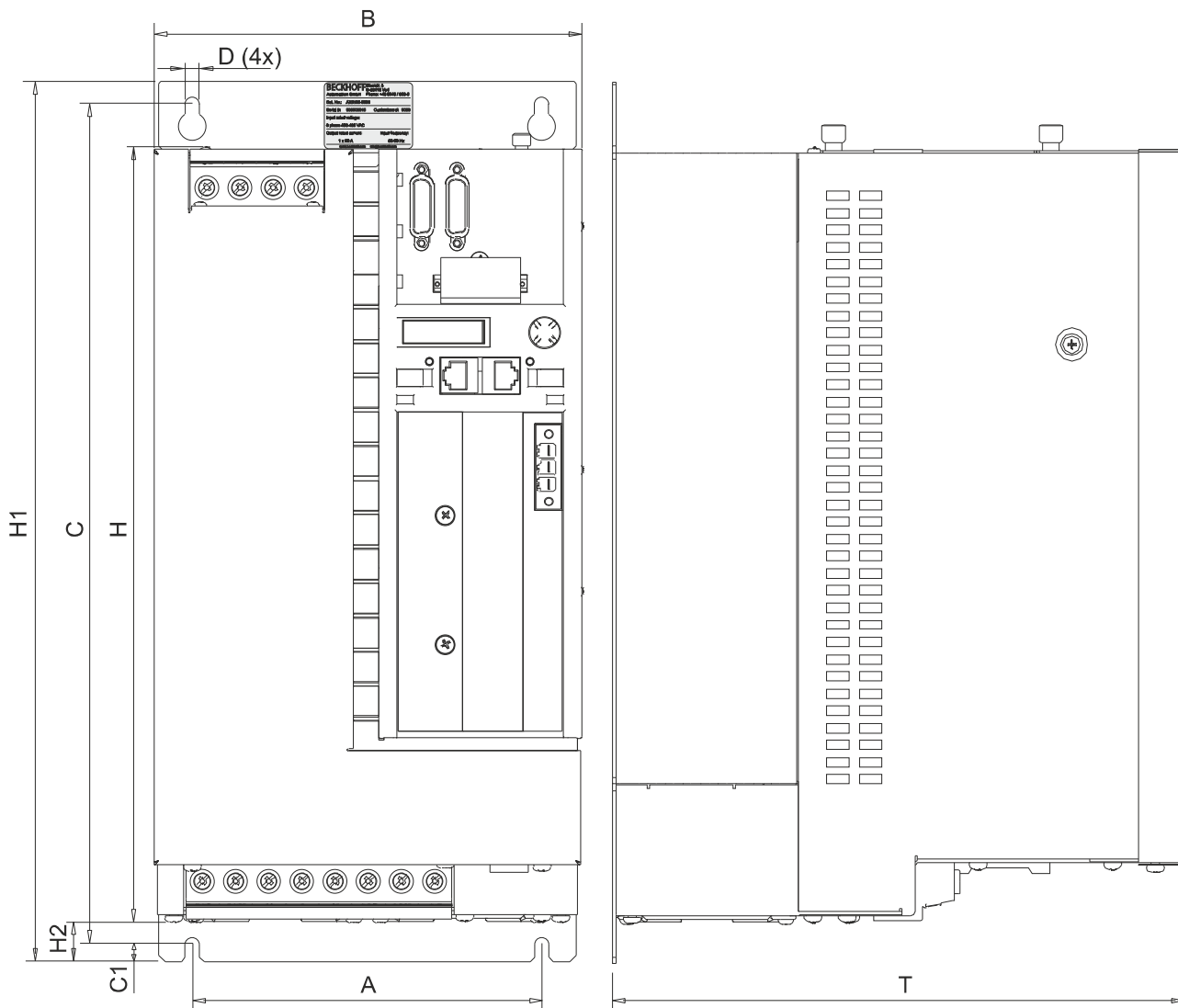

AX	A [mm]	B [mm]	C [mm]	C1 [mm]	D [mm]	H [mm]	H1 [mm]	H2 [mm]	T [mm]	Fastening screws
5160	158	190	380	8	6.5	345	398	16.5	259	4 x M5
5172	158	190	380	8	6.5	345	398	16.5	259	4 x M5
5190	200	280	582	10	9	540	603	10	254	4 x M8
5191	200	280	582	10	9	540	603	10	254	4 x M8
5192	200	280	575	10	9	540	600	20	335	4 x M8
5193	200	280	575	10	9	540	600	20	335	4 x M8

6.4 Properties

- High-speed EtherCAT system communication
- Wide voltage range: $1 \times 100_{-10\%} V_{AC} - 1 \times 240_{+10\%} V_{AC} \dots 3 \times 100_{-10\%} V_{AC} - 3 \times 480_{+10\%} V_{AC}$
- Multi-feedback interface
- flexible motor type selection
- scalable wide range motor current measurement
- High-speed capture inputs
- Diagnostic and parameter display
- integrated mains filter
- Optional safety functions: restart lock, intelligent TwinSAFE safety functions
- compact design for simple control cabinet installation
- AX-Bridge - the quick connection system for power supply, DC link and control voltage

The integrated, fast AX5000 control technology with a current control cycle of up to 62.5 μ s supports fast and highly dynamic positioning tasks. The drives are designed as single- or two-channel servo drives:

- **AX51xx: single-channel servo drive**
rated motor current: 1 A, 3 A, 6 A, 12 A, 18 A, 25 A, 40 A, 60 A, 72 A, 90 A, 110 A, 143 A, 170 A
- **AX52xx: two-channel servo drive**
rated motor current: 2 x 1 A, 2 x 3 A, 2 x 6 A (with flexible allocation of total device current on both axes)

The 2-channel servo drives with variable motor output allocation enable operation of two motors with identical or even with different capacity on a single servo drive. For example, an asynchronous motor with a rated current of 1 A and a linear motor with a rated current of 9 A can be operated with a servo drive with two 6 A channels. The total current is relevant for the device utilization.

The AX Bridge (only up to AX5140) enables convenient and fast connection of several servo drives of the AX5000 series to form a drive system. This pluggable supply and connection module combines power supply, DC link and control voltage (24 V_{DC}) and enables fast installation and commissioning.

The AX5000 offers flexible and universal connection options. It supports

- almost all feedback systems, including robust resolvers via OCT, sine/cosine encoders with EnDat, Hiperface or BiSS.
- a wide range of motor types such as asynchronous, synchronous, torque or linear motors.

6.5 Wide voltage range

In order to facilitate worldwide application with different voltage systems, the AX5000 features a wide voltage range. Virtually any voltage system can be connected with one and the same device, from $1 \times 100 V_{AC} - 1 \times 240 V_{AC}$ to $3 \times 100 V_{AC} - 3 \times 480 V_{AC}$. This reduces stock-keeping and prevents destruction through unsuitable mains voltage. Examples for different mains systems:

- $1 \times 100 V_{AC}, 3 \times 200 V_{AC}$ for Asia
- $1 \times 115 V_{AC}, 3 \times 230 V_{AC}, 3 \times 480 V_{AC}$ for North America
- $1 \times 220 V_{AC}, 3 \times 380 V_{AC}$ for China
- $1 \times 230 V_{AC}, 3 \times 400 V_{AC}$ for Europe

6.6 Variable motor interface

The AX5000 supports the connection of different motor types, ranging from standard asynchronous motors to ironless linear motors:

Motor type	Operation mode and limits
Brushless synchronous motors	<ul style="list-style-type: none"> • Servo mode with feedback
Torque motors	<ul style="list-style-type: none"> • Multipole servomotors with high torque and relatively low speed
Linear motors (iron core)	<ul style="list-style-type: none"> • Servo mode with feedback
Linear motors (ironless)	<ul style="list-style-type: none"> • Servo mode with feedback
Asynchronous motor	<ul style="list-style-type: none"> • Frequency converter mode without feedback • High-frequency spindle up to 60,000 rpm (only for devices of the AX5xxx-0000-x21x series "Dual Use [► 13]) • Servo mode with feedback

6.7 Multi-feedback interface

AX5000 offers interfaces for all common feedback systems. No additional interface cards are required.

Connection options:

- OCT One cable feedback system
- Sine / cosine 1 V_{pp}
- EnDAT, single- and multi-turn
- Hiperface, single- and multi-turn
- BiSS, single- and multi-turn
- Resolver, 2-pin - 8-pin
- Support for electronic motor name plates

7 Mechanical installation

⚠ WARNING

Caution - Risk of injury!

- The servo drives may only be installed by trained, qualified personnel. The qualified personnel must know and comply with the national accident prevention regulations.
- Safety boots must be worn.

⚠ WARNING

Caution - Risk of injury through electric shock!

De-energize all electrical components (servo drive, control cabinet, etc.) before commencing the installation or deinstallation.

NOTE

Destruction of the servo drive!

- Always install the servo drive vertically.
- Provide adequate ventilation for the servo drive. The permissible ambient conditions are specified in the chapter "Technical data".
- It is essential to adhere to the required distances (see diagrams below).

7.1 Installation examples (1.5 A - 40 A devices)

AX5000 without AX-Bridge

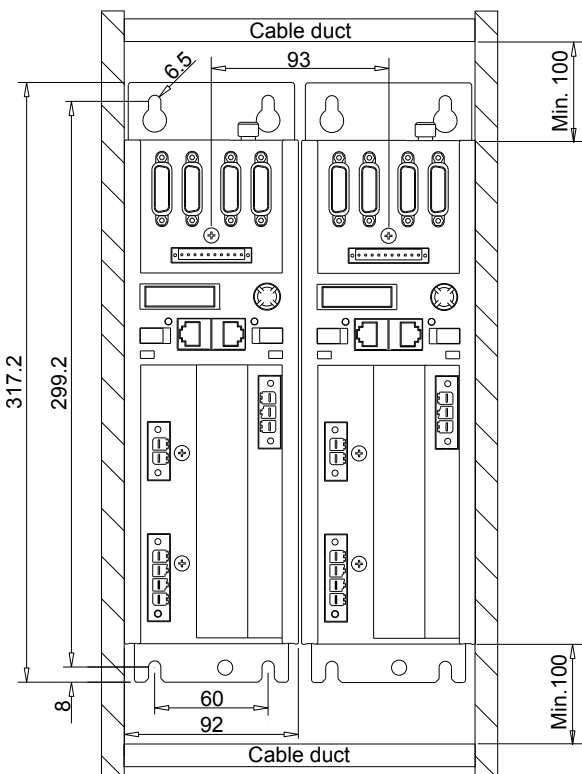

AX5000 with AX-Bridge

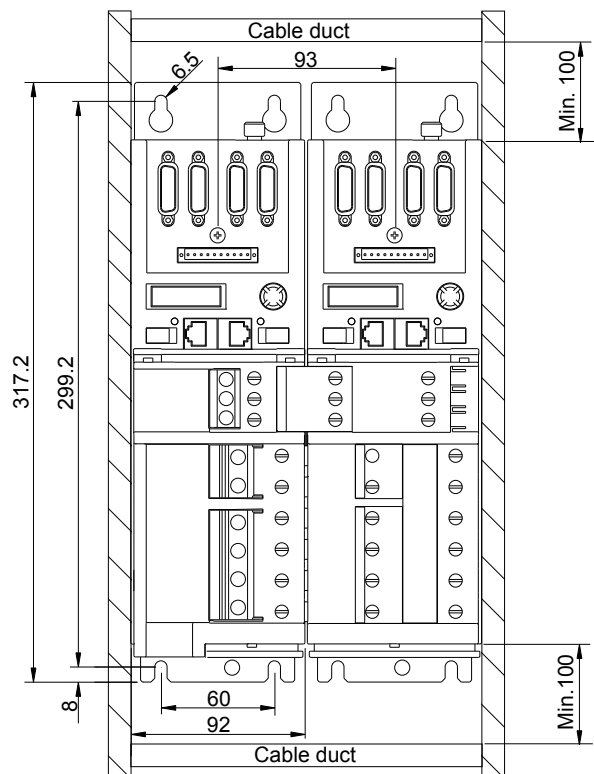

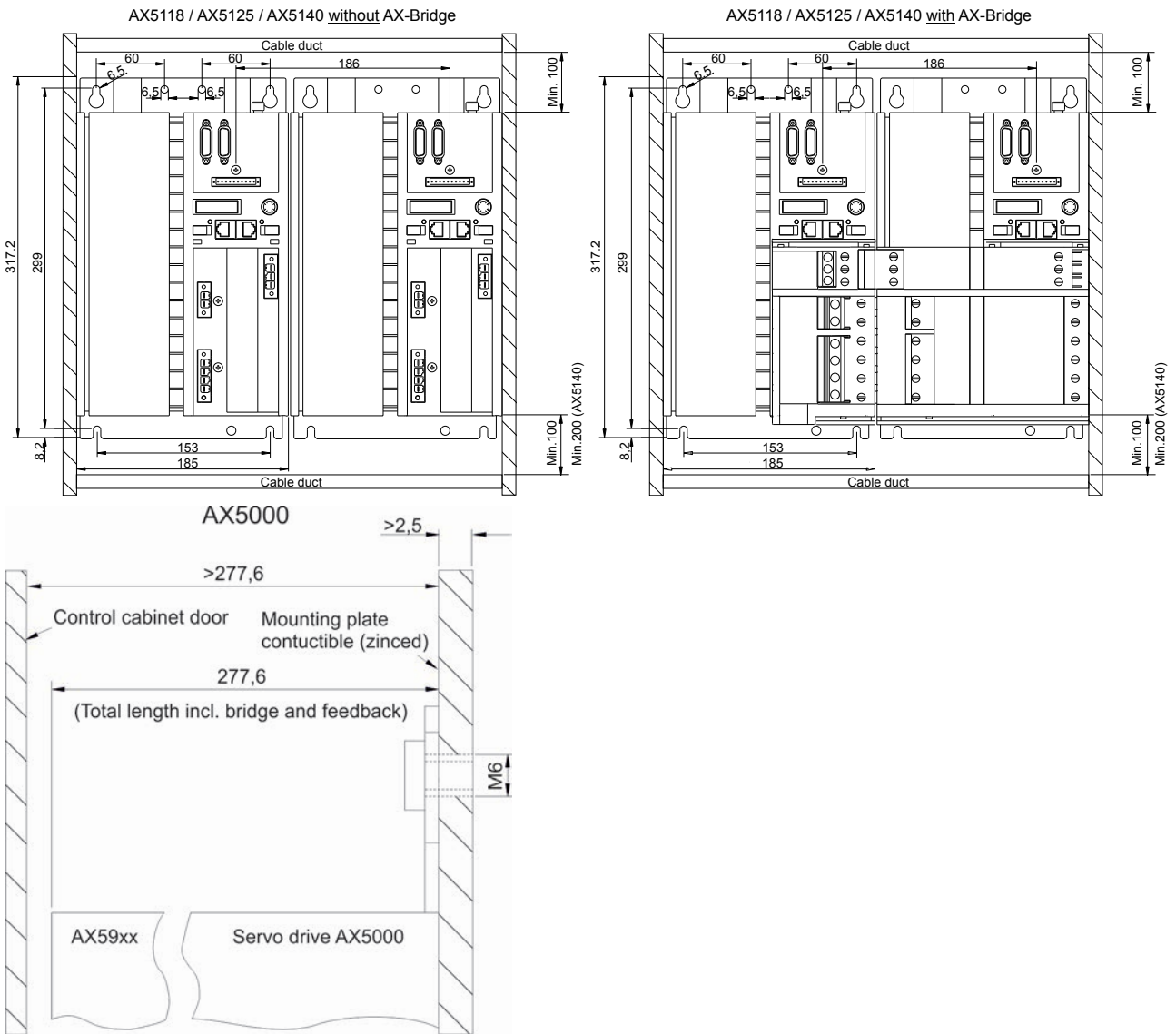

⚠ WARNING

Caution - Risk of injury through electric shock!

The mounting plate must be earthed according to the statutory regulations.

NOTE

Earthing!

Non-compliant earthing of the AX5000 can cause EMC problems.

7.2 Installation examples (60 A - 170 A devices)

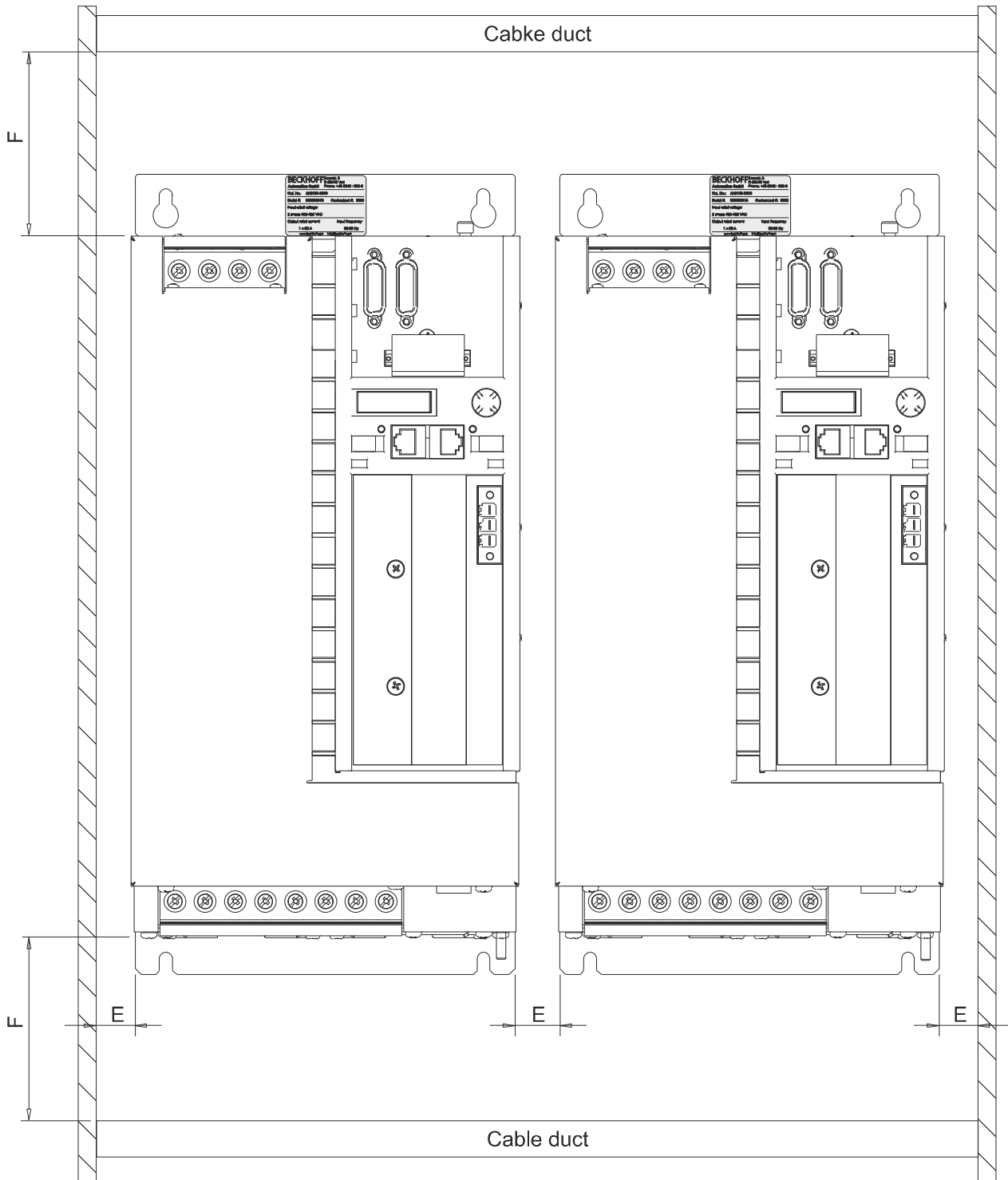

AX	F [mm]	E [mm]
5160 and 5172	≥ 180	20
5190 and 5191	≥ 180	40
5192 and 5193	≥ 180	40

Installation in the control cabinet

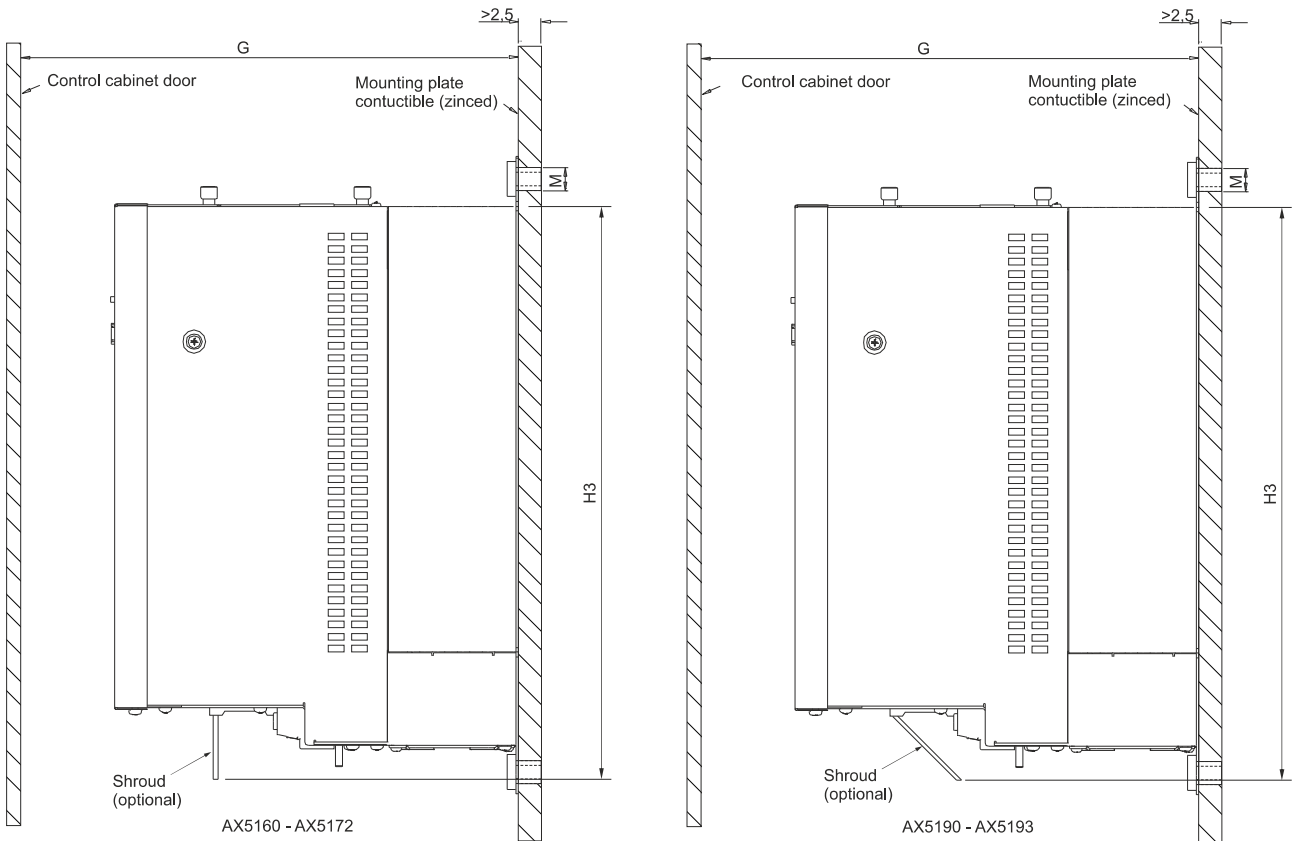

AX	G [mm]	M [mm]	H3 [mm]
5160 and 5172	≥ 300	4 x M5	445
5190 and 5191	≥ 300	4 x M8	640
5192 and 5193	≥ 500	4 x M8	640



⚠ WARNING

Caution - Risk of injury through electric shock!

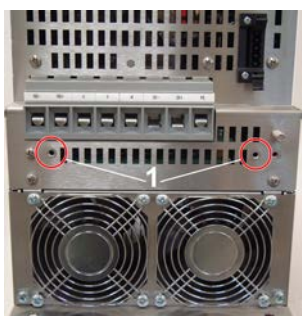

The mounting plate must be earthed according to the statutory regulations. Non-compliant earthing of the AX5000 can cause EMC problems.

Installation of the shield (optional)

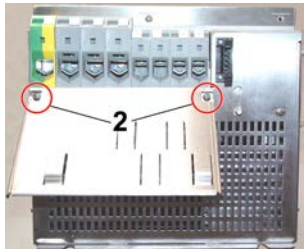

AX5160 and AX5172

Preparing for installation	Shroud mounting
 <p>1.) The threaded holes (1) for mounting of the shroud, are in the delivery state of the servo drive AX5160 / AX5172, not fitted with screws.</p> <p>Check before mounting the shroud, if the threaded holes are free of Dirt.</p>	 <p>2.) Position the shroud.</p> <p>3.) Mounted the shroud with the screws (2). Use for mounting only the screws of the shroud set. The screws are included in the shroud set.</p> <p>4.) Connect the wires to the terminals provided. Attach the shield by the tabs.</p>
 <p>Shroud set for AX5160 and AX5172 consisting of shroud and mounting screws (2 x M4 x 10).</p>	

AX5190 and AX5191

Preparing for installation		Shroud mounting	
	<p>1.) Remove the 2 pre-mounted screws.</p>		<p>2.) Position the shroud. 3.) Mounted the shroud with the screws (2). Use for mounting only the screws of the shroud set. The screws are included in the shroud set. 4.) Connect the wires to the terminals provided. Attach the shield by the tabs.</p>
	<p>Shroud set for AX5190 and AX5191 consisting of shroud and mounting screws (2 x M4 x 10).</p>		

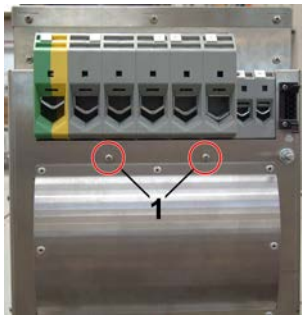
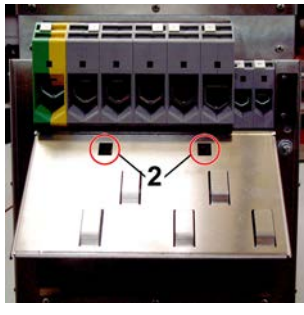
AX5192 and AX5193

Preparing for installation		Shroud mounting	
	<p>1.) Remove the 2 pre-mounted screws.</p>		<p>2.) Position the shroud. 3.) Mounted the shroud with the screws (2). Use for mounting only the screws of the shroud set. The screws are included in the shroud set. 4.) Connect the wires to the terminals provided. Attach the shield by the tabs.</p>
	<p>Shroud set for AX5192 and AX5193 consisting of shroud and mounting screws (2 x M4 x 10).</p>		

8 Electrical installation



UL approval

If you intend to operate an AX5000 in a region that requires UL approval, please refer to the chapter "Guidelines and Standards".

⚠ WARNING

Caution - Risk of injury!

- The servo drives may only be installed by trained, qualified personnel. The qualified personnel must know and comply with the national accident prevention regulations.
- Safety boots must be worn.

⚠ WARNING

Caution – Risk of injury through electric shock!

De-energize all electrical components (servo drive, control cabinet, etc.) before commencing the installation or deinstallation.

⚠ DANGER

Serious risk of injury through electric shock!

Due to the DC link capacitors dangerous voltage may persist at the DC link contacts "X02" after the servo drive has been disconnected from the mains supply. Wait 5 minutes after disconnection and measure the voltage on the DC link contacts DC+ and DC-. The device is safe once the voltage has fallen below 50 V.

⚠ WARNING

Caution – Risk of injury through electric shock!

- Before installation, wiring and commissioning it is essential to read the section on "Safety".
- Before installing, uninstalling or connecting the servo drive and the motors please note the following: - Remove all relevant mains fuses. - Switch off the main system switch and secure it with a lock. - Put up a warning sign.
- The control and power connections for the motors may be live, even if the motor is prevented from rotating by the internal brake.

⚠ CAUTION

Destruction of the AX5000!

- Check the rated voltage and current of the servo drive and the connected motors.
- Once the AX5000 has been disconnected from the mains supply, (emergency off, mains contactor etc.), wait at least 3 minutes before switching it on again or query the status of IDN "P-0-0205" (see "IDN description" in the documentation).

8.1 Connection of several servo drives to form a drive system

NOTE

Destruction of the equipment!

- The connection sequence of the devices is **not** arbitrary. The total rated current of the device must decrease from the power supply. AX5112-AX5106-AX5203-AX5201 = OK AX5201-AX5112-AX5203 ≠ OK
- All devices in a drive system are always to be disconnected from and reconnected to the mains supply together (emergency stop, mains contactor etc.).

⚠ CAUTION

Danger for persons and equipment

Note the total rated current of the connected devices. According to CE, the current carrying capacity of the power busbars of the AX Bridge is limited to 85 A.

NOTE

Destruction of the external brake resistor!

An external brake resistor may not be connected to the X02 terminal point (DC link) in a drive system. Use an external brake module AX5021 for this.

8.1.1 Connection example - module AX5901 and AX5911 (AX Bridge)

This connection option enables a safe system to be set up very quickly. The modules are attached to plug contacts X01, X02 and X03, the relevant slides are pushed to the left and screwed tight. According to CE, the current carrying capacity of the power busbars of the AX Bridge is limited to 85 A.

⚠ CAUTION

Risk of injury due to electric shock!

Move all busbar sliders to the left limit stop in order to ensure full current carrying capacity. Then tighten all screws with a torque of 2.2 Nm.

⚠ CAUTION

Personal injuries!

Please ensure that the connection line for the AX5901 supply module is adequately dimensioned. The dimensioning depends on the total rated current and must comply with EN60204-1. A 3-phase connection must be used if the total rated current exceeds 9 A.

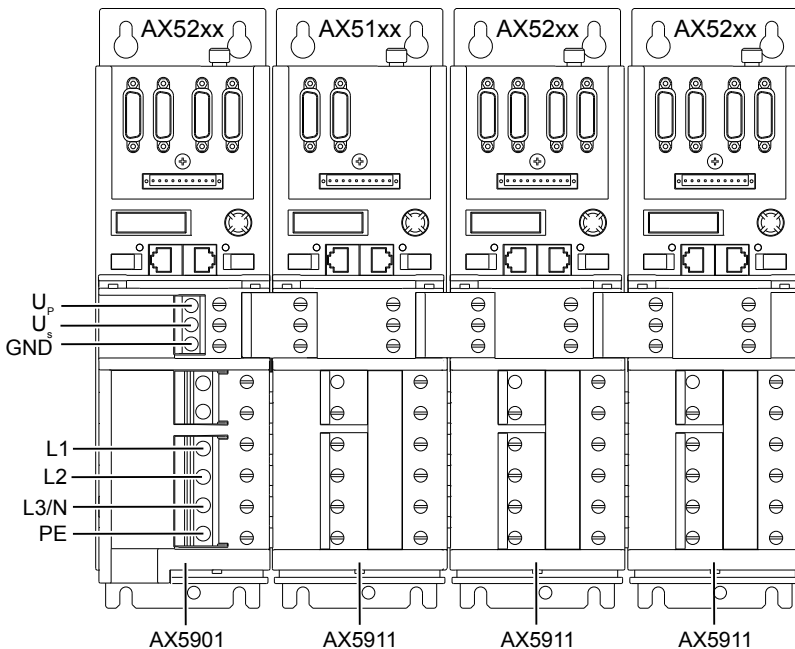

AX5901 (AX520x and AX5101 - AX5125)

Terminal points	Conductor design	Max. conductor cross-section	Tightening torque
L1-L3, PE	solid wire	10 mm ² , AWG 7	2.2 Nm
	stranded wire with ferrule	16 mm ² , AWG 5	2.2 Nm
	stranded- / multi-wire	25 mm ² , AWG 3	2.2 Nm

AX5902 (AX5140)

Terminal points	Conductor design	Max. conductor cross-section	Tightening torque
L1-L3, PE	solid wire	16 mm ² , AWG 5	3.2 ± 0.8 Nm
	stranded wire with ferrule	16 mm ² , AWG 5	3.2 ± 0.8 Nm
	stranded- / multi-wire	25 mm ² , AWG 3	3.2 ± 0.8 Nm

8.1.2 Connection example - wiring in series without AX bridge

Wire the relevant connections using individual cables.

⚠ CAUTION

Damage to persons and devices!

- Please ensure that the final supply network connection cable is adequately dimensioned. The dimensioning depends on the total current and must comply with EN60204-1.
- To establish a DC link system wire the X02 connections with a suitable cable. Voltages up to 890 V may be present.
- The connectors are designed for a maximum current of 41 A and a maximum conductor cross-section of 6 mm².
- Avoid phase reversal between the devices!

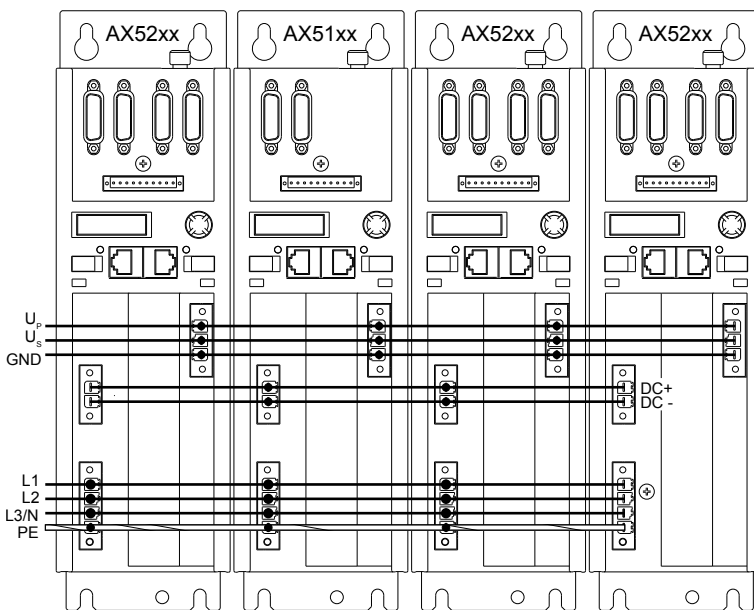

i No UL drive system!

The following figure shows an AX wiring in series configuration without AX Bridge. To configure a UL drive system, please refer to the information in chapter 9.1.3 "UL drive system – configuration example".

8.1.3 Connection example – DC link group (60 A to 170 A devices)

This connection technique enables you to establish a DC link group for servo drives from the series AX5160 to AX5193

The following illustration shows a possible configuration example.

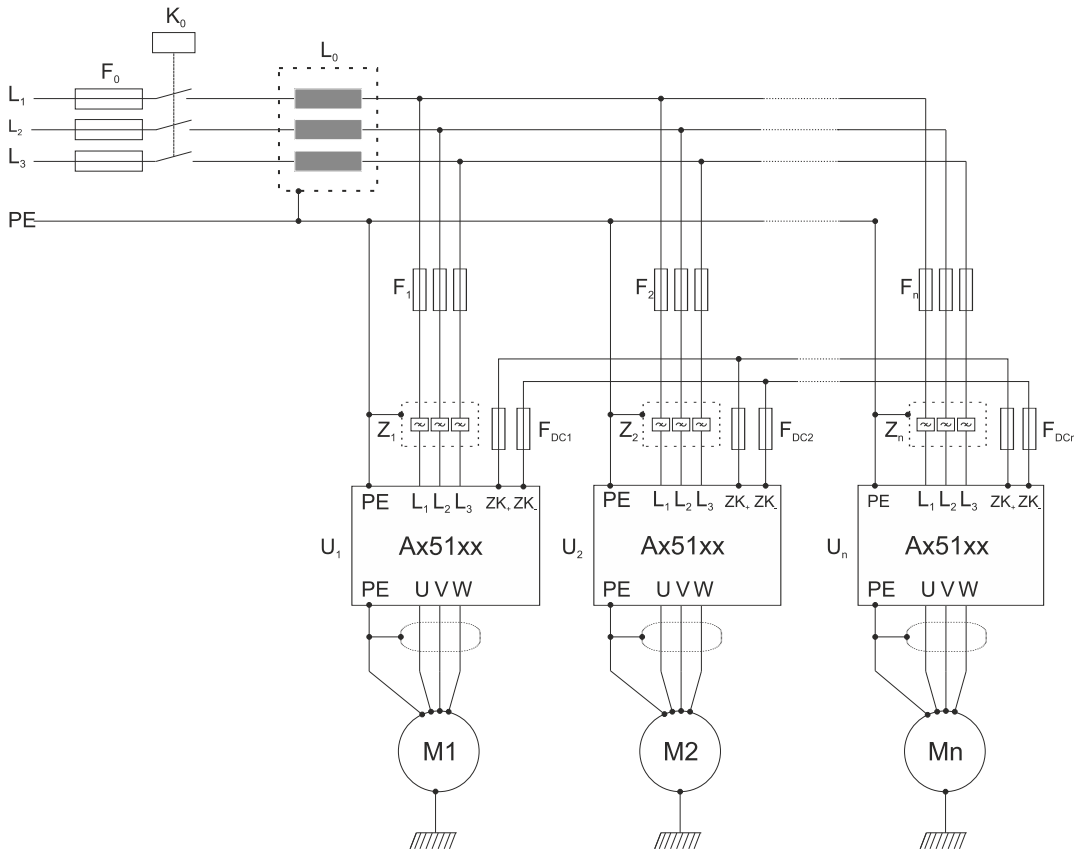

Key to picture:

- F_{0-n} = Mains fuses = UL fuse (480 V_{AC})
- $F_{DC1-DCn}$ = DC link fuses (DC fuses) = UL fuse (700 V_{AC} / 800 V_{DC})
e.g. ferrule FWP from Cooper-Bussmann
- K_0 = Common mains contactor
- L_0 = Mains choke
- Z_{1-n} = Mains filter (optional)

	<p>Drive system with UL approval!</p> <p>Before implementation a DC link group, please contact your UL approval body and discuss further necessary boundary conditions.</p>
---	--

Dimensioning of the UL fuses F_{DC1} - F_{DCn}

The dimensioning of the fuses F_{DC1} to F_{DCn} in the DC link is application-dependent. The motor and the load profile are incorporated directly into the calculation. Please consider this when dimensioning.

	<p>Fuse holders with UL approval</p> <p>Note when using UL fuses that the necessary fuse holders also have to carry UL approval.</p>
---	---

Mains choke

To ensure balancing of all servo drives, a common mains choke (L_o) must be provided. The rated current of the mains choke must be \geq the rated current of the common mains fuse (F_o) of the drive system (see section "Mains fuse"). The short-circuit voltage U_k of the mains choke must be 2%

Dimensioning the mains fuse

The following section describes the dimensioning of the mains fuse to be used for individual devices and the use of mains fuses in the DC link group.

Series AX5160 to AX5193 (60 A to 170 A):

Individual device:

- The main fuse must be dimensioned such that it corresponds to the rated current of the servo drive multiplied by the correction factor 1.1. The value determined is rounded up to the next larger standard step (see section [Electrical Data \[▶ 36\]](#)). If the size of the current (in your application) on the mains side is known, the mains fuse can also be dimensioned smaller in accordance.
- The cross-section of the mains supply cable must be dimensioned such that the permissible current load of the cable is \geq the rated current of the selected mains fuse (see section [Motors and Cables \[▶ 107\]](#)).

DC link group:

- The common main fuse (F_o) must be dimensioned such that it corresponds to the sum of all the rated currents of the servo drives multiplied by the correction factor 1.1. The value determined is rounded up to the next larger standard step (see section dimensioning example). If the size of the current (in your application) on the mains side is known, the mains fuse (F_o) can also be dimensioned smaller in accordance.
- The cross-section of the mains supply cable must be dimensioned such that the permissible current load of the cable is \geq the rated current of the selected mains fuse.
- The cross-section of the mains supply cable and the mains fuses (F_1 to F_n) of the individual servo drives in the DC link group are to be selected analogously to the operation of the individual servo drives (see section "Individual devices").

The local regulations and the local conditions (ambient temperature, cable routing, etc.) must be referred to when determining the permissible current load of the cables (selection of the necessary cross-section – see section [Motors and Cables \[▶ 107\]](#)).

Dimensioning example:

$$\begin{array}{rclclclcl}
 1 \times \text{AX5172} & + & 2 \times \text{AX5192} & + & 1 \times \text{AX5193} & & & \\
 72 \text{ A} & + & 286 \text{ A} & + & 170 \text{ A} & = & 528 \text{ A} \times 1.1 = 581 \text{ A} & \quad \mathbf{630 \text{ A selected}}
 \end{array}$$

Mains switch-on conditions:

The mains must be switched through to all servo drives simultaneously. Therefore, use a common mains contactor (K_0) for all servo drives. The phase error detection (grid monitoring) of the servo drives must be active. Observe the relevant parameterization for this (P-0-0204 Disable U_{main} monitoring and U_{main} phase error detection).

Parameterization P-0-0204:

The default values of the parameter P-0-0204 (Power management control word) are set to:

- Disable U_{main} monitoring = 0 and
- U_{main} phase error detection = 1.

In the DC link group the default values of the parameter P-0-0204 are to be checked before commissioning and set to the above values if discrepancies are found.

Parameterization P-0-0214:

To parameterize an AX5160 to AX5193 DC link group, the following settings must be made in parameter P-0-0214 (DC link connection mode):

- The value 0x000A sets the servo drives AX5160 to AX5193 to stand-alone mode
- The value 0x000B sets the servo drives AX5160 to AX5193 to DC link group mode

The external brake resistor is activated in both cases.

Mains filter:

If mains filters are used, a separate mains filter must be used for each servo drive. The mains filter must be positioned as close to the servo drive as possible. Use short cables without loops.

A suitable shield connection is ensured by adhering to the following points:

- The mounting plate must not be painted. The shield is automatically connected via the mounting plate.
- If the mounting plate is painted, the shield must be connected via the underside of the servo drive (earthing bolt).

Max. cable sizes accepted by the connecting terminals:

The maximum cable cross-sections are dictated by the maximum cable sizes that can be accepted by the connecting terminals on the servo drive (see table below):

Device type	Mains terminal		Motor terminal		DC link terminal		R_b terminal	
	min. [mm ² / AWG]	max. [mm ² / AWG]	min. [mm ² / AWG]	max. [mm ² / AWG]	min. [mm ² / AWG]	max. [mm ² / AWG]	min. [mm ² / AWG]	max. [mm ² / AWG]
AX5160	4 / 12 ¹	35 / 2	4 / 12	35 / 2	4 / 12	35 / 2	4 / 12	35 / 2
AX5172	4 / 12	35 / 2	4 / 12	35 / 2	4 / 12	35 / 2	4 / 12	35 / 2
AX5190	25 / 4	95 / 2/0	35 / 2	95 / 3/0	25 / 6	50 / 2/0	25 / 6	50 / 2/0
AX5191	25 / 4	95 / 2/0	35 / 2	95 / 3/0	25 / 6	50 / 2/0	25 / 6	50 / 2/0
AX5192	25 / 4	95 / 2/0	150 / 300		150 / 300		25 / 6	50 / 2/0
AX5193	25 / 4	95 / 2/0	150 / 300		150 / 300		25 / 6	50 / 2/0

Dimensioning of the brake resistors for operation in the DC link group:

In individual braking situations the energy balance in the DC link group can be generative. Servo drives from the series AX5160 to AX5193 have no internal brake resistor. External brake resistors must be used to dissipate the energy generated. The brake resistor must always be connected to the connector provided on the servo drive.

Under the following conditions it is possible to dispense with one or more brake resistors:

- the remaining brake resistors must be able to handle the continuous power
- the remaining brake resistors must be able to handle the short-term power
- the ohmic value of the brake resistor for each servo drive must not be lower than the minimum permissible value.

Part of the brake energy is also stored in the DC link, independent of the brake resistor. The more servo drives there are in the DC link group, the larger the storage capacity. It is therefore possible to store more energy.

The following must be considered when dimensioning the brake resistors:

- The external brake resistor must have an ohmic value that is at least as large as the minimum value permitted by the servo drive.

Servo Drives	AX5160	AX5172	AX5190	AX5191	AX5192	AX5193
Min. brake resistor (external brake resistor)	13 Ω	13 Ω	10 Ω	10 Ω	6.5 Ω	6.5 Ω

- The peak braking power of the DC link group is given by the sum of the peak braking powers of all the brake resistors in the DC link group:

$$P_{peak_Br_DC} = P_{peak_R1} + P_{peak_R2} + \dots + P_{peak_Rn}$$

- The continuous braking power is derived from the calculation of the effective braking power:

$$P_{eff_Br_DC} = P_{eff_R1} + P_{eff_R2} + \dots + P_{eff_Rn}$$

where:

$P_{peak_Br_DC}$	is the peak braking power of the entire DC link group and
$P_{eff_Br_DC}$	is the effective braking power of the entire group

DC link group with other AX5000 servo drives:

● No DC link group permissible with devices for 1.5 A to 40 A!

i Servo drives from the series AX5101 to AX5140 are excluded from the DC link group with servo drives from the series AX5160 to AX5193 and may NOT be connected to one another! The DC link group described here is permissible only for AX5160 to AX5193 servo drives!

8.1.4 UL drive system - configuration example

	<p>Drive system with UL approval!</p>
<p>The following illustration shows a possible configuration example. Before implementation, please contact your UL approval body and discuss further necessary boundary conditions.</p>	

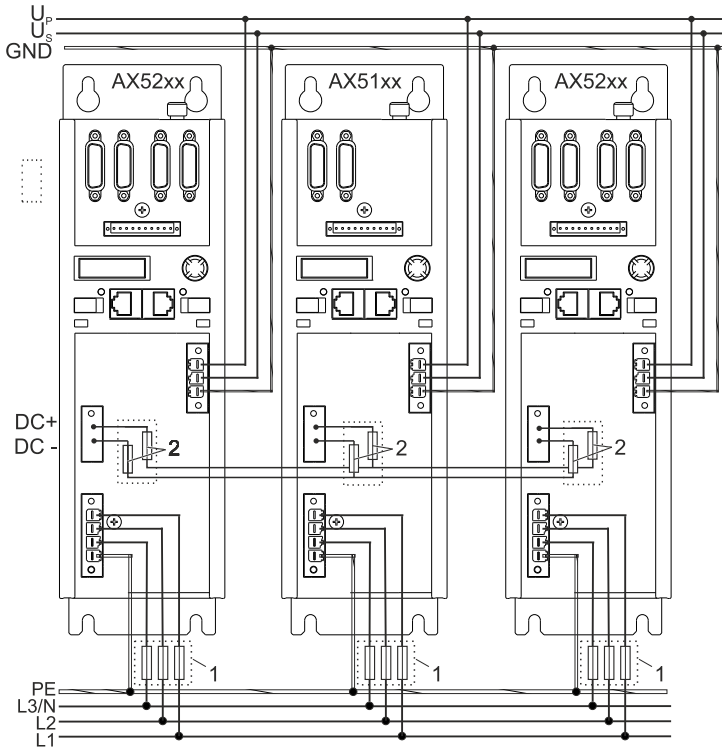

Legend:

1 = UL fuse (480 VAC)

2 = UL fuse (700 VAC / 800 VDC) e.g. Ferrule FWP from Cooper-Bussmann

	<p>Fuse holders with UL approval</p>
<p>Note when using UL fuses that the necessary fuse holders also have to carry UL approval.</p>	

8.2 Connection example AX5101 - AX5112 and AX520x

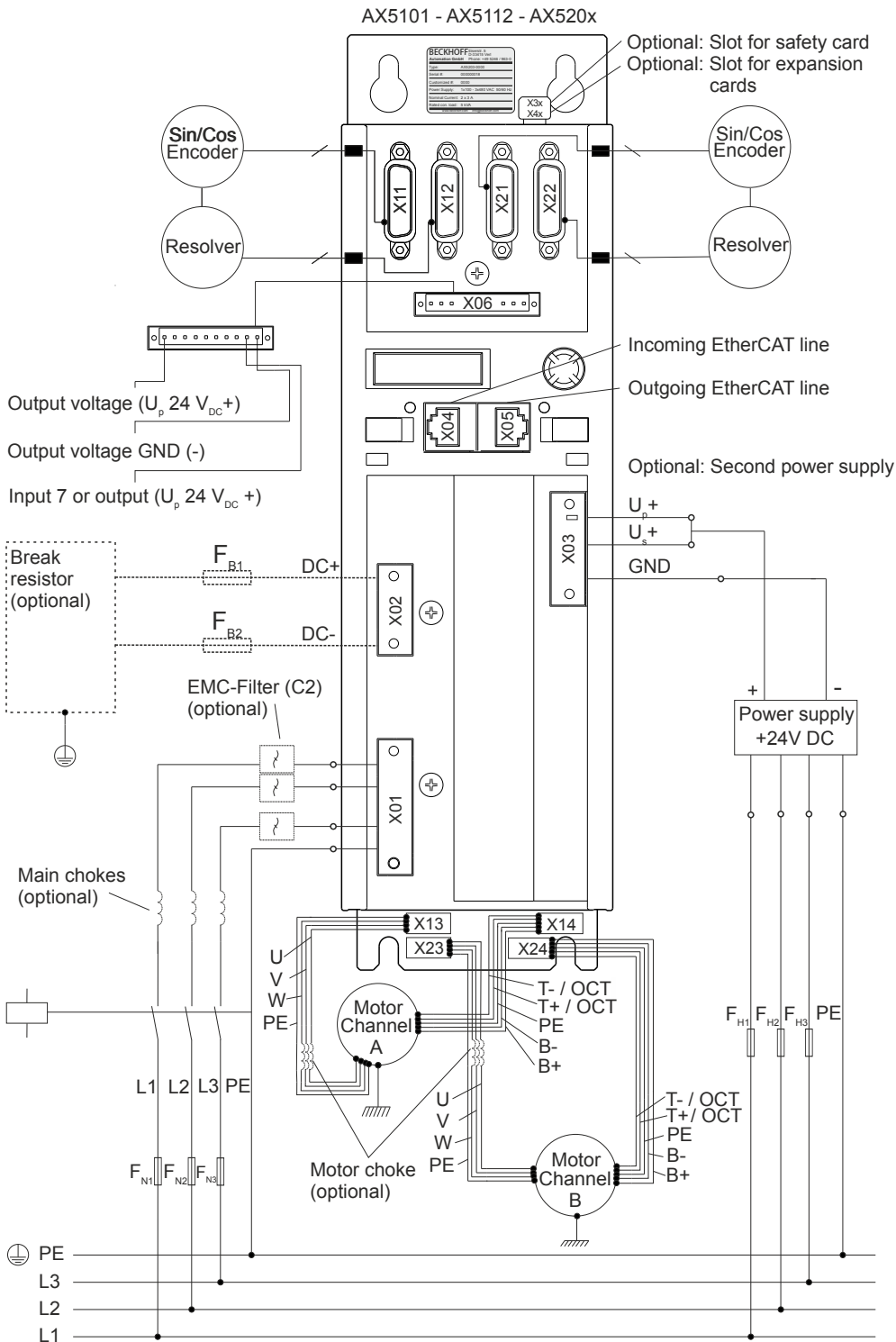

8.3 Connection example AX5118 - AX5125 and AX5140

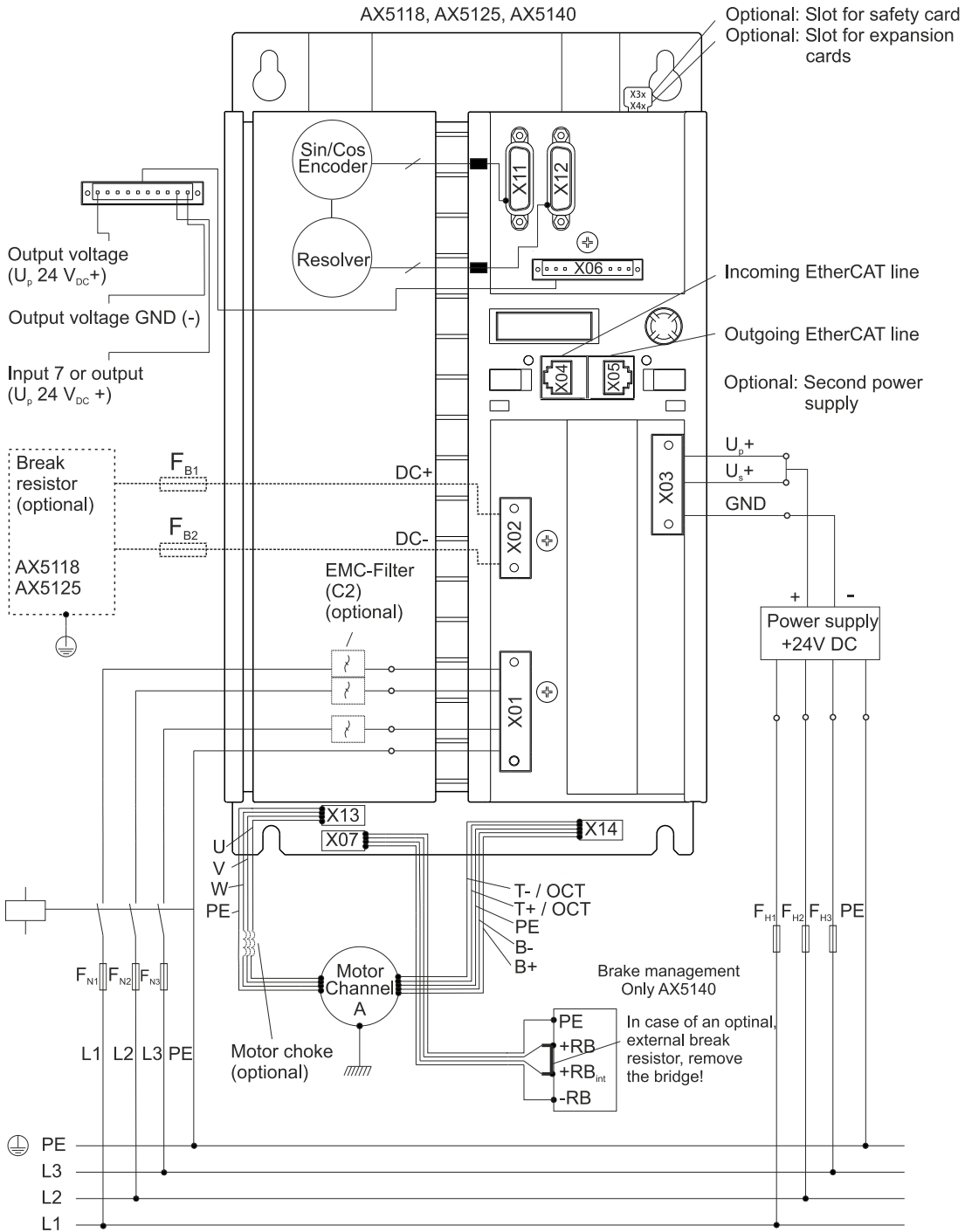

8.4 Connection example AX5160 - AX5172

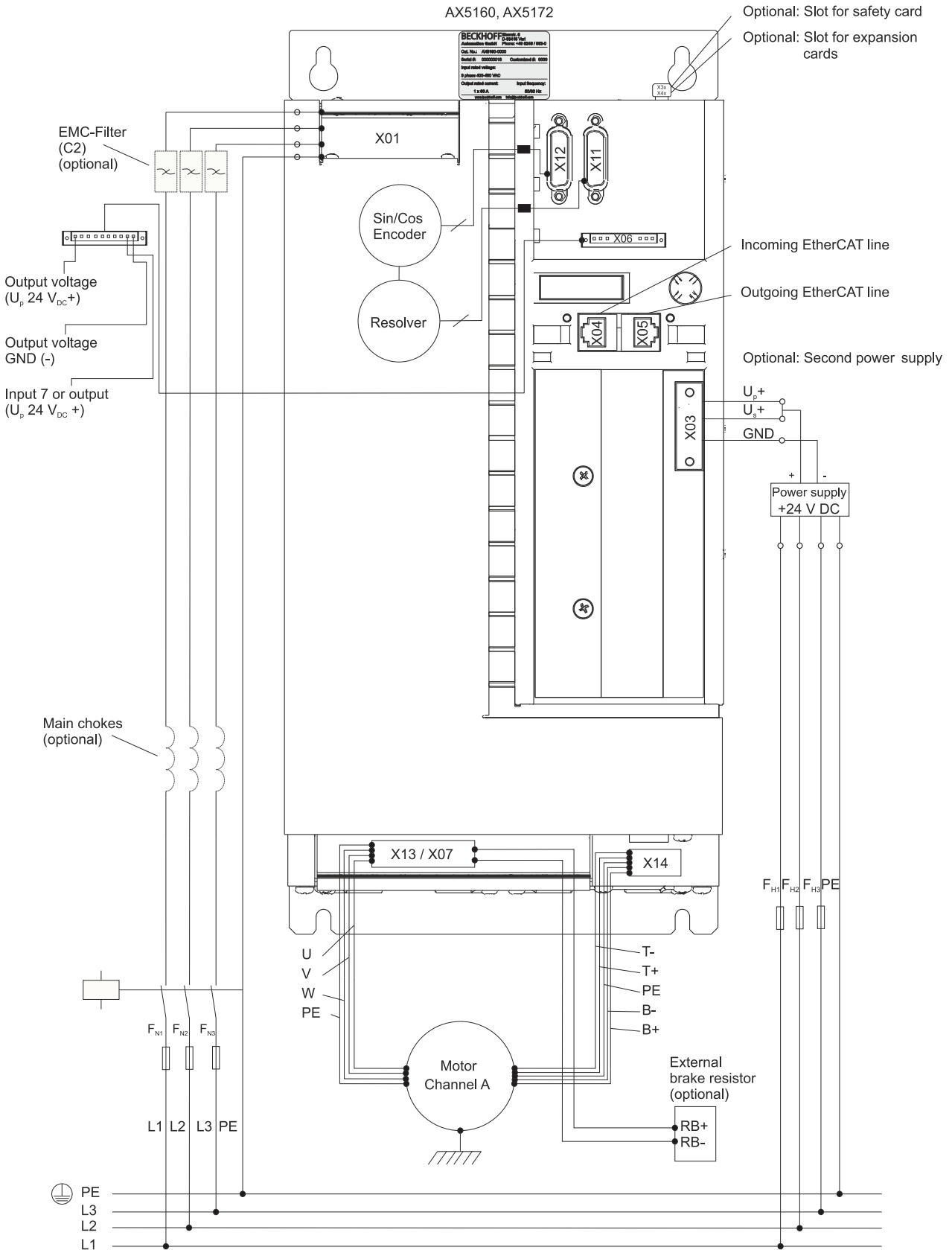

8.5 Connection example AX5190 - AX5191

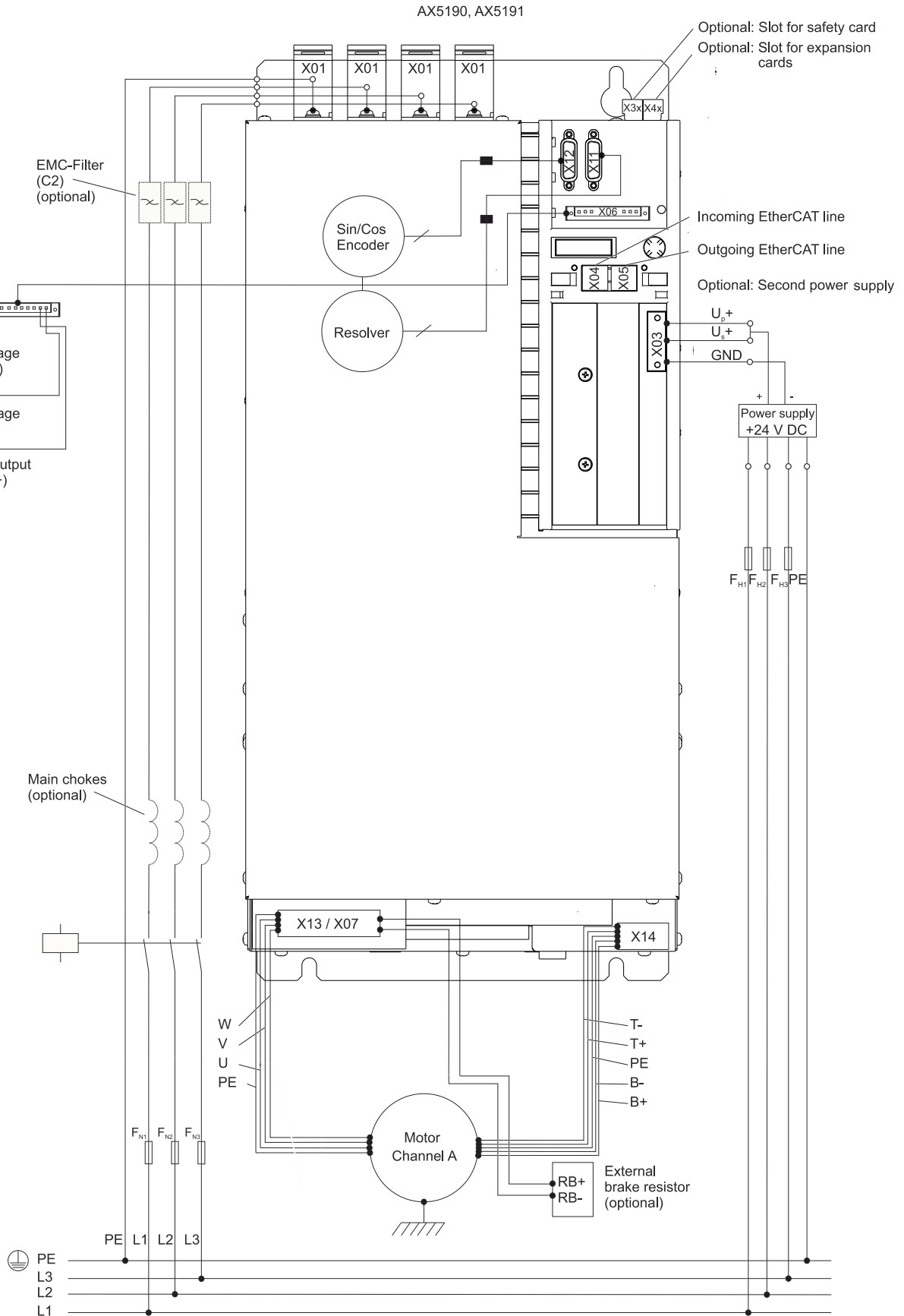

8.6 Connection example AX5192 - AX5193

AX5192, AX5193

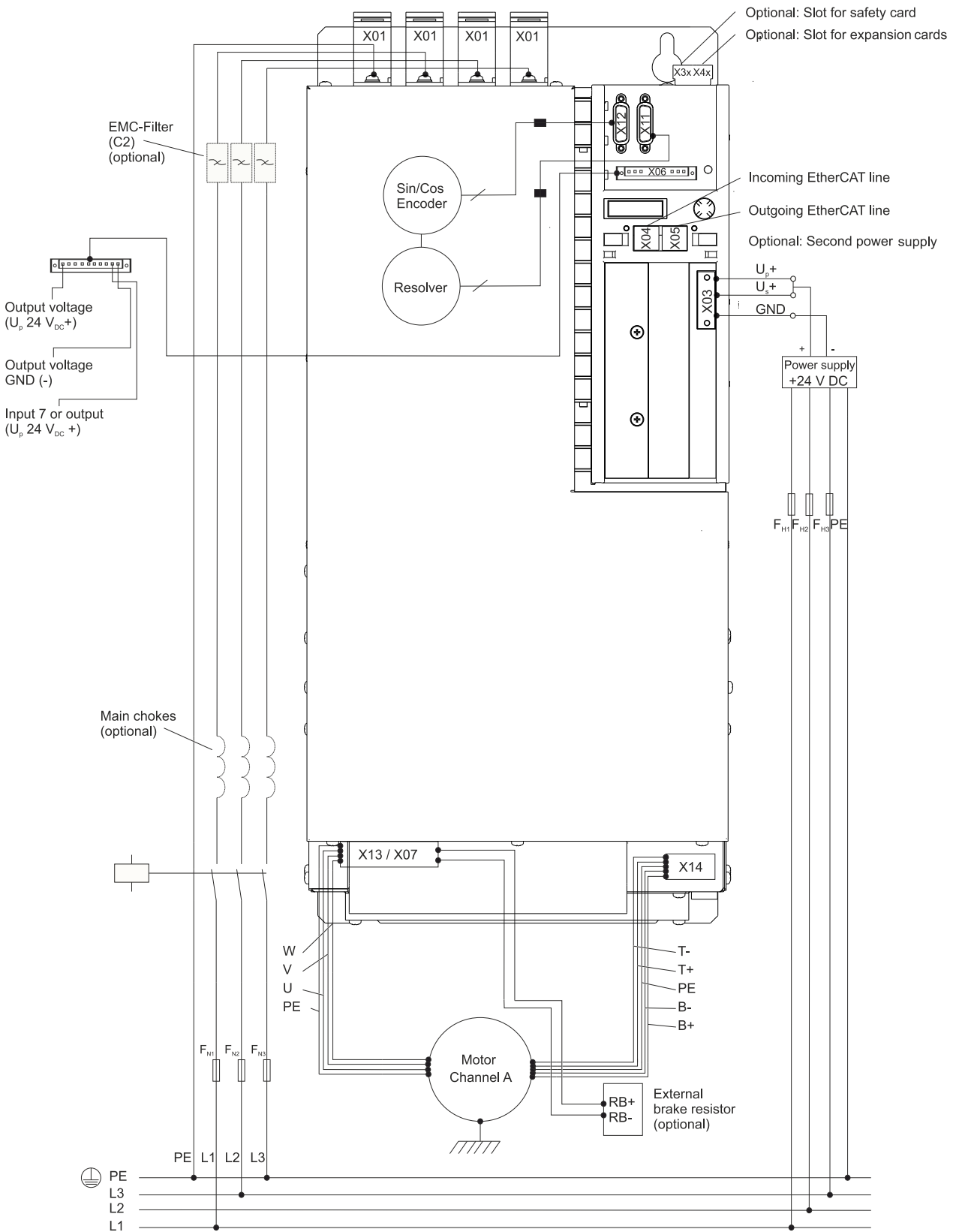

8.7 Power supply (1.5 A - 40 A devices)

⚠ WARNING

Caution - Risk of injury!

The electrical installation must be carried out by a qualified electrician. Before installing and commissioning AX5000 servo drives please read the safety notes in the foreword of this documentation.

NOTE

Destruction of the AX5000!

The connection sequence of the devices is not arbitrary. The total rated current of the device must decrease from the power supply. The order "AX5112-AX5106-AX5201-AX5103" is correct; the order "AX5201-AX5112-AX5203" is wrong.

⚠ CAUTION

Personal injuries!

Note the total current of the connected devices. According to CE the current carrying capacity of power busbars is limited to 85 A.

⚠ CAUTION

Personal injuries!

Please ensure that the connection line for the AX5901 supply module is adequately dimensioned. The dimensioning depends on the total rated current and must comply with EN 60204-1. The connector plugs are designed for a maximum conductor cross-section of 25 mm². A 3-phase connection must be used if the total rated current exceeds 9 A.

⚠ CAUTION

Personal injuries!

To set up a drive system without AX5901 supply module and AX bridge please note the following: The connector plugs of the wide voltage input are designed for a maximum current of 41 A and a maximum conductor cross-section of 6 mm². The cable configuration must comply with the requirements specified in DIN VDE 0298 Part 4 / 2003-08 and EN 60204-1. Avoid phase reversal between the devices!

8.7.1 X01: Main supply connection



UL Listing

It is essential to observe chapter "Guidelines and Standards" if you wish to operate an AX5000 in an economic area that requires a UL-Listing.

Voltage systems ranging from single-phase 100 V_{AC} to three-phase 480 V_{AC} can be connected to the wide voltage input of the AX5000 . In single-phase systems the mains phase is connected to terminal point L1 and the neutral conductor to terminal point L3/N.

	Terminal point	Connection		Tightening torque
		3-phase	1-phase	
	L1	Phase L1	Phase L1	0,5 - 0,6 Nm
	L2	Phase L2	not used	
	L3/ N	Phase L3	Neutral conductor	
	PE	Protective conductor	Protective conductor	

Connection to the standard mains supply (TT / TN) with earthed centre

Single phase 100_{-10%} - 240_{+10%} V_{AC}, 50/60 Hz

Three phase 100_{-10%} - 480_{+10%} V_{AC}, 50/60 Hz

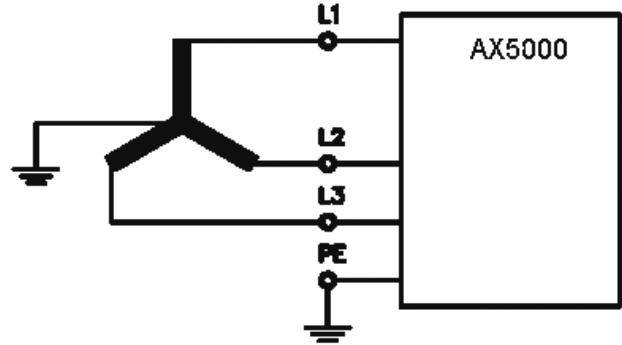
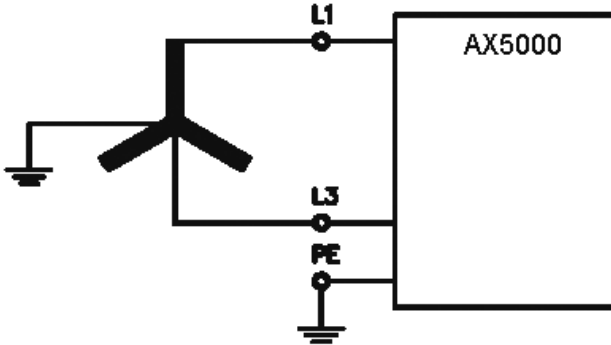

Connection to a IT-mains supply (100 - 240 V) without isolating transformer

NOTE

EMC Act in europe!

Due to electromagnetic emission, in Europe the AX5000 must be operated in conjunction with an isolating transformer

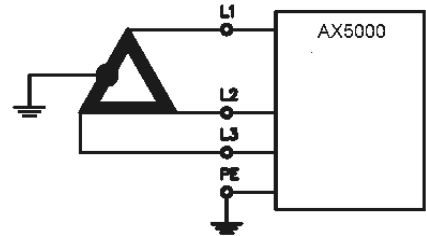
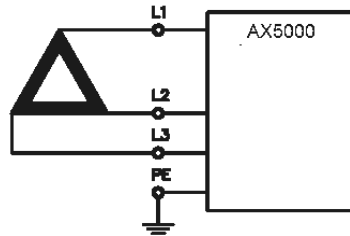
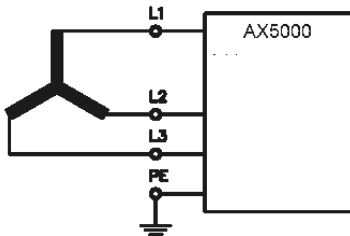

Connection to other mains types (100 - 240 V) without isolating transformer

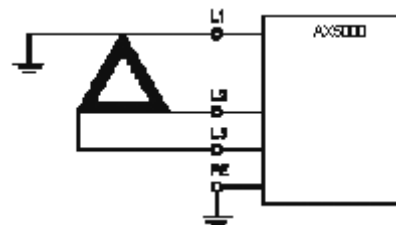
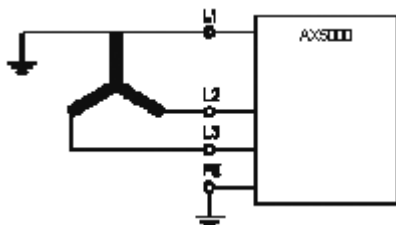

Connection to other mains types (100 - 480 V) with isolating transformer

NOTE

Destruction of the AX5000!

For asymmetrically earthed or non-earthed 100...480 V mains an isolating transformer must be used.

100 - 480 V Isolating transformer

240 - 480 V Isolating transformer

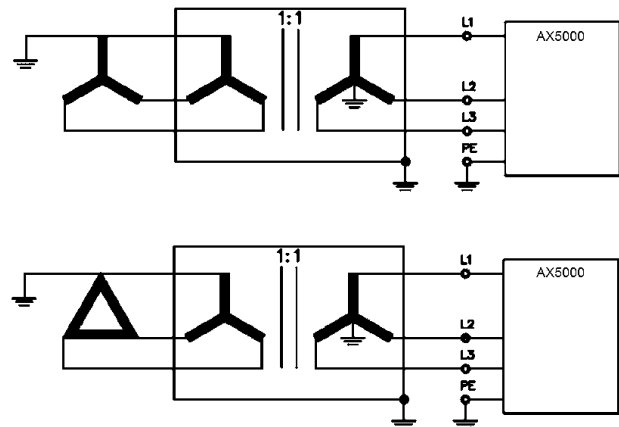
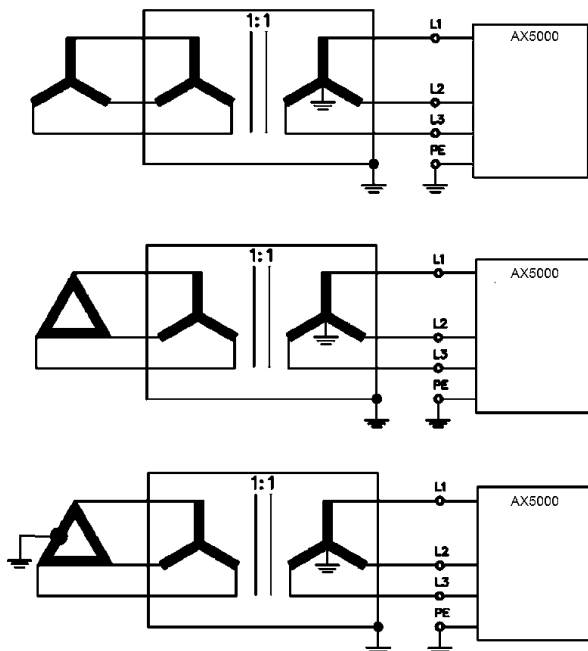

8.7.2 Fuse protection

External protection, CE-compliant

⚠ WARNING

Fire hazard due to overload of the connection cable!

- The following data refer to stand-alone devices. Please note the total current of all connected devices in a multi-axis system.
- The recommended fuses are designed for line protection. The servo drives feature integrated self-protection.

Single-phase:

	AX5101	AX5103	AX5106	AX5201	AX5203	AX5206
AC supply *)	10 AT	10 AT	16 AT	10 AT	16 AT	20 AT
24 V supply	5 AT					
Brake resistor	electronic					

*) Application class "gG" mains fuses according to IEC 60269 or "C" type automatic circuit-breakers must be used.

Three-phase:

	AX5101	AX5103	AX5106	AX5112	AX5118	AX5125	AX5140	AX5201	AX5203	AX5206
AC supply *)	6 AT	6 AT	10 AT	20 AT	35 AT	35 AT	50 AT	10 AT	10 AT	20 AT
24 V supply	5 AT									
Brake resistor	electronic									

*) Application class "gG / gL" mains fuses according to IEC 60269 or "C" type automatic circuit-breakers must be used.

Internal protection, CE-compliant

Circuit	Fuse
24 V system voltage	3.4 AF
24 V peripheral voltage	electronic
Brake resistor	electronic

External protection, UL-compliant

The integrated protection against short circuit is no substitute for the external mains protection. The mains protection must comply with the manufacturer's specification and the national and international regulations and laws.

Can be used in power supply systems with a maximum current carrying capacity of 18000 A at 480 V.

Single-phase:

	AX5101	AX5103	AX5106	AX5201	AX5203	AX5206
AC supply (max.) *)	6 A	12 A	20 A	12 A	20 A	20 A
24 V supply (max.)	3 A					
Brake resistor	electronic					

*) UL-approved mains fuses of class "RK5" must be used.

Three-phase:

	AX5101	AX5103	AX5106	AX5112	AX5201	AX5203	AX5206
AC supply (max.) *)	6 A	12 A	20 A	20 A	12 A	20 A	20 A
24 V supply (max.)	3 A						
Brake resistor	electronic						

*) UL-approved mains fuses of class "RK5" must be used.

	<p>AX5112!</p> <p>Protection through UL-approved fuses of class "RK5" with a rated current of 20 A and 480 V min.</p>
---	--

Internal protection, UL-compliant

Circuit	Fuse
24 V system voltage	3.4 AF
24 V peripheral voltage	electronic
Brake resistor	electronic

External drive system protection

Rule of thumb: Determine the total rated device currents, multiply with the correction factor and round up to the next higher standard level.

Sample: 1 x AX5103 + 2 x AX5201 + 2 x AX5203
 3 A + 6 A + 12 A = 21 x 1.1 = 23.1 A --> **selected 25 A**

	<p>Special requirements for a drive system</p> <p>Please consult our Application Department with respect to the special requirements for a drive system with UL approval.</p>
---	--

Residual current circuit breaker

Servo drives with built-in mains filters generate a small leakage current (fault current) due to the capacitors in the filter. This fault current is responsible for malfunctions in standard residual current circuit breakers. For this reason so-called AC/DC sensitive residual current circuit breakers must be used, which also take into account DC currents.

8.7.3 X02: DC Link (AX5101 - AX5125 und AX520x)

DC link coupling or external brake resistor is possible via terminal X2.

	Terminal point	Connection		Tightening torque
	DC+	DC link +	External brake resistor	0,5 - 0,6 Nm
	DC-	DC link -		

8.7.4 X02: DC Link (only AX5140)

Via terminal X2 a DC link coupling can be configured. Don't connect a brake resistor under circumstances!

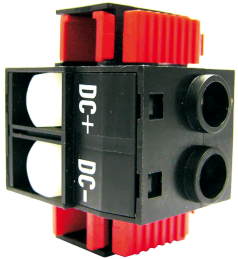
	Terminal point	Connection	
	DC+	DC link +	
	DC-	DC link -	

⚠ WARNING

Serious risk of injury through high electrical voltage!

890 V DC voltage at the DC link terminals X02. Once the device has been switched off dangerous voltage will still be present for a further 5 minutes. Only remove the connector if you wish to configure a drive system with the AX bridge. Only remove the white hexagonal plug if the terminal points are to be rewired.

8.7.5 X03: 24 VDC supply

System and peripheral voltage for the servo drive is supplied via connector X3. The supply is based on two channels in order to offer an option to separate between motor stopping brakes and control electronics.

⚠ CAUTION

Safe operation!

The voltage tolerances must be taken into account when connecting motors with stopping brake.

	Terminal point	Connection	Current consumption	Tightening torque
	Up	24 V _{DC} ±10% (depending on the motor holding brake) - peripheral voltage (e.g. separate brake supply)	Depending on the connected consumers (see X06 and X14, X24)	0.5 – 0.6 Nm
	Us	24 V _{DC} -15% + 20% - system supply voltage	-12 A = 0.4 A – 0.8 A 18 A - 25 A = 1.1 A 40 A = 1.6 A	
	GND	GND		

Connection to the standard mains supply 24 V_{DC} (X03)

The 24 VDC connection "X03" is used for supplying the control electronics and periphery with DC voltage. The control electronics and the periphery can be supplied separately with two different voltage sources.



If one power supply unit is used for the 24 VDC power supply, the connections US and UP must be bridged, in order to ensure that both the control electronics and the periphery are supplied.

Supply via one or two power supply units

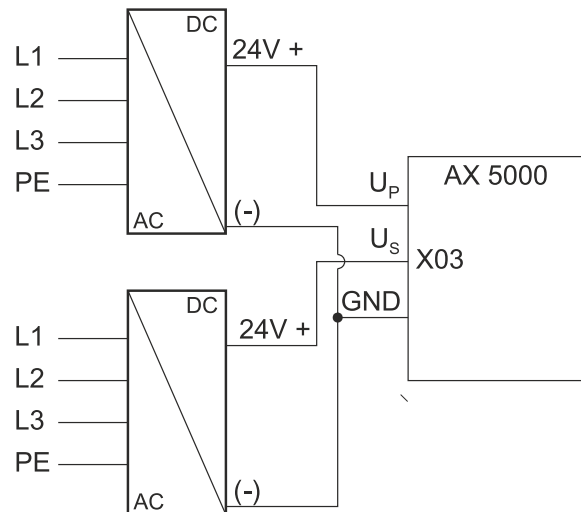
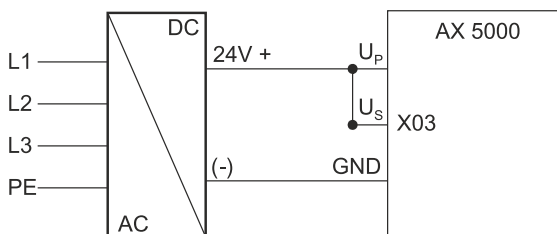

8.7.6 Safe system stop in the event of power failure

A power failure can lead to uncontrolled idling of the drive axes: linear axis or lifting axes would hit the limit stop unbraked. The 24 V_{DC} supply of the AX5000 has two channels, so that separate power supplies can be used for the control electronics and the brake control. This enables the supply voltage for the control electronics to be buffered via the UPS of the Industrial PCs until all axes were stopped safely.

8.8 Power supply (60 A - 170 A devices)

⚠ WARNING

Caution - Risk of injury!

The electrical installation must be carried out by a qualified electrician. Before installing and commissioning AX5000 servo drives please read the safety notes in the foreword of this documentation.

NOTE

Destruction of the AX5000!

The connection sequence of the devices is not arbitrary. The total rated current of the device must decrease from the power supply. The order "AX5112-AX5106-AX5201-AX5103" is correct; the order "AX5201-AX5112-AX5203" is wrong.

8.8.1 X01 - Voltage input

AX5160 and AX5172

Figure	Terminal point	Connection
	L1	Phase L1
	L2	Phase L2
	L3	Phase L3
	PE	Protective conductor

AX5190 and AX5191

Figure	Terminal points	Connection
	L1	Phase L1
	L2	Phase L2
	L3	Phase L3
	PE	Protective conductor

AX5192 and AX5193

Figure	Terminal points	Connection
	L1	Phase L1
	L2	Phase L2
	L3	Phase L3
	PE	Protective conductor

Mains supply connection (X01)

The servo drives of the AX5000 series are equipped with a wide voltage input „X01“ and can be connected to voltage systems three-phases 400 V_{AC-10%} - 480 V_{AC+10%}.

i Connection to the standard mains supply (TT/TN) with earthed centre is described below. Connections to other supply systems are not permissible.

Three-phase 400_{-10%} - 480_{+10%} V_{AC}

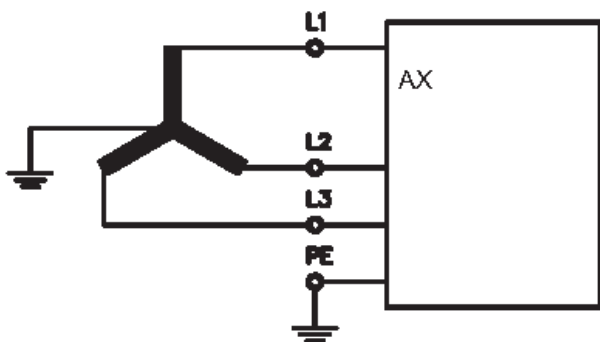

8.8.2 Fusing

External protection for individual devices, CE-compliant

⚠ CAUTION

Fire hazard through short circuit!
 The recommended fuses are designed for line protection. The servo drives feature integrated self-protection.

Fusing	AX5160	AX5172	AX5190	AX5191	AX5192	AX5193
AC supply ^{*)}	80 AT	100 AT	125 AT	160 AT	200 AT	224 AT
24 V supply	4 AT		10 AT			
Brake resistor	electronic					

^{*)}Application class „gG“ mains fuses according to IEC 60269 or „C“ type automatic circuit breakers must be used.

External protection for individual devices, UL-compliant

⚠ CAUTION

Fire hazard through short circuit!
 The recommended fuses are designed for line protection. The servo drives feature integrated self-protection.

Fusing	AX5160	AX5172	AX5190	AX5191	AX5192	AX5193
AC supply ^{*)}						
24 V supply	4 AT		10 AT			
Brake resistor	electronic					

^{*)}Mains fuses according to type “RK5” min. 480 V must be used.

8.8.3 X02: DC link

i DC link AX5000 (60 A -170 A devices)!

When establishing a DC link connection (only for 60 A – 170 A devices!), it is essential to follow the chapter:

"Connection example – DC link group (60 A - 170 A devices)". [▶ 52]

⚠ DANGER

Serious risk of injury through high electrical voltage!

Due to the DC link capacitors, the DC link terminal points "DC+ and DC-" and "RB+ and RB-" may be subject to dangerous voltages exceeding 875 V_{DC}, even after the servo drive was disconnected from the mains supply.

After disconnection, wait for 15 minutes (AX5160/AX5172), 30 minutes (AX5190/AX5191) or 45 minutes (AX5192/AX5193) and measure the voltage at the DC link-terminal points DC+ and DC-. The device is safe once the voltage has fallen below 50 V.

AX5160 - AX5172

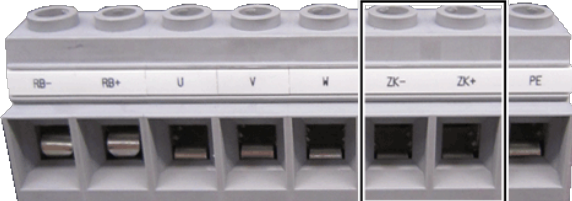
Figure	Terminal point	Connection
	DC +	DC link +
	DC -	DC link -

AX5190 – AX5191

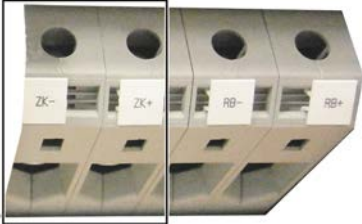
Figure	Terminal point	Connection
	DC +	DC link +
	DC -	DC link -

AX5192 – AX5193

Figure	Terminal point	Connection
	DC +	DC link +
	DC -	DC link -

8.8.4 X03: 24 VDC supply

System and peripheral voltage for the servo drive is supplied via connector X3. The supply is based on two channels in order to offer an option to separate between motor stopping brakes and control electronics.

⚠ CAUTION

Safe operation!
The voltage tolerances must be taken into account when connecting motors with stopping brake.

	Terminal point	Connection	Current consumption
	Up	24 V _{DC} ±10% (depending on the motor holding brake) - peripheral voltage (e.g. separate brake supply)	Depending on the connected consumers (see X06 and X14)
	Us	24 V _{DC} -15% + 20% - system supply voltage	60A – 72A = 3A 90A – 170A = 10A
	GND	GND	

Connection to the standard mains supply 24 V_{DC} (X03)

The 24 VDC connection "X03" is used for supplying the control electronics and periphery with DC voltage. The control electronics and the periphery can be supplied separately with two different voltage sources.



If one power supply unit is used for the 24 VDC power supply, the connections US and UP must be bridged, in order to ensure that both the control electronics and the periphery are supplied.

Supply via one or two power supply units

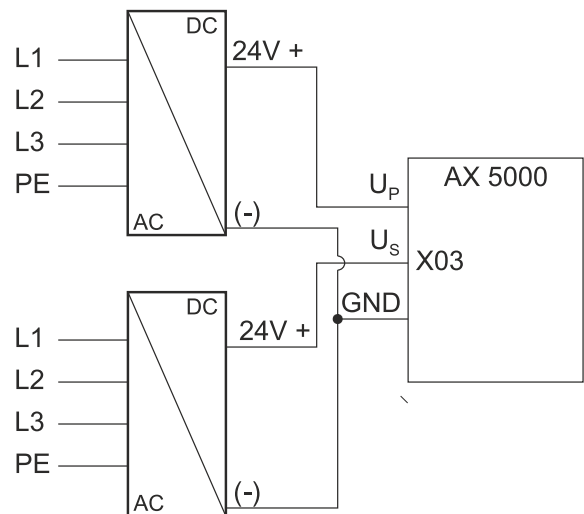
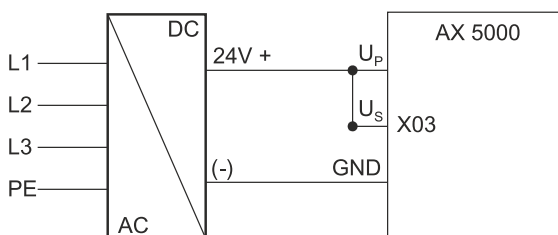

8.8.5 Safe system stop in the event of power failure

A power failure can lead to uncontrolled idling of the drive axes: linear axis or lifting axes would hit the limit stop unbraked. The 24 V_{DC} supply of the AX5000 has two channels, so that separate power supplies can be used for the control electronics and the brake control. This enables the supply voltage for the control electronics to be buffered via the UPS of the Industrial PCs until all axes were stopped safely.

8.9 Leakage currents

When operating servo drives, operationally related leakage currents occur in various frequency ranges (capacitive): In addition, it is possible for a smooth DC residual current (ohmic) to be produced after the rectifier. These currents would prevent a residual current circuit breaker (RCCB or RCD) of the type A or AC from tripping. In the event of a fault, therefore, it would be possible for dangerous voltages to be present on the housing parts. For 3-phase applications the statutory regulations in different countries (please check whether your country is affected) require the use of AC/DC-sensitive RCDs. These should have a rated residual current of ≤ 300 mA. In order to be able to meet these requirements it is necessary to know or calculate the expected leakage currents.

Formulas

The leakage current level depends on the fixed leakage currents, the motor cable length and the supply voltage. The following formulas were determined empirically.

● Calculation basis

i

The values for the leakage current calculated with the equations are valid only if:

- original Beckhoff motor cables are used and
- shielding and grounding concepts are adhered to
- In addition it should be noted that the calculated leakage current value is not exact but merely reflects the maximum expected value, with associated dispersion.

● Composition of the max. total leakage current

i

The max. total leakage current is composed of:

- a device-dependent fixed part with 50 Hz (single-phase feed) or 150 Hz (three-phase feed)
 - plus a variable part that depends on the motor cable length and clock frequency. If no other specifications are applied, the clock frequency is around 8 kHz.
-

Leakage currents for individual devices

$$I_{LCdevice} = I_{LCfix} + I_{LCvar}$$

AX5000 up to 12 A – single-phase connection, leakage current in [mA]:

$$I_{AbFix} = \left(\frac{12 \text{ mA}}{230 \text{ V}} + \frac{4 \text{ mA}}{230 \text{ V}} \right) * \text{Supply voltage [V]}$$

$$I_{AbVar} = \left(\frac{0,51 \frac{\text{mA}}{\text{m}} * \text{Total motor cable length m}}{230 \text{ V}} \right) * \text{Supply voltage [V]}$$

AX5000 up to 12 A – three-phase connection, leakage current in [mA]:

$$I_{AbFix} = \left(\frac{8 \text{ mA}}{480 \text{ V}} + \frac{14 \text{ mA}}{480 \text{ V}} \right) * \text{Supply voltage [V]}$$

$$I_{AbVar} = \left(\frac{2,2 \frac{\text{mA}}{\text{m}} * \text{Total motor cable length m}}{480 \text{ V}} \right) * \text{Supply voltage [V]}$$

AX5118 - three-phase connection, leakage current in [mA]:

$$I_{AbFix} = \left(\frac{10 \text{ mA}}{480 \text{ V}} + \frac{85 \text{ mA}}{480 \text{ V}} \right) * \text{Supply voltage [V]}$$

$$I_{AbVar} = \left(\frac{4,8 \frac{\text{mA}}{\text{m}} * \text{Total motor cable length [m]}}{480 \text{ V}} \right) * \text{Supply voltage [V]}$$

AX5125 - three-phase connection, leakage current in [mA]:

$$I_{AbFix} = \left(\frac{15 \text{ mA}}{480 \text{ V}} + \frac{83 \text{ mA}}{480 \text{ V}} \right) * \text{Supply voltage [V]}$$

$$I_{AbVar} = \left(\frac{5,4 \frac{\text{mA}}{\text{m}} * \text{Total motor cable length [m]}}{480 \text{ V}} \right) * \text{Supply voltage [V]}$$

AX5140 - three-phase connection, leakage current in [mA]:

$$I_{AbFix} = \left(\frac{15 \text{ mA}}{480 \text{ V}} + \frac{35 \text{ mA}}{480 \text{ V}} \right) * \text{Supply voltage [V]}$$

$$I_{AbVar} = \left(\frac{4,4 \frac{\text{mA}}{\text{m}} * \text{Total motor cable length m}}{480 \text{ V}} \right) * \text{Supply voltage [V]}$$

The total leakage current is composed of the sum of the individual device leakage currents:

$$I_{LCtotal} = I_{LCdevice1} + I_{LCdevice2} + \dots + I_{LCdevicen}$$

Leakage currents in a DC link

If several devices are connected via a DC link, only the fixed leakage currents for 50 Hz or 150 Hz are present, as long as no axis is enabled. As soon as an axis is released, the complete fixed leakage currents (50 Hz or 150 Hz) are present and additionally a fixed portion of 8 kHz with a motor cable length of 0 m. The following diagrams illustrate the individual leakage current components:

Sample	
	<p>1 x AX5000 (enabled) without DC link</p> $I_{LCtotal} = I_{LCvar} + I_{LCfix}$
	<p>2 x AX5000 (not enabled) in DC link</p> $I_{ABtotal} = I_{ABfix_1} + I_{ABfix_2}$
	<p>1 x AX5000 (enabled) + 1 x AX5000 (not enabled) in DC link</p> $I_{ABtotal} = I_{ABvar_1} + I_{ABfix_1} + I_{ABfix_2}$ <p>If the AX5000_2 is also enabled the equation is as follows:</p> $I_{ABtotal} = I_{ABvar_1} + I_{ABvar_2} + I_{ABfix_1} + I_{ABfix_2}$

Influence of the motor chokes

Motor chokes are used in order to protect the power semiconductors and the motors through lower voltage edges and therefore reduced peak values of the commutation or leakage currents. However, the reduction in voltage edges has no influence on the RMS value of the leakage currents. Since this is precisely what an RCD invariably assesses, motor chokes have no positive influence here.

8.10 EtherCAT

8.10.1 X04, X05: EtherCAT connection

EtherCAT[®]

The AX5000 is integrated in the EtherCAT strand via the RJ45 sockets X04 and X05.

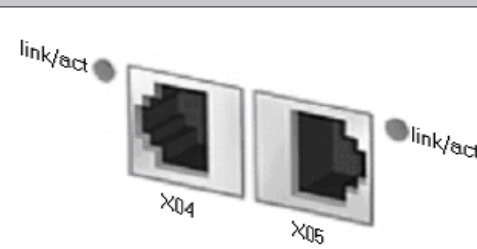
	RJ45	Signal
	X04 (IN)	incoming EtherCAT line
	X05 (OUT)	outgoing EtherCAT line



8.11 Digital I/Os

8.11.1 X06: Digital I/Os

⚠ CAUTION

Destruction of the AX5000!

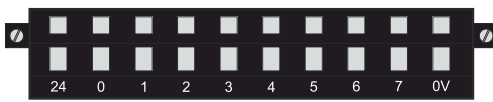
This connector is not designed for external power supply. It is supplied via the 24 V supply (periphery) of connector X03.

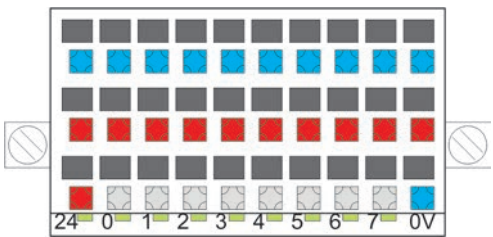
	Terminal point	Signal	Output current	
I/O plug connector without LEDs ZS4500-2006 	24	Power supply for the external sensors (switches/initiators) (U_p 24 V _{DC} +)	max. 1 A	
	0	Input 0		
	1	Input 1		
	2	Input 2		
	3	Input 3		
	4	Input 4		
	5	Input 5		
I/O plug connector with LEDs ZS4500-2007 (optional) 	6	Input 6		
	7	Input 7 or output (configurable) (U_p 24 V _{DC} +)	max. 0.5 A	
	0V	GND (-)		
	ZS4500-2008 (optional) 			

Voltage level	State
-3 V ... 5 V	0 or "false"
15 V ... 30 V	0 or "false"

● Configuration of the plug signal inputs:

i The signal inputs of the plugs can be configured with the following functions (IDNs): P-0-0251, P-0-0400, P-0-0401, P-0-0402, P-0-0800, P-0-0801, P-0-0802.

For further information please refer to the documentation for the S- and P-parameters of the AX5000 servo drive series.

8.11.2 Technical data

Technical data	ZS4500-2006	ZS4500-2007	ZS4500-2008
Number of terminal points	10	10	30
Signal LEDs	no	yes	yes
Rated voltage	24 V _{DC}	24 V _{DC}	24 V _{DC}
Rated current	2 A		
Wire cross section	0.5 mm ² ... 1.5 mm ²		
Strip length	10 mm		
Dimensions (W x H x D)	approx. 42mm x 10.3mm x 26.9mm	approx. 42mm x 12.7mm x 26.9mm	approx. 42mm x 20.8mm x 26.9mm
Weight	approx. 10 g	approx. 10 g	approx. 20 g
Permissible ambient temperature range during operation	0°C ... + 55°C		
Permissible ambient temperature range during storage	-25°C ... + 85°C		
Permissible relative humidity	95 %, no condensation		
Vibration/shock resistance	conforms to EN 60068-2-6 / EN 60068-2-27, EN 60068-2-29		
EMC immunity/emission	conforms to EN 61000-6-2 / EN 61000-6-4		
Protection class	IP 20		
Installation position	variable		
Approval	CE, UL, CSA		

8.11.3 Ordering information for I/O plug connectors

Order identifier	Signal LEDs	Supports the following connection types		
		Single-conductor	Two-conductor	Three-conductor
ZS4500-2006	no	yes	no	no
ZS4500-2007	yes	yes	no	no
ZS4500-2008	yes	yes	yes	yes

8.11.4 Connection of digital sensors/actuators

ZS4500-2006 (standard) and ZS4500-2007 (optional)

The connection type (single-conductor) in the two connectors ZS4500-2006 and ZS4500-2007 is identical. The ZS4500-2007 is additionally equipped with LEDs. The following diagram shows the ZS4500-2006.

A sensor (F) is connected at terminal point "0" via a single-conductor connection. The 24 V supply for the sensor is connected externally. It would also be possible to take the 24 V supply for sensor (F) directly from terminal point "24", which would cover this option.

In this case terminal point "7" is configured as an output. The configuration is implemented on the software side. A relay (G) is connected via a single conductor; the 0 V connection is external.

i **Ground potential**

- If sensor (F) or further initiators are supplied through a separate power supply unit, the ground potential of the separate power supply unit must be connected with the ground potential of terminal point "GND" of connector "X03" (24 V supply).
- The ground potential (0 V) of the relay (G) must be connected with the ground potential of terminal point "GND" of connector "X03" (24 V supply).

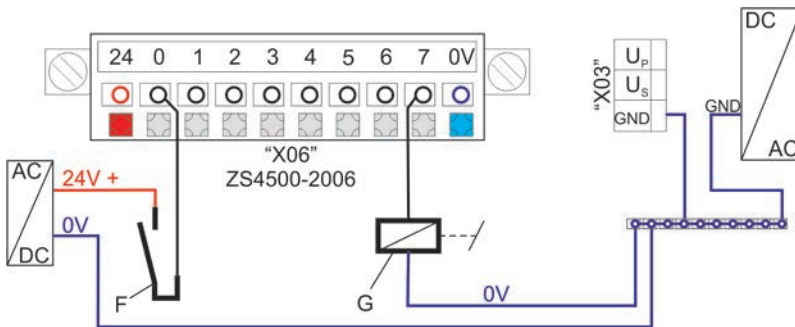

ZS4500-2008 (optional)

A single-, two- or three-conductor connection may be used for this connector. The diagram shows the two- and three-conductor type. The single-conductor type matches the diagram for connector ZS4500-2006.

The terminal points at (B) are internally bridged. The two bridges (A) have to be established externally on the plug, in order to use the terminal points.

A sensor (C) is connected at terminal point "2" via a two-conductor connection.

An initiator (D) is connected at terminal point "4" via a three-conductor connection.

In this case terminal point "7" is configured as an output. The configuration is implemented on the software side. At this point a relay (E) is connected via a two-conductor connection.

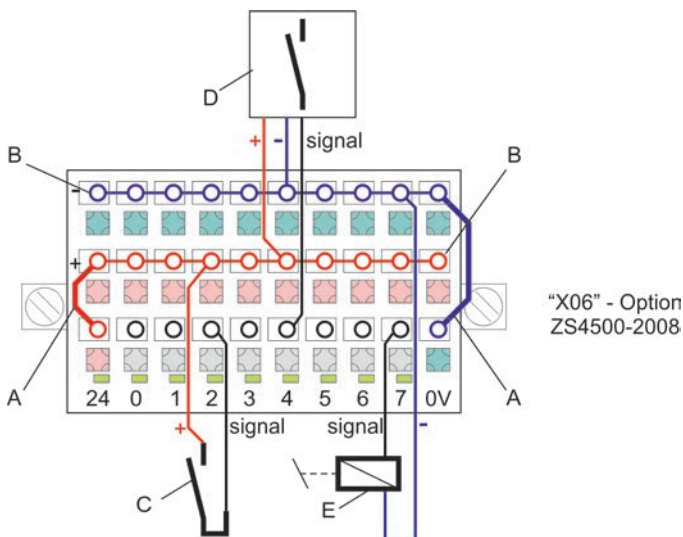

8.12 Feedback

Information on commutation can be found in chapter 10.12: "[Commutation techniques \[► 203\]](#)".
Information about the limit frequencies can be found under the interface descriptions.

i Absolute encoder

When using an absolute encoder, it must be verified before moving the axis that the feedback system supplies the expected position data at the distinctive positions in the traversing range - 'START' and 'MID' and 'END' – and that these positions are retained after the restart (Bootstrap -> OP) of the AX5000. Overflow in the traversing range must be avoided!

8.12.1 Rotational encoders

Heidenhain:

The Heidenhain company supplies feedback systems with the "EnDat 2.2" interface in 2 versions. One version is without the analog signals (sine and cosine), one version includes the analog signal "1Vss". To date, Beckhoff supports only EnDat 2.1 with analog signal. Since the EnDat 2.2 interface supports all of the commands of EnDat 2.1, attention only needs to be paid to the provision of the analog signal 1Vss on the Heidenhain feedback systems with EnDat 2.2; i.e. the Heidenhain order designation "EnDat02" must be stated.

Type	System	Sin/Cos per revolution	Supply voltage	Interface	Sampling
ECI 1118	Singleturn	16	5 V	EnDat 2.1 + 1 Vpp	Inductive
ECI 1319	Singleturn	32	5 V or 7 - 10 V	EnDat 2.1 + 1 Vpp	Inductive
ECN 413	Singleturn	512	3.6 V - 14 V	EnDat 2.1 + 1 Vpp	Optical
ECN 413	Singleturn	2048	3.6 V - 14 V	EnDat 2.1 + 1 Vpp	Optical
ECN 1113	Singleturn	512	5 V	EnDat 2.1 + 1 Vpp	Optical
ECN 1313	Singleturn	2048	5 V	EnDat 2.1 + 1 Vpp	Optical
EQI 1130	Multiturn	16	5 V	EnDat 2.1 + 1 Vpp	Inductive
EQI 1331	Multiturn	32	5 V or 7 - 10 V	EnDat 2.1 + 1 Vpp	Inductive
EQN 425	Multiturn	512	3.6 V - 14 V	EnDat 2.1 + 1 Vpp	Optical
EQN 425	Multiturn	2048	3.6 V - 14 V	EnDat 2.1 + 1 Vpp	Optical
EQN 1125	Multiturn	512	5 V	EnDat 2.1 + 1 Vpp	Optical
EQN 1325	Multiturn	512	5 V	EnDat 2.1 + 1 Vpp	Optical
EQN 1325	Multiturn	2048	5 V	EnDat 2.1 + 1 Vpp	Optical
RCN 829	Singleturn	32768	3.6 – 5.25 V	EnDat 2.2 + 1 Vpp	Optical
ROQ 425	Multiturn	512	3.6 V - 14 V	EnDat 2.1 + 1 Vpp	Optical
ROQ 425	Multiturn	2048	3.6 V - 14 V	EnDat 2.1 + 1 Vpp	Optical
ERN 180	incremental	1024	5 V	1 Vpp	Optical
ERN 180	incremental	2048	5 V	1 Vpp	Optical
ERN 180	incremental	5000	5 V	1 Vpp	Optical
ERN 480	incremental	2048	5 V	1 Vpp	Optical
ERM 280	incremental	1200	5 V	1 Vpp	Magnetic

Hengstler:

Type	System	Sin/Cos per revolution	Supply voltage	Interface	Sampling
AD 34	Singleturn	2048	5 V	BiSS + 1 Vpp	Optical
AD 36	Singleturn	2048	5 V	BiSS + 1 Vpp	Optical
AD 36	Multiturn	2048	5 V	BiSS + 1 Vpp	Optical
AD 58	Singleturn	2048	5 V	BiSS + 1 Vpp	Optical
AD 58	Multiturn	2048	5 V	BiSS + 1 Vpp	Optical

Kübler:

Type	System	Sin/Cos per revolution	Supply voltage	Interface	Sampling
8.5853	Singleturn	2048	5 V	BiSS + 1 Vpp	Optical

Sick- Stegmann:

Type	System	Sin/Cos per revolution	Supply voltage	Interface	Sampling
SEK 37	Singleturn	16	7 V - 12 V	HIPERFACE + 1 Vpp	Capacitive
SEL 37	Multiturn	16	7 V - 12 V	HIPERFACE + 1 Vpp	Capacitive
SEK 52	Singleturn	16	7 V - 12 V	HIPERFACE + 1 Vpp	Capacitive
SEL 52	Multiturn	16	7 V - 12 V	HIPERFACE + 1 Vpp	Capacitive
SRS 50	Singleturn	512	7 V - 12 V	HIPERFACE + 1 Vpp	Optical
SRM 50	Multiturn	512	7 V - 12 V	HIPERFACE + 1 Vpp	Optical
SKS 36	Singleturn	125	7 V - 12 V	HIPERFACE + 1 Vpp	Optical
SKM 36	Multiturn	125	7 V - 12 V	HIPERFACE + 1 Vpp	Optical

Digital rotary encoders:

Type	System	Resolution per revolution	Interface	Sampling
EEK 37	Singleturn	16 bit	OCT	Capacitive
EEL 37	Multiturn	16 bit	OCT	Capacitive
EKS 36	Singleturn	18 bit	OCT	Optical
EKM 36	Multiturn	18 bit	OCT	Optical
EKS 36	Singleturn	20 bit	OCT	Optical
EKM 36	Multiturn	20 bit	OCT	Optical
ERS 50	Singleturn	23 bit	OCT	Optical
ERM 50	Multiturn	23 bit	OCT	Optical

Universal rotary encoders:

Type	System	Sin/Cos per revolution	Supply voltage	Interface	Sampling
1		512	5 V	1 Vpp	

8.12.2 Linear encoders

Heidenhain:

Type	System	Measuring steps	Supply voltage	Interface	Sampling
LS 388C	incremental	20 µm	5 V	1 Vpp	Optical
LS 486	incremental	20 µm	5 V	1 Vpp	Optical
LS 487	incremental	20 µm	5 V	1 Vpp	Optical
LC 483	incremental	20 µm	3.6 V – 5.25 V	EnDat 2.1 + 1 Vpp	Optical
LIDA 477	incremental	20 µm	5 V	1 Vpp	Optical
LIDA 483	incremental	20 µm	5 V	1 Vpp	Optical
LIDA 487	incremental	20 µm	5 V	1 Vpp	Optical
LIDA 287	incremental	200 µm	5 V	1 Vpp	Optical

HIWIN:

Type	System	Measuring steps	Supply voltage	Interface	Sampling
Magic	incremental	1 mm	5 V	1 Vpp	Magnetic

lika:

Type	System	Measuring steps	Supply voltage	Interface	Sampling
SMS	incremental	1 mm	5 V	1 Vpp	Magnetic

Numerik Jena:

Type	System	Measuring steps	Supply voltage	Interface	Sampling
LIA20	incremental	20 µm	5 V	1 Vpp	Optical

Siko:

Type	System	Measuring steps	Supply voltage	Interface	Sampling
LE100/1	incremental	1 mm	5 V	1 Vpp	Magnetic

Universal linear encoders:

Type	System	Measuring steps	Supply voltage	Interface	Sampling
1	incremental	20 µm	5 V	1 Vpp	
2	incremental	1 mm	5 V	1 Vpp	
3	incremental	20 µm	5 V - uncontrolled	1 Vpp	
4	incremental	1 mm	5 V - uncontrolled	1 Vpp	

i Motor feedback database

If your feedback system is not listed here, please follow the link to the Beckhoff download area. By downloading and installing the "AX5000 setup" you will obtain the TwinCAT Drive Manager, the latest firmware and the latest motor feedback database.

8.12.3 X11 and X21: Feedback, high-resolution

The X11 and X21 D-SUB plugs are available for connecting high-resolution feedback systems. In delivery state X11 is assigned to axis A, X21 to axis B.

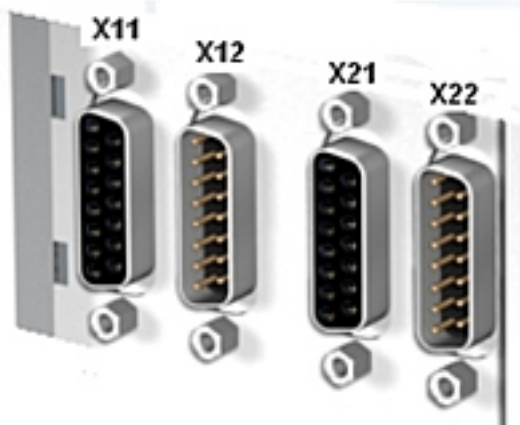

Pin	EnDAT / BiSS	Hiperface	Sine / cosine 1 Vpp	TTL ¹⁾	Output current
1	SIN	SIN	SIN	n.c.	max. 250 mA / channel
2	GND_5 V	GND_11 V	GND_5 V	GND_5 V	
3	COS	COS	COS	n.c.	
4	U _s _5 V	n.c.	U _s _5 V	U _s _5 V	
5	DX+ (Data)	DX+ (Data)	n.c.	B+	
6	n.c.	U _s _11 V	n.c.	n.c.	
7	n.c.	n.c.	REF Z	REF Z	
8	CLK+ (Clock)	n.c.	n.c.	A+	
9	REFSIN	REFSIN	REFSIN	n.c.	
10	GND_Sense	n.c.	GND_Sense	GND_Sense	
11	REFCOS	REFCOS	REFCOS	n.c.	
12	U _s _5 V_Sense	n.c.	U _s _5 V_Sense	U _s _5 V_Sense	
13	DX- (Data)	DX- (Data)	n.c.	B -	
14	n.c.	n.c.	Z	Z	
15	CLK- (Clock)	n.c.	n.c.	A -	

¹⁾Attention: Wire break detection is not supported for TTL encoders.

Limit frequency:

1 Vpp = 270 kHz

TTL = 10 MHz

MES = 500 Hz

8.12.4 Resolver

Universal resolvers:

Number of poles	Frequency	Transmission ratio
2	8 kHz	0.5
6	8 kHz	0.5
8	8 kHz	0.5

8.12.5 X12 and X22: Feedback, resolver / Hall

The X12 and X22 D-SUB sockets are available for connecting resolvers or Hall sensors for commutation. X12 is assigned to axis A in the factory, X22 to axis B.

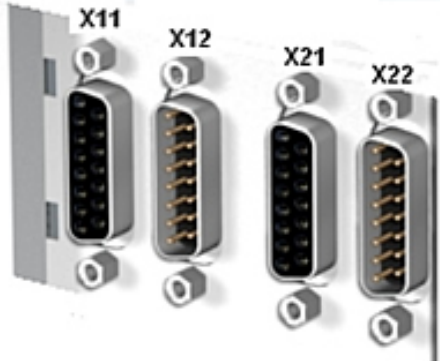
	Pin	Resolver	Analog Hall sensor
	1	Temperature (only PTC, Klixon or bimetal!). Switching point: 1300 Ω ± 3%	n.c.
	2	AGND	n.c.
	3	COS - (S3)	n.c.
	4	SIN - (S4)	n.c.
	5	REF - (R2)	n.c.
	6	n.c.	Sin 1Vpp
	7	n.c.	-120° or -90° 1Vpp *
	8	n.c.	U _s 11 V (supply)
	9	Temp._GND	n.c.
	10	COS + (S1)	n.c.
	11	SIN + (S2)	n.c.
	12	REF + (R1)	n.c.
	13	n.c.	REFSin 1Vpp
	14	n.c.	-120° or -90° 1Vpp *
	15	n.c.	GND (supply)

Limit frequency:

Resolver = 300 Hz

8.12.6 X14 and X24: Feedback, OCT (1.5 A - 40 A devices)

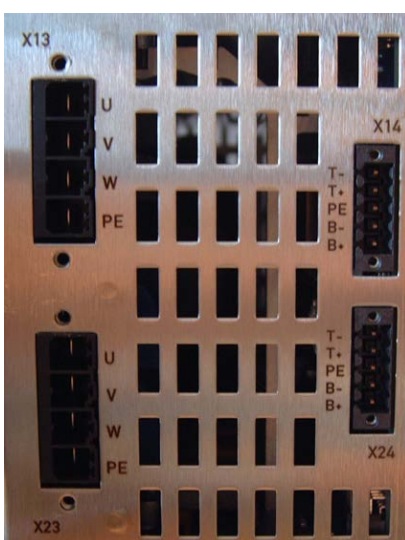
	Pin	OCT / thermal contact
	T -	OCT -
	T +	OCT +

8.13 Motors

8.13.1 Concept

Both three-phase synchronous motors and three-phase asynchronous motors can be driven with the servo drives from the AX5000 series. The operation of asynchronous motors with the AX5000 is useful if, in the configuration of the drive system, a channel is still freely available and also if asynchronous motors are used that are to be operated with open-loop control. In the case of the use of asynchronous motors intended for closed-loop operation, the AX5000 series is a good alternative regardless of the configuration of the drive system.

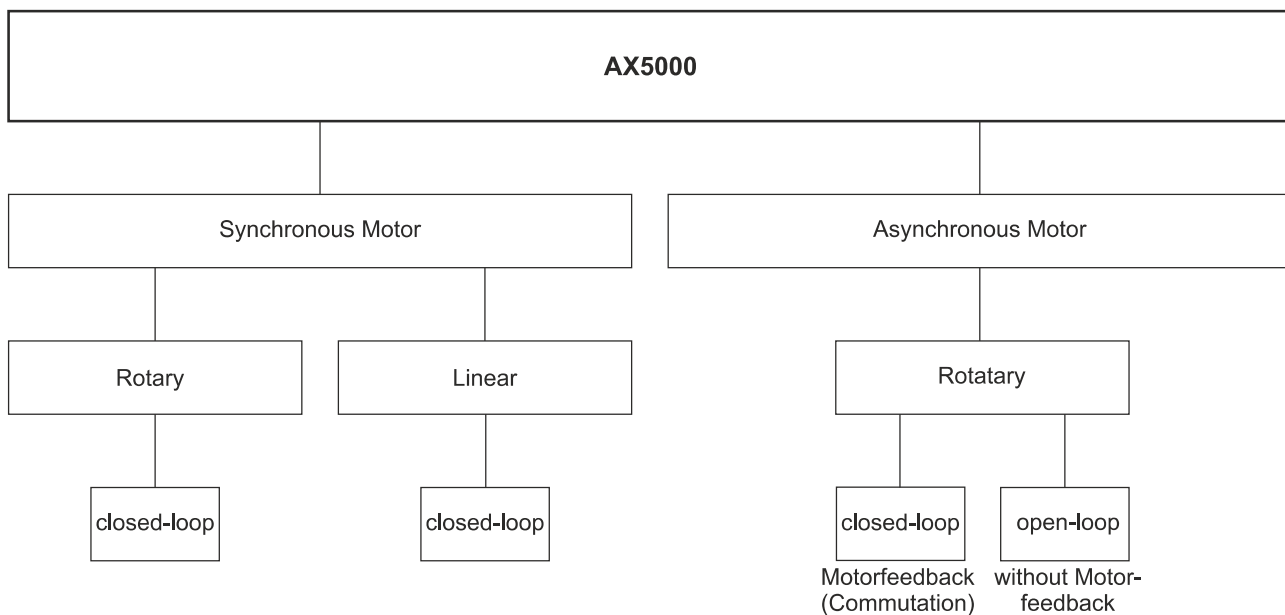

8.13.2 Motor data set

A motor dataset contains the motor data and control parameters, which the AX5000 requires for operating the motor. Beckhoff is continually expanding the pool of available motor data sets and makes the latest motor database available automatically when the TwinCAT Drive Manager is updated.

i Creating motor data sets

Further information on creating motor data sets can be found in chapter 9.13.4: "[Synchronous motors](#) [▶ 88](#)",

8.13.3 TwinCAT Drive Manager

Servo drives are parameterized via the TwinCAT Drive Manager (TCDM). The screen masks required for the parameterization will be explained at this point. If you need basic information about the TCDM, please read the complete documentation, which is available on our website for download.

Start the TCDM and click the entry (2) under the relevant channel (1) in the tree; the motor/feedback configuration appears in the TCDM working area. Click on the field (3) in order to open the 'Motor selection window'. In the 'Motor selection window' you can display all of the available motors, or enter your own motors including motor parameters (asynchronous motors only).

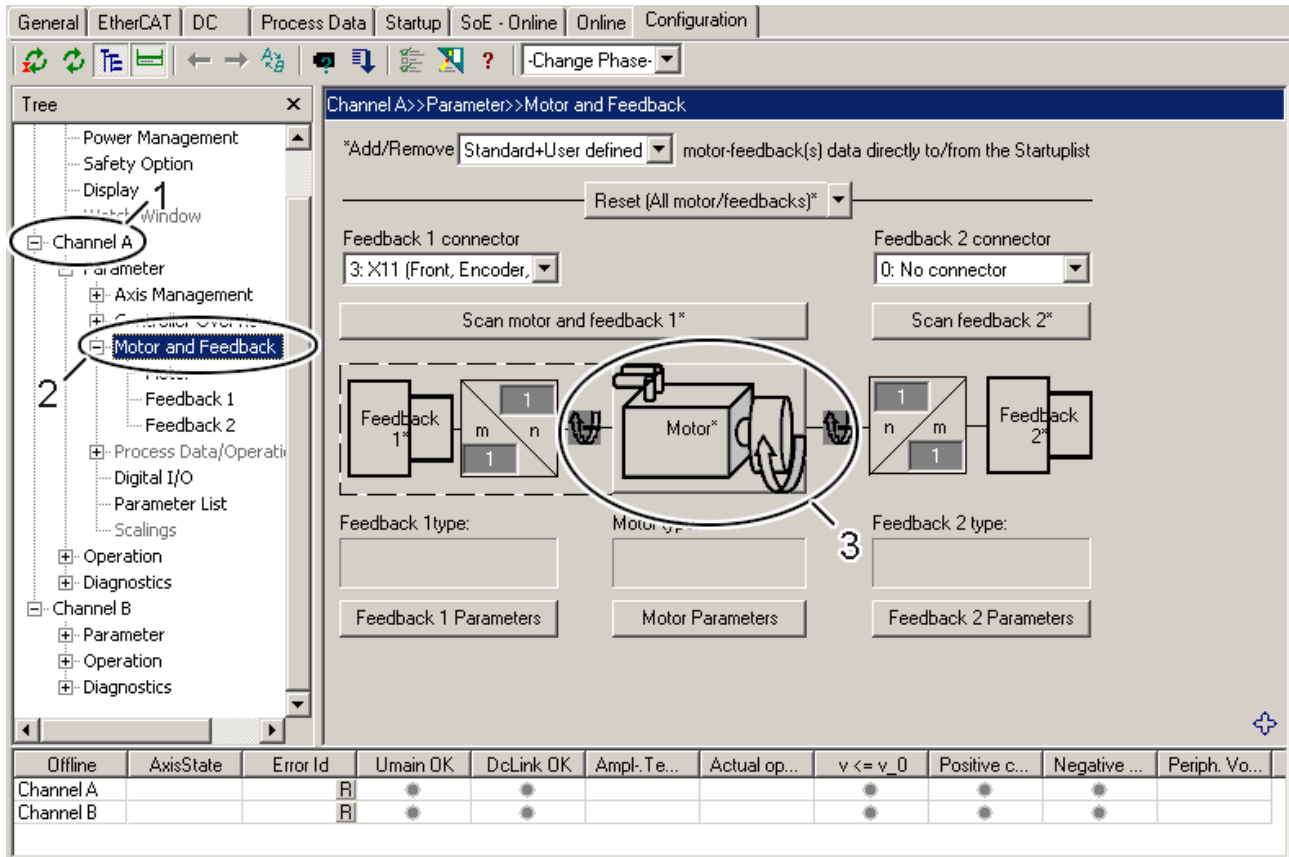

8.13.4 Motor types

8.13.4.1 Synchronous motors

In the case of synchronous motors, you can only select an existing motor; it is not possible to register your own motors. If your motor is not listed, please contact our support department.

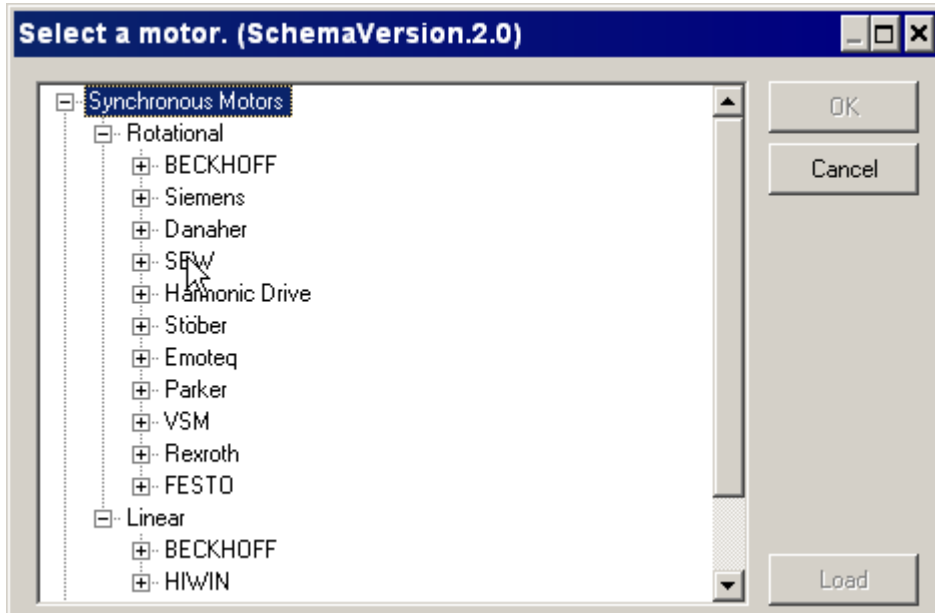

8.13.4.2 Asynchronous motors

With the AX5000 you have the possibility to implement a good positioning drive with an inexpensive standard motor in combination with a low-cost incremental encoder.

Linear

Linear asynchronous motors are not supported at present.

Rotary

1. Motor selection

You can either choose an existing motor (1) or generate parameters for a new motor (2). After selection, click "OK" (3) to move to the next menu.

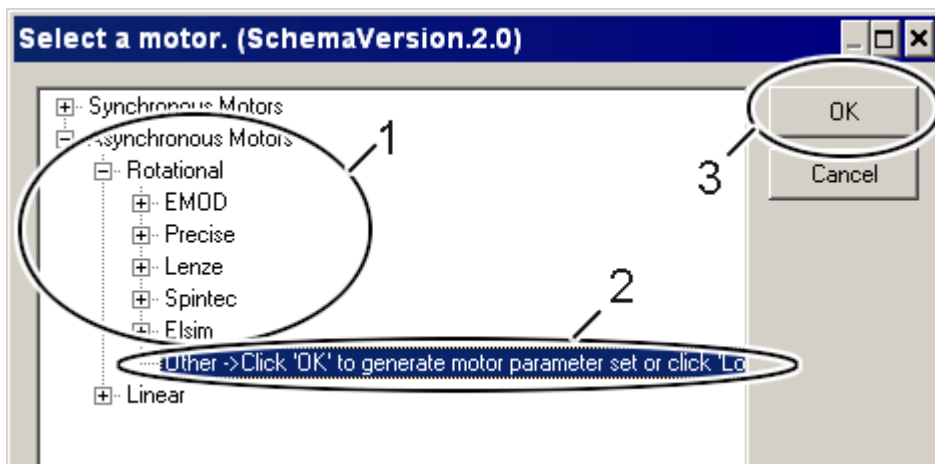

2. Characteristic motor data

In the next menu characteristic motor data are entered or selected. Expert mode (9) is not currently supported. Parameters (4) and (5) are preset; you do not need to change them. You can enter a new motor manufacturer or select an existing motor manufacturer in parameter (6). A new group is generated in parameter (7) to suit the motor. If you wish to conform to the structure of the motor database, name the group according to the nominal speed of the motor. Enter the exact type designation of the motor in parameter (8). Check your entries and then click "Next" (10) to move to the next menu.

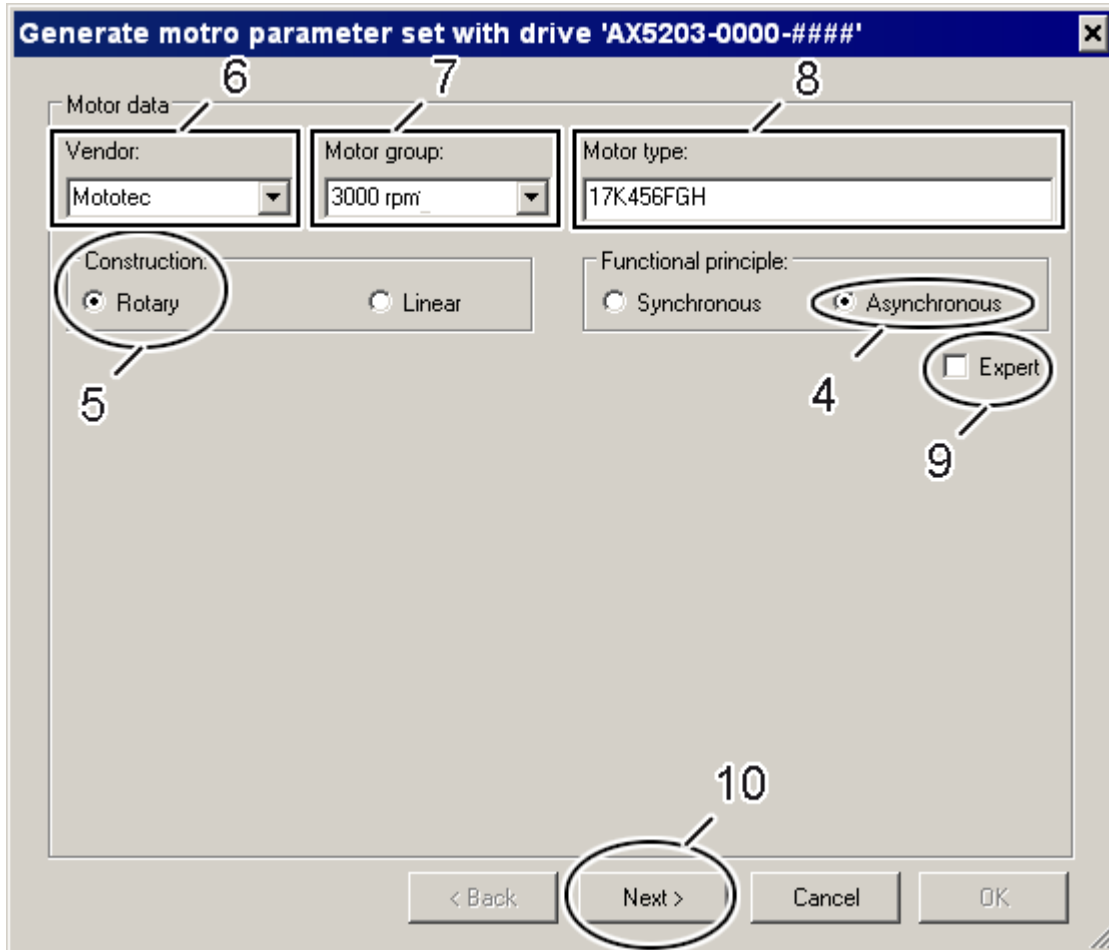

3. Basic motor data

The basic data are subdivided into three categories: "Basic" (1); "Temperature:" (2) and "Brake" (3).

Basic (1):

i It is essential to observe the maximum permitted d_u / d_t of the motor winding!

a) Type of connection: Star or delta connection. If you wire and operate the motor in a star or delta configuration, please note that the rated motor current changes along with the rated motor voltage and that the AX5000 can supply a maximum rated voltage of 480 V. Please refer to the motor documentation or name plate for the permissible motor voltages and currents for star and delta connection.

b) The derating is dependent upon your application. Derating is the difference between the effective rated channel current and the rated motor current in %. Example: rated motor current = 4 A; effective rated channel current = 3 A -> derating = 25 %.

c) The ratio of I_p to I_n (overload factor) is set to 1.5 as standard and must be checked against the motor documentation or name plate.

d) The rated current must be adjusted in accordance with the type of connection and checked against the motor documentation or name plate.

e) The maximum motor speed is dependent upon the mechanical properties and the maximum rotary field frequency of the AX5000. Please observe the M / f curve and the field weakening according to the motor documentation.

f) The rated voltage must be adjusted in accordance with the type of connection and checked against the motor documentation or name plate.

g) The nominal speed is dependent upon the number of pole pairs and the nominal frequency and must be checked against the motor documentation or name plate.

h) The nominal frequency is set to 50 Hz as standard and must be checked against the motor documentation or name plate.

i) The power factor ($\cos \phi$) is set to 0.8 as standard and must be checked against the motor documentation or name plate.

Temperature (2):

k) The type of motor temperature monitoring used and the AX5000 input used must be selected.

i For further information on the combinations you intend to use please contact the Beckhoff applications department.

m) The temperature at which a warning is given is set to 80 °C. This parameter is effective only for KTY sensors.

n) The temperature at which the motor is switched off is set to 140 °C and must be checked against the motor documentation or name plate. This parameter is effective only for KTY sensors.

Brake (3):

o) The type of motor brake used must be selected and checked against the motor documentation or name plate.

Double-check all entries and click 'Next' (4) to move to the next menu.

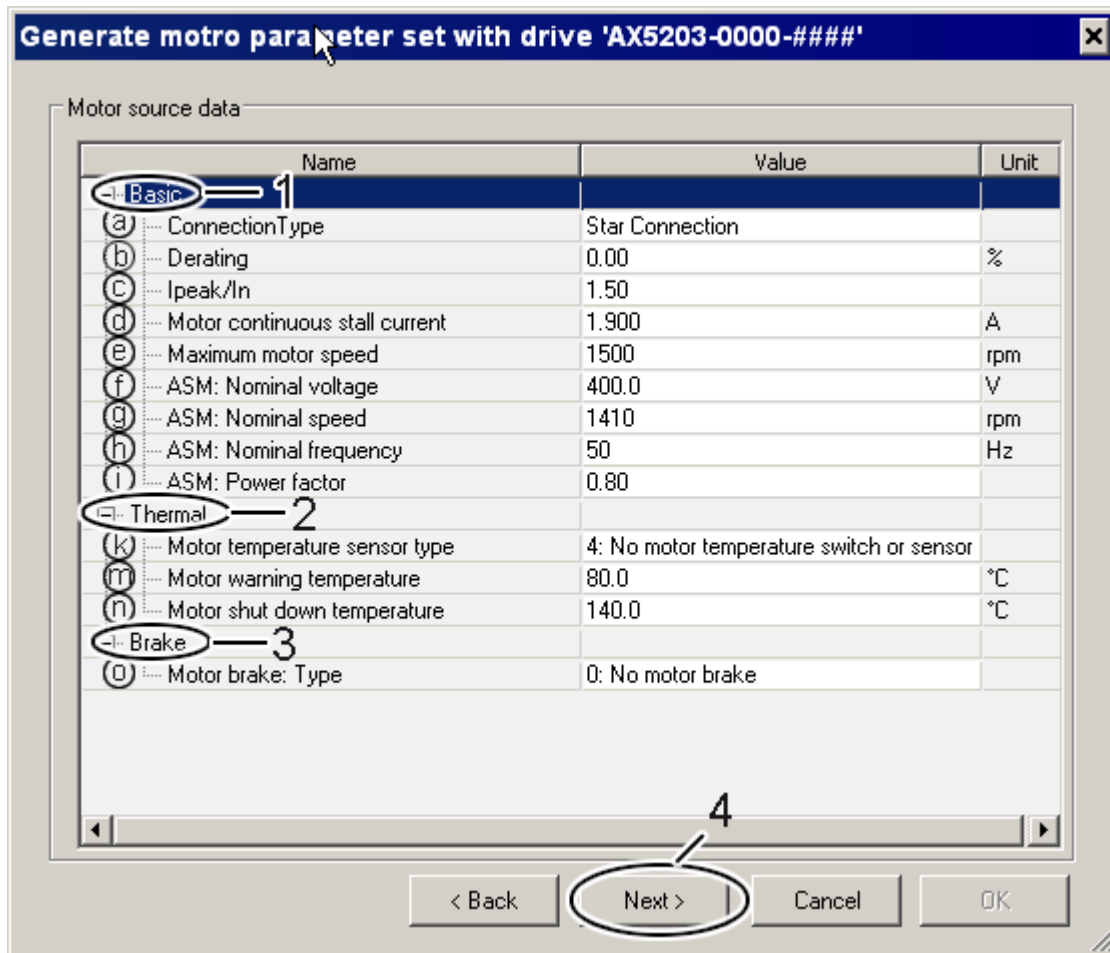

4. Summary

The motor data entered and the data calculated from them are displayed in this window. Please check ALL parameters once more for plausibility and click 'OK' (5) to move to the next menu.

Generate motor parameter set with drive 'AX5203-0000-####' ✕

Motor source data and calculated data

Text	Value	Unit
Motor continuous stall current (S-0-0111)	1.900	A
Maximum motor speed (S-0-0113)	1500	rpm
ASM: Nominal voltage (P-0-0101)	400.0	V
ASM: Nominal speed (P-0-0100)	1410	rpm
ASM: Nominal frequency (P-0-0102)	50	Hz
ASM: Power factor (P-0-0104)	0.80	
Motor temperature sensor type (P-0-0061)	4: No motor temperature switch or s...	
Motor warning temperature (S-0-0201)	80.0	°C
Motor shut down temperature (S-0-0204)	140.0	°C
Current ctrl cycle time (P-0-0002)	125	us
Thermal motor model (P-0-0062): Time constant	60	s

Drive type: AX5103-0000-#### | A... Constraints:

Text	Value	Unit
ASM: Connection type (P-0-0106)	0: Star connection	
Motor peak current (S-0-0109)	2.850	A
Number of pole pairs/pole pair distance (P-0-0051)	2	
ASM: Rotor time constant (P-0-0105)	71	ms
Bipolar velocity limit value (S-0-0091)	1410	inc/(1...
Max motor speed with max torque (P-0-0056)	1410	rpm
Configured channel current (P-0-0093)	1.900	A
Configured channel peak current (P-0-0092)	2.850	A

5

5a. Default storage folder for self-generated motor data sets

The default storage folder for user-generated motor datasets is called "CustomerGenerated" (1), and the suggested file name (2) corresponds to the motor type entered above (see "Characteristic motor data"). This storage folder has the advantage that you can find your self-generated motor data sets at a glance; however, they are not included in the above list above under 1. 'Motor selection', but are only visible if you click the 'Load' button at the bottom right under 1. 'Motor selection'. The suggested name designates only the XML file of the motor data set. For the purposes of displaying in the lists, the XML file is read and the corresponding identifying motor data ('Vendor', 'Motor group' and 'Motor type') are listed as a selection. To save your data, click on "Save" (4), which then takes you to the last menu.

If your self-generated motor data sets are to be listed directly in the above list under 1. 'Motor selection', click on the symbol (3) to open the "MotorPool" folder.

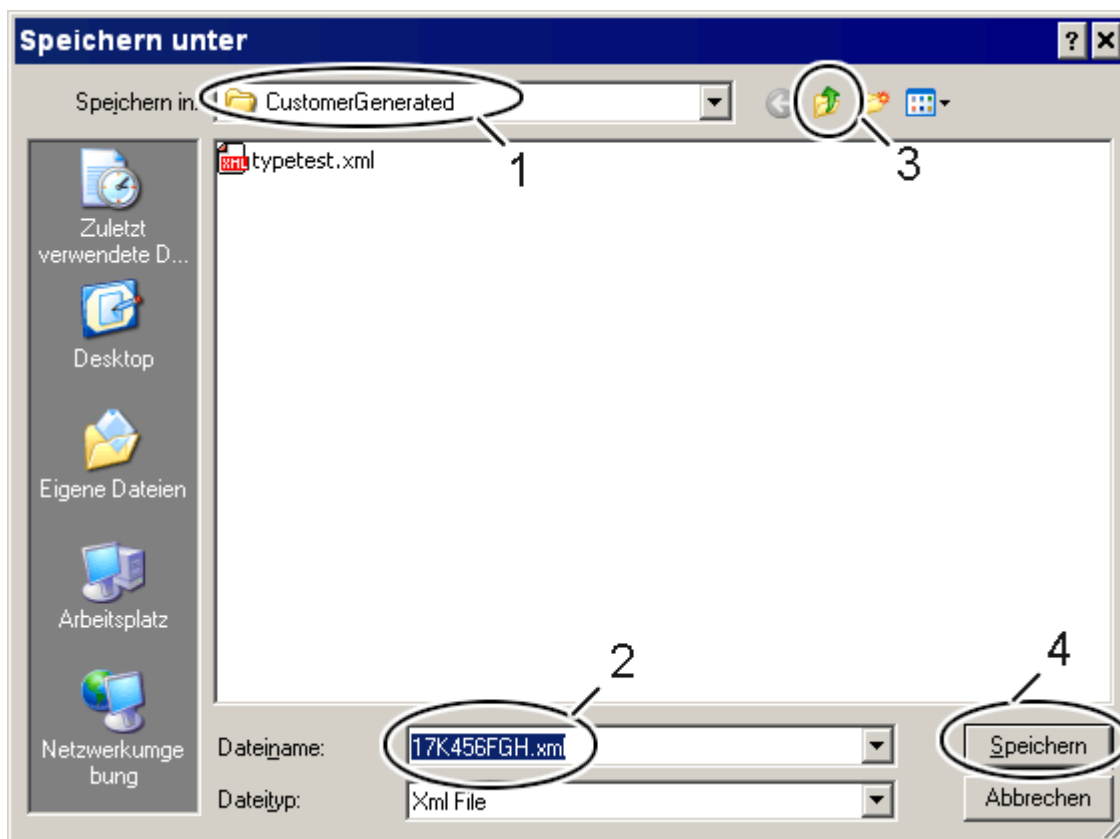

5b. Default storage folder for the motor data sets from the Beckhoff motor database

The default storage folder for the motor data sets provided is called "MotorPool" (4). All motor data sets from the Beckhoff motor database are saved here in the form of XML files. We recommend that you assign a unique file name to your self-generated motor data set, so that you can identify it (5):

Customer = name of your company

Mototec = The name (Vendor) assigned by you under 2. "Identifying motor data"

3000 = The motor group assigned by you under 2. "Identifying motor data"

17K456FGH = The motor type assigned by you under 2. "Identifying motor data"

Of course, you can also assign an arbitrary file name. The assigned name designates only the XML file of the motor data set. For the purposes of displaying in the lists, the XML file is read and the corresponding identifying motor data ('Vendor', 'Motor group' and 'Motor type') are listed as a selection.

You create one XML file for each motor data set; the motors from the same motor group of a manufacturer (Vendor) are always summarized in the XML files for Beckhoff motor data sets.

To save your data, click on "Save" (6), which then takes you to the previous menu.

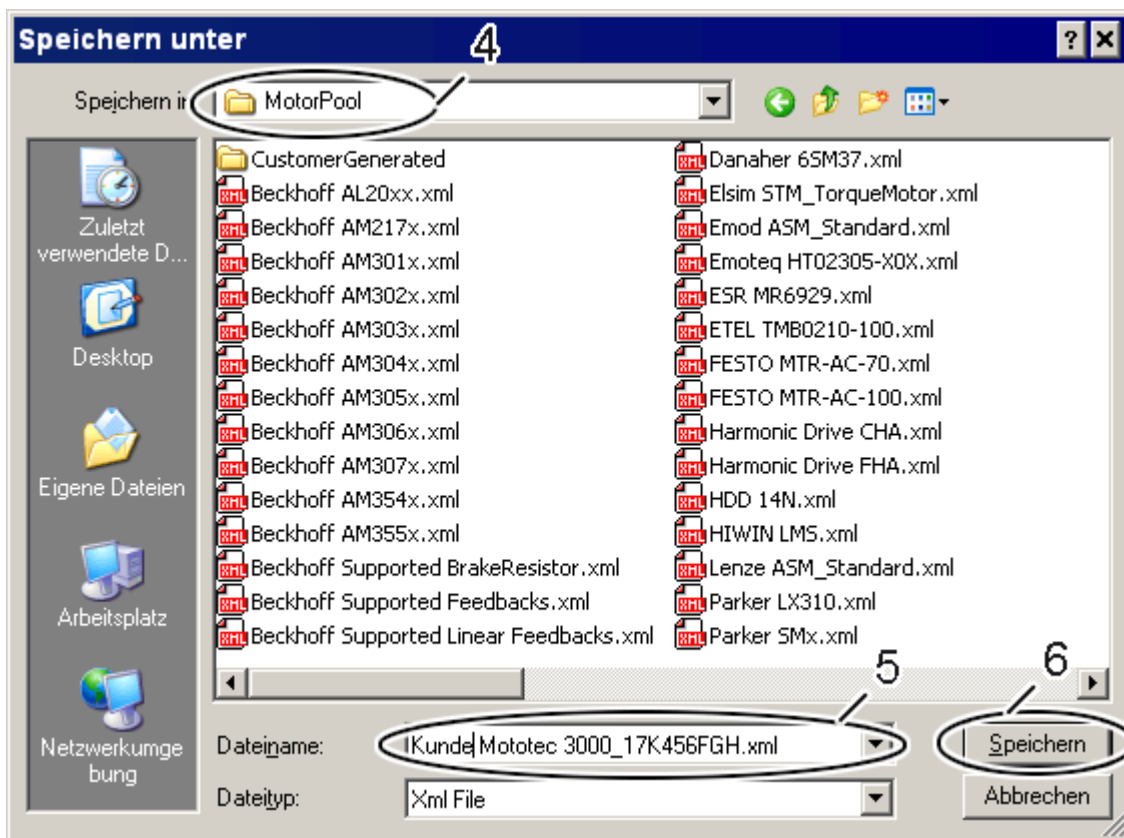

6. Mains voltage and further settings

This window also appears when you select an existing motor data set (synchronous motor or asynchronous motor). You can adapt the following entries at any time.

- a) You can select one of the pre-defined mains voltage variants or you can specify one of your own.
- b) Enter the mains voltage (only possible if no mains variant was selected under a)).
- c) Enter the upper tolerance of the mains voltage (only possible if no voltage was selected in a)).
- d) Enter the lower tolerance of the mains voltage (only possible if no voltage was selected in a)).
- e) + f) Phase monitoring is only useful for a 3-phase mains supply. Switch phase monitoring on or off (only possible if no voltage was selected in a)).
- g) Use this setting to enable automatic transfer of the resolution of the encoder and the scaling factor from the AX5000 to the NC. (Only required if the motor was integrated via an NC axis).
- h) The cycle time of the current controller is 125 µs.
- i) Selection of the type of ASM connection. If you have generated the motor data set, you can only select the type of connection entered under 3. "Basic motor data –a)". If Beckhoff has generated the motor data set, you can choose between star connection and delta connection.
- k) Selection of the ASM control mode. If you select "U/f control", only open-loop operation of the motor is possible; the AX5000 then acts like a servo drive. If you select "i-control with feedback", closed-loop operation of the motor is possible, but the motor must be equipped with a feedback system. Click on "OK" (1) to complete the procedure.

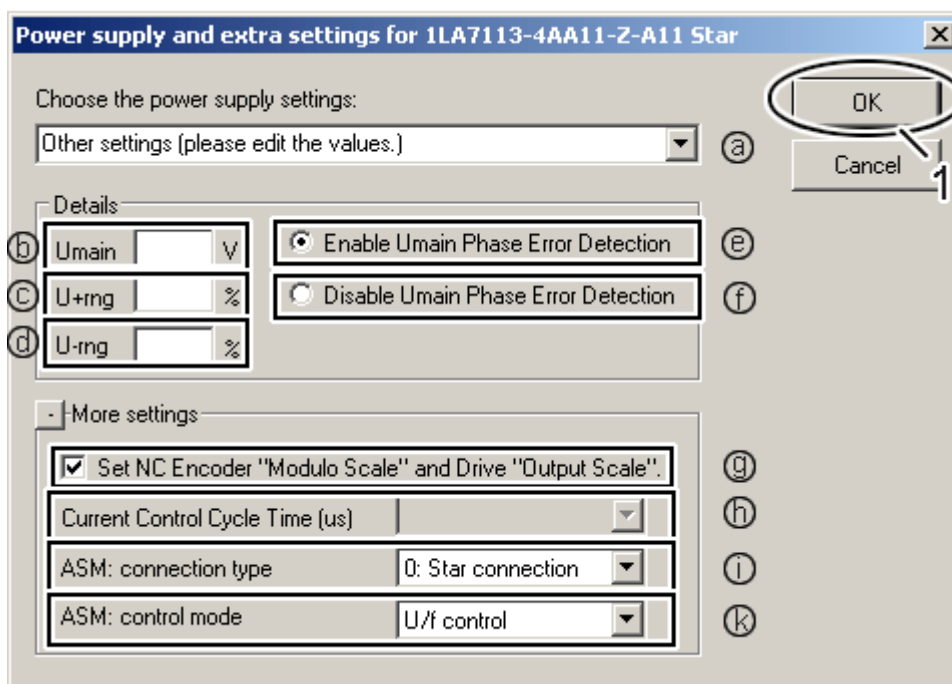

Open-loop

If open-loop operation of the motor is desired, you can influence the operating behavior with the following parameters.

Interdependence between the type of connection of the motor, the speed and the rated output current of the AX5000

Example motor:

Asynchronous motor with rated voltage 230 V and rated current 6 A at 50 Hz for delta connection or rated voltage 400 V, rated current 3.5 A at 50 Hz for star connection

If your application requires speeds above the nominal speed (1), this requirement can be realized without having to use a bigger motor:

The AX5000 can provide 400 V of channel output voltage and thus operate the asynchronous motor in delta connection at up to 87 Hz (2) without field weakening occurring, i.e. with the rated torque. You only need to note that a rated current of 6 A is required.

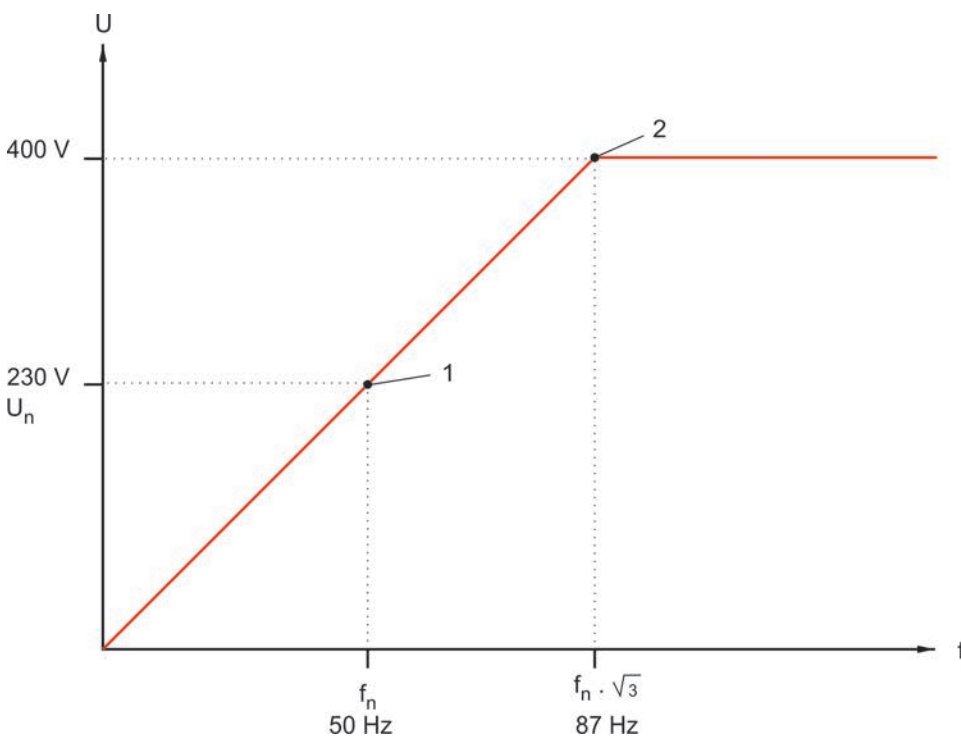

Boost voltage

The operation of an asynchronous motor with a linear U/f characteristic curve results in a weakening of the torque in the lower speed range due to the dominant resistive component. The standstill torque is zero without a boost voltage. Furthermore, the asynchronous motor requires a certain time after the current is applied in order to build up the magnetic field on the rotor and, hence, to generate the magnetic force or the torque. If your application can not tolerate this delay, there is a possibility to reduce this time delay via the so-called "boost voltage", which "premagnetises" the rotor. With "premagnetization" a magnetic field is created in the rotor even though the rotor is not moving. Torque is hence immediately available to rotate the rotor shaft if a target speed is specified. The interdependence between the boost voltage, speed and torque is illustrated in the graphic below on the basis of an example motor. The influence of the boost voltage on the torque is clearly visible at low speeds.

Example motor:

- Rated speed: 1410 rpm
- Rated torque: 10.2 Nm
- Breakdown torque: 28.6 Nm
- Starting torque: 25.5 Nm
- Power factor: 0.78
- Efficiency: 0.79

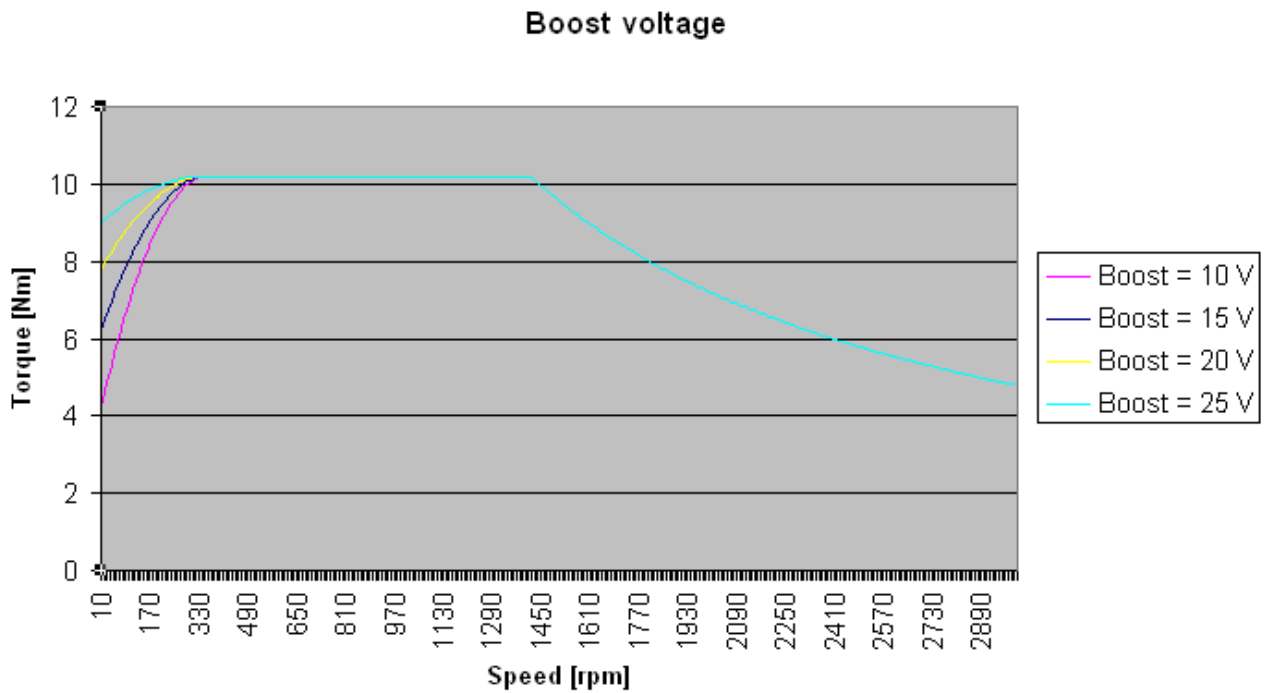

The boost voltage is parameterized in the IDN-P-0-0103. Most applications will be covered by the default setting of 10 V.

NOTE

Attention: destruction of the motor

In an asynchronous motor without an external fan, the motor temperature must be monitored in the lower speed range when boost voltage is used. If necessary, you can change the boost voltage online.

Settings for ramping up and down

In the open-loop operation of the asynchronous motor, the values you need to adjust for the ramps depend on the application. The ramp-up is parameterized in the IDN S-0-0136 and the ramp-down in the IDN S-0-0137.

Closed-loop

If closed-loop operation of the asynchronous motor is desired, you must select the feedback system used in the motor in the TCDM.

Feedback

Start the TCDM and click the entry (2) under the relevant channel (1) in the tree; the motor/feedback configuration appears in the TCDM working area. Click on the 'Feedback 1' (3) field to open the 'Feedback selection window'. You can view all available feedback systems in the 'Feedback selection window'.

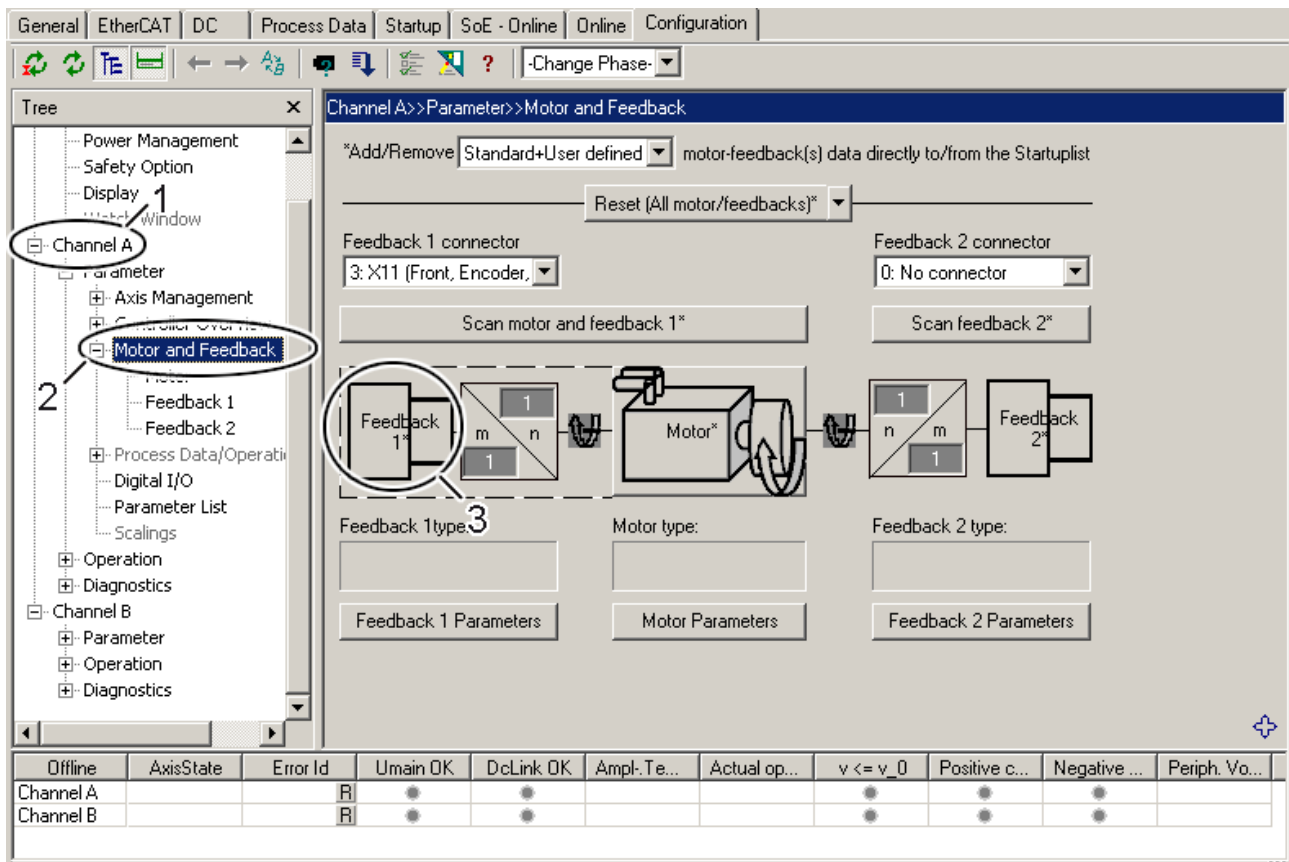

1a. Feedback selection - resolver

Only one of the listed feedback systems can be selected. Either choose the feedback system of an existing manufacturer or choose a standard feedback system under "Unknown" (1). If your motor is equipped with a resolver, determine the generic parameters of the resolver and select the appropriate resolver type (2). Typical generic parameters for the classification of resolvers are the number of poles "p" and the gear ratio "n". Click on "OK" (3) to complete the procedure.

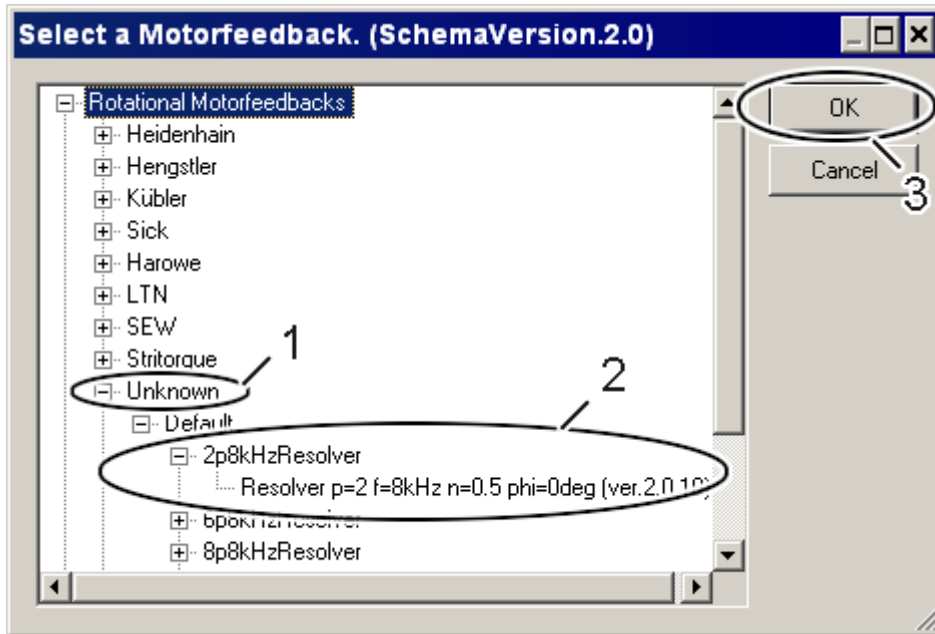

1b. Feedback selection - 1Vpp encoder

You can only select one existing feedback system. Either choose the feedback system of an existing manufacturer or choose a standard feedback system under "Unknown" (1). If your motor is equipped with a 1Vpp encoder, determine the parameters of the feedback system and select the appropriate encoder (2). Typical parameters for the classification of 1Vpp encoders are the number of lines 's' and the supply voltage '5 V or 5 V fixed'. The difference between the two voltage variants is the use of a sense line (5 V). Click on "OK" (3) to complete the procedure.

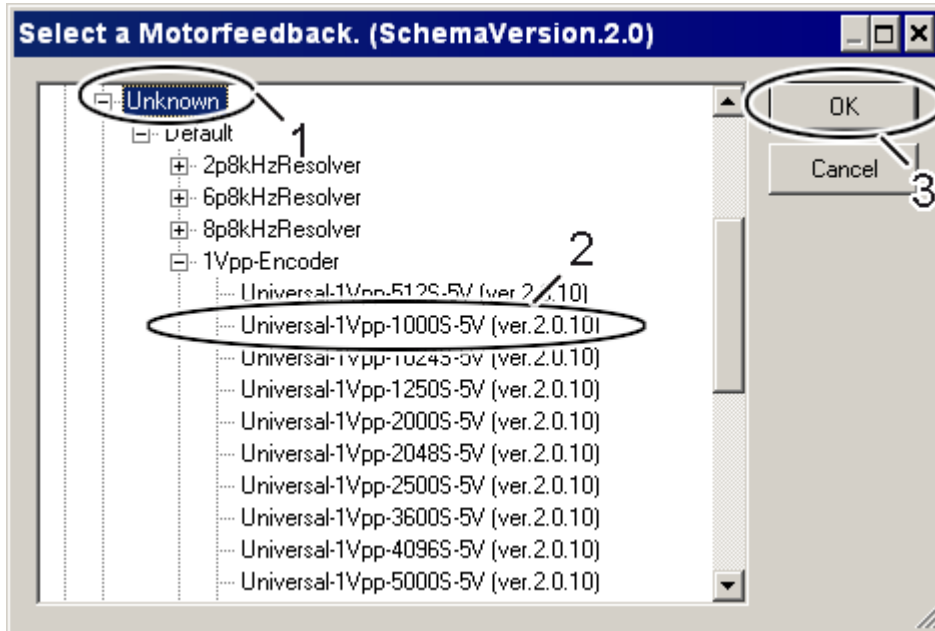

1c. Feedback selection - TTL encoder

You can only select one existing feedback system. Either choose the feedback system of an existing manufacturer or choose a standard feedback system under "Unknown" (1). If your motor is equipped with a TTL encoder, determine the parameters of the feedback system and select the appropriate TTL encoder (2). Typical parameters for the classification of TTL encoders are the number of lines 's' and the supply voltage '5 V or 5 V fixed'. The difference between the two voltage variants is the use of a sense line (5 V). Click on "OK" (3) to complete the procedure.

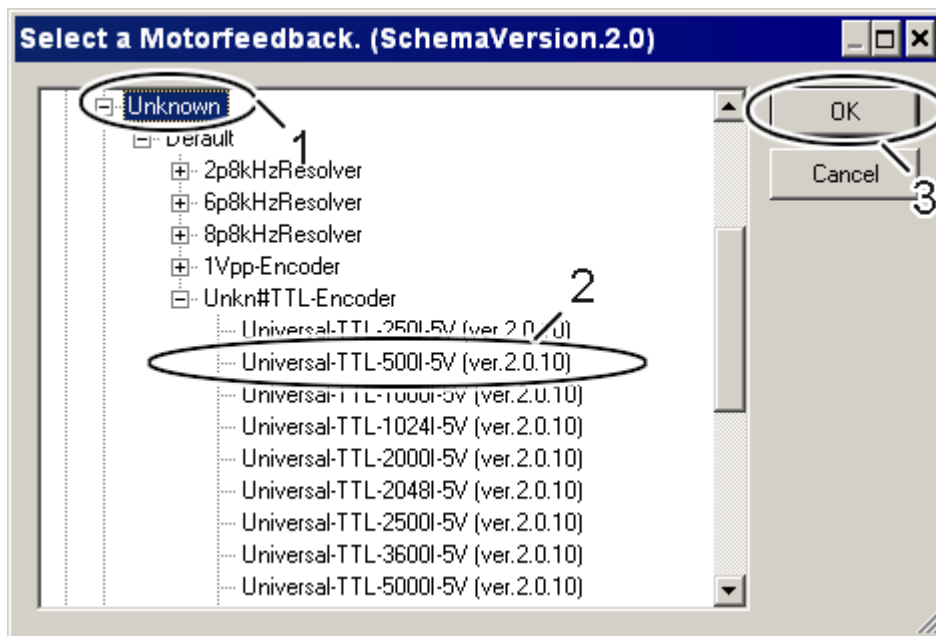

● TTL Encoder!
i Wire break detection is not supported for TTL encoders.

Commutation

In asynchronous motors the rotor magnetic field is generated electrically by means of rotor windings, which are energized by the servo drive. For this reason, neither a part-absolute nor an absolute encoder system is required for commutation; wake+shake also does not need to be used. The magnetic field of the stator induces a voltage in the rotor windings. This leads to a current flow in the rotor windings. This in turn generates a magnetic field, which produces a torque.

8.13.5 Motor connections (1.5 A - 40 A devices)

8.13.5.1 X13 (A), X23 (B): AX5101 - AX5125 and AX520x

	Terminal point	Signal	Tightening torque
	U	Motor connection U	0.6 Nm
	V	Motor connection V	
	W	Motor connection W	
	PE	Protective conductor	
	Shroud	Shield	

8.13.5.2 X13: AX5140

	Terminal point	Signal	Tightening torque
	U	Motor connection U	1.0 Nm
	V	Motor connection V	
	W	Motor connection W	
	PE	Protective conductor	
	Shroud	Shield	

NOTE

Shield connection!

The shield connection is established via the shroud of the motor connector. Please tighten the knurled screw with a screwdriver (max. 1.0 Nm). Inadequately shield connection as a result of a loose plug can lead to uncontrolled interference currents, which may also flow via encoder or resolver cables. This approach can thus result in feedback problems.

8.13.5.3 X14 (A), X24 (B): Motor brake, thermal contact (1.5 A - 40 A devices)

	Terminal point	Signal	Current load	Tightening torque	Conductor cross-section
	T -	OCT and temp. - *		max. 0.25 Nm	0.2 – 1.5 mm ²
	T+	OCT + and temp. + *			
	PE	Protective conductors and inner shields of the signal pairs			
	B -	Brake, GND			
	B+	Brake (Up) +	max. 2.2 A		

¹⁾ switch, KTY 83-1xx or KTY 84-1xx

NOTE

Destruction of the AX5000!

Read the "Cables" chapter carefully and be sure to adhere to the specifications contained in it.

Temperature monitoring for Beckhoff motors

AM2000 with resolver

Via resolver cable.

AM2000 with EnDat

The thermal protection contact is implemented in the encoder cable to the AX5000 and must be bridged to the resolver connection via an adapter / Y cable.

AM2000 with BiSS

Not available.

AM3000 with resolver

Via resolver cable.

AM3000 with EnDat

Via motor cable.

AM3000 with BiSS

Via motor cable.

Linear motors AL2000

The thermal protection contact exits the motor via a separate cable.

1. If the pre-assembled Beckhoff motor and encoder cable is used, an additional thermal protection contact cable (ZK4540-0020-xxx) is required for connecting the thermal protection contact with the AX5000 resolver interface, where temperature evaluation takes place.
2. If the AL2250 connector box is used, the thermal protection contact is automatically bridged to the motor cable.

Temperature monitoring and evaluation for motors from other manufacturers

1. Temperature monitoring via PTC, Klixon or bimetal

Evaluation either on the resolver interface (X12 / X22) or the temperature contact (X14 / X24)

2. Analog temperature evaluation (e.g. KTY)

Evaluation only on the temperature contact (X14 / X24)

8.13.6 Motor connections (60 A - 170 A devices)

8.13.6.1 X13: AX5160 and AX5172

	Terminal point	Connection
	U	Motor connection U
	V	Motor connection V
	W	Motor connection W
	PE	Protective conductor

8.13.6.2 X13: AX5190 and AX5191

	Terminal point	Connection
	U	Motor connection U
	V	Motor connection V
	W	Motor connection W
	PE	Protective conductor

8.13.6.3 X13: AX5192 and AX5193

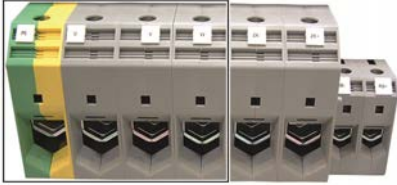
	Terminal point	Connection
	U	Motor connection U
	V	Motor connection V
	W	Motor connection W
	PE	Protective conductor

8.13.6.4 X14: Motor brake, thermal contact

	Terminal point	Connection	Output current
	T -	Temp. - *	max. 2.2 A
	T+	Temp. + *	
	PE	Signal pair shield	
	B -	Brake GND	
	B+	Brake (U_p) +	

*) switch, KTY 83-1xx or KTY 84-1xx

8.14 External brake resistor

⚠ DANGER

High voltage – Danger of death!

Due to the DC link capacitors, the DC link terminal points "ZK+ and ZK- (DC+ and DC-)" and "RB+ and RB-" may be subject to dangerous voltages of up to $875 V_{DC}$, even after the servo drive was disconnected from the mains supply.

Wait 5 minutes for the AX5101 - AX5125 and AX520x; 15 minutes for the AX5140/AX5160/AX5172; 30 minutes for the AX5190/AX5191; 45 minutes for the AX5192/AX5193 after disconnecting, and measure the voltage at the DC link terminal points "ZK+ and ZK- (DC+ and DC-)". The device is safe once the voltage has fallen below 50 V.

8.14.1 X02 - AX5101-AX5125 and AX520x

	Terminal point	Signal
	DC+	DC link +
	DC-	DC link -

8.14.2 X07 - AX5140

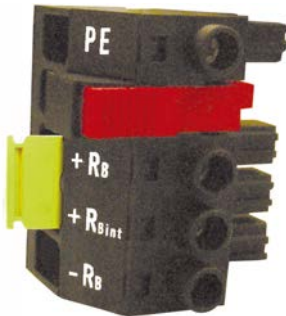
	Terminal point	Signal
	PE	Protective conductor
	+R _B	External brake resistor +
	+R _{Bint}	Internal brake resistor +
	-R _B	Brake resistor GND

i Operation of AX5140

Commissioning the AX5140 can only be carried out when the terminal points "+R_{Bint}" and "+R_B" are bypassed (delivery state) or an external brake resistor is connected (terminal points "+R_B" and "-R_B"). If these measures are not taken then the AX5140 will be stopped with the error message "FD4B – undervoltage".

8.14.3 AX5160 and AX5172

	Terminal point	Connection
	RB +	Ext. brake resistor +
	RB -	Ext. brake resistor -

8.14.4 AX5190 and AX5191

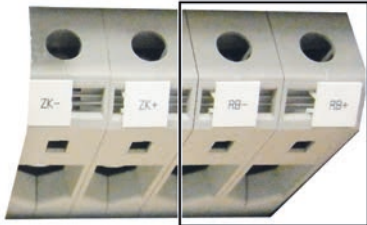
	Terminal point	Connection
	RB +	Ext. brake resistor +
	RB -	Ext. brake resistor -

8.14.5 AX5192 and AX5193

	Terminal point	Connection
	RB +	Ext. brake resistor +
	RB -	Ext. brake resistor -

8.15 Motors and cables for servo drives AX5101 - AX5140

With longer motor cables the resulting commutation currents can lead to EMC faults. Use the tables below to check whether mains chokes or mains filters have to be used in your application. When selecting the control cabinet ensure that there is adequate space for mains chokes and mains filters, etc.

Lay the power and signal cables in separate metal cable ducts or, if both types of cable use the same metal cable duct, make sure there is an earthed metal dividing wall between the cables.

● Motor chokes

i For the AX5140 to AX5193 series no motor chokes are required.

Maximum cable length (including extensions) for a rated motor voltage up to 400 V:

Motor choke	AX5101-AX5112 a. AX52xx		AX5118 a. AX5125		AX5140	
	C2 ¹⁾	C3	C2 ²⁾	C3	C2	C3
Without	< 25 m	< 25 m	< 25 m	< 25 m	-	< 35 m
AX2090-MD50-0012	< 100 m	< 100 m	-	-	-	-
AX2090-MD50-0025	-	-	< 50 m	< 50 m	-	-

¹⁾ For compliance with EN 61800-3 only with mains filter AX2090-NF50-0014.

²⁾ For compliance with EN 61800-3 only with mains filter AX2090-NF50-0032.

In exceptional cases (sensitive sensors, etc.) it can be necessary to use a motor choke even for motor cable lengths < 25 m.

Maximum cable length (including extensions) for a rated motor voltage up to 480 V

Motor choke	AX5101-AX5112 a. AX52xx		AX5118 a. AX5125		AX5140	
	C2 ¹⁾	C3	C2 ²⁾	C3	C2	C3
Without	< 20 m	< 20 m	< 20 m	< 20 m	-	< 35 m
AX2090-MD50-0012	< 100 m	< 100 m	-	-	-	-
AX2090-MD50-0025	-	-	< 50 m	< 50 m	-	-

In exceptional cases (sensitive sensors, etc.) it can be necessary to use a motor choke even for motor cable lengths < 20 m.

In order to keep circuit feedback (distortion reactive power) as low as possible, a mains choke should always be used.

● Radio interference in the living area:

i Mains chokes are products with limited availability according to EN 61800-3. The products can cause radio interference in residential areas. In this case, measures must be taken by the operator.

8.16 Motors and cables for servo drives AX5160 - AX5193

With longer motor cables the resulting commutation currents can lead to EMC faults. Use the tables below to check whether mains chokes or mains filters have to be used in your application. When selecting the control cabinet ensure that there is adequate space for mains chokes and mains filters, etc.

Lay the power and signal cables in separate metal cable ducts or, if both types of cable use the same metal cable duct, make sure there is an earthed metal dividing wall between the cables.

● Motor chokes

i For the AX5140 to AX5193 series no motor chokes are required.

Maximum cable length (including extensions) for a rated motor voltage up to 480 V

Servo drive	Category C2		Category C3	
	with mains filter	with mains filter and mains choke	without mains filter and without mains choke	with mains filter and mains choke
AX5160 ¹⁾	max. 10 m	max. 25 m	max. 25 m	max. 50 m
AX5172 ²⁾	max. 10 m	max. 25 m	max. 25 m	max. 50 m
AX5190 ³⁾	---	max. 10 m	---	max. 25 m
AX5191 ⁴⁾	---	max. 10 m	---	max. 25 m
AX5192 ⁵⁾	---	max. 10 m	---	max. 25 m
AX5193 ⁶⁾	---	max. 10 m	---	max. 25 m

In compliance with EN 61800-3 only in conjunction with the following accessories:

- ¹⁾ Mains filter AX2090-NF50-0063 and (or) mains choke AX2090-ND0060
²⁾ Mains filter AX2090-NF50-0100 and (or) mains choke AX2090-ND0072
³⁾ Mains filter AX2090-NF50-0100 and (or) mains choke AX2090-ND0090
⁴⁾ Mains filter AX2090-NF50-0150 and (or) mains choke AX2090-ND0110
⁵⁾ Mains filter AX2090-NF50-0150 and (or) mains choke AX2090-ND0143
⁶⁾ Mains filter AX2090-NF50-0180 and (or) mains choke AX2090-ND0170

In order to keep circuit feedback (distortion reactive power) as low as possible, a mains choke should always be used.

● Radio interference in the living area:



Mains chokes are products with limited availability according to EN 61800-3. The products can cause radio interference in residential areas. In this case, measures must be taken by the operator.

9 Advanced system characteristics

9.1 Commissioning

9.1.1 Important information for commissioning

WARNING

Caution - Risk of injury!

Electronic equipment is not fail-safe. The machine manufacturer is responsible for ensuring that the connected motors and the machine are brought into a safe state in the event of a fault in the drive system.

Please be aware each time before commissioning the AX5000 that connected motors can make uncontrolled movements, which cannot always be prevented even by the AX5000's integrated diagnostic system, or may permit uncontrolled movements until the diagnostic system responds. Analyze your system and take suitable precautions to prevent damage being caused by these uncontrolled movements.

Potential causes of uncontrolled movements:

The diagnostic system of the AX5000 is equipped with complex plausibility checks, which constantly monitor installation, operation, parameterization and operation and, if necessary, interrupt them with a diagnostic message. The parameters listed below are monitored by default, although it is not possible to cover all eventualities.

- Incorrect commutation results (e.g. on wake & shake), please note chapter Commutation techniques--> Commutation error "F2A0".
- Take special care with third-party motors: When a motor or encoder is replaced or when a different SysMan file (.TSM) is used, always execute the command "P-0-0166" without load connection and analyze the result. If necessary, adjust the commutation offset, as described in the chapter on the commutation process.
- Input of invalid parameters
- Measuring transducer and/or signal transducer defective or incorrectly adjusted
- Cables defective or not adequately shielded
- Incorrectly attached sensors

CAUTION

Increased attention in the case of vertical axes!

When commissioning vertical axes, the risk consideration described above is to be carried out with particular care. An uncontrolled movement can mean the sudden falling down of a load in this case.

9.1.2 Software requirements

Generally, two TwinCAT software modules are required for controlling the AX5000:

- TwinCAT NC PTP
- TwinCAT PLC

TwinCAT NC is a closed software module whose features the user can only influence via parameters. The *TwinCAT NC* parameters can be set in the *TwinCAT System Manager*.

TwinCAT PLC is a program code which the user creates in the *PLC Control* development environment.

Structure of TwinCAT NC PTP

TwinCAT NC has 2 tasks:

- NC task 1 SPP (**S**et **P**re**P**aration task)
- NC task 1 SEC (**S**et **E**xecution task)

The SPP task is responsible for planning the requested traversing task. The SAF task is responsible for executing the motion command.

The traversing task leaves the PLC in the direction of the ADS router with destination *NC-Task 1 SVB (NC task 1 SPP)*. The router relays the telegram to this task.

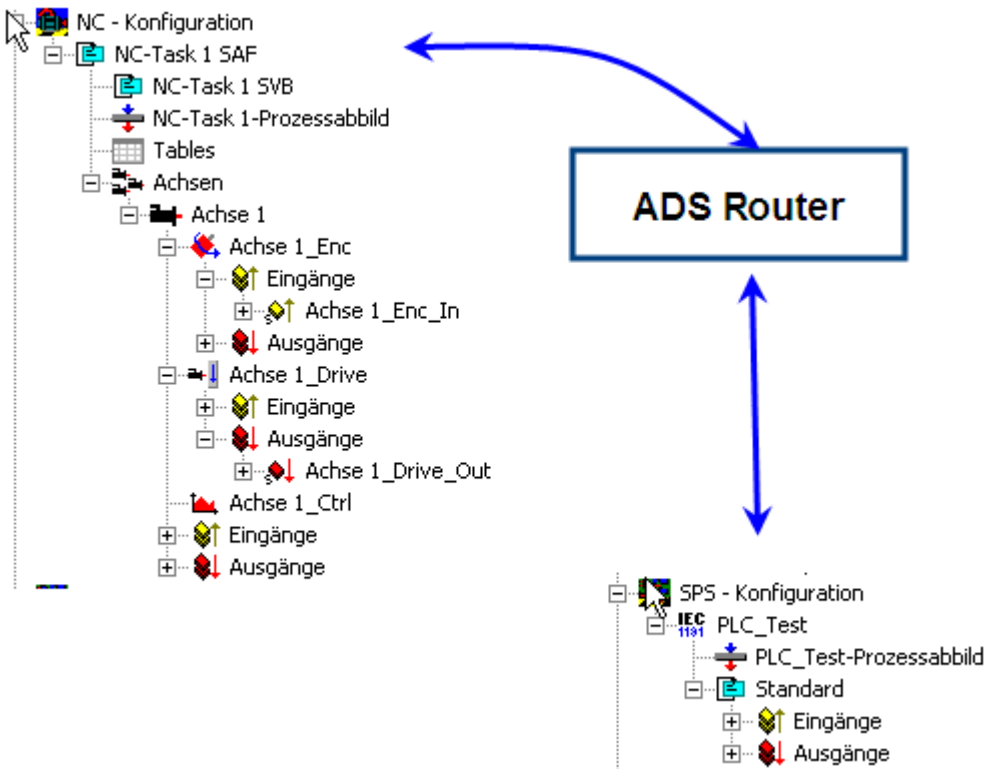

The NC accepts or rejects the message. The response arrives back at the calling block in the PLC via the same route. Instructions are issued based on blocks contained in TCMC.lib. Once the NC has accepted the instruction, the system tries to calculate a solution taking into account the boundary conditions (max. velocity, acceleration, deceleration, and jerk).

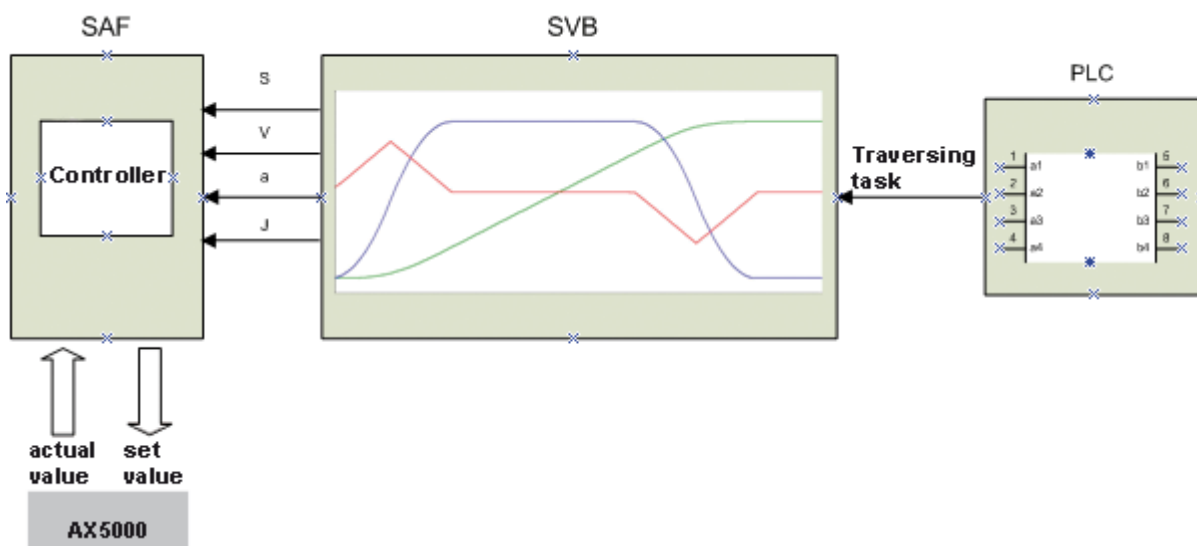

If a solution exists, a table containing the position (s) velocity (v), acceleration/deceleration (a) and jerk (j) for the whole travel time within the sampling time of the SEC task is transferred to the SEC.

If no solution exists, the system deviates downwards based on maximum jerk, maximum acceleration, and maximum velocity (in this order).

Actual and set values shown in the diagram are served by the 1_Enc axis and 1_Drive axis components.

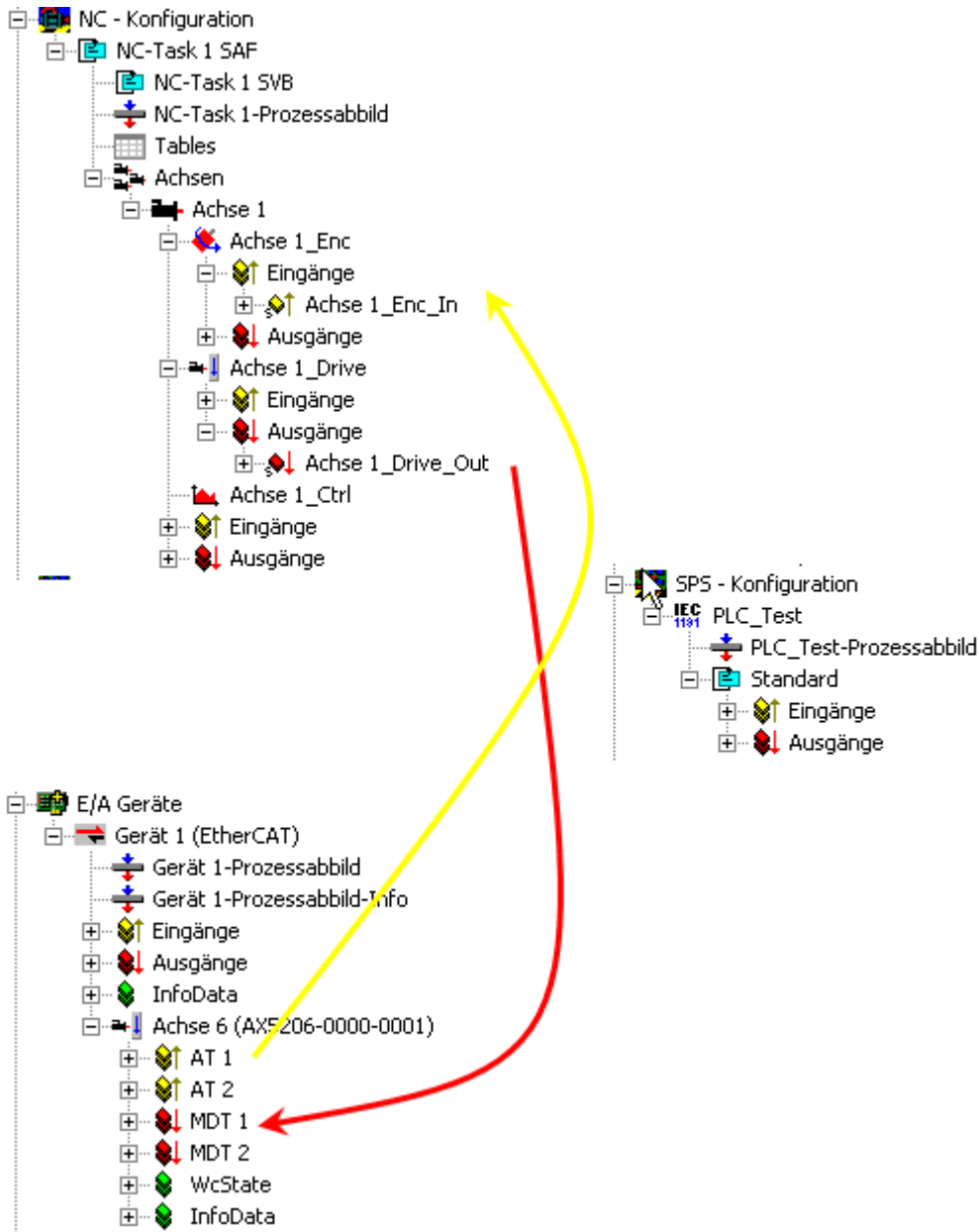

Since the AX5000 is known to the system as a slave, linking can take place automatically if required. In the event of problems the link can be checked by the user.

NC / AX5000 link specification:

NC set values	AX5000 set values	NC actual values	AX5000 Actual values
axis n_Drive / outputs/axis n_DriveOut / nOutData1	MDT n / position set value (option)	axis n_Enc / inputs / axis 1_Enc_In / nInData1	AT n / actual position value sensor 1
axis n_Drive / outputs/axis n_DriveOut / nOutData2	MDT n / velocity set value		
axis n_Drive / outputs/axis n_DriveOut / nCtrl1	MDT n / master control word (Hi-byte)	axis n_Drive / inputs/axis n_DriveIn / nStatus1 & nStatus2	AT n / drive status word
		axis n_Drive / inputs/axis n_DriveIn / nStatus4	WcState' / WcState

9.1.3 Rotary motors

9.1.3.1 Commissioning under TwinCAT 2

This tutorial describes the procedure for commissioning the servo drive AX5000. All the steps shown are based on TwinCAT version 2.11. The individual sections build on each other and should be followed sequentially.

The tutorial shows a possible approach as an example. Alternative approaches are possible.

Creating a project

- Open TwinCAT in the System Manager



- Create a project via the icon (1) in the toolbar or via the menu bar: File (2) → New

→ An empty project is created.

Select target system

Target system available in selection list

In the System Manager select the target system (runtime system), to which the drive is connected as EtherCAT slave.

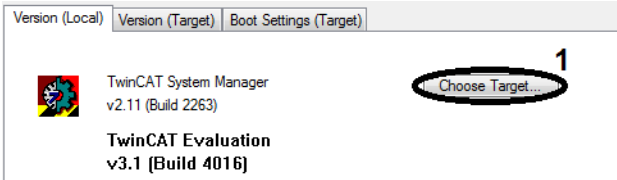

In the System Manager, open *System* and *press* *Choose Target...* (1).

The *Choose Target System* window opens. On the left there is a list of all known target systems, for which a route has already been entered.

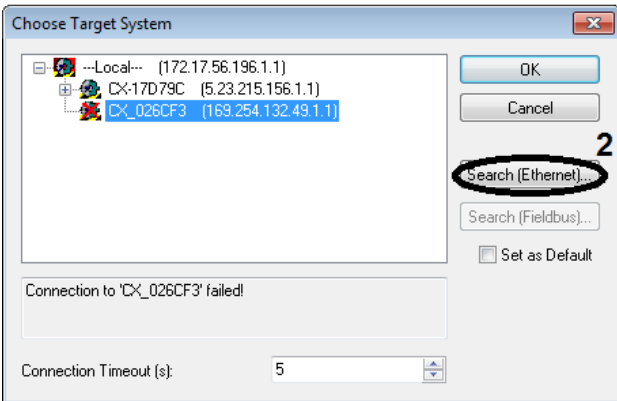

Further target systems can be found via *Search (Ethernet)* (2), if the system is not listed under the known systems.

This opens the window *Add Route*.

Before starting the search for more target systems, set the IP address as *Address Info* (3).

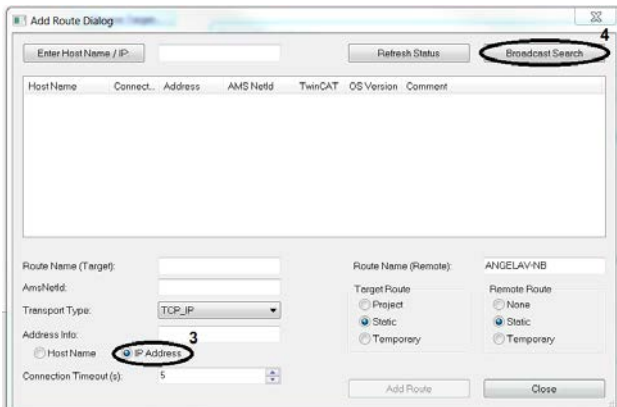

Start the search with *Broadcast Search* (4).

A list with all target systems that were found is displayed.

Select the required target system.

For a CX the name CX_abcdef is assigned by default; abcdef represent the last 6 digits of the MAC ID, which is printed on the name plate.

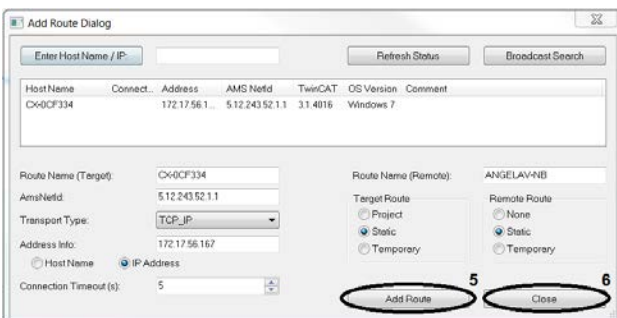

Create link using *Add Route* (5).

You will see a password prompt for the Embedded PC.

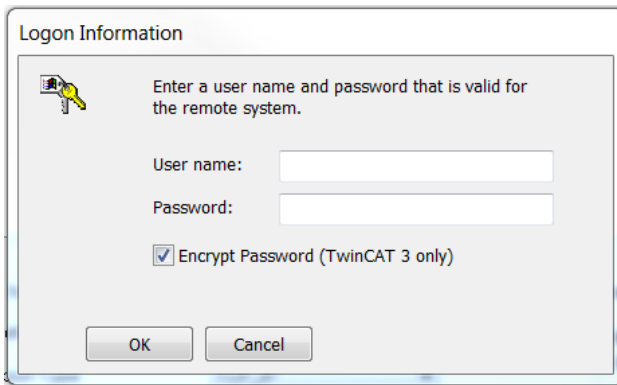

Enter the required password (The Beckhoff default password for Windows 7 is "1").

Confirm with *OK*.

Close the *Add Route* window with Close (6).

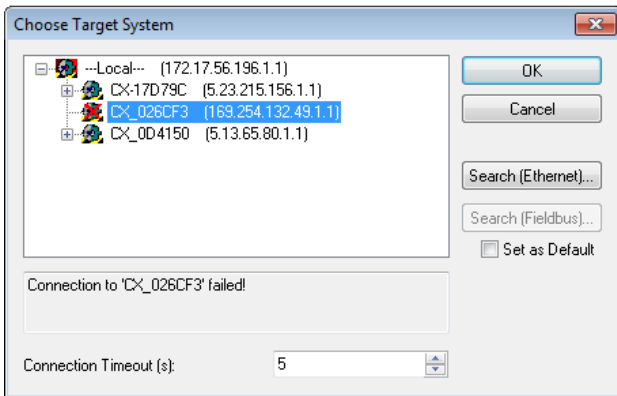

Select the newly added target system.

Press *OK* to confirm your selection.

→ *The target system is selected.*

Adding EtherCAT master and drives

You can implement your drive in your TwinCAT project either manually or via an automatic scan. It is advisable to scan, because this will insert the required drive devices directly into the project.

TwinCAT in ConfigMode

To start the scanning process, TwinCAT must be in *ConfigMode*. *ConfigMode* is one of several TwinCAT states, which is displayed in the status bar of the System Manager. If the text is highlighted in blue, *ConfigMode* is activated, and the scan can be started. If the text is highlighted in green or red, follow these steps:



Click the blue gear icon in the toolbar. You will see a query regarding the state change to be carried out. Confirm the state change with OK.

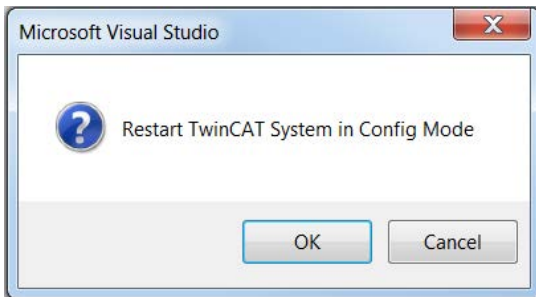

TwinCAT switches to ConfigMode, and the text highlighting in the status bar turns blue. TwinCAT is in ConfigMode.

Start drive scanning

If the right target system and *ConfigMode* are enabled, the scan can be started.



In the System Manager select *I/O - Configuration* → *I/O Devices*. Press the *Scan* in the toolbar or right-click on *I/O Devices* and select *Scan Devices...* In both cases, the following sequence starts: Close the information window with OK.

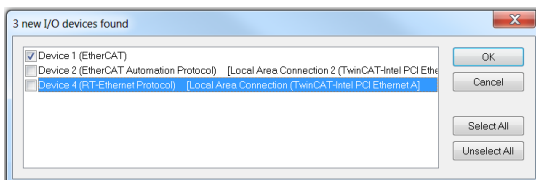
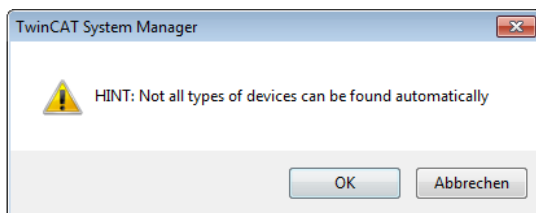

Select the devices to be automatically added to the TwinCAT project. As a minimum, select the device with the supplement (*EtherCAT*). Complete the selection with OK.

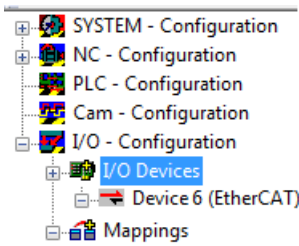

In the System Manager all selected devices are shown below the "I/O Configuration" icon.

Confirm the subsequent query whether the boxes should be scanned with Yes

If the query is answered in the negative, no boxes / EtherCAT slaves and therefore no drives are scanned.

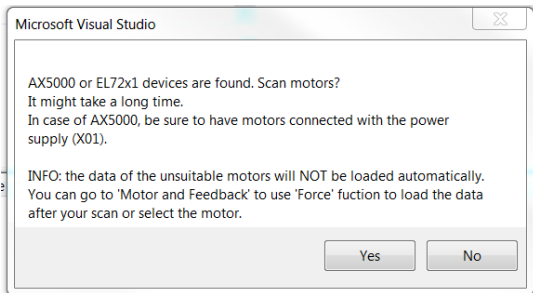
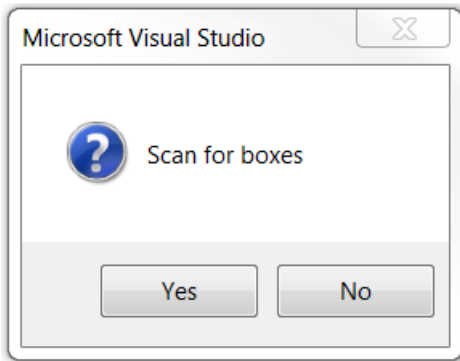

The message regarding a found servo drive or servo terminal can trigger a special scan for motors. Reads the electronic type plates of the motors and enters the data directly in the TCDriverManager.

Confirm the query with Yes to read the electronic type plates.

If the query is not confirmed, no name plates are read. In this case, the motor types must be entered manually. See [Determining the motor type \[► 118\]](#).

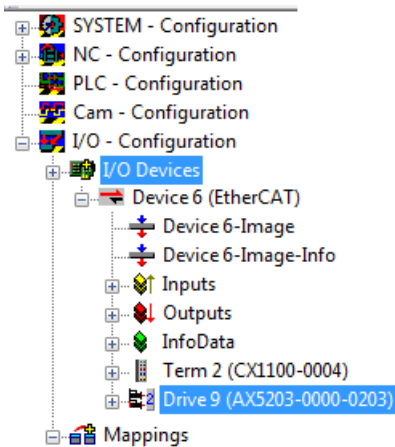

Wait for the scan to complete.

The System Manager then shows the servo drives and terminals that were found. To control the motors via the TwinCAT project, an NC or CNC axis configuration has to be created.

Confirm the query with Yes to create an NC axis configuration.

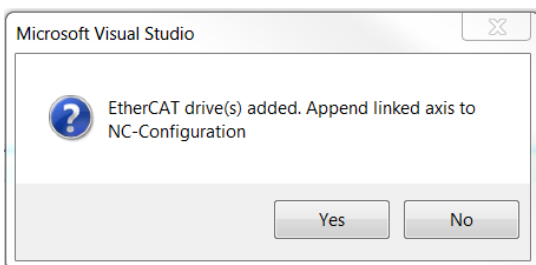

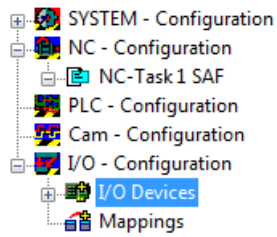

As a result of the automatic axis configuration creation, an axis is added for each motor that was found and linked accordingly.

If you require a CNC axis, close the window with *No* and create the configuration manually. See [Create NC axis configuration](#) [► 121].

The created NC axis configuration is shown in the System Manager.

Decline the request to activate Free Run with *No*.

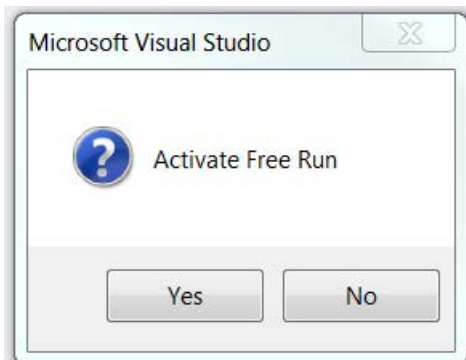

→The drive is fully implemented in the TwinCAT project.

Also see about this

📄 [Configuring devices](#) [► 118]

Configuring devices

Determining the motor type

If a motor has no electronic name plate or the offer to scan for motors was declined, the motor type has to be entered manually in the TCDriveManager.

Opening the TCDriveManagers

- In the System Manager, under I/O configuration → I/O devices, select the EtherCAT master, to which the AX5000 units are connected. In this example select "Device 6" for the AX5000. Here, open "Drive 9" (1).
- Open the Configuration tab (2).

→ The TCDriveManager is open.

Motor settings

In the *Configuration* tab, a tree structure is shown on the left, which can be used to navigate to the individual dialog pages. To check or set the motor type, edit the motor and feedback settings (3).

- Open either Channel A or Channel B → Parameter → Motor and Feedback (3).
The motor and feedback settings appear to the right of the tree.
If the fields Motor type (4) and Feedback 1 type (5) are empty, this may have two reasons:
 1. The motor does not have an electronic name plate: [Determine the motor without electronic type plate \[► 119\]](#)
 2. The motor has an electronic name plate: [Determine the motor with electronic type plate \[► 120\]](#)

Determine the motor without electronic type plate

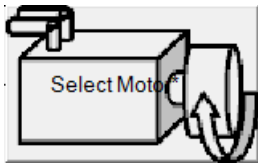

Press the Select Motor button to add the motor type. A selection window opens, which shows all motor versions and their properties.

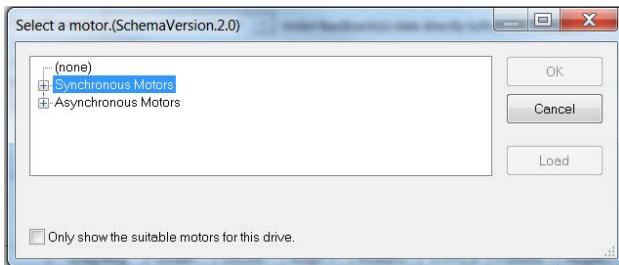

Look for the motor of your drive in the list.

Confirm the selection with **OK**.

A further window appears, in which you have to select or set the mains voltage to which the AX5000 is connected.

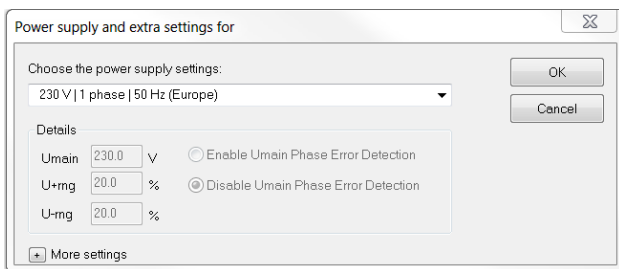

Make the required settings.

Confirm the selection with **OK**.

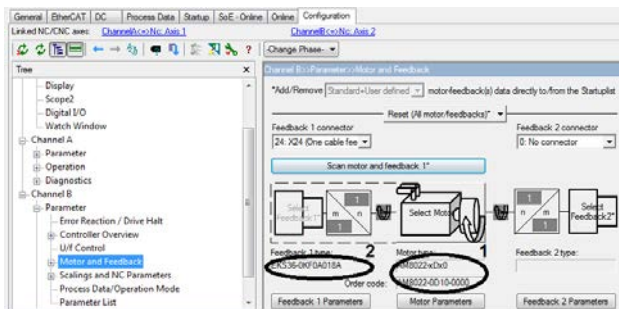

Selecting a motor type makes it appear in the Motor type field (1). When the motor type is selected, the encoder system used in this motor type also becomes known and is shown in the field Feedback 1 type.

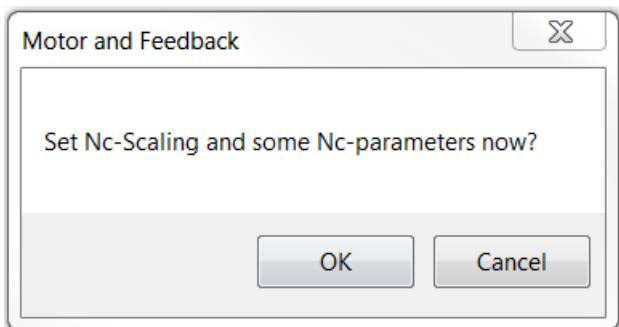

When the motor type is specified, a further query appears, as to whether the NC or CNC parameters relating to this axis should also be set.

If you confirm this message with **OK**, you will be directed to the corresponding settings. See [Create NC axis configuration](#) |> 121].

→ The motor type is set.

Determine the motor with electronic type plate

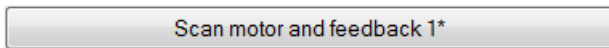

Press the “Scan motor and feedback 1*” button.

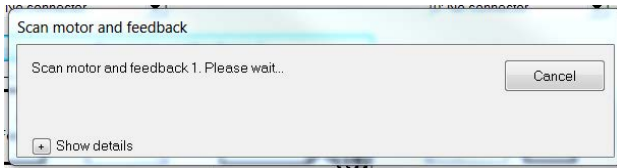

Wait until the loading process is complete and the window closes.
A window opens, in which the feedback type that was determined is displayed.

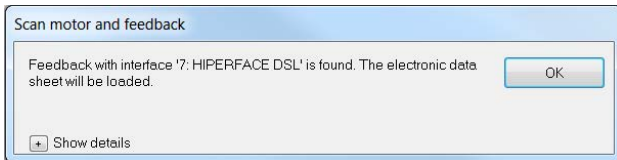

Confirm the display with *OK*.

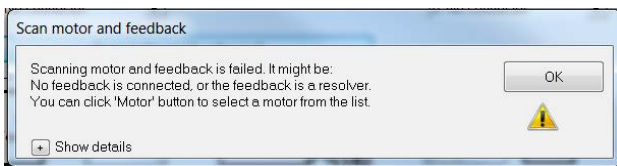

If this error message appears, instead of the message about the determined feedback type, this may be because your scanned motor has no electronic name plate.

In this case, proceed as described under [Determine the motor without electronic type plate](#) [► 119].

→ *The electronic name plate is read, and the motor type and the feedback type have been determined.*

Create NC axis configuration

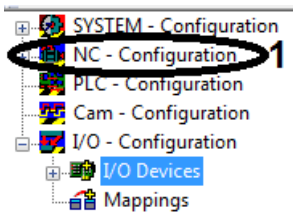

Right-click on NC – Configuration (1) in the System Manager.

Select *Insert Task...*

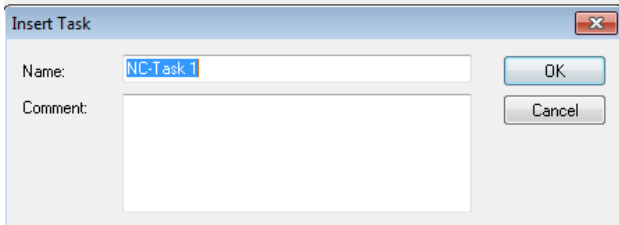

Name the NC task

Confirm the entry with *OK*.

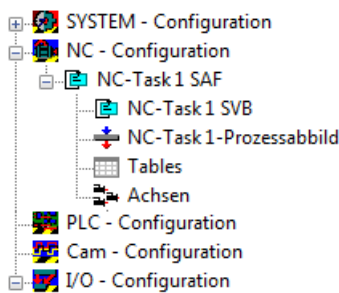

The System Manager expands below the *NC configuration* to show the added NC task. The logical NC axes can now be added below the Axes icon.

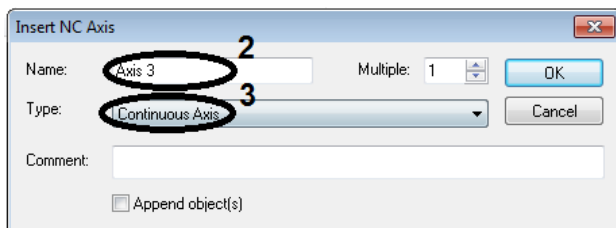

Right-click on *Axes* within the axis configuration.

Select *Append Axis....*

Enter a name for the NC axis (2).

Determine the axis type (3).

Confirm with *OK*.

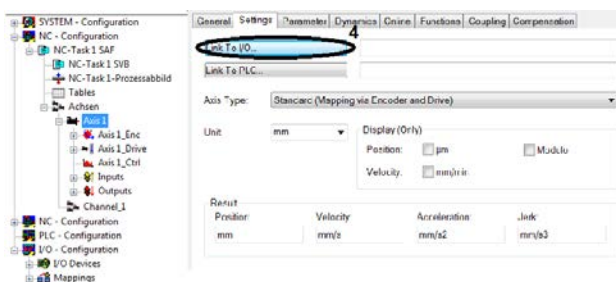

In the System Manager the new axis appears with its name within the NC axis configuration. Now link the logical NC axes with the physical axes (the channels of the respective AX5000).

Open *Axis 1* in the System Manager tree

Switch to the *Settings* tab

Link the NC axis with the hardware axis via *Link To I/O...* (4).

Select the AX5000 channel to be linked from the list. You can filter the list based on the channel link status. The filter *Unused* (5) only shows channels that are not linked. The setting *All* (5) shows all channels, irrespective of their link status.

Confirm the selection with *OK*.

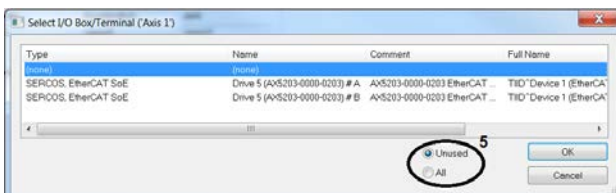

Create CNC axis configuration

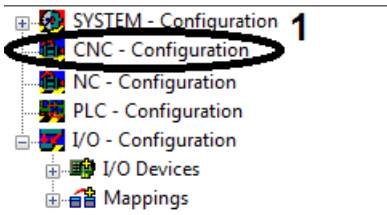

Right-click on CNC – Configuration (1) in the System Manager.

Select *Inert Task* in the context menu...

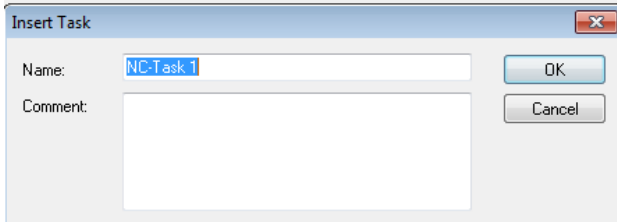

Name the CNC task

Confirm the entry with *OK*.

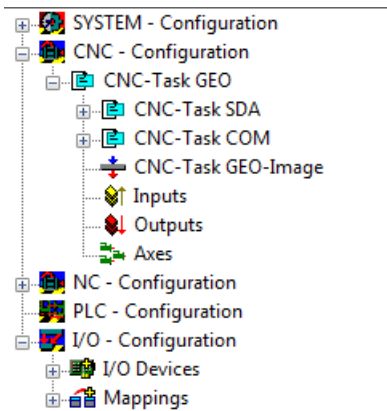

The System Manager expands in the *CNC Configuration* section to show the added CNC task. The logical CNC axes can now be added below the Axes icon.

Right-click on *Axes* within the axis configuration.

Select *Append Axis...*

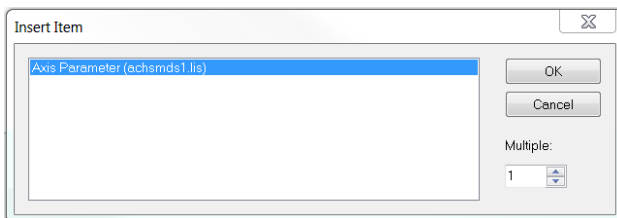

Select the axis type from the list.

Confirm the selection with *OK*.

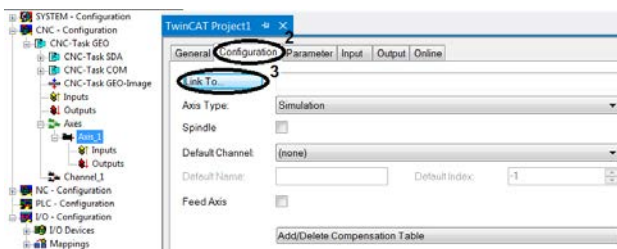

In the System Manager the new axis appears with its name below the CNC task. Link the CNC axes with the drive, in order to enable control.

Open *Axis_1* in the System Manager.

Open the Configuration tab (2).

Link the CNC axis with the hardware axis via *Link to I/O...* (3).

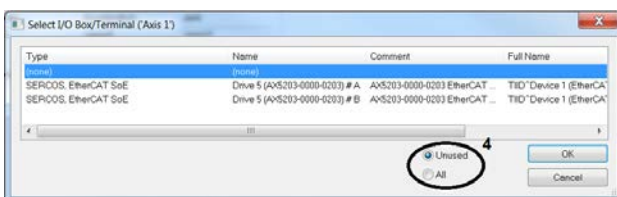

Select the axis to be linked from the list
You can filter the list based on the axis link status.

The filter *Unused* (4) only shows axes that are not linked. The setting *All* (4) shows all axes, irrespective of their link status.

Confirm the selection with *OK*.

Specifying the scaling factor

The scaling factor is an application-related parameter, which is required for converting the position representations between the NC and the AX5000. The NC is usually parameterized in the application unit (e.g. degree). The AX5000 operates with a position representation of 2^x increments per revolution (with $x = [20...31]$). If, for example, a motor revolution corresponds to an application revolution (360 degrees), and $x = 20$ was selected, the resulting scaling factor is $360 \text{ degrees} / 2^{20}$.

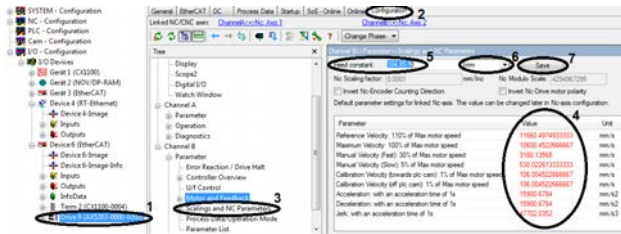

In the System Manager tree, open I/O –Configuration → I/O Devices → Device 6 → Drive 9 (1).

Open the TCDriverManager via the Configuration tab (2).

In the TCDriverManager tree select Channel B → Parameter → Scalings and NC Parameters (3).

A table with different NC parameters and the corresponding values (4) can be found to the right of the TCDriverManager tree. Since the initial parameter values are default values that were not explicitly saved by the user, they are regarded as invalid and therefore shown in red font. The individual parameter values depend on the scaling factor, so that all parameter values can be adjusted by modifying the scaling factor.

Adjust the scaling factor via the field Feed constant (5).

Select the unit (6).

Confirm the change with Save (7).

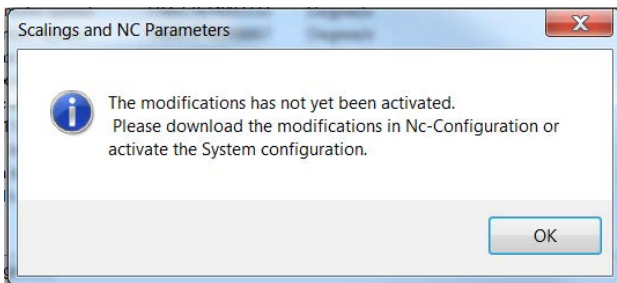

Acknowledge the information window with OK.

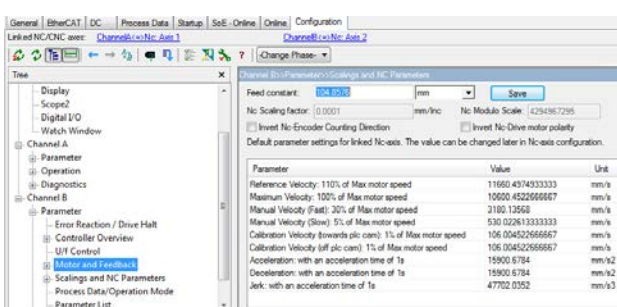

By confirming the change, the parameter values and their units are adjusted to the new reference value and appear in black font.

→ Your motor parameters are set correctly.

The configuration of Channel A follows the same procedure as for Channel B.

Specifying velocities

Checking the scaling factor

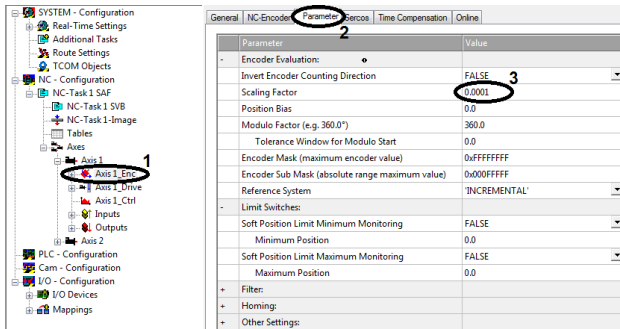

In the System Manager, open NC- Configuration → NC-Task 1 SAF → Axes → Axis 1 → Axis 1_Enc (1).

Open the Parameter tab (2).

Compare the value of the Scaling Factor (3) with the value of the scaling factor.

If the value does not match the scaling factor, select the field (3) and enter the scaling factor.

ATTENTION: Please ensure decimal points are used, not decimal commas, as used in Germany!

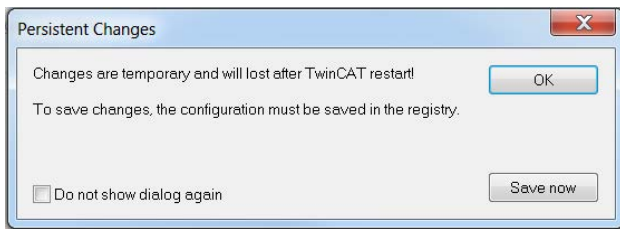

Save changes permanently with *Save now*.

Wait a moment and close the window with *OK*.

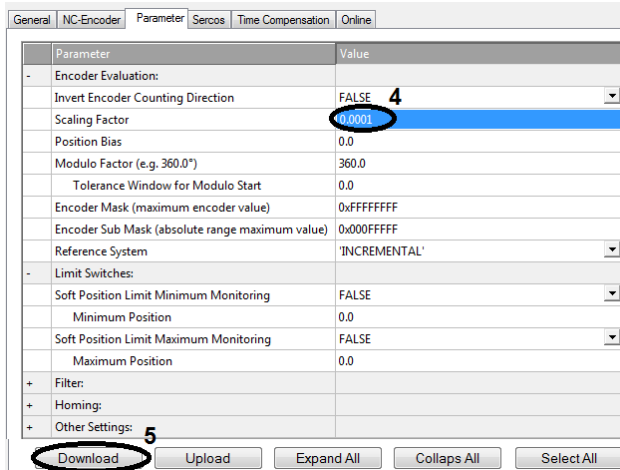

The value change is indicated by the blue color of the field (4).

Select the field with the changed value (4) to activate the Download button (5).

Press Download (5) to save the change.

Another window appears:

Check the value for the second axis.

Setting the velocities

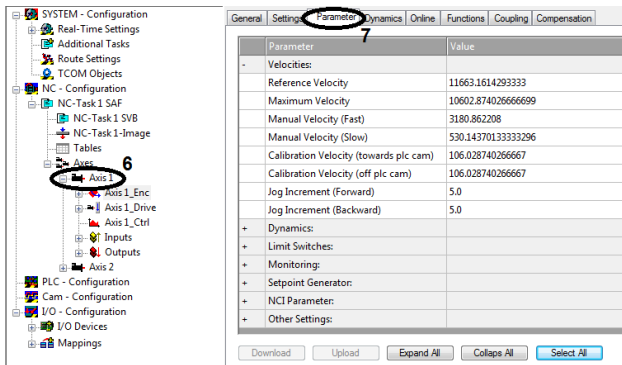

In the System Manager, open NC – Configuration → NC-Task 1 SAF → Axes → Axis 1 (6).

Open the Parameter tab (7).

Set the velocities as required.

ATTENTION: Please ensure decimal points are used, not decimal commas, as used in Germany!

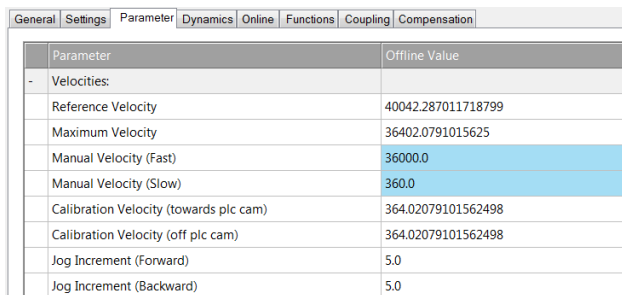

The value change is indicated by the blue color of the field.

→ The velocities are adjusted and take effect with the next configuration.

Parameter	Description
Reference Velocity	The reference velocity must be set to a value \geq the "maximum velocity".
Maximum Velocity	Maximum velocity (= max. velocity of the NC motion command)
Manual Velocity (Fast)	Velocity in the manual test menu (F1 and F4)
Manual Velocity (Slow)	Velocity in the manual test menu (F2 and F3)
Calibration Velocity (towards plc cam)	Homing velocity
Calibration Velocity (off plc cam)	Homing velocity

Test mode

To test the TwinCAT project with all its settings on the drive, the settings have to be transferred to the runtime system. To this end the whole configuration must be loaded into the runtime system of the target hardware (e.g. a CX2000) and started there. After successful configuration, the motor control can be tested manually in manual mode.

Before commissioning the manual control, it is advisable to check the control status of the drive.

Configure drive

Before you can start the controller, you must transfer the TwinCAT settings to the target system. To do this, activate the configuration.



Click the Activate Configuration icon in the toolbar.

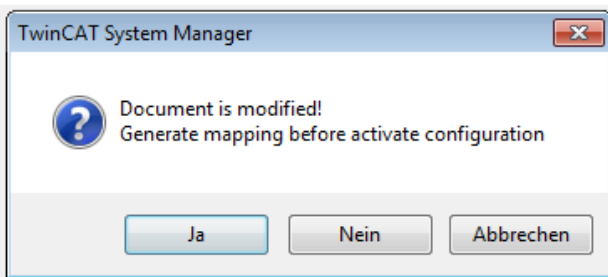

Confirm the warning with Yes.

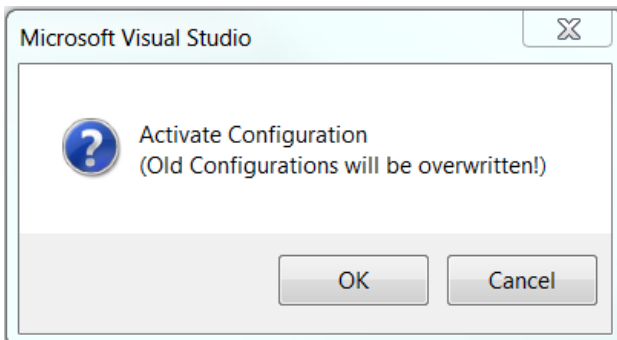

Start the configuration with OK.

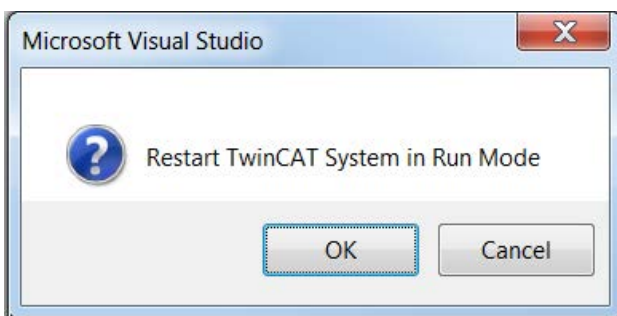

Start Run mode with OK.



Wait until the text highlighting turns green. Only then is the application in Run mode.

→ All your settings were transferred to the runtime system. The drive is ready for operation.

Checking the state

In the first step it makes sense to check the EtherCAT communication state of the system.

The screenshot shows the TwinCAT Project1 interface. On the left, the 'I/O - Configuration' tree is expanded to 'I/O Devices', where 'Device 6 (EtherCAT)' is selected and circled with a '1'. The main window shows the 'Online' tab circled with a '2'. A table of device states is circled with a '3', and the control buttons for the 'Actual State' are circled with a '4'.

No.	Ad...	Name	State	CRC
1	1001	Term 2 (EL1859)	OP	0,0
2	1002	Term 3 (EL3255)	OP	0,0
3	1003	Term 4 (EK1110)	OP	0,0
4	1004	Drive 5 (AX5203-0000-0203)	OP	0

Counter	Cyclic	Queued
Send Frames	390165 +	24824
Frames / sec	499 +	16
Lost Frames	0 +	0
Tx/Rx Errors	0 /	0

- In the System Manager, open I/O – Configuration → I/O Devices → Device 6 (EtherCAT) (1).
- Open the Online tab (2).
All slaves of the selected EtherCAT master and its communication states are displayed (3).
- Use the "buttons" in (4) to change the EtherCAT state of the master.
To ensure smooth operation, the states of all devices should be *OP* (see *State* status column the table (3)).

→ Your system is checked and ready for operation.

Activating manual control

TwinCAT has a manual test menu, which allows you to start the drive manually in a test mode. The manual test menu can be called up via the drive (*Devices*) or via the axis configuration.

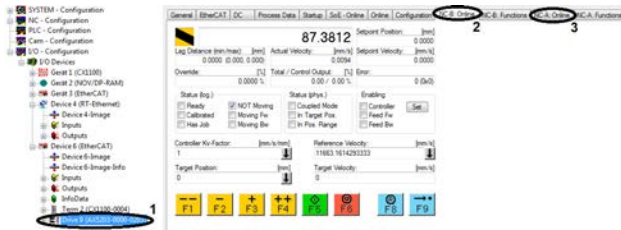

Manual test menu for drive

In the System Manager, open I/O - Configuration → I/O Devices → Device 6 → Drive 9 (1).

Switch to tab NC-B: Online (2) or NC-A: Online (3). In this case you would test the drive for axis 2 by selecting NC-B: Online (2). Select NC-A: Online (3) to test axis 1.

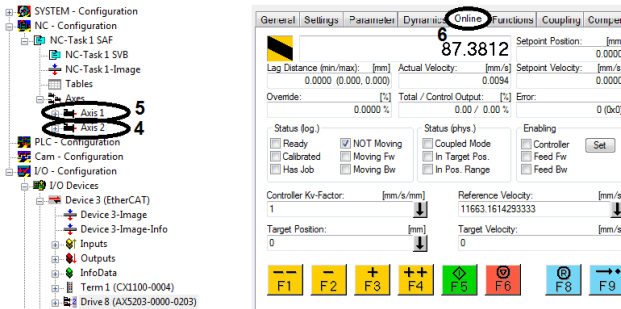

Manual test menu for axis configuration

In the System Manager, select NC - Configuration → NC-Task 1 SAF → Axes → Axis 2 (4) or Axis 1 (5). Depending on which of the two axes is to be tested.

Open the Online tab (6).

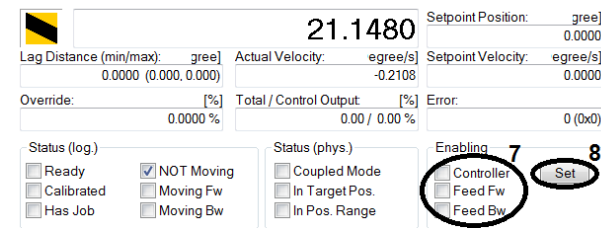

Setting the drive enables

To operate the motors manually, manual drive control must be enabled. The control is activated when Enabling Controller (7) is active. In addition, the drive requires Enabling Feed Fw** (7) activated for forward travel, and Enabling Feed Bw (7) for reverse travel.

Use the Set button (8) to change the settings.

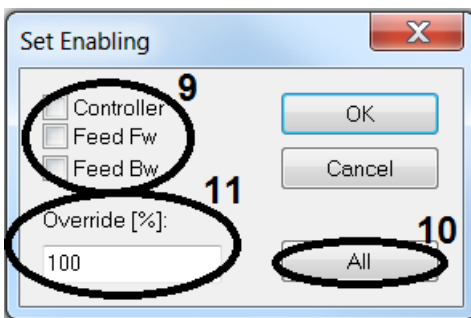

Use the All (10) button to set all settings and the override (11) to 100%, or all settings can be specified manually:

Tick the individual options (9) to activate them.

Enter the Override value (11).

The override (11) scaled the set velocity of the NC motion command. The *Override* value can be between 0% and 100%.

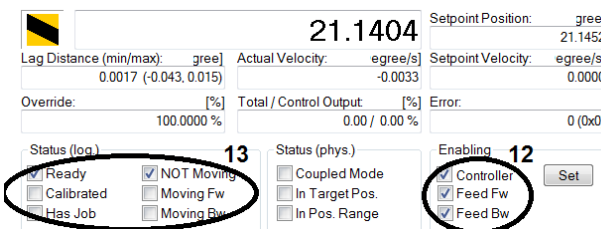

In the function view, the activated options are indicated by ticks (12). In addition, the Status (log.) (13) has changed with the activation, and the override has been entered. The drive is ready for operation and can be controlled with the manual mode menu.

*If this flag is set, the system tries to activate the drive control (of the AX5000) and to set the drive to a state in which it follows the set value specifications of the NC. The "Ready" flag is set if the drive acknowledges this request as successful.

**These so-called direction enables make it possible for the NC to accept motion commands in the respective direction. The drive does not see these two flags.

Manual control guide

The drive can be controlled using the buttons F1 to F9 and the fields *Target Position* and *Target Velocity*.

The screenshot displays a manual control interface with the following elements:

- Position:** 21.1339
- Actual Velocity:** -0.3543
- Setpoint Position:** 21.1415
- Setpoint Velocity:** 0.0000
- Lag Distance (min/max):** 0.0051 (-0.043, 0.015)
- Override:** 100.0000 %
- Total / Control Output:** 0.00 / 0.00 %
- Error:** 0 (0x0)
- Status (log.):**
 - Ready
 - Calibrated
 - Has Job
 - NOT Moving
 - Moving Fw
 - Moving Bw
- Status (phys.):**
 - Coupled Mode
 - In Target Pos.
 - In Pos. Range
- Enabling:**
 - Controller
 - Feed Fw
 - Feed Bw
- Controller Kv-Factor:** 1
- Reference Velocity:** 40033.1411132813
- Target Position:** 0
- Target Velocity:** 0

At the bottom, there are nine function buttons: F1 (Reverse Fast), F2 (Reverse Slow), F3 (Forward Slow), F4 (Forward Fast), F5 (Start Direct Travel), F6 (Stop Direct Travel), F8 (Reset), and F9 (Home).

The following table provides an overview of all manual mode functions.

Function	Description
F1	Reverse travel with <i>Manual Velocity (Fast)</i>
F2	Reverse travel with <i>Manual Velocity (Slow)</i>
F3	Forward travel with <i>Manual Velocity (Slow)</i>
F4	Forward travel with <i>Manual Velocity (Fast)</i>
F5	Start a direct travel command <ul style="list-style-type: none"> • Enter the <i>Target Position</i> • Enter the <i>Target Velocity</i> • Start the travel command with F5
F6	Stop a direct travel command
F8	NC reset; the current motion command is aborted.
F9	Initiate homing (see TwinCAT documentation)

Typical error messages

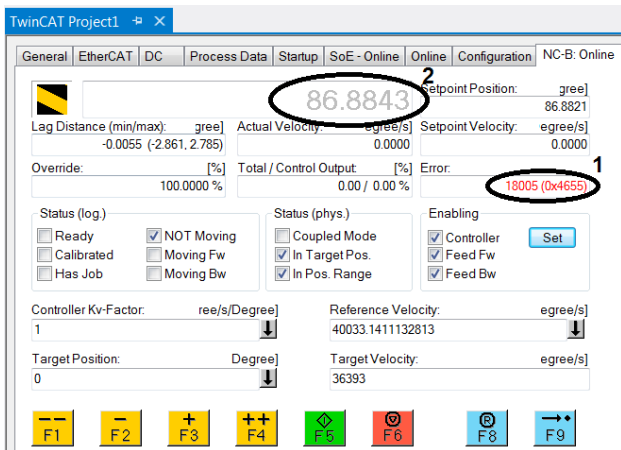

If you are in the manual mode menu and the position value (2) is greyed out, this has the following reason: A greyed out shown actual position for EtherCAT drives indicates a "WC state error". In this case, the WC state flag generated by the EtherCAT master is "true", which means that the NC does not receive valid position data from the drive.

The corresponding EtherCAT drive is probably not in EtherCAT state SafeOp or Op. Further analysis is required to ascertain why the drive is not in this state.

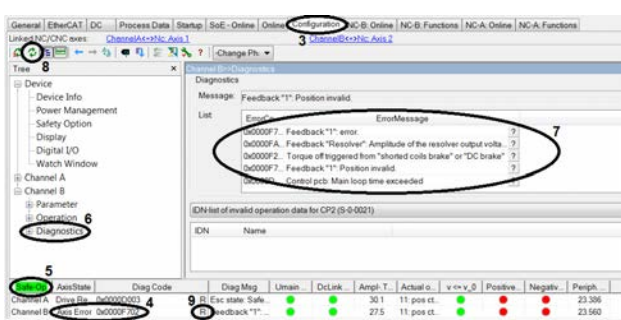

To investigate further, open the TCDriveManager via Configuration (3). In the status bar, another error code is shown at Diag Code (4). Check the drive state (5). Select Diagnostics (6) from the tree structure, in order to obtain further information about the error. A list (7) on the right shows the whole error history. Update the list via the button with the two green arrows (8). Once the cause is identified and corrected, reset the axis via the R button (9).

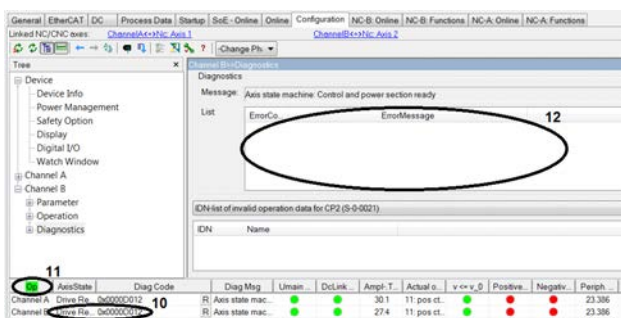

After a short time, the error indication will disappear from the status line for the axis (10), and the drive will be in OP state (operational) (11). Update the list of error messages once more (8). It should contain no more error messages (12).

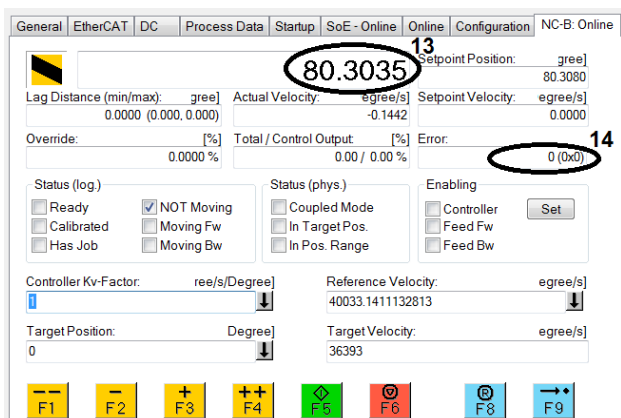

In the manual mode menu for the axis, the position value (13) is shown in black again.

Press the F8 button to acknowledge the NC error (14) in the manual mode menu.

The drive is ready for operation again when the "Ready" flag is set.

9.1.3.2 Commissioning under TwinCAT 3

This tutorial describes the procedure for commissioning the servo drive AX5000. All the steps shown are based on TwinCAT Version 3. The individual chapters build on each other and should be followed sequentially.

The tutorial shows a possible approach as an example. Alternative approaches are possible, which are referred to in several places.

Creating a project

Open TwinCAT in the Windows Start menu.

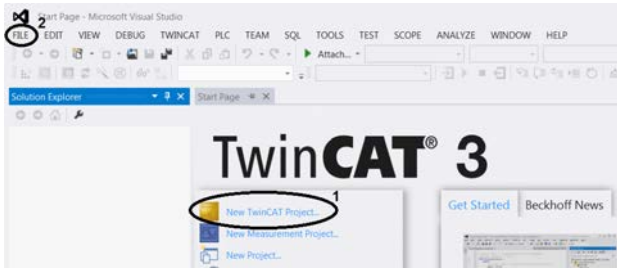

Create a new project using the option New TwinCAT Project ... (1) on the start page.

If TwinCAT opens without the start page shown on the left, create a new project via the menu bar: File (2) → New → Project.

In both cases, the window for creating a project will open.

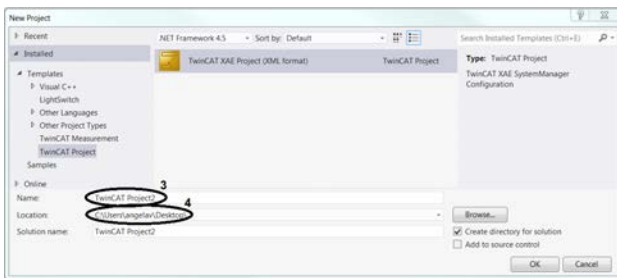

Assign project name (3).

Specify storage location (4).

Confirm with OK.

→ The new project appears with the Solution Explorer on the left and the workspace on the right.

Select target system

Target system available in selection list

In order to control your drive with TwinCAT, the software needs to communicate with the hardware. To this end, the drive has to be selected as target system for the TwinCAT project.



The toolbar indicates which target system is active (1).

Open the selection list using the small arrow (2) to the right of the display window.

Select the drive as the target system.



Confirm query with Yes to change the platform settings automatically.

This setting can be found in the toolbar (3). If you answer No, this setting must be made manually:

Open the platform selection list via the small arrow (4) to the right of the display window (3).

Select a system-compatible platform.

→ The newly selected target system appears in the display window (1).

→ The newly selected platform appears in the display window (3).

Target system not available in selection list

If the target system is not in the list, follow these steps:

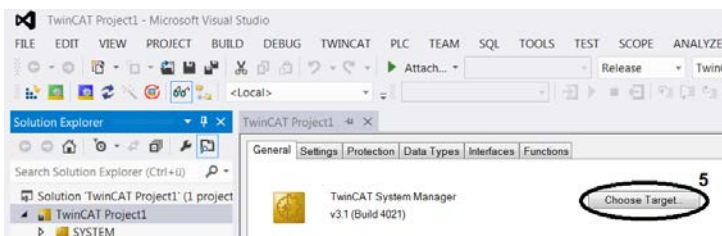

Choose Target System... select from the list, or open *System* in the Solution Explorer and press *Choose Target...* (5).

Both options take you to the *Choose Target System* window. On the left is a list of all target systems already in use. This list should be identical to the previous selection list.

Find more target systems via *Search (Ethernet)* (6).

This opens the window *Add Route*.

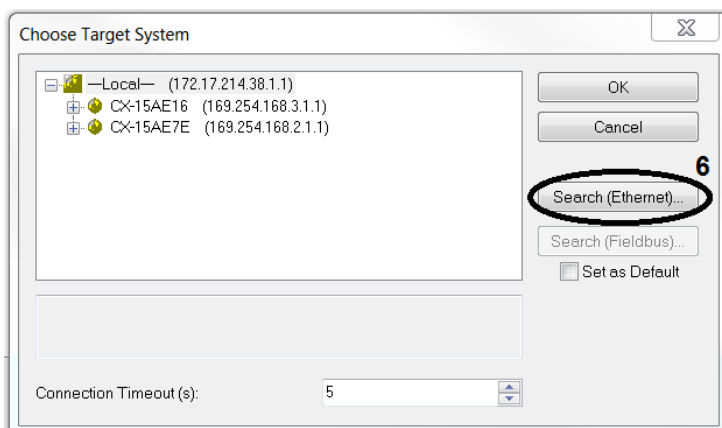

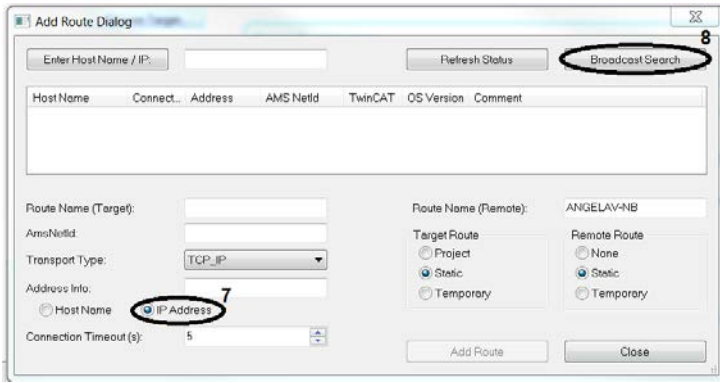

Before starting the search for more target systems, set the IP address as *Address Info* (7).

Start the search with Broadcast Search (8). A list with all target systems that were found is displayed.

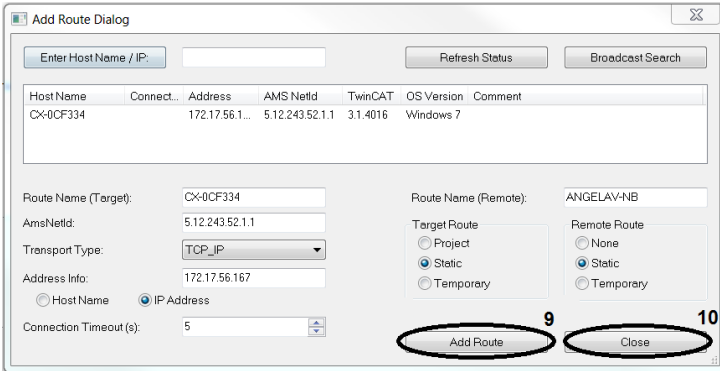

Select the required target system.

Create link using Add Route (9). You will see a password prompt for the Embedded PC.

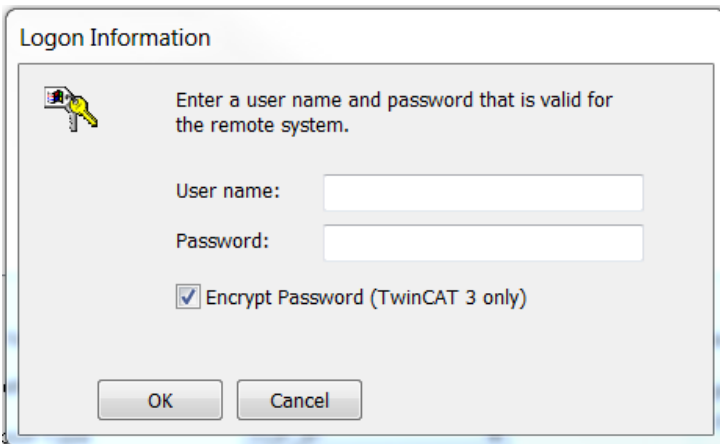

Enter the required password (The Beckhoff default password for Windows 7 is „1“).

Confirm with *OK*.

Close the *Add Route* window with Close (10).

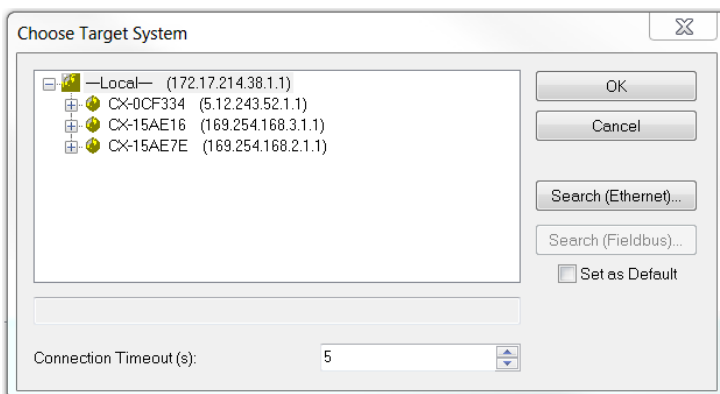

Select the newly added target system.

Press *OK* to confirm your selection.

Because the platform to be used depends on the respective target system, the platform also needs to be adjusted if the target system is changed.

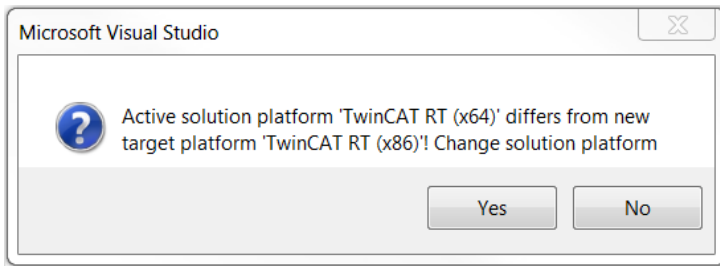

Confirm query with **Yes** to change the platform settings automatically. This setting can be found in the toolbar (3). If you answer **No**, this setting must be made manually:

Open the platform selection list via the small arrow (4) to the right of the display window (3).

Select a system-compatible platform.

→ The newly selected target system appears in the display window (1).

→ The newly selected platform appears in the display window (3).

Implementing devices

You can implement your drive in your TwinCAT project either manually or via an automatic scan. It is advisable to scan, because this will insert the required drive devices directly into the project.

TwinCAT in ConfigMode

To start the scanning process, TwinCAT must be in *ConfigMode*. *ConfigMode* is one of several TwinCAT states, which can be identified by the small gear icon in the status bar at the bottom of the screen. If the icon is blue, *ConfigMode* is activated, and the scan can be started. If the icon is green or red, follow these steps:



Click the blue gear icon in the toolbar.

You will see a query regarding the state change to be carried out.

Confirm the state change with **OK**.

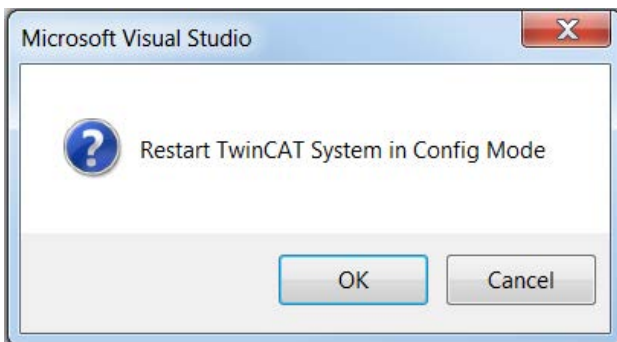

TwinCAT switches to *ConfigMode*, and the icon in the status bar turns blue.

→ *TwinCAT is in ConfigMode.*

Start drive scanning

If the right target system and *ConfigMode* are enabled, the scan can be started.



In the Solution Explorer select *I/O* → *Devices*. Press the *Scan* in the toolbar or right-click on *Devices* and select *Scan*. In both cases, the following sequence starts: Close the information window with *OK*.

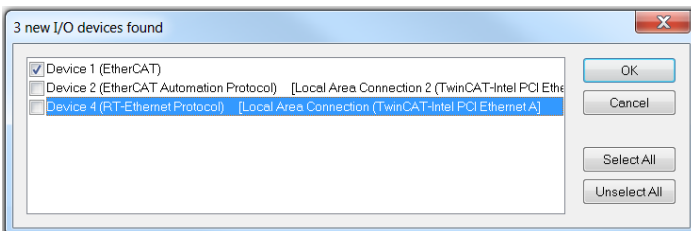
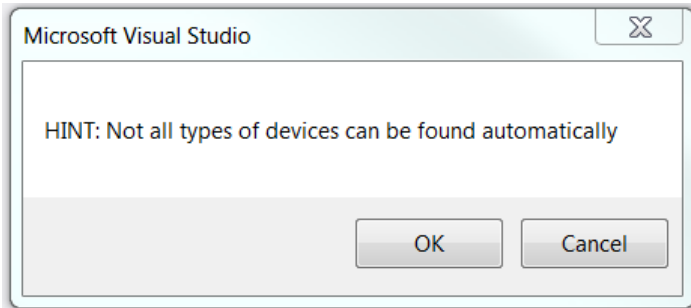

Select the devices to be automatically added to the TwinCAT project.

As a minimum, select the device ending with (*EtherCAT*).

Complete the selection with *OK*. The Solution Explorer shows all selected devices.

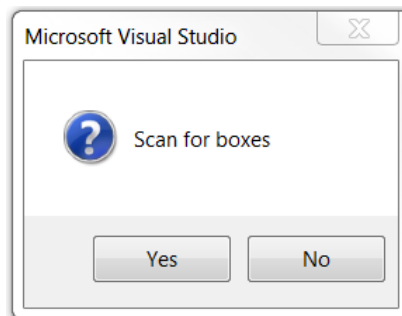
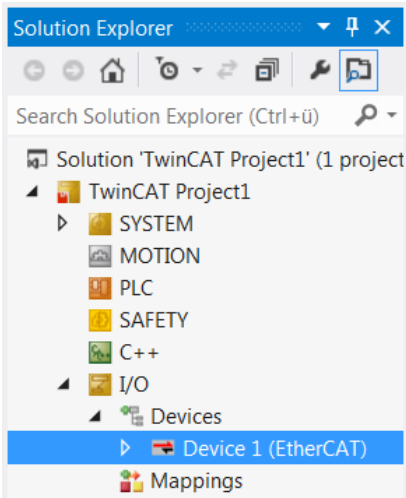

Confirm the following query with *Yes*. If you answer *No*, the scan is aborted. The message regarding a found servo drive or servo terminal can trigger a special scan for motors. This would read the electronic name plates of the motors and enter the data directly in the TCDriverManager.

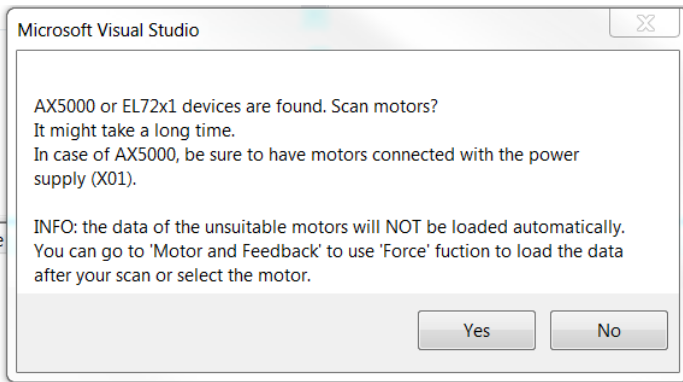

Confirm the query with Yes to read the electronic type plates. If the query is not confirmed, no name plates are read. In this case, the motor types must be entered manually. See [Determining the motor type](#) [▶ 137].

Wait until the scan is complete. The Solution Explorer then shows the servo drives and terminals that were found.

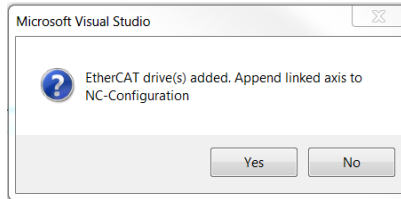
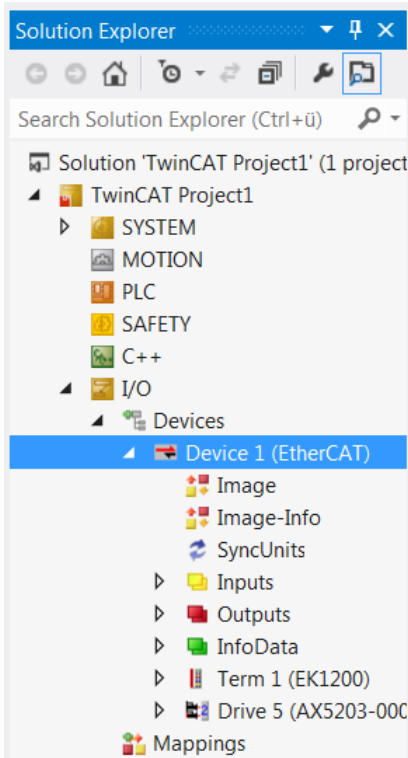

To control the motors via the TwinCAT project, an NC or CNC axis configuration has to be created. Confirm the query with Yes to create an NC axis configuration. As a result of the automatic axis configuration creation, an axis is added for each motor that was found and linked accordingly. If you require a CNC axis, close the window with No and create the configuration manually. See [Create axis configuration](#) [▶ 140].

The created NC axis configuration is shown in the Solution Explorer.

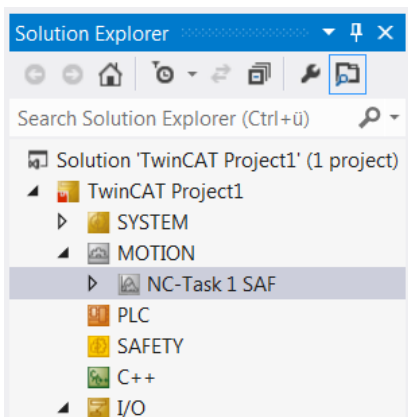

Decline the request to activate Free Run with No.

→The drive is fully implemented in the TwinCAT project.

i Free Run mode

Free Run mode is used for synchronising the axes, if no NC is available. When NC is used, a triggering task is activated, which synchronises the axes. This is not available if the system is operated without NC. In Free Run mode a virtual task is created, which enables axis synchronisation and reading of I/O data.

If the system is in Free Run mode, the blue and red status bar icons flash alternately.



Also see about this

Configuring devices [▶ 137]

Configuring devices

Determining the motor type

If a motor has no electronic name plate or the offer to scan for motors was declined, the motor type has to be entered manually in the TCDriveManager.

Opening the TCDriveManagers

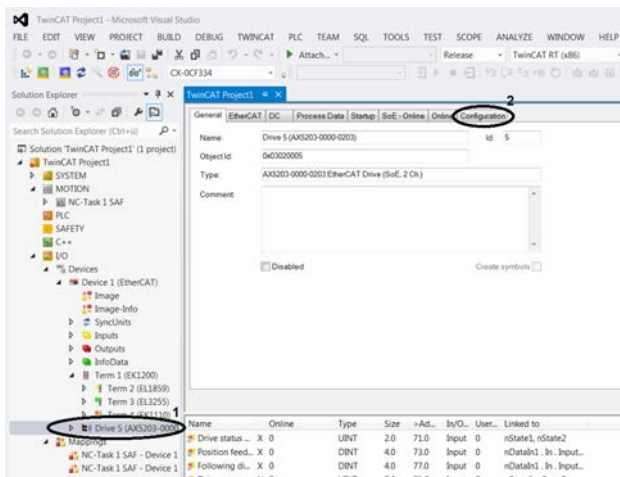

In the Solution Explorer, open I/O → Devices → Device 1 → Drive 5 (1).

Open the Configuration tab (2).

→ The TCDriveManager is open.

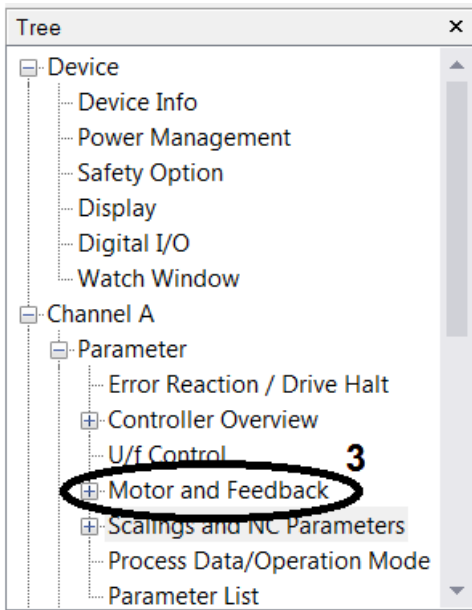

Motor settings

Under the *Configuration* tab you will see a tree structure on the left-hand side, which can be used for all the required settings.

To check or set the motor type, edit the motor and feedback settings (3).

Open either Channel A or Channel B → Parameter → Motor and Feedback (3).

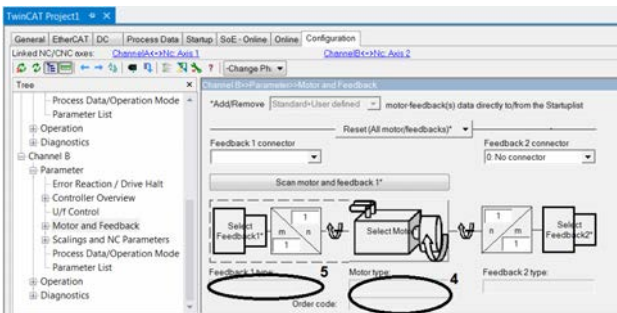

The motor and feedback settings appear to the right of the tree.

If the fields Motor type (4) and Feedback 1 type (5) are empty, this may have two reasons:

The motor does not have an electronic name plate: Determine the motor type without electronic name plate [► 139]

The motor has an electronic name plate that was not read: Determine the motor type with an electronic name plate that was not read [► 140]

Determine the motor type without electronic name plate

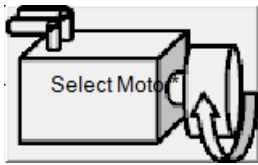

Press the Select Motor button to add the motor type. This opens a selection window that lists all the motor type versions and their features.

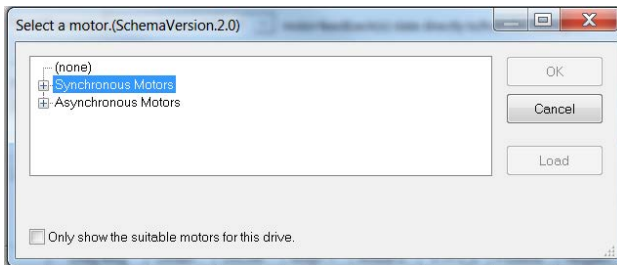

Look for the motor of your drive in the list. Confirm the selection with **OK**. Another window appears, in which you can make advanced settings.

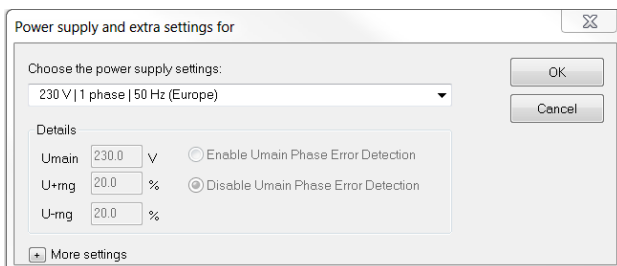

Make the required settings. Confirm the selection with **OK**.

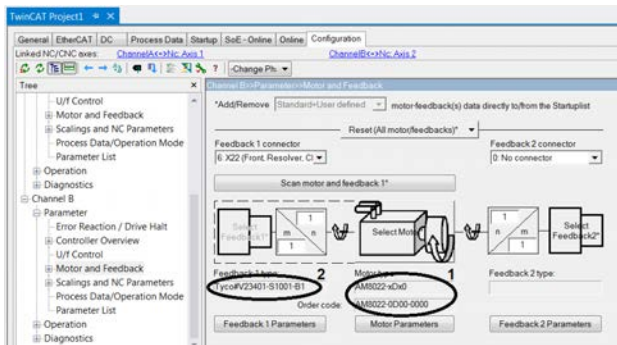

Selecting a motor type makes it appear in the Motor type field (1). The field Feedback 1 type (2) is completed automatically, since for each motor type a corresponding feedback type is stored in the TCDriveManager.

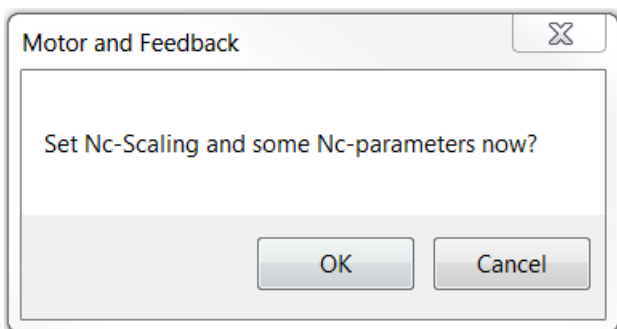

Once the motor type has been specified, a further query appears relating to the parameters of the axis configuration.

If you confirm this message with **OK**, you will be directed to the corresponding settings. See [Create axis configuration \[► 140\]](#).

→ The motor type is set.

Determine the motor type with an electronic name plate that was not read

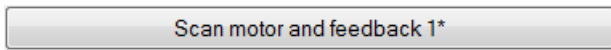

Press the “Scan motor and feedback 1*” button.

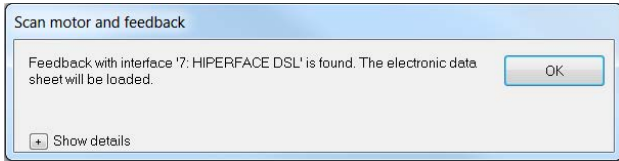

Wait until the loading process is complete and the window closes. A new window opens, in which the feedback type that was determined is displayed.

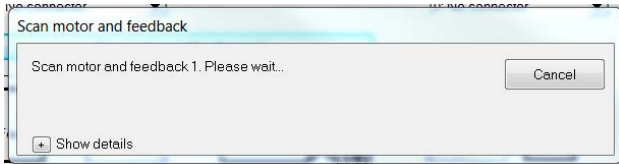

Confirm the display with OK.

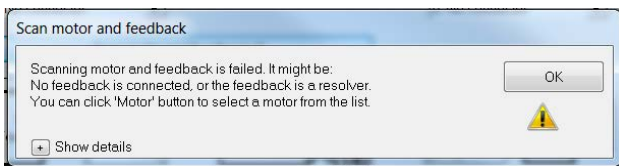

If this error message appears, instead of the message about the determined feedback type, this may be because your scanned motor has no electronic name plate.

In this case, proceed as described under Determine the motor type without electronic name plate [► 139].

→ The electronic name plate is read, and the motor type and the feedback type have been determined.

Create axis configuration

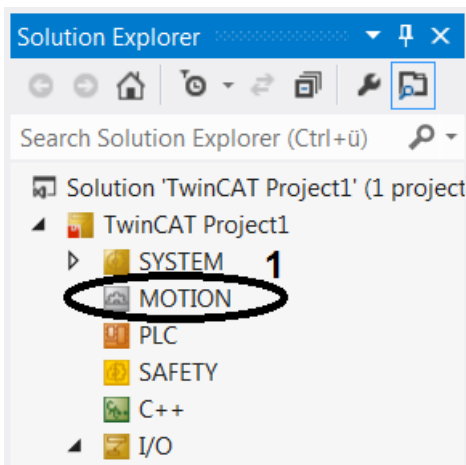

Right-click on Motion (1) in the Solution Explorer. Select *Add New Item...*

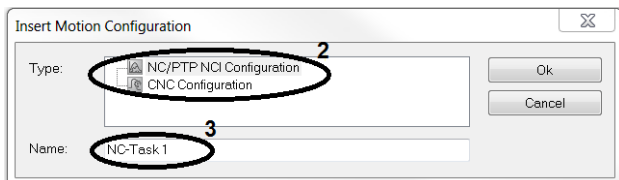

Select Type (2) for your axis configuration. Enter a name for the axis configuration (3). Click OK to create the axis configuration. The next steps depend on the axis type.

Creating an NC axis

If an NC axis configuration has already been created, the individual axes can be created and linked. The *Motion* section of the Solution Explorer expands and shows the new NC axis configuration.

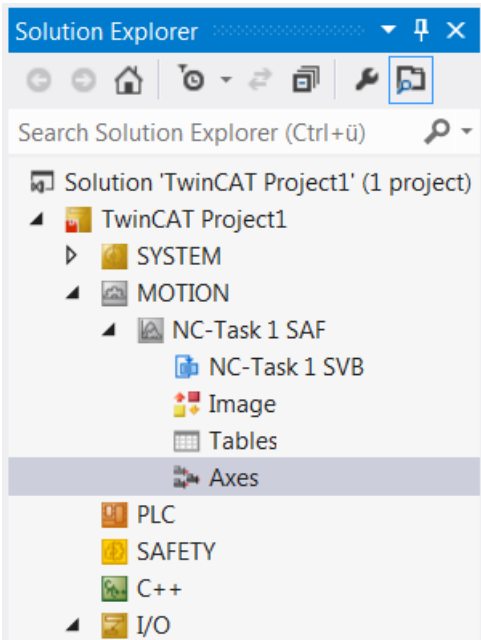

- Right-click on *Axes* within the axis configuration.
- Select *Add New Item....*
- Enter a name for the NC axis (1).
- Determine the axis type (2).
- Confirm with *OK*.

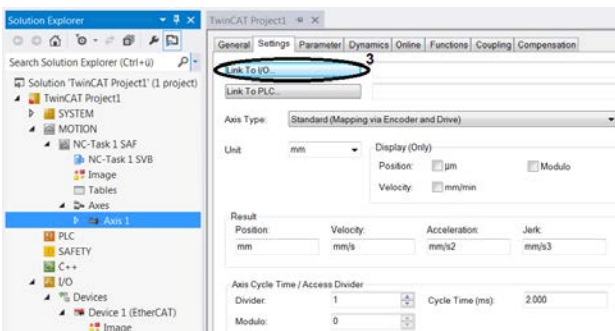
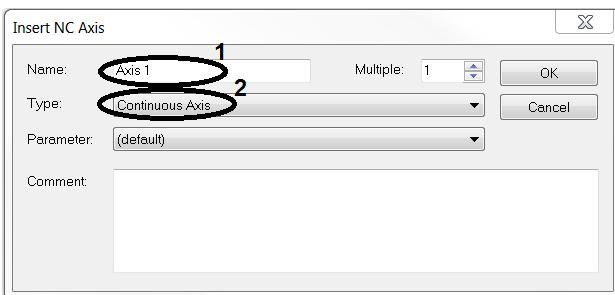

In the Solution Explorer the new axis appears with its name within the NC axis configuration. Link the individual NC axes with the drive, in order to enable control.

Open *Axis 1* in the Solution Explorer.

Switch to the *Settings* tab.

Link the NC axis with the hardware axis via *Link to I/O...* (3).

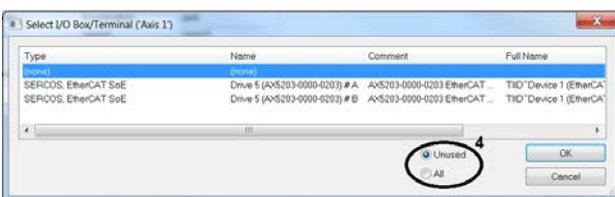

Select the drive to be linked from the list. You can filter the list based on the axis link status. The filter *Unused* (4) only shows axes that are not linked. The setting *All* (4) shows all axes, irrespective of their link status.

Confirm the selection with *OK*.

→ Your NC axis is successfully linked with the drive.

Creating a CNC axis

If a CNC axis configuration has already been created, the individual axes can be created and linked. The *Motion* section of the Solution Explorer expands and shows the new CNC axis configuration.

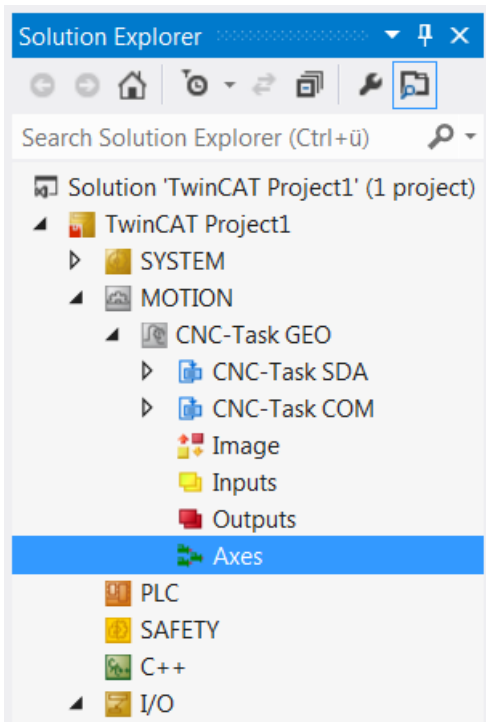

Right-click on Axes within the axis configuration. Select *Add New Item....*

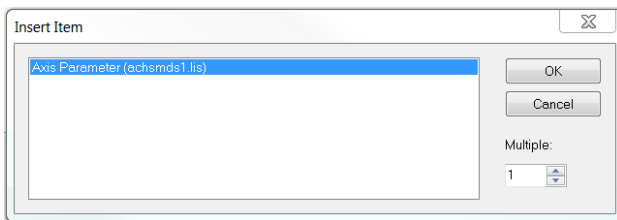

Select the axis type from the list. Confirm the selection with *OK*.

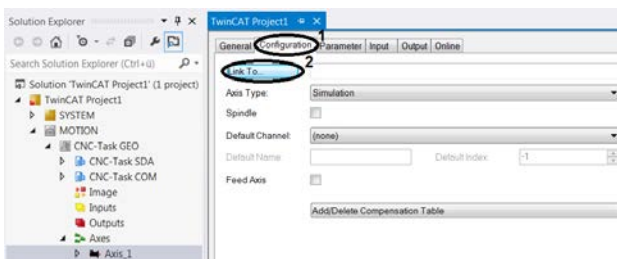

In the Solution Explorer the new axis appears with its name within the CNC axis configuration. Link the individual CNC axes with the drive, in order to enable control. Open *Axis_1* in the Solution Explorer. Open the Configuration tab (1).

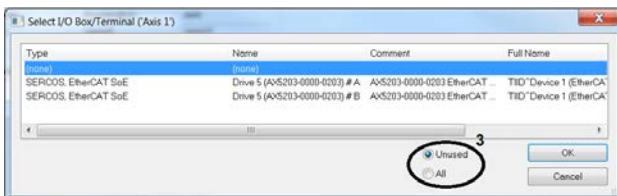

Link the CNC axis with the hardware axis via *Link to I/O...* (2).

Select the drive to be linked from the list. You can filter the list based on the axis link status. The filter *Unused* (3) only shows axes that are not linked. The setting *All* (3) shows all axes, irrespective of their link status. Confirm the selection with *OK*.

→ Your CNC axis is successfully linked with the drive.

Specifying the scaling factor

The scaling factor is an application-specific parameter, which is required for converting position values.

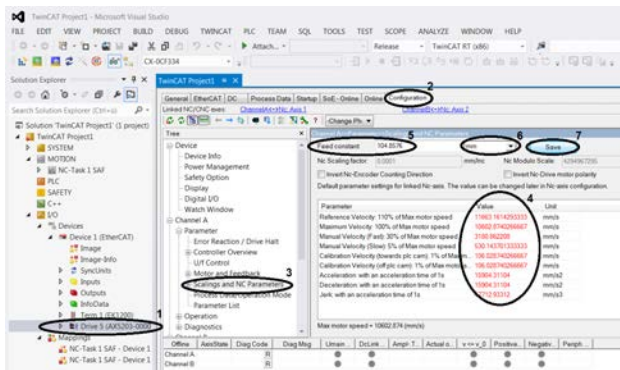

In the Solution Explorer, open I/O → Devices → Device 1 → Drive 5 (1).

Open the TCDriverManager via the Configuration tab (2).

In the tree structure select Channel A → Parameter → Scalings and NC Parameters (3).

On the right next to the tree structure, there is a table showing various motor parameters and associated values (4). Since the initial parameter values are default values that were not explicitly saved by the user, they are regarded as invalid and therefore shown in red font. The individual parameter values depend on the scaling factor, so that all parameter values can be adjusted by modifying the scaling factor.

Adjust the scaling factor via the field Feed constant (5).

Select the unit (6).

Confirm the change with Save (7).

Acknowledge the information window with OK.

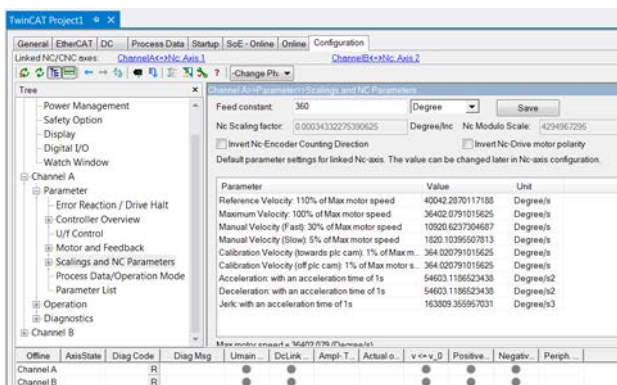
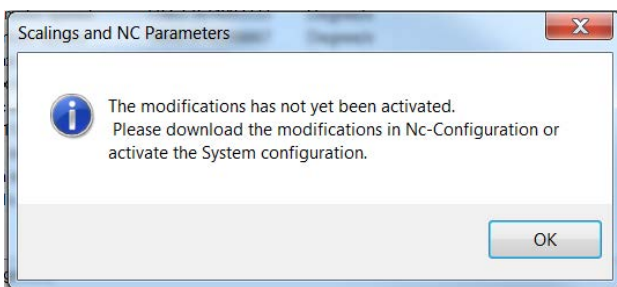

By confirming the change, the parameter values and their units are adjusted to the new reference value and appear in black font.

→ Your motor parameters are set correctly.

The configuration of Channel B follows the same procedure as for Channel A.

Specifying velocities

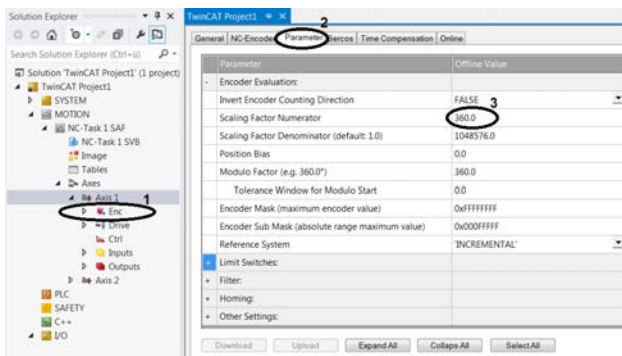

Checking the scaling factor

In the Solution Explorer, open Motion → NC-Task 1 SAF → Axes → Axis 1 → Enc (1).

Open the Parameter tab (2).

Compare the value of the Scaling Factor Numerator (3) with the value of the scaling factor.

If the value does not match the scaling factor, select the field (3) and enter the scaling factor.

ATTENTION: Please ensure **decimal points** are used, not decimal commas, as used in Germany!

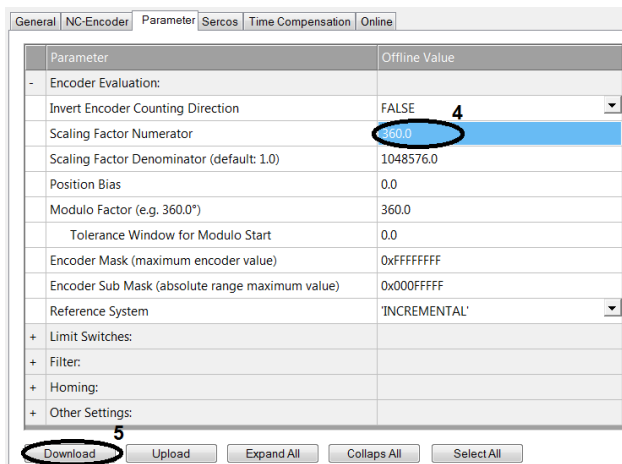

The value change is indicated by the blue colour of the field (4).

Select the field with the changed value (4) to activate the Download button (5).

Press Download (5) to save the change.

Another window appears:



Save changes permanently with *Save now*.

Wait a moment and close the window with *OK*.

Also check the settings of *Channel B*.

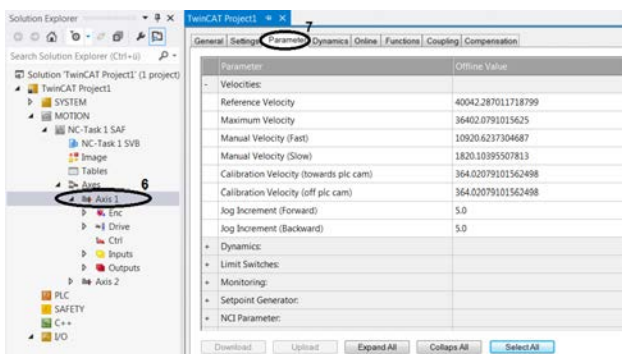

Setting the velocities

In the Solution Explorer, open Motion → NC-Task 1 SAF → Axes → Axis 1 (6).

Open the Parameter tab (7).

Set the velocities as required.

ATTENTION: Please ensure **decimal points** are used, not decimal commas, as used in Germany!

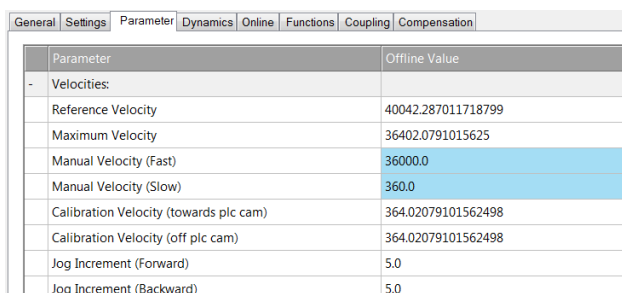

The value change is indicated by the blue colour of the field.

Parameter	Description
Reference Velocity	Reference velocity of an analog servo drive
Maximum Velocity	Maximum velocity (= maximum value of the field <i>Target Velocity</i>)
Manual Velocity (Fast)	Velocity in the manual test menu (<i>F1</i> and <i>F4</i>)
Manual Velocity (Slow)	Velocity in the manual test menu (<i>F2</i> and <i>F3</i>)
Calibration Velocity (towards plc cam)	Homing velocity
Calibration Velocity (off plc cam)	Homing velocity

→ *The velocities are adjusted and take effect with the next configuration.*

Test mode

To test the TwinCAT project with all its settings on the drive, the settings have to be transferred to the drive. To do this, the entire system must be configured. After successful configuration, the motor control can be tested manually in manual mode.

Before commissioning the manual control, it is advisable to check the control status of the drive.

Configure drive

Before you can start the controller, you must transfer the TwinCAT settings to the drive. To do this, activate the configuration.



Click the Activate Configuration icon in the toolbar.

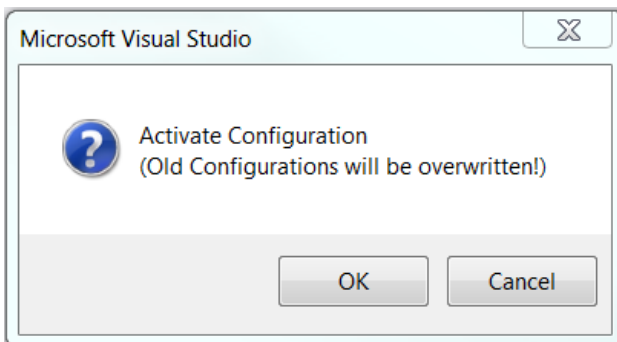

Activate the configuration with OK. All settings are applied to the drive.

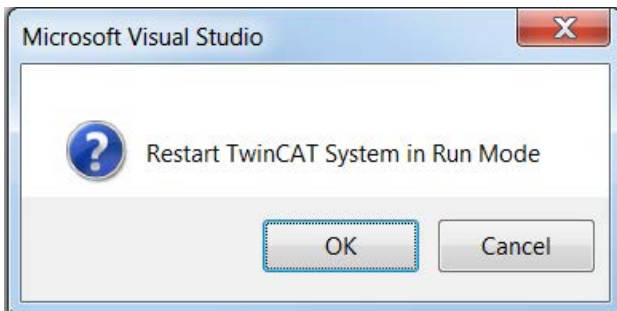

Start Run mode with OK.



Wait until the blue gear icon in the status bar turns green. Only then is the application in Run mode.

→ All your settings were applied to your drive. The drive is ready for operation.

Checking the state

Before you operate the motor control, check the system states of the drive.

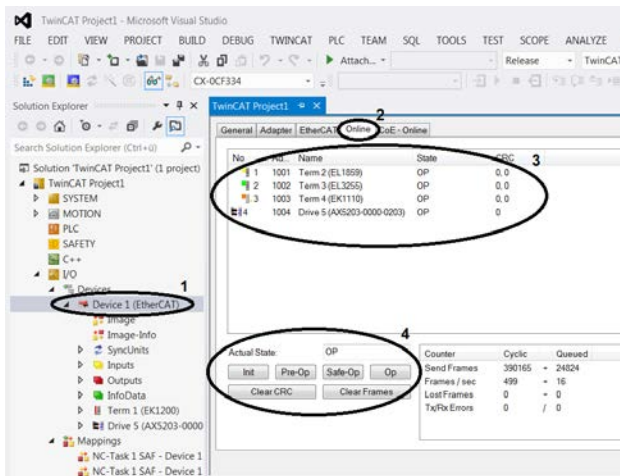

In the Solution Explorer, open I/O → Devices → Device 1 (EtherCAT) (1).

Open the Online tab (2).

All drive devices are displayed (3).

The function keys (4) can be used to change the states of all devices.

To ensure smooth operation, the states of all devices should be *OP* (see *State* status column the table (3)).

→ Your system is checked and ready for operation.

Activating manual control

TwinCAT has a manual test menu, which allows you to start the drive manually in a test mode. The manual test menu can be called up either via the drive (*Devices*) or via the axis configuration.

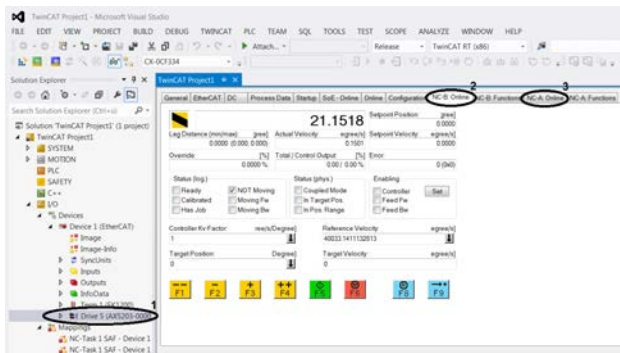

Manual test menu for drive

In the Solution Explorer, open I/O → Devices → Device 1 → Drive 5 (1).

Switch to tab NC-B: Online (2) or NC-A: Online (3).

In this case you would test the drive for axis 2 by selecting NC-B: Online (2). Select NC-A: Online (3) to test axis 1.

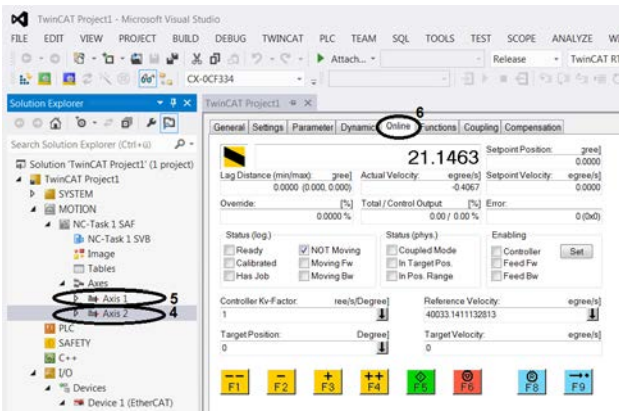

Manual test menu for axis configuration

In the Solution Explorer, select Motion → NC Task 1 SAF → Axes → Axis 2 (4) or Axis 1 (5). Depending on which of the two axes is to be tested.

Open the Online tab (6).

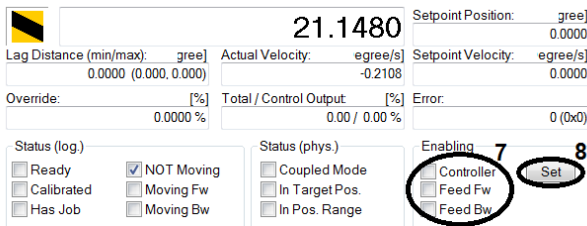

Setting the authorization permissions

To operate the motors manually, you have to enable manual drive control. The control is enabled when Enabling Controller (7) is activated. In addition, the drive requires Enabling Feed Fw (7) activated for forward travel, and Enabling Feed Bw (7) for reverse travel.

Use the Set button (8) to change the settings.

Use the All (10) button to set all settings and the override (11) to 100%, or to set all settings manually:

Tick the individual options (9) to activate them.

Enter the Override value (11).

Override (11) overrides over all previous velocity limits and indicates the ratio of the respective velocity. The *Override* value can be between 0% and 100%.

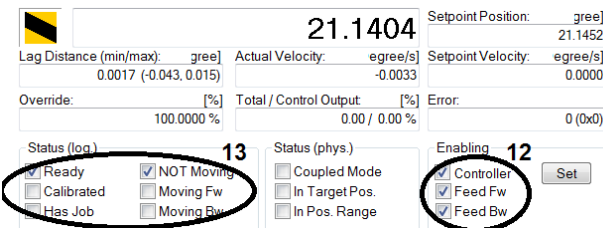
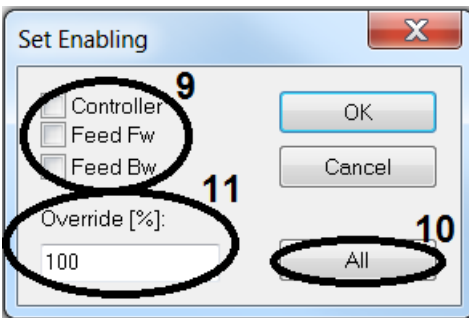

In the function view, the activated options are indicated by ticks (12). In addition, the Status (log.) (13) has changed with the activation, and the override has been entered. The motors are ready for operation and can be controlled with the manual test menu.

→ Manual control is activated and can be used.

Manual control guide

The drive can be controlled using the buttons F1 to F9 and the fields *Target Position* and *Target Velocity*.

The screenshot displays a manual control interface with the following elements:

- Position:** 21.1339 (Setpoint Position: 21.1415)
- Velocity:** -0.3543 (Actual Velocity: -0.3543, Setpoint Velocity: 0.0000)
- Override:** 100.0000 %
- Total / Control Output:** 0.00 / 0.00 %
- Error:** 0 (0x0)
- Status (log):**
 - Ready
 - Calibrated
 - Has Job
 - NOT Moving
 - Moving Fw
 - Moving Bw
- Status (phys.):**
 - Coupled Mode
 - In Target Pos.
 - In Pos. Range
- Enabling:**
 - Controller
 - Feed Fw
 - Feed Bw
- Controller Kv-Factor:** 1 (units: rev/s/Degree)
- Reference Velocity:** 40033.1411132813 (units: degree/s)
- Target Position:** 0 (units: Degree)
- Target Velocity:** 0 (units: degree/s)

At the bottom, there are nine function buttons: F1 (Reverse Fast), F2 (Reverse Slow), F3 (Forward Slow), F4 (Forward Fast), F5 (Start Direct Travel), F6 (Stop Direct Travel), F8 (Reset Control), and F9 (Trigger Homing).

The following table provides a brief overview of all manual mode functions.

Function	Description
F1	Reverse travel with <i>Manual Velocity (Fast)</i>
F2	Reverse travel with <i>Manual Velocity (Slow)</i>
F3	Forward travel with <i>Manual Velocity (Slow)</i>
F4	Forward travel with <i>Manual Velocity (Fast)</i>
F5	Start a direct travel command <ul style="list-style-type: none"> • Enter the <i>Target Position</i> • Enter the <i>Target Velocity</i> • Start the travel command with F5
F6	Stop a direct travel command
F8	Reset the control (if hand control has stopped responding)
F9	Trigger homing (see TwinCAT documentation)

Typical error messages

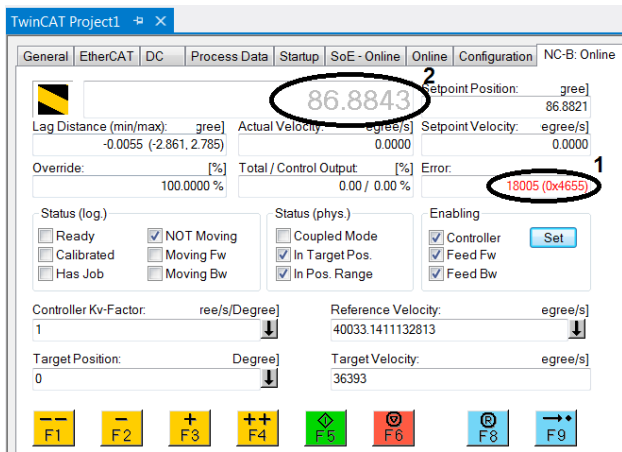

If you are in the manual test menu and the position value (2) is greyed out, the manual test menu issues an error message (1), and manual control is not active. The error message gives no details about the cause. To investigate further, open the TCDriveManager via Configuration (3).

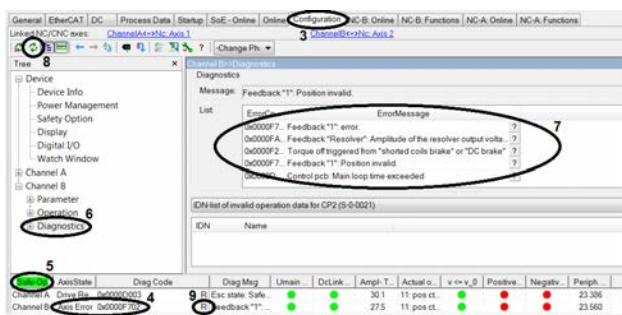

In the status bar for the axes, another error code is shown at Diag Code (4). Check the drive state (5). Select Diagnostics (6) from the tree structure, in order to obtain further information about the error. A list (7) on the right shows the whole error history. This list can be used to identify the specific cause of the error message. Update the list via the button with the two green arrows (8), to show the latest error messages. Once the cause is identified and corrected, reset the axis via the R button (9).

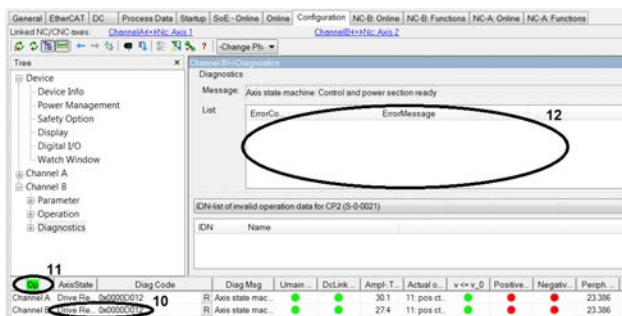

After a short time, the error indication will disappear from the status line for the axis (10), and the drive will be in OP state (operational) (11).

Update the list of error messages once more (8). It should contain no more error messages (12).

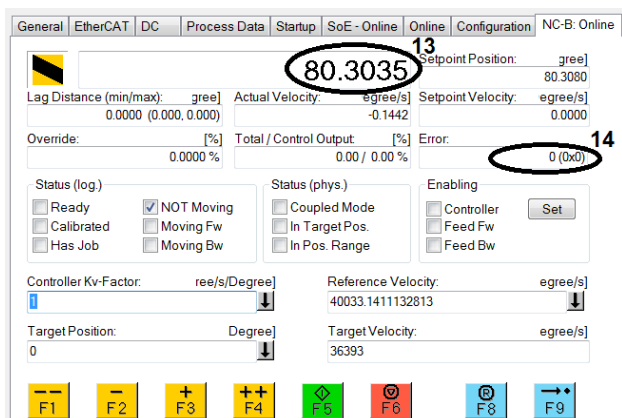

In the manual test menu for the axis, the position value (13) is shown in black font once again.

Press the F8 button to reset the error (14) in the manual test menu.

→ The drive is ready for operation again.

9.1.4 Linear motors

9.1.4.1 Commissioning of linear motor axes

Beckhoff Automation GmbH & Co. KG does not sell complete linear motor units. Magnetic plates and coil parts are offered for sale. The machine manufacturer selects a linear measuring system to suit the application. The assembly takes place at the machine manufacturer's premises. This leads to various selection options, whose results usually cannot be determined until commissioning. For example, the direction in which the measuring system counts may not be known.

An incremental measuring system is often used with linear motors. This necessitates the use and configuration of "Wake & Shake".

Requirements for commissioning

XML motor description

The XML description matching the motor is required for the commissioning of a linear motor on the AX5000 servo drive. The associated XML files for Beckhoff linear motors are contained in the TwinCAT setup (AX5000 Download Package).

i XML files for third-party motors!

In the case of third-party motors the required XML descriptions can be generated with the help of the "Tc Motor Data File Generator".

XML measuring system description

If a measuring system is used, it must also be present in the form of an XML description. Without this XML description the measuring system does not appear in the TC Drive Manager selection list. A missing XML description can be generated exclusively by Beckhoff Automation GmbH & Co. KG.

If an incremental (non-absolute) measuring system with sine/cosine or TTL signals is used, a corresponding system can be chosen as "Unknown" from the list shown below.

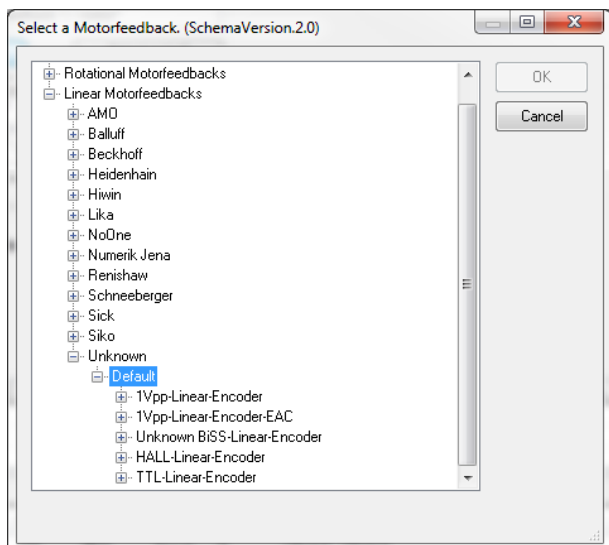

An overview of feedback systems already used can also be found in the AX5000 system manual. The picture detail below shows a selection of possible feedback systems that could come into question as a measuring system.

Lineare Encoder

Heidenhain:

Typ	System	Messschritte	Versorgungs-spannung	Schnittstelle	A
LS 388C	Inkremental	20 µm	5 V	1 Vpp	O
LS 486	Inkremental	20 µm	5 V	1 Vpp	O
LS 487	Inkremental	20 µm	5 V	1 Vpp	O
LC 483	Inkremental	20 µm	3,6 V - 5,25 V	EnDat 2.1 + 1 Vpp	O
LIDA 477	Inkremental	20 µm	5 V	1 Vpp	O
LIDA 483	Inkremental	20 µm	5 V	1 Vpp	O
LIDA 487	Inkremental	20 µm	5 V	1 Vpp	O
LIDA 287	Inkremental	200 µm	5 V	1 Vpp	O

HIWIN:

Typ	System	Messschritte	Versorgungs-spannung	Schnittstelle	A
Magic	Inkremental	1 mm	5 V	1 Vpp	M

Iika:

Commissioning

Motor and feedback selection

The motor should be selected first, then the measuring system. This order ensures that the pole pair distance of the linear motor is automatically taken into account in the feedback settings of the parameter.

In the case of linear encoders with TTL signals, a distinction must be made between the signal period and the resolution. The manufacturers specify the resolution when evaluating all edges ("after quadrupling"). For the AX5000 the signal period must be specified. A measuring system whose resolution is specified by the manufacturer as 1 µm, for example, has a signal period of 4 µm and must be selected accordingly (picture below):

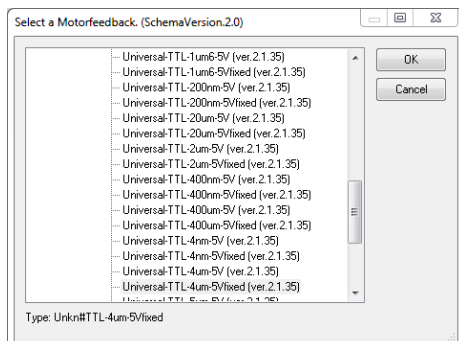

Motors with a pole pair distance that is not an integer represent a special case!
 It is necessary to specify the "Signal periods per rotation" in parameter P-0-0150.

Sample:

With a pole pair distance of 28.1 mm and a sine period length of the linear encoder of 1 mm, a value of 28.1 would be correct. However, only integer values can be entered there. The Tc Drive Manager therefore enters the value 28 in P-0-0150 (picture below):

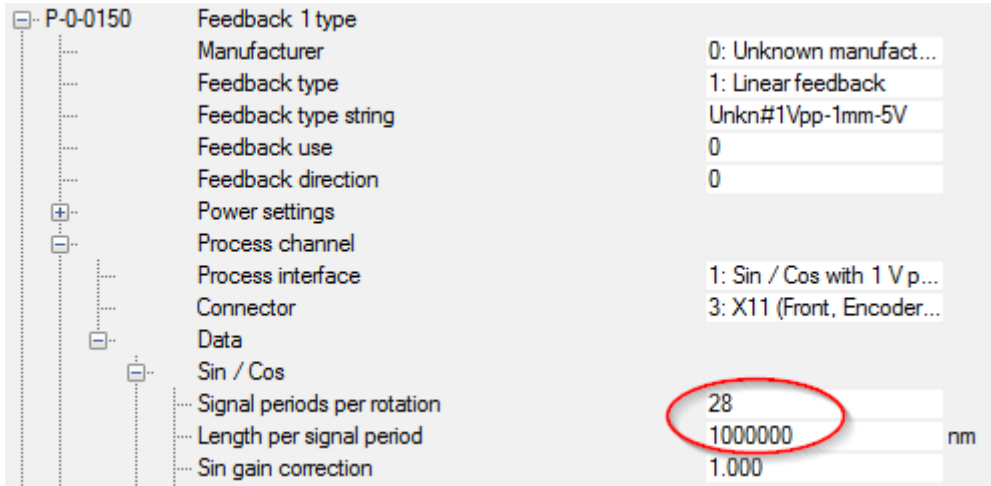

The feedback gear unit is now automatically activated in order to correct the error described above (picture below).

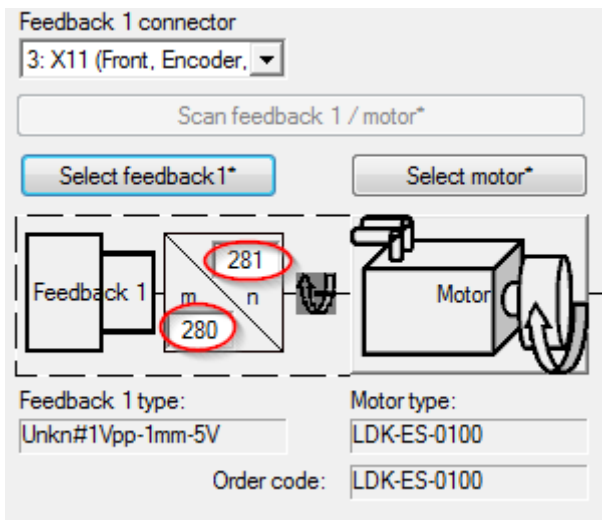

Scaling factor

The pole pair distance of the linear motor in millimeters is to be entered in the field "Feed constant"(picture below). After entering the correct "Feed constant", all positions are specified in mm, all speeds in mm/s. A non-integer input is possible at this point. 28.1 (decimal point!) is the correct value in the above example.

Channel A>>Configuration>>Scaling and NC parameters

Rotational position resolution: 1048576: 2²⁰ bit

Feed constant: 28.1 mm /motor rotation Set NC Parameters

NC scaling factor: 28.1 / 1048576 mm/Inc

NC modulo scale: 4294967295

Invert NC-Encoder counting direction Invert NC-Drive motor polarity

Default parameter settings for linked NC-axis. The value can be changed later in NC-axis configuration.

Parameter	Value	Unit
<input checked="" type="checkbox"/> Scale factor numerator:	28.1	mm/Inc
<input checked="" type="checkbox"/> Scale factor denominator:	1048576	mm/Inc
<input checked="" type="checkbox"/> Reference Velocity: 110% of Max motor speed	2129.71585359701	mm/s
<input checked="" type="checkbox"/> Maximum Velocity: 100% of Max motor speed	1936.10532145182	mm/s
<input checked="" type="checkbox"/> Manual Velocity (Fast): 30% of Max motor speed	580.831596435547	mm/s
<input checked="" type="checkbox"/> Manual Velocity (Slow): 5% of Max motor speed	96.8052660725912	mm/s
<input checked="" type="checkbox"/> Calibration Velocity (towards plc cam): 1% of Max motor speed	19.3610532145182	mm/s
<input checked="" type="checkbox"/> Calibration Velocity (off plc cam): 1% of Max motor speed	19.3610532145182	mm/s
<input checked="" type="checkbox"/> Acceleration: with an acceleration time of 1s	2904.15798217773	mm/s ²

The values are confirmed in the NC with "Set NC Parameters". They are only valid when the configuration is activated.

Checking the linear encoder

Once the motor and feedback have been selected and the scaling factor has been entered, the configuration must be activated. Subsequently the measuring system must be checked. The AX5000 must not report any feedback error when doing this. Please observe the notes in the section "[Troubleshooting \[► 163\]](#)".

Observe the position in the NC. Push the motor by hand during this procedure. The distance by which the motor is pushed must be correctly displayed in the NC.

If a measuring system is used that can read out absolute and incremental signals, then the absolute and incremental tracks must have the same counting direction. Therefore, the two tracks have to be compared beforehand. The absolute position is read by the AX5000 only when switching on/restarting. Then it switches over and evaluates only the incremental information (sincos or TTL signals).

Important: Up to this step the counting direction should not be inverted via a parameter at any point!

Now push the motor by hand. While doing this, observe the direction in which the position increases. Switch the AX5000 to the "Init" state and then to the "Op" state (picture below). Using this procedure the absolute position is read out again.

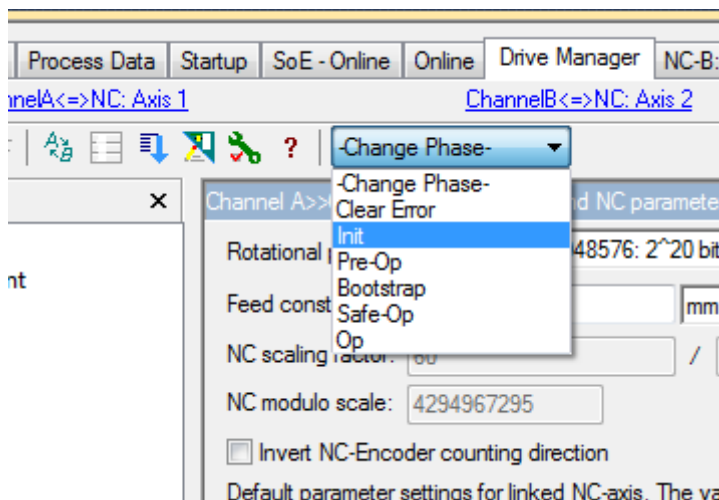

Note the absolute position read out. Now push the motor in the direction of the increasing position. Then switch the AX5000 once again to the "Init" state and then to the "Op" state (picture below). If the absolute position displayed after this procedure is larger than the one noted beforehand, both tracks are counting in the same direction.

If a smaller position is displayed, the counting direction for the incremental encoder signals must be reversed. This should be done by hardware means, for example by swapping the SIN+ and REFSIN signals in the feedback connector.

Now repeat the test!

● Counting direction doesn't correspond to the application!

i If the counting direction of the linear encoder doesn't correspond to the desired counting direction in the application, this can be ignored at this point. The necessary settings can be made at the end of the commissioning. The requirement for this is that the motor drives without errors.

Checking the motor phases and the encoder counting direction

If the absolute and incremental positions of the linear encoder have the same counting direction (or if there is only an incremental position), the phase sequence of the motor can be compared with the encoder counting direction. This can be checked using the command P-0-0166 "Motor and feedback connection check" (picture below).

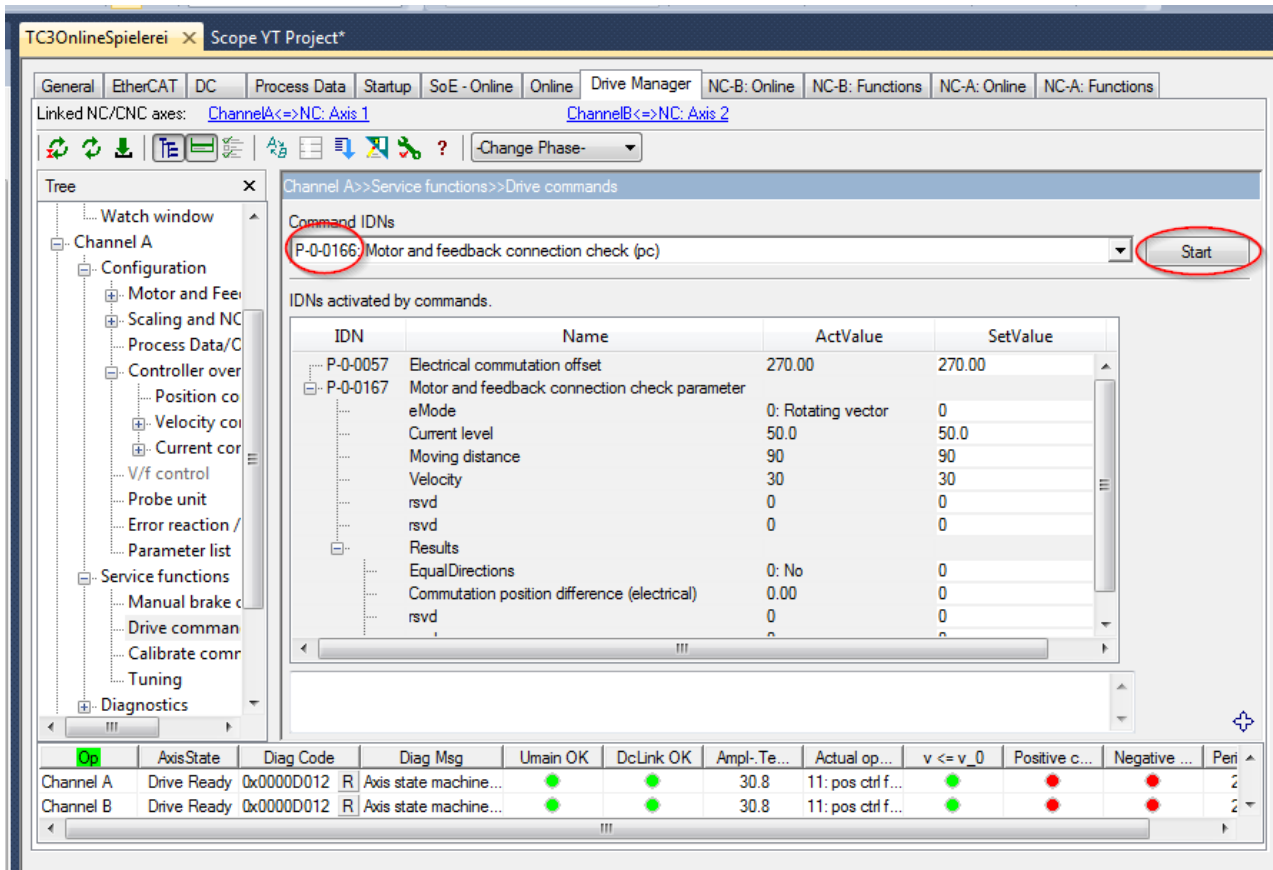

If the command P-0-0166 has been selected for checking the motor and feedback connection (picture above), the input mask of parameter P-0-0167 appears. The parameters in the upper area should not initially be changed.

The main voltage (e.g. 400 V) must be switched on in order to execute the command. The AX5000 must be ready but not enabled. The "Diag Code" is 0x0000D012.

NOTE

The execution of this command causes a movement of the motor!

Before confirming the following message with "Yes", make sure that the motor can move freely and cannot cause any damage.

The following message appears during the first execution:

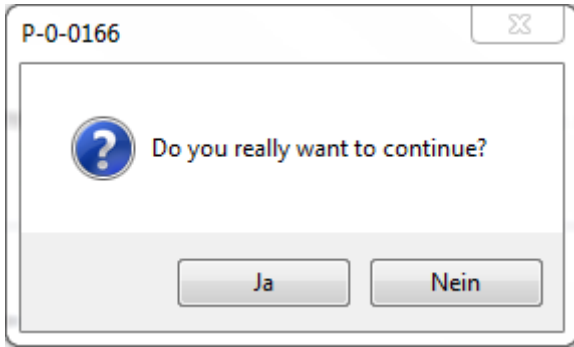

The linear motor first jerks and then makes a further movement a few seconds later.

If the command was executed successfully, the message "Succeeded to start the command" appears. Values are hereby entered in parameter P-0-0167 "Results" (picture below).

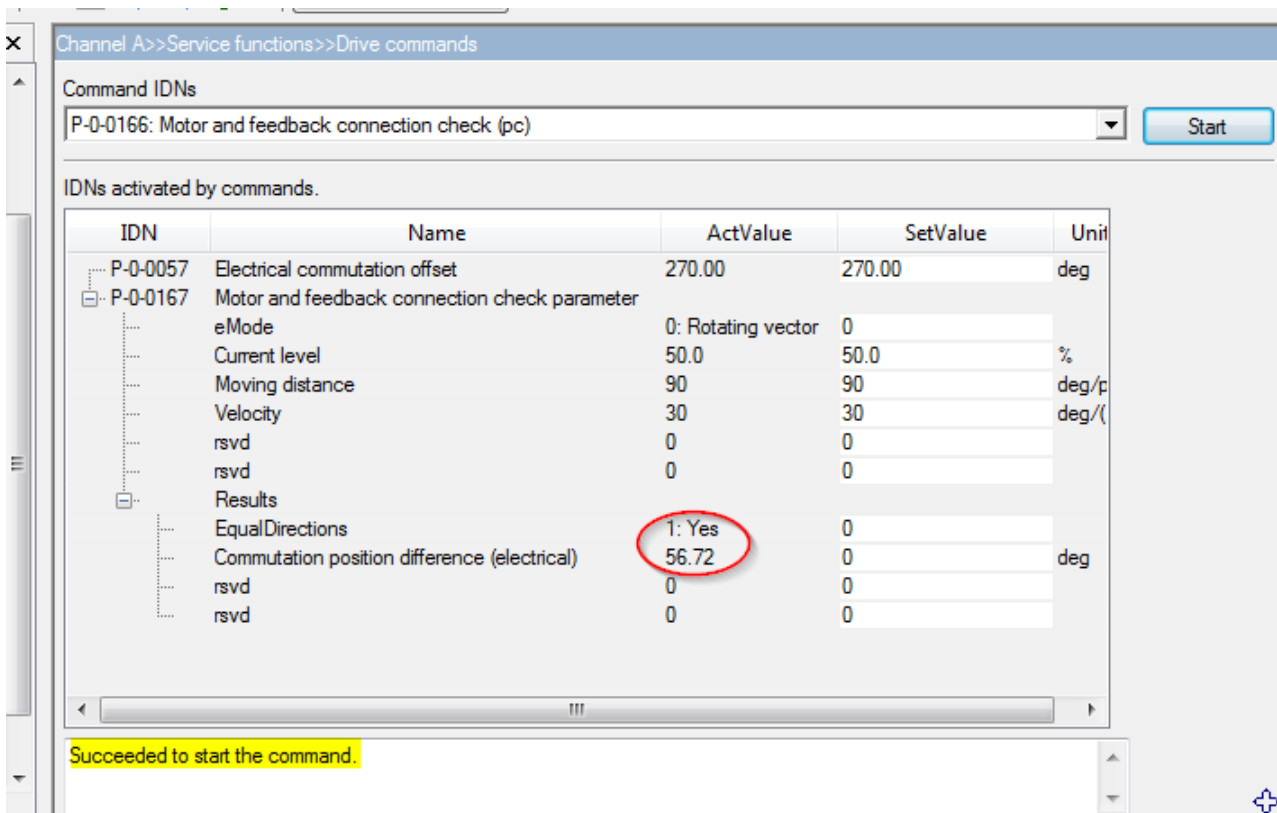

It is important that the result "1:Yes" appears in the setting "Equal Directions" (picture above → red circle). If "0:No" should appear there, two phases of the motor connection (AX5000 X13/X23) need to be swapped, e.g. U and V.

The command can also be executed repeatedly.

i **Further information can be found in the parameters:**
 P-0-0150; P-0-0166 and P-0-0167.

Determination of the commutation offset

If the order of the motor phases matches the counting direction of the measuring system, the commutation offset can be determined. In the case of absolute measuring systems, the commutation offset is only determined once. The value is saved. In the case of incremental measuring systems, the "Wake & Shake" must be configured. The commutation search then takes place automatically after each restart, when enabling the servo drive for the first time.

With incremental measuring systems

NOTE

Use of incremental measuring systems for vertical axes!

Beckhoff Automation GmbH & Co. KG urgently advises you not to use incremental measuring systems with vertical axes. A reliable commutation search is not possible with this combination!

Parameter P-0-0160 executes the commutation search. The behavior is configured with parameter P-0-0165. The "Static current vector" method can be used for test drives. It is preferable to use "Wake & Shake" in operation. It causes less movement of the axis. Both methods are executed using the command "Start" (picture below → red circle). All settings should initially remain unchanged. The routine must be completed without error. The message "Succeeded to start the command" (picture below → red circle) should appear.

The screenshot shows the Drive Manager interface for Channel A. The 'Command IDNs' dropdown is set to 'P-0-0160: Calibrate commutation offset (pc)'. The 'Start' button is circled in red. Below, the 'IDNs activated by commands' table is shown:

IDN	Name	ActValue	SetValue	Unit
P-0-0057	Electrical commutation offset	270.00	270.00	deg
P-0-0058	Mechanical commutation offset	53.48		deg
P-0-0165 Commutation offset calibration parameter				
	Command mode	0: Static current vector	0: Static current vector	
	Activation	0: Manual	0: Static current vector 1: Wake and Shake	
	Static current vector			
	Current level	50.0	50.0	%
	Duration	3000	3000	ms
	Wake and Shake			

Below the table, a status message "Succeeded to start the command." is circled in red.

After successful execution of the command, the axis can be driven for test purposes; see below. Following a successful test the entries "Command Mode" and "Activation" in parameter P-0-0165 should be changed to "Wake & Shake" and "1:On enable request" respectively.

In most cases the default settings for "Wake & Shake" can be left unchanged. In many applications it is useful to set the parameter "Commutation pos control: Kp" to 0. Details for this can be found under the keyword "Electronic Commutation" in the Beckhoff Information System.



Further information can be found in the parameters:

P-0-0160 and P-0-0165.

With absolute measuring systems

The AL2200-MES-Feedback indicates only the absolute position in relation to a pole pair. Homing is necessary each time after switching on. The commutation offset only needs to be determined once and saved. The commutation offset is determined in the same way as with other absolute measuring systems. For that reason the AL2200-MES-Feedback is not described separately here.

Set the values for "Commutation Mode" and "Adjustable Commutation Offset (mechanical)" in parameter P-0-0150 (see picture below).

S		P-0-0150	PS	067	Feedback 1 type	
					Manufacturer	12: Beckhoff
					Feedback type	1: Linear feedback
					Feedback type string	Beck#AL2200MES-5V-1...
					Feedback use	0: Commutation motorfeed...
					Feedback direction	0: Positive direction
					rsvd	
					Power settings	
					Process channel	
					Parameter channel	
					Parameter interface	0: No commutation interfa...
					Connector	0: No connector
					Identifier	0
					Bit resolution singletum position	0
					Bit resolution multitum position	0
					Number of clockcycles to get singletum position...	0
					Number of clockcycles to get multitum position	0
					Digital name plate	0: No digital name plate
					Commutation mode	2: Commutation offset 0 deg
					Adjustable commutation offset (mechanical)	0.0 deg
					Linear resolution about digital interface	0 nm

The configuration must be activated to confirm the settings. Command P-0-0166 is used to set the electrical commutation offset.

⚠ CAUTION
The execution of this command causes a movement of the motor!
Wait for the message "Succeeded to start the command"!

"Yes" must appear as result under "Equal Directions".

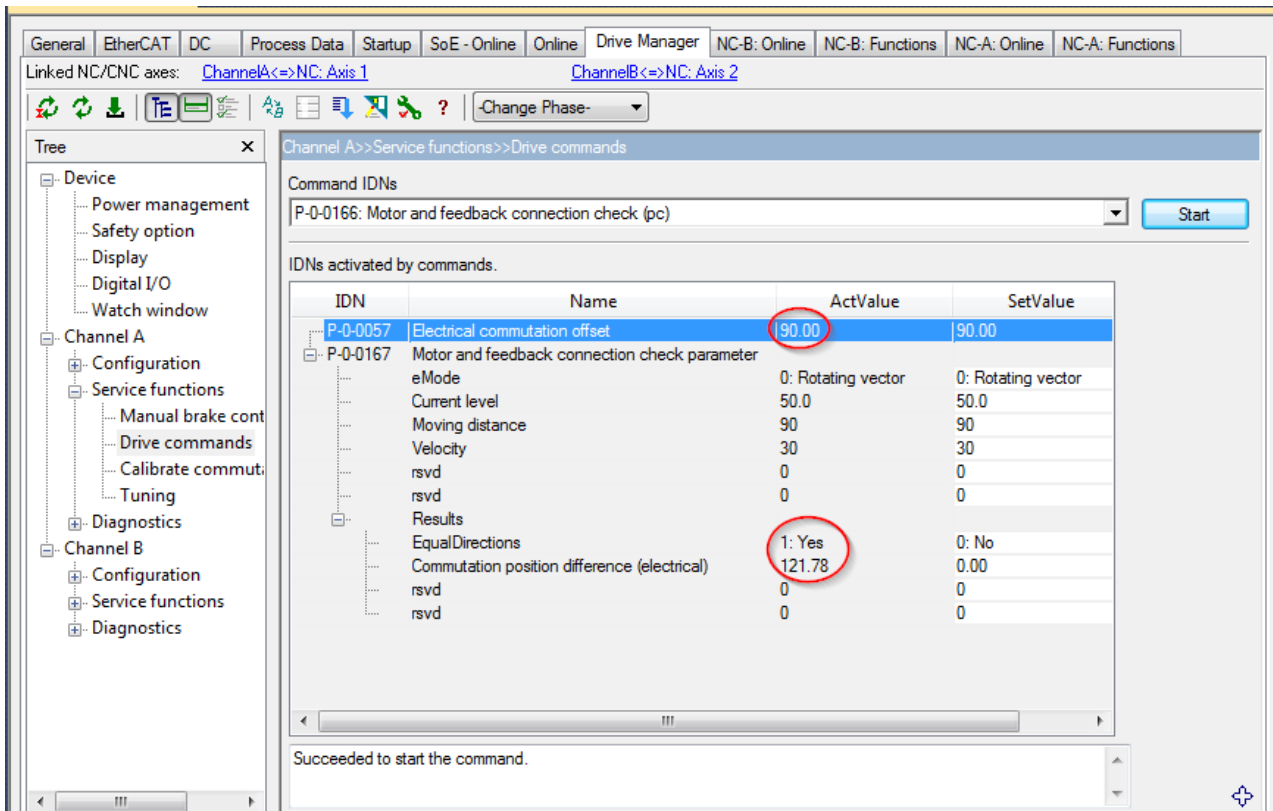

Read the value for "Commutation position difference". Subtract this value from the value in P-0-0057 "Electrical commutation offset". The result, if positive, is the new value for P-0-0057. Add 360° to the result if it is negative.

Sample:

$$90^\circ - 121.78^\circ = -31.78^\circ$$

$$-31.78^\circ + 360^\circ = 328.22^\circ$$

The result is the new value for P-0-0057 "Electrical commutation offset". Enter the value in SetValue and confirm with <Enter>. Confirm the message that then appears with Yes (picture below).

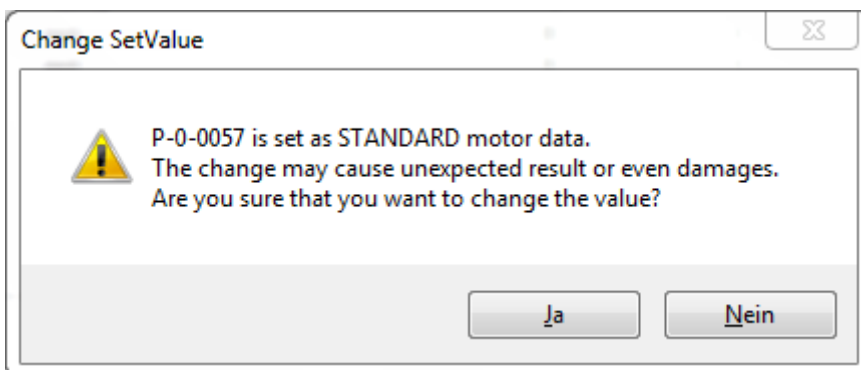

The new value becomes active immediately upon pressing the download button (red arrow → picture below).

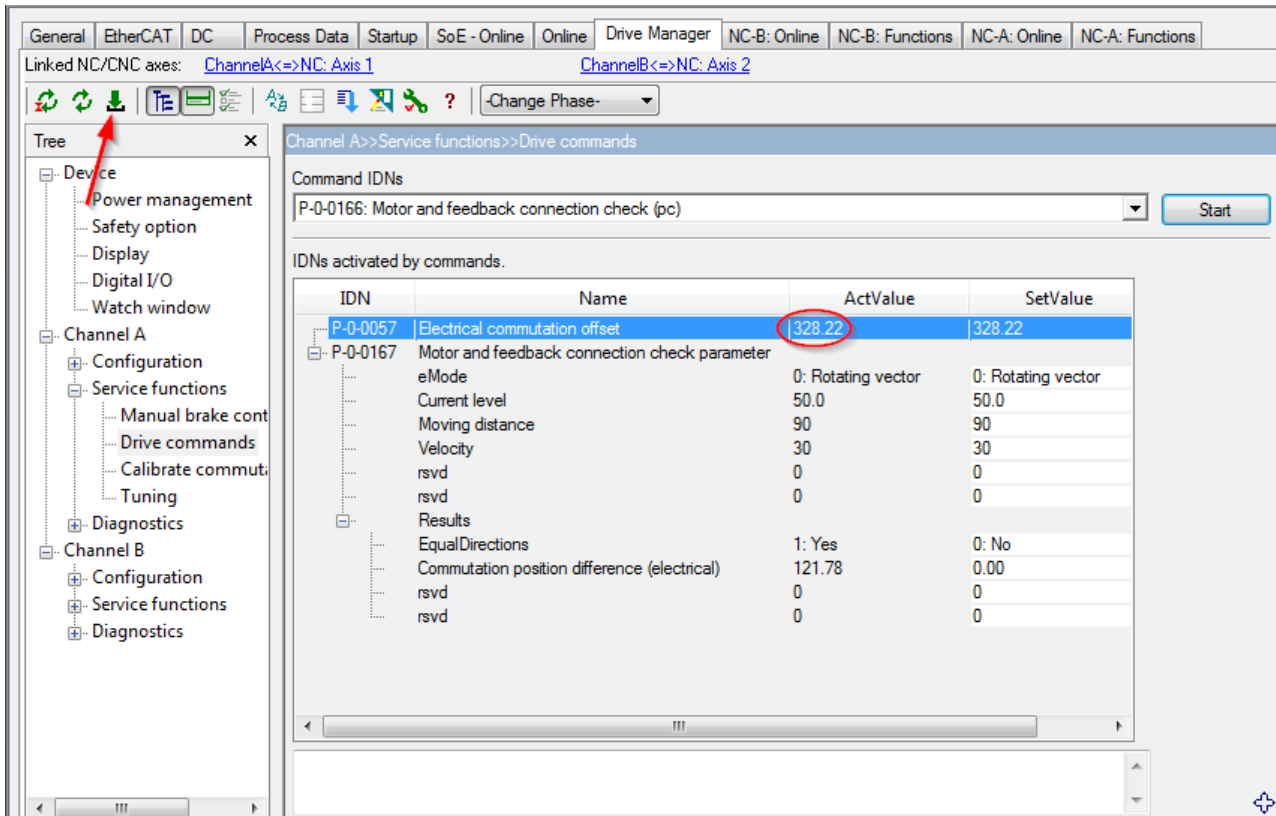

The value is displayed in the setting "ActValue" after the download is complete. Execute command P-0-0166 again!

The value for "Commutation position difference" should now lie within the range:

$$355 \dots 360 = 0 \dots 5.$$

If this value is displayed you have successfully completed the commutation search!

The offset value has already been adopted into the startup list with the download button.

If the value lies outside the range, P-0-0057 can be corrected again using the method described. If no useful value is found, the more detailed check should be performed with the help of command P-0-0166. In this case, please observe the section: "[Checking the motor phases and the encoder counting direction |> 156](#)".

i Further information can be found in the parameters:

P-0-0057, P-0-0150 and P-0-0166.

Moving the axis for test purposes

Use the jogging buttons of the NC to move the axis at a slow speed. Do not execute the “Reversing function”. Allow the motor to move by at least one pole pair in order to ensure that the commutation works properly!

i Lag error if the velocity controller is not optimized!

It is possible for large lag errors to occur as long as the velocity controller has not been optimized!

- Test the travel movement at slow speeds and low acceleration.
- Allow a large lag error where possible.

If the axis travels only a few millimeters and then stops while drawing a high current, carry out the [commutation check](#) [▶ 156] using command P-0-0166.

Determination of the control loop parameters

The determination of the control loop parameters of a linear motor axis is done in the same way as with a standard axis. For that reason only an abridged procedure is described here.

In most cases the preset proportional gain in the velocity/speed controller is much too small. This is set in relation to the motor mass. In particular in the case of linear motors, the external mass can be large in comparison with the motor mass. This case requires a significant enlargement of K_p .

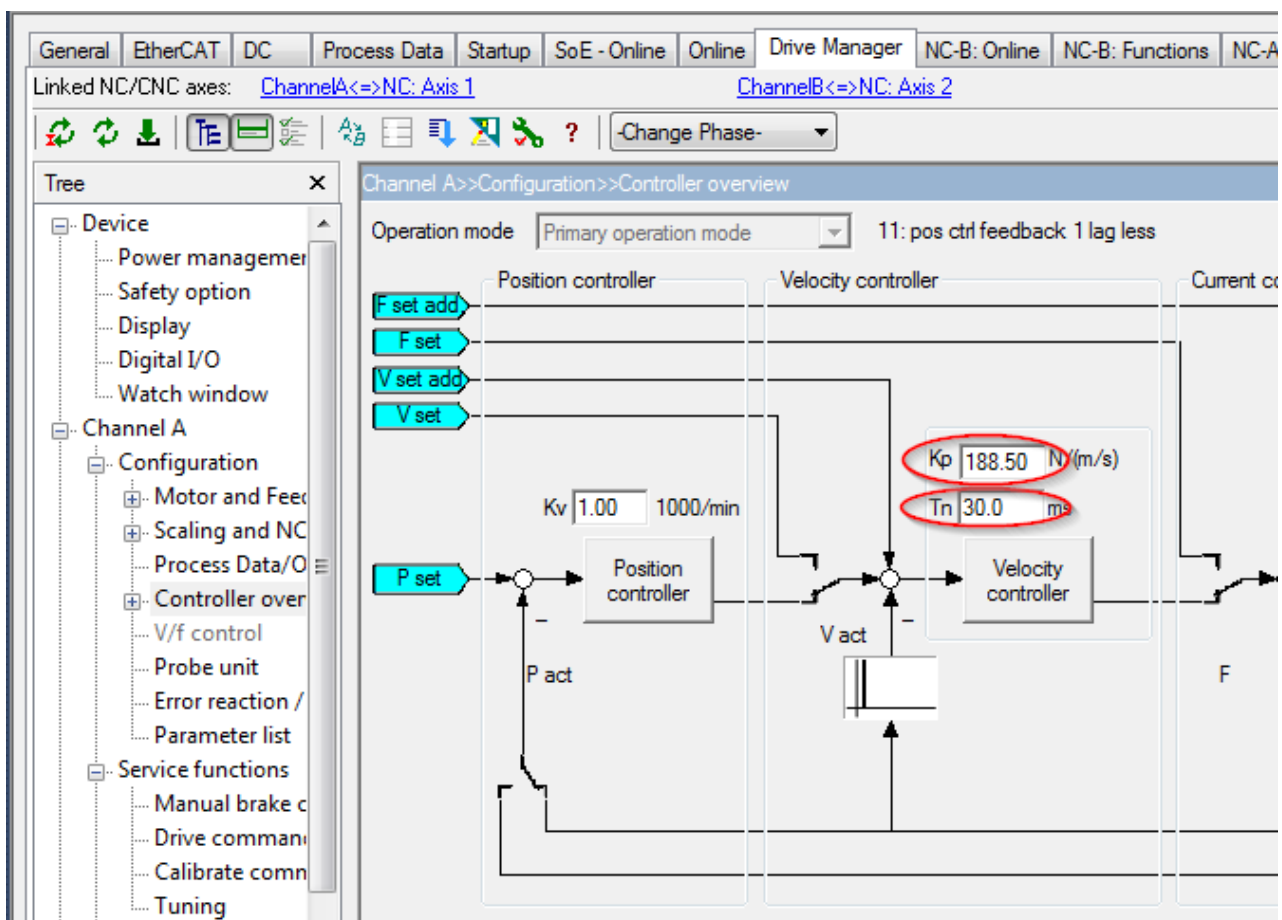

Abridged procedure:

1. Set T_n to $\geq 30ms$ (to reduce oscillation of the axis).
2. Start a reversing function at a moderate speed.
3. While the axis is moving, increase K_p in the "Controller Overview" window in steps of, for example, 20% up to the oscillation limit. (It is possible to check by axis noise).
4. Reduce K_p by about 20% until the oscillation reliably stops.
5. Also check that the axis doesn't oscillate when it is at a standstill.
6. Reduce T_n
A value of between 5 ms and 10 ms is useful if the load is coupled normally.
The value must be increased if oscillations occur.
7. $K_v = 1$ in the position controller is usually okay. Reduce K_v (for example to 0.5) if the axis overshoots the position after optimizing the velocity controller.
 K_v can also be increased if an overly large lag error occurs.

Troubleshooting

Feedback error

It is important to read all messages in order to identify the causes of errors. In the case of feedback errors in particular, the AX5000 normally outputs several error messages at once.

Errors in connection with the feedback power supply

Make sure when selecting a feedback system with the designation "Unknown" that the power supply is set correctly (picture below)!

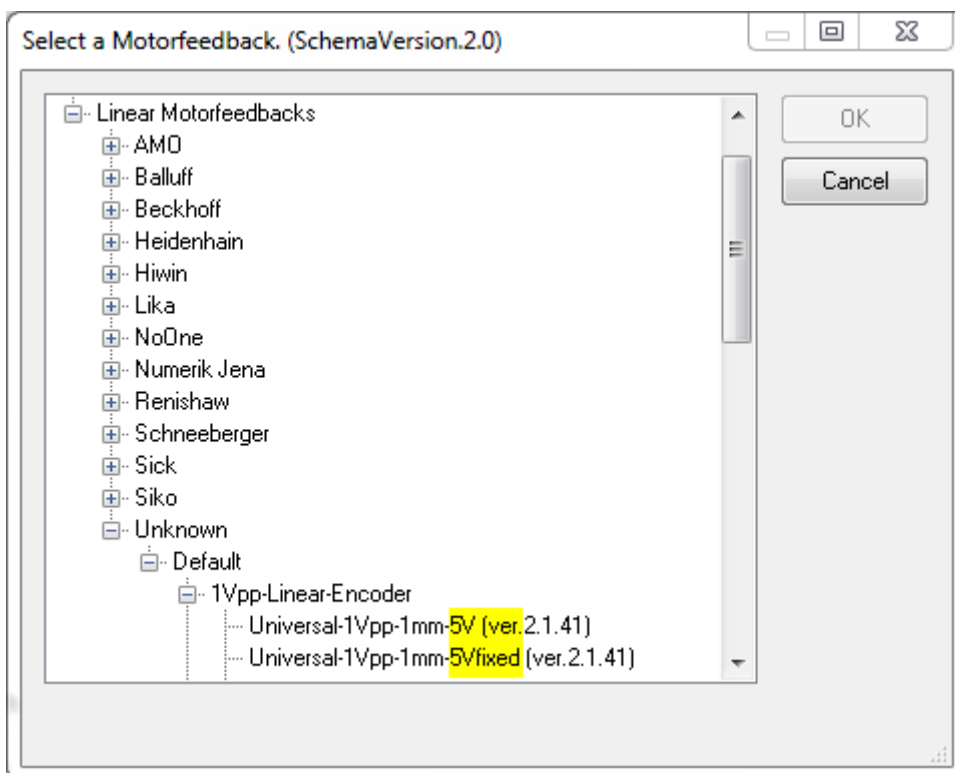

If the setting is "5V", the AX5000 expects a sense line to be connected. The setting "5V fixed" must be deselected if the encoder employed does not have a sense connection.

The selection leads to different settings in the "Power Settings" in the feedback parameter P-0-0150 (picture below).

P-0-0150	Feedback 1 type		
	Manufacturer	0: Unknown manufact...	0: Unknown manufacturer
	Feedback type	1: Linear feedback	1: Linear feedback
	Feedback type string	Unkn#TTL-10um-5Vfix...	Unkn#TTL-10um-5Vfixed
	Feedback use	0: Commutation motorf...	0: Commutation motorfeedback
	Feedback direction	0: Positive direction	0: Positive direction
	Power settings		
	Control voltage	3: 5V without sense, pi...	3: 5V without sense, pin 4 and 2
	Wait time after power up	800	0: off
	Connector	5: X21 (Front, Encoder...	1: 8V/11V, pin 6 and 2
	Process channel		2: 5V with sense, pin 4 and 2, sense pin 12 and 1
	Parameter channel		3: 5V without sense, pin 4 and 2

An incorrect selection leads to AX5000 error messages (see section "Error codes"). [► 164]

Error during activation (enable) of the AX5000

If the shield of the motor cable and/or feedback cable is not connected over a large area with the housing of the AX5000, this leads to a feedback error in the current feed to the linear motor. The position is then correctly displayed only when pushing the motor by hand.

The shield of the motor cable is normally connected with a clip to the metal bracket of the motor connector. The screws of the motor connector (X13/X23) must be screwed to the housing of the AX5000 and fastened with a tightening torque of 0.6 Nm.

Error codes

Error code	Error description
F152	Channel Errors If only this error is displayed, it is probably a two-channel device and the error cause is located in the other channel. Otherwise, observe the other error messages!
F702	Superordinate message. Please observe the other error messages!
F70E	Superordinate message. Please observe the other error messages!
F707	No feedback voltage <ul style="list-style-type: none"> The power supply is not correctly connected. The sense line is not correctly connected. No sense connection exists.
FA01	Initialization error <ul style="list-style-type: none"> Incorrect setting in parameter P-0-0150. Wiring error
FA49	Feedback process channel error (1Vss) The amplitude of the analog signal is too small -> check the connection.
F4A5	SoE Communication Parameter Error (see section "Error F4A5 [► 165]")



Consequential error!

Please contact the Beckhoff applications department if the servo drive displays consequential errors that are not described in this section!

Error F4A5 "SoE Communication Parameter Error"

The parameter that caused error F4A5 is output in parameter S-0-0021 (picture below). This can be read in the Diagnostics window.

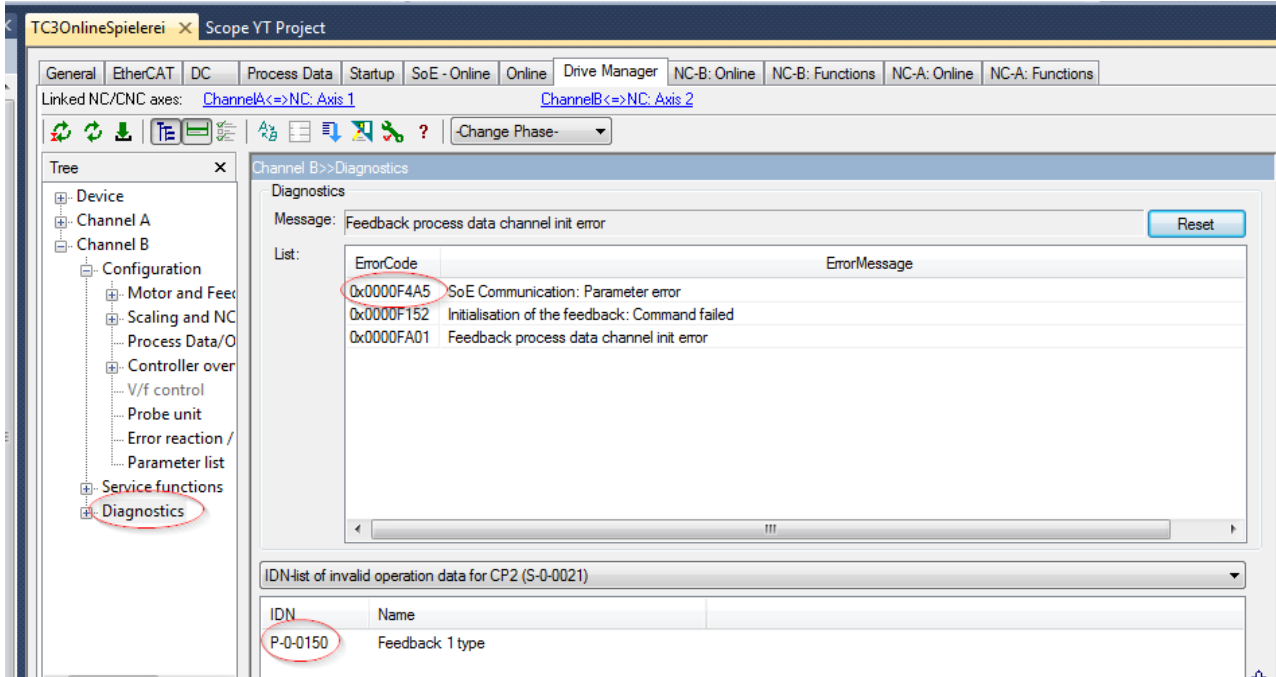

In this case F152 and FA01 are consequential errors of F4A5. The cause of the error is an incorrect setting in parameter P-0-0150.

IDN	Name	Value	Unit
P-0-0150	Feedback 1 type	0	
	Manufacturer	0: Unknown manufact...	0: Unknown manufact...
	Feedback type	1: Linear feedback	1: Linear feedback
	Feedback type string	Unkn#1Vpp-1mm-5Vfix...	Unkn#1Vpp-1mm-5Vfix...
	Feedback use	0: Commutation motorf...	0: Commutation motorf...
	Feedback direction	0: Positive direction	0: Positive direction
	Power settings		
	Process channel		
	Process interface	1: Sin / Cos with 1 V p...	1: Sin / Cos with 1 V p...
	Connector	5: X21 (Front, Encoder...	5: X21 (Front, Encoder...
	Data		
	Sin / Cos		
	Signal periods per rotation	0	0
	Length per signal period	1000000	1000000 nm
	Sin gain correction	1.000	1.000

A value > 0 must be entered for "Signal periods per rotation" (picture above). This takes place automatically if, during the configuration, the motor is selected first and then the feedback.

The correct value is the pole pair distance / ("Length per signal period")

Sample:

$$\text{Signal periods per rotation} = 24\text{mm} / 1000000\text{nm} = 24$$

The error message F4A5 can also occur with a reference to parameter S-0-0113 "Maximum motor speed":

The screenshot shows the Beckhoff diagnostic software interface. The 'Diagnostics' window is open, displaying a list of error messages. The error '0x0000F4A5 SoE Communication: Parameter error' is highlighted with a red circle. Below this, the 'IDN-list of invalid operation data for CP2 (S-0-0021)' table is visible, with the entry 'S-0-0113 Maximum motor speed' also circled in red.

ErrorCode	ErrorMessage
0x0000FD15	The maximum feedback frequency is too high.
0x0000F4A5	SoE Communication: Parameter error

IDN	Name
S-0-0113	Maximum motor speed

In this case the additionally occurring error message FD15 allows a conclusion to be drawn about the cause: the selected measuring system and the maximum velocity configured in S-0-0113 result in a too high input frequency at the encoder input (X11/X21).

Sample:

Measuring system with 20 µm signal period. Maximum travel speed of the motor = 12 m/s.

$$12 \text{ m/s} : 20\mu\text{m} = 1000000 \text{ 1/s} = 1 \text{ MHz}$$

The max. permissible input frequency for sine/cosine signals at X11/X21 is 250 kHz.

Remedy: Reduce the value of S-0-0113. The maximum possible speed of the motor is required only in very few applications.

Note: The value of the max. speed is shown in the parameter list in rpm. In the case of linear motors 1 rpm is one pole pair distance per minute.

S-0-0113	Maximum motor speed	30000	30000	rpm
----------	---------------------	-------	-------	-----

Conversion of the displayed value for a motor with a pole pair distance of 24 mm:

$$30000\text{rpm} * 0.024\text{m} / 60 = 12 \text{ m/s}$$

i Further information can be found in the parameters:

S-0-0021 and P-0-0150.

Error F107 "Status of the axis: current controller not ready"

If this error appears, the entry "Commutation Mode" in parameter P-0-0150 must be changed from "No commutation" to "2:Commutation Offset 0 deg" or "3:Adjustable mechanical Offset". Refer also to section "Determination of the commutation offset".

P-0-0150	PS	069	Feedback 1 type	
			Manufacturer	0: Unknown manufacturer
			Feedback type	1: Linear feedback
			Feedback type string	Unkn#1Vpp-20um-5Vfixed
			Feedback use	0: Commutation motorfeedback
			Feedback direction	0: Positive direction
			rsvd	
			Power settings	
			Process channel	
			Parameter channel	
			Parameter interface	0: No commutation interface
			Connector	0: No connector
			Identifier	0
			Bit resolution singletum position	0
			Bit resolution multitum position	0
			Number of clockcycles to get singletum posi...	0
			Number of clockcycles to get multitum position	0
			Digital name plate	0: No digital name plate
			Commutation mode	0: No commutation position
			Adjustable commutation offset (mechanical)	0: No commutation position deg
				1: Feedback commutation offset
				2: Commutation offset 0 deg
				3: Adjustable mechanical offset (

NOTE

Nature and source of the danger

The setting "0: No commutation position" is intended to prevent an axis being inadvertently activated and then moving in an unforeseeable manner or "running away". If not already done, it is essential after the change to determine a valid commutation offset before the axis is activated (enabled).

Checking the motor connection and feedback

The motor can execute a defined movement independently of the feedback on the basis of command P-0-0166. If the movement is observed (e.g. with the software oscilloscope), conclusions can be drawn about the feedback settings.

The screenshot shows the Drive Manager software interface. The left sidebar displays a tree view with 'Channel A' expanded to 'Service functions' > 'Drive commands'. The main window shows the configuration for command P-0-0166: 'Motor and feedback connection check (pc)'. Below the command selection, a table lists parameters activated by the command:

IDN	Name	ActValue
P-0-0057	Electrical commutation offset	270.00
P-0-0167	Motor and feedback connection check parameter	
	eMode	0: Rotating vector
	Current level	50.0
	Moving distance	360
	Velocity	30
	rsvd	0
	rsvd	0
	Results	
	EqualDirections	0: No
	Commutation position difference (electrical)	0.00
	rsvd	0
	rsvd	0

Enter a value of 360 degrees in parameter P-0-0167 in the setting “Moving distance”. On execution of P-0-0166 the motor is then moved by one electrical revolution. In the case of linear motors this corresponds to one pole pair distance. Since the motor executes an undefined movement before that, it is a good idea to record the complete movement with the software oscilloscope.

The following signals should be recorded:

- Torque Feedback (S-0-0084)
- Position feedback value 1 (S-0-0051)
- ActPos (from the NC)

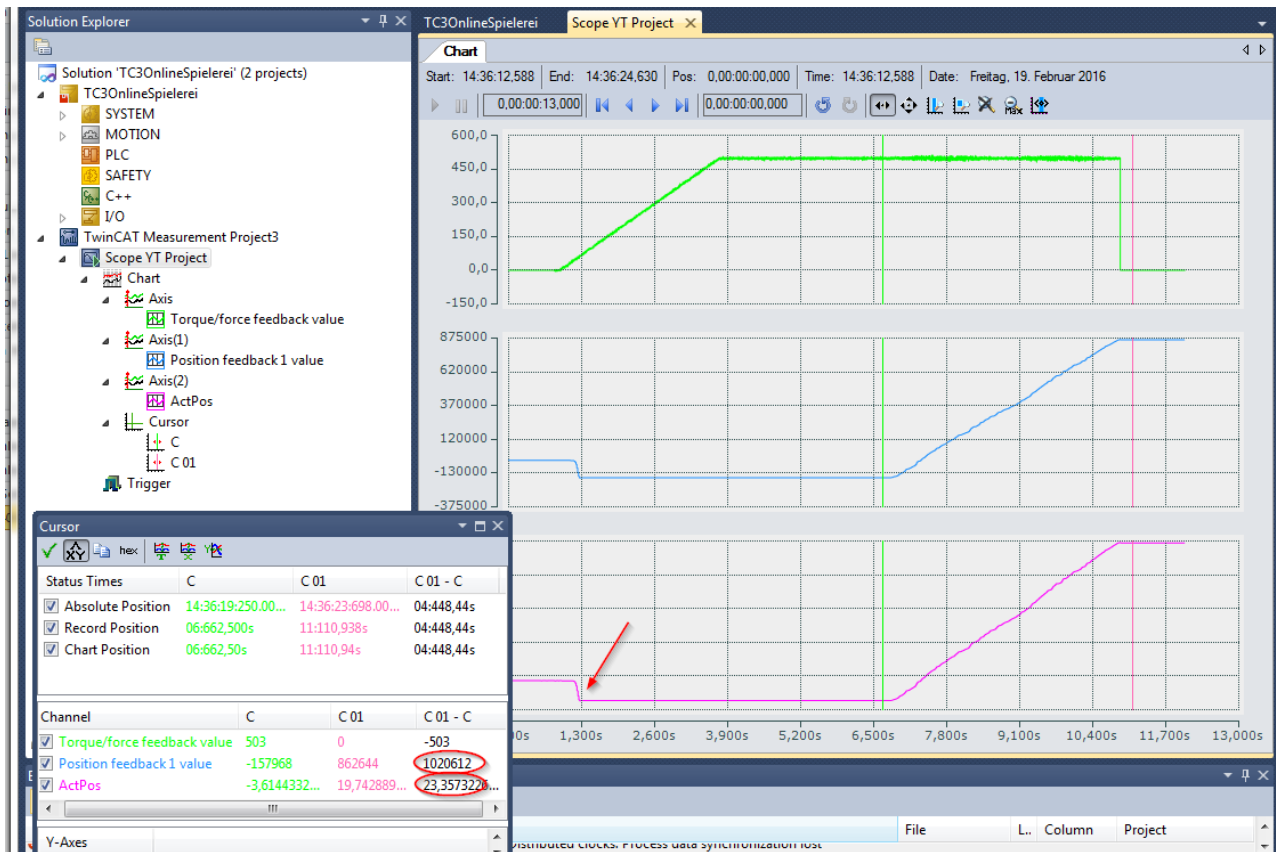

If the motor doesn't move by the expected pole pair distance, check the value entered in parameter P-0-0125 (Pole pair distance).

The jerky movement at the beginning (picture above → red arrow) is not included in the observation. The motor aligns itself via the poles.

From the current curve it can be seen that the value initially ramps up and is then kept constant for a while. During that time the direction is electrically turned once. The value set in parameter S-0-0051 should increase by approx. 2^{20} (1048576) increments. The NC position (ActPos) should increase by the value of a pole pair distance. In the example the values are sufficiently precise with 1020612 and 23.357.

If the increase of S-0-0051 differs considerably from 2^{20} , the resolution of the linear encoder has not been entered correctly.

If S-0-0051 proceeds correctly but ActPos displays a wrong difference, the scaling factor has been set incorrectly.

The connection of the motor phases must be checked if the movement does not proceed evenly, but only a jump takes place, for example.

9.1.5 Third-party motors

9.1.5.1 Commutation offset for third-party motors

9.1.5.1.1 Preliminary remark

This section provides information on checking a direction of rotation and determining the commutation offset for third-party motors.

Please observe the following notes:

A commutation offset can only be determined and stored for motors with resolver, absolute encoder (single- or multi-turn) or the part-absolute MES.

For incremental encoders (sine/cosine or TTL signals) the “Wake&Shake” routine must be configured. This is necessary, since in this case the commutation offset is not constant. The “Wake&Shake” routine redetermines the commutation offset after each start.

● Do not use the electronic name plate!



If a motor with an EnDat or BISS encoder is used, we advise against not using an electronic name plate.

NOTE

Inversion of the count direction

All direction settings must have their default values. Do not invert a count direction before the correct commutation angle was determined!

The offset to be determined can be a mechanical offset relative to the rotor position or an electrical offset relative to the electrical rotation. Both procedures are explained below.

● Further information can be obtained in the parameters:



P-0-0057, P-0-0058, P-0-0150, P-0-0160, P-0-0166, P-0-0167

9.1.5.1.2 Checking the direction of rotation

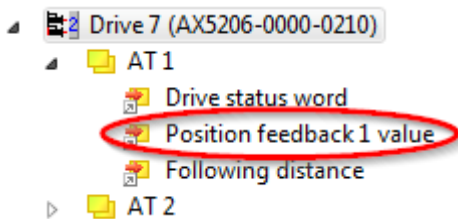

Please note that for proper operation the count direction of the feedback system must match the sequence of the motor phases.

Turn the motor shaft clockwise, viewed from the A-side. The parameter “Position feedback 1 value” (see lower image) should be positive. If this is not the case, the sine and cosine signals at the motor should be swapped.

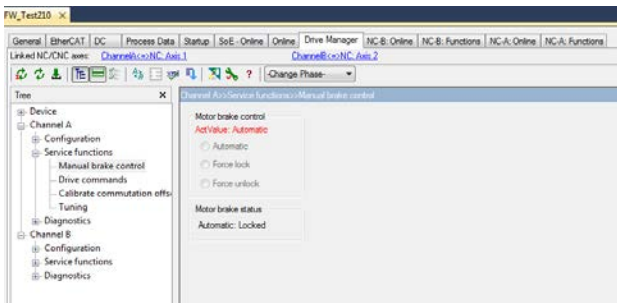

If the motor has a holding brake, it can be released in the TCDriveManager under “Service functions/ Manual operation” (see lower image).

Now use the command P-0-0166 to check the counting direction of the feedback system and whether it matches the connection of the motor phases.

⚠ CAUTION

Motor movement!

When you check the counting direction of the motor with the command P-0-0166, the motor will move. Therefore, please keep a safe distance from the motor with all body parts before you start the command P-0-0166!

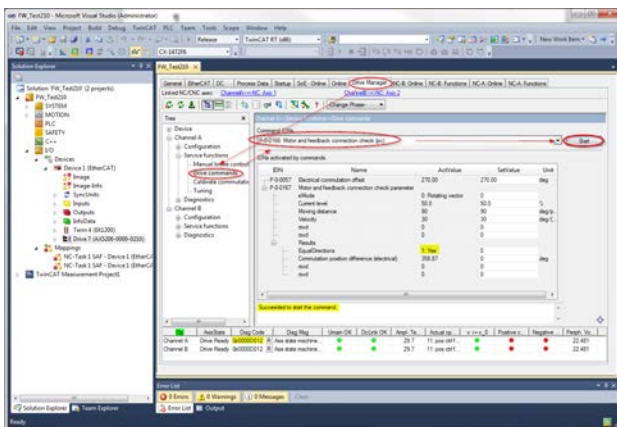

The AX5000 must be set inactive without error (diag code = 0x0000D012).

After selecting the command P-0-0166 press “Start”. Confirm the selection (Do you really want to continue?) with “Yes”.

The command P-0-0166 was successfully completed when the message “Succeeded to start the command” appears in the context menu.

The verification result can now be read in parameter P-0-0167. If the “Equal Directions” selection area shows 0: No, change the order of the motor phases (The direction of rotation of the feedback system was already checked and possibly corrected in the previous step).

i Please do not use a TwinCAT setting to change the motor phases at the motor connection.

Swap motor phases U and V, for example, at the motor connector plug (X13/X23).

If the “Equal Directions” selection area now shows 1:Yes, the commutation offset can be determined based on one of the following methods.

9.1.5.1.3 Determining the electrical commutation offset

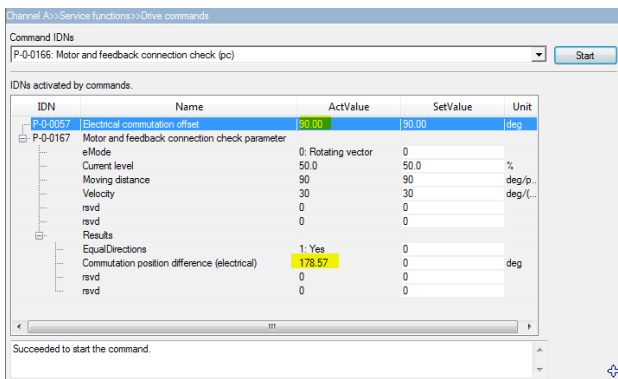

Execute the command P-0-0166 (see section “Checking the direction of rotation”). To determine the commutation offset we need the current value from parameter P-0-0057 and the current value from parameter P-0-0167:

Read the value for “Commutation position difference”. Subtract this value from the value in P-0-0057 “Electrical commutation offset”. If the result is positive, this is the new value for P-0-0057. If the result is negative, add 360°.

Sample:

$$90^\circ - 178.57^\circ = -88.57^\circ$$

$$-88.57^\circ + 360^\circ = 271^\circ \text{ (fractions can be neglected.)}$$

The result is the new value for P-0-0057 “Electrical commutation offset”. Enter the value at SetValue and confirm with <Enter>. Confirm the message that is displayed with <Yes>.

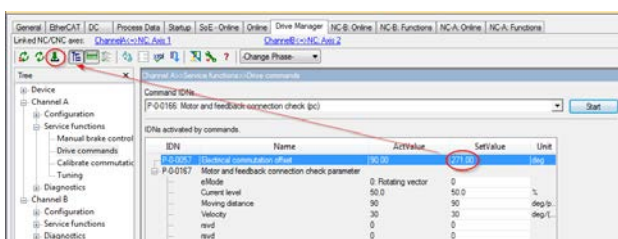

Pressing the download button (red circle) activates the new value immediately.

The value is displayed in the setting “ActValue” after the download is complete. Execute command P-0-0166 again!

The value for “Commutation position difference” should now lie within the range: 355 ... 360 = 0 ... 5. 355 ... 360 = 0 ... 5 liegen.

If this value is displayed you have successfully completed the commutation search! The offset value has already been adopted into the startup list with the download button.

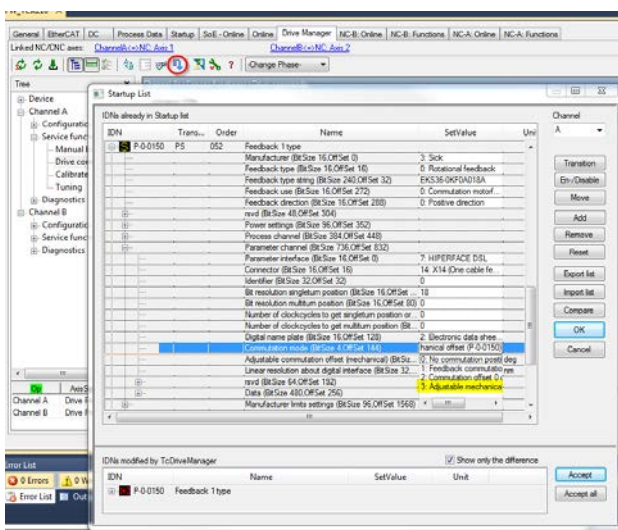

To use the commutation angle, the “Commutation mode” must be changed in parameter P-0-0150:

Change the entry “Commutation mode” to “3:Adjustable offset”. Then reactivate the TwinCAT configuration.

After changing the “commutation mode” once, this method has the advantage (compared with the mechanical offset) that the offset (P-0-0057) can be changed at any time without having to restart the system.

9.1.5.1.4 Determining the mechanical commutation offset

Abridged procedure:

Adjustable commutation mechanical value!

i Before determining the mechanical commutation offset, check whether the value "Adjustable commutation mechanical" in P-0-0-0150 is set to 0. If this is not the case, set the value to 0 and activate the TwinCAT configuration. Then perform the steps described below.

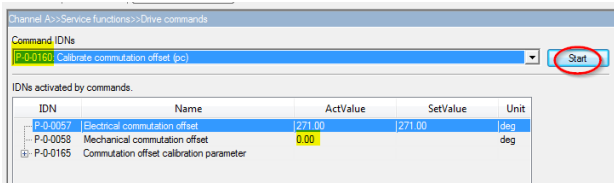

- 1.) Run command P-0-0160.
- 2.) Press the "Download" and "Start" buttons. Wait until the "Succeeded to start the command" appears.
- 3.) You get a new value in parameter P-0-0058 "Mechanical commutation offset". Remember this value.
- 4.) Open the "Startup list". Open the parameter structure P-0-0150. Open "Parameter Channel".
- 5.) Set parameter P-0-0150 "Feedback 1 Type" in "Commutation mode": 3 Adjustable offset.

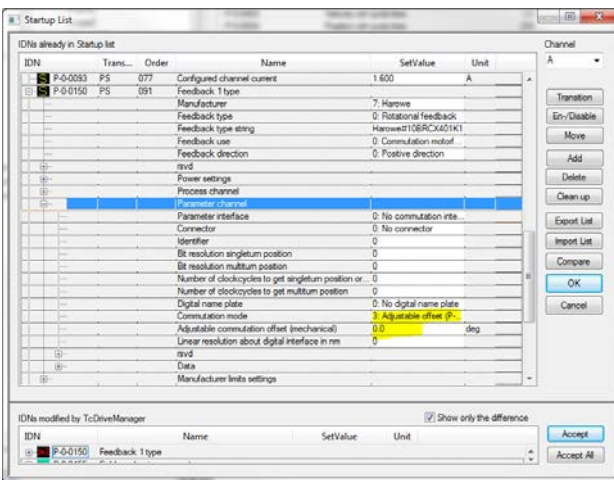

- 6.) Change the value in P-0-0150 "Feedback 1 Type" in the "Adjustable commutation offset (mechanical)" to the value which you have previously read in parameter P-0-0058. Confirm with OK and activate the configuration in the TwinCAT System Manager.

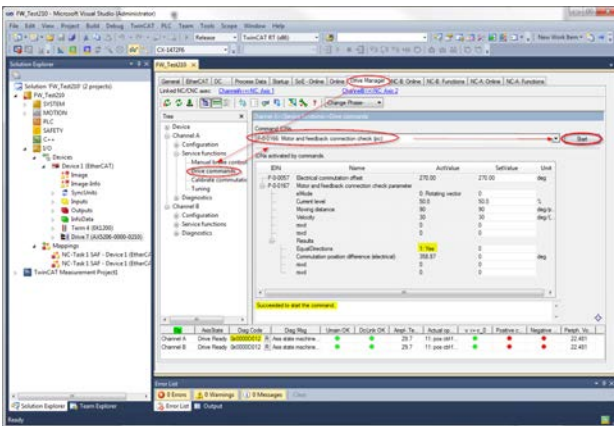

- 7.) Change to the "Drive Commands" tab and execute command P-0-0166 "Motor and feedback connection check".
- 8.) Leave the default values and confirm with Start. If the message "Succeeded to start the command" appears, open the parameter structure of the P-0-0167 "Results". "Equal direction" must be "Yes" and "Command position difference" must be between 355 ° and 360 "(0 ° ... 5 °)".

⚠ CAUTION

Motor movement!

If you execute the command P-0-0160 or P-0-0166, the motor performs a movement. Therefore, please keep a safe distance from the motor with all body parts before you start the command P-0-0160 or P-0-0166!

9.1.5.1.5 Configuration of the Wake&Shake routine

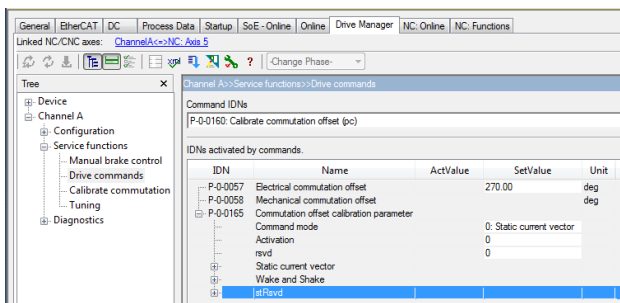

A configuration requirement is that the count direction of the feedback system matches the sequence of the motor phases.

Details of the process for finding the commutation with "Wake&Shake" can be found in the Beckhoff Information System under the keyword: "Electronic commutation".

This section only contains a brief overview.

The command P-0-0160 executes the routine. The type of execution can be set in parameter P-0-0165.

For "Command mode" you can select between: Static current vector and Wake and Shake.

- 0:
- 1:

auswählen.

The "Static current vector" procedure results in a larger motor movement. It can be used for testing.

The "Wake and Shake" procedure minimizes the axis movement. This procedure is the one that tends to be used in practice.

Both procedures determine a commutation offset, although this is not shown in parameter P-0-0058. This is due to the fact that a new value has to be determined at each restart. This value depends on the axis position. The numerical value is therefore meaningless for the user.

The result can then be checked with the command P-0-0166. Both procedures should initially be performed with the default values.

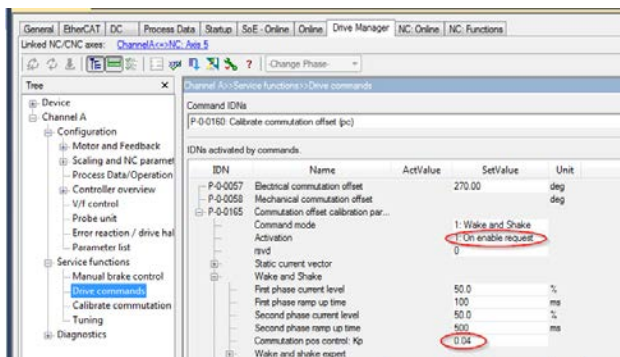

The setting "Activation 1: On enable request" has the effect that the AX5000 automatically executes a commutation search with the first enable after a restart.

With "Wake and Shake" it often makes sense to set "Commutation pos control: Kp 0", in order to avoid execution errors.

9.1.6 Homing

9.1.6.1 Homing

Homing refers to an axis initialization run during which the correct actual position is determined by means of a reference signal. This procedure is referred to as *homing*, *referencing* or *calibration*. A switch that is triggered at a known, unique position along the travel path serves as reference signal. Further signals such as the encoder zero track can be analyzed in order to increase the precision.

In general a distinction is made between drive-controlled homing and NC-controlled homing. Drive-controlled homing is carried out automatically by a suitable drive without input from the control system and is not discussed in detail in this documentation. NC-controlled homing is fully controlled by the control system and supports a wide range of drive types. The different NC-controlled homing mechanisms are described below.

Position reference systems and encoder systems

A distinction is made between different position reference systems (measurement systems), depending on which position measuring system is used. An *absolute measurement system* provides an absolute position (directly after switching on) that is unique over the whole travel path. Such a measurement system is calibrated once and set via a persistently stored position offset. In this case homing is not required even after a system restart. In contrast, *relative measurement systems* provide a non-unambiguous position value (after switching on) that must be calibrated through homing. Relative measurement systems are subdivided further into purely relative systems (incremental encoders) and part-absolute systems, which only provide a unique position during a motor or encoder revolution.

- Absolute position - e.g. multi-turn encoder
 - BiSS
 - EnDat
 - Hiperface
 - SSI
- Part-absolute position - e.g. single-turn encoder
 - BiSS
 - EnDat
 - Hiperface
 - MES (Beckhoff)
 - Resolver
- Relative position - incremental encoders
 - Sine / cosine (sine 1 Vss)
 - HTL (rectangle)

General description of a homing procedure

Figure A shows a schematic diagram of a homing procedure with individual velocity profile phases.

1. When the machine is switched on the axis is in a random position (1).
2. Homing is initiated, and the axis travels towards the reference cam.
3. Once the reference cam is detected, the axis stops and reverses.
4. The axis moves away from the reference cam and detects the falling edge of the reference cam signal.
5. The axis continues and searches for a sync pulse or another distinctive event, depending on the reference mode setting. This step may be omitted where appropriate.
6. The occasion is detected and the specified reference position is set.
7. The axis stops and thus stands slightly away from the reference position. The reference position was set a short while before with maximum accuracy.

Figures B and C show the position and velocity profile during homing.

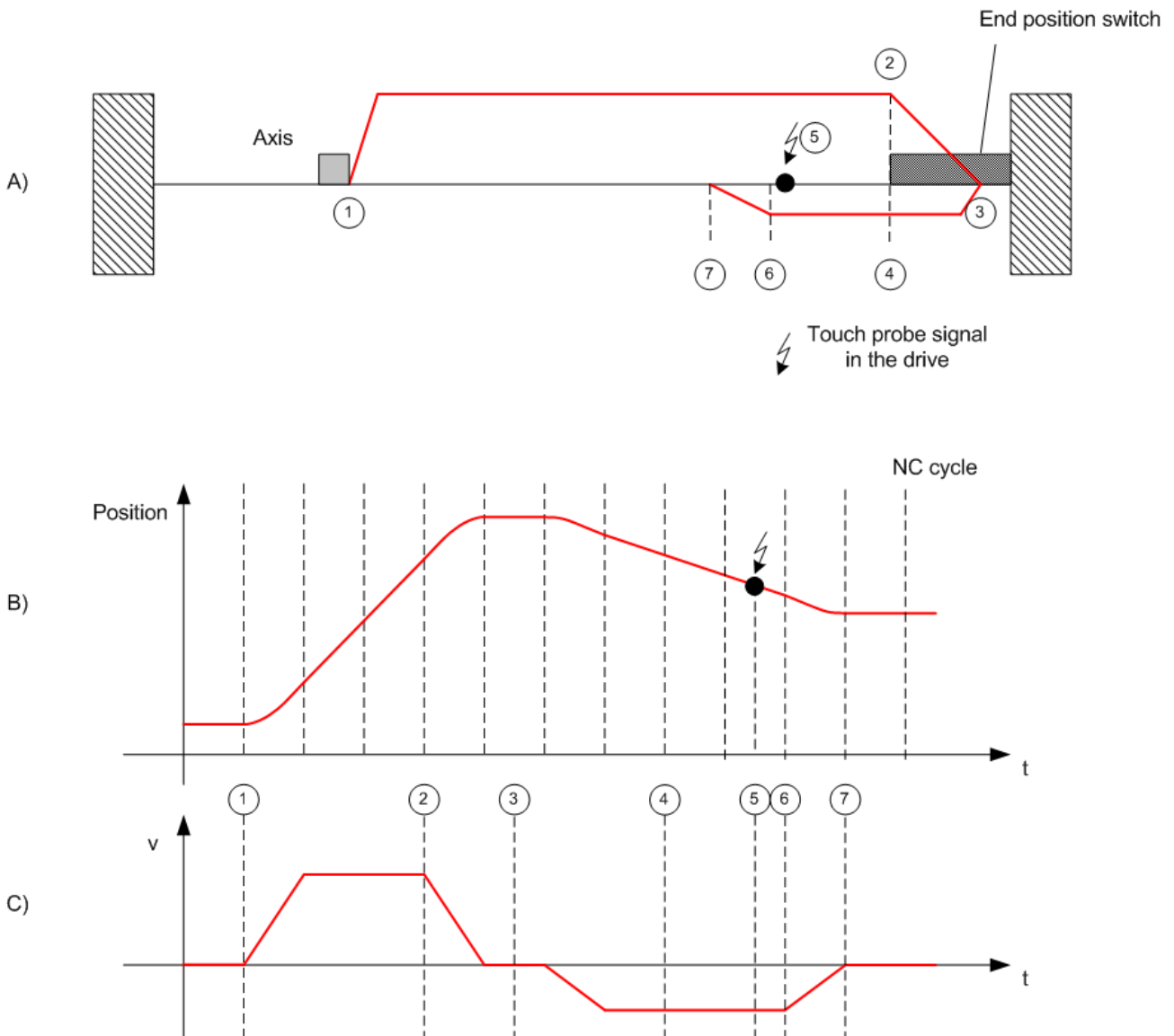

Referencing modes

The NC system supports different referencing modes, depending on the encoder system type.

- **Homing based on reference cam (Plc Cam)**
The simplest axis referencing mode uses a reference cam that generates a digital signal at a defined position along the travel path. During homing the NC determines the signal edge and allocates a configurable reference position to this position. Referencing based on a reference cam is always possible, irrespective of the encoder type, and is a prerequisite for other, more precise modes.
- **Software Sync**
Software Sync mode enhances the homing precision by additionally detecting the encoder count overflow after an encoder or motor revolution, after the reference cam signal has been detected. This mode requires a part-absolute encoder (e.g. resolver) with constant overflow interval relative to the reference cam. Overflow detection is parameterized via the *Reference Mask* parameter (see System Manager section).
- **Hardware Sync**
Some encoder systems provide a sync pulse per revolution (zero track) in addition to the count. The homing precision can be enhanced by selecting this mode, if the encoder evaluation logic is able to pick up the sync pulse. The precision is comparable with Software Sync. Hardware Sync mode may require parameterization or special wiring of the drive or encoder system.
- **Hardware Latch**
Hardware Latch reference mode (*Hardware Latch Pos* or *Hardware Latch Neg*, depending on edge) requires an external digital latch signal for storing the encoder position in the evaluation unit of the encoder system. The encoder system must support such a latch function and may have to be configured first in order to be able to utilize this function.

	Absolute encoder system	Part-absolute encoder system	Relative encoder system
NC	Referencing not required	Recommended reference mode <i>SoftwareSync</i> (also possible: <i>PlcCam</i> , <i>HardwareSync</i>)	Recommended reference mode <i>HardwareSync</i> (also possible: <i>PlcCam</i>)
Drive	Referencing not required	Drive setting not required	Drive parameterization required (for Sercos/SoE see Probe Unit)

Parameterization in the System Manager

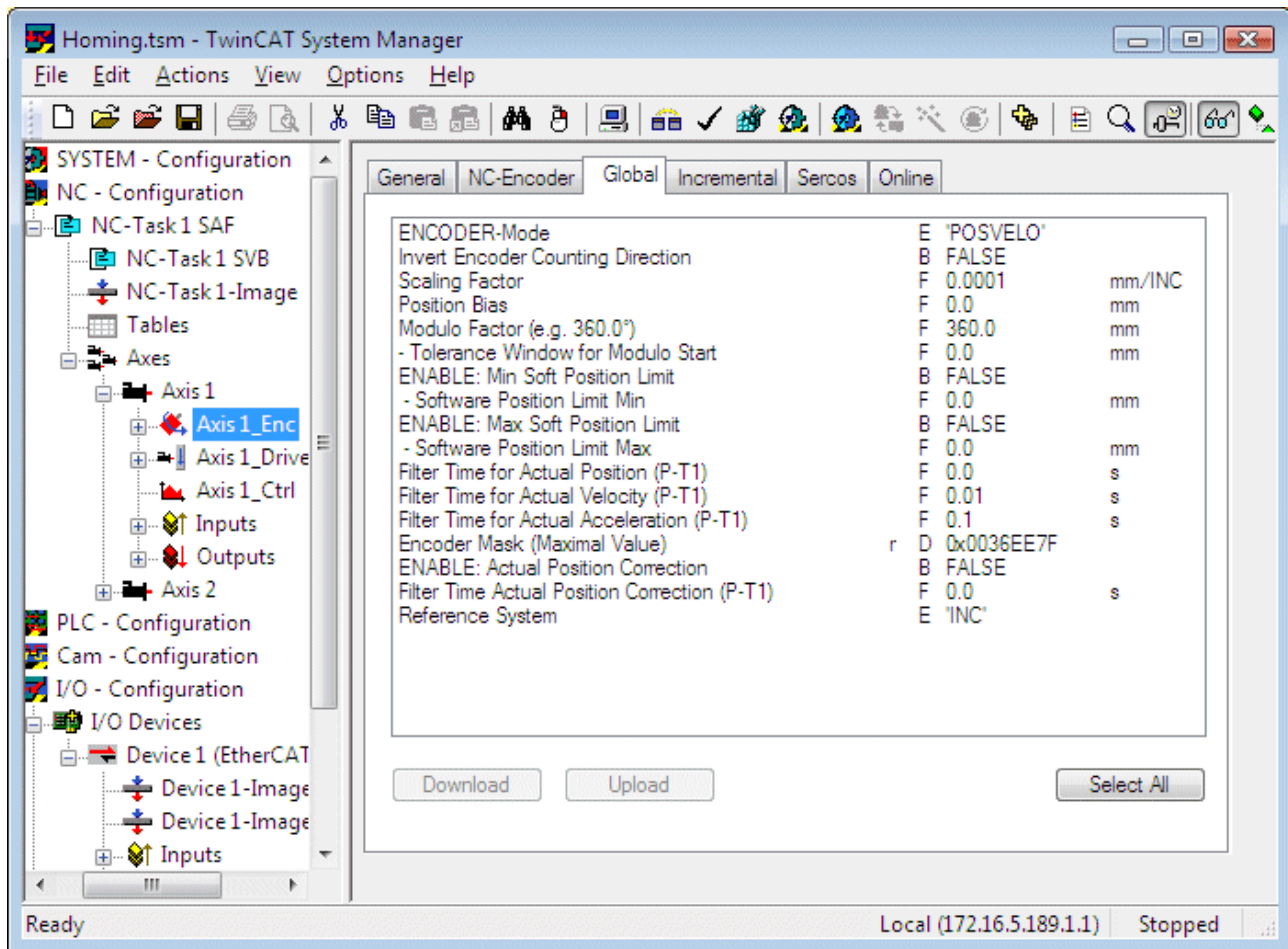

Reference System : The encoder parameters *Reference System* determines whether the encoder system used is incremental or absolute. In an absolute encoder system the encoder value is taken from the control system without modification.

Not all NC encoders support this optional parameter, i.e. only those types that offer a choice between absolute and incremental encoder reference system (measurement system) support it (e.g. SERCOS, KL5001, M3000, ProfiDrive, Universal). This choice determines whether the actual encoder position is interpreted and evaluated as an absolute or incremental position, based on an absolute or incremental reference system (measurement system).

In an absolute reference system no further processing takes place with regard to encoder counter value overflow or underflow. It is assumed that the counter value is unique within the axis traversing range and no encoder counter value overflow or underflow occurs. Otherwise there would be a discontinuity in the actual position, resulting in a position following error. Axis referencing via MC_Home is not possible. Instead, the actual position is calibrated once via the parameter *Position Bias (zero offset / position offset)*.

In an *incremental reference system* axis referencing via MC-Home is generally required. In addition the NC automatically detects and accounts for encoder counter value overflow or underflow events, so that continuous axis operation is possible over many months ("infinite range").

Encoder Mask (maximum value): The *encoder mask* determines the bit width for the incremental encoder position. The encoder mask is used for detecting and counting in range overflow events.

Scaling Factor: The *scaling factor* is multiplied by the incremental encoder position, including all overflows. From this an absolute axis position can be calculated with the parameterized physical unit.

Position Bias (zero offset): Position offset; moves the axis coordinate system relative to the encoder coordinate system. This value is mainly used in absolute encoder systems. In relative systems an offset is usually not required, since the system moves to a parameterized reference position after homing.

Invert Encoder Counting Direction: The encoder count direction can be inverted if it does not match the required logical count and travel direction.

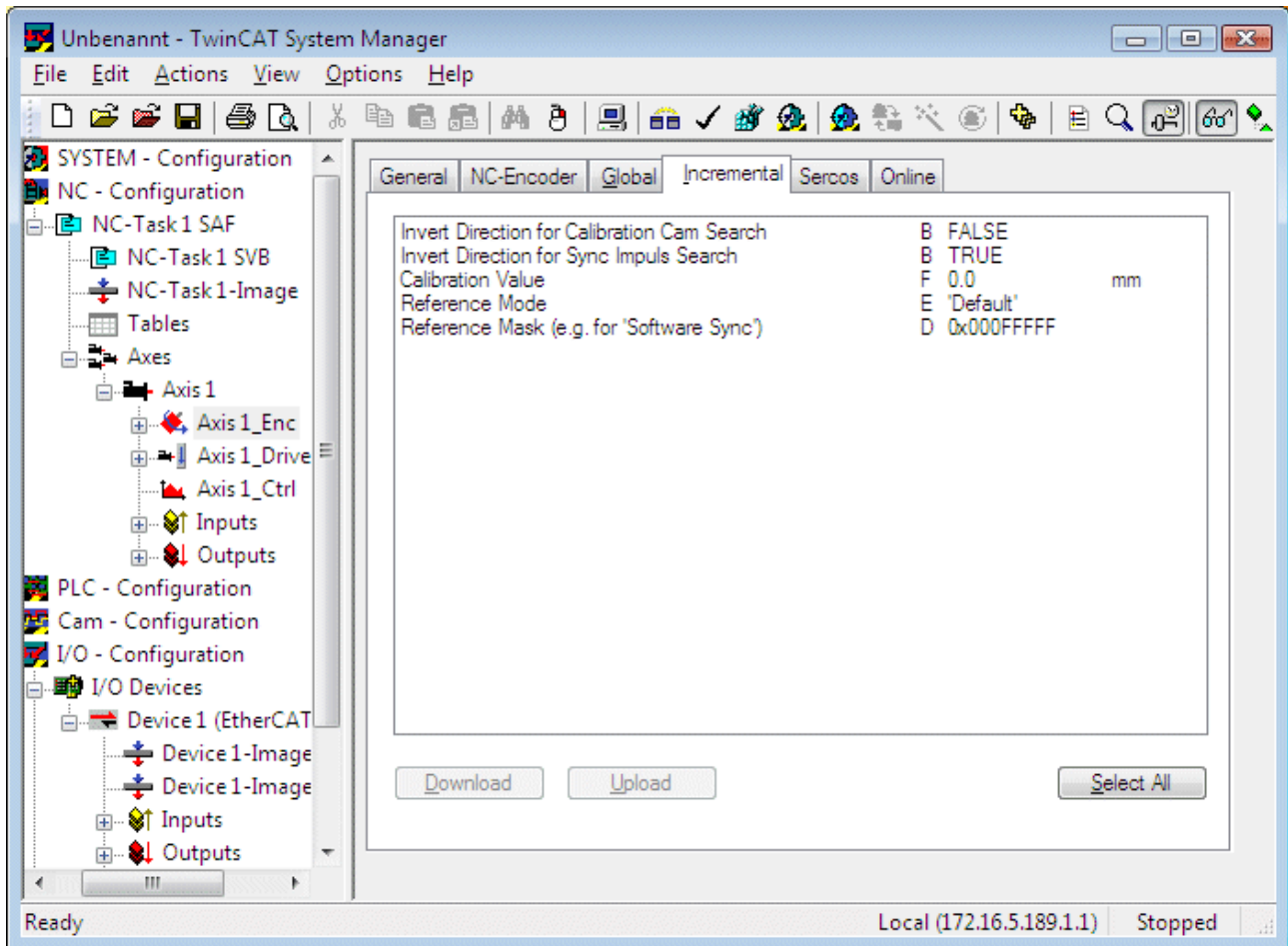

Reference Mode : *Referencing mode* as described above (*Plc CAM, Hardware Sync, Hardware Latch Pos, Hardware Latch Neg, Software Sync*). The *default* mode corresponds to *Plc CAM* mode.

The *Reference Mode* parameter is used to specify the type of reference event (physical or logical event) for the referencing process. Depending on the parameterized reference mode, during the referencing procedure either the hardware property of the drive or encoder (e.g. hardware latch) is used, or the reference event is exclusively detected within the control, i.e. without further hardware reference.

Reference Mask: The *reference mask* parameterizes overflow detection for *Software Sync* reference mode. It is less or equal the encoder mask and defines an encoder value range, which is part-absolute. Examples include the bit width of a motor revolution or the bit width of a sine period in a sine/cosine encoder. *Software Sync* therefore always detects the same overflow position in a part-absolute encoder system.

Calibration Value: *Reference position* to which the axis position is set after homing.

Invert Direction for Calibration Cam Search: The parameter inverts the axis travel direction for searching the referencing cam during homing. The standard direction is negative, i.e. towards the axis coordinate system origin.

Invert Direction for Sync Impuls Search: The parameter inverts the axis travel direction for searching the sync pulse during homing.

Referencing of coupled axes

TwinCAT enables axis coupling during referencing. The coupled axes do not necessarily have to be referenced. Axis coupling enables referencing of gantry axes, for example, provided the system can ensure that the two axes are suitably oriented relative to each another before homing. In this case the procedure is as follows:

- Ensure that both axes can be moved in coupled mode. (Position comparison is not possible at this stage, because none of the axes is referenced.)
- Couple axis 2 with axis 1.
- Start homing for axis 1. Slave axis 2 will travel with axis 1.
- Decouple the axes after the homing procedure.
- Couple axis 1 with axis 2.
- Start homing for axis 2. Slave axis 1 will travel with axis 2.
- Decouple the axes after the second homing procedure.
- Move both axes to a set position for alignment. The travel path for both axes should be minimal and may correspond to the mean value from both positions, for example.
- Couple the axes. The coupled system is now referenced.

Programming a homing procedure in the PLC

MC_Home

The MC_Home function block is used to initiate homing from the PLC. The reference mode and further parameters are configured in the System Manager as described above. Only the reference cam signal (bCalibrationCam) is fed into the block.

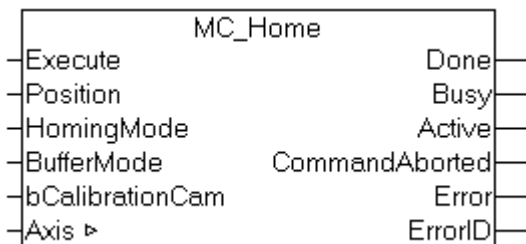

Drive types and I/O interface

Homing is largely independent of the drive types used. In some cases the drive has to be parameterized, particularly if a drive latch function is used. The following chapter describes the version with the AX5000.

9.1.6.2 Special characteristics in hardware end positions

If a SERCOS or SoE drive (e.g. AX50xx) is in a hardware end position (positive or negative), the drive blocks further traversing commands in end position direction and beyond the end position (see also bit 3, *drive follows command value*, in the SERCOS status word), and is therefore no longer operational from a control system perspective. This means that, without special measures, the axis can often no longer be moved from the end position into the valid traversing range via TwinCAT or the control system. This situation is particularly likely to occur with drives in the velocity interface, because in this case the position control leads to frequent changes in direction in the drive velocity output.

In order to rectify this special situation, a control bit in the PlcToNc axis interface (see bit 8 called *AcceptBlockedDriveSignal* in *nDeCtrlDWord*) can be used to force TwinCAT to accept the AX50xx axis as operational and therefore enable a move from the end position into the valid traversing range.

In the past, in many cases the only alternative was to mechanically move the axis away from the end position.

NC interface

PlcToNc axis interface, bit 8 called *AcceptBlockedDriveSignal* in *nDeCtrlDWord*

PLC interface

TcNc-Lib, see PLC function *AxisSetAcceptBlockedDriveSignal* in the TwinCAT PLC Library NC.

Homing with latch function

During homing a trigger event is expected and a position value is latched, depending on the referencing mode (*hardware latch*). Parameterization is required in order to be able to use the drive latch function (see AX5000 Probe Unit).

9.1.6.3 Probe Unit

● Detailed method for configuration of the probe unit:

i For further information of the probe unit, please look at the functional manual of the servo drive AX5000: Probe unit function

9.1.7 Error messages during commissioning

The greatest likelihood of error messages occurs during the commissioning process. Incorrectly assembled cables, missing shield connection, wrongly parameterized motors / feedback systems, mechanical problems and many other issues are detected at this stage. The drive can often not be started or stops after a short time with a diagnostic message.

● Documentation of all error messages

i If an error message occurs, first of all please refer to the error message information in the documentation "AX5000_DiagMessages". You will usually find suggestions for solutions there which can be implemented relatively easily.

9.1.7.1 FA49, Feedback process channel error (1Vss)

When this diagnostic message appears it may indicate an error in the analog signal for the feedback system (1Vss). The AX5000 monitors the output signals from the sin/cos 1Vss feedback system and switches off the drive when the signal lies outside the tolerance range between 0.53 Vss and 1.34 Vss. The feedback systems are specified in such a way that they only supply exact values within the stated tolerance range. Beyond this the values may be usable but are not necessarily so.

Voltage analysis

With an external oscilloscope

The values from the feedback system can be determined with the aid of an external oscilloscope (scope). You can connect an external scope between the feedback connector and the AX5000 and determine the sine and cosine voltages.

With the TwinCAT software oscilloscope

Parameterization of the IDNs P-0-0150 / P-0-0180

● Feedback system 1 or 2

i The diagnostic message FA49 applies to both feedback systems 1 and 2. You can find out which feedback system is currently affected by pointing the mouse cursor at the diagnostic message in the TCDriveManager. A tool tip will then appear showing the faulty feedback system. The IDN P-0-0150 described below applies to feedback system 1. The IDN P-0-0180 applies to feedback system 2 and has the same structure as P-0-0150.

Open the System Manager and select the servo drive (1) which is generating the error. Open the TCDriveManager (2) and select the faulty feedback (4) in the affected channel (3). In the IDN "P-0-0150" (5) under the "Sin / Cos" parameter (6) open the value range (8) under the Parameter "SinCos 1Vss monitoring". Four options appear.

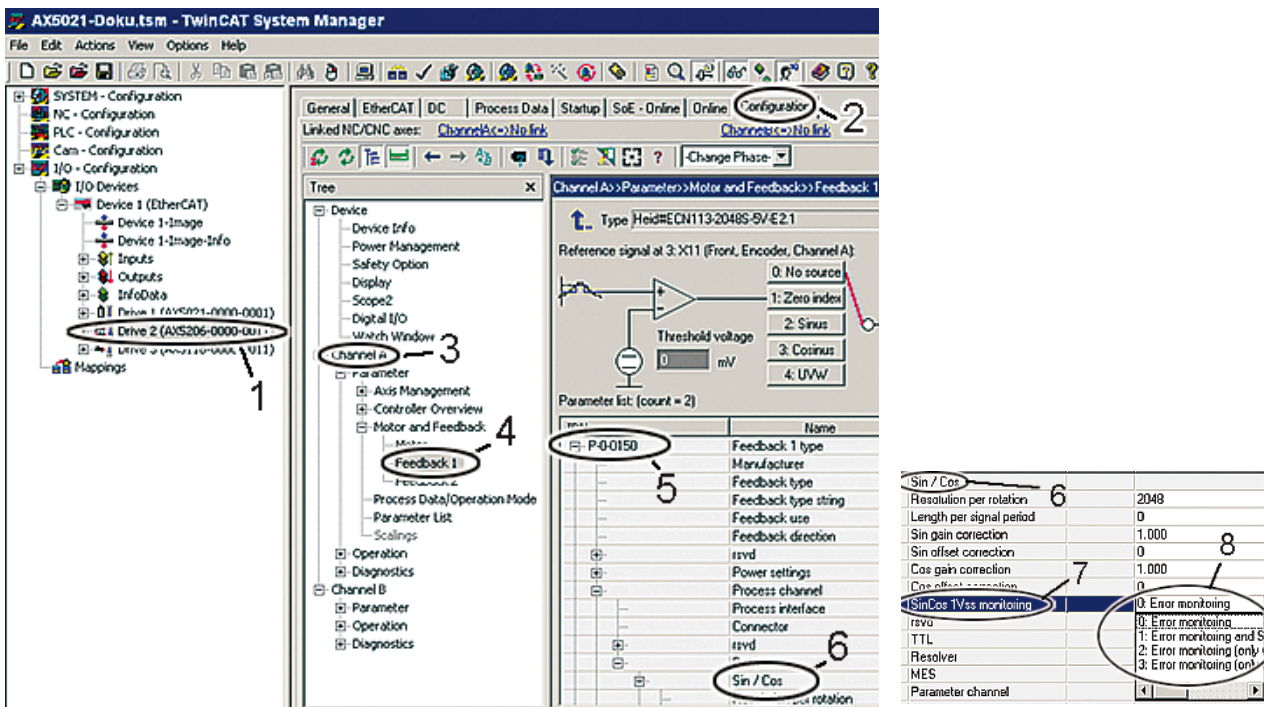

- 0 = Error monitoring (full error monitoring)
- 1 = Error monitoring and Sin/Cos logging (full error monitoring and logging of sin/cos signals)
- 2 = Error monitoring (only wire break detection) and Sin/Cos logging (only wire break detection and logging of sin/cos signals)
- 3 = Error monitoring (only wire break detection)

To log the Sin/Cos signals, select either 1 or 2. Whether to select option 1 or 2 should generally be decided depending on the application. However, there are two rough indications for making the choice:

If the faulty axis can no longer be used because the error always occurs immediately, then you need to select the "2 = (only wire break detection and logging of sin/cos values)" option so that the error can occur and be logged.

If the faulty axis can be operated because the error only occurs sporadically, then you can select "1 = (full error monitoring and logging of sin/cos values)" or "2 = (only wire break detection and logging of sin/cos values)" so that the error can always be logged.

⚠ WARNING

Warning, risk of injury from uncontrolled movements!

If a faulty axis is used then this axis may make uncontrolled movements. Make sure that no one is in the machine's traversing range.

In many cases the faulty axis can also be moved manually and this option should be used preferentially for safety reasons.

Adding the debug pointer to the Startup list

In order for the sin/cos signals to be logged, the relevant debug pointers must be added to the AX5000 Startup list. Call the Startup list in the TCDriverManager using the button (9) and click on "Add" (10). A window opens with a list of parameters including P-0-1006 to P-0-1010 (11).

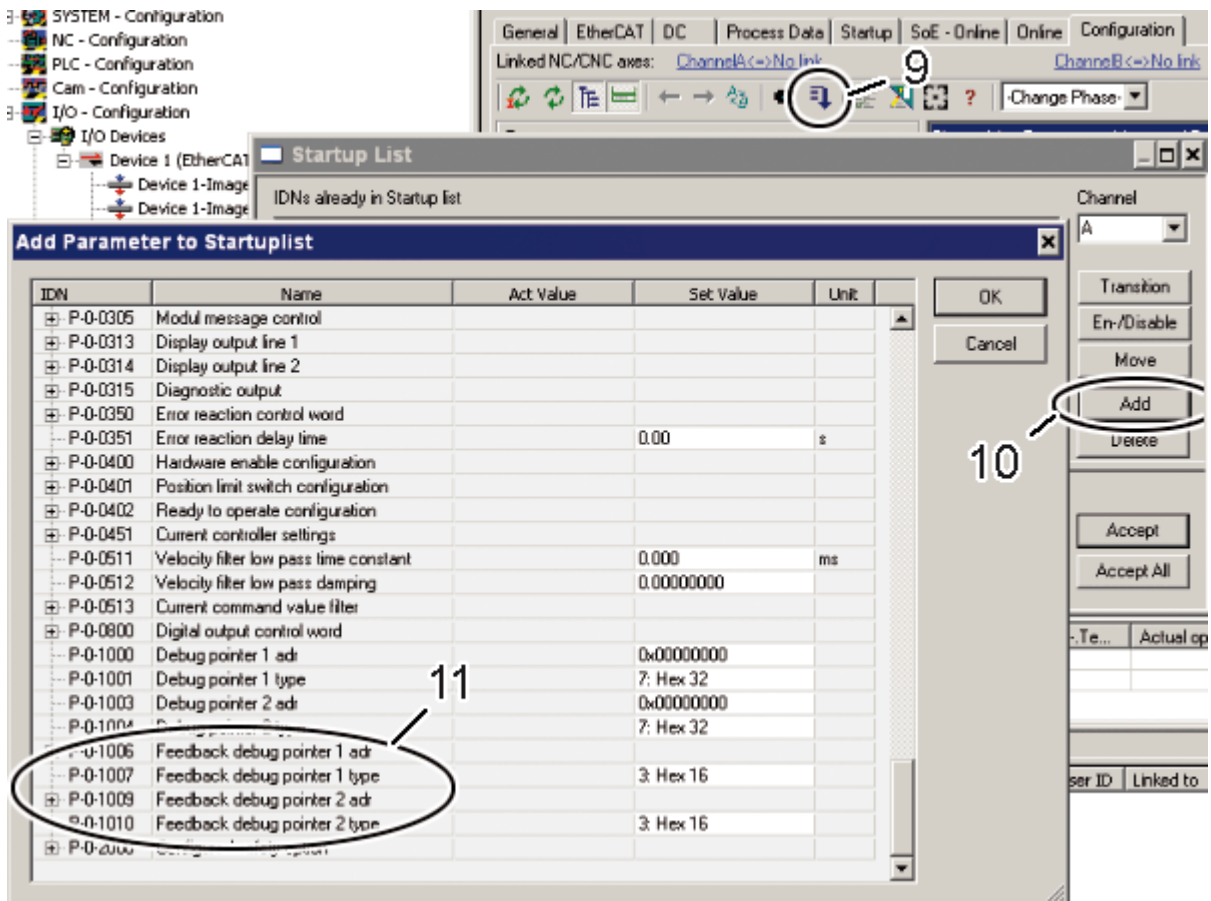

The IDNs need to be parameterized before being added to the Startup list. The IDNs P-0-1006 and P-0-1007 denote sine signals, the IDNs P-0-1009 and P-0-1010 cosine signals; the structures are the same for sines and cosines.

For the IDN "P-0-1006" under "Addr" select the address "0xA000 Sin/Cos ChA: Sin (Int16)" (12).

P-0-1006	Feedback debug pointer 1 adr		Sin/Cos ChA: Sin (Int16)
	Addr		0xA000: Sin/Cos ChA
	Source		0xA001: Sin/Cos ChA
P-0-1007	Feedback debug pointer 1 type	12	0xA002: Sin/Cos ChA
P-0-1009	Feedback debug pointer 2 adr		0xA003: Sin/Cos ChA
	Addr		0xA004: Sin/Cos ChA
	Source		0xA005: Sin/Cos ChA
P-0-1010	Feedback debug pointer 2 type		0xA010: Resolver/MI
P-0-2000	Configured safely option		0xA011: Resolver/MI
			0xA012: Resolver/MI
			0xA013: Resolver/MI
			0xA014: Resolver/MI

Under "Source" select the faulty feedback system, where "0: Front" refers to the feedback system on the front of the AX5000 and "1: Option" refers to the feedback system on the AX5701 / 02 option card.

P-0-1006	Feedback debug pointer 1 adr		
	Addr		0xA000: Sin/Cos ChA: ...
	Source		0: Front
P-0-1007	Feedback debug pointer 1 type		0: Front
P-0-1009	Feedback debug pointer 2 adr		1: Option

For the IDN "P-0-1007" select the option "2: Decimal 16".

P-0-1007	Feedback debug pointer 1 type		2: Decimal 16
P-0-1009	Feedback debug pointer 2 adr		0: Binary 16
	Addr	13	1: Unsigned Decimal 16
	Source		2: Decimal 16
P-0-1010	Feedback debug pointer 2 type		3: Hex 16

You now need to repeat the procedure with the IDNs "P-0-1009" and "P-0-1010". For the IDN "P-0-1009" under "Addr" enter the value "0xA001: Sin/Cos ChA: Cos (Int16)".

Select the four IDNs and press "OK" so that the IDNs are entered in the Startup list.

Activate configuration

In the TCDriveManager (14), click in the tree on "Process Data/Operation Mode". A new window opens where, under "AT or MDT", you select "AT" (16). Next highlight the two IDNs "P-0-1008" and "P-0-1011" (17) and move them into the "Parameter for Process Data" window by clicking on the ">>" button (18).

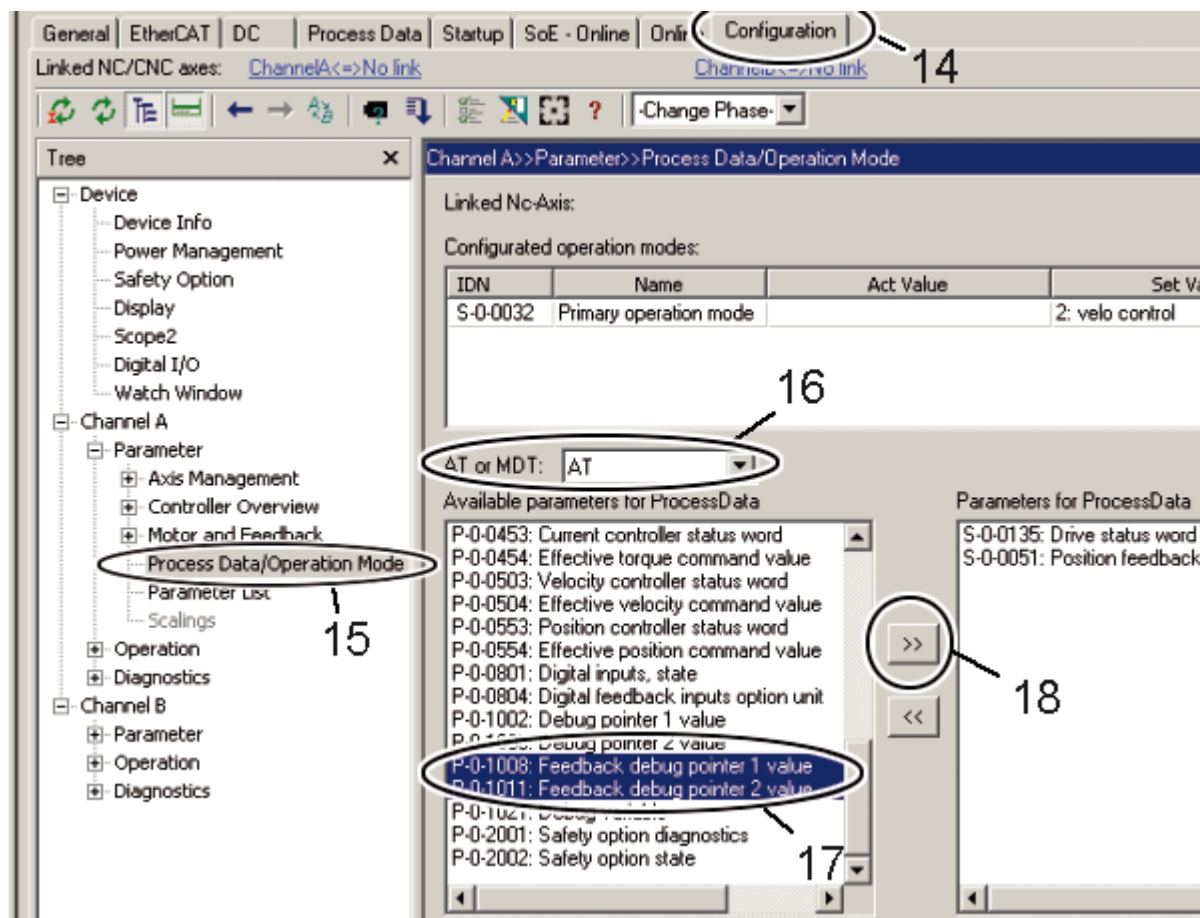

Under the relevant EtherCAT Device (19), activate the ADS Server (20). Now check the boxes beside "Enable ADS Server" and "Create symbols" (21). The "Port" (22) is entered automatically.

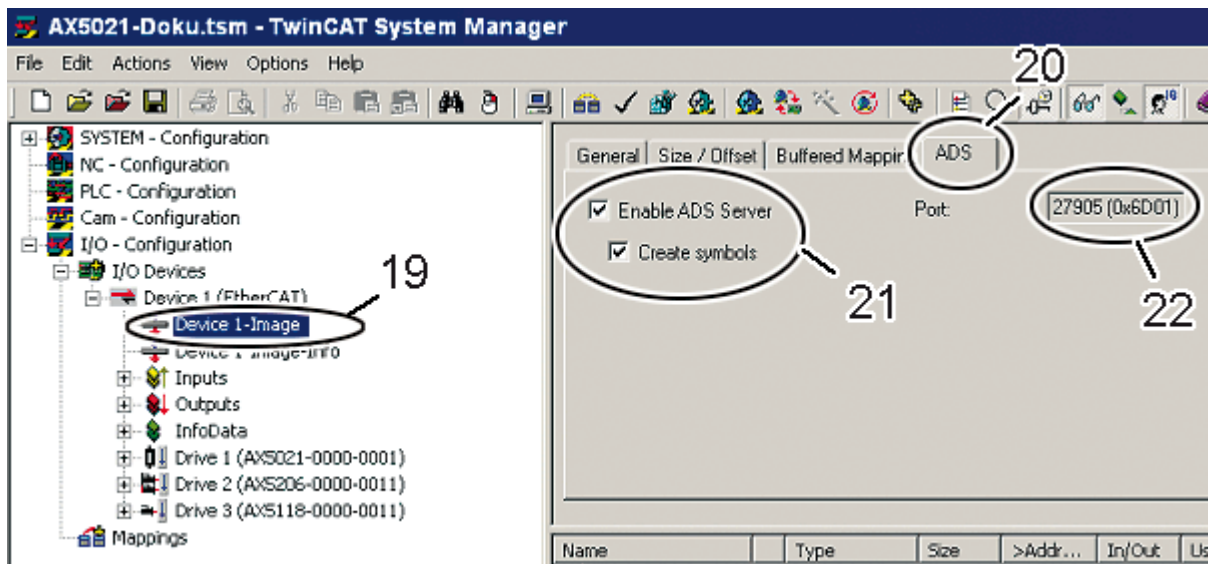

Start "TwinCAT Scope2" and check whether the amplitude values are permissible. The scaling factor is 1 / 46602.

9.2 EtherCAT

9.2.1 Parameter handling

The servo drives from the AX5000 series use a new method for managing their configuration parameters (IDNs).

In contrast to conventional servo drives (e.g. AX2000), these parameters are not stored in a non-volatile manner on the AX5000 itself, but they are transferred from the controller to the drive whenever the EtherCAT fieldbus system starts up. This approach has the advantage that the parameter management takes place exclusively in the corresponding TwinCAT project, without the need for separate data backup of drive parameters. If a replacement is required, it is sufficient to replace the servo drive. There is no need to load parameters onto the servo drive.

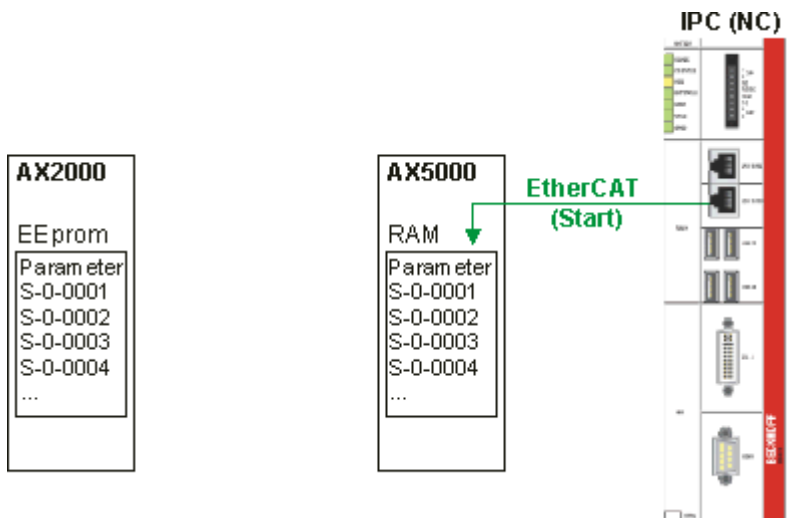

The parameters are transferred from the controller to the servo drive when the EtherCAT system starts up. Due to the high data transfer rate offered by EtherCAT this process is very fast, even in larger systems.

Transitions

During startup the EtherCAT system passes through the following states: Init, Pre-Operational, Safe-Operational, and Operational (see chapter EtherCAT state machine).

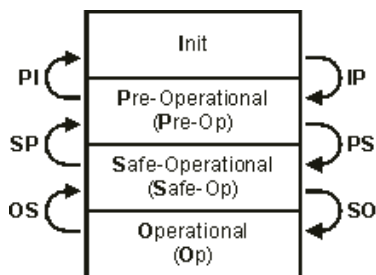

The diagram shows the following transitions:

- IP:** Transition from **Init** to **Pre-Operational**
- PS:** Transition from **Pre-Operational** to **Safe-Operational**
- SO:** Transition from **Safe-Operational** to **Operational**
- OS:** Transition from **Operational** to **Safe-Operational**
- SP:** Transition from **Safe-Operational** to **Pre-Operational**
- PI:** Transition from **Pre-Operational** to **Init**

In practice the parameters (IDNs) are transferred from the higher-level control system to the AX5000 during transitions IP, PS and SO.

The TwinCAT System Manager indicates at which transition the individual AX5000 parameters can be transferred.

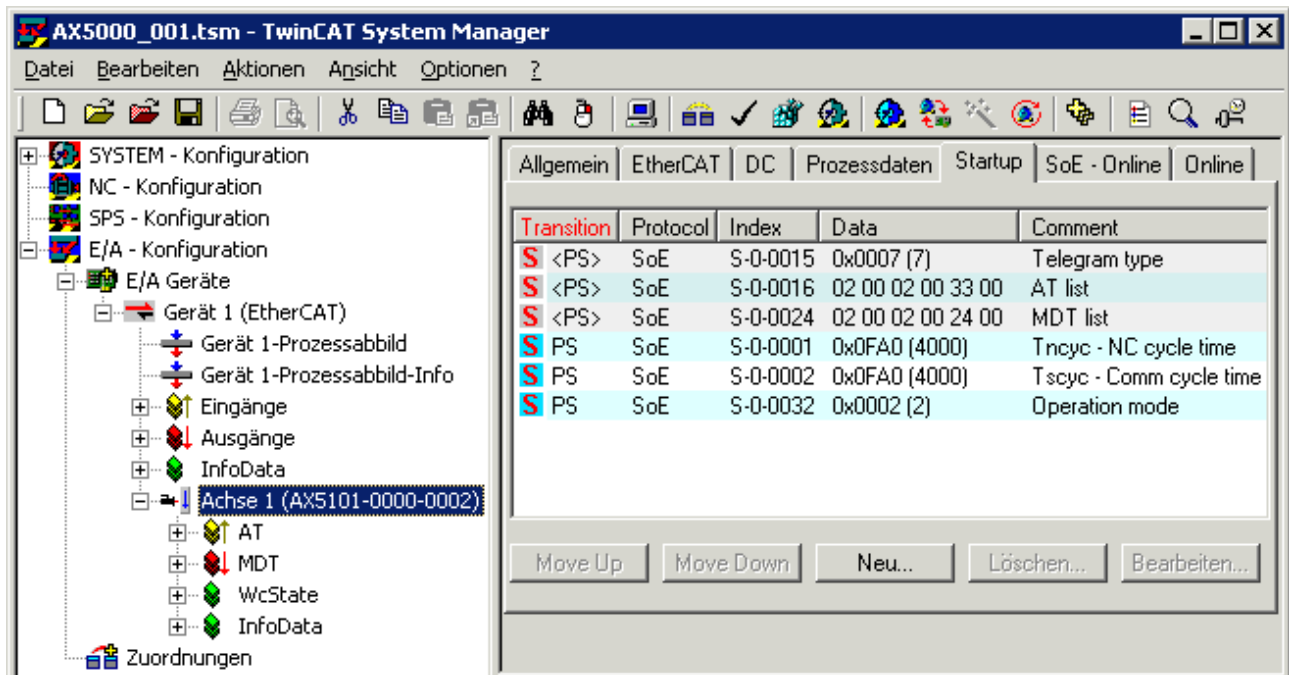

9.2.2 EtherCAT synchronization

The EtherCAT master sends EtherCAT telegrams to all connected EtherCAT slaves. In each slave an EtherCAT slave controller (ESC) is implemented. In order to achieve high positioning precision and meet stringent demands in terms of concentricity characteristics, it is necessary for the set value generation in the master and all connected drives to be synchronized. In the EtherCAT system the so-called distributed clocks are available for this synchronization task. For details see www.ethercat.org. The following description deals exclusively with the synchronization of the data.

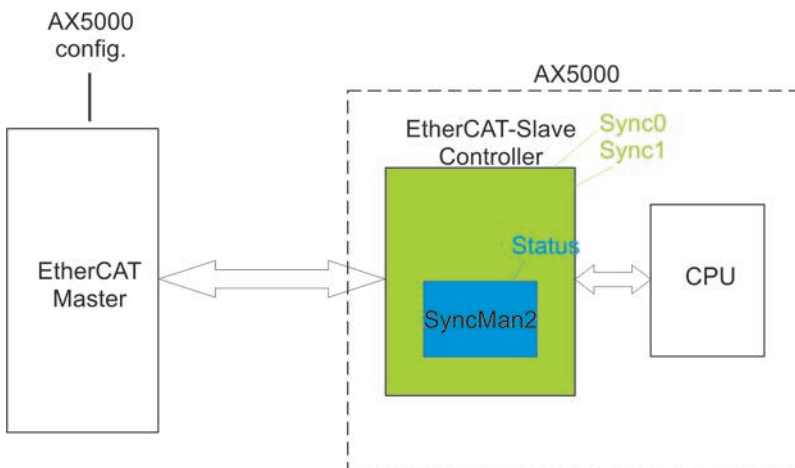

EtherCAT Master

From the TwinCAT project and the ESI files (EtherCAT slave information) of the connected slaves, the System Manager determines the required parameterization for the distributed clocks of the connected EtherCAT slaves when the configuration is generated. This parameterization is transferred to the slaves or their slave controllers via Init commands whenever the EtherCAT segment starts up. Manual adjustment is not required and should only be carried out in consultation with AX5000 support.

EtherCAT slave controller (ESC)

The EtherCAT slave controller (ESC) of the AX5000 is parameterized by the master such that two synchronization signals (Sync0 and Sync1) are generated. These signals are analyzed by the CPU and then synchronized with the internal control algorithms.

Sync0

The "Sync0" signals are sent every 250 μ s as standard. If a signal fails to materialize, the CPU generates the error code **F414**, and the axes of the servo drive are stopped with the "EStop ramp".

Additional error messages:

The Sync0 cycle time may only be configured with 62.5 μ s, 125 μ s or 250 μ s, otherwise the CPU generates the error code **F409**.

If the signal "Sync0" is not activated in the ESC, the CPU generates the error code **F410**.

If the pulse length of the signal no longer conforms to the standard, the CPU generates the error code **F411**.

In the case of each error message the axes are brought to a standstill with the "EStop ramp".

Sync1

The "Sync1" signals are parameterized according to the NC cycle time as standard. This cycle time is always a multiple of Sync0. If a signal fails to materialize (see F1), the CPU also generates the error code **F414**, and the connected axes are stopped with the "EStop ramp".

Additional error messages:

The Sync1 cycle time must be a multiple of the Sync0 cycle time and must be identical to the parameters "S-0-0001 and S-0-0002", otherwise the CPU generates the error code **F412**.

If the signal "Sync1" is not activated in the ESC, the CPU generates the error code **F413**.

If the pulse length of the interrupt no longer conforms to the standard, the CPU generates the error code **F411**.

In the case of each error message the connected axes are brought to a standstill with the "EStop ramp".

End of telegram (EOT)

The EtherCAT state controller (ESC) in the slave processes the EtherCAT telegrams dynamically. At the end of the telegram (EOT) it transfers the content to the addressed Sync Manager (if the telegram was intended for this slave and no CRC error is present). The EOT thus lags slightly behind the signal of Sync1 by the time DT2; the status of SyncManager2 is subsequently set to "SyncManager written". The CPU only copies the data from SyncManager2 into its own memory area if this status is "SyncManager written" at the time of Sync1. At the time of the Sync1 signal, the CPU expects a written SyncManager2. The end of the telegram must therefore occur just before the Sync1 signal is generated. The data are not copied if the status is not "SyncMan written"; if the data cannot be copied twice in succession, the CPU generates the error code **F415** and the connected axes are brought to a standstill with the "EStop ramp".

Jitter!

The tolerance for the existence of new data at the right time, due to "jitter" etc., is NULL. The EtherCAT master must ensure that the data arrive at the SyncMan2 in time.

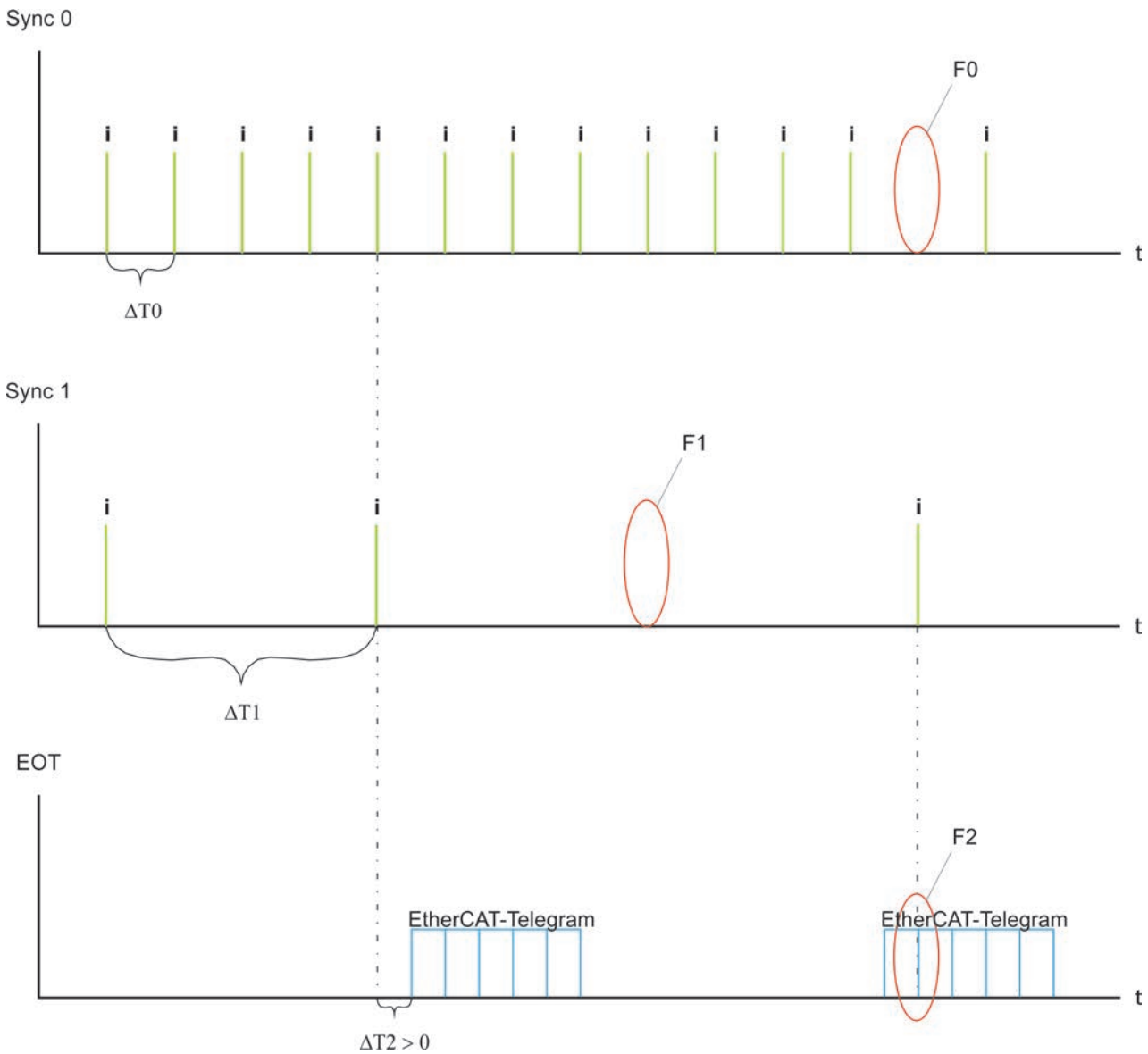

Special notes concerning the diagnostic message F415 "Distributed Clocks: process data synchronization"

The real-time behavior of the machine is continuously monitored during operation. An important component of this monitoring is the synchronization of all hardware and software components involved in data transfer. The illustrations below represent a simplified example of this data transfer. The focus is on the drive tasks "NC" and "PLC".

Sample 1

1. The CPU timer sends interrupts on a regular basis (default: base time = 1 ms)
2. The individual tasks are now processed in accordance with the rules of task management.
3. Task management:
 Since the task takes up a greater or smaller amount of time due to a higher or lower number of computing processes, the "I/O update" should be parameterized directly after the entry point (a) at the start of the task. This excludes one source of incorrect synchronization.
 A further source of error is an unfavorable prioritization of the individual tasks (see below).
4. Following the "I/O update", the resulting data are transferred to the TwinCAT-IO system and subsequently dispatched by EtherCAT telegram to the connected devices. The EtherCAT telegram passes through each physically connected device and hands over or picks up only the data for this device.

- The order of task calculation depends among other things on the prioritization of the tasks. If a task has a higher priority, it is also calculated first and can send its data to the TwinCAT-IO system, which then dispatches the telegram. Problems usually occur when individual tasks have different cycle times; see below.

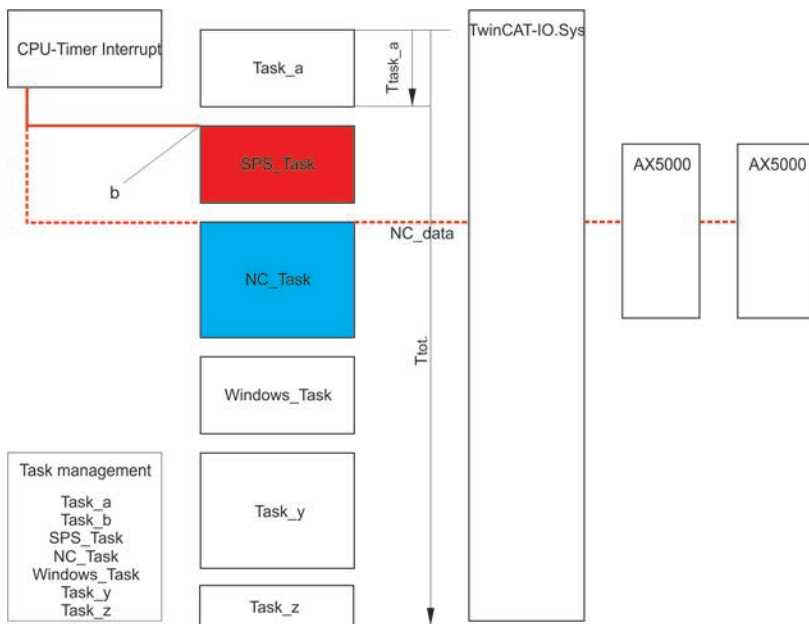

Prioritization

The following graph describes the effects of prioritization on the synchronization of the data.

Assumptions:

- Sync1 = 3 ms
- NC cycle time = 3 ms
- NC priority = 10
- PLC cycle time = 2 ms
- PLC priority = 5
- NC data are to be transmitted cyclically to the drive. Although the PLC requires time to compute, no data are transmitted to the drive.

Due to its higher priority, the PLC task is always calculated before the NC task; these tasks affect each other at the start point time "0 ms" and then repetitively every "6 ms", i.e. 2x Sync1. However, the ESC expects the EtherCAT telegram with the NC data at each Sync1 (3 ms). That is not ensured, however, because the more highly prioritized PLC task is always calculated before the NC task and thus in the case of synchronous mapping the telegram start is delayed. For this reason the NC telegram arrives somewhat later every 6 ms and can thus cause the **F415** error in the AX5000.

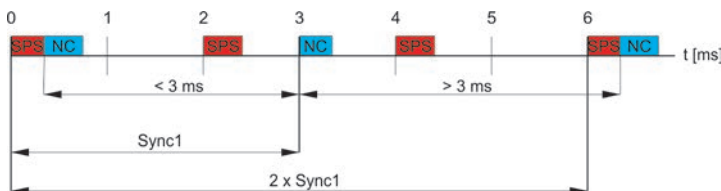

Sample 2

1. The CPU timer sends interrupts on a regular basis (default: base time = 1 ms)
2. The individual tasks are now processed in accordance with the rules of task management.
3. Task management:
 Since the task takes up a greater or smaller amount of time due to a higher or lower number of computing processes, the "I/O update" should be parameterized directly after the entry point (a) at the start of the task. This excludes one source of incorrect synchronization.
 A further source of error is an unfavorable prioritization of the individual tasks (see below).
4. Following the "I/O update", the resulting data are transferred to the TwinCAT-IO system and subsequently dispatched by EtherCAT telegram to the connected devices. The EtherCAT telegram passes through each physically connected device and hands over or picks up only the data for this device.
5. The order of task calculation depends among other things on the prioritization of the tasks. If a task has a higher priority, it is also calculated first and can send its data to the TwinCAT-IO system, which then dispatches the telegram. Problems usually occur when individual tasks have different cycle times; see below.

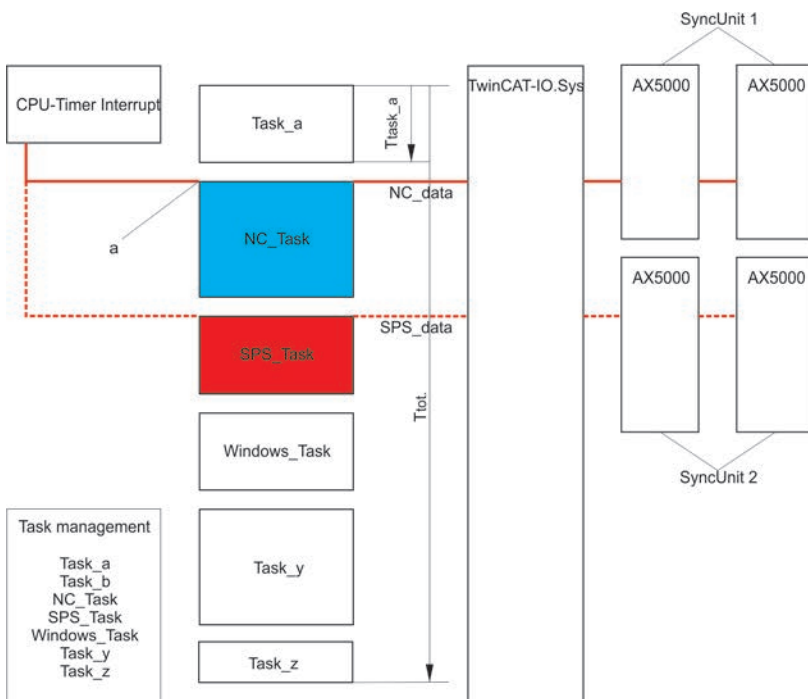

Prioritization

The following graph describes the effects of prioritization on the synchronization of the data.

Assumptions:

Sync1 = 3 ms
 NC cycle time = 2 ms
 NC priority = 5
 PLC cycle time = 3 ms
 PLC priority = 25
 NC task serves only devices in SyncUnit 1, synchronous mapping
 PLC task serves only devices in SyncUnit 2, synchronous mapping
 NC and PLC data are to be transferred cyclically.

Due to its higher priority, the NC task is always calculated before the PLC task and the telegram is accordingly also sent first; these tasks affect each other at the start point time "0 ms" and then repetitively every "6 ms", i.e. $2 \times \text{Sync1}$. However, the ESC expects an EtherCAT telegram at each Sync1 (3 ms). This is not a problem in SyncUnit 1, which is served by the NC, since the more highly prioritized NC always sends the telegram in the same time pattern. However, the PLC telegram arrives somewhat later every 6 ms and can thus cause the **F415** error in the AX5000 in SyncUnit 2.

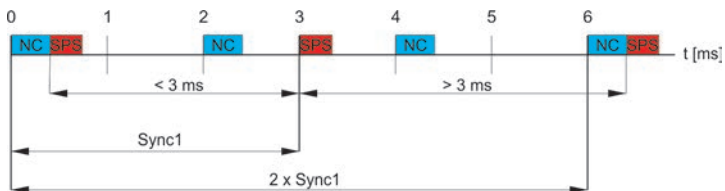

9.3 Operation modes

In drive technology a distinction is made between the following operation modes:

- Current / torque control
- Speed control
- Position control

In the SoE standard the individual operation modes are specified via the standard parameter S-0-0032 (main operation mode).

9.3.1 Mode parameterisation according to SoE

Parametrization of the IDN S-0-0032

Bit	Operation mode
0	no mode of operation
1	torque control
2	velocity control
3	position control feedback 1
4	position control feedback 2
11 and 12	position ctrl feedback 1 + 2 lag less
32769	torque control using dynamic MDT
32770	velocity control using dynamic MDT
32771 and 32772	position control feedback 1 + 2 using dynamic MDT
32779 and 32780	position control feedback 1 + 2 lag less using dynamic MDT

Cascaded control structure

The diagram shows a typical control structure with higher-level position controller and subordinate speed and current controller.

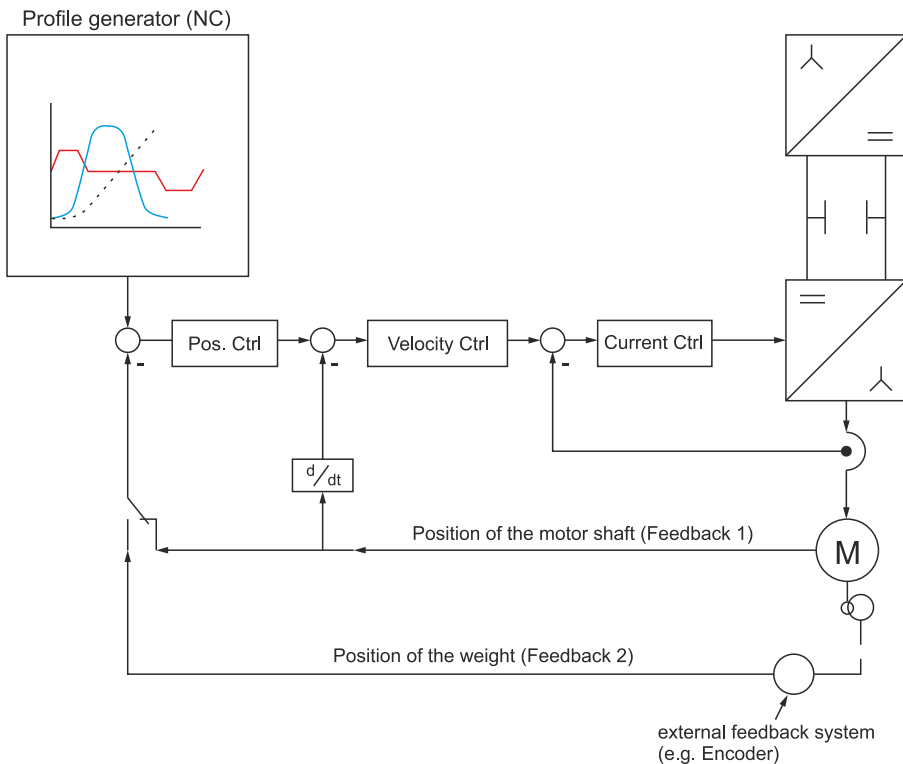

A cascaded controller structure consisting of current, speed and position controllers has proven to be necessary for achieving high dynamics and positioning accuracy. The diagram illustrates the time constants of the individual control loops, rising from inside to outside. Two operating modes are suitable for positioning: velocity set value specification or position set value specification.

For the position of operation, 2 modes are:

- speed setpoint (speed interface):
Cyclic speed setpoints are sent from the controller to the drive. Of the Position controller is in this case on the side of the controller (NC) implemented.
- Position setpoint. (Position interface):
Cyclic setpoint positions are sent from the controller to the drive. The position controller is here implemented in the drive. In the control (NC) only the setpoint profile is calculated. Here is a higher bandwidth in the position control achieved (no EtherCAT dead in closed Loop). This mode should always be used when the controller enables.

Profile generator

The profile generator generates curve profile of a positioning job of the PLC function block MC_MoveAbsolute. In each NC cycle, at a specified time (node T1 - Tn), the Setpoints this positioning task passed to the axis control. Thus, the servo amplifier optimally can proceed, the target values of the profile generator with the SAF task of the EtherCAT fieldbus must be triggered. The SAF task ensures that the support points (T1 - Tn) to the servo amplifier be transported.

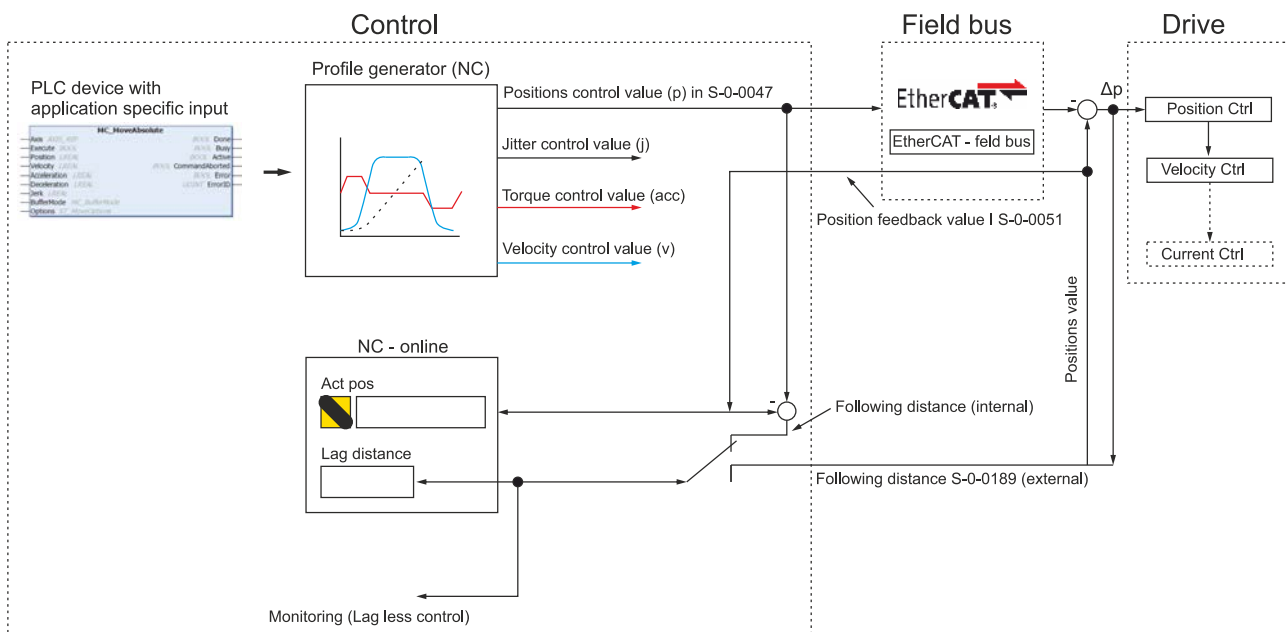

MC_MoveAbsolute is primarily used for linear axis systems. This PLC function block, let to axes with a speed v process of starting to target positions.



For further informations, please look at the following link:

PLC (Libs (TwinCAT 3 PLC lib: Tc2_MC2 (Motion-Function block (Point to Point Motion

9.4 Display and navigation rocker

9.4.1 Navigation rocker

	<p>The navigation rocker is used for navigating within the display. It has 5 contact points: “right”, “left”, “top”, “bottom” and “centre”</p>
---	--

9.4.2 Display

General

Starting from the standard display, you can access the configuration and command displays by pressing the

right side of the navigation rocker . Except with the standard display, if you do not change the display for approx. 25 seconds, the standard display is automatically shown again. The standard display is always shown if the device is working perfectly.

ECatSt=Op UdcLnk+00306V		M:CycValuesLine1 ECatSt:		M:CycValuesLine2 UdcLnk: V		M:Reset Activate Ch A		M:Set Device ID ID ---X 00000		M:Save Device ID Device ID 00000
----------------------------	---	-----------------------------	---	-------------------------------	---	--------------------------	--	----------------------------------	---	-------------------------------------

Display	Description												
Line 1 Line 2	The display consists of 2 lines. These two lines display independent, configurable contents. The contents can be arranged into 4 groups.												
<table border="1"> <tr> <td>ECatSt=Op UdcLnk+00306V</td> <td>1</td> </tr> </table>	ECatSt=Op UdcLnk+00306V	1	<p>Cyclic values (standard display): The so-called standard display is shown permanently. The values provided can be displayed in the two lines. The two lines are preconfigured in the factory as follows: Line 1: EtherCAT status Line 2: DC link voltage</p>										
ECatSt=Op UdcLnk+00306V	1												
<table border="1"> <tr> <td>A Id: 0xF415(F)</td> <td rowspan="2">2</td> </tr> <tr> <td>B Id: 0xF415(F)</td> </tr> <tr> <td>A IO Sync lost(F)</td> <td rowspan="2">3</td> </tr> <tr> <td>B IO Sync lost(F)</td> </tr> <tr> <td>A Id: 0xF415(F)</td> <td rowspan="2">4</td> </tr> <tr> <td>B Id: 0xF415(F)</td> </tr> <tr> <td>A IO Sync lost(F)</td> <td rowspan="2">5</td> </tr> <tr> <td>B IO Sync lost(F)</td> </tr> </table>	A Id: 0xF415(F)	2	B Id: 0xF415(F)	A IO Sync lost(F)	3	B IO Sync lost(F)	A Id: 0xF415(F)	4	B Id: 0xF415(F)	A IO Sync lost(F)	5	B IO Sync lost(F)	<p>Error messages: If an error occurs, the diagnostic code (hex) and a short version of the message (2+3) are shown alternately on the display. If the error concerns only channel "A", then this display is shown only in the upper line; the standard text remains in the lower line. If the error concerns only channel "B", then this display is shown only in the lower line; the standard text remains in the upper line. In both cases the display additionally flashes (2-5). If the error has been rectified and acknowledged with the reset command (S-0-0099), the standard display with the cyclic values appears again (see above).</p>
A Id: 0xF415(F)	2												
B Id: 0xF415(F)													
A IO Sync lost(F)	3												
B IO Sync lost(F)													
A Id: 0xF415(F)	4												
B Id: 0xF415(F)													
A IO Sync lost(F)	5												
B IO Sync lost(F)													
see error messages	Warnings: If a warning occurs, the display behaves in the same way as with an error message.												
see error messages	Information messages: If an information message occurs, the display behaves in the same way as with an error message, but does not flash.												



Cyclic values

The two lines with the cyclic values, which are shown on the standard display, are freely configurable. You can choose from 51 different cyclic values. The values are saved in IDNs and retrieved from there. The procedure for configuring line 1 and line 2 is identical:

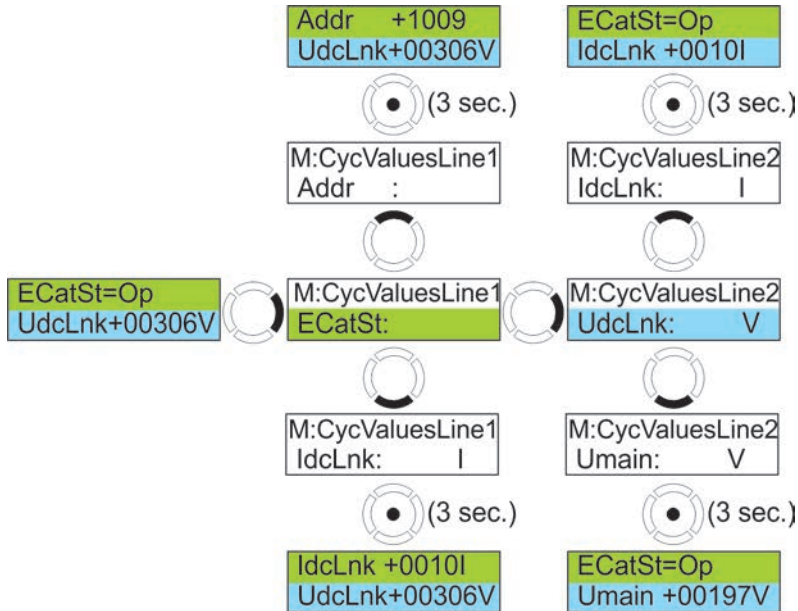
Overview (example)



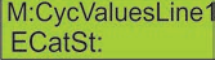

Changing the display

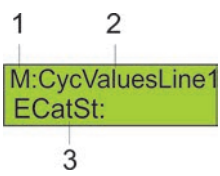
Starting from the standard display, press the right-hand side of the rocker  1x (for line 1) or 2x (for line 2); the display  or  appears.

Display	Description
	1 = "M" indicates that the "menu mode" is activated. 2 = The "CycValuesLine1" menu is active. This means that the cyclic values are displayed in line 1. 3 = Indicates which cyclic values are currently displayed.

The currently displayed value determines the point of entry into the list of the cyclic values. You can change

to the next cyclic value with the bottom  or the top  side of the rocker, as shown below. If the

desired value has been reached, press the center  of the rocker for 3 seconds. The value is adopted and the changed standard display is shown.

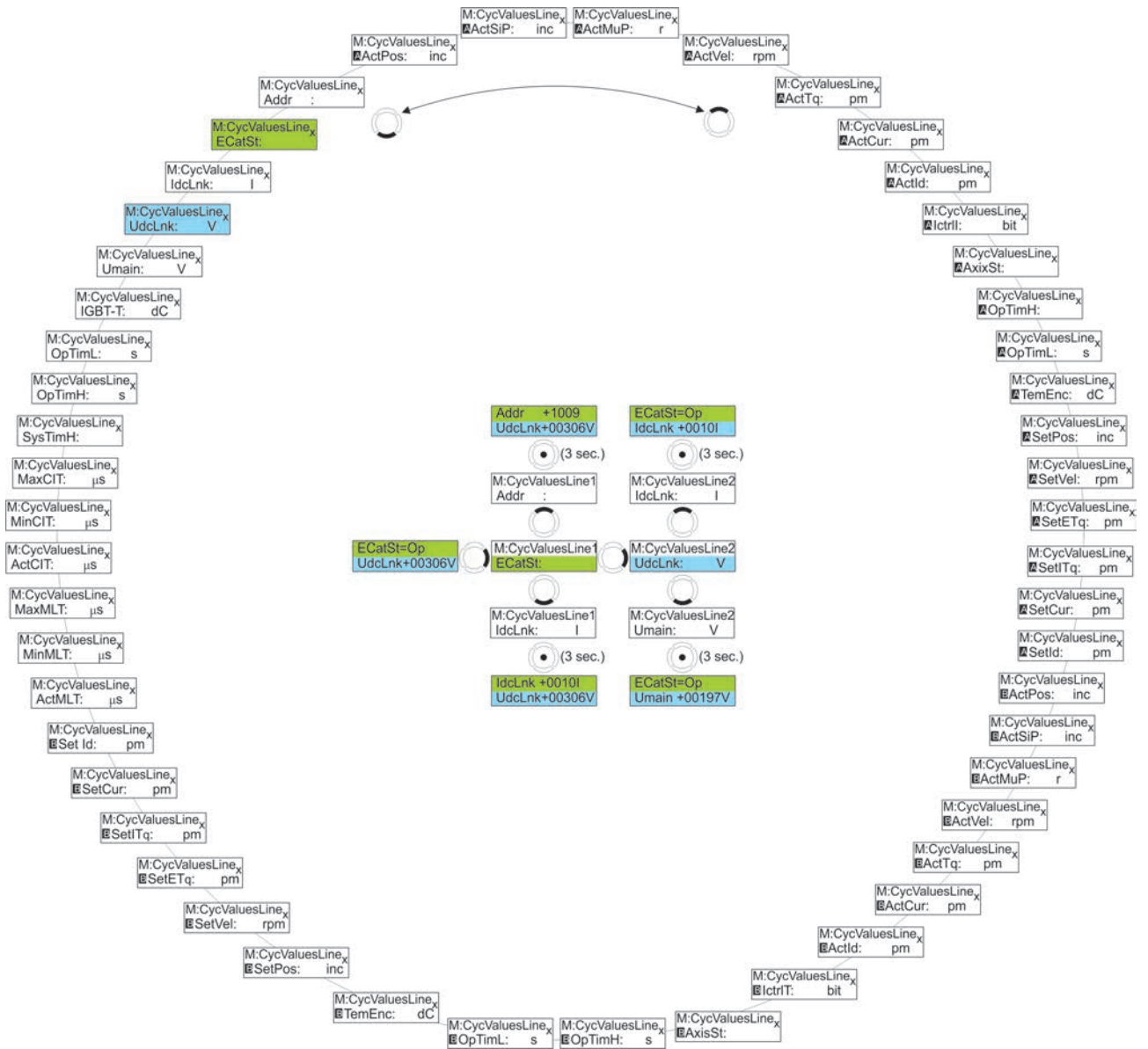

Error reset (command S-0-0099)

After rectifying an error, it is necessary to perform an error reset. The associated command is the IDN S-0-0099. This command can also be given directly via the display. As soon as an error occurs the display flashes continuously; the standard display is shown again and the flashing stops only after a successful error reset.

Overview

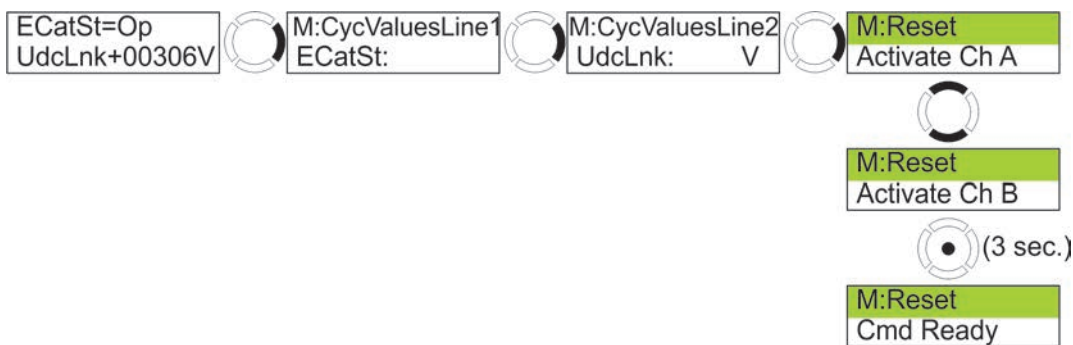



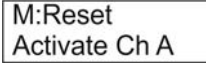

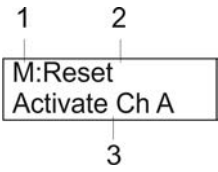
Executing the command

Press the right side of the rocker  3x until the following display appears: 

Display	Description
	1 = "M" indicates that the "menu mode" is activated. 2 = The "Reset" menu is active. 3 = Indicates which channel of the AX5000 the reset affects.

There are now 2 possibilities:

Press the center of the rocker  for approx. 3 sec. to execute the reset command for channel "A"
or

Press the upper or lower side of the rocker  and switch to channel "B". Now press the center of the rocker  for approx. 3 seconds and execute the Reset command for channel "B". The following display appears .

The standard display should appear again after approximately 25 seconds. If the error display is still visible after that, this means that you have not rectified the cause of the error, or that there are further errors.

Device ID

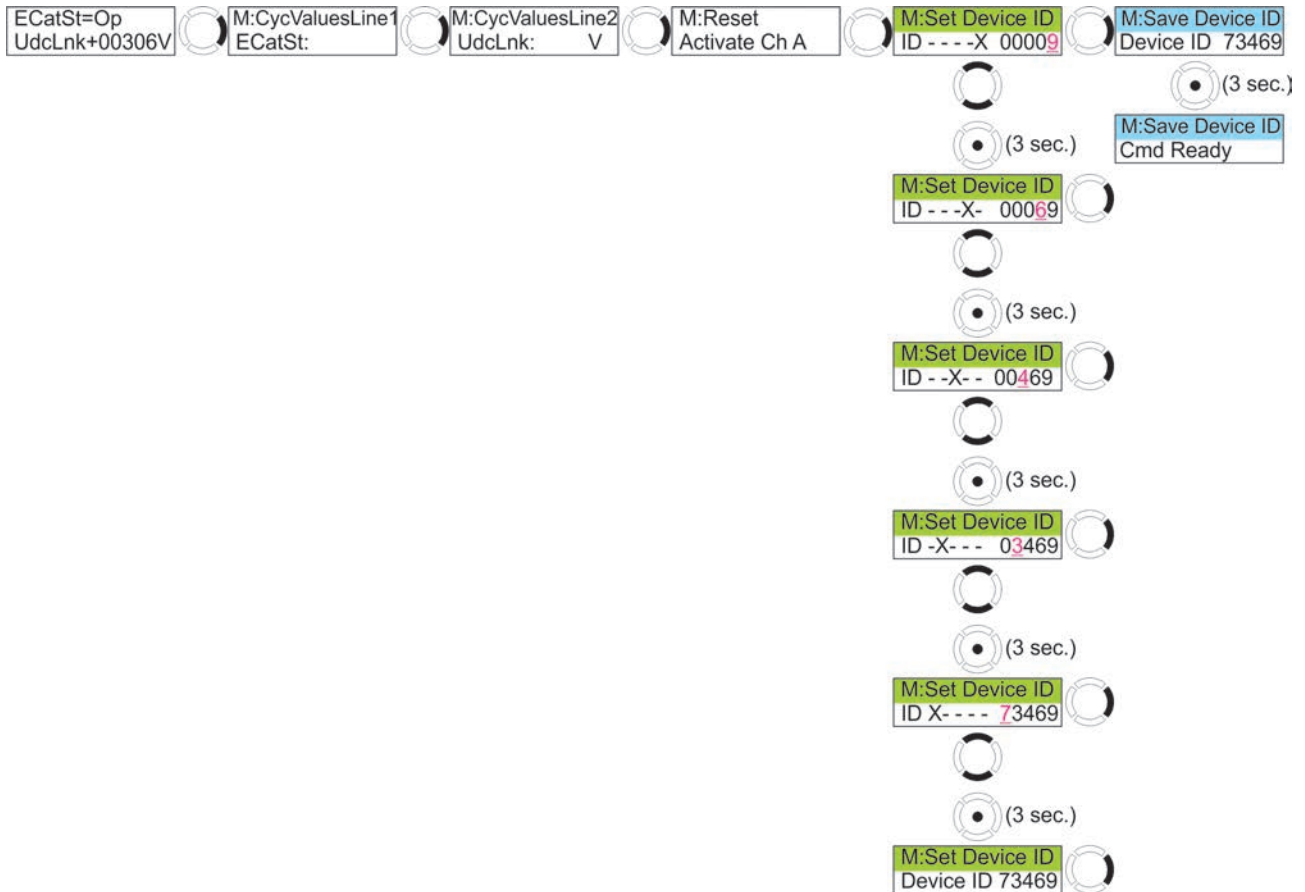

The Device ID is a configurable ID of the AX5000 in the system environment. It is saved in the IDN P-0-0020.

Overview (example)





Entering the Device ID

You can edit the 5-digit Device ID by entering the individual digits. The prerequisite for this is that the "Set Device ID" menu is active. As mentioned above, the display of the AX5000 displays freely configurable cyclic data in the upper and lower lines as standard.

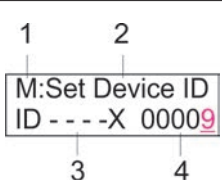
Press the right side of the rocker  4x until the following display appears: 

Display	Description
	1 = "M" indicates that the "menu mode" is activated. 2 = The "Set Device ID" menu is active. 3 = Indicates which digit "X" of the Device ID is currently editable; in this example it is the last digit, i.e. "nine". 4 = Device ID

You can now immediately edit the last digit of the Device ID by pressing the top or bottom side of the rocker

 . The top side  increments the number, the bottom side  decrements it. After you have set the digit, there are 2 possibilities:

Press the center of the rocker  for approx. 3 sec. and you can then edit the digit to the left of the current digit.

or

Press the right side of the rocker ; this takes you to the "Save Device ID" menu.

i Temporary memory

After you have finished editing, the changed Device ID is located in a temporary memory, which is cleared when the AX5000 is switched off. You must execute the command "Save Device ID", so that the Device ID is saved permanently in the AX5000.

Saving the Device ID

By means of saving the Device ID, the IDN P-0-0020 is written to the AX5000 and can be used further.

If you have just changed the Device ID, press the right side of the rocker  and the following display

appears: 

If the standard display is visible, press the right side of the rocker  5x until the following display

appears: 

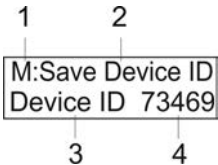
Display	Description
	1 = "M" indicates that the "menu mode" is activated. 2 = The "Save Device ID" menu is active. 3 + 4 = Indicates which Device ID will be saved.

Press the center of the rocker  for approx. 3 sec. in order to save the displayed Device ID.

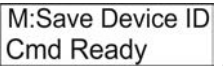
If saving was successful, this display appears: 

The standard display appears again after approximately 25 seconds.

9.5 Motor brake management

9.5.1 IDNs involved

IDN	Name
S-0-0206	Drive on delay time
S-0-0207	Drive off delay time
P-0-0058	Motor brake type
P-0-0096	Motor control word
P-0-0097	Motor status word

9.5.2 Functioning

IDN S-0-0206 determines the time of the motor standstill after the motor current feed, so that the brake can vent first.

IDN-S-0-0207 defines the switch-off delay between activation of the motor brake and deactivation of the current feed.

IDN-P-0-0058 is used to configure the motor brake.

IDN-P-0097 displays the state of the motor brake.

IDN-P-0096 can be used to release the motor brake manually or requesting activation of the brake manually. This bits overwrite the internal brake request. The brake is therefore released or engaged irrespective of the motor current feed and any travel command.

WARNING

Risk of injury!

Improper operation of IDN P-0-0096 can therefore lead to sagging of a non-energized Z axis or closing of the motor brake at full speed!

9.6 Commutation methods

The important characteristics of a servomotor, such as its very smooth running, high efficiency and optimum thermal utilization, are strongly influenced by the commutation. Commutation refers to the transfer of current from one winding to the next. The moment at which commutation takes place must be harmonized with the magnetic field of the rotor if the servomotor is to operate most effectively.

9.6.1 Rotary servomotors

9.6.1.1 Mechanical commutation

These motors, which use brushes, generate the alternating fields necessary for operation of the motor through sliding contacts, whose geometrical arrangement switches the current paths. Brush losses and wear are disadvantages of this simple, mechanical commutation method.

9.6.1.2 Electronic commutation

These modern motors generate the alternating field needed for operation of the motor by means of an electronic circuit which is not subject to either wear or friction. The type of motor and the encoder system in use determine the commutation method.

Absolute encoder system (motor feedback) within one rotation

Samples of this type of encoder system includes: Resolver, EnDat, BiSS and HIPERFACE

Two different commutation methods are involved here:

Mechanical adjustment of the encoder

The motor's encoder system is mechanically adjusted at the factory (the encoder and rotor are matched to one another), but the rotor position is unknown.

The commutation angle is determined once by the P160 command, using the IDN "P0-0-165_Command mode_Static current vector" and the IDN "P-0-057 "Electrical commutation offset". This means that the corresponding mechanical angle coming from the encoder system is displayed and read out in P-0-0058, and is saved in the IDN "P-0-0150_Parameter chanel_Adjustable commutation offset" (motor database). In order for the parameter to be used, the IDN "P-0-0150_Parameter chanel_Commutation mode" (motor database) must be set to 3: "Adjustable offset". The associated value of the IDN "P-0-057 "Electrical commutation offset" is also saved in the motor database.

Electronic adjustment of the encoder system

● Synchronous motors!



Electronic adjustment is only required for synchronous motors. In the case of a synchronous motor, the magnetic field of the rotor is generated electronically, and therefore can be set appropriately for the electromagnetic field of the winding.

Depending on the encoder system there are, again, two different commutation methods:

1. The encoder is always attached to the rotor by the manufacturer in the same rotary position, but the rotor position is not known.
The commutation angle is determined once by the P160 command, using the IDN "P0-0-165_Command mode_Static current vector" and the IDN "P-0-057 "Electrical commutation offset". This means that the corresponding mechanical angle coming from the encoder system is displayed and read out in P-0-0058, and is saved in the encoder system's data store (exceptionally) and in the IDN "P-0-0150_Parameter chanel_Adjustable commutation offset" (motor database). In order for the parameter to be used, the IDN "P-0-0150_Parameter chanel_Commutation mode" (motor database) must be set to 3: "Adjustable offset". The associated value of the IDN "P-0-057 "Electrical commutation offset" is also saved in the motor database. This method requires a encoder system having a data store and a data line.
2. The angle between the encoder system and the rotor is determined by the motor manufacturer using a command that is specific to the encoder, and is communicated to the encoder system. The encoder system stores this angle, using it for internal calculation, but the rotor position is unknown.
The commutation angle is determined once by the P160 command, using the IDN "P0-0-165_Command mode_Static current vector" and the IDN "P-0-057 "Electrical commutation offset". This means that the corresponding mechanical angle coming from the encoder system is displayed and read out in P-0-0058, and is saved in the encoder system's data store (exceptionally) and in the IDN "P-0-0150_Parameter chanel_Adjustable commutation offset" (motor database). In order for the parameter to be used, the IDN "P-0-0150_Parameter chanel_Commutation mode" (motor database) must be set to 3: "Adjustable offset". This angle is always included in internal calculation processes. This method requires an intelligent encoder system.

Non-absolute encoder system (feedback) within one rotation

Samples of this type of encoder system includes: SIN / COS 1Vss

In this case, a special commutation procedure (wake&shake) must be run in order to determine the commutation angle. This angle is stored internally, and is taken into account during operation. If the AX5000 is switched off, or if the "EtherCAT-State machine" is switched into "Pre-op" or a lower state, the commutation angle will be lost because the encoder system is not absolute. "Wake&shake" can only operate without error when the drive system is running steadily; in other words there must not be any vibrations affecting the motor from outside. In addition, a stability investigation using the default values of the "IDN P-0-0165" is necessary the first time the system is operated.

i Oscillatory system!

It is important for this stability investigation to examine the application in advance and to determine the oscillation that is potentially most problematic. This case can occur under load conditions, or may be found when unloaded.

⚠ WARNING

Warning, risk of injury from uncontrolled movements!

In the method described below, the motor shaft is brought directly to a certain position. Make sure that your application permits this movement, secure the surroundings to prevent unintentional entry, and make sure that nobody is in the hazardous area.

Oscillatory system

It is necessary to analyze the vibration pattern of an oscillating system, and to take appropriate damping measures. Oscillations always have their effect in Phase 2 of "wake&shake"; oscillations are not particularly critical in Phase 1.

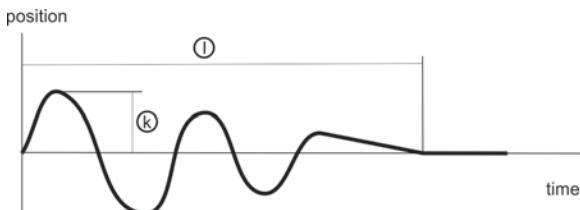

Decaying oscillation

The amplitude (k) and the decay time (l) of this kind of oscillation must be found. The parameters IDN-P-0-0165 "Commutation pos control: Kp" can affect both the amplitude (k) and the decay time (l). The parameter IDN-P-0-0165 " Second phase duration" should be greater than the decay time (l).

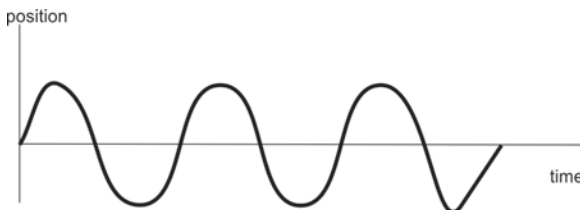

Constant oscillation

This kind of oscillation is unacceptable, as a stable regulation process is not established. The parameters IDN-P-0-0165 "Commutation pos control: Kp" must be checked, and modified if necessary. If this does not achieve the desired result, you must damp the vibration mechanically.

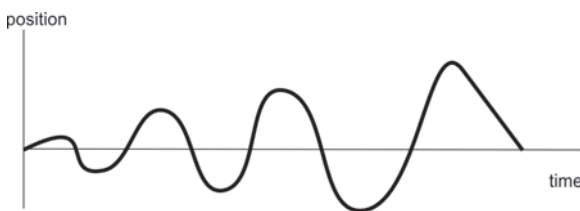

Rising oscillation

This kind of oscillation is unacceptable, as a stable regulation process is not established. The parameters IDN-P-0-0165 "Commutation pos control: Kp" must be checked, and modified if necessary. If this does not achieve the desired result, you must damp the vibration mechanically.

The motor shaft is brought to freely definable electrical positions by impressing an appropriate current in the course of this investigation. When this injected current is switched off, the motor should remain in the position that it has reached. BECKHOFF recommends positions of 0°, 90°, 180° and 270°. In critical applications, eight positions (0°, 45°, 90°, 135° ...315°) should be selected instead of four. The current injection is parameterized in the IDN P-0-0165 under "Static current vector", while the freely selectable electrical position is set in the IDN P-0-0057. "Wake&shake" should be carried out in each position; stability of the system is only ensured when this has been done successfully.

Wake&shake**● Oscillating system!**

i A mechanical remedy must be provided if the application oscillates. You can carry out the commutation up to a degree using wake&shake, but should carefully select the parameters for the IDN "P-0-0165" to make the effect of the oscillation as small as possible, since too much post-pulse oscillation will cause a commutation error. This is because the angle measured after completing the command will be entered as the commutation angle.

⚠ WARNING**Warning, risk of injury from uncontrolled movements!**

The motor shaft will be moved in steps during the process described below. In Phase 1 the maximum electrical movement is 8 x (the value from "P-0-0-0165_Fist phase position monitoring limit"). In Phase 2 it is 0.5 x (the value from "P-0-0-0165_Fist phase step width"). This formula can only be applied if the previous investigation of stability has been concluded satisfactorily. Make sure that your application permits this movement, secure the surroundings to prevent unintentional entry, and make sure that nobody is in the hazardous area.

The wake&shake commutation function consists of two phases. An approximate determination of the rotor position is carried out in Phase 1, while Phase 2 determines the position more precisely. The aim of the commutation function is to determine the precise position of the rotor with a minimum amount of movement.

Due to the pairs of poles, servomotors exhibit a direct relationship between the electrical and mechanical rotation. One electrical rotation always corresponds to one mechanical rotation divided by the number of pole pairs. A motor with a single pair of poles is illustrated in the following example for the sake of simplifying the calculation.

Parameterization is carried out using the IDN P-0-0165 "Commutation offset calibration parameter". The quoted angles always refer to electrical rotations!

IDN P-0-0165 - Commutation offset calibration parameter

Parameter	Default	Description
Command mode	0: Static current vector	Selection between two commutation methods
Activation	0: manual	Selection of when the commutation process is started
Static current vector		Commutation methods
Current level	Stationary current in %	Current intensity of the current vector (value = 100% x P0-0093 / P0-0092)
Duration	3000 ms	Period for which the parameterized current is maintained so that any oscillations that may be present can settle, allowing an optimum commutation angle to be reached
Wake and shake		Commutation methods
First phase current vector	Stationary current in %	Ⓐ Current intensity of the current vector (value = 100% x P0-0093 / P0-0092)
First phase ramp up time	100 ms	Ⓑ Time for the current vector "a" to reach its parameterized magnitude
Second phase current level	Stationary current in %	Ⓒ Current intensity of the current vector (value = 100% x P0-0093 / P0-0092)
Second phase ramp up time	500 ms	Time for the current vector "g" to reach its parameterized magnitude
Commutation pos control: Kp	0.04	Amplification factor. Attention: If "0" then Variant 2 will be carried out in Phase 2
Wake and shake expert		Attention: Only experienced users should change the following parameters!
First phase pos monitoring limit	0.5 degrees	Ⓓ Minimum angle of rotation of the rotor required to detect movement
First phase step width	22.5 degrees	Ⓔ Current vector offset or segment detection angle
First phase waiting time after step	150 ms	Ⓕ The time from detection of movement and the next step in Phase 1 or between Phase 1 and Phase 2 (any oscillations in the system have time to settle)
Second phase duration	3000 ms	Ⓖ Period for which the parameterized current is maintained so that any oscillations that may be present can settle, allowing an optimum commutation angle to be reached
Error monitoring (range of motion)	90 degrees	The maximum movement of the rotor before it is switched off, since there would otherwise be a risk that the motor would make an uncontrolled movement.
Ⓐ Ⓑ Ⓒ Ⓓ Ⓔ Ⓕ Ⓖ Ⓗ	= identifying characters for the description below	

Motor with 3 pole pairs

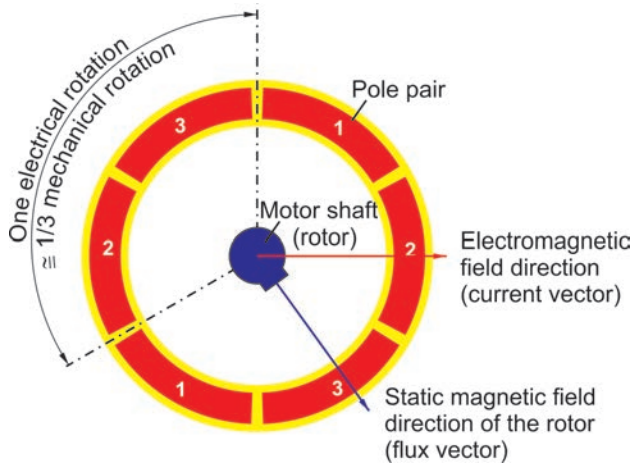

Motor with one pair of poles

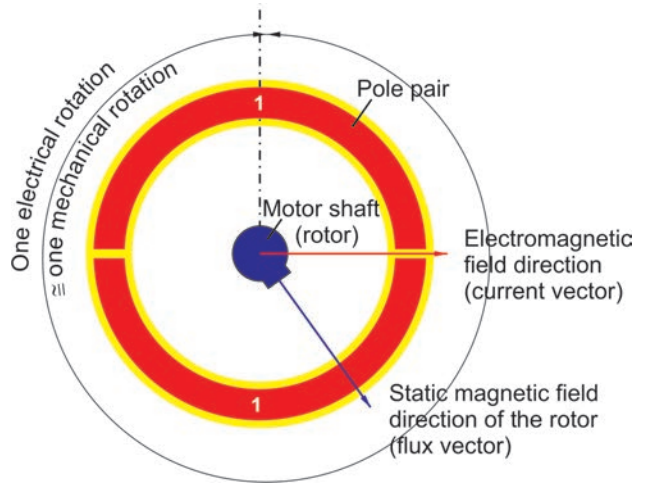

Phase 1 - approximate determination of the rotor position (motor shaft)

Step 1:

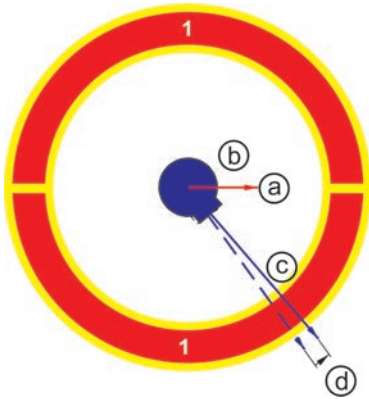

Ⓐ Ⓑ Ⓓ = see IDN P-0-0165 parameter description above

Ⓒ = flux vector of the rotor with permanent magnet.

Sequence:

A current vector "a" is developed during the time "b". Due to the rising magnetic force, the rotor "c" is turned in the direction of the current vector "a". The direction of rotation "d" is transmitted to the feedback system and the AX5000, where it is stored.

Step 2:

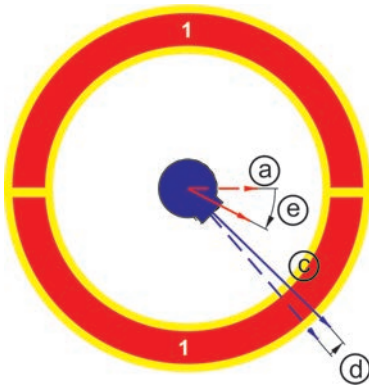

Ⓐ Ⓑ Ⓓ Ⓔ = see IDN P-0-0165 parameter description above

Ⓒ = flux vector of the rotor with permanent magnet.

Sequence:

A current vector "a" is developed during the time "b". Due to the rising magnetic force, the rotor "c" is turned in the direction of the current vector "a". The direction of rotation "d" is transmitted to the feedback system and the AX5000, where it is stored and analyzed. If the analysis shows that the direction of rotation "d" of the rotor "c" has not changed when compared with that of the previous impressed current, the process continues.

Step 3:

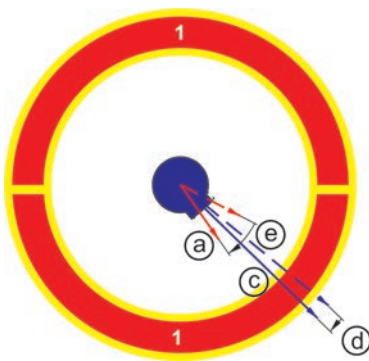

Ⓐ Ⓑ Ⓓ Ⓔ = see IDN P-0-0165 parameter description above

Ⓒ = flux vector of the rotor with permanent magnet.

Sequence:

The current vector "a" is again set to the magnitude "e" in the direction of the rotor "c". The current vector "a" is now again developed during the time "b". Due to the rising magnetic force, the rotor "c" is turned in the direction of the current vector "a". The direction of rotation "d" is transmitted to the feedback system and the AX5000, where it is stored and analyzed. In this case, the analysis shows that the direction of rotation "d" of the rotor "c" has changed when compared with that of the previous impressed current. As a result, the sector in which the rotor "c" is located has been found, and Phase 1 is therefore completed.

Example of an oscilloscope display of Phase 1:

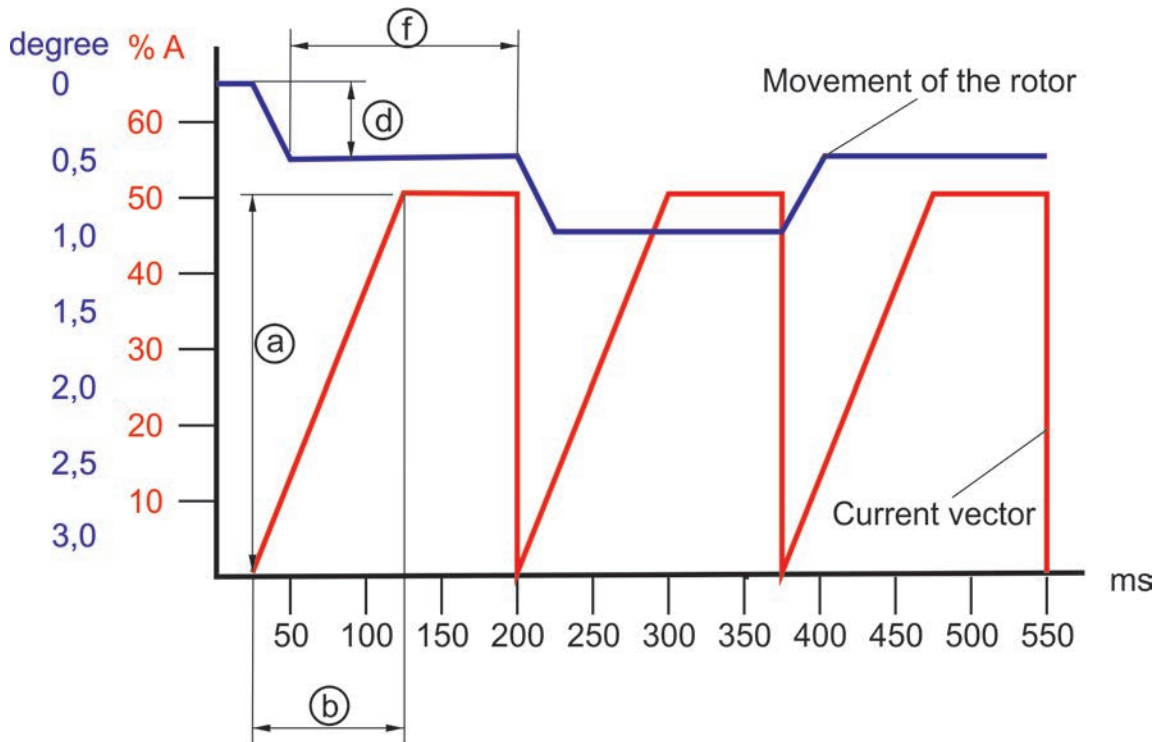

Phase 2 - precise determination of the rotor position (motor shaft)

There are two variants of the precise localization that may be used in Phase 2. In the first variant, the rotor only makes minimal movement, but this does require a very stable system with only a slight tendency to oscillate. In the second variant, the rotor can move by up to a maximum of half the sector \textcircled{e} , but this method is much more tolerant against oscillation.

The value set in the parameter IDN-P-0-0165 "Commutation pos control: Kp" controls which variant is used:

IDN-P-0-0165 "Commutation pos control: Kp" > 0 --> Variant 1

IDN-P-0-0165 "Commutation pos control: Kp" = 0 --> Variant 2

Variant 1 (IDN-P-0-0165 "Commutation pos control: Kp" > 0):

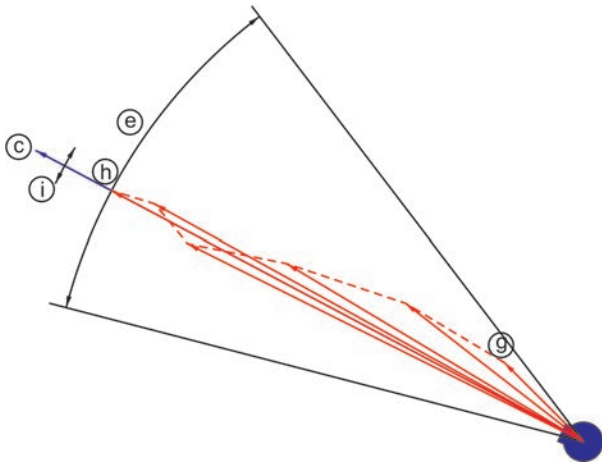

Ⓐ Ⓔ Ⓙ ⓓ = see IDN P-0-0165 parameter description above

Ⓒ = flux vector of the rotor with permanent magnet.

Ⓘ = movement of the rotor

Sequence:

The current vector "g" is developed starting from the final position of the current vector "a" in Phase 1. Due to the rising magnetic force, the rotor "c" is turned in the direction of the current vector "g". The movement is passed through the feedback system to the AX5000, and supplied to a control loop. This control loop immediately corrects the direction of the current vector. This algorithm is executed until the parameterized current intensity is achieved, and the current vector approximately coincides with the flux vector. The current is now maintained over the period "h" which ensures that optimum commutation takes place. In this control algorithm, the rotor only moves minimally through "i".

Variant 2 (IDN-P-0-0165 "Commutation pos control: Kp" = 0):

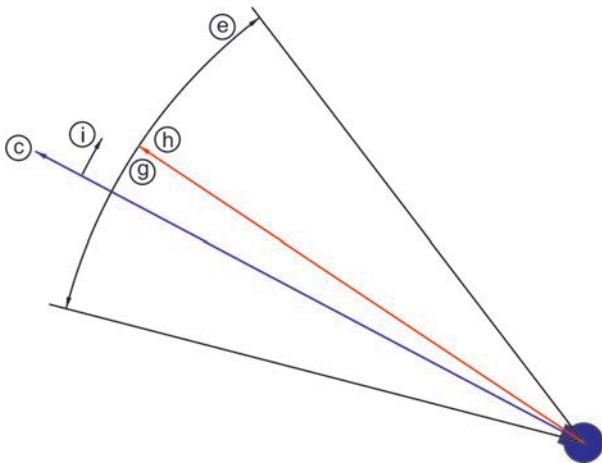

Ⓐ Ⓔ Ⓙ ⓓ = see IDN P-0-0165 parameter description above

Ⓒ = flux vector of the rotor with permanent magnet.

Ⓘ = movement of the rotor

Sequence:

After determining the sector "e" in Phase 1, the current vector "g" is placed exactly in the center of the sector "e", and this current is developed. Due to the rising magnetic force, the rotor "c" is turned in the direction of the current vector "g" until they coincide. In this static alignment, the rotor cannot move more than half the width of the sector "e".

Using IDN P-0-0165 to affect wake&shake

Parameter	Default	Possible causes that might require a change in the default value
First phase current level	Stationary current in %	Sluggish system, high attenuation --> increase value Smooth system, low attenuation --> reduce value
First phase ramp up time	100 ms	Sluggish system, high attenuation --> increase value Smooth system, low attenuation --> reduce value
First phase pos monitoring limit	0.5 degrees	Application only permits very limited uncontrolled changes in the movement --> reduce value The system has a small amount of attenuation --> reduce value The loading relationships require more overshoot --> increase value
First phase step width	22.5 degrees	
First phase waiting time after step	150 ms	Decay behavior of the system: Long settling time --> increase value Short settling time --> reduce value
Second phase current level	Stationary current in %	
Second phase ramp up time	500 ms	
Second phase duration	3000 ms	
Error monitoring (range of motion)	90 degrees	Application only permits very limited uncontrolled changes in the movement --> reduce value The system has a small amount of attenuation --> reduce value The loading relationships require more overshoot --> increase value
Commutation pos control: Kp	0.04	High load stiffness --> increase value Low load stiffness --> reduce value A special case "0": Variant 2 is carried out in Phase 2

9.6.2 Linear motors

The above description of the commutation process applies equally to rotary motors and to linear motors. Depending on the construction, there are merely some differences of nomenclature (e.g. motor shaft (rotor) = primary part; "degree" = "mm" (conversion is needed))

WARNING

Warning, risk of injury from uncontrolled movements!

The primary part is moved in steps during "wake&shake". In Phase 1 the maximum electrical movement is 8 x (the value from "P-0-0-0165_Fist phase position monitoring limit"). In Phase 2 it is 0.5 x (the value from "P-0-0-0165_Fist phase step width"). This formula can only be applied if the previous investigation of stability has been concluded satisfactorily. Make sure that your application permits this movement, secure the surroundings to prevent unintentional entry, and make sure that nobody is in the hazardous area.

Linear motors consist of a secondary assembly, whose position is fixed, onto which permanent magnets are attached with alternating polarity and regular spacing. A primary assembly can undergo translatory movement above this magnetic field. This movement is created by generating an electromagnetic field in the primary assembly. Linear motors always have only one pair of poles, and the distance between the poles therefore corresponds to one electrical rotation.

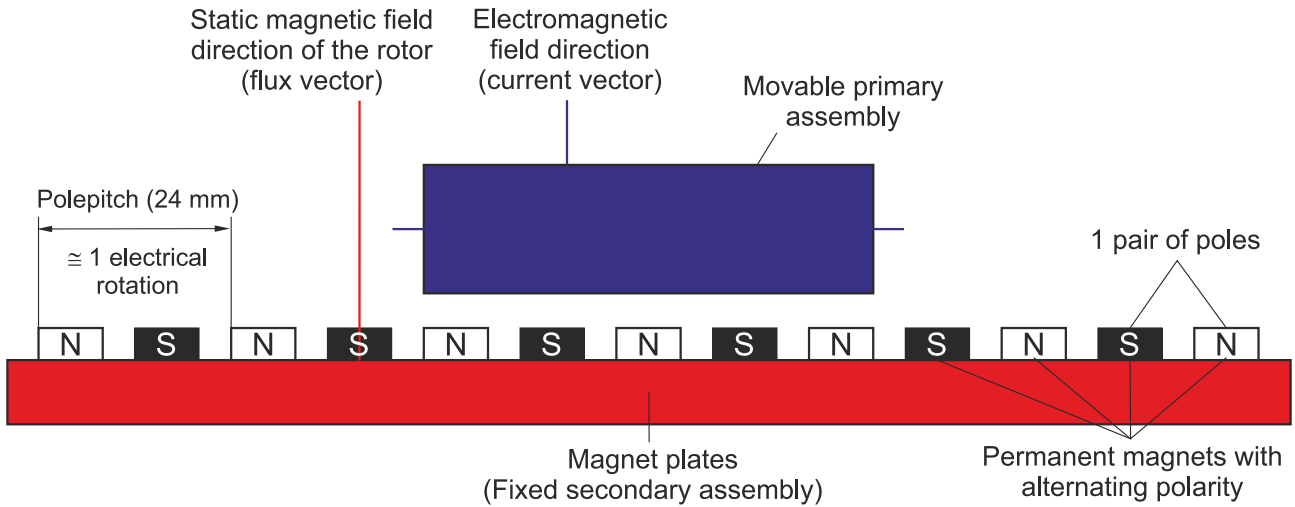

The "Electronic Commutation" section above can be applied to linear motors.

9.6.3 Commutation error "F2A0"

During operation of the motor the commutation is permanently monitored. The following conditions must apply in order for the AX5000 to detect a commutation error:

1. The current velocity must be higher than the limit speed set in the IDN "P-0-0069 Commutation monitoring"
2. The power and acceleration vectors must have different signs.
3. The current power is greater than 95% of the value in the IDN "P-0-0092 Configured channel peak current".

When these three conditions apply it is very likely that there is a commutation error and that the motor is undergoing uncontrolled acceleration; the AX5000 generates a commutation error and switches the motor torque-free i.e. it stops without control.

⚠ WARNING

Warning, risk of injury from uncontrolled movements!

A certain distance will have been travelled from the point when the error is detected until the motor stops. Make sure that your application permits this movement, secure the surroundings to prevent unintentional entry, and make sure that nobody is in the hazardous area. This applies in particular to vertical axes.

● Occurrence of commutation error

i A commutation error almost always occurs when the axis is commissioned. If this error occurs during regular operation of the axis then special measures need to be adopted. See next chapter.

9.6.4 Commutation error during regular operation (very rare)

Under special operating conditions the regular operation of the axes can fulfil the three conditions cited above and therefore trigger this error message despite correct commutation. A number of examples are given below which, however, occur very seldom:

1. When the servo drive is operating at the limit (conditions 1 and 3 are met) and external forces cause an opposing torque which then fulfils condition 2, the servo drive generates a commutation error.
2. The servo drive is operating at the limit (conditions 1 and 3 are met) and an oscillating current is produced due to a rapid change of direction or speed. Condition 2 is then also met and a commutation error arises.

If these examples do not apply to your application, analyze the application and try to find the cause. If you are unable to remedy the cause but still wish to operate the axis, there is only one option for suppressing the commutation error:

Parameterize the value of the IDN P-0-0069 to the permitted maximum speed of the motor so that point 1 of the above-mentioned factors cannot apply and the commutation error will no longer appear.

⚠ WARNING

Warning, risk of injury from uncontrolled movements!

Increasing the value of the IDN "P-0-0069" to the highest speed always means that the commutation monitoring will no longer cause errors, even when other conditions actually call for this. This is particularly critical when the motor is being replaced. If the value of the IDN "P-0-0069" is **NOT** reset, then uncontrolled movements of the motor may occur. Beckhoff recommends that you should **NOT** increase the value of the IDN "P-0-0069".



Drive design

As a rule the drive should not be designed at the limit i.e. the current power should reach a max. of 90% of the P-0-0092 "Configured channel peak current" value.

9.7 OCT

9.7.1 Precondition for operation

A prerequisite for operation of the OCT motor is a suitable AX5000 with a serial number > 105.000 and firmware V 2.04 or higher.

AX5000 with hardware version 2

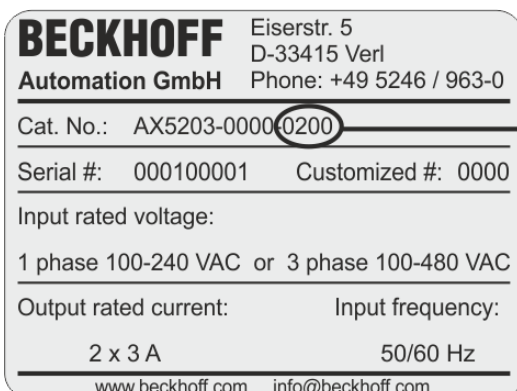

The AX5000 with hardware version 2 is marked with "0200" (1) in the catalogue number. The catalogue number can be found on the name plates.

AX5000 with hardware version 2 and set "Featureflag 0"

The feature flags (3) are documented in the IDN "P-0-0322" (2). The "Feature Flag 0" must have the value 1

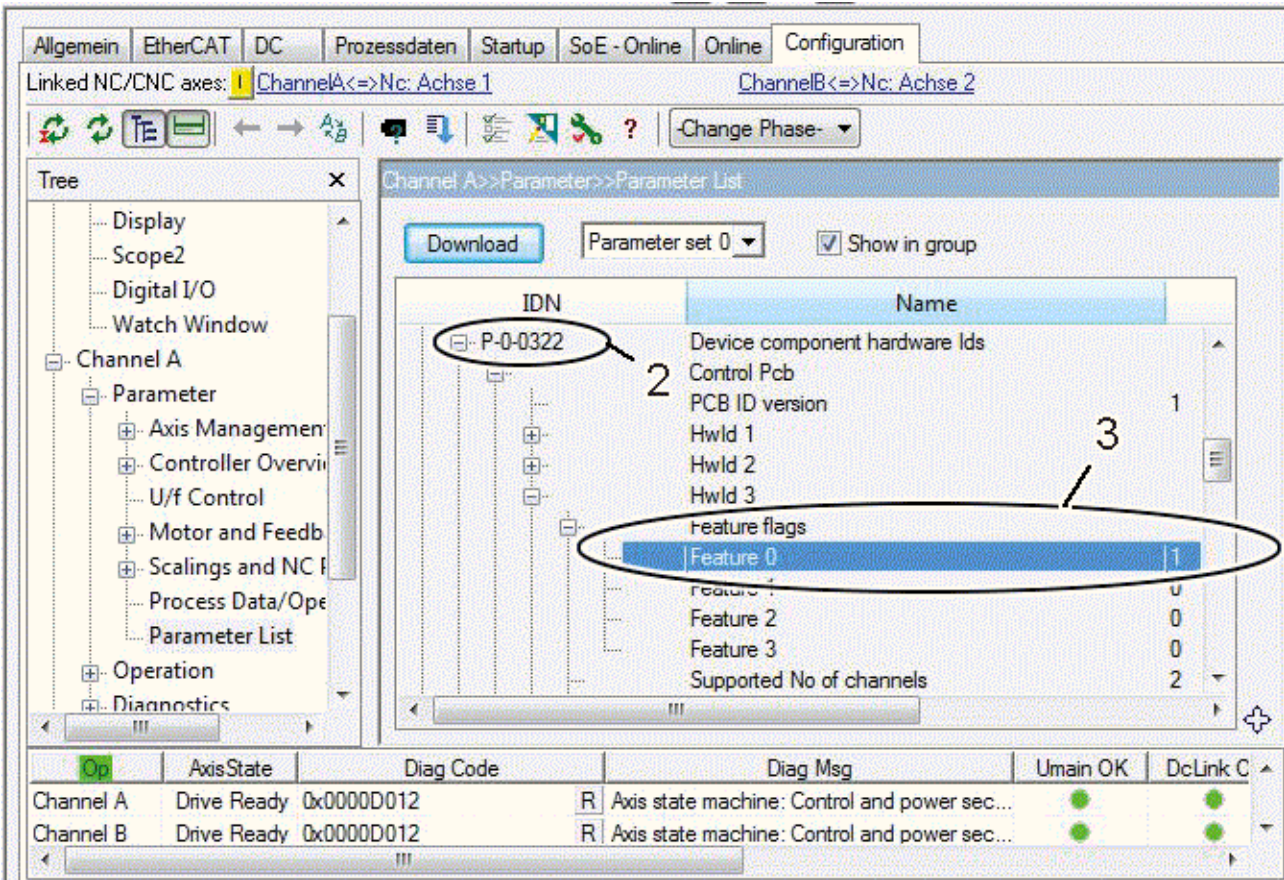

AX5000 with hardware version 2 and firmware version 2.04 or higher.

The current firmware version of the AX5000 is displayed under (4) in the "Watch Window".

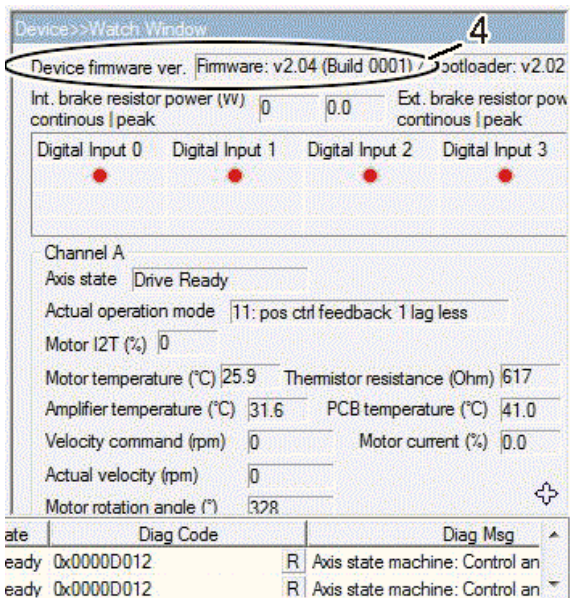

9.8 Decommissioning

DANGER

Serious risk of injury through electric shock!

Due to the DC link capacitors, the DC link terminal points "ZK+ and ZK- (DC+ and DC-)" and "RB+ and RB-" may be subject to dangerous voltages exceeding $875 V_{DC}$, even after the servo drive was disconnected from the mains supply. Wait 5 minutes for the AX5101 – AX5125 and AX520x; 15 minutes for the AX5140/AX5160/AX5172; 30 minutes for the AX5190/AX5191; 45 minutes for the AX5192/AX5193 after disconnecting, and measure the voltage at the DC link terminal points "ZK+ and ZK- (DC+ and DC-)". The device is safe once the voltage has fallen below 50 V.

9.9 Integrated safety

9.9.1 Safety-Card AX5801

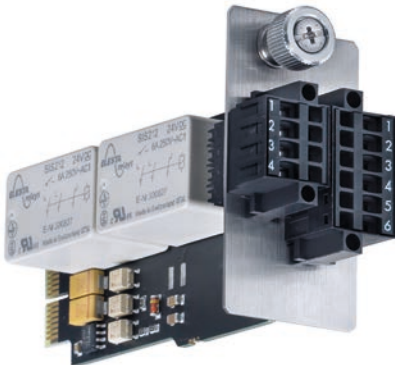

9.9.2 Intended use

The AX5801 Safety Card is exclusively intended for application in the safety slot of the servo drives AX5101 – AX5140 and AX52xx. The cards are installed together with the servo drive as components in electrical systems and machinery and may only be used in this way.

9.9.3 Scope of supply

The scope of supply includes the following components:
 AX5801 Safety Card, 4-pin connector, 6-pin connector, technical documentation and packaging

If one of the components is damaged please notify the logistics company and Beckhoff Automation GmbH immediately.

9.9.4 Safety regulations

⚠ DANGER

Serious risk of injury through electric shock!

Due to the DC link capacitors, the DC link terminal points "ZK+ and ZK- (DC+ and DC-)" and "RB+ and RB-" may be subject to dangerous voltages exceeding $875 V_{DC}$, even after the servo drive was disconnected from the mains supply. Wait 5 minutes for the AX5101 – AX5125 and AX520x; 15 minutes for the AX5140/AX5160/AX5172; 30 minutes for the AX5190/AX5191; 45 minutes for the AX5192/AX5193 after disconnecting, and measure the voltage at the DC link terminal points "ZK+ and ZK- (DC+ and DC-)". The device is safe once the voltage has fallen below 50 V.

⚠ WARNING

Caution - Risk of injury!

Electronic equipment is not fail-safe. The machine manufacturer is responsible for ensuring that the connected motors and the machine are brought into a safe state in the event of a fault in the drive system.

NOTE

Caution – electrostatic charging may lead to destruction of the Safety Card!

The Safety Card is an ESD-sensitive component. Follow the usual ESD safety procedures when handling the card (anti-static wrist straps, earthing of the relevant components etc.).

9.9.5 Personnel qualification

This description is only intended for trained specialists in control, automation and drive engineering who are familiar with the applicable national standards. Knowledge of machine safety legislation is compulsory.

9.9.6 Product description

The AX5801 Safety Card from Beckhoff is used to realize the safe stop functions "STO or SS1 according to IEC 61800-5-2". STO stands for SafeTorqueOff, SS1 for SafeStop1.

Thanks to the integrated two-channel monitoring of the AX5000, you can realize stop category 0 or 1 according to IEC 60204-1 with minimum effort and further TwinSAFE blocks from Beckhoff, thereby achieving category 4, PL e according to ISO 13849-1:2006.

Two-channel monitoring is achieved through certified relays (Rel1 and Rel2). The relays are equipped with positively driven contacts including feedback contacts (K1 and K2). The feedback contacts are connected in series and potential-free with terminals (5) and (6) of the 6-pin connector.

The two coils (S1 and S2) have to be supplied with 24 V DC via terminals 1 and 2 or 3 and 4 of the 6-pin or 4-pin connector. Terminals 1-1, 2-2, 3-3 and 4-4 of the two connectors are bridged internally. If a relay releases, the de-energizing circuit of the AX5000 servo drive range ensures that the connected motors (both channels) become torque-free.

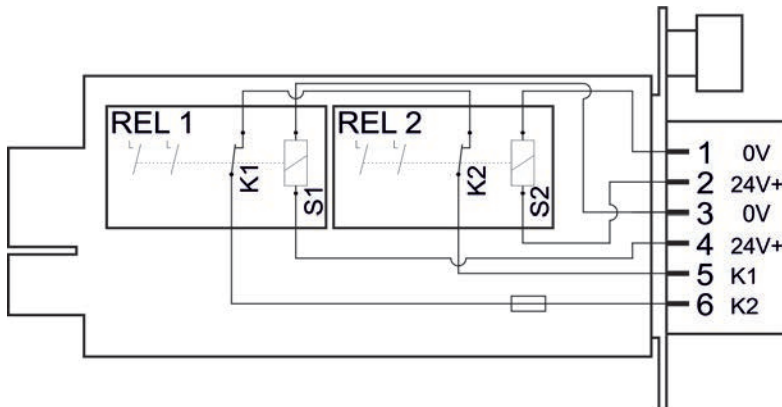

9.9.7 Technical data

Data	Values
Relay operating voltage (terminal 1-4)	24 VDC -15% +20%
Feedback contacts operating voltage (5-6)	24 VDC -15% +20%
Max. switching current of the feedback contacts (5-6)	0.35 A
Conductor cross-section of terminals 1-6	0.2 - 1.5 mm ²
Conductor strip length of terminals 1-6	10 mm
Current consumption	50 mA

We recommend using wire end sleeves!

9.9.8 Installation of the AX5801 Safety Card

⚠ DANGER

Serious risk of injury!

Due to the DC link capacitors, the DC link terminal points "ZK+ and ZK- (DC+ and DC-)" and "RB+ and RB-" may be subject to dangerous voltages exceeding $875 V_{DC}$, even after the servo drive was disconnected from the mains supply. Wait 5 minutes for the AX5101 – AX5125 and AX520x; 15 minutes for the AX5140/AX5160/AX5172; 30 minutes for the AX5190/AX5191; 45 minutes for the AX5192/AX5193 after disconnecting, and measure the voltage at the DC link terminal points "ZK+ and ZK- (DC+ and DC-)". The device is safe once the voltage has fallen below 50 V.

9.9.8.1 Mechanical installation

9.9.8.1.1 Installation of the two connectors on the AX5801 Safety-Card

- Insert the enclosed 4-pin connector (1) into the socket.
- Tighten the two bolts (2).
- Insert the 6-pin connector (3) into the socket.(4).
- Tighten the two bolts (5).

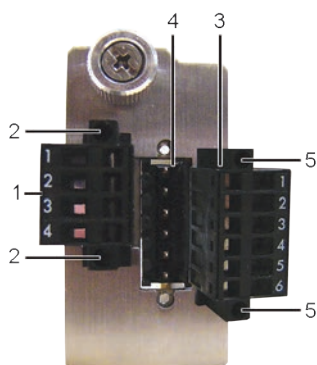

9.9.8.1.2 Installation of the AX5801 Safety-Card

- Fully release the bolt (6).
- Remove the insert (7) in the direction of the arrow (8).
- Carefully insert the Safety Card (9) into the opening in the direction of the arrow (10). The slot has guides for the card on the short sides. Ensure that the card is inserted into these guides.
- Tighten the bolt (11).

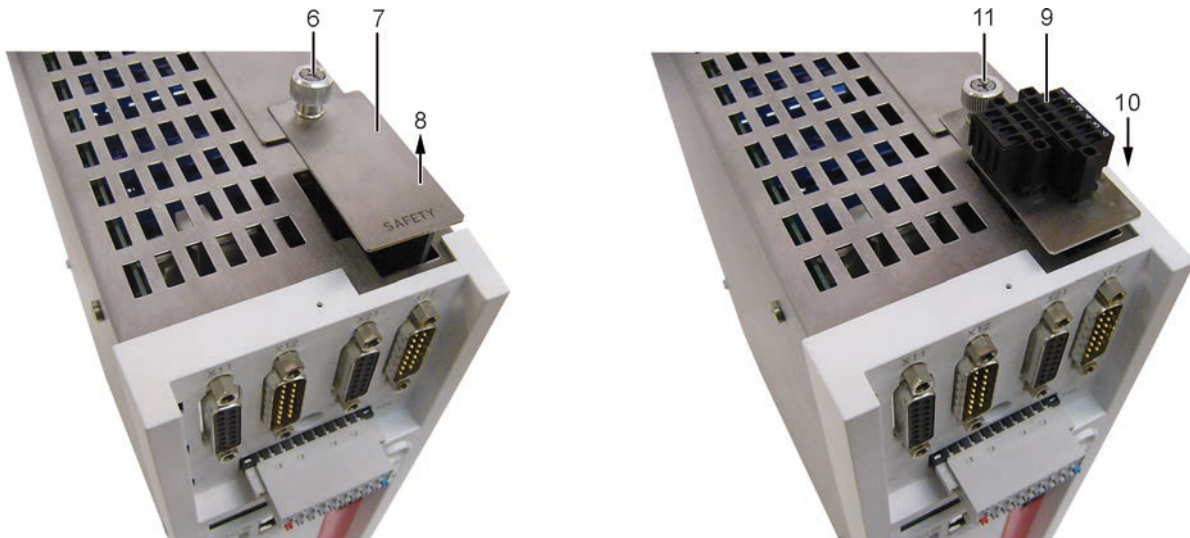

9.9.8.2 Electrical installation

Configure the safety operation of servo drive via IDN P-0-2000. During the next system start-up the servo drive automatically detects whether a Safety Card was inserted and whether the IDN P-0-2000 parameterization is correct. Error message "0xFDD4" indicates incorrect configuration. If the servo drive with the Safety Card does not reach the safe state, error message "0xFDD5" appears on the display of servo drive. In this case please contact Beckhoff.

⚠ CAUTION

Danger for persons and equipment!

If an error message appears on the display of the AX5000 the servo drive must not be put into service if the servo drive in the system or machine represents a safety-relevant part of the control system.

9.9.9 Application example (emergency stop – stop category 1)

Components involved:

- Emergency stop device (control switch S1) according to ISO 13850 and control switch S2
- 1 safety input terminal (KL1904) and 1 input terminal (KL 1404)
- 1 safety logic terminal (KL6904) with function block "ESTOP"
- AX5801 Safety Card and servo drive from the AX5000 range
- Programmable logic controller (PLC) and EtherCAT fieldbus

By activating the emergency stop device (S1) inputs EStopIn1 and EStopIn2 of FB "ESTOP" are switched to state "0", resulting in outputs EStopOut and EStopDelOut of FB "ESTOP" being switched to state "0". As a result, a quick stop command is issued to the PLC and therefore the AX5000 via EtherCAT. The output EStopDelOut of FB "ESTOP" ensures that after a specified delay time the 24 V supply of the AX5801 Safety Card is interrupted. This causes the relays (REL1 and REL2) to release and both channels (motors) to be made torque-free via the internal deactivation procedure of the AX5000.

In the event of a fault the controlled shutdown (quick stop) may fail. The Safety Card becomes active once the delay time has elapsed, and all motors connected to the device run out. The risk analysis for the machine must indicate that this behavior can be tolerated. An interlock may be required.

The delay time must be set slightly longer than the maximum braking time of the quick stop.

Sticking relay contacts on the Safety Card are detected via input EDM1 of FB "ESTOP", and restarting is prevented.

When the emergency stop device is released again, the control switch (S2) must be operated (first rising then falling edge at the restart input of FB "ESTOP") in order to restart the AX5000.

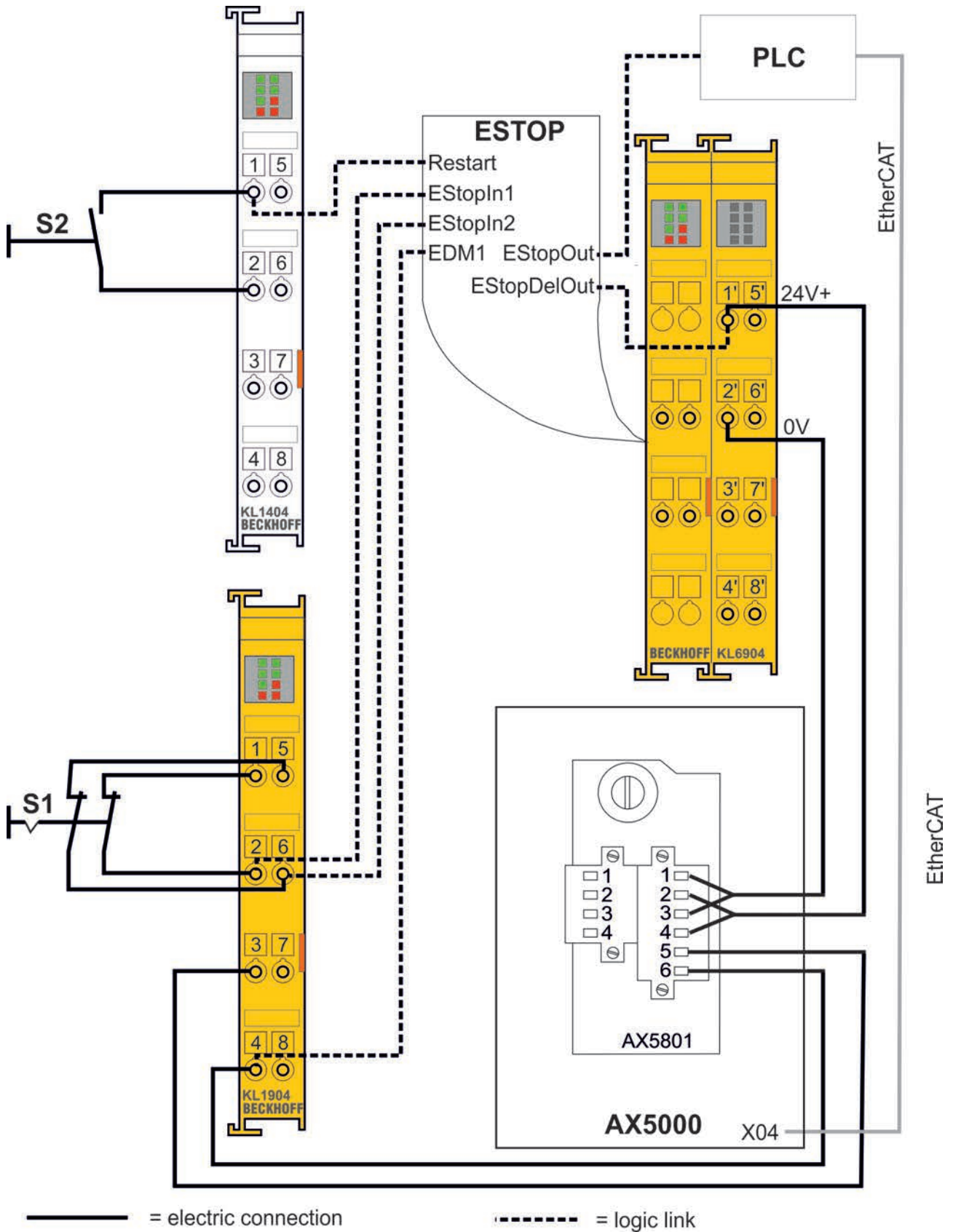

9.9.10 Application example with several AX5000

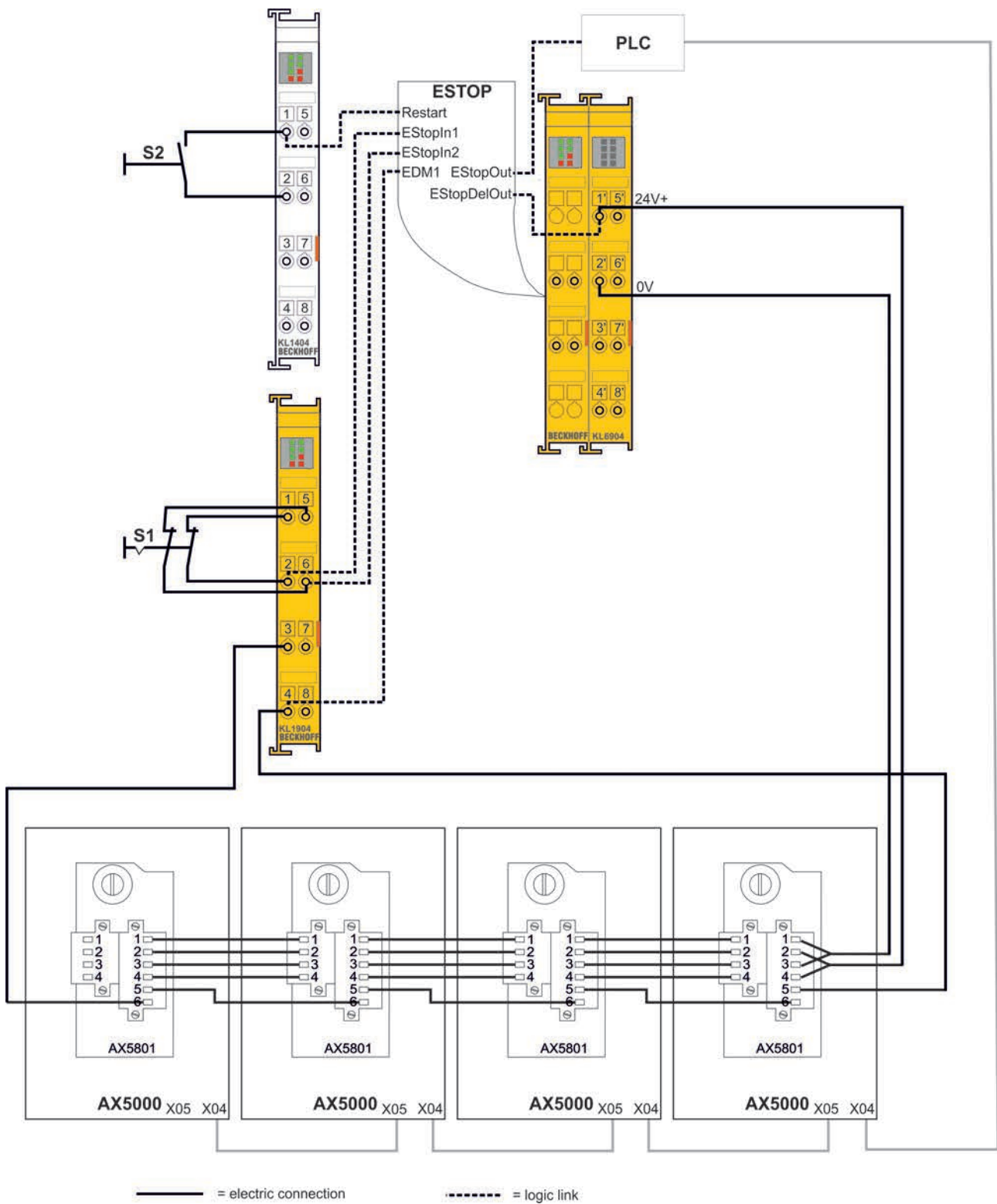

10 Project planning

10.1 Important information for project planning

The more thoroughly a machine or plant project is thought through in advance, the less risk there is of having to carry out expensive modifications during or after commissioning. This applies to both the mechanical and electrical design. This chapter can only provide a brief overview of electrical project planning.

10.2 Drive train design

Application, servo drive, motors and gear mechanism must be adapted to each other so that there is an adequate safety margin for all components as a degree of sluggishness appears over time due to high temperatures or wear. Make sure that the components in the working area of the system have adequate reserves so that the working life is not impaired and the necessary control quality can be maintained.

10.3 Energy management

If the quality of the mains supply is impaired due to wide fluctuations in voltage, then both the servo drive specification and the speed range of the motor will need to be considered. With a positive tolerance for voltage fluctuation the upper limit value of the wide voltage input of the AX5000 needs to be taken into account. With a negative tolerance of the voltage fluctuation it must be checked whether the decrease in speed caused by the low voltage is permissible. With these motors what is known as field weakening operation (check availability) of the servo drive may provide a solution. If the mains supply does not meet the specifications for operation of the AX5000, then isolating transformers, mains chokes, mains filters or other measures may be required.

● Only AX5101 – AX5140!



An energy efficient drive system operates in a drive system with a shared DC link and shared internal and possibly also external brake resistors or brake modules. If you are already using similar drive systems, the AX5000 offers a convenient diagnostic system for determining the load on the brake resistors and for transferring the values. Previous experience with drive systems shows that in such a system much smaller or even no external brake resistors / brake modules need to be used.

10.4 EMC, earthing, shield connection and potential

● EMC information of the servo drive AX5000!



For further information, please read the EMC – information brochure of the servo drive AX5000. You will find the document on the Beckhoff homepage (www.beckhoff.com) under: Motion → Documentation → EMC – leaflet.

10.5 Control cabinet

The dimensions of the control cabinet must be sufficient to accommodate all components with the specified distances. Remember that high temperatures may necessitate forced cooling. Position the control cabinet as close as possible to the machine so that the motor cables can be as short as possible.

In addition, the control cabinet should have an earthed metal rear panel to which the AX5000 incl. periphery are attached so that safe earthing can be guaranteed. If you are unable to guarantee these conditions you need to earth the AX5000 and the relevant components using an approved cable of adequate size.

11 Accessories



Accessories with UL-Listing!

If you wish to operate an AX5000 in an economic area that requires a UL-Listing, please make sure that the accessories also have a UL-Listing.

The following optional accessories are available (see Beckhoff main catalog or www.beckhoff.de):

- Motor and feedback cable (ready-made)
- Motor and feedback cable sold by the metre
- D-Sub connector X11, X12, X21, X22 individual (for feedback cable and resolver/Hall)
- Motor and sensor connector X13, X14, X23, X24
- EtherCAT bus cable, ready-made or sold by the metre
- Synchronous servomotors (linear or rotational)
- External ballast resistor
- Expansion cards
- Additional modules

11.1 AX-Bridge - quick connection system

11.1.1 Supply module for multi-axis system

If several AX5000 are to be linked to form a multi-axis system, a supply module for connecting the mains voltage and the control voltage (24 V_{DC}) for the control electronics and the motor brake is required.

Figure	Article no.	Description
	AX5901	AX-Bridge power supply module for connection of supply voltage and 24 V DC for control and brake energy (pluggable), for AX5x01...AX5125, 85 A
	AX5902	AX-Bridge power supply module for connection of supply voltage and 24 V DC for control and brake energy (pluggable), for AX5140, 85 A

To install the supply module connectors X01, X02 and X03 must be removed and replaced with the supply module.

11.1.2 AX-Bridge connection module (AX5x01 - AX5112)

The connection between the two AX amplifiers is established by moving the three busbar sliders of the first connection module of the next drive to the left.

Figure	Article no.	Description
	AX5911	AX-Bridge power distribution module, quick connection system for power supply, DC-Link and control voltage (pluggable), for AX5x01...AX5112, 85 A

11.1.3 AX-Bridge connection module (AX5118 and AX5125)

The connection between the two AX amplifiers is established by moving the three busbar sliders of the first connection module of the next drive to the left.

Figure	Article no.	Description
	AX5912	AX-Bridge power distribution module, quick connection system for power supply, DC-Link and control voltage (pluggable), for AX5118 and AX5125, 85 A

11.2 Brake module - AX5021-0000

Figure	Art.-No.	Description
	AX5021-0000-0000	Using a brake module allows to take up additional braking power in a drive system. For drives up to the size of the AX5125 (25 A rated current) it is not permissible to connect the DC busses and an external brake resistor at the same time. A further advantage is the simple installation and the small space requirement of the brake module. The brake module is equipped with a complete DC link and an internal brake resistor and enables the connection of an external brake resistor with the integrated brake chopper. Several brake modules can be integrated into a drive system.

i Operating conditions

The brake module may only be used together with servo drives of the AX51xx-xxxx-02xx or AX52xx-xxxx-02xx series. These devices have serial numbers above 100.000. In addition to the AX5021, the drive system must include at least two further servo drives from the AX5000 range.

11.2.1 Electrical data

Electrcal data	AX5021
int. Resistance ¹⁾ [W]	150
int. Resistance ²⁾ [W]	14.000
ext. Resistance min. [Ω]	22
ext. Resistance ³⁾ [W]	6.000
ext. Resistance ⁴⁾ [W]	max. 32.000
Power loss P [W]	max. 250
Charging rate 24 V _{DC} [A]	0.3 – 0.4
DC link capacity [μ F]	705

1) Durability break power P_{rms}

2) Peak break power P_{peak}

3) Durability brake power P_{rms}

4) Peak brake power P_{peak}

11.2.2 Mechanical data

The external dimensions of the brake module are identical to the dimensions of the servo drives from the AX5000 series up to 12 A.

Mechanical data	AX5021
Weight	approx. 4 kg
Width	92 mm
Height without plugs	274 mm
Depth without connectors / accessories	232 mm

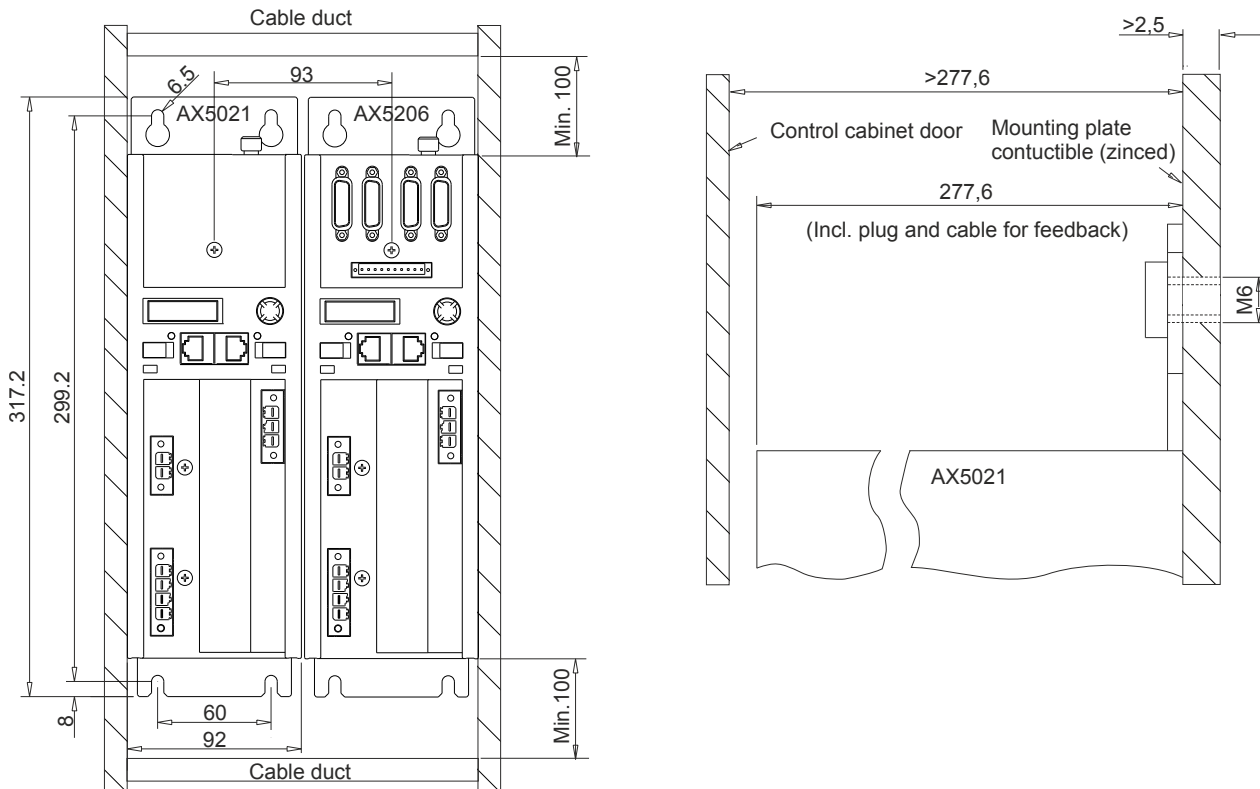

11.2.3 General overview

No.	Name		
1	Navigation rocker		
2	Labelling field		
3	X05 - socket for EtherCAT output		
4	X03 – power supply 24 V DC Input		
5	X52 - connection of the temperature monitor and the fan of the external brake resistor		
6	X51 - connection of the external brake resistor		
7	X01 – mains supply 100 – 480 V		
8	X02 – DC link output (890 V DC voltage).		
9	 DANGER		Max. voltage 890 V DC at the DC link terminals (X02). Once the device has been switched off dangerous voltage will still be present for a further 5 minutes. The device is safe once the voltage has fallen below 50 V.
10			X04 - socket for EtherCAT input
11	Display		

11.2.4 Pin strip assignment of X51 and X52

No.	Name
1	T- = input of the temperature measurement sensor of the external brake resistor
2	T+ = input of the temperature measurement sensor of the external brake resistor
3	PE = protective conductor
4	F- = output to the fan controller of the external brake resistor
5	F+ = output to the fan controller of the external brake resistor
6	PE = protective conductor
7	B- = output to the controller of the external brake resistor
8	B+ = output to the controller of the external brake resistor



Please refer to the servo drive 'Startup' manual for the pin assignments of the remaining inputs and outputs.

i **Temperature rise in the external brake resistor**

The temperature rise of the external brake resistor should be monitored continuously via temperature contacts (1) and (2).

11.2.5 Electrical connection (example)

⚠ DANGER

Serious risk of injury through high electrical voltage!

Due to the DC link capacitors dangerous voltage may persist at the DC link contacts "X02" after the servo drive has been disconnected from the mains supply. Wait 5 minutes after disconnection and measure the voltage on the DC link contacts DC+ and DC-. The device is safe once the voltage has fallen below 50 V.

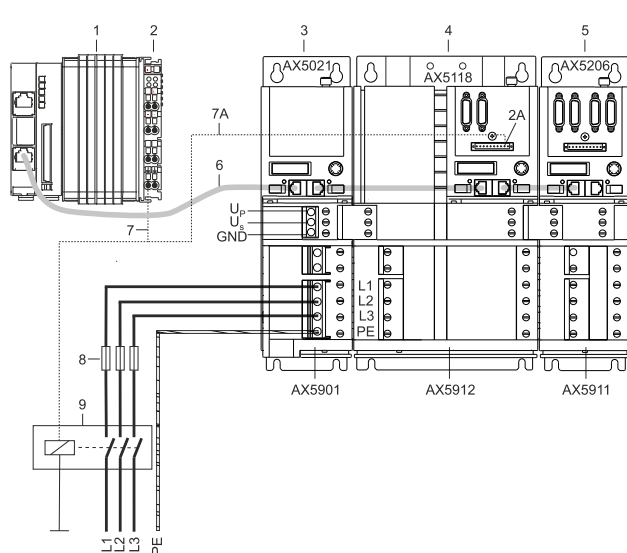

The example below describes the brake module and several servo drives, which are linked via AX-Bridge modules to make up a drive system. We recommend that the brake module be placed in the first position with the AX-Bridge power supply module (AX5901) and after that the servo drives with decreasing rated current; we assume here that the most powerful servo drive also releases the greatest brake energy.

CAUTION!

Uncontrolled movements!

If the drive system is disconnected from the mains due to a mains failure, all axes of the drive system make uncontrolled movements. Take suitable measures to ensure that no persons are endangered during this time. Vertical axes are particularly dangerous.

Pos.	Name	Pos.	Name
1	PC with TwinCAT and PLC	6	Patch cable
2	Output terminal	7	Control cable from the output terminal
2A	Output "8" of the servo drive digital I/Os	7A	Control cable from output '8' of the servo drive digital I/Os
3	Brake module	8	Mains fuses
4	Servo drive (with the greatest brake energy)	9	Mains contactor
5	Servo Drives		

11.2.6 Integration into TwinCAT

Integration of the brake module by TCDriveManager and Powermanagement

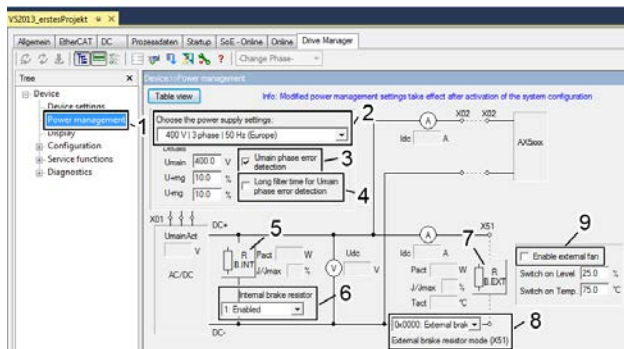

The brake module can be integrated and parameterized in the TCDriveManager as a completely digital I/O device.

The position descriptions are in the table below.

Pos.	Description	Pos.	Description
1	Powermanagement	6	Activation / deactivation of the internal brake resistor
2	Mains voltage selection	7	External brake resistor parameter list
3	Phase monitoring (deactivate for single-phase mains)	8	0 = Deactivation of the external brake resistor (not recommended) 1 = Standard energy management with external brake resistor 2 = Energy management with external brake resistor (standalone)
4	Delay time until the phase monitoring responds (activate if mains is unclean)	9	Enabling / disabling the fan of the external brake resistor and setting the switching thresholds Switch on Level: Percentage specification of the rated capacity value of the external brake resistor. Switch on Temp.: Max. temperature value for the external brake resistor in °C.
5	Internal brake resistor parameter list		

11.2.7 DC link (only for 60A-170A devices)

● Connection example DC link group!

i For further information of the production for an DC link group you will find in the system manual of the servo drive AX5000 under: "[Connection example – DC link group \[► 52\]](#)"

11.2.8 Operation modes of the AX5021

It can be assumed that a brake module is used only if the brake energy cannot be dissipated despite a DC link system and internal brake resistors. The brake module can be operated in two different operation modes, which have a direct influence on the energy management. The operation modes can be selected when using the external brake resistor. The following sketches show the storage capacity of the DC link of the individual devices in relation to the operation modes.

Ext. brake resistor enabled (system / standard)

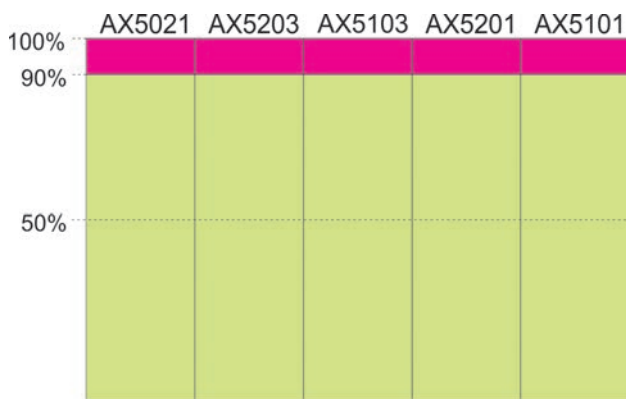

In this operation mode the capacity of the DC link of the brake module is reduced by approx. 10%. At 90% DC link load the brake chopper then directs the generated braking energy to the external brake resistor and, when this has reached its capacity limit, into the internal brake resistor. In this case the brake energy is first fed into the brake module, since the brake choppers in the other servo drives are only activated at 100% utilization of the DC link. This operation mode is set as the default, because no further configuration of the devices in the DC link system is necessary apart from the basic configuration of the brake module. If the external brake resistor of the brake module is mounted outside the control cabinet, then the thermal load in the control cabinet is also lower.

Ext. brake resistor enabled (standalone brake chopper)

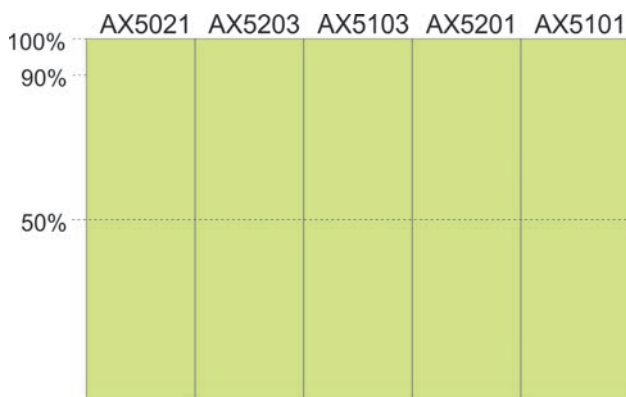

In this case the capacity of the DC links is fully utilized. This operation mode must be selected and, apart from the basic configuration of the brake module, the internal brake resistors of the devices in the DC link system should be deactivated, as otherwise the thermal load in the control cabinet will also increase. In order to reduce the thermal load further, it is a good idea to mount an external brake resistor on the brake module outside the control cabinet.

11.2.9 Braking power diagnosis

● Power Management of the servo drive AX5000!

i Further information for the diagnostics of the external brake resistors you will find in the function description of the servo drive AX5000 under: "Power Management".

11.3 Optional encoder card - AX5701 / AX5702

Figure	Art.-No.	Description
	AX5701-0000	encoder option card for one additional encoder input 1 V _{pp} , BiSS B, Hiperface, EnDat
	AX5702-0000	encoder option card for two additional encoder inputs 1 V _{pp} , BiSS B, Hiperface, EnDat

11.3.1 Intended use

The optional encoder cards are exclusively intended for application in the optional rear slot of a servo drive from the AX5000 series. The cards are installed together with the servo drive as components in electrical systems and machinery and may only be used in this way.

11.3.2 Safety regulations

The responsible staff must ensure that the application or use of the products described satisfy all the requirements for safety, including all the relevant laws, regulations and guidelines.

⚠ DANGER

Caution - Danger of death!

Even when the AX5000 is disconnected from the mains voltage, dangerous voltage continues to be present at the "X02" terminals of the DC link for at least 5 minutes. Wait until the DC link capacitors are discharged before touching live terminals. The voltage measured between the DC+ and DC- terminals (X02) must have dropped to below 50 V.

⚠ WARNING

Caution - Risk of injury!

Electronic equipment is not fail-safe. The machine manufacturer is responsible for ensuring that the connected motors and the machine are brought into a safe state in the event of a fault in the drive system.

NOTE

Caution – Destruction of the optional encoder card through electrostatic charging!

The optional encoder card is an ESD-sensitive component. Follow the usual ESD safety procedures when handling the card (anti-static wrist straps, earthing of the relevant components etc.).



UL approval

If you intend to operate an AX5000 in a region that requires UL approval, please refer to the chapter "Guidelines and Standards".

11.3.3 Product identification

11.3.3.1 Type key

AX5701 – optional encoder card for single-channel servo drives

AX5702 – optional encoder card for two-channel servo drives

i Operation of the optional encoder card

The AX5701 can only be used in single-channel servo drives, the AX5702 can only be used in two-channel servo drives.

Inputs A to D are single-wire inputs (single-ended). They have a certain potential to ground, which is analysed.

Inputs E to F are two-wire inputs (differential). They require (+) and (-) and analyse the voltage difference between the conductions.

Firmware revision

AX5000-xxxx-02xx = mind. 2.03 build 0009

11.3.3.2 Description of the digital inputs

i Configuration of the digital inputs and outputs!

Further information on the control and configuration of the digital inputs and outputs can be found in the function description of the servo drive AX5000 under: "Digital Inputs and Outputs".

11.3.3.3 Overview of sockets X41 (channel A) and X42 (channel B)

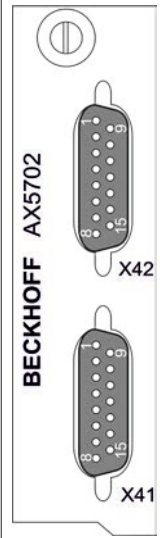
	Pin	EnDAT / BiSS	Hiperface	Sin / Cos 1V _{pp}	TTL ¹⁾	In "A"	In "B"	In "C"	In "D"	In "E"	In "F"
	1	SIN +	SIN +	SIN +	n.c.	X				X (+)	
	2	GND_5 V	GND_9 V	GND_5 V	GND_5 V						
	3	COS +	COS +	COS +	n.c.			X			X (+)
	4	U _s 5 V	n.c.	U _s 5 V	U _s 5 V						
	5	DX+ (Data)	DX+ (Data)	n.c.	B+			Y			
	6	n.c.	U _s 9 V	n.c.	n.c.						
	7	n.c.	n.c.	REF Z	REF Z						
	8	CLK+ (Clock)	n.c.	n.c.	A+	Y					
	9	REF SIN	REF SIN	REF SIN	n.c.		X				X (-)
	10	GND_Sense	n.c.	n.c.	GND_Sense						
	11	REF COS	REF COS	REF COS	n.c.				X		X (-)
	12	U _s 5 V Sense	n.c.	U _s 5 V Sense	U _s 5 V Sense						
	13	DX - (Data)	DX - (Data)	n.c.	n.c.				Y		
	14	n.c.	n.c.	Z +	Z +						
	15	CLK - (Clock)	n.c.	n.c.	n.c.			Y			

¹⁾Attention: Wire break detection is not supported for TTL encoders.

The digital inputs "A" to "D" can be connected to X or Y.

The digital inputs "E" and "F" must be connected to X (+) and X (-).

11.3.3.4 Configuration of jumpers J-"A" for channel "A" and J-"B" for channel "B"

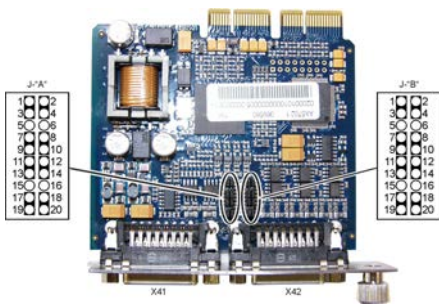

Jumpers J-"A" and J-"B" (1) are located at the center of the printed circuit board near the front panel of the card. For each channel there are 2 row of jumpers, each with 20 pins. The default setting without analysis of the additional inputs is shown in the following figure.

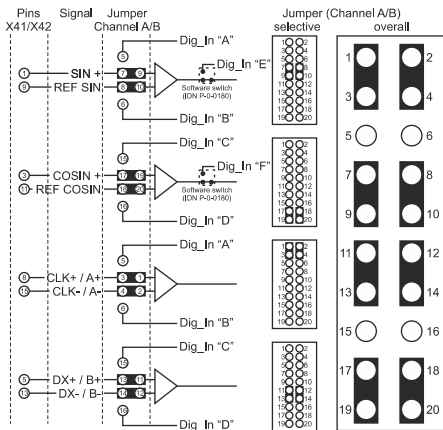

The opposite figure shows the basic jumper configuration, which is the same for channel A and channel B. The pins of input sockets X41 and X42 are wired firmly to the corresponding pins of the jumpers rows. The non-configurable pins are not shown. To use the additional inputs proceed as follows:

- Reposition the relevant jumpers und set IDN P-0-0180-->Feedback options-->Digital Inputs "Input A" to "Input D" to "used" or set IDN P-0-0180-->Feedback options-->Digital Inputs "Input E" or "Input F" to "used" without repositioning the jumpers.
- Connect the encoder cable as required for the relevant inputs or use an adapter.

The following table shows a selection of combination options.

Feedback system	Input "A"	Input "B"	Input "C"	Input "D"	Input "E"	Input "F"
EnDat					not available	
BISS					not available	
Hiperface	X	X				
Sin / Cos 1 V _{pp}	X	X	X	X		
TTL ¹⁾	X ²⁾	X ²⁾	X ³⁾	X ³⁾	X ²⁾	X ³⁾

¹⁾Attention: Wire break detection is not supported for TTL encoders.

²⁾ Either inputs "A" and "B" or input "E" can be used

³⁾ Either inputs "C" and "D" or input "F" can be used.

11.3.3.4.1 Technical data

Description	Value
Digital inputs "A" to "D" (single-ended)	Open collector with max. 1 mA
Digital inputs "E" to "F" (differential)	0 - 5 V at the input resistance 120 W

11.3.4 Installation of the optional encoder card

⚠ DANGER

Caution - Danger of death!

Even when the AX5000 is disconnected from the mains voltage, dangerous voltage continues to be present at the "X02" terminals of the DC link for at least 5 minutes. Wait until the DC link capacitors are discharged before touching live terminals. The voltage measured between the DC+ and DC- terminals (X02) must have dropped to below 50 V.

NOTE

Destruction of the optional encoder card through electrostatic charging!

The optional encoder card is an ESD-sensitive component. Follow the usual ESD safety procedures when handling the card.

- Fully release the screw (1).
- Remove the panel (2).
- Carefully insert the optional card (3) into the opening in the direction of the arrow. The slot has guides for the card on the short sides. Ensure that the card is inserted into these guides. Tighten the bolt (4).

11.3.5 Sample: Renishaw RGH 22Z30D00

Feedback and inputs

P-0-0180	Feedback 2 type	13: Renishaw	13: Renishaw
	Manufacturer	13: Renishaw	13: Renishaw
	Feedback type	1: Linear feedback	1: Linear feedback
	Feedback type string	Ren#RGH22Z-TTL-5...	Ren#RGH22Z-TTL-5...
	Feedback use	1: Additional second m...	1: Additional second m...
	Feedback direction	0: Positive direction	0: Positive direction
	rsvd		
	Power settings		
	Process channel		
	Parameter channel		
	Manufacturer limits settings		
	Feedback options		
	Digital Inputs		
	Input A (single ended)	0: Not used	0: Not used
	Input B (single ended)	0: Not used	0: Not used
	Input C (single ended)	1: used	1: used
	Input D (single ended)	0: Not used	0: Not used
	Input E (differential)	1: used	1: used
	Input F (differential)	0: Not used	0: Not used
	reserved	0	0
	rsvd	0	0
	rsvd		

Scaling

P-0-0180	Feedback 2 type	13: Renishaw	13: Renishaw
	Manufacturer	13: Renishaw	13: Renishaw
	Feedback type	1: Linear feedback	1: Linear feedback
	Feedback type string	Ren#RGH22Z-TTL-5...	Ren#RGH22Z-TTL-5...
	Feedback use	1: Additional second m...	1: Additional second m...
	Feedback direction	0: Positive direction	0: Positive direction
	rsvd		
	Power settings		
	Process channel		
	Process interface	2: Incremental 5V TTL	2: Incremental 5V TTL
	Connector	41: X41 (Option Slot, E...	41: X41 (Option Slot, E...
	rsvd		
	Data		
	Sin / Cos		
	TTL		
	Resolution per rotation	48000	48000
	Length per signal period	500	500
	rsvd		
	Resolver		
	MES		
	Parameter channel		
	Manufacturer limits settings		
	Feedback options		

11.3.5.1 Overview of socket X41 (channel A) and jumper configuration

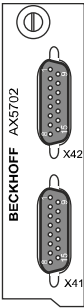
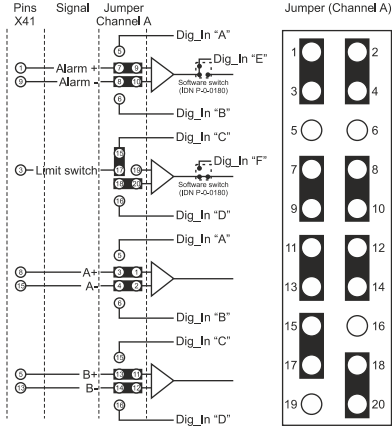
Socket X41	Pin	Renishaw	In "C"	In "E"	Jumper configuration
	1	Alarm +		X +	
	2	GND_5 V			
	3	Limit switch	X		
	4	U _s 5 V			
	5	B +			
	6	n.c.			
	7	REF Z			
	8	A +			
	9	Alarm -		X -	
	10	GND_Sense			
	11	n.c.			
	12	U _s 5 V Sense			
	13	B -			
	14	Z +			
	15	A -			

11.4 Optional encoder card - AX5721 / AX5722

Figure	Art.-No.	Description
	AX5721-0000	encoder option card for one additional encoder input EnDat 2.2, BiSS C
	AX5722-0000	encoder option card for two additional encoder inputs EnDat 2.2, BiSS C

11.4.1 Intended use

11.4.2 Safety regulations

The responsible staff must ensure that the application or use of the products described satisfy all the requirements for safety, including all the relevant laws, regulations and guidelines.

⚠ DANGER

Danger of death!

Due to the DC link capacitors dangerous voltage (> 875V_{DC}) may persist at the DC link contacts "ZK+ and ZK- (DC+ and DC-)" and "RB+ and RB-" after the servo drive has been disconnected from the mains supply. After disconnecting the servo drive wait at AX5101 - AX5125 and AX520x; 5 minutes, at AX5140/ AX5160/AX5172; 15 minutes, at AX5190/AX5191; 30 minutes and at AX5192/AX5193; 45 minutes and measure the voltage at the DC link contacts ZK+ and ZK- (DC+ and DC-). The device is safe once the voltage has fallen below 50 V.

⚠ WARNING

Warning – Risk of injury!

Electronic equipment is not fail-safe. The machine manufacturer is responsible for ensuring that the connected motors and the machine are brought into safe state in the event of a fault in the drive system.

⚠ CAUTION**Destruction of the digital encoder card through electrostatic charging!**

The digital encoder card is an ESD-sensitive component. Follow the usual ESD safety procedures when handling the card.

**UL approval**

If you intend to operate an AX5000 in a region that requires UL approval, please refer to the chapter "Guidelines and Standards".

11.4.3 Product identification

11.4.3.1 Type key

AX5721 – High Resolution Digital Encoder Option Card for single-channel servo drives.

AX5722 – High Resolution Digital Encoder Option Card for dual-channel servo drives.



No safety functions!

Safety functions cannot be implemented with the encoder option card.

The encoder option card enables the connection of one digital feedback system per channel. The sockets X41 or X42 respectively are not plug-compatible with the front sockets X11 or X21 respectively of the AX5000. The following interfaces are supported:

- EnDat 2.2
- BiSS “C” mode

Firmware revision:

AX5000: 2.06 or higher and AX572x: 2.06 or higher.

11.4.3.2 Overview of sockets X41 (channel A) and X42 (channel B)

	Pin	EnDat 2.2	BiSS C	Output current
	1	n.c.	n.c.	0.25 A / Channel
	2	GND	GND	
	3	n.c.	n.c.	
	4	5V+ ±10%	5V+ ±10%	
	5	Data+	Data+	
	6	12V	12V	
	7	n.c.	n.c.	
	8	CLK+	CLK+	
	9	n.c.	n.c.	
	10	GND sense	GND sense	
	11	n.c.	n.c.	
	12	5V sense ±10%	5V sense ±10%	
	13	Data-	Data-	
	14	n.c.	n.c.	
	15	CLK-	CLK-	

¹Attention: Wire break detection is not supported for TTL encoders. The digital inputs "A" to "D" can be connected to X or Y. The digital inputs "E" and "F" must be connected to X (+) and X (-).

11.4.3.2.1 Technical data

Motor type	Max. Resolution	
Rotatory	≤ 32 Singleturn-Bits	≤ 16 Multiturn-Bits
Linear	≤ 48 Singleturn-Bits	

11.4.4 Installation of the optional encoder card

⚠ DANGER

Caution - Danger of death!

Even when the AX5000 is disconnected from the mains voltage, dangerous voltage continues to be present at the "X02" terminals of the DC link for at least 5 minutes. Wait until the DC link capacitors are discharged before touching live terminals. The voltage measured between the DC+ and DC- terminals (X02) must have dropped to below 50 V.

NOTE

Destruction of the optional encoder card through electrostatic charging!

The optional encoder card is an ESD-sensitive component. Follow the usual ESD safety procedures when handling the card.

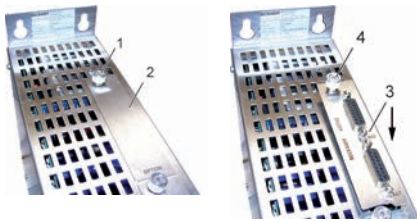

- Fully release the screw (1).
- Remove the panel (2).
- Carefully insert the optional card (3) into the opening in the direction of the arrow. The slot has guides for the card on the short sides. Ensure that the card is inserted into these guides. Tighten the bolt (4).

11.4.5 Error messages

No.	Description
F870	„Encoder not ready“ – execute the RESET command (S-0-0099)
F872	„Error flag active“ – status changes to „Safe-Op“. Restart required.
F873	„Get position timeout“ – status changes to „Safe-Op“. Restart required.
F874	“Crc memory error”– execute the RESET command (S-0-0099)
F875	“No EnDat 2.2 encoder connected”– execute the RESET command (S-0-0099)
F876	“UART Error”– execute the RESET command (S-0-0099)
F877	“Out of memory”– execute the RESET command (S-0-0099)
F879	“Callibration error”– execute the RESET command (S-0-0099)
F87A	“AX572x power supply error”– execute the RESET command (S-0-0099)
F87C	“AX572x protocol not supported”– execute the RESET command (S-0-0099)
F87D	“AX572x wrong parameter”– execute the RESET command (S-0-0099)

11.5 External Brake Resistor AX2090-BW5x

Figure	Art.-No.	Description
	AX2090-BW5x	The external brake resistors of the AX2090-BW5x series are able to convert the dynamic energy generated during braking of a servomotor into heat. The built-in temperature switch enables the system to respond immediately to any overload of the brake resistor through analysis in the AX5000 or the PLC. All brake resistors of the AX2090-BW5x-xxxx series are UL and CSA approved.

NOTE

Caution - Destruction of the equipment

The brake resistor may only be connected to individual AX5000 devices or AX5021 brake modules. It must never be used in a drive system without the AX5021 brake module, since this may lead to its destruction through overload.

NOTE

Caution - Destruction of the brake resistor and consequential damage

The built-in temperature switch must be monitored, so that the machine can be stopped in a controlled manner and switched off in the event of an overloading of the brake resistor.

11.5.1 Appropriate use

The brake resistors from the AX2090-BW5x-xxxx series are exclusively designed for direct application with an AX5000 series servo drive or the AX5021 brake module. They are designed for installation as components in electrical installations and machines together with the servo drive or the brake module, and this is their only purpose.

⚠ WARNING

Caution – Risk of injury!

Basically, electronic devices are not fail-safe. The machine manufacturer is responsible for ensuring that the connected motors and the machine are brought into a safe state in the event of a fault in the drive system.

The external brake resistors of the AX2090-BW5x-xxxx series are able to convert the dynamic energy generated during braking of a servomotor into heat. The series covers a wide continuous power and peak power range. The built-in temperature switch enables the system to respond immediately to any overload of the brake resistor through analysis in the AX5000 or the PLC. All brake resistors of the AX2090-BW5x-xxxx series are UL and CSA approved.

Improper use

The external brake resistor AX2090-BW5x-xxxx is **not** suitable for use in the following areas:

- in ATEX zones without a suitable housing
- in areas with aggressive environments (e.g. aggressive gases or chemicals)

The relevant standards and directives for EMC interference emissions must be complied with in residential areas. The servo drives may only be installed in housings and control cabinets with appropriate shielding attenuation.

11.5.2 Safety rules

The responsible staff must ensure that the application or use of the products described satisfy all the requirements for safety, including all the relevant laws, regulations and guidelines.

DANGER

Serious risk of injury through electric shock!

Due to the DC link capacitors dangerous voltage ($> 890V_{DC}$) may persist at the DC link contacts "ZK+ and ZK- (DC+ and DC-)" and "RB+ and RB-" after the servo drive has been disconnected from the mains supply. After disconnecting the servo drive wait at AX5101 - AX5125 and AX520x; 5 minutes, at AX5140/AX5160/AX5172; 15 minutes, at AX5190/AX5191; 30 minutes and at AX5192/AX5193; 45 minutes and measure the voltage at the DC link contacts ZK+ and ZK- (DC+ and DC-). The device is safe once the voltage has fallen below 50 V.

WARNING

Caution - Risk of injury through hot surfaces!

The temperature of the brake resistor housing surface may reach over 200 °C. Please ensure that the housing has cooled down below 40 °C before touching it.



UL-Listing!

It is essential to observe directives and standards if you wish to operate an AX5000 in an economic area that requires a UL-Listing.

11.5.3 Product identification

Scope of supply

The scope of delivery may vary depending on the ordered configuration. Before installing the device please ensure that all ordered components were delivered and that they are undamaged. In the event of any damage please contact the carrier immediately and document the damage.

The scope of supply always includes:

- Brake resistor of the appropriate performance class
- Technical documentation (this documentation)
- Packaging

Name plate

Figure	Pos.-No.	Description
<p>BECKHOFF Huelshorstweg 20 Phone: + 49 52 46 / 9 63 - 0 Automation GmbH & Co. KG D-33415 Verl Fax: + 49 52 46 / 9 63 - 198 Germany www.beckhoff.com info@beckhoff.com</p> <p>Catalog No. : AX2090 - BW50 - 0600 Serial No. : FZECQU 400 x 65 E No. : E212934</p> <p>1 Type power at 40° C : 600 W 2 Resistance : 47 Ω 3 Switching temperature : 180 °C</p> <p>4 Product No : 217269</p> <p>5 [Barcode]</p> <p>6 [UL US and CE logos]</p> <p>7 Made in Germany</p>	1	Type power at 40 °C
	2	Resistance
	3	Switching temperature
	4	Product no
	5	Barcode
	6	UL-Recognized Component – certification
	7	CE – certification
	8	E no.
	9	Serial no.
	10	Catalog no.

Type key

Figure	Pos.-No.	Description
<p>AX2090-BW5x-yyyy</p> <p>1 2 4 5</p> <p>3</p>	1	Drive Technology Accessories
	2	BW = brake resistor
	3	Servo drive AX5000
	4	0 = AX5000 up to 12 A rated channel current 1 = AX5118 up to AX5140 2 = AX5160 up to AX5172 3 = AX5190 up to AX5191 4 = AX5192 up to AX5193
	5	AX5000

11.5.4 Mechanical installation

11.5.4.1 Mounting positions and distances

(A) = vertical installation is only permitted according to the diagram (terminal box facing downwards).
 (B) = horizontal installation

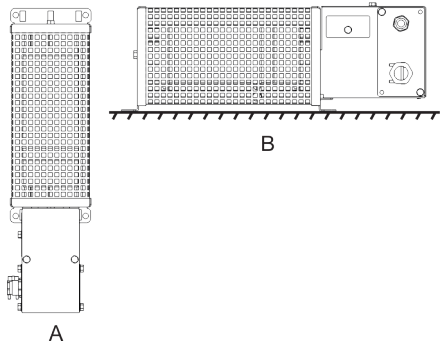
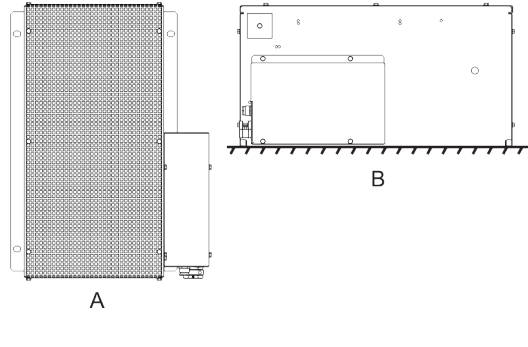
Assignment of the device classes	
 <p>A</p> <p>B</p>	 <p>A</p> <p>B</p>
AX2090-BW50-xxxx	AX2090-BW51-3000 and AX2090-BW51-6000
AX2090-BW51-1000	AX2090-BW52-3000 and AX2090-BW52-6000
	AX2090-BW53-3000 and AX2090-BW53-6000
	AX2090-BW54-3000 and AX2090-BW54-6000

For all mounting positions the following minimum distances must be adhered to:

200 mm to adjacent components, walls etc. and 300 mm to components, ceilings etc. above. If the device is installed vertically (A), the minimum distance to components, floors etc. below is 200 mm in order to allow unobstructed flow of air to the brake resistor.

11.5.5 Electrical installation

11.5.5.1 Important notes

⚠ DANGER

Serious risk of injury through electric shock!

Only staff qualified and trained in electrical engineering are allowed to wire up the brake resistors.

- Check the assignment of the servo drive and the brake resistor. Compare the rated voltage and the rated current of the devices.
- Always make sure that the brake resistors are de-energized during assembly and wiring, i.e. no voltage may be switched on for any piece of equipment which is to be connected. Ensure that the control cabinet remains turned off (barrier, warning signs etc.). The individual voltages will only be turned on again during commissioning.
- Due to the DC link capacitors, the DC link contacts "ZK+ and ZK- (DC+ and DC-)" and "RB+ and RB-" may be subject to dangerous voltages exceeding $890V_{DC}$, even after the servo drive was disconnected from the mains supply.
 Wait 5 minutes for the AX5101 - AX5125 and AX520x; 15 minutes for the AX5140/AX5160/AX5172; 30 minutes for the AX5190/AX5191; 45 minutes for the AX5192/AX5193 after disconnecting, and measure the voltage at the DC links "ZK+ and ZK- (DC+ and DC-)". The device is safe once the voltage has fallen below 50 V.

11.5.5.2 Connection the brake resistor

Remove the two screws (1) and remove the cover (2) in direction of the arrow. Connect an adequately dimensioned cable (see chapter "Cables") to the connections (3) of the resistor and the earthing stud (5) and take it out of the terminal box through the strain-relief assembly (9). Ensure adequate strain relief with the two screws (8). Connect the other side of the cable to the DC link contact connector "X2" of the AX5000. The connector is supplied with the AX5000. Connect the earthing cable to the earthing conductor of the control cabinet.

Connect an adequately dimensioned cable to the potential-free N/C contact (4) of the temperature switch and take it out of the terminal box through the strain-relief assembly (7) (see chapter "Temperature switch"). Ensure adequate strain relief with the nut (6).

Install the cover (2) in reverse order.

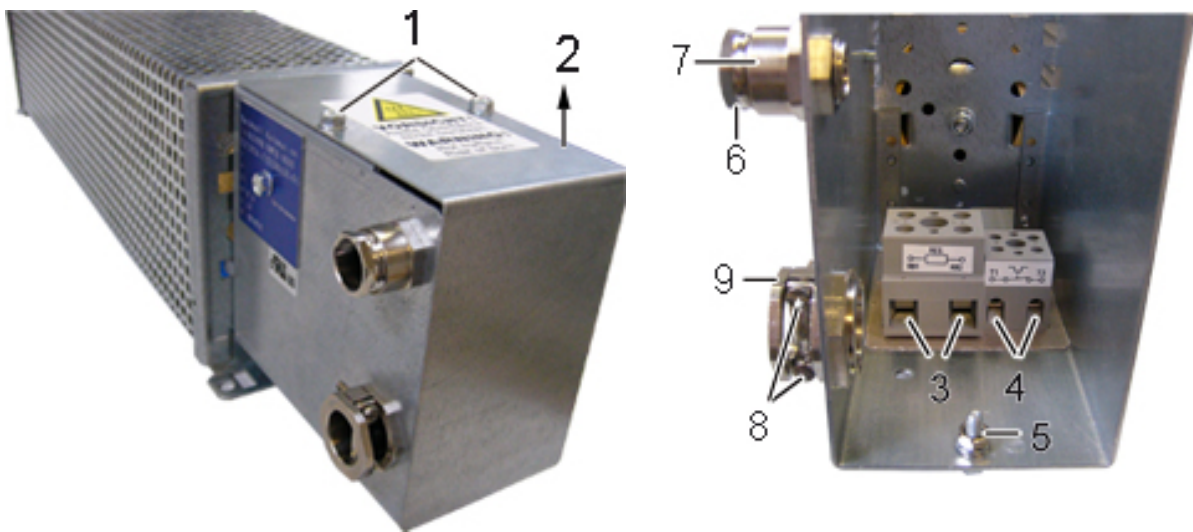

11.5.5.3 Cables

Beckhoff offers pre-assembled cables for safe, faster and flawless installation of the motors. Beckhoff cables have been tested with regard to the materials, shielding and connectors used. They ensure proper functioning and compliance with statutory regulations such as EMC, UL etc. The use of other cables may lead to unexpected interference and invalidate the warranty.

WARNING

Caution - Fire hazard!

The brake resistors can reach temperatures of almost 200 °C. Therefore, ensure adequate thermostability of the cables! Cables with inadequate thermostability can cause a cable fire!

NOTE

EMC safety

Use only shielded cables.

Type	Brake resistor		Temperature switch	
	[mm ²]	[AWG]	[mm ²]	[AWG]
AX2090-BW50-0300	1,5	16	0.75	18
AX2090-BW50-0600	1,5	16	0.75	18
AX2090-BW50-1600	1,5	16	0.75	18
AX2090-BW51-1000	2,5	12	0.75	18
AX2090-BW51-3000	2,5	12	0.75	18
AX2090-BW51-6000	2,5	12	0.75	18
AX2090-BW52-3000	4,0	12	0.75	18
AX2090-BW52-6000	4,0	12	0.75	18
AX2090-BW53-3000	6,0	12	0.75	18
AX2090-BW53-6000	6,0	12	0.75	18
AX2090-BW54-3000	6,0	12	0.75	18
AX2090-BW54-6000	6,0	12	0.75	18

We recommend wire end sleeves.

11.5.5.4 Temperature switch

NOTE	
Destruction of the brake resistor!	
The temperature switch is exclusively used for temperature monitoring. The brake resistor is not switched off.	

The temperature switch has a potential-free N/C contact, which enables immediate response to any overload of the brake resistor through analysis in the AX5000 or the PLC. Connect the cable directly to a free input of plug "X06". Then parameterize it such that the AX5000 stops the motor(s) with an emergency ramp or the PLC reads and processes this input.

Type	Switching temperature	Switching current 24 VDC or 230 VAC
	[°C]	[A]
AX2090-BW50-0300	180	2
AX2090-BW50-0600	180	2
AX2090-BW50-1600	180	2
AX2090-BW51-1000	180	2
AX2090-BW51-3000	85	2
AX2090-BW51-6000	85	2
AX2090-BW52-3000	85	2
AX2090-BW52-6000	85	2
AX2090-BW53-3000	85	2
AX2090-BW53-6000	85	2
AX2090-BW54-3000	85	2
AX2090-BW54-6000	85	2

11.5.5.5 Short-term capacity

Brake resistors are usually not operated continuously, but only exposed to short-time duty. In the following section the permitted short-term capacity is calculated based on the continuous power, overload factor and duty cycle.

11.5.5.5.1 Duty cycle

The duty cycle is a relative value that depends on the switch-on time (t_{on}) and the cycle time. Cycle times up to 120 sec. are used directly in the calculation. Should the cycle time exceed 120 sec., the maximum relevant cycle time of 120 sec. is used in the calculation.



$$\text{duty cycle} = \frac{t_{on}}{\text{Cycle time}} \times 100 \%$$

Sample 1

$T_{on} = 60 \text{ s}$
 Cycle time = 280 s
Duty cycle = 50%

Sample 2

$T_{on} = 40 \text{ s}$
 Cycle time = 100 s
Duty cycle = 40 %

Further information of external brake resistors:

i For further information on the configuration and diagnostics of external brake resistors, please refer to the function description of the servo drive AX5000: "Diagnostic of external brake resistors".

11.5.5.2 Overload factor

AX2090-BW51-3000 and AX2090-BW51-6000
 AX2090-BW52-3000 and AX2090-BW52-6000
 AX2090-BW53-3000 and AX2090-BW53-6000
 AX2090-BW54-3000 and AX2090-BW54-6000

AX2090-BW50-xxxx and AX2090-BW51-1000

Overload factor depending on duty circle

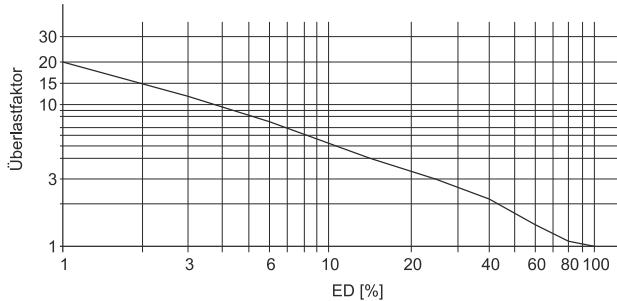

Overload factor depending on duty circle

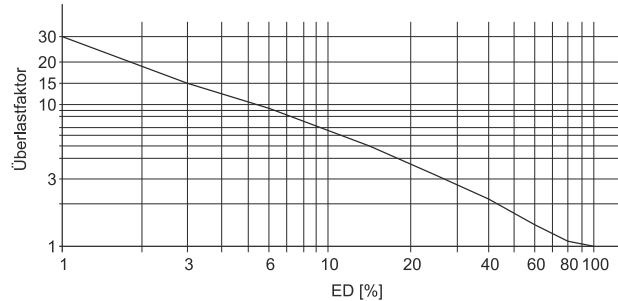

Calculation formula

Short-term capacity = continuous power x overload factor

11.5.5.6 Overtemperature and continuous power at 100% duty cycle

If your application requires a higher continuous power than the specified nominal capacity, you can accept this state if a higher brake resistor temperature is permitted. The following diagram shows the overtemperature v. the continuous power.

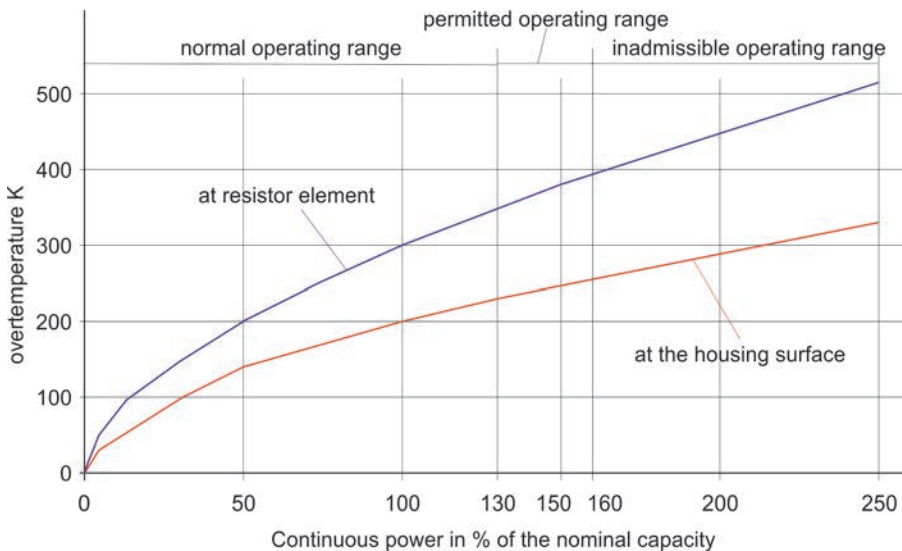

Normal operating range, max. 130%	Permitted operating range, max. 160%	Inadmissible operating range, more than 160%
This operating range is recommended for maximum service life and error-free operation.	This operating range is still permitted, although it results in shorter service life with higher failure probability	In this operating range there is a risk of destruction of the brake resistor through overheating. Due to the high temperatures the adjacent components are also at risk.

NOTE

Destruction of the brake resistor and adjacent components
 Always ensure adequate ventilation of the brake resistor, since the temperatures of the housing surface may exceed 200 °C.

11.5.6 Technical data

Dimensions

Type ¹⁾	Type power [W] * at 40 °C	Resistance [Ω]	O [mm]	R [mm]	H [mm]	M [mm]	U [mm]	Weight [kg]	AX5000
AX2090-BW50-0300	300	47	349	92	120	230	64	2	AX5x01-AX5112
AX2090-BW50-0600	600	47	549	92	120	430	64	3	AX5x01-AX5112
AX2090-BW50-1600	1600	47	649	185	120	530	150	5,8	AX5x01-AX5112
AX2090-BW51-1000	1000	23	749	92	120	630	64	4	AX5118-AX5140
AX2090-BW51-3000	3000	23,4	490	355	255	380	270	8	AX5118-AX5140
AX2090-BW51-6000	6000	23,2	490	455	255	380	370	12	AX5118-AX5140
AX2090-BW52-2000	3000	13,2	490	355	255	380	270	8	AX5160-AX5172
AX2090-BW52-6000	6000	13,0	490	455	255	380	370	12	AX5160-AX5172
AX2090-BW53-3000	3000	10,2	490	355	255	380	270	8	AX5190-AX5191
AX2090-BW53-6000	6000	10	490	455	255	380	370	12	AX5190-AX5191
AX2090-BW54-3000	3000	6,6	490	355	255	380	270	8	AX5192-AX5193
AX2090-BW54-6000	6000	6,5	490	455	255	380	370	12	AX5192-AX5193

*) 4% decrease in performance per 10K temperature difference

¹⁾ All external brake resistor have the protection class IP20

Technical drawings

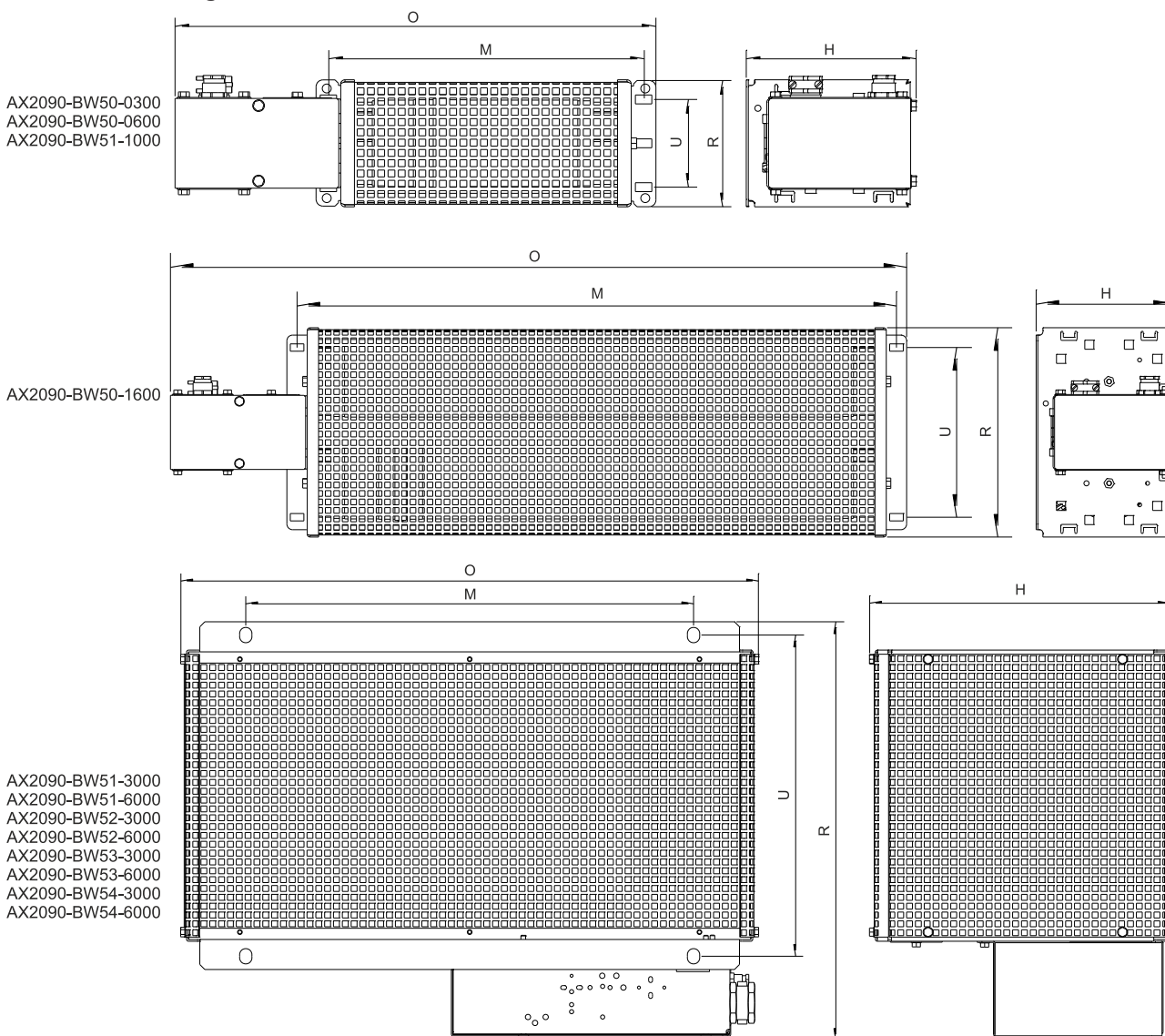

11.6 Cables

11.6.1 General specification

Wire cross-section depending on the cable length (according to EN60402)

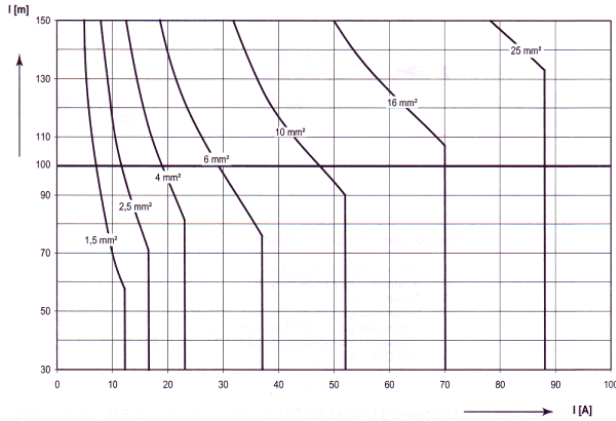

Beckhoff offers pre-assembled motor and feedback cables for faster and flawless installation. Design, dimensioning and installation have significant influence on the function of a servo system. Beckhoff servo cables have been tested with regard to the material used, shielding and connection, in order to guarantee proper function and compliance with statutory requirements such as EMC. The use of other may invalidate the warranty.

11.6.1.1 Line load for different types of installation

⚠ WARNING

Fire hazard!

If several servo drives are operated at the same time the resulting total current of the configuration must be taken into account for dimensioning of the cables. The information provides in this section should be re-garded as guidance. It is not intended as a substitute for professional design based on the specific application.

Cable cross-section		Three-core non-metallic sheathed cable or conduit	Three-core non-metallic sheathed cable, stacked on wall	Three-core non-metallic sheathed cable, side by side, horizontal
[mm ²]	[AWG]	[A]	[A]	[A]
1.5	16	12.2	15.2	16.1
2.5	12	16.5	21.0	22
4	10	23	28.0	30
6	10	29	36.0	37
10	8	40	50.0	52
16		53	66.0	70
25		67	84.0	88
35		83	104.0	114

Line load according to EN60204-1, Table 5, at an ambient temperature of 40°C

The cable descriptions can be found on the Beckhoff website at <http://www.beckhoff.de/motion/documentation>.

11.6.2 Order key for motor and feedback cables

Z K 4 t u v - w w x y - z z z z				
t	Servo drive series	5	=	AX5000
u	Function	0	=	Motor cable
		1	=	Encoder cable EnDat, Hiperface, BiSS
		2	=	Encoder cable Sin/Cos with zero pulse
		3	=	Resolver cable
		4	=	Temperature cable AL2000
		5	=	Hall cable for AL2000
v	Function	0	=	Motor - drive
		1	=	Extension cable
		2	=	Motor – choke (only AM3000 cable)
		4	=	Motor - other side The free end is fitted with wire end sleeves
		5	=	Drive - other side The free end is fitted with wire end sleeves
		9	=	Raw material
ww	Motor series	0 0	=	AL2000/AM2000/AM3000/AM3500
		01 to 19	=	Beckhoff
		80 to 89	=	Beckhoff
		20 to 29	=	Alpha EnDat / Alpha resolver
		30 to 39	=	Lenze
		40 to 49	=	SEW
		50 to 59	=	Siemens
		60 to 79	=	Further
x	Quality	90 to 99	=	Further
		0	=	fixed installation / no motion
		1	=	dynamic / drag chain
		2	=	high dynamic / high-speed chain
		6	=	high torsion cable
y	Cross-section [mm²]	0	=	Feedback
		1 to 8	=	0.75=1 / 1.0=2 / 1.5=3 / 2.5=4 / 4.0=5 / 6.0=6 / 10=7 / 16=8
		9	=	special
		90	=	25
		91	=	35
		92	=	50
z z z z	Length in dm			
	applies only if Y ≠ 9	0001 to 9999	=	1 to 1000 m
	applies only if Y > 9	_001 to _999	=	1 to 100 m

11.6.3 SEW motors from the “DFS / CFM” range with stopping brake

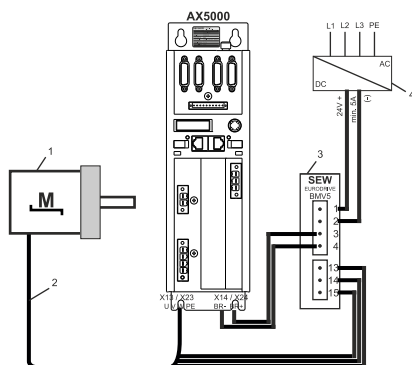

The stopping brake of the SEW motors has to be connected via a brake rectifier, to guarantee the “quick activation of the brake”. A 3 wire connection cable is required for this. The following schematic diagram shows the correct connections of the motors to the AX5000.

- SEW servo motor of the DFS/ CFM range (1)
- Motor brake cable ZK4500-4xxx (2)
- SEW- BMV5 brake rectifier (3)
- Power supply unit with 5A minimum output current (4)

11.6.4 Special motor connections

11.6.4.1 Linear motors of the AL2xxx series

11.6.4.1.1 Installation

⚠ WARNING

Caution – Risk of injury through electric shock!

Remove the motor and feedback lines from the connector box to the servo drive when you open the connector-box.

● Attaching the connector box!

i The linear motor cables are not for trailing cables, hence the connector box has to be fixed on the moving part of the linear motor.

Unscrew the cover and fix the connector box with 2 M4 screws on the carriage of the linear motor.

Motor cable:

Strip the wires of the motor cable and fit wire end sleeves. Twist the screen of the motor cable and solder on a cable with a minimum diameter of 1.5 mm². Fit wire end sleeves or a cable lug to the free end. Place the nut of socket “A” over the motor cable and feed the wires through the socket “A” in the box and screw the nut onto socket “A”. Fit the shielded and PE cables with a “PE” connection and the power wires on connection “X1”.

Encoder cable:

Strip the wires of the encoder cable and fit wire end sleeves. Twist the screen of the encoder cable and solder on a cable with a minimum diameter of 0.75 mm². Fit wire end sleeves or a cable lug to the free end. Place the nut of socket “B” over the encoder cable and feed the wires through the socket “B” in the box and screw the nut onto socket “B”. Fit a “PE” connection to the shielded cable. Wire the signal wires to the “X2” connection as per the table.

Connection pin	Signal description	MES AL2200	LIKA SMS-V1	SIKO LE100	NJ* LIA 1 Vss
X1-PE	PE / GND	shield	shield	shield	wh / gn
X2-1	COS -	red	orange	green	red
X2-2	GND	white	black	black	white
X2-3	SIN -	yellow	blue	orange	yellow
X2-4	+ 5V DC	brown	red	brown	brown
X2-5	DATA + / Z +	---	white	blue	grey
X2-6	n.c.	---	---	---	---
X2-7	PTC	---	---	---	---
X2-8	Clock+	---	---	---	---
X2-9	COS +	blue	green	yellow	blue
X2-10	GND sense	grey	---	---	---
X2-11	SIN +	green	yellow	red	green
X2-12	+ 5V sense	pink	---	---	---
X2-13	DATA - / Z -	---	---	violet	pink
X2-14	PTC	---	---	---	---
X2-15	Clock-	---	---	---	---

Thermal protection cable:

Strip both wires of the thermal protection contact cable and fit wire end sleeves. Twist the screen of the thermal protection contact cable and solder on a cable with a minimum diameter of 0.75 mm². Fit wire end sleeves or a cable lug to the free end. Place the nut of socket “C” over the thermal protection contact cable and feed the wires through the socket “C” in the box and screw the nut onto socket “C”. Fit a “PE” connection to the shielded cable. Fit both thermal protection contact wires to contacts “7” and “14” of connection “X2”. Retighten the connector box cover.

11.7 Motor chokes AX2090-MD50

Figure	Art.-No.	Description
	AX2090-MD50-0012 motor choke for AX5000 (1.5...12 A), necessary for motor cable ≥ 25 m, up to 12 A rated current, necessary for motor cable ≥ 25 m, max. 100 m, with integrated connection cable (150 mm)	A motor choke must be installed between the AX5000 and the motor from a certain motor cable length onwards. The motor choke reduces the commutation current flowing via the screen back into the AX5000 to a permissible value and can also provide a solution to EMC problems.
	AX2090-MD50-0025 motor choke for AX5000 (18...25 A), up to 25 A rated current, necessary for motor cable ≥ 25 m, max. 50 m, with integrated connection cable (150 mm)	

11.7.1 Electrical connection

The motor chokes are connected based on the "plug & play" principle. Pull the two plug connectors from the existing motor cable of the AX5000 and plug them into the sockets of the motor choke. The two plugs of the integrated motor choke cable are then plugged into the socket of the AX5000.

⚠ WARNING

Caution - Risk of injury through electric shock!

De-energize all electrical components (servo drive, control cabinet etc.) before commencing the installation or deinstallation of the motor choke.

● Connection cables

i Use exclusively Beckhoff motor cables and firmly tighten the connecting plugs. Max. tightening torque - M4 thread = 1.5 Nm \pm 0.1 Max. tightening torque - M3 thread (motor connector) = 0.6 Nm \pm 0.1.

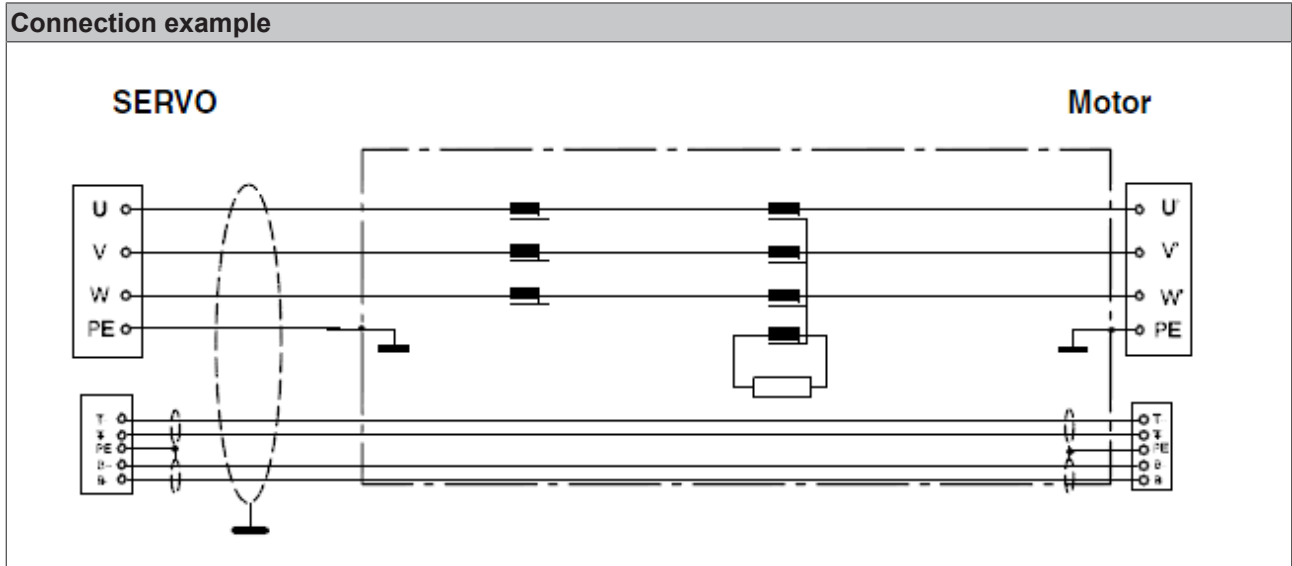

11.7.2 Technical data

Rated motor current	Motor cable length	Servo Drives	Motor choke
max. 400 V	>20 m to 100 m	AX5101, AX5103, AX5106, AX5112, AX5201, AX5203, AX5206	AX2090-MD50-0012
max. 480 V	>20 m to 100 m		
max. 400 V	>20 m to 50 m	AX5118 and AX5125	AX2090-MD50-0025
max. 480 V	>20 m to 50 m		

Data	AX2090-MD50-0012	AX2090-MD50-0025
Rated voltage	480 V AC	480 V AC
Rated frequency	0 - 60 Hz	0 – 60 Hz
Test voltage cable/cable for 2 s	1770 V DC	1770 V DC
Test voltage cables/housing for 2 s	2700 V DC	2700 V DC
Rated temperature	50 °C	50 °C
Inductance	0.2 mH	0.12 mH
Continuous load operation (S1)	12 A	25 A
Climate category (IEC 60068-1)	25/100/21	25/100/21
Approval	UL 1283	UL 1283
Resistance [type]	25 mΩ	15 mΩ
Power loss	5 - 25 W ¹⁾³⁾	10 -35 W ²⁾⁴⁾
Weight	2.9 kg	8.5 kg

¹⁾rated current 1 - 12 A

²⁾rated current 18 – 25 A

³⁾measured at max. cable length of 100 m

⁴⁾measured at max. cable length of 50 m

Insertion attenuation (reference value $Z = 50 \Omega$)

- unsymmetrisch, Abschluss der Nachbarzweige
- · - · asymmetrisch, alle Zweige parallel (common mode)
- - - symmetrisch (differential mode)

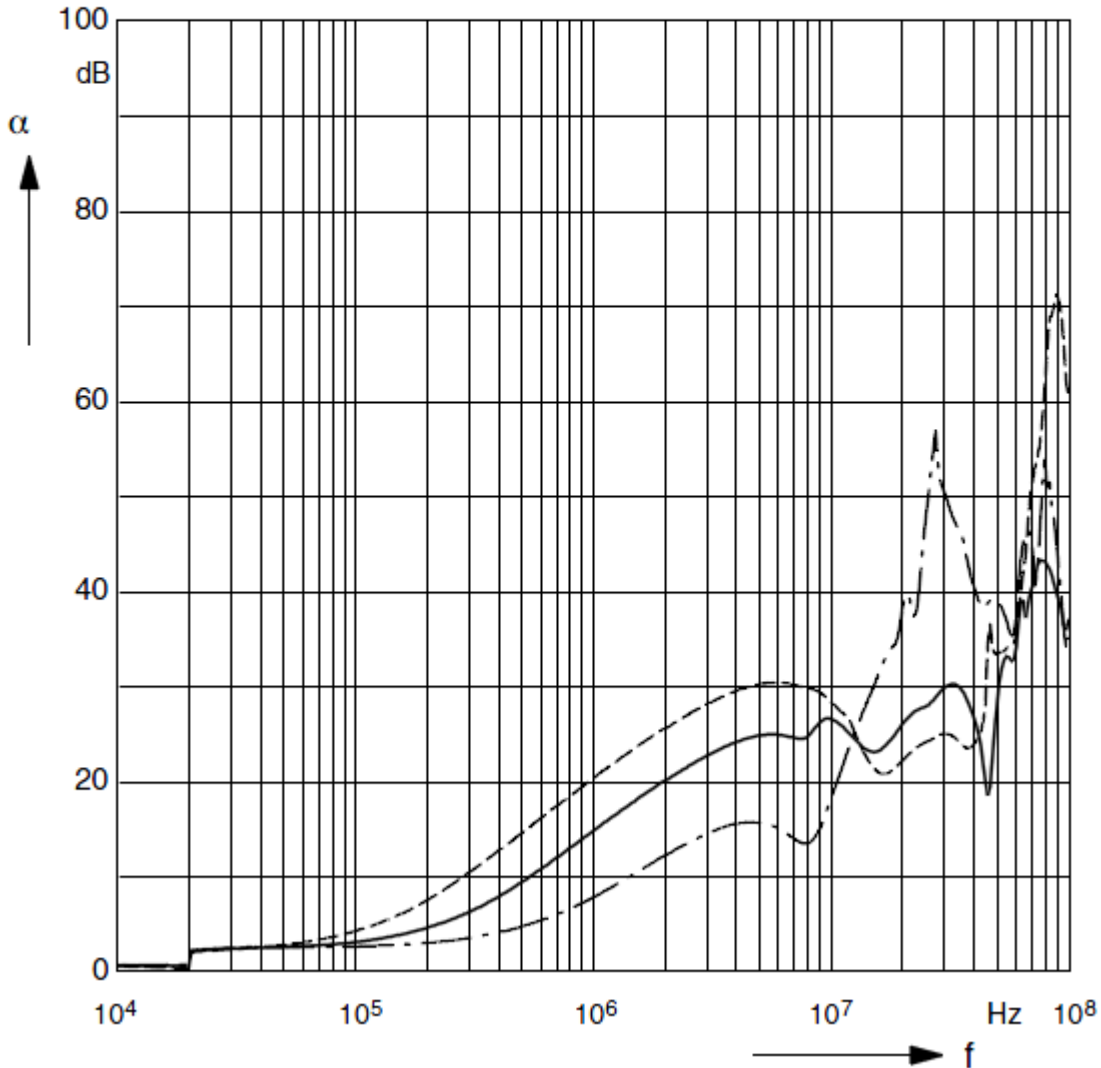

11.7.3 Installation of the motor choke AX2090-MD50-0012

⚠ CAUTION

Destruction of the motor choke!

- Always install the motor choke vertically on an earthed metallic mounting plate. If no metallic mounting plate is available, you must earth the motor choke; an earthing bolt is provided on the motor choke for this purpose.
- Ensure adequate ventilation of the motor choke. The permissible ambient conditions are specified in the chapter "Technical data".
- It is essential to maintain the necessary distances to the AX5000 (see sketches below).

The motor chokes for the AX5000 (a) with a max. rated channel current of 12 A are bolted to the mounting plate (d) below the device.

'Figure 1' shows a motor choke (b) for one channel.

In the case of 2-channel devices, the motor chokes are bolted on top of one another; see 'figures 2 and 3'. The spacer (e) is supplied with the motor choke.

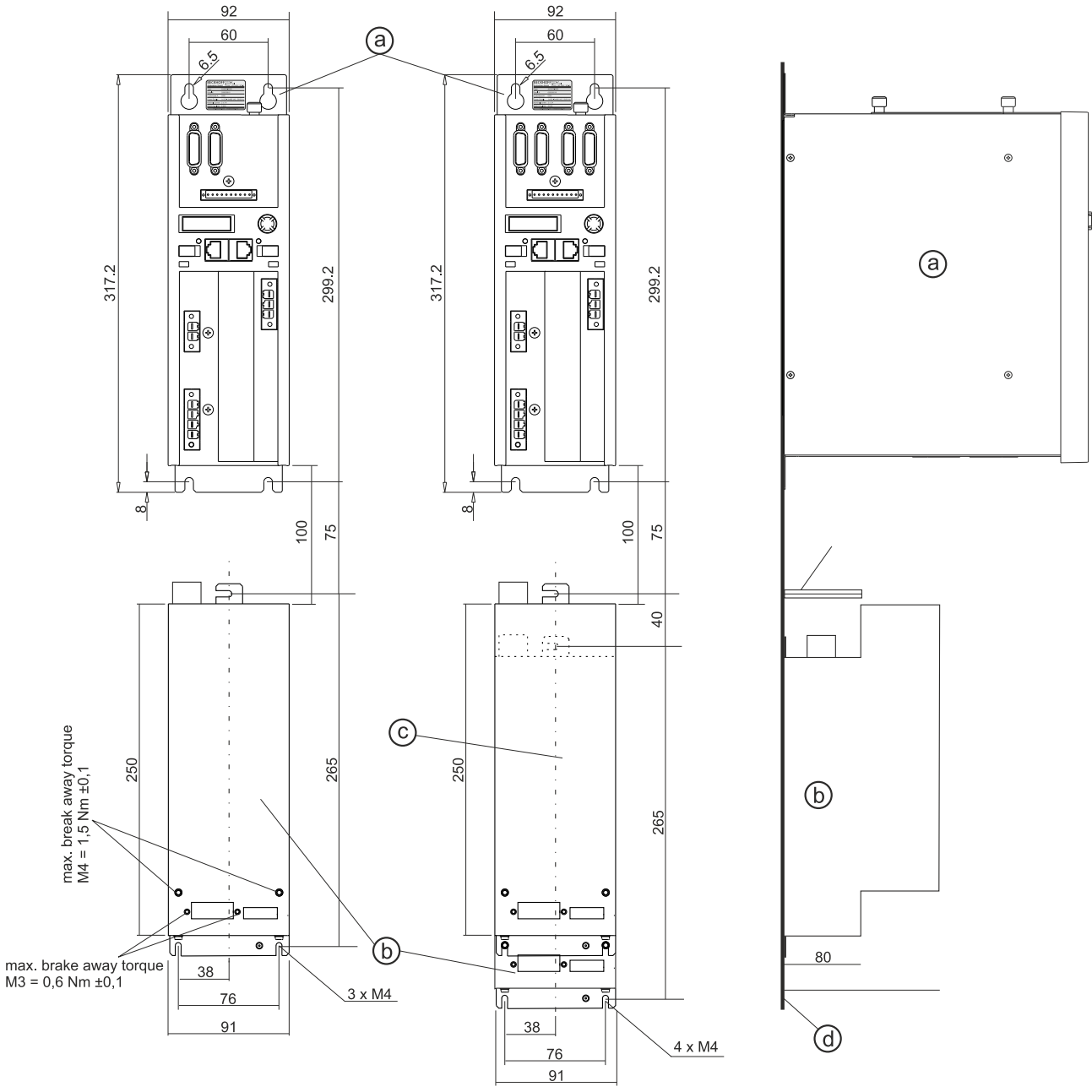
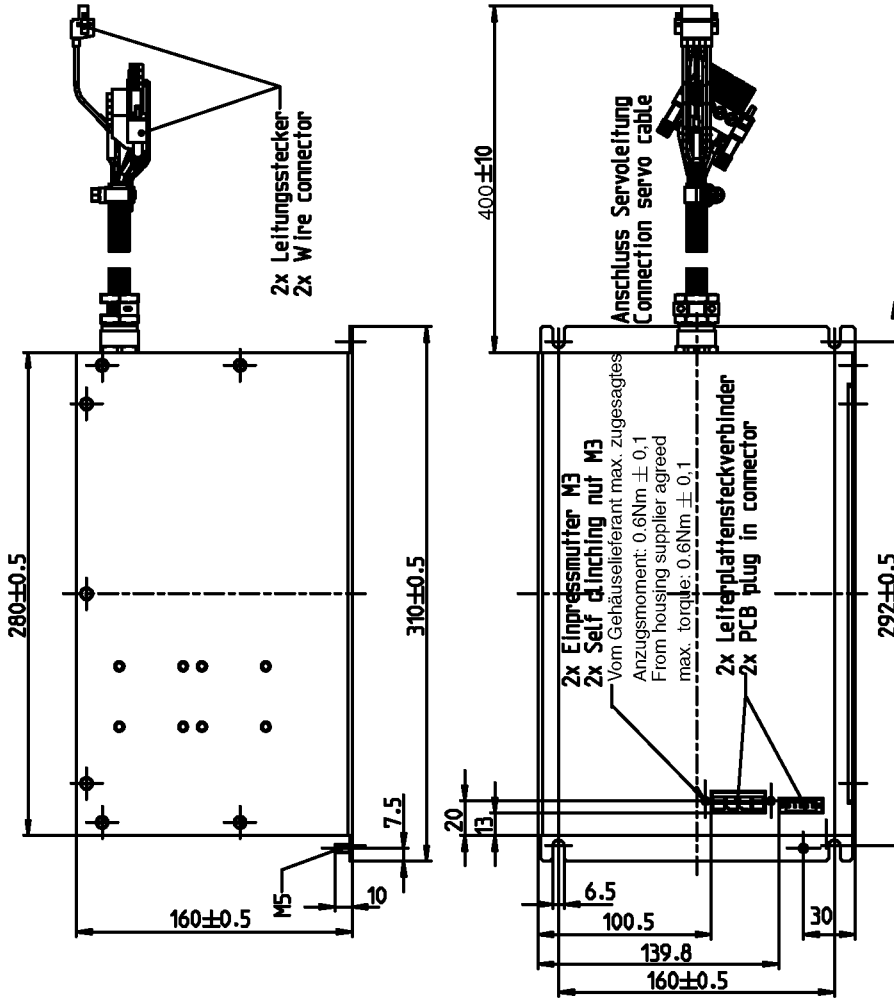

Figure 1

Figure 2

Figure 3

11.7.4.2 AX2090-MD50-0025



Alle Maßangaben in mm
ALL dimensions in mm

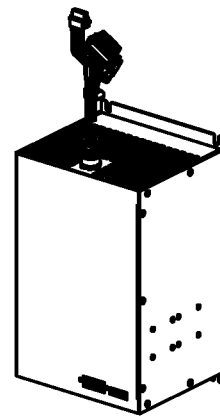
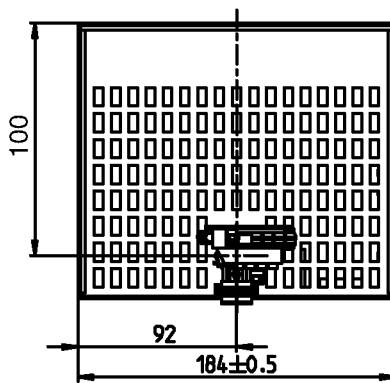
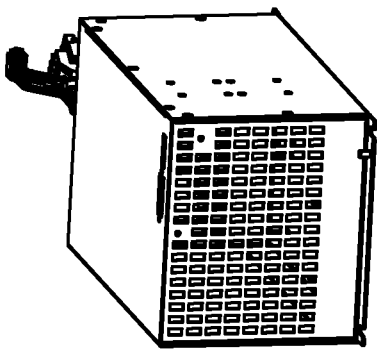

11.8 Mains choke AX2090-ND50

11.8.1 Technical data

Environmental conditions	Three-phase mains chokes AX2090-ND50
Rated voltage	3 x 460 V, -25% +10%, 50/60 Hz ¹⁾
Overload factor	2.0 x I _N for 30 s
Ambient temperature	-25 °C to +45 °C, with 1.3% (/°C) power derating to +60 °C
Mounting height	1000 m, with 6% (/1000 m) power derating to 4000 m
Relative humidity	15%...95%, condensation not permitted
Storage temperature	-25 °C to +70 °C
Protection class	IP00
Short-circuit voltage	UK 4% at 400 V = 9.24 V UK 2 % at 400 V = 4.6 V
Permissible level of contamination	P2 according to EN 61558-1
Thermal configuration	I _{eff} < I _N
Material	The AX2090-ND50 devices are UL-certified for the US and Canadian markets

¹⁾ at 60 Hz mains frequency the power loss is approx. 10% higher!

Three-phase mains chokes

Data	AX2090-ND50-					
	0060	0072	0090	0110	0143	0170
Rated current [A]	60	72	90	110	143	170
Power loss [W]	70	80	120	140	160	170
Inductance [mH]	0.25	0.20	0.16	0.13	0.10	0.09
Weight [kg]	7	10	13	15	25	25
Connection [mm ²]	16	16	35	35	70	70
Short-circuit voltage	4 % U _K					

11.8.2 Installing the mains chokes

⚠ WARNING

Caution - Risk of injury through electric shock!

De-energize all electrical components (servo drive, control cabinet etc.) before commencing the installation or deinstallation of the mains choke.

⚠ WARNING

Caution - risk of injury through high voltages!

Mains chokes contain components that can store electrical charge. Wait 10 minutes after disconnecting the mains chokes and measure the voltage on conductors L1 to L3. You can ensure safe working by letting the voltage drop below 50 V.

⚠ CAUTION

Beware of improper earthing!

Ensure proper earthing during installation of the mains chokes. The installation should take place on a mounting plate (chromated / galvanized) suitable for earthing.

11.8.2.1 Circuit diagram and installing

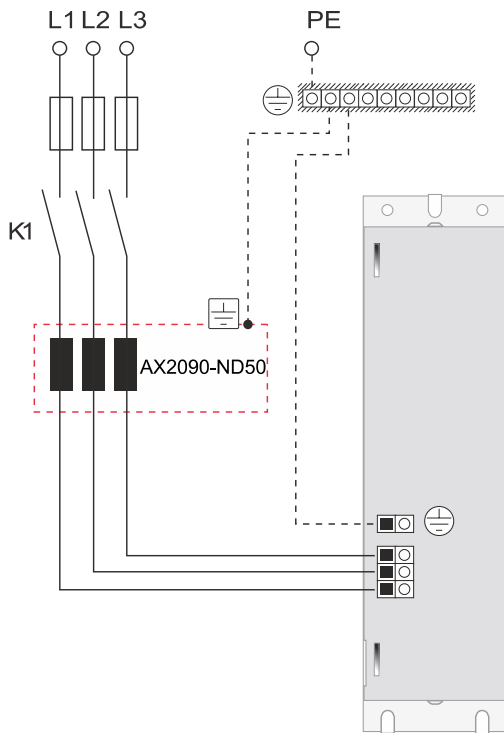

Assembly sequence:

- Position the mains choke on the mounting surface.
- Mark the positions of the thread holes on the mounting surface.
- Centre and drill the thread holes. Then cut the threads in the holes.
- Secure the mains choke on the mounting surface with suitable screws.

Connection:

- Connect the protective conductor connection of the mains choke with the PE rail.
- Connect the connecting cable of the mains choke to the appropriate terminals of the servo drive.
- Connect the mains choke to the supply network.

⚠ DANGER

Serious risk of injury!

Due to the DC link capacitors dangerous voltage ($> 890V_{DC}$) may persist at the DC link contacts “ZK+ and ZK-“and “RB+ and RB-“ after the servo drive has been disconnected from the mains supply. After disconnecting the servo drive wait at AX5160/AX5172; 15 minutes, at AX5190/AX5191; 30 minutes and at AX5192/AX5193; 45 minutes and measure the voltage at the DC link contacts ZK+ and ZK-. The device is safe once the voltage has fallen below 50 V.

11.8.2.2 Dimensional drawing

	AX2090-ND50-					
Dimension [mm]	0060	0072	0090	0110	0143	0170
B (Wigth)	190	190	230	230	240	240
H (Height)	200	240	300	300	330	330
T (Depth)	120	110	160	180	200	200
A	170	170	180	180	190	190
C	68	78	98	122	125	125
D	8	8	8	8	11	11

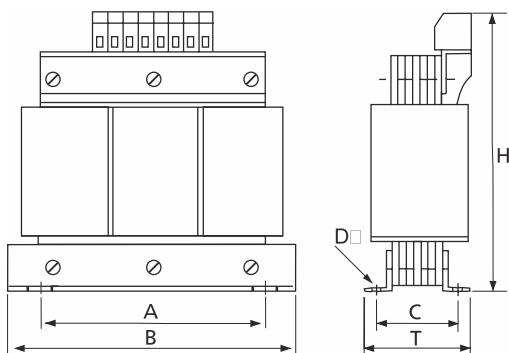

11.9 Mains filter - AX2090-NF50

11.9.1 Technical data

Data	AX2090-NF-50-					
	0014	0032	0063	0100	0150	0180
Rated voltage [V _{AC}]	480					
Rated frequency [Hz]	50 / 60					
Rated current [A]	14.6	32.8	63	100	150	180
Voltage cable/cable for 2 sec. [V _{DC}]	2236		--	--	--	--
Voltage cable/housing for 2 sec. [V _{DC}]	2720		--	--	--	--
Rated temperature [°C]	50		40			
Climate category (IEC 60068-1)	25/100/21		--	--	--	--
Resistance [mΩ]	9	4	--	--	--	--
Leakage current [mA]	15		6.8	9.8		
Overload capability (thermal)	1.5 x Rated current for 3 min per hour or 2.5 x Rated current for 30 s per hour					
Weight [kg]	0.9	1.75	5.0	6.0	6.8	7.0
Approvals	EN 133200, UL 1283, CSA C22.2 No.8		--	--	--	--

11.9.2 Installing the mains filter

⚠ WARNING

Caution - Risk of injury through electric shock!

De-energize all electrical components (servo drive, control cabinet etc.) before commencing the installation or deinstallation of the mains filter.

⚠ WARNING

Caution - Risk of injury through electric shock!

Mains filters contain components that can store electrical charge. Wait 5 minutes after disconnecting the filters and measure the voltage on conductors L1 to L3. The device is safe once the voltage has fallen below 50 V.

⚠ CAUTION

Personal injuries!

When installing the mains filter, the protective earth cables must be connected first as a matter of principle. They must be disconnected last when deinstalling. Depending on the size of the leakage current, the special regulations for the implementation of the protective earth connection must be observed. Minimum requirement for the protective conductor KU-value ¹⁾ = 4.5 for leakage currents $I_L < 10 \text{ mA}$ or $KU = 6$ for $I_L > 10 \text{ mA}$.

¹⁾ The KU-value is a variable for the classification of safety-related types of failure for protection against dangerous shock current and excessive heating. A value of $KU = 4.5$ in relation to interruption is attained:

- with a permanently attached protective conductor $\geq 1.5 \text{ mm}^2$
- for protective conductor connection $\geq 2.5 \text{ mm}^2$ with plug connector for industrial systems (IEC 60309-2).

$KU = 6$ in relation to interruption is attained with permanently connected conductors $\geq 10 \text{ mm}^2$, wherein the type of connection and routing must comply with the standards applicable to PEN conductors.

NOTE

Destruction of the mains filter

The mains filters must be protected by means of an appropriate overcurrent protection device against the impermissible exceeding of the rated current.

11.9.2.1 Circuit diagram

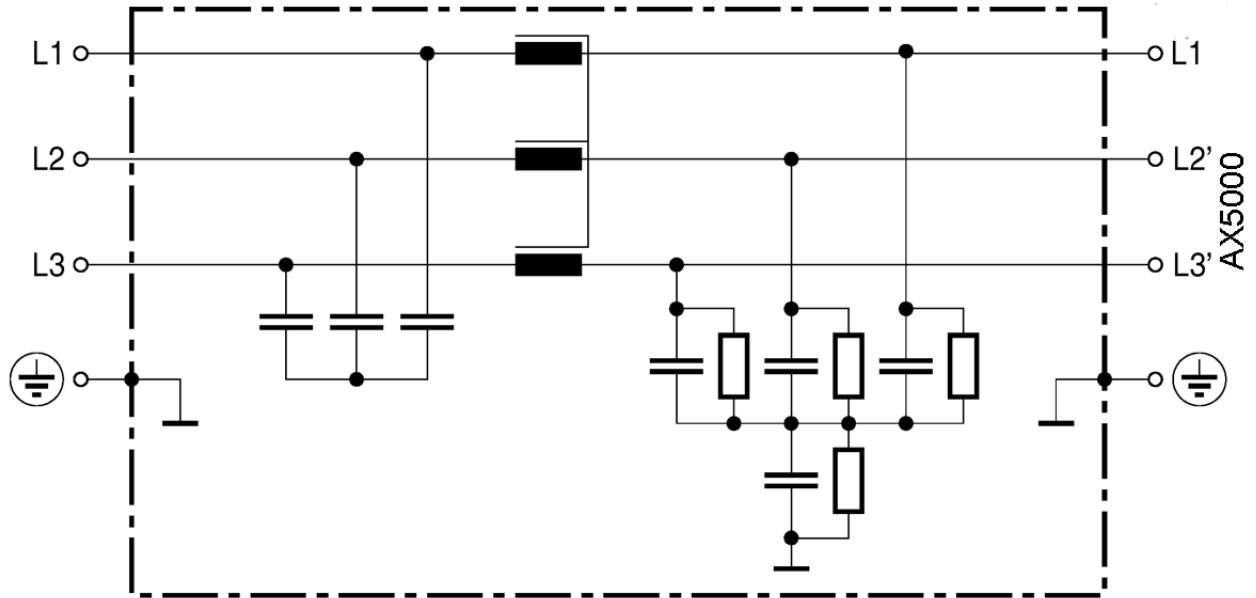

Connection cables

The length of the connecting cable from the mains filter to the AX5000 must not exceed 0.4 m. Use exclusively shielded connecting cables.

11.9.2.2 Dimensions and dimensional drawings

	AX2090-NF50-					
Dimensions	0014	0032	0063	0100	0150	0180
B1 [mm]	38 _{-0.3}	35 _{-0.3}	40	45	60	180
B2 [mm]	46.4	58	62	75	90	200
B3 [mm]	Ø 4.5		Ø 7			Ø 8.5
H1 [mm]	70	90	180	200	220	120
H2 [mm]	1.5		--	--	--	--
K [mm ²]	4	10	0.6-16	16-50	35-95	Busbars
K1 [mm]	--	--	--	--	--	45
K2 [mm]	--	--	--	--	--	86
K3 [mm]	--	--	--	--	--	91
L1 [mm]	200		240	250	280	160
L2 [mm]	231	265	280	290	320	310
L3 [mm]	221 _{-0.5}	255 _{-0.5}	270		300	180
L4 [mm]	--	--	305	336	380	410
PE1 [mm]	60	70	--	--	--	30
PE2 [mm]	9	8	--	--	--	--
PE [mm ²]	M5		M6	M8		M10
T [Nm]	0.5 – 0.6	1.2 – 1.5	--	--	--	--

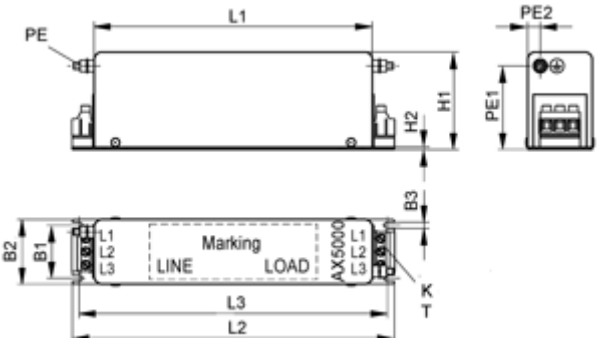
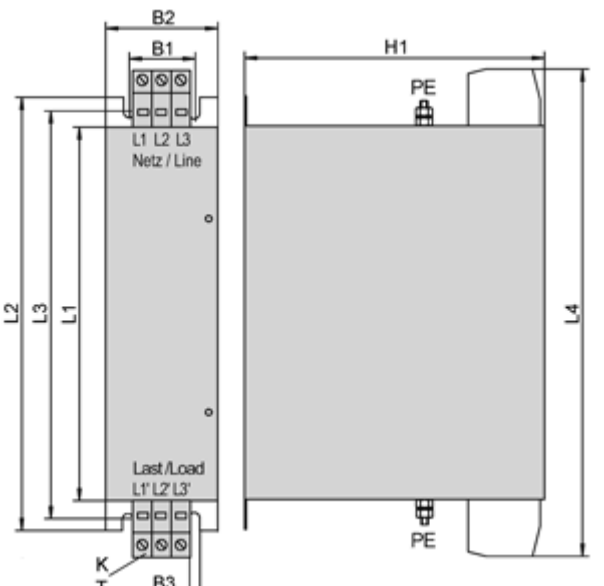
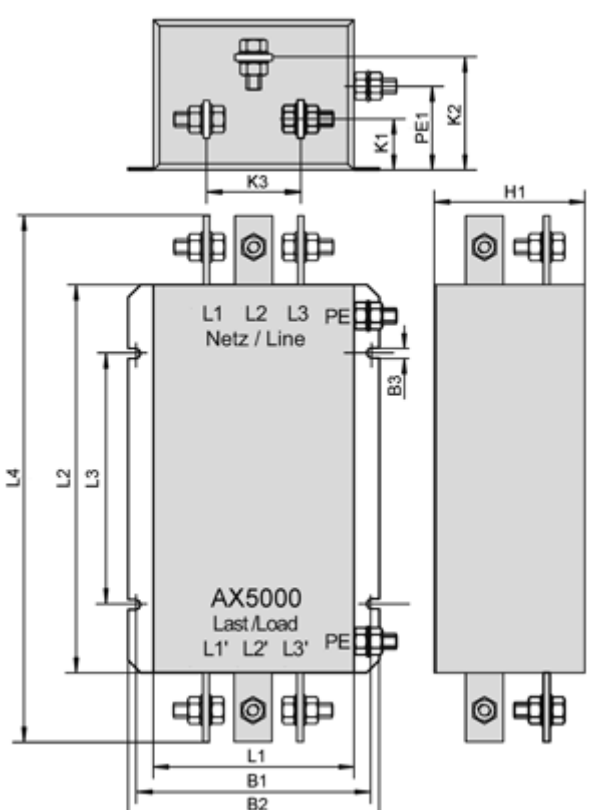
Figure	Mains filter
	<p>AX2090-NF50-0014 AX2090-NF50-0032</p>
	<p>AX2090-NF50-0063 AX2090-NF50-0100 AX2090-NF50-0150</p>
	<p>AX2090-NF50-0180</p>

11.10 Transient voltage suppressor - AX2090-TS50

Figure	Art.-No.	Description
	AX2090-TS50-3000	The Beckhoff transient box of the series AX2090-TS50 enables voltage peaks, by means of switching operations in electrical circuits or by electrostatic discharges to be recorded.

11.10.1 Guidelines and Standards

11.10.1.1 Appropriate use

The AX2090-TS50-3000 transient boxes are accessory components for the AX5000 servo drive series. They are specifically designed for the Canadian market, to protect supply networks from overvoltages and to absorb current peaks.

The AX2090-TS50-3000 transient boxes are always installed as control cabinet components and may only be commissioned as integrated system components.

⚠ WARNING

Caution - Risk of injury!

Electronic equipment is not fail-safe. The machine manufacturer is responsible for ensuring that the connected motors and the machine are brought into a safe state in the event of a fault in the drive system.

The transient boxes may only be operated in closed control cabinets, under the conditions described in the "Technical data [[▶ 264](#)]" section.

11.10.1.2 CSA approval

The AX2090-TS50-3000 transient box series was approved by the American UL certification authority for the Canadian market, in accordance with the standards and guidelines applicable in Canada.

	<p>Transient box with CSA approval: AX52090-TS50-3000 – certified according to CAN / CSA C22.2 no. 274.</p>
---	--

The cRU logo should be shown on the name plate. If you wish to operate an AX2090-TS50-3000 in Canada, please check whether the name plate shows the cRU logo.

11.10.2 Technical data

This section contains general technical data and ordering information for the Beckhoff AX2090-TS50-3000 transient box. See below for name plate information (technical approvals, certifications, mains supply, etc.).

AX2090-TS50-3000	
Electrical data	
Rated input voltage [V _{AC}]	100 – 480
Max. pulse peak current [A]	3000 at 25 °C
Power derating	20% at 50 °C
Transient protection	Fuse AX3-430C or similar according to E128662

AX2090-TS50-3000	
Mechanical data	
Material	Housing: Cast aluminum Cover: Cast aluminum with CR foam rubber perimeter seal
Surface	Textured paint
Color	RAL 7001
Ambient temperature [°C]	-25 to +85
IP protection class	IP 66 (closed state) according to IEC 60 529
NEMA protection class	NEMA 4
Weight [kg]	1,56

AX2090-TS50-3000	
Ordering information	Transient protection for servo drives of the AX5101 – AX5125 and AX520x series, required for CSA certification

11.10.2.1 Name plate

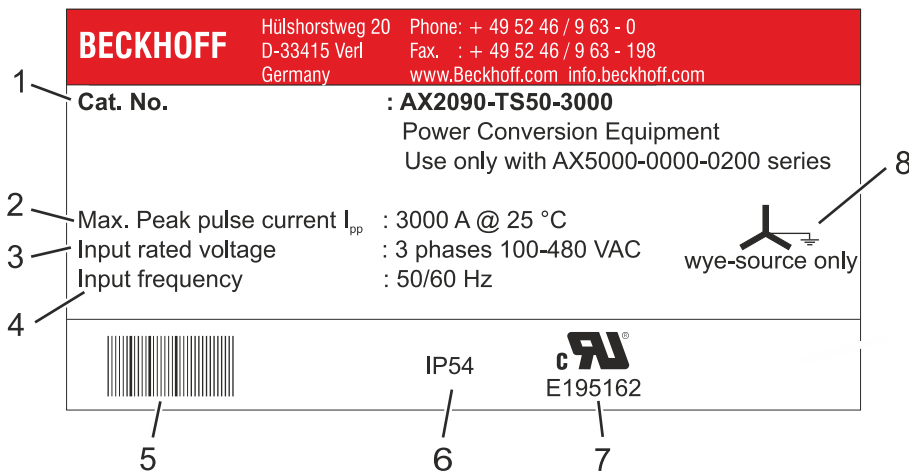

Item no.	Name
1	Order number
2	Max. pulse peak current
3	Rated input voltage
4	Input frequency
5	Barcode
6	Protection class
7	cRU-compliant (E195162)
8	Standard mains supply with earthed center

11.10.3 Installation of the transient box

11.10.3.1 Connection example

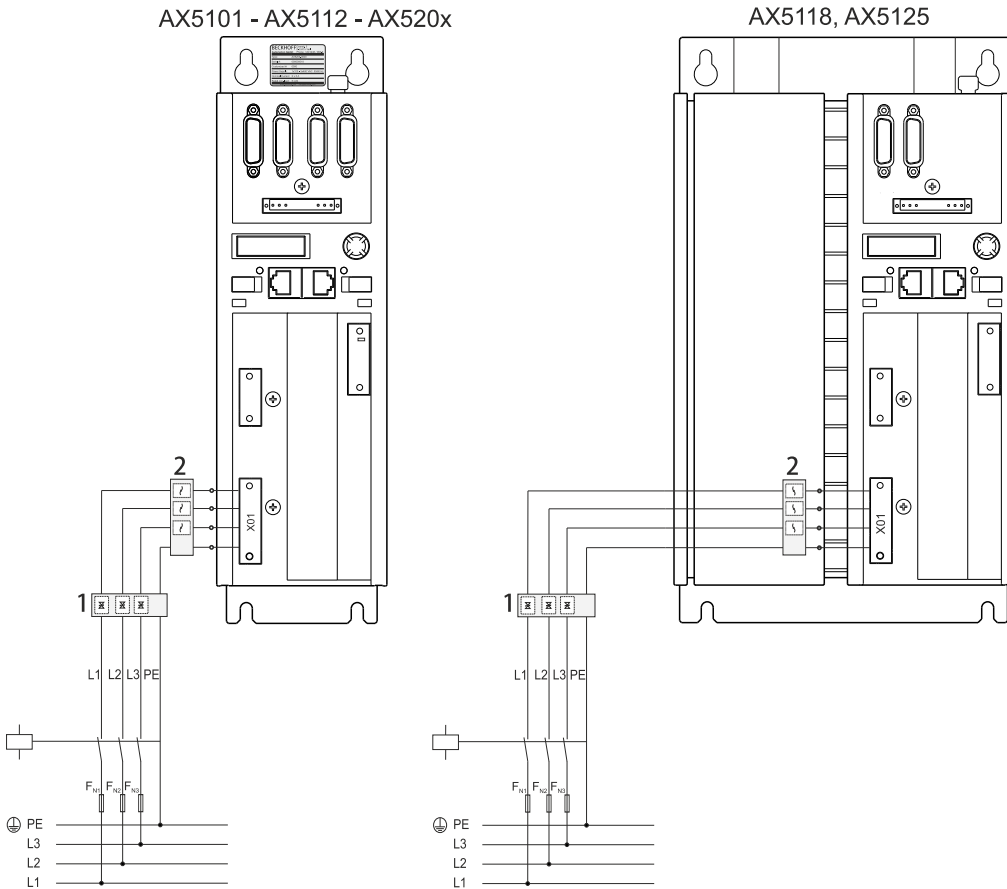

Item no.	Name
1	Transient box AX2090-TS50-3000
2	Mains filter (optional) AX2090-NF50-0014 (AX5101 - AX5112 and AX520x) Mains filter (optional) AX2090-NF50-0032 (AX5118 and AX5125)

Connection cables

When assembling the connecting cables note the following lengths:

- cable between the transient box and the mains filter (optional): min. 200 mm.
- cable between the mains filter and the AX5000 servo drive: max. 400 mm.

i EMC-compliant installation of the components and shield concept

For further information on EMC-compliant installation and the shield concept please refer to the Beckhoff website (www.beckhoff.com) under: Motion → Documentation → AX5000 – EMC leaflet.

11.10.3.2 Installation in the control cabinet

Beckhoff Automation GmbH & Co. KG recommends M6 screws with through-hole thread of strength grade 8.8 for installation of the transient box in the control cabinet. The screws should be tightened with a maximum tightening torque of 7.3 Nm.

⚠ WARNING

Caution - Risk of injury through electric shock!

The mounting plate must be earthed according to the statutory regulations.

NOTE

Earthing!

Improper earthing of the AX2090-TS50-3000 transient box can result in EMC problems.

11.10.3.3 Dimensions

AX2090-TS50-3000

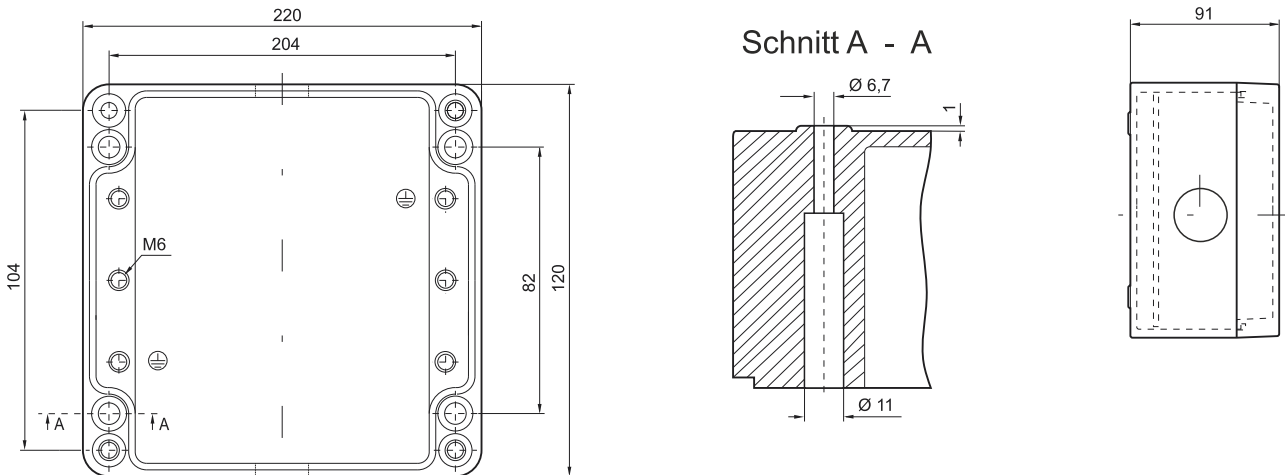

Tightening torques for the fastening screws (cover)	
M6 x 40 (4 screws)	2 ⁺¹ Nm

12 Appendix

12.1 Error management

12.1.1 General

Fatal errors are error types requiring reinitialization of the connected AX5000 feedback systems. For this the communication status of the EtherCAT Slave State Machine must be changed from Operational (Op) to Safe-Operational (Safe-Op), which takes place automatically on the occurrence of a fatal error in the case of standard parameterization. In such a case the drive is in ErrSafe-Op, since an error is additionally signaled. Since two-channel devices possess only one communication unit and no axis operation is possible in the SafeOp state, both channels are stopped by default. In this particular case, the change from Op to ErrSafe-Op results in the working counter of the SyncUnit becoming invalid, since the AX5000 can no longer supply valid actual values, resulting in all servo drives in this SyncUnit being disabled.

12.1.2 Requirement

The measures described in this section assume the following software versions.

- TwinCAT v2.10 b1329 or later versions
- Firmware v2.x or later versions

12.1.3 Parameterization

A fatal error completely stops a two-channel device by default, i.e. the error-free channel and the associated SyncUnit are also stopped. If such a behavior is not permitted in the application, the default behavior can be changed with the following parameterization of IDN P0-0350.

P-0-0350: Change of communication state in the event of fatal errors

0: Immediate state change (default)

If the servo drive is in "Op" state when the fatal error occurs, it immediately changes from "Op" to "ErrSafe-Op" and sets the error bit in the EtherCAT state.

1: No change in communication state while the other channel is enabled

In this case the AX5000 initiates the state change from Op to ErrSafe-Op in the event of a fatal error on one channel only once the error-free channel has been deactivated. The error-free channel can therefore continue to operate until it is deactivated.

2: Change of status when the reset command is called (S-0-0099)

In the case of an active fatal error, the AX5000 only changes to "ErrSafeOp" if the Reset command is executed in the drive; hence, the change of state can be initiated at the best possible time from the application by means of the Reset command.

☐ P-0-0350	Error reaction control word	
	Error reaction	1: a) Ramp b) Torque off
	Communication state change on fatal error	0: Immediate state change
	rsvd	0: Immediate state change
P-0-0351	Error reaction delay time	1: No state change while enabled
P-0-0360	Parameter set prearrangement	2: State change if reset is called

PLC

The IDN P-0-0040 is used in order to be able to diagnose in the PLC whether a fatal error situation has occurred that will lead to a change of status when next deactivating a channel or when calling the Reset command. This IDN should be read acyclically in the PLC with block "FB_SoERead". Cyclic evaluation is not meaningful, since the AX5000 no longer supplies valid inputs in ErrSafe-Op state after a fatal error, and therefore no valid information is transferred cyclically.

Bit 0: this bit indicates whether the other channel has an error that will lead to a change of communication from 'Op' to 'ErrSafe-Op' on deactivation of this channel.

Bit 1: this bit indicates whether this channel has a fatal error that will lead to a change of communication from 'Op' to 'ErrSafe-Op' on deactivation of the other channel. An error reset is not possible as long as this bit is set.

Bit 2: this bit indicates whether this channel has a fatal error that will lead to a change of communication from 'Op' to 'ErrSafe-Op' on executing the Reset command.

P-0-0040	Additional drive status word		
	Pending fatal error on other channel: Wait on disable		
	Fatal error: Reset locked until other channel disabled		
	Fatal error: State change if reset is called		
	reserved		

12.1.4 SyncUnit diagnostics

The individual servo drives should be consolidated in meaningful groups, depending on the application. Each of these groups is allocated to a SyncUnit. Since each group has its own working counter, the individual groups can continue to operate independently in the event of fatal errors. For particularly critical applications, each AX5000 can be allocated a separate Sync Unit. However, this step should only be implemented in cases where it is actually required, because each further Sync Unit results in additional data traffic on the EtherCAT strand.

Allocation of servo drives to a Sync Unit

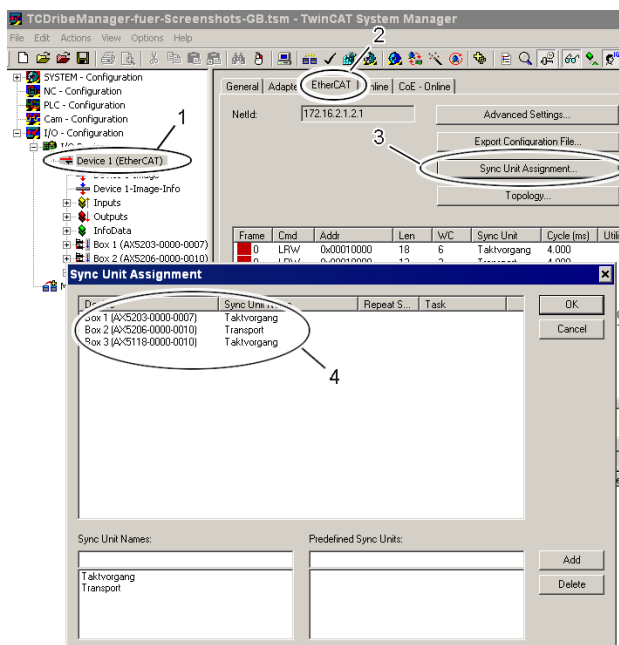

Start the TwinCAT System Manager and left-click on the associated EtherCAT strand (1). Select the "EtherCAT" tab (2) and left-click on "Sync Unit Assignment" (3). The "Sync Unit Assignment" submenu appears. Section (4) shows the servo drives and their allocation to the Sync Units. Servo drives AX5203 and AX5118 belong to Sync Unit "Cycle Process", 5206 belongs to Sync Unit "Transport".

12.1.5 Reinitialization, troubleshooting and reset

1. Analyze and rectify the fatal error.
2. Carry out an error reset via IDN S-0-0099. To this end the blocks "FB_SoEReset" or "FB_SoEReset_ByDriveRef" are available in the PLC.
3. Automatic change of communication state from "ErrSafe-Op" to "Op".
4. NC axis reset. To this end the block "NC_Reset" is available in the PLC.

Re 3:

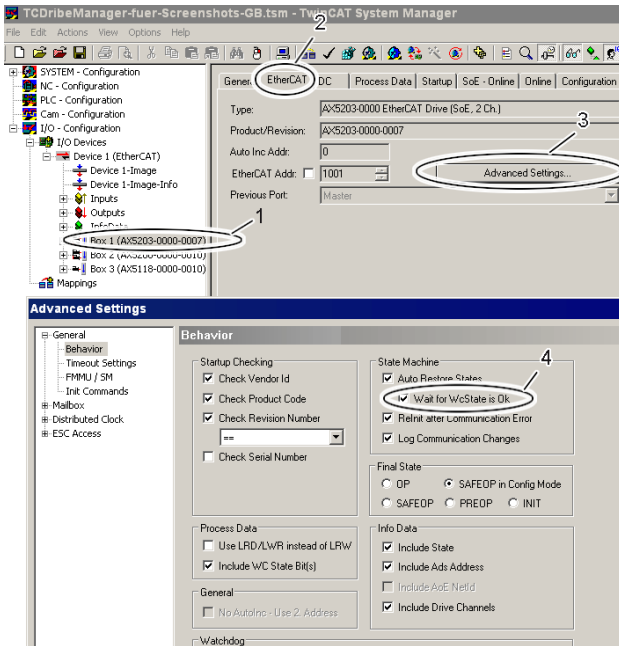

In order for the communication state to automatically switch back to "Op", flag "Wait for WcState is OK" must be activated on the corresponding AX5000. This is automatically the case for new configurations. In existing configurations it may have to be set accordingly.

Start the TwinCAT System Manager and left-click on the associated servo drive (1). Select the "EtherCAT" tab (2) and left-click on "Advanced Settings...." (3). The "Advanced Settings" submenu appears. Select the flag "Wait for WcState is OK" with the left mouse button (4).

12.2 Firmware Update

The firmware of the AX5000 is a complex software, which is absolutely necessary for the operation of the servo drive. The servo drives are subject to a constant process of further development and improvement and, hence, the firmware is also under constant development, so that the latest technological innovations can also be used.

12.2.1 Firmware version on the AX5000

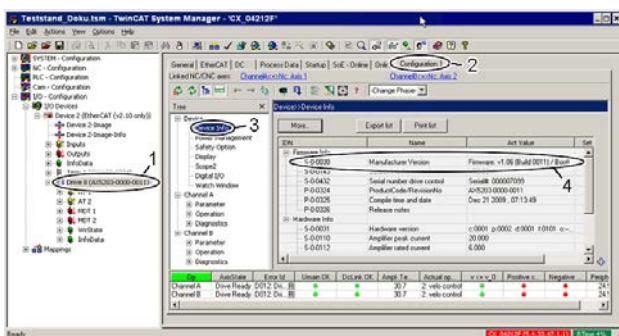

The current firmware version of the AX5000 is located in "IDN S-0-0030 - Manufacturer Version" and can be displayed using the TCDriverManager as follows: In the TwinCAT System Manager, mark the servo drive (1) whose firmware version you would like to know. Open the TCDriverManager (2) and click "Device Info" (3). A window opens and the current firmware version (4) appears in the "IDN S-0-0030".

12.2.2 Update to a new firmware version

Read please the Release Notes carefully before the update. All important changes and additions to the individual firmware versions for the servo drives are located in the corresponding file in the download area on our homepage.

● Never touch a running system!

i This old IT concept applies more than ever today, in these times of the most complex systems with ever decreasing cycle times. Please do not perform firmware updates on a system that is working well without a reason, unless requested to do so by Beckhoff Automation.

● Update only within a version number!

i We recommend firmware updates only within the same version number (e.g.: V.1.05 (Build 0003) to V.1.05 (Build 0007). If you want to update from V.1.05 to V.1.06, for example, you would need to make further adjustments in TwinCAT. In accompaniment to that, we do not recommend performing a so-called "downgrade" to a lower version number.

⚠ CAUTION

Do not work on live equipment!

The 24 V supply (plug "X03") must be connected to the servo drive in order to be able to perform a firmware update. Make sure that the power supply (plug "X01") is disconnected from the servo drive, so that uncontrolled movements of the equipment cannot occur.

12.2.2.1 Update preparation

So that you can perform a firmware update, a connection must be made to the computer with TwinCAT that controls the AX5000. It is quite usual for you not to be in the area where the equipment is operated. That is not also necessary, because there are three different procedures for establishing a connection:



Direct accesses to the control computer

You are in the same place where the equipment is operated and can work directly on the control computer. In this case you can continue immediately with the next chapter "Performing the update".

Remote access to the control computer

You are in a different place and have no direct access to the control computer. In this case you can also perform a firmware update on the control computer using one of the remote connections (VPN tunnel with remote desktop, VNC etc.) that are usual in the IT world. Please make sure that the firewall is configured accordingly for the remote connection and that you have the necessary rights. After establishing the remote connection you can continue with the next chapter "Performing the update".

Remote access by ADS

You are in a different place and have no direct access to the control computer, or the control computer is located in a cleanroom or the like. In this case you can also perform a firmware update via remote access by ADS. Please read in the Online Information System how to implement remote access by ADS. Afterwards you can continue with the chapter "Performing the update". The Online Information System is multilingual!

12.2.2.2 Performing the update

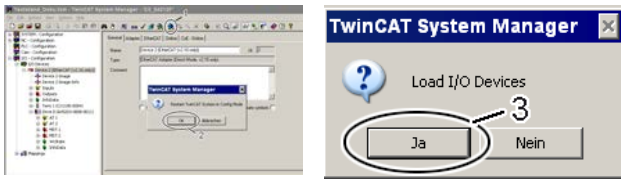

Click the button (1) in the TwinCAT System Manager to enter the configuration mode. Confirm the query with OK (2). After that a further window appears which must be confirmed with Yes (Ja) (3). Deactivate the "Free Run" with No (Nein) (4).



The system is now in "Configuration mode".

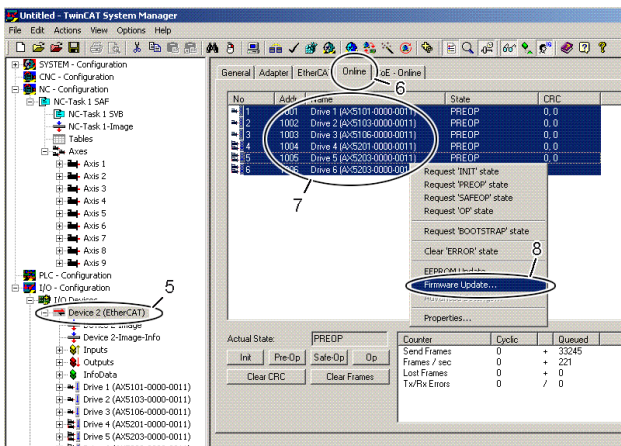

In order to perform the firmware update, you must click the "Online" tab (6) in the "EtherCAT Device" (5). If you want to update several devices, you can select the respective servo drives (7) together; in the case of one device, select only the one servo drive. Subsequently, click with the right mouse button inside the selected area and select the command "Firmware Update" (8) in the command overview.

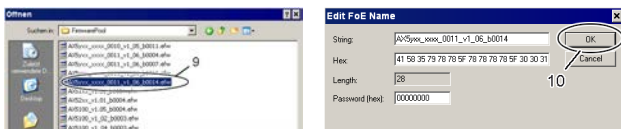

In the place where you have stored the desired firmware version, select the firmware file (9) and click "Open" (10). Confirm the window that then opens with "OK"; the firmware update is then performed. After successful completion you must click OK (11) in the concluding "Function Succeeded" window.

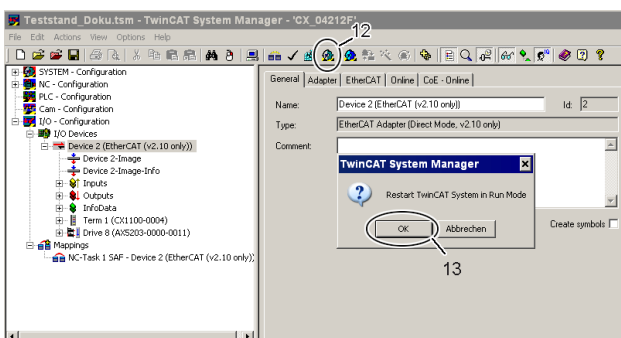
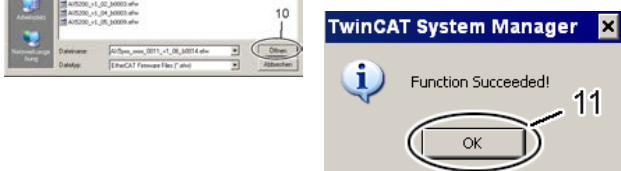

Subsequently, TwinCAT must be brought from configuration mode back into operation mode. To do this, click the button (12) and confirm the query that appears with "OK" (13).

i Update failed!

If the firmware update is aborted with an error message, you should try again. If the abortion occurs several times, please start a further attempt with another copy of the firmware file.

13 Support and Service

Beckhoff and their partners around the world offer comprehensive support and service, making available fast and competent assistance with all questions related to Beckhoff products and system solutions.

Beckhoff's branch offices and representatives

Please contact your Beckhoff branch office or representative for local support and service on Beckhoff products!

The addresses of Beckhoff's branch offices and representatives round the world can be found on her internet pages:

<http://www.beckhoff.com>

You will also find further documentation for Beckhoff components there.

Beckhoff Headquarters

Beckhoff Automation GmbH & Co. KG

Huelshorstweg 20
33415 Verl
Germany

Phone:	+49(0)5246/963-0
Fax:	+49(0)5246/963-198
e-mail:	info@beckhoff.com

Beckhoff Support

Support offers you comprehensive technical assistance, helping you not only with the application of individual Beckhoff products, but also with other, wide-ranging services:

- support
- design, programming and commissioning of complex automation systems
- and extensive training program for Beckhoff system components

Hotline:	+49(0)5246/963-157
Fax:	+49(0)5246/963-9157
e-mail:	support@beckhoff.com

Beckhoff Service

The Beckhoff Service Center supports you in all matters of after-sales service:

- on-site service
- repair service
- spare parts service
- hotline service

Hotline:	+49(0)5246/963-460
Fax:	+49(0)5246/963-479
e-mail:	service@beckhoff.com