

# XP-503 panel PC



## Company Information

All proprietary names and product designations are brand names or trademarks registered to the relevant title holders.

### **Break-Down Service**

Please call your local representative:

<http://www.eaton.eu/aftersales> or

Hotline After Sales Service:

+49 (0) 1805 223822 (de, en)

[AfterSalesEGBonn@eaton.com](mailto:AfterSalesEGBonn@eaton.com)

### **Manufacturer**

Eaton Industries GmbH

Hein-Möller-Straße 7-11

D-53115 Bonn

Germany

[www.eaton.eu](http://www.eaton.eu)

[www.eaton.com](http://www.eaton.com)

### **Support**

#### **Region North America**

Eaton Corporation

Electrical sector

1111 Superior Ave.

Cleveland, OH 44114

United States

877-ETN-CARE (877-386-2273)

[www.eaton.com](http://www.eaton.com)

#### **Other regions**

Please contact your local distributor or send an e-mail to:

[automation@eaton.com](mailto:automation@eaton.com)

### **Original**

The German-language edition of this document is the original manual.

#### **Translation of the original version.**

All editions of this document other than those in German language are translations of the original manual.

4th edition 2017, publication date 01/2017

© 2014 by Eaton Automation GmbH, CH-9008 St. Gallen

Author: Ivo Hengartner

Editor: Antje Panten-Nonnen

All rights reserved, also for the translation.

No part of this manual may be reproduced, stored in a retrieval system, or transmitted in any form or by any means, electronic, mechanical, photocopying, micro-filming, recording or otherwise, without the prior written permission of Eaton Industries GmbH, Bonn.

Subject to alteration.



## **Danger!** **Dangerous electrical voltage!**

---

### **Before commencing the installation**

- Disconnect the power supply of the device.
- Ensure that devices cannot be accidentally restarted.
- Verify isolation from the supply.
- Earth and short circuit.
- Cover or enclose neighbouring units that are live.
- Follow the engineering instructions (AWA/IL) of the device concerned.
- Only suitably qualified personnel in accordance with EN 50110-1/-2 (VDE 0105 Part 100) may work on this device/system.
- Before installation and before touching the device ensure that you are free of electrostatic charge.
- The functional earth (FE) must be connected to the protective earth (PE) or to the potential equalisation. The system installer is responsible for implementing this connection.
- Connecting cables and signal lines should be installed so that inductive or capacitive interference does not impair the automation functions.
- Install automation devices and related operating elements in such a way that they are well protected against unintentional operation.
- Suitable safety hardware and software measures should be implemented for the I/O interface so that a line or wire breakage on the signal side does not result in undefined states in the automation devices.
- Ensure a reliable electrical isolation of the low voltage for the 24 volt supply. Only use power supply units complying with IEC 60364-4-41 (VDE 0100 Part 410) or HD 384.4.41 S2.
- Deviations of the mains voltage from the rated value must not exceed the tolerance limits given in the specifications, otherwise this may cause malfunction and dangerous operation.
- Emergency stop devices complying with IEC/EN 60204-1 must be effective in all operating modes of the automation devices. Unlatching the emergency-stop devices must not cause restart.
- Devices that are designed for mounting in housings or control cabinets must only be operated and controlled after they have been installed with the housing closed. Desktop or portable units must only be operated and controlled in enclosed housings.
- Measures should be taken to ensure the proper restart of programs interrupted after a voltage dip or failure. This should not cause dangerous operating states even for a short time. If necessary, emergency-stop devices should be implemented.
- Wherever faults in the automation system may cause damage to persons or property, external measures must be implemented to ensure a safe operating state in the event of a fault or malfunction (for example, by means of separate limit switches, mechanical interlocks etc.).



## Table of Contents

<b>1</b>	<b>General.....</b>	<b>5</b>
1.1	Purpose of this manual .....	5
1.2	Additional documents.....	5
1.3	List of revisions .....	6
<b>2</b>	<b>Description of device.....</b>	<b>7</b>
2.1	Function .....	7
2.2	Intended use .....	7
2.3	Device models.....	8
2.4	Marking .....	10
2.5	Marine approvals.....	11
<b>3</b>	<b>Safety instructions.....</b>	<b>12</b>
3.1	Basics.....	12
3.2	Precautionary statements .....	13
3.3	Mandatory requirements, personnel requirements .....	14
3.3.1	Occupational safety.....	14
3.3.2	Personnel qualifications .....	14
3.3.3	Manual .....	14
3.3.4	Installation, maintenance, and disposal .....	14
3.3.5	Prohibited use .....	14
3.3.6	Prerequisites for proper operation.....	15
3.4	Device-specific hazards .....	16
<b>4</b>	<b>Installation .....</b>	<b>20</b>
4.1	Safety instructions .....	20
4.2	Unpacking and checking the package contents .....	20
4.3	Storage and transportation.....	20
4.4	Installing .....	20
4.4.1	Temperature.....	21
4.4.2	Aeration and de-aeration.....	21
4.4.3	Mounting position .....	22
4.4.4	Installation cut-out .....	22
4.4.5	Fixing and sealing .....	23
4.4.6	Conditions for marine approval .....	25
4.5	Preparing the device for operation .....	26
4.6	Connecting the power supply.....	27
4.7	Using peripheral devices .....	28
4.8	External connections.....	29
4.8.1	Ethernet connections .....	29
4.8.2	USB connections.....	30
4.8.3	DVI-I interface .....	30
4.8.4	Serial interfaces .....	31

# Table of Contents

<b>5</b>	<b>Commissioning and operation</b>	<b>32</b>
5.1	Adding expansions to the XP-503	32
5.1.1	General prerequisites	32
5.2	Connecting peripheral devices	34
5.2.1	Interfaces	34
5.2.2	Periphery	36
5.3	Using the storage media	37
5.3.1	CFast memory card	37
5.4	Using the XP-503	39
5.5	Safety Warnings	39
5.5.1	Commissioning	41
5.6	XP-503 with Windows Embedded Standard 7	44
5.6.1	Protect Mode (Operated with two drives, C:\ and D:\)	44
5.6.2	Managing Accounts and Auto Logon functionality	47
5.6.3	Touch parameters	49
5.6.4	License Eaton Galileo-Open Runtime	51
5.6.5	License Eaton Visual Designer Runtime	51
<b>6</b>	<b>Maintenance and repairs</b>	<b>53</b>
6.1	Safety instructions	53
6.2	Maintenance	53
6.2.1	Cleaning the capacitive touch panel	53
6.2.2	Battery	53
6.3	Repairs	53
<b>7</b>	<b>Storage, transport and disposal</b>	<b>55</b>
7.1	Safety instructions	55
7.2	Storage	55
7.3	Transport	55
7.4	Disposal	56
<b>8</b>	<b>Technical data</b>	<b>57</b>
8.1	Dimensions for XP-503 with 25.65 cm (10.1") display	57
8.1.1	Front dimensions	57
8.1.2	Device dimensions	58
8.1.3	Fitting dimensions	59
8.2	Dimensions for XP-503 with 39.6 cm (15.6") display	60
8.2.1	Front dimensions	60
8.2.2	Device dimensions	61
8.2.3	Fitting dimensions	62
8.3	Dimensions for XP-503 with 54.6 cm (21.5") display	63
8.3.1	Front dimensions	63
8.3.2	Device dimensions	64
8.3.3	Fitting dimensions	65
8.4	General	66
8.5	Directives and standards	70
8.6	Approvals	71

## 1 General

### 1.1 Purpose of this manual

This manual contains all the information you will need in order to use the XP-503 panel PC safely and effectively. The manual is considered an integral part of the device and must always be readily available in the device's close proximity.

This manual describes all the lifecycle stages for the device: transportation, installation, commissioning, operation, maintenance, storage, and disposal. It does not, however, go over its operating system or application software.

#### Target group

This manual is intended for engineers, electricians, and automation technicians. Electrical engineering and physics-related knowledge and skills will be required in order to be able to commission the corresponding devices.

#### CAUTION



Installation requires qualified electrician



Before working with the device, make sure to read chapter 3, "Safety instructions." Chapter 3 contains important information regarding your own personal safety, and must be read and understood by everyone who will be working with the device.

#### WARNING



Incomplete manual copies

Working with individual pages taken out from the manual may lead to bodily injury and property damage due to missing safety information.

▶ Always work with the full document.

### 1.2 Additional documents

The following documents may also be helpful in relation to the use of this device:

- [1] MN05010009Z-DE System Description Networks in Brief  
(information on networks in general and on how to integrate PCs and panels into networks)
- [2] IL0480006ZU XP-503 Instruction Leaflet

#### Download Center

To download the documents, go to the Download Center - Documentation page by clicking on the Customer Support tab on the Eaton website and then selecting the appropriate option:

■ [www.eaton.eu/doc](http://www.eaton.eu/doc) (search for the document number using the search field on the home page)

#### Product information

For up-to-date information, please consult the product page on the Internet.

■ [www.eaton.eu/xp500](http://www.eaton.eu/xp500)

# 1 General

## 1.3 List of revisions

### 1.3

### List of revisions

The following table only lists major modifications.

<b>Publication date</b>	<b>Page</b>	<b>Keyword</b>	<b>New</b>	<b>Modification</b>	<b>Deleted</b>
07/2014		New edition	✓		
11/2015		ATEX accreditation	✓		
09/2016		Marine approvals	✓		
01/2017		Additional device models	✓		



## 2 Description of device

### 2.1 Function

XP-503 panels can be used as control and monitoring devices.

XP-503 devices are the answer to the growing demand of machine and system manufacturers for high-precision, cost-effective HMI solutions featuring industrial-grade capacitive multi-touch technology. These devices are available in three widescreen display sizes: 10.1", 15.6", and 21.5". Their slim design, featuring a non-reflective glass front, delivers a modern look. The robust, scratch-resistant front and open device concept on the Panel PCs make them suitable for use in almost all branches of industry involved in mechanical and plant engineering.

### 2.2 Intended use

XP-503 panel PCs are primarily intended for use in machine and system building applications. They are suitable for use in industrial environments and are typically used for automation purposes.

## 2 Description of device

### 2.3 Device models

#### 2.3

#### Device models

Device type	Part no.	Article no.
10.1" widescreen industrial panel PC (Galileo) <ul style="list-style-type: none"><li>• PCT Multitouch</li><li>• 1.65 GHZ CPU</li><li>• 4 GB RAM</li><li>• Min. 32 GB of internal memory</li><li>• Min. 4 GB of CFast removable memory</li><li>• Windows Embedded Standard 7</li><li>• Galileo Open Runtime License</li></ul>	XP-503-10-A10-A00-1B	174474
15.6" widescreen industrial panel PC (Galileo) <ul style="list-style-type: none"><li>• PCT Multitouch</li><li>• 1.65 GHZ CPU</li><li>• 4 GB RAM</li><li>• Min. 32 GB of internal memory</li><li>• Min. 4 GB of CFast removable memory</li><li>• Windows Embedded Standard</li><li>• Galileo Open Runtime License</li></ul>	XP-503-15-A10-A00-1B	174475
21.5" widescreen industrial panel PC (Galileo) <ul style="list-style-type: none"><li>• PCT Multitouch</li><li>• 1.65 GHZ CPU</li><li>• 4 GB RAM</li><li>• Min. 32 GB of internal memory</li><li>• Min. 4 GB of CFast removable memory</li><li>• Windows Embedded Standard 7</li><li>• Galileo Open Runtime License</li></ul>	XP-503-21-A10-A00-1B	174476
10.1" widescreen industrial panel PC (VD) <ul style="list-style-type: none"><li>• PCT Multitouch</li><li>• 1.65 GHZ CPU</li><li>• 4 GB RAM</li><li>• Min. 32 GB of internal memory</li><li>• Min. 4 GB of CFast removable memory</li><li>• Windows Embedded Standard 7</li><li>• Visual Designer runtime license</li></ul>	XP-503-10-A10-A00-1V	174477
15.6" widescreen industrial panel PC (VD) <ul style="list-style-type: none"><li>• PCT Multitouch</li><li>• 1.65 GHZ CPU</li><li>• 4 GB RAM</li><li>• Min. 32 GB of internal memory</li><li>• Min. 4 GB of CFast removable memory</li><li>• Windows Embedded Standard 7</li><li>• Visual Designer runtime license</li></ul>	XP-503-15-A10-A00-1V	174478

## 2 Description of device

### 2.3 Device models

21.5" widescreen industrial panel PC (VD)	XP-503-21-A10-A00-1V	174479
<ul style="list-style-type: none"> <li>• PCT Multitouch</li> <li>• 1.65 GHZ CPU</li> <li>• 4 GB RAM</li> <li>• Min. 32 GB of internal memory</li> <li>• Min. 4 GB of CFast removable memory</li> <li>• Windows Embedded Standard 7</li> <li>• Visual Designer runtime license</li> </ul>		
15.6" widescreen industrial panel PC (Galileo)	XP-503-15-A10-A01-1B	184582
<ul style="list-style-type: none"> <li>• PCT Multitouch</li> <li>• 1.65 GHZ CPU</li> <li>• 4 GB RAM</li> <li>• Min. 32 GB of internal memory</li> <li>• Min. 4 GB of CFast removable memory</li> <li>• Windows Embedded Standard</li> <li>• Galileo Open Runtime License</li> <li>• ATEX certification II 3D Ex tc IIIC T70°C U</li> </ul>		
10.1" widescreen industrial panel PC (Galileo)	XP-503-10-A10-A01-1B	184926
<ul style="list-style-type: none"> <li>• PCT Multitouch</li> <li>• 1.65 GHZ CPU</li> <li>• 4 GB RAM</li> <li>• Min. 32 GB of internal memory</li> <li>• Min. 4 GB of CFast removable memory</li> <li>• Windows Embedded Standard</li> <li>• Galileo Open Runtime License</li> <li>• ATEX certification II 3D Ex tc IIIC T70°C U</li> </ul>		
21.5" widescreen industrial panel PC (Galileo)	XP-503-21-A10-A01-1B	184927
<ul style="list-style-type: none"> <li>• PCT Multitouch</li> <li>• 1.65 GHZ CPU</li> <li>• 4 GB RAM</li> <li>• Min. 32 GB of internal memory</li> <li>• Min. 4 GB of CFast removable memory</li> <li>• Windows Embedded Standard</li> <li>• Galileo Open Runtime License</li> <li>• ATEX certification II 3D Ex tc IIIC T70°C U</li> </ul>		

Tab. 1 Device models

## 2 Description of device

### 2.4 Marking

#### 2.4

#### Marking

##### Nameplate

The device has a nameplate on rear. This nameplate makes it possible to identify the device and includes the following information:

- Manufacturer
- Part Number
- Required power supply
- Article No. (Part No. or Art. No.)
- Serial No.
- Certification marks and information concerning the corresponding certification/approval
- Layout of interfaces and controls

To get fast and effective support, make sure to always provide Customer Service with the following information from the nameplate:

- Article No. (Part No. or Art. No.)
- Serial No.

2.5

**Marine approvals**

**Obtained type approvals**

XP-503 panels have been granted the required shipping classification by Det Norsk Veritas / Germanischer Lloyd (DNV GL)

- DNV GL-CG-0339 type approval, November 2015 edition, "Environmental test specification for electrical, electronic and programmable equipment and systems"  
Certificate No.: TAA00000NC

**Location classes**

Temperature	B - Ambient temperature: 0°C to +55°C
Humidity	B - Relative humidity up to 100 % at all relevant temperatures.
Vibration	A - Bulkheads, beams, deck, bridge, Acceleration amplitude: 0.7 g
EMC	A* - All locations except bridge and open deck B* - All locations (including bridge and open deck)
Input	Required protection according to DNV-GL Rules shall be provided upon installation on board

\* Filters / Ferrites maybe required to fulfil. See installation restrictions

**Installation restrictions**

- Install and commission referring to manuals
- Screened communication cables improve EMC behavior
- PE connection of communication cables improve EMC behavior (e.g. earth-connection kit: EATON ZB4-102-KS1)

Location class	interface	Installations
EMC B	Power supply	Place interference filter
EMC A		No additional installations

 The gasket installed inside the enclosure cover at the factory must be present in order to provide stability against vibrations.

 see section 4.4.64.4.6 Conditions for marine approval.

## 3 Safety instructions

### 3.1 Basics

## 3 Safety instructions

### 3.1 Basics

The device has been designed according to the state of the art and all generally accepted safety rules and standards. However, this alone cannot eliminate all potential hazards, which is why it is necessary for you to be aware of all hazards and residual risks.



Do not run the device unless it is in perfect technical condition. Make sure to always operate it as specified in this document.



 **Read this chapter before working with the device. It contains important information regarding your own personal safety, and must be read and understood by everyone who will be working with the device.**

3.2

Precautionary statements

 <b>Danger</b>	
	<b>DANGER</b> signal word Indicates an imminent hazardous situation that will result in death or serious injury if it is not avoided.

 <b>WARNING</b>	
	<b>WARNING</b> signal word Indicates a potentially hazardous situation that could result in death or serious injury if it is not avoided.

 <b>CAUTION</b>	
	<b>CAUTION</b> signal word Indicates a potentially hazardous situation that could result in minor or moderate injury if it is not avoided.

<b>CAUTION</b>	
	<b>CAUTION</b> signal word without warning sign Indicates a situation that could result in property damage if it is not avoided.

 Used to highlight useful information.

The hazard symbol used and the corresponding text will provide information regarding the specific hazard and how to avoid or prevent it.

## 3 Safety instructions

### 3.3 Mandatory requirements, personnel requirements

#### 3.3 Mandatory requirements, personnel requirements

##### 3.3.1 Occupational safety



All generally accepted occupational health and safety rules and standards (internal and national) must be complied with.

##### 3.3.2 Personnel qualifications

The personnel responsible for installation, operation, maintenance, and repairs must have the necessary qualifications for the work they will be performing. They must be appropriately trained and/or briefed and be informed of all hazards and risks associated with the device.

##### 3.3.3 Manual

Make sure that every person who will be working with the device, regardless of the lifecycle stage involved, has read and understood the relevant sections of this manual.

 <b>WARNING</b>	
	<p><b>Incomplete manual copies</b></p> <p>Working with individual pages taken out from the manual may lead to bodily injury and property damage due to missing safety information.</p> <p>▶ Always work with the full document.</p>

##### 3.3.4 Installation, maintenance, and disposal

Make sure that the device is connected, installed, serviced, and disposed of professionally and in line with all relevant standards and safety rules.

##### 3.3.5 Prohibited use

It is strictly prohibited to use the device in order to implement safety-relevant functions (in the sense of personal and machine protection).



#### 3.3.6

#### Prerequisites for proper operation

In order for the device to be able to meet the contractually stipulated terms, the following must be observed:

- Only qualified personnel should be allowed to work with the device.
- The personnel working with the device must have read the manual and must follow all the instructions in it.
- The required ambient conditions must be met.
- Maintenance work must be carried out correctly.
- Potentially explosive area, zone 22, only device type XP-503-...-A10-A01-1B:
  - The XP-503-...-A10-A01-1B are designed for installation in the front of enclosures in protection type "tc" (alternatively "ta" or "tb"). This installation must be tested and certified separately.
  - The maximum surface temperature at the outer surface is set to 70°C at the maximum ambient temperature of 50°C.
  - For safe installation, comply with the specification to holding brackets and tightening torque in the Instruction Leaflet.
  - The ground resistance of accessible metal parts must be less than 10<sup>9</sup> ohms

We assume no liability for damages, consequential damages, and/or accidents caused by the following:

- Failure to follow occupational health and safety rules and standards
- Device failures or function disturbances
- Improper use and/or handling
- Failure to follow the instructions in this manual
- Alterations, changes, and repairs to the device





For more information on repairs, please refer to chapter 6.3.1, "Repairs."





## 3 Safety instructions

### 3.4 Device-specific hazards

#### 3.4

#### Device-specific hazards

 <b>Danger</b>	
	<p><b>Explosion hazard</b></p> <p>Death, serious injury, and property damage may occur if the device is being used in a potentially explosive (classified) location and, during operation, an electrical plug connection is disconnected or the device is exposed to dangerous impacts or other types of dangerous mechanical shock.</p> <ul style="list-style-type: none"><li>▶ Use the device in the following environments only:<ul style="list-style-type: none"><li>- Non-hazardous (non-explosive) area</li><li>- Hazardous (explosive) area, zone 22 (as defined in the ATEX Directive), only device type: XP-503-15-A10-A01-1B (184582) XP-503-10-A10-A01-1B (184926) XP-503-21-A10-A01-1B (184927)</li></ul></li><li>▶ The ground resistance of accessible metal parts must be less than 10<sup>9</sup> ohms.</li><li>▶ Make sure that the device is not exposed to dangerous impacts and other types of dangerous mechanical shock.</li><li>▶ De-energize the device before disconnecting plug connections.</li><li>▶ Clean only with a clean soft antistatic damp cloth</li><li>▶ When used in a potentially explosive atmosphere, zone 22</li></ul> <p>The XP-503-...-A10-A01-1B are designed for installation in the front of enclosures in protection type "tc" (alternatively "ta" or "tb"). This installation must be tested and certified separately. The maximum surface temperature at the outer surface is set to 70°C at the maximum ambient temperature of 50°C. The environment has to be designed to avoid any bunch discharge. For safe installation, comply with the specification to holding brackets and tightening torque in the Instruction Leaflet.</p>

 <b>WARNING</b>	
	<p><b>Live parts inside the device</b></p> <p>When the device is open, there will be an electric shock hazard if live parts are touched.</p> <ul style="list-style-type: none"><li>▶ Do not open the device if it is not de-energized.</li></ul>
 <b>WARNING</b>	
	<p><b>Stray currents</b></p> <p>Large transient currents between the protective circuits of different devices may result in fire or in malfunctions due to signal interference.</p> <ul style="list-style-type: none"><li>▶ If necessary, route an equipotential bonding conductor, with a cross-sectional area that is several times larger than that of the cable screen, parallel to the cable.</li></ul>

**⚠ CAUTION**



**Electrostatic discharge**

Electrostatic discharges may damage or ruin assembly parts.

- ▶ Do not touch components (e.g., pins) that are electrostatic-sensitive.
- ▶ Discharge any static electricity from your body before touching the device (e.g., by touching an earthed metal object).

**CAUTION**



**Non-galvanically-isolated interfaces**

The device may be damaged by potential differences.

- ▶ The GND connections of all bus stations must be connected.

**CAUTION**



**Data loss**

If an SSD, HD, or CFast card is being written to and a voltage drop occurs or the drive/card is removed, data may be lost or the SSD, HD, or CFast card may be ruined.

- ▶ Insert SSDs, HDs, and CFast cards only when the device is de-energized.
- ▶ Avoid writing to SSDs, HDs, and CFast cards as much as possible. Reasons:
  - The number of write cycles for SSDs, HDs, and CFast cards is limited.
  - If there is a voltage drop while a write operation is in progress, data loss is highly likely to occur.
- ▶ Remove SSDs, HDs, and CFast cards only when the device is de-energized.
- ▶ Before switching off the device, make sure that there are no programs writing to an SSD, HD, or CFast card.

**CAUTION**



**Stable mounting cut required**

An IP65 degree of protection will only be ensured if the control panel is stiff enough, the device is properly mounted using its holding brackets, and the gasket has a proper seat.

- Minimum sheet thickness of control panel where the device will be flush mounted: 1.5 mm.
- In order for the device to be properly mounted, every single one of the holding brackets included with the delivery must be used at its intended spot.

### 3 Safety instructions

#### 3.4 Device-specific hazards

##### CAUTION



##### Condensation in/on the device

If the device is or has been exposed to climatic fluctuations (temperature fluctuations, air humidity), condensation may form on or inside the device, creating a short-circuit hazard.

- ▶ Do **not** switch on the device if there is condensation in or on it.
- ▶ If the device has condensation in or on it, or if the device has been exposed to temperature fluctuations, let the device settle into the existing ambient temperature before switching it on do not expose the device to direct heat radiation from heating appliances).

##### CAUTION



##### UV light

Plastics may become brittle when exposed to UV light. This will reduce the device's lifespan.

- ▶ Protect the device from direct sunlight (UV radiation).

##### CAUTION



##### Cleaning the device

The device can be damaged by pointy or sharp objects, as well as by liquids.

- ▶ Do not use pointy or sharp objects (e.g., knives) to clean the device.
- ▶ Do not use any aggressive or abrasive cleaning products or solvents.
- ▶ Make sure that no liquids get into the device (short-circuit hazard).

### 3 Safety instructions

#### 3.4 Device-specific hazards

## 4 Installation

### 4.1 Safety instructions

## 4 Installation

### 4.1 Safety instructions

 Before installing and commissioning the device, make sure to read chapter 3, "Safety instructions." Chapter 3 contains important information regarding your own personal safety.

### 4.2 Unpacking and checking the package contents

#### Unpacking

- Check the XP-503's packaging for transit damage.
- Carefully remove the packaging in order to avoid damaging the device.

 Keep the original packaging so that you will be able to use it in the future if you need to transport or ship the XP-503. Make sure to also keep the documents enclosed with the device.

#### Verify

- Check the package contents for visible transit damage.
- Use the package insert to make sure that the contents are complete.

### 4.3 Storage and transportation

The XP-503 is sturdily built, but the components inside it are sensitive to excessively strong vibrations and mechanical shock.

Accordingly, make sure to protect the XP-503 from excessively large mechanical loads.

The device should only be transported in its original packaging, complete with all shock-absorbing parts.

 If storing/transporting the device in cold weather conditions or in such a way that it will be exposed to extreme differences in temperature, make sure that no condensation forms on or inside the device.

### 4.4 Installing

 The Panel PC XP-503 is approved for use in closed spaces.

When installing the XP-503, make sure to also consult the "Technical data" chapter.

 The following requirements and instructions must be observed without fail in order to ensure that the XP-503 will run properly and will not be damaged.

#### 4.4.1

##### Temperature

- Prior to commissioning:
  - Slowly let the device settle into the existing ambient temperature.
  - If there is condensation in or on the device, do not switch on the device until it is completely dry.
- Avoid overheating during operation:  
Do not expose the device to direct sunlight or other sources of heat.
- The ambient air temperature during operation must not exceed the maximum limit value specified in the "Technical data" chapter.

#### 4.4.2

##### Aeration and de-aeration

- Do not block the ventilation openings when mounting the device:  
They are designed to allow air to circulate in order to cool the device.
- The device uses natural convection-based passive cooling, i.e., it does not use CPU or system fans.
- The CPU and the power supply unit's power semiconductors are directly thermally connected to the back of the display housing by means of a heat spreader or heat sink.
- Make sure that there will be enough volume for air changes inside the control panel, etc. There must be a clearance of at least 50 mm around the XP-503. The clearance behind it can be reduced to 20 mm if necessary.
- Make sure that there is enough air recirculation.

Example: XP-503-15

The following also applies to other device versions as applicable.



Abb. 1 Aeration and de-aeration

## 4 Installation

### 4.4 Installing

#### 4.4.3

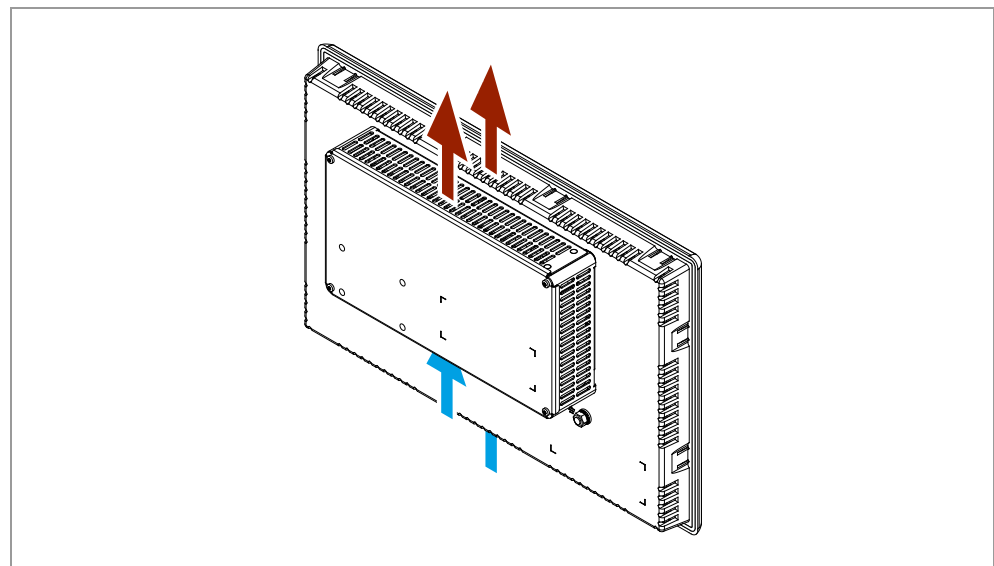
#### Mounting position

The device is designed to be flush mounted in landscape mode.

It can be mounted in a perfectly vertical position or at an angle of up to  $\pm 10^\circ$  in the directions shown below.

If the device is not mounted in a perfectly vertical position, make sure that air will still be able to circulate properly through the openings in the housing.

Example: XP-503-21

The following also applies to other device versions as applicable.



Abb. 2 Permissible mounting positions

#### 4.4.4

#### Installation cut-out

The dimensions for the mounting cutout can be found in the "Fitting dimensions" section (for the relevant device) of the "Mechanical dimensions" chapter

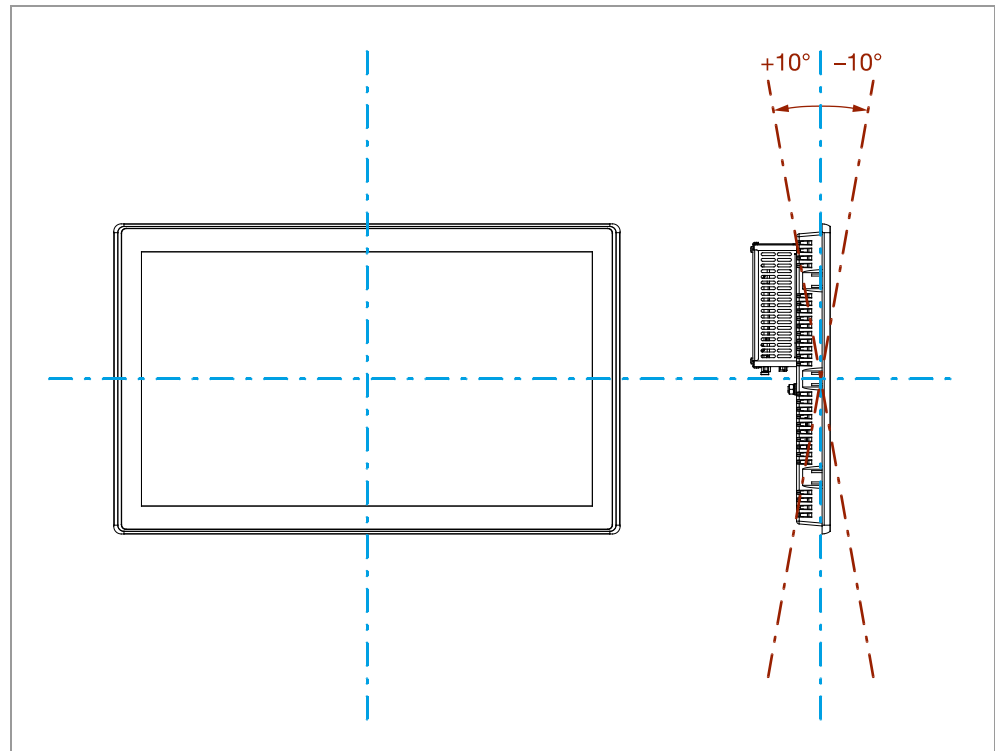

**Make sure that there is also sufficient clearance for removing the XP-503 from the mounting cutout.**



#### 4.4.5

#### Fixing and sealing

##### Flush mounting in cabinets, etc.

The XP-503 is designed to be flush mounted in control panels and swing frames.

- ▶ The mounting cutout must be located in a position that ensures that webs or other reinforcing elements in the control panel, etc. will stabilize it. If necessary, reinforcing elements must be installed/added.

#### CAUTION



##### Stable mounting cut required

An IP65 degree of protection will only be ensured if the control panel is stiff enough, the device is properly mounted using its holding brackets, and the gasket has a proper seat.

- Minimum sheet thickness of control panel where the device will be flush mounted: 1.5 mm.
- In order for the device to be properly mounted, every single one of the holding brackets included with the delivery must be used at its intended spot.

Example: XP-503-15

The following also applies to other device versions as applicable.



Abb. 3 Fixing and sealing

## 4 Installation

### 4.4 Installing

#### ■ IP65-tight flush mounting

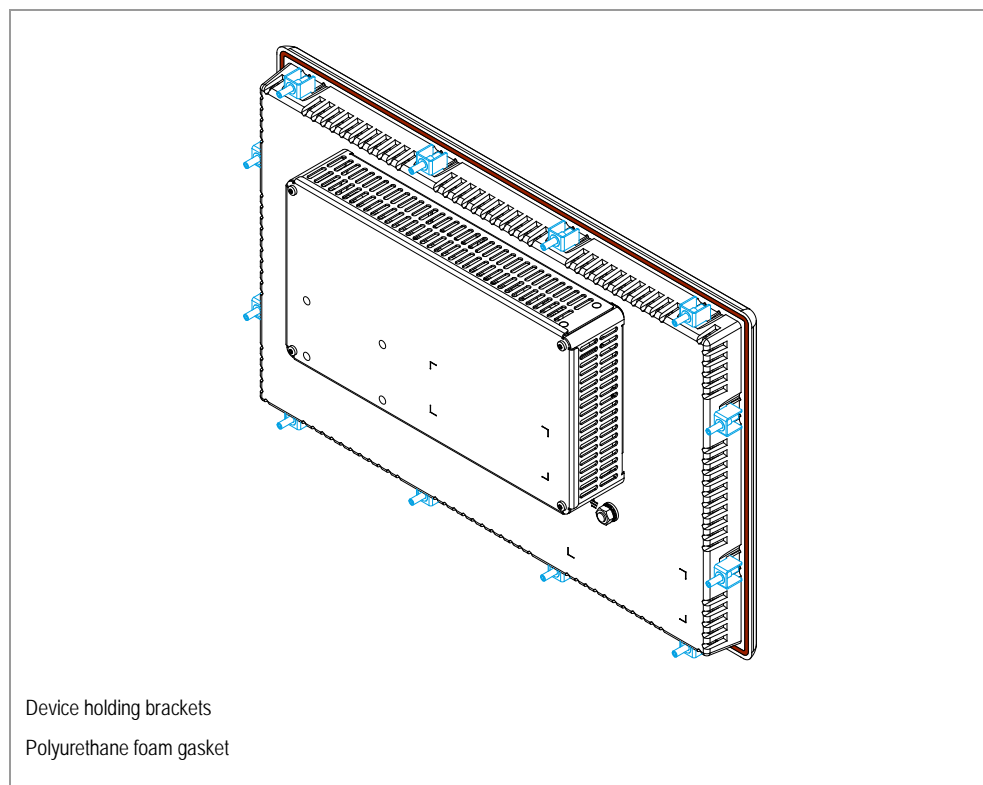
- Peripheral gasket at the back of the front frame on the display housing



Abb. 4 Polyurethane foam gasket

#### ■ Device holding bracket

- The purpose of the device holding brackets is to secure the flush-mounting panel PC onto a control panel, etc. To this end, the brackets must be hooked into the display housing sideways and screwed against the control panel door.
- Together with the polyurethane foam gasket, these holding brackets are the main element involved in achieving an IP65 degree of protection.
- The holding brackets' intended locations have been selected in such a way as to ensure that the brackets will push against the center of the peripheral polyurethane foam gasket.
- The holding brackets are included as accessories with the device.

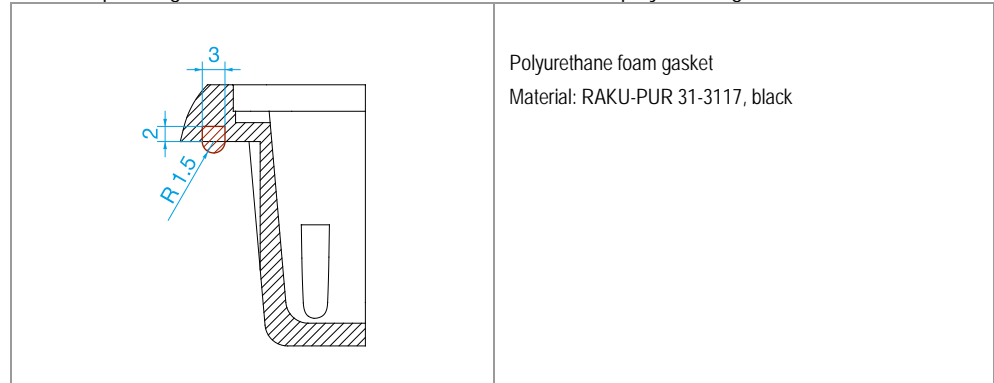

Abb. 5 Device holding bracket

- ▶ When tightening the M4 x 25 DIN 914 Allen set screw **with torque: 0.6 – 0.7 Nm**

#### 4.4.6

#### Conditions for marine approval

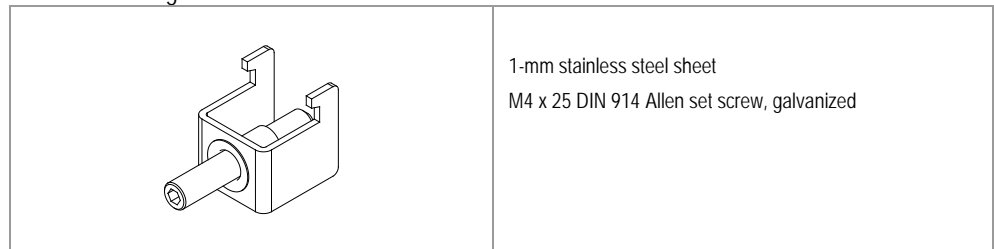
The following DNV GL rules for shipping classification in accordance with DNV GL-CG-0339 type approvals must be observed:

- 1 Complete and proper installation and commissioning in accordance with DNV GL rules and Eaton requirements and specifications.
- 2 Installation of radio interference suppression filters for the 24-V-DC-supply.

#### Radio interference suppression filter for the 24-V-DC-supply

Additional interference filters must be installed for the power supply in order to adhere to the EMC B provisions.

- Integrate a radio interference suppression filter into the wiring.

Depending on the output, the following filters can be used:

- XT-FIL-1 radio interference suppression filter for 24-V-DC supply up to 2.2 A (Eaton article no. 285316) or
- XT-FIL-2 radio interference suppression filter for 24-V-DC supply up to 12 A (Eaton article no. 118980)



Abb. 6 Power supply with EMC filter

Grounding is ensured either by using

- the filter's integrated contact fields onto a grounded metal plate

or using

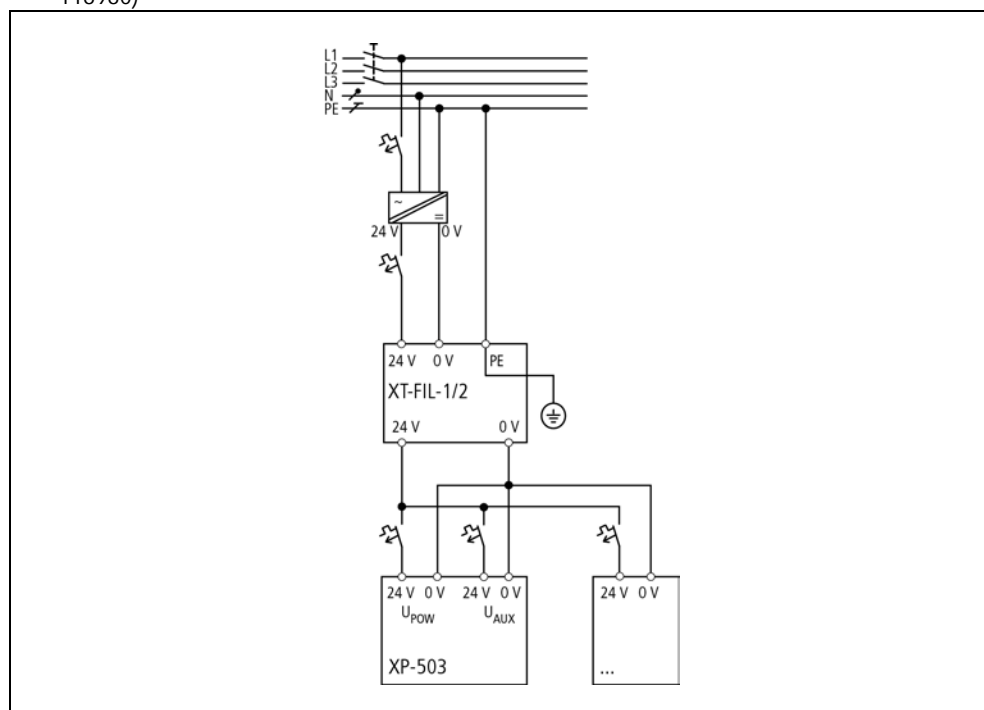
- a separate line to the filter's PE connection.

Depending on the current consumption or configuration, several filters may be used as well.

## 4 Installation

### 4.5 Preparing the device for operation

#### 4.5

#### Preparing the device for operation

##### CAUTION



##### **Interference-proof connections for undisturbed operation**

For all signal connections, use screened cables and metal connectors only.

All plug-in connections must be screwed or locked into place.  
This will improve their electrical shielding.

Signal cables must not be routed in the same cable duct with power cables.

Before commissioning the system, check all cable connections.

Make sure that all voltages and signals have the required values.

##### CAUTION



##### **Safely diverting electrical interference currents**

The device and the control panel must be connected to a central earth point with as short a conductor length as possible.

The connection between the device and the control panel must have as low a resistance as possible.

The earth connection must be implemented using a green and yellow cable with a minimum cross-sectional area of 6 mm<sup>2</sup>.



Emitted interference as per EN 55022:2010 Class A and EN 61000-6-4:2007

##### WARNING



##### **Devices with a 24 V DC supply**

The device should only be run with safety extra-low voltage (functional extra-low voltage with protective separation).

The power transformer must meet all applicable standards.

## 4.6

### Connecting the power supply

Before connecting the power supply

CAUTION	
	<p><b>Control required</b></p> <p>Does the voltage fall within the permissible input range?</p> <p>Functional earth: Connect the earth point to the cabinet's earth! M6 x 12 earthing stud on the back of the display housing</p>

Supply voltage 24 V DC

CAUTION	
	<p><b>Safety extra-low voltages (SELV) necessary</b></p> <p>24 V DC (18 – 36 V DC) supply for integrated DC/DC converter.</p> <p>The applied voltage must meet the requirements for safety extra-low voltages (SELV) set forth in IEC 60950 and – in connection with the UL listing – the requirements for a low-voltage source set forth in UL 508!</p> <p>Pay attention to the polarity!</p>

Example: XP-503-15

The following also applies to other device versions as applicable.

Bottom of housing:



Abb. 7 Connecting the 24 V DC supply voltage

#### Connection cable

For the power supply connection:

Copper conductor: 60° / 70°C

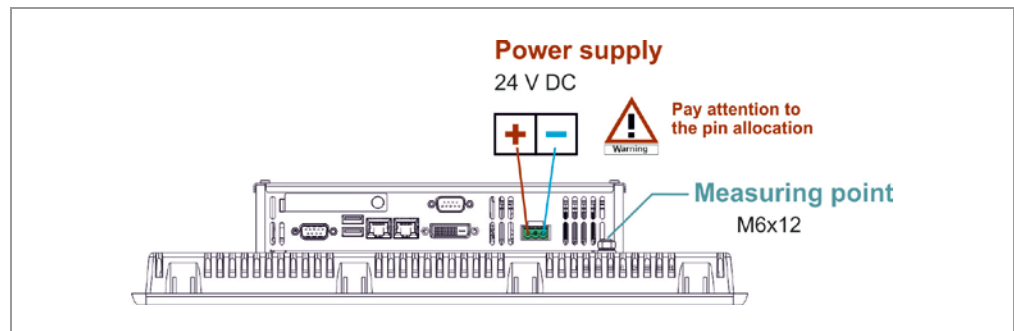
Cross section: 0.75 – 2.5 mm<sup>2</sup>

Tightening torque of 0.56 to 0.79 Nm (screws on plug section)

## 4 Installation

### 4.7 Using peripheral devices

#### Plug-in connection for 24 V DC

On the back of the device, at the bottom of the housing:

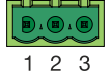
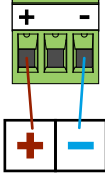
	Basic enclosure		<b>MSTBA 2.5/ 3-G-5.08</b> 3-pole, grid: 5.08 mm Phoenix Contact article no.: 1757255	
	Connector section		<b>MSTB 2.5/ 3-ST-5.08</b> 3-pole, grid: 5.08 mm Screw connection Phoenix Contact article no.: 1757022  Included as an accessory with the device!	
	Pin	Signal	Connection	Configuration
	1	+	+24 V DC	Supply voltage +24 V DC
	2	N.C.	N.C.	not used
	3	-	0V	Supply voltage 0 V

Tab. 2 Plug-in connection for 24 V DC

- Install the enclosed plug on a two-conductor cable and plug it into the socket at the bottom of the housing. Pay attention to the polarity.
- Connect the power supply cable to a 24-V power supply that meets the requirements for safety extra-low voltages (SELV) set forth in IEC 60950 and – in connection with the UL listing – the requirements for a low-voltage source set forth in UL 508!

The device is now ready to run on 24 VDC.

### 4.7

#### Using peripheral devices

With their peripheral ports, Eaton's devices make it possible to connect a variety of components.

CAUTION	
	<p><b>Disturbances in EMC</b></p> <p>When using commercially available peripheral devices (e.g., with the USB port), it is important to keep in mind that their EMC interference immunity parameters will normally be designed with office environments in mind.</p> <p>These devices are not suitable for operation in industrial environments!</p>

4.8

External connections

 The external interfaces described below can be accessed on the back of the device, at the bottom of the housing.

4.8.1

Ethernet connections

Two Ethernet connections, each with its own RJ45 port. The Ethernet controllers support transfer rates of 10 Mbit/s, 100 Mbit/s, and 1 Gbit/s.

■ Configuration for the 10 Mbit/s and 100 Mbit/s operating modes

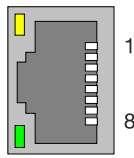
RJ 45 socket 8-pole, 2 LEDs (CAT5e/6)	Pin	Signal	Description	Input/Output	
	1	TxD +	Transmit +	O	
	2	TxD –	Transmit –	O	
	3	RxD +	Receive +	I	
	4	N.C.	not used	---	
	5	N.C.	not used	---	
	6	RxD –	Receive –	I	
	7	N.C.	not used	---	
	8	N.C.	not used	---	
			LED yellow	Link	
			LED green	Activity	

Tab. 3 Ethernet [10/100 Base-T]

■ Pinout for the 1000 Mbit/s operating mode

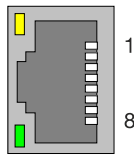
RJ 45 socket 8-pole, 2 LEDs (CAT5e/6)	Pin	Signal	Description	Input/Output	
	1	DB +	Bi-directional data B +	I/O	
	2	DB –	Bi-directional data B –	I/O	
	3	DA +	Bi-directional data A +	I/O	
	4	DD +	Bi-directional data D +	I/O	
	5	DD –	Bi-directional data D –	I/O	
	6	DA –	Bi-directional data A –	I/O	
	7	DC +	Bi-directional data C +	I/O	
	8	DC –	Bi-directional data C –	I/O	
			LED yellow	Link	
			LED green	Activity	

Tab. 4 Ethernet [1000 Base-T]

 2 x Ethernet

## 4 Installation

### 4.8 External connections

#### 4.8.2 USB connections

Two 9-pole USB ports, Type A, for connecting USB peripherals.

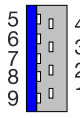
Type A USB 9-pole	Pin	Signal	Description
	1	USB VCC	+5 V Power
	2	USB -	Data -
	3	USB +	Data +
	4	GND	Ground
	5	SS_RX -	twisted with RX +
	6	SS_RX +	Data transmission device to host
	7	GND_DRAIN	Shield
	8	SS_TX -	twisted with TX +
	9	SS_TX +	Data transmission host to device

Tab. 5 USB 3.0

 2 x USB 3.0

#### 4.8.3 DVI-I interface

DVI-I interface, conforming to the DVI-I (dual-link) standard, for connecting (with a digital or analog signal) an external display unit.

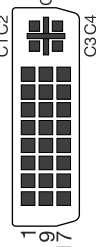
DVI-I socket (24+5)-pole (dual link)	Pin	Signal	Pin	Signal	Pin	Signal
	1	Data 2 -	9	Data 1 -	17	Data 0 -
	2	Data 2 +	10	Data 1 +	18	Data 0 +
	3	Data 2/4 Shield	11	Data 1/3 Shield	19	Data 0/5 Shield
	4	Data 4 -	12	Data 3 -	20	Data 5 -
	5	Data 4 +	13	Data 3 +	21	Data 5 +
	6	DDC Clock	14	+5v	22	Clock Shield
	7	DDC Data	15	Ground (for +5V)	23	Clock +
	8	VSYNC	16	Hot Plug Detect	24	Clock -
	C1	Red	C3	Blue	C5	Ground
	C2	Green	C4	HSYNC		

Tab. 6 DVI-I



4.8.4

Serial interfaces

■ RS 485/232

One serial interface on a 9-pole SUB-D plug that can be used as an RS 232, RS 422, or RS 485 port, configurable in the BIOS.

SUB-D plug 9-pole	Pin	RS 232	RS 422	RS 485
		1	DCD	TX -
2	RXD	TX +	DATA +	
3	TXD	RX +	N.C.	
4	DTR	RX -	N.C.	
5	GND	GND	GND	
6	DSR	N.C.	N.C.	
7	RTS	N.C.	N.C.	
8	CTS	N.C.	N.C.	
9	RI	N.C.	N.C.	

Tab. 7 RS 485/232

☞ Default setting: half-duplex RS 485

■ RS 232

One serial interface on a 9-pole SUB-D plug that can be used as an RS 232 port.

SUB-D plug 9-pole	Pin	Signal	Description	Input/Output
		1	DCD	Data Carrier Detect
2	RXD	Receive Data	I	
3	TXD	Transmit Data	O	
4	DTR	Data Terminal Ready	O	
5	GND	Signal Ground	---	
6	DSR	Data Set Ready	I	
7	RTS	Request to Send	O	
8	CTS	Clear To Send	I	
9	RI	Ring Indicator	I	

Tab. 8 RS 232

## 5 Commissioning and operation

### 5.1 Adding expansions to the XP-503

## 5 Commissioning and operation

### 5.1 Adding expansions to the XP-503

#### 5.1.1 General prerequisites

##### Limitation of Liability

All technical data, certifications, and approvals will cease to apply/be void if expansions other than those approved by Eaton are used.

We will not assume liability for functional limitations resulting from the use of third-party devices and components.

#### ⚠ CAUTION



All cards and assembly parts are electrostatic-sensitive. Follow all ESD safety instructions. The symbol to the left is used to indicate the use of electrostatic-sensitive components.

##### Precautions

#### ⚠ CAUTION



Electronic assembly parts are extremely sensitive to electrostatic discharges. Because of this, it is necessary to take precautions whenever handling the cards. Please refer to the guidelines for electrostatic-sensitive components for more information (ESD guidelines).

- Before plugging in or disconnecting components or expansion modules, disconnect the XP-503 from the power supply.
- Before plugging in the cables, you will need to bring the static charge on your body to the same potential as the charge on the XP-503 and the cables. To do this, briefly touch the metal housing.
- Discharge the electrostatic charge on your tools.
- Wear an anti-static wrist strap when handling components.
- Leave components and expansion modules in their packaging until right before you install them.
- Grab components and expansion modules from the edge only – do not touch connection pins or traces.
- Never run the XP-503 with the housing open.

#### CAUTION



Please note:  
Only service personnel should be allowed to open the XP-503.

## 5 Commissioning and operation

### 5.1 Adding expansions to the XP-503

#### Before opening

- ▶ Shut down the operating system.
- ▶ Disconnect the power supply.
- ▶ Disconnect all connection cables from the XP-503.
- ▶ Remove the CFAST card

#### Open

Example: XP-503-15, The following also applies to other device versions as applicable.

	<p>Unscrew the four screws on the housing cover: Torx pan head screws without plain unthreaded shank RHS TORX Zn M3 x 5 ISO 7380-1</p>
	<p>Remove the cover from the housing.</p> <p>Please note: The CFAST adapter is screwed onto the cover and wired to the board.</p>
	<p>All service-relevant assembly parts, such as RAM, mSATA, the CMOS battery, and the optional HDDs or SSDs, can be accessed from the inside of the housing.</p>

Abb. 8 Opening the device

#### Close

When closing the device, follow the same steps you used to open it, but in opposite order.

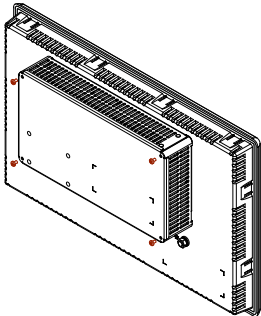
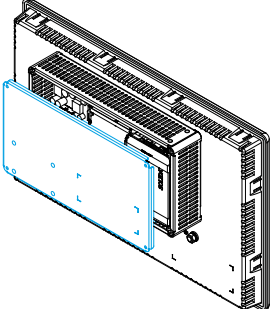
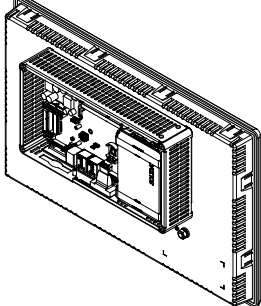

#### Note on marine approvals

The gasket installed inside the enclosure cover at the factory must be present in order to provide stability against vibrations.

## 5 Commissioning and operation

### 5.2 Connecting peripheral devices

## 5.2 Connecting peripheral devices

### 5.2.1 Interfaces

#### Connection locations

The ports used to connect peripherals are located on the back of the housing.

- These connections are accessible at the bottom of the housing (the housing does not need to be opened in order to access these ports).

Example: XP-503-15, The following also applies to other device versions as applicable.



Abb. 9 Connection locations



**Do not plug in or disconnect any plugs during operation!**

**Before connecting peripherals, make sure they are designed for use in industrial environments!**

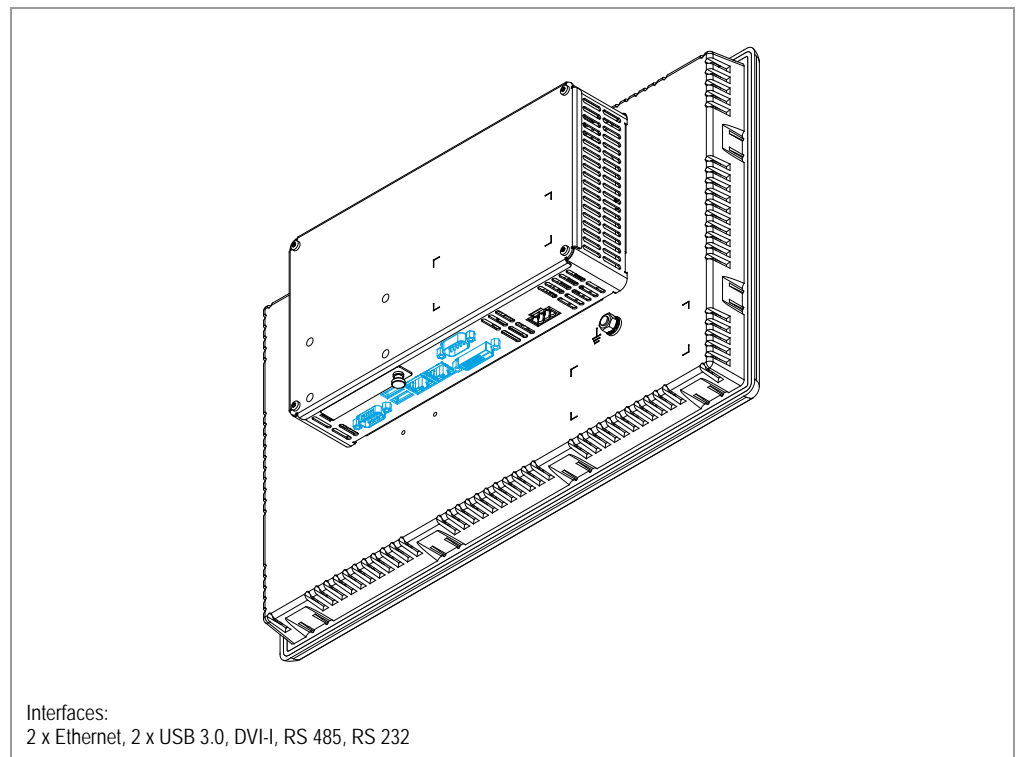
For the ports' layout, see the nameplate on the back of the housing.

The connections are standard contacts with the corresponding standard pinouts.

# 5 Commissioning and operation

## 5.2 Connecting peripheral devices

### Connections layout

The connections listed below are the external interfaces on the computer board installed in the XP-503. They can be found on the back of the device, at the bottom of the housing.

Example: XP-503-15, The following also applies to other device versions as applicable.

Bottom of housing:



Abb. 10 Connections for peripherals

No.	Interface	Plug design
1	DVI-I display port (digital/analog)	DVI-I socket, (24+5)-pole
2	Ethernet (LAN 1)	RJ 45 socket, 8-pole, 2 LEDs
3	Ethernet (LAN 2)	RJ 45 socket, 8-pole, 2 LEDs
4	USB 3.0 Port	USB Type A, 9-pole
5	USB 3.0 Port	USB Type A, 9-pole
6	Serial interface RS 485	Sub-D plug, 9-pole
7	Serial interface RS 232	Sub-D plug, 9-pole

Tab. 9 Interfaces

## 5 Commissioning and operation

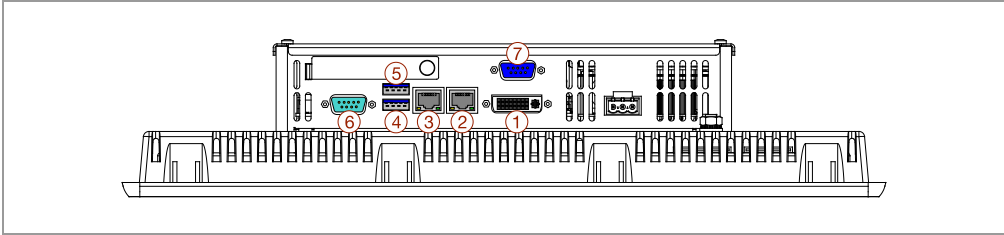
### 5.2 Connecting peripheral devices

#### 5.2.2

#### Periphery



Connected devices must have the CE mark (for industrial environments!).

An external keypad can be used simultaneously with the touch panel.

#### Keypad

The XP-503 has been designed to work with the following keypads:

- USB keypad  
A USB keypad can be connected to one of the USB interfaces.  
It may be necessary to install a USB keypad driver the first time you use the keyboard.

#### Mouse

The XP-503 has been designed to work with a variety of mouse types:

- Serial mouse  
A serial mouse can be connected to the serial ports (RS 232). The matching mouse driver must be installed and configured before being able to use the mouse.
- USB mouse  
A USB mouse can be connected to one of the USB ports.  
It may be necessary to install a USB mouse driver the first time you use the mouse.

#### Printer

A printer can be connected to one of the USB ports and used once the corresponding printer driver has been installed.

#### USB flash drive

A USB stick can be plugged into one of the USB interfaces.

#### Display

An external display unit can be connected to the DVI-I interface.

#### Ethernet network

The XP-503 can be connected to various computer networks using the two RJ45 ports that serve as Ethernet ports.

Ethernet is a standard used for local networks, and requires twisted-pair cables in order to connect the computers.

## 5.3 Using the storage media

### 5.3.1 CFast memory card

The CFast slot can be accessed at the bottom of the housing. The card adapter is screwed onto the housing's cover and is connected to a SATA interface on the board. A cover prevents the card itself from falling out. The card will come out from the bottom of the slot!

 **Note the specification for the CFast memory, at least 4GB.**

► Before changing the card, the device must be disconnected from the power supply.

Example: XP-503-15, The following also applies to other device versions as applicable.





Abb. 11 CFast memory card location

CAUTION	
	<p><b>Before changing the card, the device must be disconnected from the power supply</b></p> <p>A cover must be used to protect the card from falling out. The card will come out from the bottom of the slot!</p>

 The CFast card can be inserted and changed without opening the housing.

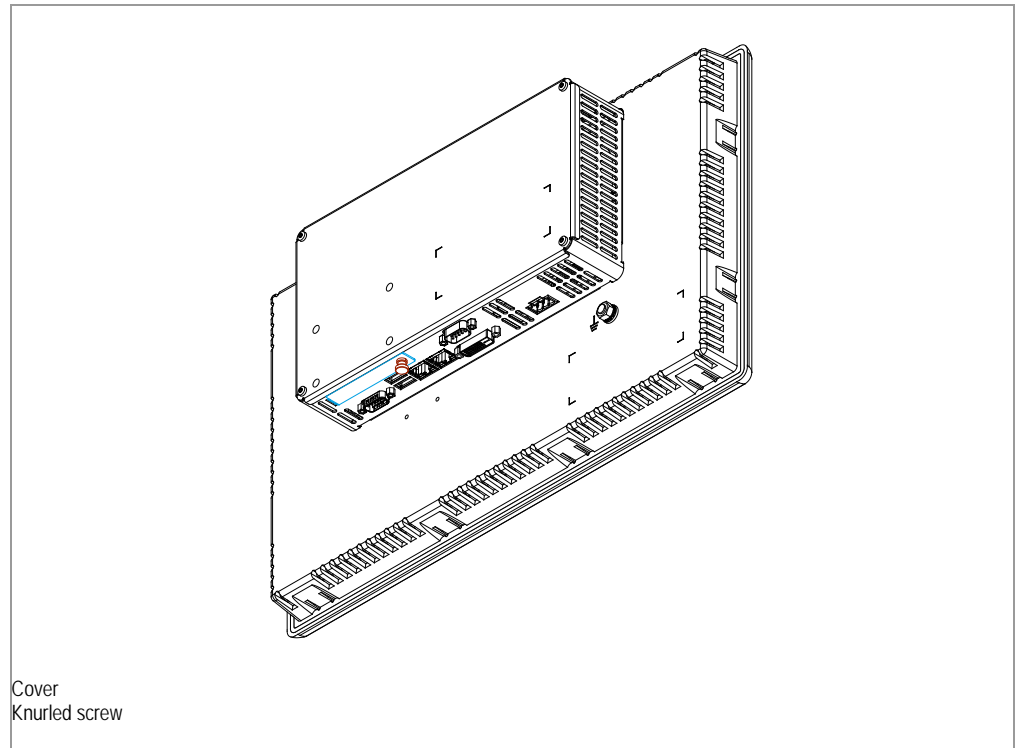
## 5 Commissioning and operation

### 5.3 Using the storage media

#### Changing the CFAST memory card

Example: XP-503-15, The following also applies to other device versions as applicable.



Abb. 12 Changing the CFAST memory card



## 5.4 Using the XP-503

### Touch panel

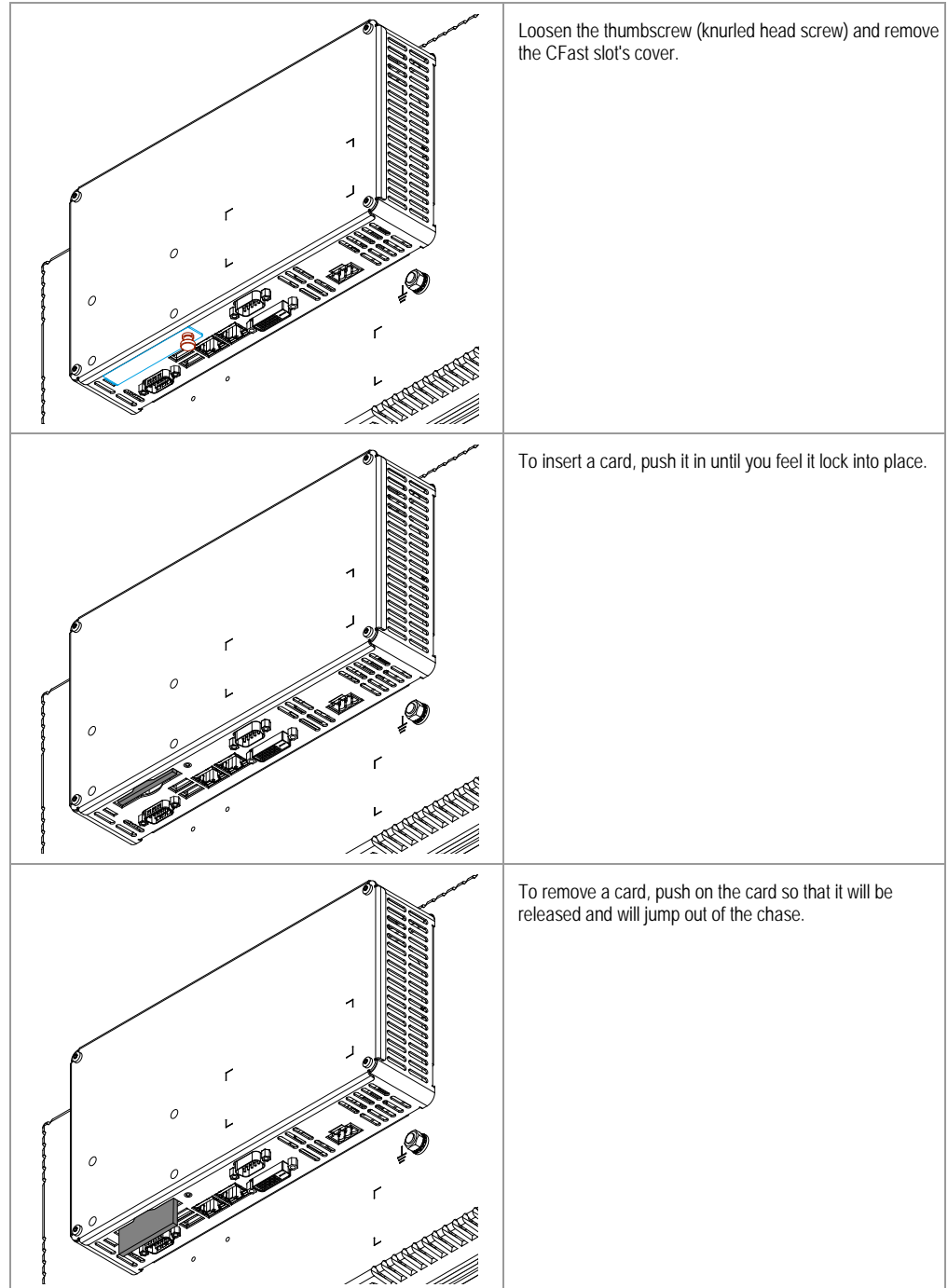
- Projected capacitive touch panel (PCT)
- Multi-touch capable
- 4-point touch operation
- 2-point touch operation when using the EMC touch sensitivity setting

The device features a touch panel with multi-touch capabilities. It is controlled by means of touching, inching, and gestures, all of which require the operator to touch the screen with their fingertips. More specifically, gestures can be carried out using multiple fingers at the same time.

## 5.5 Safety Warnings

Using the XP-503 entails additional risks associated with using a touch panel device with multi-touch capabilities

Observe the following instructions in order to keep you and others safe and avoid property damage.

### WARNING



#### Malfunctions when using a touch panel with multi-touch capabilities

There is always the possibility of an operator making errors when using the touch panel. These errors may result in bodily injury or property damage.

The following precautions will help prevent the accidental use of the malfunctions:

- Do not, under any circumstance, use the touch panel to control safety-relevant functions.
- Before cleaning the device, switch to a safe operating mode.  
Before performing maintenance work, disconnect it from the power supply.

### WARNING



#### Incorrectly using the multi-touch functions

Performing gestures incorrectly on the touch panel can result in system operation errors and, consequently, in bodily injury.

Before using the device, make sure you are thoroughly familiar with the Windows operating system's multi-touch functions, as well as with the application you will be using and its functions. Make sure that the gestures you perform on the multi-touch display will be recognized by the application. It may be necessary to practice certain gestures beforehand.

## 5 Commissioning and operation

### 5.5 Safety Warnings

#### WARNING



#### **Risk of functions being triggered accidentally by conductive material in soiling**

If the device's touch panel is soiled, any conductive material present in the dirt may trigger unexpected operator actions. When functions are triggered incorrectly in the system, bodily injury and property damage may occur.

Keep the touch panel clean at all times and take suitable measures in order to protect it from soiling.

Before using the device, check which types of potential soiling may accumulate on the touch panel and which functions may be triggered incorrectly as a result.

#### WARNING



#### **Potential damage when installing and operating the device**

Scratches and other damage on the device's glass panel may trigger unexpected operator actions. When functions are triggered incorrectly in the system, bodily injury and property damage may occur.

Make sure that the glass panel is not damaged during installation or use.

#### WARNING



#### **Dangerous currents when installing and connecting the device**

Connecting the device incorrectly may result in dangerous currents and overvoltage being produced.

Always connect the protective conductor before anything else.

 **WARNING**

 **Performing gestures incorrectly on the touch panel with multi-touch capabilities**

If gestures are performed incorrectly on the touch panel with multi-touch capabilities, they may not be recognized or they may be recognized incorrectly. When this occurs, the device will either not respond to the operator's input or will respond in a wrong or unexpected way.

Observe the following when using the touch panel with multi-touch capabilities:

- The touch panel responds to contact on its surface, not to pressure.
- If using a stylus:  
Make sure to specifically use a capacitive touch panel stylus.
- If using your fingers:
  - Make sure to only use your fingertips.
  - Do not use your fingernails to operate the touch panel.
- Do not use thick gloves when operating the touch panel, e.g., work gloves.
- You may wear the following types of gloves:
  - Thin cotton gloves,
  - Rubber-coated gloves
  - Latex gloves
  - Capacitive touch panel gloves
- Touch the touch panel perpendicularly, not at an angle.
- Make sure you do not touch the screen accidentally, e.g., with your knuckles or by leaning against the display or using it for support.
- Make sure to always keep the touch panel clean.
- Always check to make sure that the device has recognized the operator actions you have entered.

### 5.5.1

#### Commissioning

##### Windows operating system



**Note:**

Taking appropriate precautions will make it possible to prevent other malfunctions while the device is running.

## 5 Commissioning and operation

### 5.5 Safety Warnings

#### SleepTime

CAUTION	
	<p><b>Updating the display required</b></p> <p>If the hibernation function is used, the image shown on the device may change after the device wakes up from hibernation.</p>



#### Disabling hibernation

To disable hibernation in the Windows operating system, go to "Start→Control Panel→Hardware and Sound→Power Options" and navigate through the appropriate options.

#### Screen saver

CAUTION	
	<p><b>Not intended triggering of functions</b></p> <p>A wake-up event will cause the operating system to resume and the screen saver to stop running. In devices with multi-touch capabilities, touching the touch panel once will cause the operating system to resume (i.e., trigger a wake-up event).</p> <p>If the touch panel is displaying available functions before the screen saver starts running, this first contact may cause the corresponding functions to be triggered.</p>





#### Disabling the screen saver

To disable the screen saver in the Windows operating system, go to "Start→Control Panel→Appearance and Personalization→Display" and navigate through the appropriate options.

CAUTION	
	<p><b>Make sure that important operating functions can only be triggered by using multiple fingers at the same time</b></p> <p>Important operating functions must be programmed in such a way that they can only be triggered by gestures requiring multiple fingers on the touch panel at the same time.</p>

Static touch panel contact

CAUTION	
	<p><b>Time out</b></p> <p>Contacts and gestures in which fingers do not move on the touch panel for more than 10 seconds will be recognized as "static contact."</p> <p>If the device detects this type of contact, the desired function will no longer be carried out after approx. 10 seconds. This is intended to prevent disruptions caused by soiling on the touch panel (e.g., saline solution on the glass panel).</p>

-  **Avoiding static contact and continuing to run intended functions**
- After approx. 10 seconds, touch the corresponding icon on the touch panel again and check the results.
  - If you will be using an operator action for an extended continuous period of time, move your finger(s) slightly during the process.

CAUTION	
	<p><b>Static contact during booting</b></p> <p>If there is static contact on the touch panel during booting, this may result in functional restrictions.</p> <p>This can be prevented by taking the following measures:</p> <ul style="list-style-type: none"><li>■ Do not touch the touch panel during booting!</li><li>■ If you do touch it, make sure to move your finger(s) slightly!</li></ul>

## 5 Commissioning and operation

### 5.6 XP-503 with Windows Embedded Standard 7

#### 5.6 XP-503 with Windows Embedded Standard 7

The XP-503 standard devices are pre-installed with the Microsoft Windows Embedded Standard 7 operating system. If your XP-503 is not a standard device or is operated with a different operating system these operating system specific descriptions may or may not apply to your device.

The general functions of the Windows Embedded Standard 7 operating system can be found in the open-access system descriptions from Microsoft®.

The following instructions describe only specific functions of the XP-503 standard devices operating with the Windows Embedded Standard 7 operating system.

##### 5.6.1 Protect Mode (Operated with two drives, C:\ and D:\)

The Eaton XP-503 family of products running the Windows Embedded Standard 7 operating system have a unique and exclusive Protect Mode™ feature that safeguards the integrity of files stored on the C:\ drive of your operating system. This feature ensures that data and operating system files cannot be modified by anyone or corrupted by unexpected power disruptions. As a result, you can be confident that the XP-503 meets your rigorous industrial environmental requirements and can be protected against all unauthorized alterations.

If Protect Mode is enabled, file write operations such as "delete," "edit," and "create new" will be executed in temporary memory only. When the device is restarted, these write operations will be deleted and the protected data storage medium will have all its original data intact, i.e., the device will always start in its original state. This means that any file changes that need to be made on drive C:\ (operating system settings, installed software) must be carried out either with Protect Mode disabled or using the appropriate special Protect Mode functions in order to save the changes permanently.

This applies to the following settings:

- Operating system functionality
- Time/date data
- Ethernet port settings
- Windows registry settings
- Windows driver installations
- Visualization runtime software and communications drivers
- Visualization project files

The Protect Mode feature is based on the Windows Embedded EWF (Enhanced Write Filter) function. Descriptions of the detailed manual operations can be found on the Internet.

### Protect-Mode data organization

C:\ drive

→ Protected by Protect Mode when enabled

Files to be installed and changed only at initial device setup and should remain unchanged under normal operation.

Other drives (such as D:\)

→ Not protected, even when Protect Mode is enabled

Files to be stored through normal operations: process data, trends, recipes, alarm lists, ...

 If Protect Mode is active and extensive changes are made to the C:\ drive (e.g. software installations), volatile memory may become full resulting in system errors.

### Protect Mode Save Operation

When the Protect Mode is active the unit is protected against any changes to data stored on the C:\ drive. In order to save desired data changes to the C:\ drive the Protect Mode Save operation must be run

 Extensive changes to C:\ drive (software installations) must be executed with Protect Mode disabled.

It is good practice to shut down and re-start the XP-503 in preparation of making permanent changes to the C:\ drive. This step will ensure that all data stored in volatile memory is cleared so that no unexpected corruption or changes will take place on your C:\ drive. Once the XP-503 has been restarted, make your changes and then save the changes by selecting "Start→All Programs→Eaton→Protect Mode Manager". From the Protect Mode Manager window select the "Protect Mode Save" tab and click on the "Commit" button.

Once the Protect Mode Save operation has been launched, the changes that affect the C:\ drive will be saved and then the device will automatically shut down and then restart, back in Protect Mode.

## 5 Commissioning and operation

### 5.6 XP-503 with Windows Embedded Standard 7

#### Disabling Protect Mode

Protect Mode is active and enabled at the factory but it is possible for the user to disable the Protect Mode feature. Reasons for doing so include the need to install a software program that is very large or one that requires multiple reboots to complete its installation.

To do so, open Protect Mode Manager by selecting "Start→All Programs→Eaton→Protect Mode Manager". From the Protect Mode Manager window select the "Advanced" tab and click on the "Disable Protect Mode Save" button. The system will then reboot and flush any pending changes to the protected C:\ drive. Upon reboot Protect Mode will be disabled and while in this mode the XP unit will behave like any other Windows PC, meaning that it is subject to all forms of malware including viruses, and adware and it must be shut down through the normal Windows shutdown mechanism to prevent potential corruption of the operating system.

It is recommended that the XP-503 unit be removed from any plant network while Protect Mode is disabled and that all media used for software installation to be connected to the unit are scanned for malware prior to attachment.



**We recommend to operate the device always with protect mode activated.**

#### Enabling Protect Mode

Once all desired changes have been made the user should place the XP unit back in Protect Mode through the Advanced tab of the Protect Mode Manager utility (Start→All Programs→Eaton→Protect Mode Manager) by clicking on the "Enable Protect Mode Save" button. This will force a reboot and return the XP-503 unit to its normal protected state.



## 5.6.2

### Managing Accounts and Auto Logon functionality

#### Managing Accounts

There is an "Administrator" user account set up on your Eaton XP-503 unit when shipped from the factory.

User: „Administrator“  
Password: „Administrator“ (passwords are case sensitive)

The XP-503 is set up to automatically log in to the Administrator account, which is why the normal Windows Security dialog box does not appear upon boot-up.

#### Modifying an Account Name or Password

You can modify the "Administrator" and any other account name password from the "User Accounts" utility in "Control Panel" (Start  Control Panel  User Accounts).

Once the Administrator password has been successfully modified you must follow the Account Auto Logon Feature section in order to continue to automatically log in to the Administrator account at boot-up.

 All changes made to the C:\ drive when Protect Mode is active must be saved or committed so that the next time the XP-503 is restarted the changes will be retained. Refer to the "Protect Mode" section for additional information.

#### Account Auto Logon Feature

The Account Auto Logon function can be used if you want the device to start directly with a user profile already logged in so that application software can be used right away. When you use this option, a user login dialog box will not appear at the beginning and the aforementioned user profile will be automatically logged in. By default, the "Auto Logon" function will be enabled for the "Administrator" user.

If you want to change the "Auto Logon" features, refer to the descriptions below.

Windows: "Start(Run", type "control userpasswords2" and press OK.

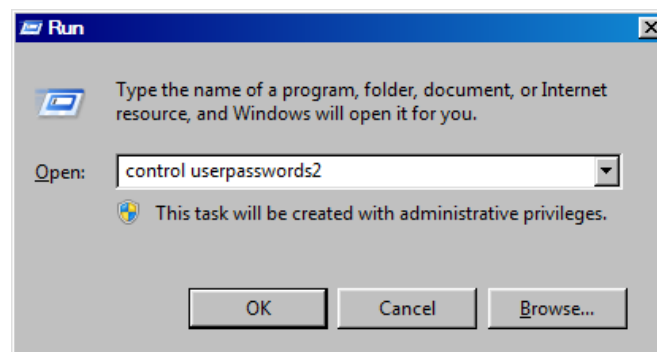

## 5 Commissioning and operation

### 5.6 XP-503 with Windows Embedded Standard 7

Following dialog box appears:

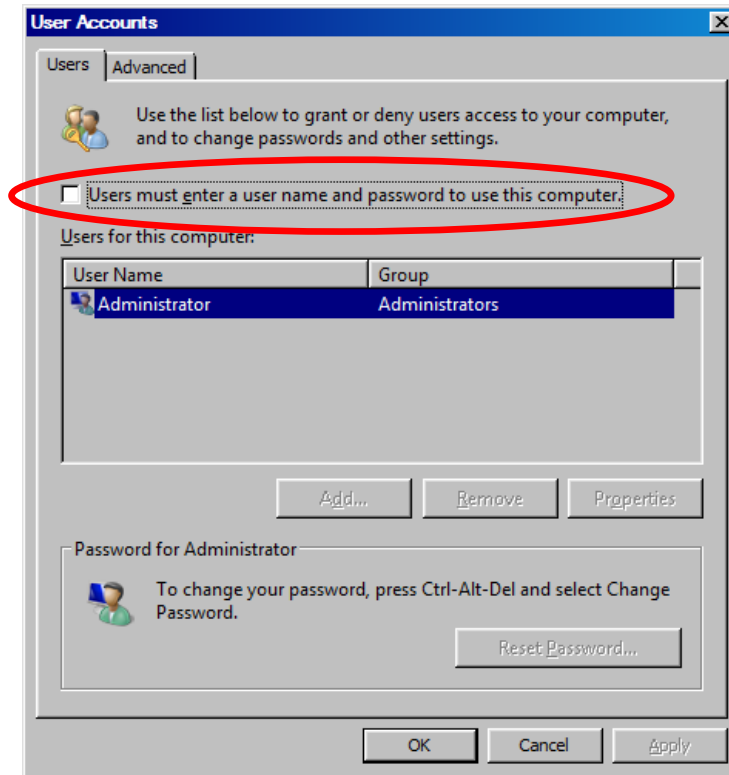

Use the Check box "Users must enter a user name and password to use this computer" to enable/disable the "Auto Logon" feature.

Check box "checked": ( „Auto Logon" is not activated  
Check box empty: ( „Auto Logon" is enabled,  
when enabling a dialog box appears for you  
to enter the username and password.

### 5.6.3

#### Touch parameters

The XP-503's touch panel has three sensitivity settings available. To select one of them, use the routine described below:

- Option "1": Default (factory setting)  
For example: fingertips, no gloves
- Option "2": Gloves  
Sensitivity setting for controlling the touch panel while wearing gloves
- Option "3": EMC  
No functional restrictions if EMC interference is up to 20% higher than normal, e.g. highly EMC loaded environment through devices with electromagnetic fields

#### Set parameters

- In the Windows operating system, go to "Start→All Programs→Eaton→TouchParameter".

The cmd window will open.

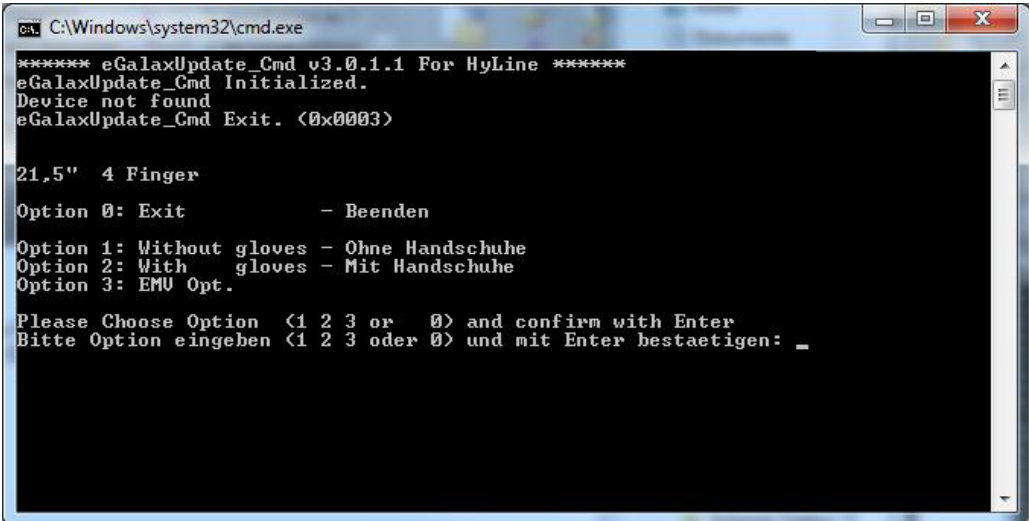

```
C:\Windows\system32\cmd.exe
***** eGalaxUpdate_Cmd v3.0.1.1 For HyLine *****
eGalaxUpdate_Cmd Initialized.
Device not found
eGalaxUpdate_Cmd Exit. (0x0003)

21,5" 4 Finger
Option 0: Exit          - Beenden
Option 1: Without gloves - Ohne Handschuhe
Option 2: With gloves  - Mit Handschuhe
Option 3: EMU Opt.

Please Choose Option (1 2 3 or 0) and confirm with Enter
Bitte Option eingeben (1 2 3 oder 0) und mit Enter bestaetigen: _
```

- Select the setting you want to use:
  - 1 Standard
  - 2 Glove
  - 3 EMC
- Confirm by pressing the Enter key.

The program will start.

## 5 Commissioning and operation

### 5.6 XP-503 with Windows Embedded Standard 7

Once the program is successfully completed, the following line will appear:  
"Firmware update Success."

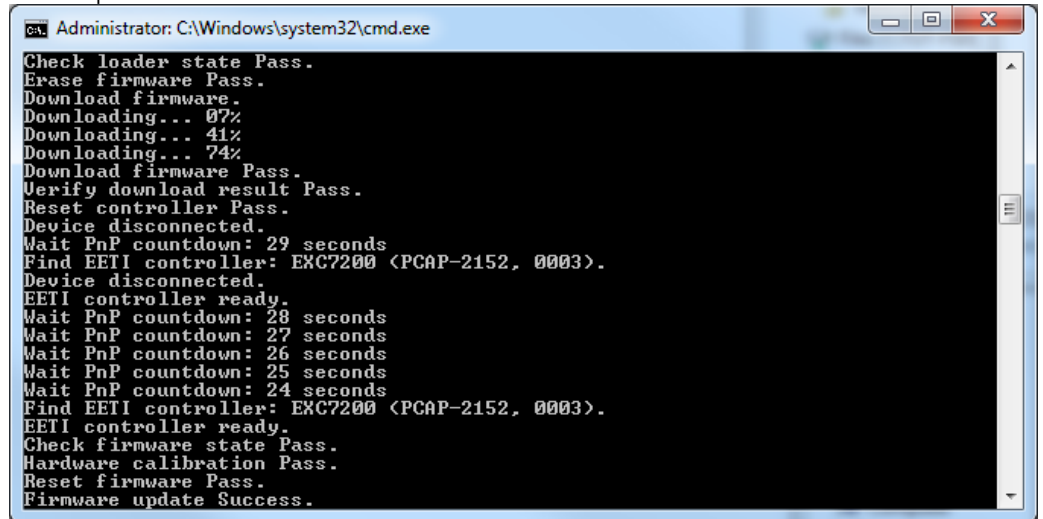

```
Administrator: C:\Windows\system32\cmd.exe
Check loader state Pass.
Erase firmware Pass.
Download firmware.
Downloading... 07%
Downloading... 41%
Downloading... 74%
Download firmware Pass.
Verify download result Pass.
Reset controller Pass.
Device disconnected.
Wait PnP countdown: 29 seconds
Find EETI controller: EXC7200 (PCAP-2152, 0003).
Device disconnected.
EETI controller ready.
Wait PnP countdown: 28 seconds
Wait PnP countdown: 27 seconds
Wait PnP countdown: 26 seconds
Wait PnP countdown: 25 seconds
Wait PnP countdown: 24 seconds
Find EETI controller: EXC7200 (PCAP-2152, 0003).
EETI controller ready.
Check firmware state Pass.
Hardware calibration Pass.
Reset firmware Pass.
Firmware update Success.
```

The program will return to the starting screen.

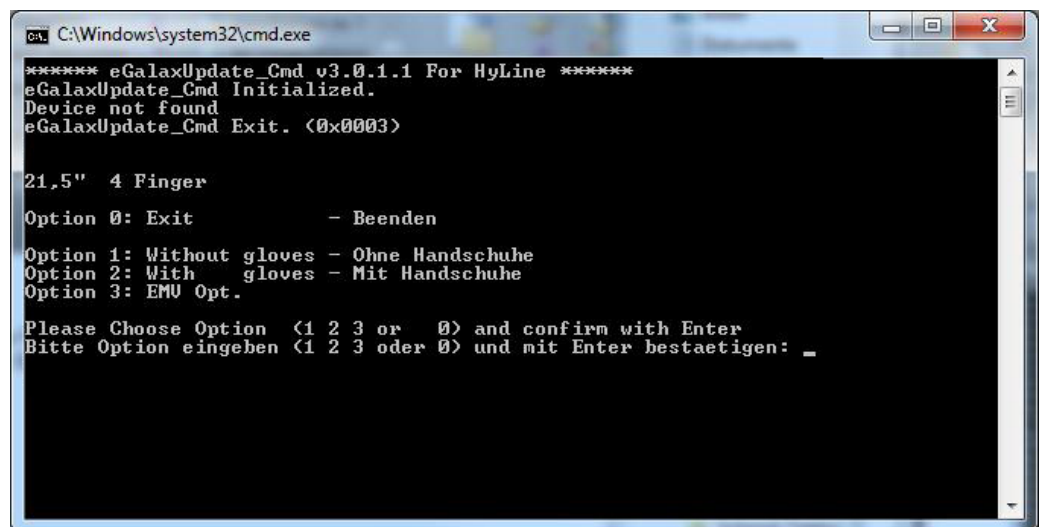

```
C:\Windows\system32\cmd.exe
***** eGalaxUpdate_Cmd v3.0.1.1 For HyLine *****
eGalaxUpdate_Cmd Initialized.
Device not found
eGalaxUpdate_Cmd Exit. (0x0003)

21,5" 4 Finger

Option 0: Exit - Beenden
Option 1: Without gloves - Ohne Handschuhe
Option 2: With gloves - Mit Handschuhe
Option 3: EMU Opt.

Please Choose Option (1 2 3 or 0) and confirm with Enter
Bitte Option eingeben (1 2 3 oder 0) und mit Enter bestaetigen: _
```

- Select '0'.
- Press the Enter key to exit the program.

#### 5.6.4 License Eaton Galileo-Open Runtime

XP-503 device types, which are licensed for Eaton Galileo Open Runtime, are licensed at the factory for the Galileo runtime software and enabled with 340 license points. Shipped from the factory only the license is installed on the device, the Galileo Open runtime software and the project files need to be transferred by the Galileo Development Software tools to the XP-503 (device selection Galileo Open) from the development PC. For further information on these tools consult the Galileo software manuals.

#### 5.6.5 License Eaton Visual Designer Runtime

XP-503 device types, which are licensed for Eaton Visual Designer runtime, are licensed at the factory for Eaton Visual Designer runtime and enabled with 4000 Tags, 5 drivers, and one each of the three web client types (Thin Client, Secure Viewer, and Mobile Access). Shipped from the factory the license is installed on the device and a recent version of Visual Designer runtime is installed. Further information about Visual Designer and how to update the software version and download the runtime project consult the Visual Designer software manual and help files.

## 5 Commissioning and operation

### 5.6 XP-503 with Windows Embedded Standard 7

## 6 Maintenance and repairs

### 6.1 Safety instructions

 Before working with the device, make sure to read chapter 3, "Safety instructions." Chapter 3 contains important information regarding your own personal safety,

### 6.2 Maintenance

Capacitive touch devices do not require maintenance. However, the following work may need to be carried out:

- Cleaning the capacitive touch panel when soiled.

#### 6.2.1 Cleaning the capacitive touch panel

CAUTION	
	<p><b>Cleaning the device</b></p> <p>The device can be damaged by pointy or sharp objects, as well as by liquids.</p> <ul style="list-style-type: none"><li>■ Do not use any pointy or sharp objects (e.g., knives) to clean the device.</li><li>■ Do not use aggressive or abrasive cleaning products or solvents.</li><li>■ Prevent liquids from getting into the device (short-circuit hazard).</li><li>■ Clean only with a clean soft antistatic damp cloth</li></ul>

Carefully clean the capacitive touch panel with a clean, soft, antistatic damp cloth.

- If there are any spots that are proving difficult to get off, spray a little dishwashing liquid on the damp cloth first.

#### 6.2.2 Battery

The battery in the device can be replaced.

### 6.3 Repairs

The device should only be opened by the manufacturer or by an authorized repair center.

For repairs, please contact your vendor or Eaton's Technical Support.

Use the original packaging to ship the device.

## 6 Maintenance and repairs

### 6.3 Repairs



## 7 Storage, transport and disposal

### 7.1 Safety instructions



Before installing and commissioning the device, make sure to read chapter 3, "Safety instructions." Chapter 3 contains important information regarding your own personal safety,

### 7.2 Storage

The ambient conditions for storage need to be met.

### 7.3 Transport

When transporting or shipping the device, make sure that the device is not damaged (use appropriate packaging).

All ambient conditions need to be met during transportation and shipping as well.



Check the device for transit damage after arrival.

## 7 Storage, transport and disposal

### 7.4 Disposal

#### 7.4

#### Disposal

 <b>Danger</b>	
	<p><b>Explosive and toxic materials</b></p> <p>The lithium battery inside the device may explode if handled incorrectly.</p> <p>▶ Dispose of the device professionally.</p>

Devices no longer being used must be professionally disposed of as per local standards or returned to the manufacturer or relevant sales department.

#### Materials used in the device

Assembly part	Material characteristic
Display housing	Aluminium die-cast Powder-spray painted surface RAL 9006, white aluminum
Housing	Galvanized sheet steel Sheet thickness 1 mm
Cover glass	Tempered glass across the entire surface (tempered soda-lime glass) Non-glare surface (chemically micro etched); gloss: 85 Designer bezel with direct-to-glass printing RAL 9005 jet black Thickness: 3 mm (XP-503-10) Thickness: 3 mm (XP-503-15) Thickness: 4 mm (XP-503-21)
Battery	Lithium CR2032, 3.0 V, 220 mAh, Panasonic
■ Battery weight	3.4 g
■ SVHC Substance	1,2-dimethoxyethane: ethylene glycol dimethyl ether (EGDME)
■ Substance weight	2-4 %
Electrical components	Various

Tab. 10 Materials used in the device

#### Materials used in the packaging

Packaging	Material characteristic
Outer packaging	Cardboard
Inner packaging	

Tab. 11 Materials used in the packaging

8 Technical data

8.1 Dimensions for XP-503 with 25.65 cm (10.1") display

8.1.1 Front dimensions

XP-503-10



Abb. 13 XP-503-10 – front dimensions

## 8 Technical data

### 8.1 Dimensions for XP-503 with 25.65 cm (10.1") display

#### 8.1.2

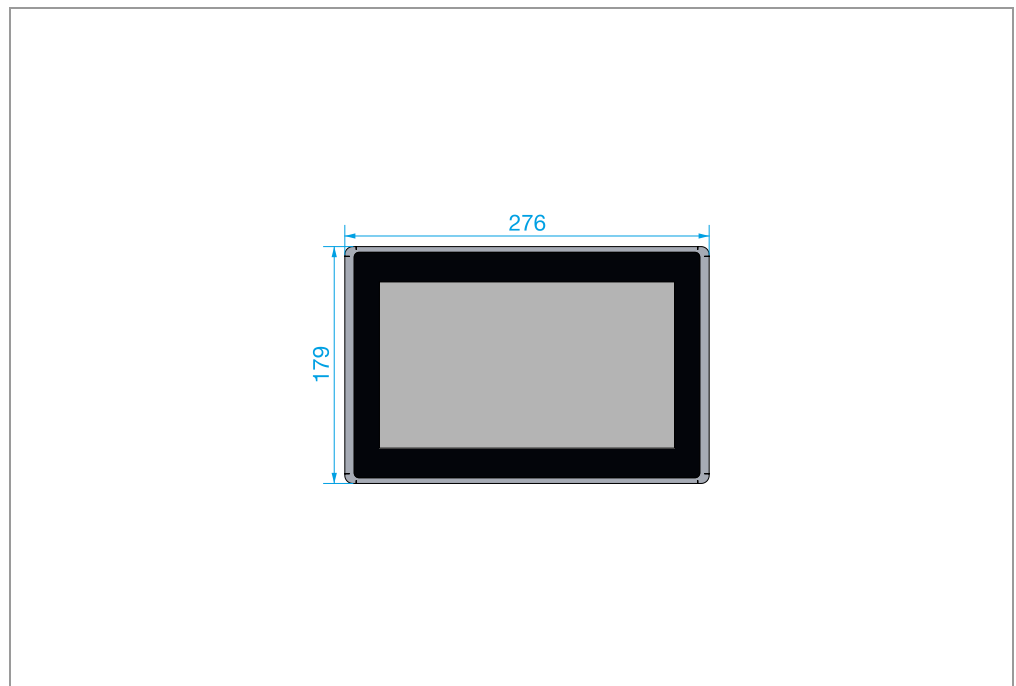
#### Device dimensions

XP-503-10



Abb. 14 XP-503-10 – device dimensions

8.1 Dimensions for XP-503 with 25.65 cm (10.1") display

8.1.3

Fitting dimensions

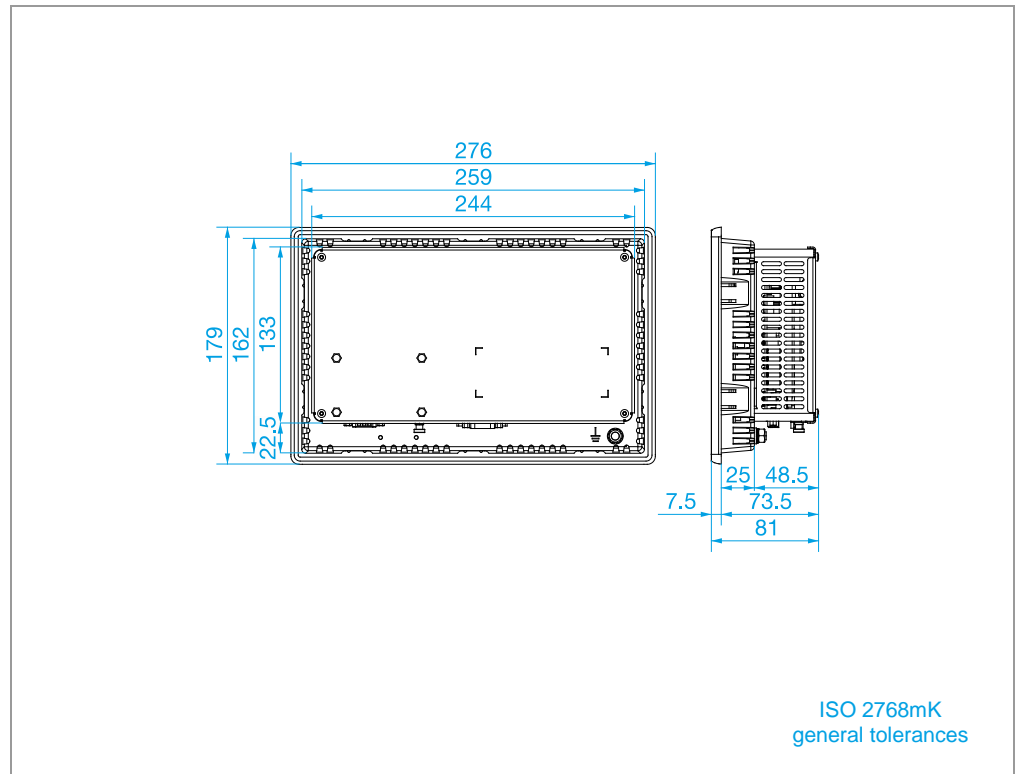
XP-503-10

Recommended mounting cutout



Abb. 15 XP-503-10 – fitting dimensions

## 8 Technical data

### 8.2 Dimensions for XP-503 with 39.6 cm (15.6") display

#### 8.2 Dimensions for XP-503 with 39.6 cm (15.6") display

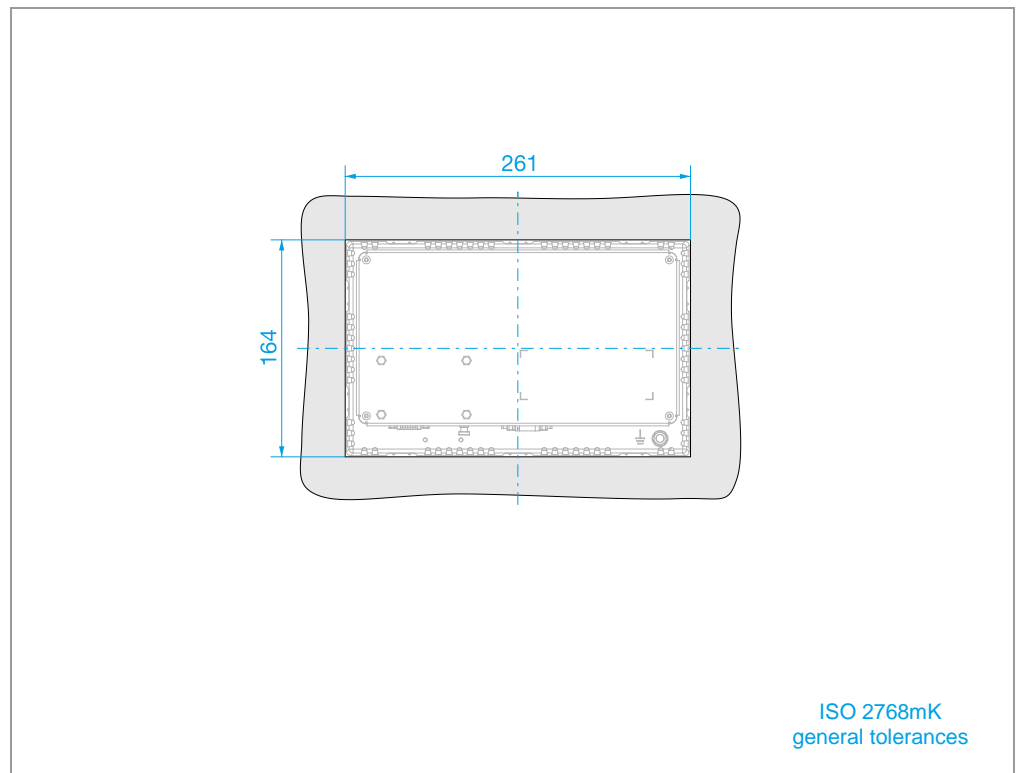
##### 8.2.1 Front dimensions

XP-503-15



Abb. 16 XP-503-15 – front dimensions

8.2.2

Device dimensions

XP-503-15

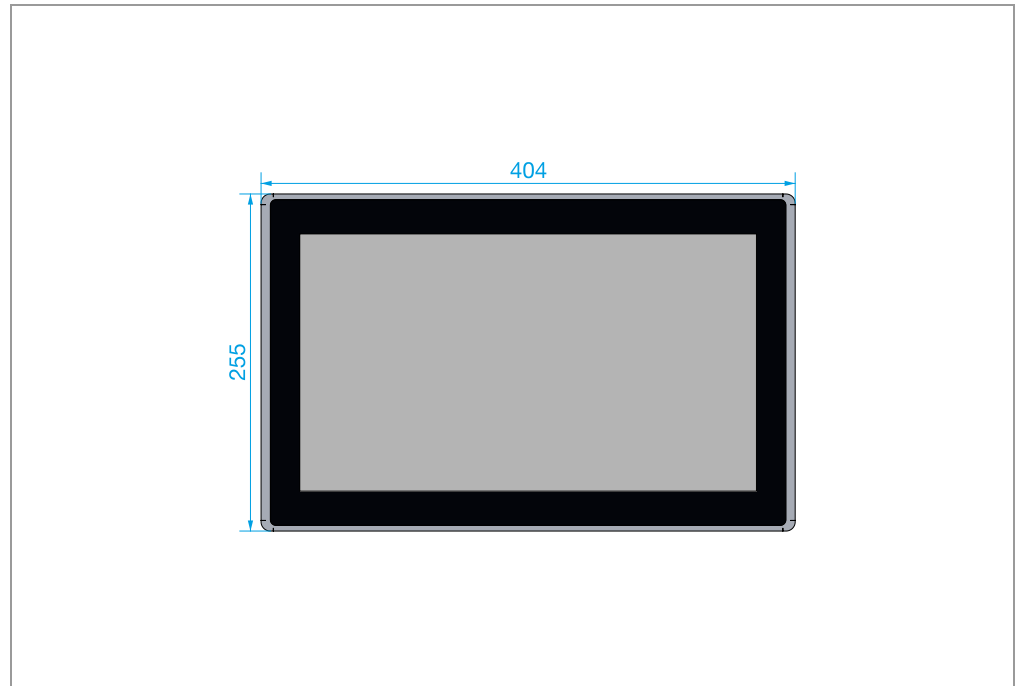

Abb. 17 XP-503-15 – device dimensions

## 8 Technical data

### 8.2 Dimensions for XP-503 with 39.6 cm (15.6") display

#### 8.2.3

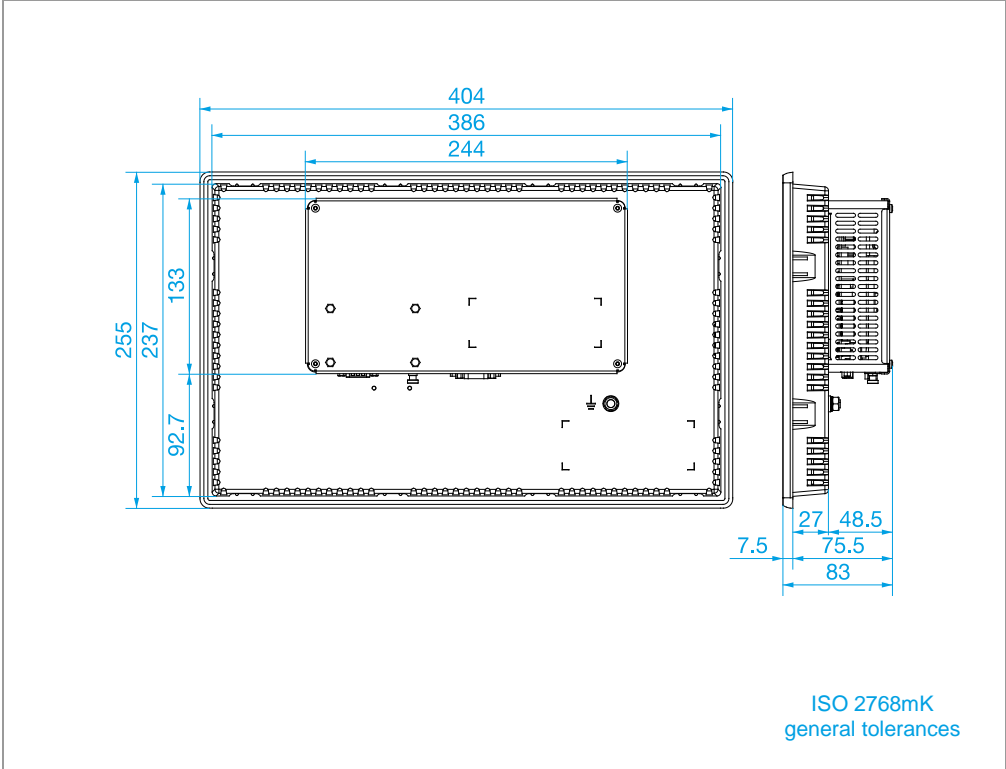
#### Fitting dimensions

XP-503-15

Recommended mounting cutout



Abb. 18 XP-503-15 – fitting dimensions



8.3 Dimensions for XP-503 with 54.6 cm (21.5") display

8.3 Dimensions for XP-503 with 54.6 cm (21.5") display

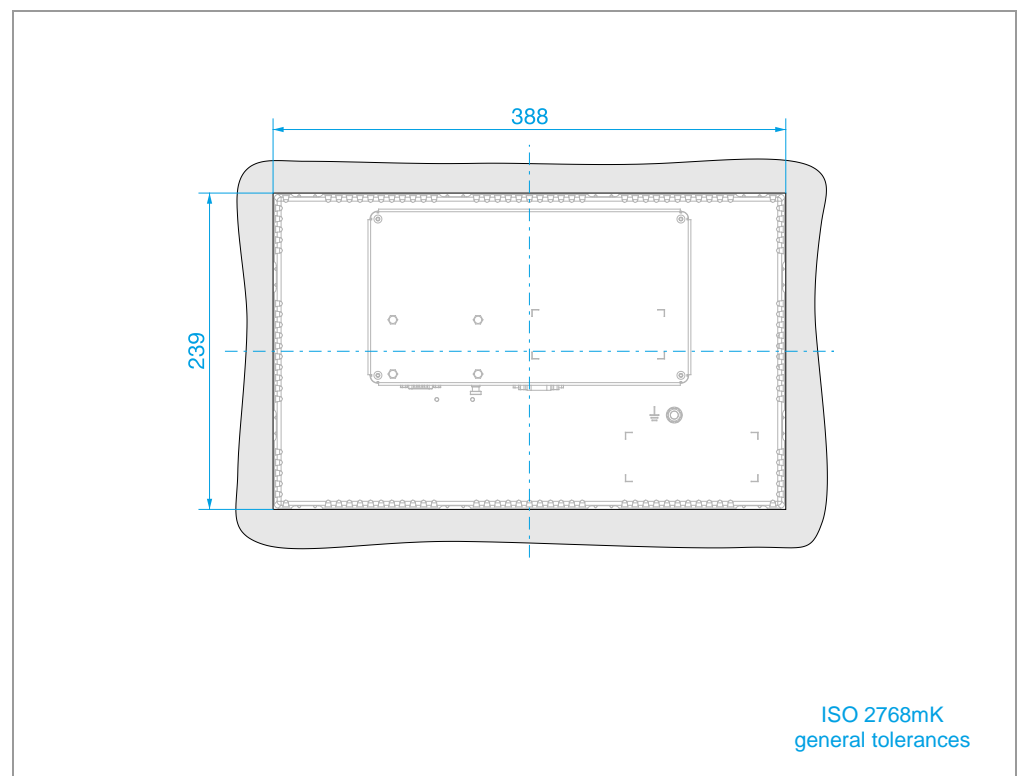
8.3.1 Front dimensions

XP-503-21



Abb. 19 XP-503-21 – front dimensions

## 8 Technical data

### 8.3 Dimensions for XP-503 with 54.6 cm (21.5") display

#### 8.3.2

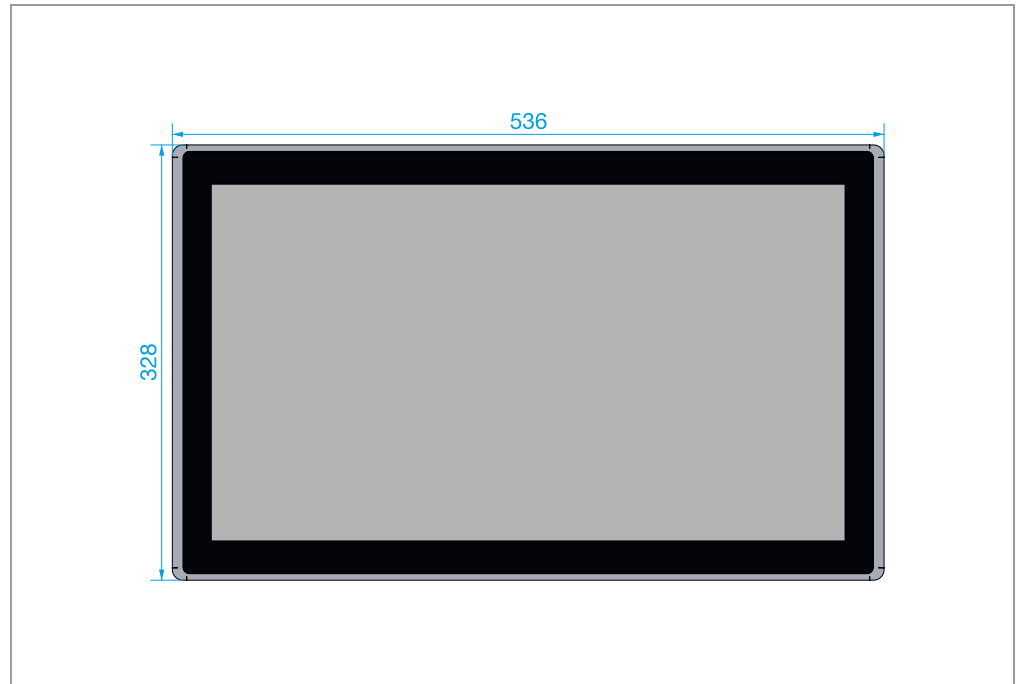
#### Device dimensions

XP-503-21



Abb. 20 XP-503-21 – device dimensions

8.3 Dimensions for XP-503 with 54.6 cm (21.5") display

8.3.3

Fitting dimensions

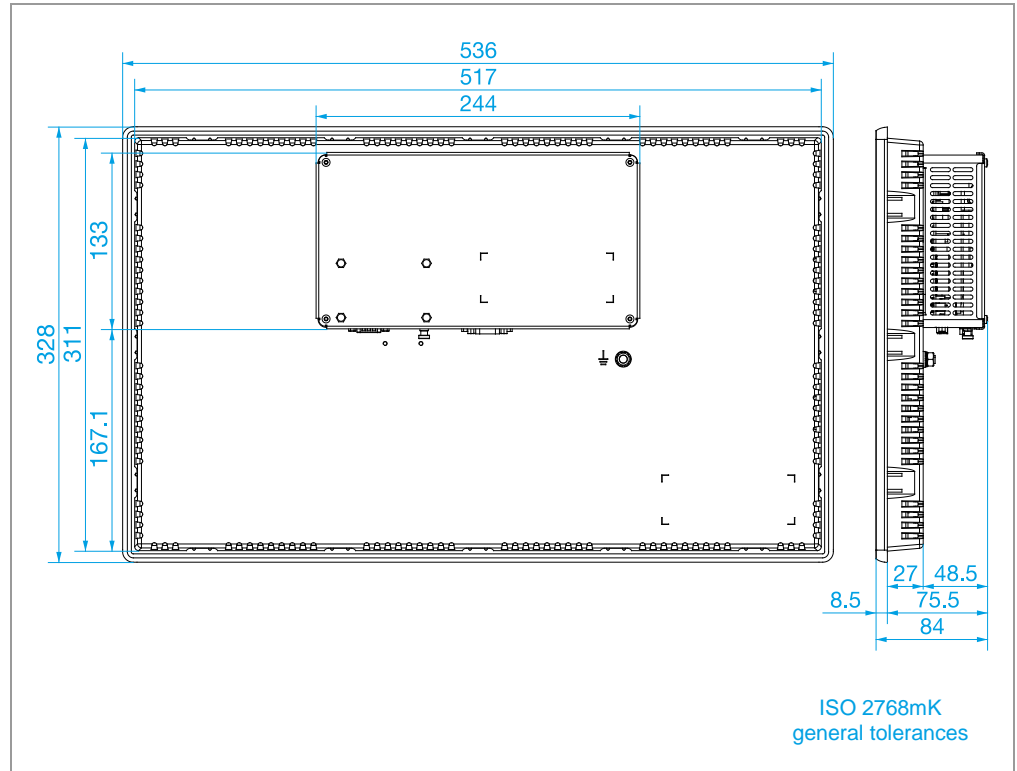
XP-503-21

Recommended mounting cutout



Abb. 21 XP-503-21 – fitting dimensions

## 8 Technical data

### 8.4 General

#### 8.4

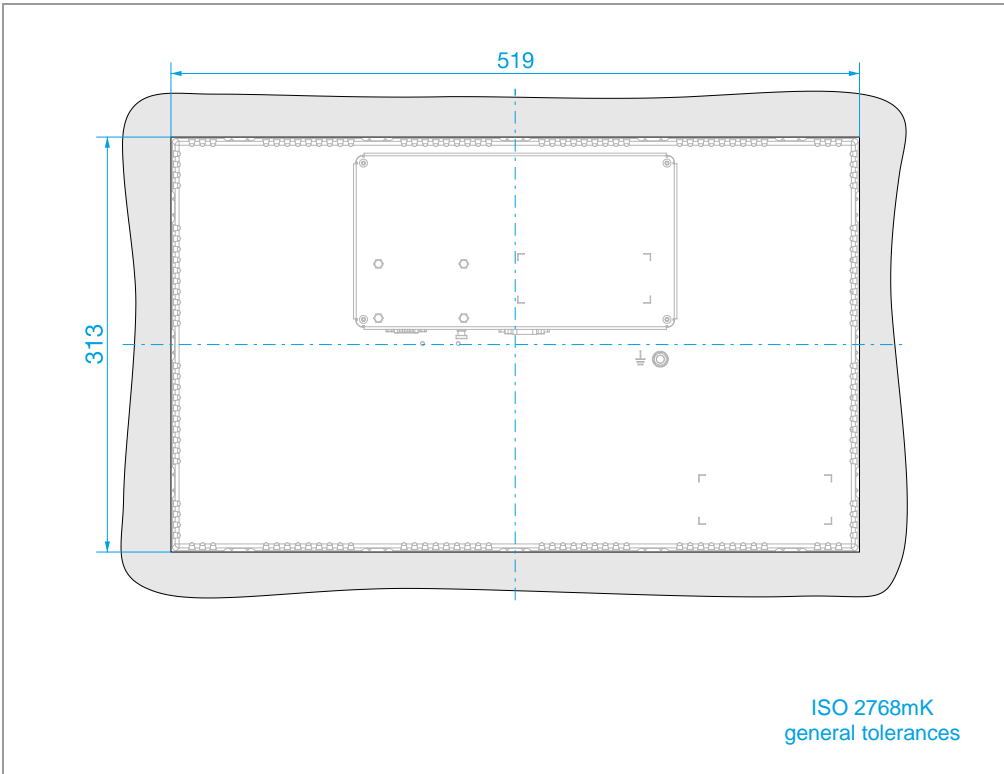
#### General

Component	description
Device system	Flush-mounting panel PC
	Built-in device
	Secured with the help of holding brackets
Enclosure material	Industrial housing design built to meet EMC requirements
Display housing (incl. front frame)	Aluminium die-cast
	Powder-spray painted surface
	RAL 9006, white aluminum
Computer housing	Galvanized sheet steel
	Sheet thickness 1 mm
Cover glass	Tempered glass across the entire surface (tempered soda-lime glass)
	Non-glare surface (chemically micro etched): gloss: 85
	Designer bezel with direct-to-glass printing
	RAL 9005 jet black
	Thickness: 3 mm (XP-503-10)
	Thickness: 3 mm (XP-503-15)
Keypad	Thickness: 4 mm (XP-503-21)
	Projected capacitive touch panel (PCT)
	Multi-touch capable, 4-point touch operation
	PCT sensor laminated on the back of the glass panel
	ITO-based touch sensor
Touch controller connected to computer board via USB interface	
	Safe PCT function by using a functional earth with as low a resistance as possible: minimum cross-sectional area of 6 mm <sup>2</sup>

Tab. 12 Technical data

## 8 Technical data

### 8.4 General

<b>Display</b>	
<b>10.1"</b>	
Part no.	Color active-matrix TFT-LCD
Screen size diagonal	25.65 cm (10.1")
Visible screen area	222.72 mm x 125.28 mm
Display resolution [W x H]	WSVGA / 1024 x 600 pixels
Format	16:9
Viewing range [left/right/above/below]	normally 70°/70°/70°/50°
Color resolution	262144 colors
Contrast ratio (Normally)	normally 500:1
Brightness	normally 550 cd/m <sup>2</sup>
<b>Backlight</b>	
Technology	Single LED (side-light type)
Life point	50000 h
<b>15.6"</b>	
Part no.	Color active-matrix TFT-LCD
Screen size diagonal	39.6 cm (15.6")
Visible screen area	344.232 mm x 193.536 mm
Display resolution [W x H]	WXGA / 1366 x 768 pixels
Format	16:9
Viewing range [left/right/above/below]	normally 85°/85°/80°/80°
Color resolution	16.7 million colors
Contrast ratio (Normally)	normally 500:1
Brightness	normally 300 cd/m <sup>2</sup>
<b>Backlight</b>	
Technology	LED
Life point	50000 h
<b>21.5"</b>	
Part no.	Color active-matrix TFT-LCD
Screen diagonal	54.6 cm (21.5")
Visible screen area	476.64 mm x 268.11 mm
Display resolution [W x H]	WUXGA / 1920 x 1080 pixels
Format	16:9
Viewing range [left/right/above/below]	normally 89°/89°/89°/89°
Color resolution	16.7 million colors
Contrast ratio (Normally)	normally 5000:1
Brightness	normally 300 cd/m <sup>2</sup>
<b>Backlight</b>	
Technology	LED
Life point	50000 h

Tab. 13 Technical data

## 8 Technical data

### 8.4 General

<b>Cooling</b>	Fanless CPU and system cooling, natural convection-based passive cooling
<b>Computer platform</b>	Single-board computer 3.5" card format (102 mm x 147 mm) AMD Radeon HD8000 chipset
<b>BIOS</b>	AMI UEFI
<b>CPU</b>	AMD eKabini GX-217GA DC (1.6 GHz) Dual-core version of "eKabini" of the SoC (System on Chip) G-series
<b>Cache memory</b>	1 x base (204-pin DDR3 SO-DIMM, 1066/1333 MHz), max. 8 GB
4 GB	1 x 4 GB DDR3-1333 SDRAM SO-DIMM
<b>External Interfaces</b>	2 x Ethernet 10/100/1000 MBit/s 2 x USB 3.0 1 x DVI-I 1 x serial: RS 485/232, configurable in BIOS; default setting: half-duplex RS 485 1 x serial: RS 232
<b>Flash memory</b>	Industrial flash technology
mSATA	1 x mSATA (internal) Min. 32 GB
CFast	1 x CFast slot (externally accessible) Min. 4 GB
<b>Operating system</b>	
...-1B	Windows Embedded Standard 7 Kit "P" (64-Bit) Galileo Runtime License
...-1V	Windows Embedded Standard 7 Kit "P" (32-Bit) Visual Designer runtime license

Tab. 14 Technical data

## 8 Technical data

### 8.4 General

<b>Supply voltage</b>	
24 V DC <sup>1)</sup>	18.36 V DC (SELV) The applied voltage must meet the requirements for safety extra-low voltages (SELV) set forth in IEC 60950 and – in connection with the UL listing – the requirements for a low-voltage source set forth in UL 508!
<b>Power consumption</b>	
XP-503-10	max. 1.2 A
XP-503-15	max. 1.5 A
XP-503-21	max. 1.7 A
<b>Mechanical dimensions</b>	
	Depends on the specific device version
<b>Weight</b>	
XP-503-10	2.70 kg
XP-503-15	4.95 kg
XP-503-21	7.55 kg
<b>Ambient air temperature</b>	
Operation (vertical ±10° mounting position)	0 °C to +50 °C [system with CFast, SSD, mSATA memory] (with natural convection)
	+5 °C to +50 °C [system with HDD] (with natural convection)
Storage	-20 °C to +60 °C
<b>Relative humidity</b>	
	10% ... 90%, non-condensing
<b>Ambient air</b>	
	Free of corrosive gases
<b>Burn-in test</b>	
	24 h burn-in [system without HDD]
	48 h burn-in [system with HDD]

Tab. 15 Technical data

## 8 Technical data

### 8.5 Directives and standards

#### 8.5

#### Directives and standards

<b>Degree of protection / tightness</b>	IP65 in the front as per EN 60529-1
	IP20 in the front as per EN 60529-1
	NEMA12 as per NEMA 250-2003
<hr/>	
<b>EMC</b>	As per 2004/108/EC EMC Directive
Emitted interference	As per EN 55022:2010 Class A and EN 61000-6-4:2007 Devices meeting this standard may not be used in residential areas.
Interference immunity	As per EN 55024:2010 and EN 61000-6-2:2005 EN 61131-2:2007
<hr/>	
<b>product safety</b>	UL 508 CSA C22.2 No. 142-M1987
<hr/>	
<b>RoHS</b>	As per 2011/65/EC RoHS Directive All assembly parts and components used are RoHS-compliant.
<hr/>	
<b>Vibration resistance (during operation)</b>	EN 60068-2-6
<hr/>	
<b>Mechanical shock resistance (during operation)</b>	EN 60068-2-27
<hr/>	
<b>Free fall</b>	EN 60068-2-32
<hr/>	
<b>Explosion protection (in relation to CE), only type XP-503-...-A10-A01-1B</b>	ATEX Directive 94/9 EG 2014/34/EG
Explosive atmospheres: equipment - general requirements	IEC/EN 60079-0:2012 + A11:2013
Explosive atmospheres: equipment dust ignition protection by enclosure «t»	IEC/EN 60079-31:2014

Tab. 16 Directives and standards



8.6

Approvals

UL	cULus (UL 508)
EMC	CE
Product safety	CE
Explosion protection (in relation to CE), II 3D Ex tc IIIC T70°C U only type XP-503-...-A10-A01-1B (184582)	<p>(U = Identification for Ex-parts, regarding EN 60079-0:2012+A1:2013, 29.9g) Zone22, Category 3D</p> <p>Special conditions for safe use („U“) The XP-503-...-A10-A01-1B are designed for installation in the front of enclosures in protection type "tc" (alternatively "ta" or "tb"). This installation must be tested and certified separately. The maximum surface temperature at the outer surface is set to 70°C at the maximum ambient temperature of 50°C. For safe installation, comply with the specification to holding brackets and tightening torque in the Instruction Leaflet IL048006ZU.</p>
DNV GL Marine approval (shipping classification)	<p>Type approval – provided that a radio interference suppression filter for the device is installed in the wiring Type-Approval DNVGL-CG-0339, Edition November 2015, Certificate No.: TAA00000NC</p>

Tab. 17 Approvals

Eaton is dedicated to ensuring that reliable, efficient and safe power is available when it's needed most. With unparalleled knowledge of electrical power management across industries, experts at Eaton deliver customized, integrated solutions to solve our customers' most critical challenges.

Our focus is on delivering the right solution for the application. But decision makers demand more than just innovative products. They turn to Eaton for an unwavering commitment to personal support that makes customer success a top priority. For more information, visit [www.eaton.eu](http://www.eaton.eu).

**Eaton Adressen weltweit:**  
**[www.eaton.com/Worldwide Sites](http://www.eaton.com/Worldwide Sites)**

**E-Mail: [info-bonn@eaton.com](mailto:info-bonn@eaton.com)**  
**Internet: [www.eaton.eu/xp500](http://www.eaton.eu/xp500)**

**Eaton Industries GmbH**  
Hein-Moeller-Str. 7-11  
D-53115 Bonn

© 2014 by Eaton Corporation  
All rights reserved  
MN048014 EN Doku 01/17



Powering Business Worldwide