



Installation and Operating instructions for

CP69xx

Built-in Control Panel with DVI/ USB Extended interface

Version: 2.5
Date: 2019-05-31

BECKHOFF

Table of contents

1	Foreword	3
1.1	Notes on the Documentation	3
1.1.1	Liability Conditions	3
1.1.2	Trademarks	3
1.1.3	Patent Pending	3
1.1.4	Copyright	3
1.1.5	State at Delivery	3
1.1.6	Delivery conditions	3
1.2	Description of safety symbols	4
1.3	Basic safety measures	5
1.4	Operator's obligation to exercise diligence	6
1.4.1	National regulations	6
1.4.2	Procedure in the event of a fault	6
1.4.3	Operator requirements	6
2	Product Description	7
2.1	Product overview	7
2.2	Appropriate Use	8
2.3	Interfaces CP69xx	8
2.3.1	DVI-E Input (Digital Visual Interface-Extended) (X101)	8
2.3.2	USB-Extended Input (X 102)	9
2.3.3	USB in (X 103)	9
2.3.4	USB out (X 104, X 105)	9
2.3.5	Power Supply (X106)	9
2.3.6	Ground connection	10
2.4	Status-LEDs	10
2.5	Connection Kits	11
2.5.1	Connection Kits DVI-E/ USB-E connection for CP69xx, optional	11
3	Installation	12
3.1	Transport and Unpacking	12
3.1.1	Transport	12
3.1.2	Unpacking	12
4	Mounting	13
4.1	Installation in the control cabinet	13
4.1.1	Preparation of the control cabinet	13
4.1.2	Installation in a control cabinet wall	13
4.1.3	Earthing measures	13

4.1.4	Mounting of the Control Panel	14
4.1.5	Fitting the power supply cable	15
4.2	Connecting the Control Panel	16
4.2.1	Connecting cables	16
4.2.2	Earthing measures	16
5	Operating Instructions	17
5.1	Switching the Control Panel on and off	17
5.1.1	Switching on	17
5.1.2	Shutting down and switching off	17
5.2	Operation	17
5.3	Keyboard codes	18
5.4	Setting the transmission rate	19
5.5	Servicing and maintenance	20
5.5.1	Cleaning	20
5.5.2	Maintenance	20
5.6	Emergency procedures	20
5.7	Shutting down	20
5.7.1	Disposal	20
6	Troubleshooting	21
7	Assembly dimensions	22
8	Technical Data	24
9	Appendix	25
9.1	Beckhoff Support and Service	25
9.1.1	Beckhoff branches and partner companies	25
9.1.2	Beckhoff company headquarters	25
9.2	Approvals for USA and Canada	26
9.3	FCC Approvals for the United States of America	26
9.4	FCC Approval for Canada	26

1 Foreword

1.1 Notes on the Documentation

This description is only intended for the use of trained specialists in control and automation engineering who are familiar with the applicable national standards. It is essential that the following notes and explanations are followed when installing and commissioning these components.

The responsible staff must ensure that the application or use of the products described satisfy all the requirements for safety, including all the relevant laws, regulations, guidelines and standards.

1.1.1 Liability Conditions

The documentation has been prepared with care. The products described are, however, constantly under development. For that reason the documentation is not in every case checked for consistency with performance data, standards or other characteristics. In the event that it contains technical or editorial errors, we retain the right to make alterations at any time and without warning. No claims for the modification of products that have already been supplied may be made on the basis of the data, diagrams and descriptions in this documentation.

All pictures shown in the documentation are exemplary. Illustrated configurations can differ from standard.

1.1.2 Trademarks

Beckhoff[®], TwinCAT[®], EtherCAT[®], Safety over EtherCAT[®], TwinSAFE[®], XFC[®] and XTS[®] are registered trademarks of and licensed by Beckhoff Automation GmbH.

Other designations used in this publication may be trademarks whose use by third parties for their own purposes could violate the rights of the owners.

1.1.3 Patent Pending

The EtherCAT Technology is covered, including but not limited to the following patent applications and patents: EP1590927, EP1789857, DE102004044764, DE102007017835 with corresponding applications or registrations in various other countries.

The TwinCAT Technology is covered, including but not limited to the following patent applications and patents: EP0851348, US6167425 with corresponding applications or registrations in various other countries.

1.1.4 Copyright

© Beckhoff Automation GmbH & Co. KG.

The reproduction, distribution and utilization of this document as well as the communication of its contents to others without express authorization are prohibited. Offenders will be held liable for the payment of damages. All rights reserved in the event of the grant of a patent, utility model or design.

1.1.5 State at Delivery





All the components are supplied in particular hardware and software configurations appropriate for the application. Modifications to hardware or software configurations other than those described in the documentation are not permitted, and nullify the liability of Beckhoff Automation GmbH & Co. KG.

1.1.6 Delivery conditions

In addition, the general delivery conditions of the company Beckhoff Automation GmbH & Co. KG apply.

1.2 Description of safety symbols

The following safety symbols are used in this operating manual. They are intended to alert the reader to the associated safety instructions.

 DANGER	<p>Acute risk of injury!</p> <p>If you do not adhere the safety advise adjoining this symbol, there is immediate danger to life and health of individuals!</p>
 WARNING	<p>Risk of injury!</p> <p>If you do not adhere the safety advise adjoining this symbol, there is danger to life and health of individuals!</p>
 CAUTION	<p>Hazard to individuals!</p> <p>If you do not adhere the safety advise adjoining this symbol, there is obvious hazard to individuals!</p>
 Attention	<p>Hazard to devices and environment</p> <p>If you do not adhere the notice adjoining this symbol, there is obvious hazard to materials and environment.</p>
 Note	<p>Note or pointer</p> <p>This symbol indicates information that contributes to better understanding.</p>

1.3 Basic safety measures

Before the Industrial PC is switched off, software that is running must be properly closed. Otherwise it is possible that data on the storage medium is lost. Please read the section [Switching the Control Panel on and off](#).

 Warning	Switch off all parts of the equipment, then uncouple the Control Panel Before opening the housing, and whenever the Control Panel is not being used for control purposes (such as during functional checks after a repair), all parts of the equipment must first be switched off, after which the Control Panel is to be disconnected from the equipment.
---	--

Disconnect the device by unplugging the connectors on the rear side of the Control Panel. Items of equipment that have been switched off must be secured against being switched on again.

 Warning	Do not exchange any parts when under power When components are being fitted or removed, the supply voltage must be switched off. Fitting work on the Control Panel can result in damage: <ul style="list-style-type: none">• if metal objects such as screws or tools fall onto operating circuit boards• if connecting cables internal to the Panel PC are removed or inserted during operation.
---	---

 DANGER	High Voltage! Displays used for the Control Panel's LC-display are operated with a voltage of up to 1000 V, depending on type. For that reason: The supply voltage must be disconnected before the housing of the Control Panel is opened.
--	--

1.4 Operator's obligation to exercise diligence

The operator must ensure that

- the product is only used as intended (see chapter [Product Description](#))
- the product is in a sound condition and in working order during operation
- the product is operated, maintained and repaired only by suitably qualified and authorized personnel
- the personnel is instructed regularly about relevant occupational safety and environmental protection aspects, and is familiar with the operating manual and in particular the safety notes contained herein
- the operation manual is in good condition and complete, and always available for reference at the location of the product.



Note

Do not open the housing of the Control Panel!

For technical support contact [Beckhoff Service](#).

1.4.1 National regulations

Depending on the type of machine and plant in which the Control Panel is used, national regulations governing the controllers of such machines will apply, and must be observed by the operator. These regulations cover, amongst other things, the intervals between inspections of the controller. The operator must initiate such inspections in good time.

1.4.2 Procedure in the event of a fault

In the event of faults at the Control Panel, the list in the section [Troubleshooting](#) can be used to determine the measures to be taken.

1.4.3 Operator requirements

Anyone who uses the Control Panel must have read these operating instructions and must be familiar with all the functions of the software installed on the Industrial PC to which he has access.

2 Product Description

2.1 Product overview

Front view of CP69xx



The “Economy” built-in Control Panel offer the following benefits:

- TFT display in different sizes
- aluminium front with sheet-steel rear cover, front side IP65, rear side IP20
- front laminate in five variants
 - only display
 - function keys and 10 PLC special keys with LED
 - numeric keyboard and 10 PLC special keys with LED
 - alphanumeric PC keyboard in US layout and 10 PLC special keys with LED
 - alphanumeric PC keyboard in US layout and 16 PLC special keys with LED on the sides
- integrated DVI/USB extension technology:
 - DVI-E and USB-E enable remote panel operation at a distance of up to 50 m from the PC
 - DVI-E input is compatible to the standard DVI output of a PC
- USB input for the direct connection to a standard USB output of a PC with distances of up to 5 m
- all connectors at the lower rear side
- 24 V power supply
- operating temperature 0...55 °C
- pull-out clamping levers for fast installation without loose parts.

2.2 Appropriate Use

The CP69xx Control Panel is designed for industrial application in machine and plant engineering. A steel plate housing with aluminum front contains a TFT display, touch screen/ pad (optional) and a PC keyboard (optional). The Control Panel is installed in the front of control cabinets.

 Danger	<p>Risk of explosion!</p> <p>The Control Panel must not be used where there is a risk of explosion.</p>
--	--

2.3 Interfaces CP69xx

Interfaces to the CP6907 with 5.7" display

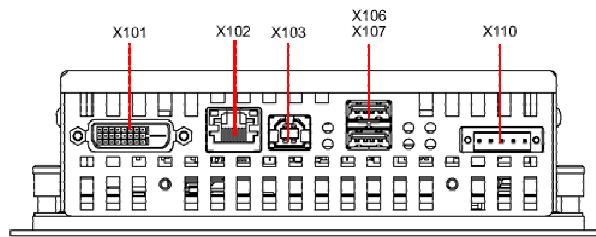

Interfaces CP69xx with 6.5", 12", 15", 19" and 24" display

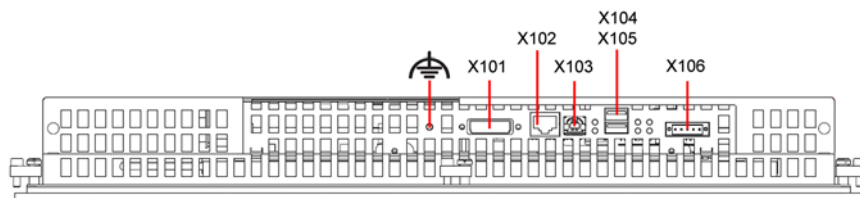

2.3.1 DVI-E Input (Digital Visual Interface-Extended) (X101)



X101

DVI-D 3 X 8-pole digital PCB installation (MOLEX 74320-9000 / 74320-9004)

The DVI-E connection (**X 101**) is used for transferring the video signal from the Industrial PC to the Control Panel. The purely digital part (DVI-D) is supported.

The graphics signal is transferred directly via a DVI cable over a distance of 50 m max. Such a cable length leads to strong distortion of the graphics signal on arrival at the Control Panel. The CP69xx Control Panel features a signal processor that restores the DVI signal. The PC requires a conventional DVI output.

Pin	Signal	Pin	Signal
1	Rx2-	13	Rx3+
2	Rx2-	14	+ 5V DVI
3	GND	15	GND
4	Rx4-	16	HPD
5	Rx4+	17	Rx0-
6	DDC CLK	18	Rx0+
7	DDC DAT	19	GND
8	AV SYNC	20	Rx5-
9	Rx1-	21	Rx5+
10	Rx1+	22	GND
11	GND	23	RxC+
12	Rx3-	24	RxC-

 Note	<p>The transmission rate of the DDC file has to be limited</p> <p>At large distance between PC and Control Panel, the transmission rate of the DDC file has to be limited.</p> <p>See also chapter Setting the transmission rate.</p>
--	--

2.3.2 USB-Extended Input (X 102)



X102

Connection via standard-RJ45-cabel, not crossed

The Control Panel is connected with the CU8800 USB to USB extended converter box via the USB-Extended input (**X 102**).

In order to realize a distance of 50 m without hubs, with USB extended the USB signal is converted so that it can be transferred via 50 m CAT5 cables commonly used for Ethernet wiring. In the Control Panel the signal is converted back to USB.

2.3.3 USB in (X 103)



X103

USB type B, PCB installation (FCI 61729-0010B USB Receptacle B-Type)

The Control Panel is connected with the Industrial PC via the USB port (**X 103**, connector type B). USB2.0 standard is supported.

Pin	Signal	Pin	Signal
1	5V	3	D+
2	D-	4	GND

2.3.4 USB out (X 104, X 105)



X104, X105

USB Type-A twin circuit board mounting (FCI 72309-0030B USB Double Receptacle A-Type)

The two USB interfaces (**X104, X105**, connector type A) are used for connecting peripheral devices with USB connection. USB2.0 standard is supported in a distance of up to 5 m from the PC, from a distance of 5 m up to 50 m USB1.1 standard is supported.

Pin	Signal	Pin	Signal
1	5V	3	D+
2	D-	4	GND

2.3.5 Power Supply (X106)



X106

Socket 5-pol RM3.50 Sw Screw Clamp BL3.5/180F (WEIDMÜLLER 1615810000)

The power supply for the Control Panel is established via the socket (**X106**). The power supply connector is included in delivery.

Pin	Signal	Pin	Signal	
1	NC	4	GND	Power Supply
2	NC	5	+ 24 V _{DC}	
3	⊕			

2.3.6 Ground connection



The Control Panel is grounded via the stud bolt.

2.4 Status-LEDs

The Status-LEDs are located near the connectors:

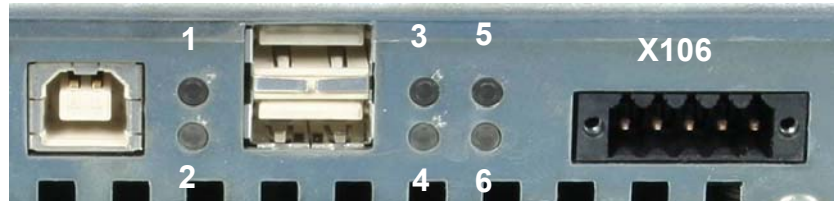

Description of the Status-LEDs:

1	Hub Goodlink:	USB-connection to the Industrial-PC established
2	Hub Suspend:	Not equipped with LED
3	USB 1:	USB 1-Interface in use
4	USB 2:	USB 2-Interface in use
5	Power Good:	Supply voltage o.k.
6	24 V in:	Power Supply is established

2.5 Connection Kits

One 5-pole power supply connector is provided with the Control Panel.

Optionally prefabricated connection kits for the DVI-E/ USB-E connection are available.

2.5.1 Connection Kits DVI-E/ USB-E connection for CP69xx, optional

The following connection kits are available:

Connecting kit	DVI-E/ USB-E Connection
C9900-K513	Connecting kit 3 m for CP69xx, containing: 3 m DVI cable, 3 m USB cable
C9900-K515	Connecting kit 5 m for CP69xx, containing: 5 m DVI cable, 5 m USB cable
C9900-K421	Connecting kit 10 m for CP69xx, containing: 10 m DVI cable, 10 m CAT 5 cable for USB-E, USB to USB-E converter CU8800 for mounting rail installation close to the PC and 1 m USB cable to connect the USB to USB-E converter to the PC
C9900-K423	Connecting kit 20 m for CP69xx, containing: 20 m DVI cable, 20 m CAT 5 cable for USB-E, USB to USB-E converter CU8800 for mounting rail installation close to the PC and 1 m USB cable to connect the USB to USB-E converter to the PC
C9900-K425	Connecting kit 30 m for CP69xx, containing: 30 m DVI cable, 30 m CAT 5 cable for USB-E, USB to USB-E converter CU8800 for mounting rail installation close to the PC and 1 m USB cable to connect the USB to USB-E converter to the PC
C9900-K427	Connecting kit 40 m for CP69xx, containing: 40 m DVI cable, 40 m CAT 5 cable for USB-E, USB to USB-E converter CU8800 for mounting rail installation close to the PC and 1 m USB cable to connect the USB to USB-E converter to the PC
C9900-K429	Connecting kit 50 m for CP69xx, containing: 50 m DVI cable, 50 m CAT 5 cable for USB-E, USB to USB-E converter CU8800 for mounting rail installation close to the PC and 1 m USB cable to connect the USB to USB-E converter to the PC

3 Installation

3.1 Transport and Unpacking

The specified storage conditions must be observed (see chapter [Technical Data](#)).

3.1.1 Transport

Despite the robust design of the unit, the components are sensitive to strong vibrations and impacts. During transport, your Control Panel should therefore be protected from excessive mechanical stress. Therefore, please use the original packaging.

 Attention	Danger of damage to the unit If the device is transported in cold weather or is exposed to extreme variations in temperature, make sure that moisture (condensation) does not form on or inside the device.
---	---

Prior to operation, the unit must be allowed to slowly adjust to room temperature. Should condensation occur, a delay time of approximately 12 hours must be allowed before the unit is switched on.

3.1.2 Unpacking

Proceed as follows to unpack the unit:

1. Remove packaging.
2. Do not discard the original packaging. Keep it for future relocation.
3. Check the delivery for completeness by comparing it with your order.
4. Please keep the associated paperwork. It contains important information for handling the unit.
5. Check the contents for visible shipping damage.

If you notice any shipping damage or inconsistencies between the contents and your order, you should notify Beckhoff Service.

4 Mounting

The Control Panel CP69xx is designed for mounting in control cabinets in machine and plant engineering applications. The ambient conditions specified for operation must be observed (see chapter [Technical Data](#)).

4.1 Installation in the control cabinet

4.1.1 Preparation of the control cabinet

The control cabinet wall must be prepared with the required mounting opening according to the Control Panel's dimensions (see chapter [Assembly dimensions](#)).

 Note	<p>Circulation of air</p> <p>When the unit is installed in an enclosure, adequate space for ventilation must be provided.</p> <p>The clearance above and below the housing must be at least 5 cm in order to ensure adequate ventilation of the Control Panel.</p>
--	---

Please note the following points during installation of the Control Panel:

- Position the Control Panel in such a way that reflections on the screen are avoided as far as possible.
- Use the position of the screen as a guide for the correct installation height; it should be optimally visible for the user at all times.
- The Control Panel should not be exposed to direct sunlight.
- When the unit is in its mounting position, the ventilation openings must not be obstructed.

 Attention	<p>Avoid extreme environmental conditions</p> <p>Extreme environmental conditions should be avoided as far as possible. Protect the Control Panel from dust, moisture and heat.</p> <p>The ventilation slots of the Control Panel must not be covered.</p>
---	---

4.1.2 Installation in a control cabinet wall

For installation of the Control Panel proceed as follows:

1. Insert the Control Panel at the intended control cabinet wall position and protect it from falling out, prior to final mounting.
2. Release the clamping levers, turn the clamping levers to the side and retighten the screws (see chapter [Mounting of the Control Panel](#)).

4.1.3 Earthing measures

Earthing connections dissipate interference from external power supply cables, signal cables or cables to peripheral equipment. Establish a low-impedance connection from the earthing point on the Control Panel housing (see chapter [Earthing measures](#)) to the central earthing point on the control cabinet wall, in which the Panel is being installed.

4.1.4 Mounting of the Control Panel

The Control Panel is installed in the cabinet wall with clamping levers.

For the cutout dimension of the Control Panel see chapter [Assembly dimensions](#), the wall thickness is between 1 mm and 5 mm.

Clamping
levers



1. Insert the Control Panel into the cutout.
2. Release the clamping levers with a 2.5 mm Allen key.

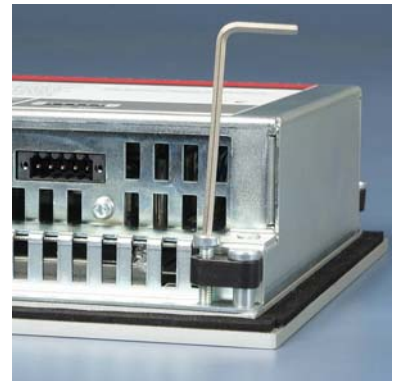

3. Turn the clamping levers to the side through 90°.

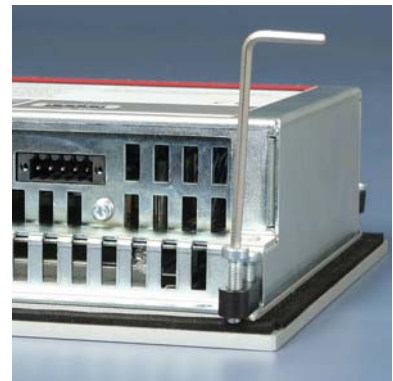

4. Retighten the screws.

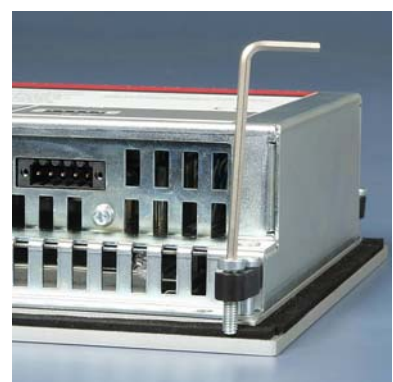

4.1.5 Fitting the power supply cable

Fit the cables for the power supply of the Control Panel, using the included material for assembling the connectors:

Material for assembling the connector

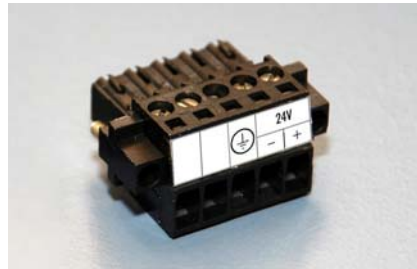

Plug connector 5-pole

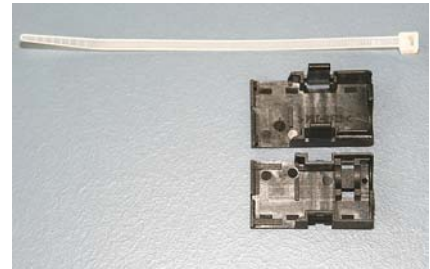

Stain relief housing with lacing cord

 Note	<p>Conductive cross-section</p> <p>The connector is specified for 16 A and can lift conductive cross-sections until 1.5 mm².</p>
--	--

So the connector is fitted to the cable

1. Strip insulation from the cable ends (Length of stripped conductor is 8 - 9 mm).
2. Screw together the cable ends in the 5-pole plug connector in accordance with wiring diagram.

Applying the strain relief

Thread the lacing cord into that lower part of the stain relief housing.



Putting in the plug connector

Put the plug connector into that lower part of the stain relief housing.

Tighten the lacing cord and pinch off the plastic strap.



Fixing the upper part of the stain relief housing

Fix the upper part of the stain relief housing by snapping it onto the lower part.



4.2 Connecting the Control Panel

 Attention	<p>The mains plug must be disconnected</p> <p>Please read the documentation for the external devices prior to connecting them!</p> <p>During thunderstorms, plug connector must neither be inserted nor removed!</p> <p>When disconnecting a plug connector, always handle it at the plug. Do not pull the cable!</p>
---	--

4.2.1 Connecting cables

The connections are located at the rear of the Control Panel and are documented in the chapter [Interfaces](#).

When connecting cables to the Control Panel, please adhere to the following order:

- Disconnect the Control Panel from the power supply.
- Connect all cables at the Control Panel and at the devices to be connected.
- Ensure that all screw connections between connectors and sockets are tight!
- Reconnect all devices to the power supply.

4.2.2 Earthing measures



Earthing connections dissipate interference from external power supply cables, signal cables or cables.

Connect the earth point on the Control Panel housing to the central earthing point with a low resistance connection. The earthing connection is located at the rear of the housing.

5 Operating Instructions

5.1 Switching the Control Panel on and off

5.1.1 Switching on

The Control Panel does not have its own mains power switch. As soon as the power supply is switched on the Control Panel is activated.

5.1.2 Shutting down and switching off

Control software such as is typically used on Industrial PCs permits various users to be given different rights. A user who may not close software may also not switch the Industrial PC off, since data can be lost from the storage medium by switching off while software is running.

 Warning	<p>First shut down, then switch off!</p> <p>If the Industrial PC is switched off as the software is writing a file to the storage medium, the file will be destroyed. Control software typically writes something to the storage medium every few seconds, so that the probability of causing damage by switching off while the software is running is very high.</p>
---	--

 Warning	<p>Switch off power supply</p> <p>When you have shut down the Industrial PC, you have to switch off power supply for at least 10 seconds before rebooting the system. After resetting power supply the Industrial PC will start booting automatically.</p>
---	---

5.2 Operation

 Note	<p>The Control Panel's membrane keypad may only be actuated by fingertips</p> <p>Attempts to actuate it with other objects can easily result in the destruction of the device. Neither may the membrane keypad be operated with a touch screen pen.</p>
--	--

 Warning	<p>Risk of damaging the Touch Screen</p> <p>The touch screen may only be actuated by finger tips or with the touch screen pen. The operator may wear gloves but there must be no hard particles such as metal shavings, glass splinters embedded in the glove.</p>
---	---

5.3 Keyboard codes

Type-dependent number of keys Depending on the precise type, the Control Panel can have fewer keys than those described here.

Operation



The cursor is the blinking character that marks the point at which the next character entered will be displayed. The cursor is also known as the insertion point. The cursor keys each move the cursor one place in the associated direction.



The Home key moves the cursor to the beginning of the line, while the End key moves it to the end of the line.



The *Pg Up* key scrolls one page back, the *Pg Dn* key scrolls one page forward.



The Tab key takes the cursor to the next input field, while Shift and Tab moves to the previous input field.



The mouse cursor can be moved over the screen with the aid of the touch screen or of the touch pad (optional). The keys correspond to the left and right hand keys of a Microsoft mouse.



The *Del* key deletes the character to the right of the cursor.



The *Ins* key causes characters to the right of the cursor to be overwritten. The overwrite mode is cancelled by pressing the key again.



Print-Screen prints a hard copy of a text screen on the printer.



The Pause key stops the computer until another key is pressed (only under MS-DOS).



Your input is confirmed with the Enter key.



Backspace deletes the character to the left of the cursor.



If the Shift key is pressed at the same time as another key, then instead of the numbers you obtain the character printed above the number, and you obtain upper case letters instead of lower case letters.



Pressing the *Caps Lock* key once activates and locks the *Shift* key. Pressing the *Shift* key cancels this function.



Rather like the effect of the *Shift* key, *Ctrl* and *Alt* also change the meaning of another key that is pressed at the same time.



This key brings up the Start menu of the operating system in use (Windows 95, 98, ME, NT, 2000, XP).



Pressing this key opens the property sheet of the active (or marked) object.



The *Esc* key has the effect of closing dialog windows and of interrupting some of the computer's working operations.



All other keys bring the character printed on them onto the display at the position of the cursor.



The meaning of the function keys, *F1* to *F10*, is determined by the software and is displayed at the bottom edge of the display.



The function of the special keys above the display is also determined by the software. The function is displayed at the top edge of the display.

The special keys each have an orange LED controlled by the software.

5.4 Setting the transmission rate

At large distance between PC and Control Panel, the transmission rate of the DDC file has to be limited. The DDC file is transmitted from the Control Panel to the PC in order to transfer the display information like timing and resolution.

The video bios of the graphic card or, using the on-board graphic, the video bios of the motherboard contains the definition of the transmission rate for the DDC file. This value has to be 50 kHz or less. Otherwise the screen is not displayed or not until windows is started.

Windows graphic drivers also include a value for the transmission rate of the DDC file. If Windows is running and no image is displayed, then use a graphic driver with a value of 50 kHz or less for DDC file transmission.

5.5 Servicing and maintenance

5.5.1 Cleaning

 DANGER	Disconnect power supply Switch off the device and all connected devices, and disconnect the device from the power supply.
--	---

The device can be cleaned with a soft, damp cleaning cloth. Do not use any aggressive cleaning materials, thinners, scouring material or hard objects that could cause scratches.

5.5.2 Maintenance

The Control Panel is maintenance-free.

5.6 Emergency procedures

In case of fire, the Control Panel should be extinguished with powder or nitrogen.

5.7 Shutting down

5.7.1 Disposal

 Note	Observe national electronics scrap regulations Observe the national electronics scrap regulations when disposing of the device.
--	---

In order to dispose of the device, it must be removed and fully dismantled:

- Housing components (polycarbonate, polyamide (PA6.6)) are suitable for plastic recycling.
- Metal parts can be sent for metal recycling.
- Electronic parts such as disk drives and circuit boards must be disposed of in accordance with national electronics scrap regulations.

6 Troubleshooting

 Note	<p>Pixel errors</p> <p>Pixel errors in the TFT display are production-caused and represent no complaint-reason!</p>
--	--

Fault	Cause	Measures
The Control Panel shows no function	No power supply to the Control Panel/ Industrial PC Cable not connected	Check power supply cable 1. Correctly connect cable 2. Call Beckhoff Service
Computer boots, software starts, but control does not operate correctly	Cause of the fault is either in the software or in parts of the plant outside the Industrial PC	Call the manufacturer of the machine or the software
Malfunction of the touchscreen	Bad or missing ground connection of the device	Establish ground connection
	Bad or missing ground connection of the user	User must stand on the floor with ordinary shoes
No screen	Transmission rate is too high when using DVI cables longer than 20 m	Limit transmission rate for DDC file to 50 kHz
USB error while TwinCAT access via USB	Cycle time in TwinCAT is set on 10 ms (standard)	Increase the cycle time up to 50 ms till 80 ms
The Control Panel functions only partially or only part of the time, e.g. no or dark picture	Faulty backlight in the display Defective components in the Control Panel	Call Beckhoff Service Call Beckhoff Service

7 Assembly dimensions

For the assembly dimensions of the Control Panels please visit our homepage. Here you will find the actual drawings using the link:

http://download.beckhoff.com/download/Technical_Drawings/Industrial_PC/Control_Panel/CP69xx

 Warning	<p>Notice mounting orientation</p> <p>The assembly of the unit must take place with the orientation diagrammed here.</p>
---	---

Control Panel
CP6907
with 5.7" display

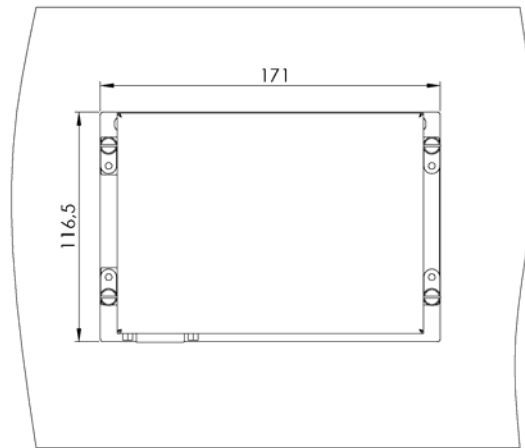

rear view with
cutout
dimensions

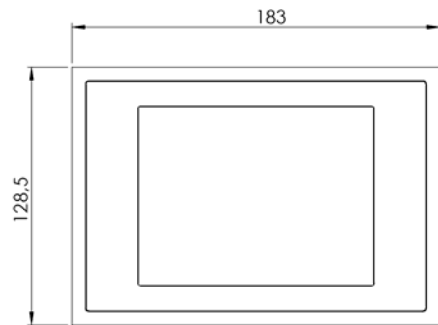

front view

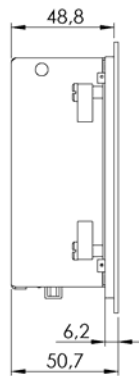

side view

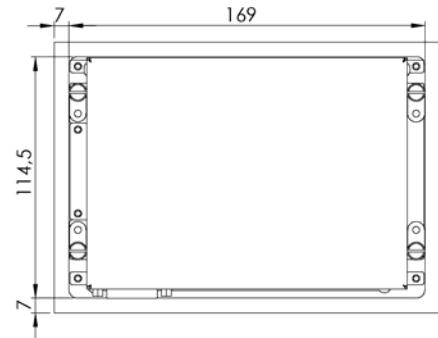

rear view

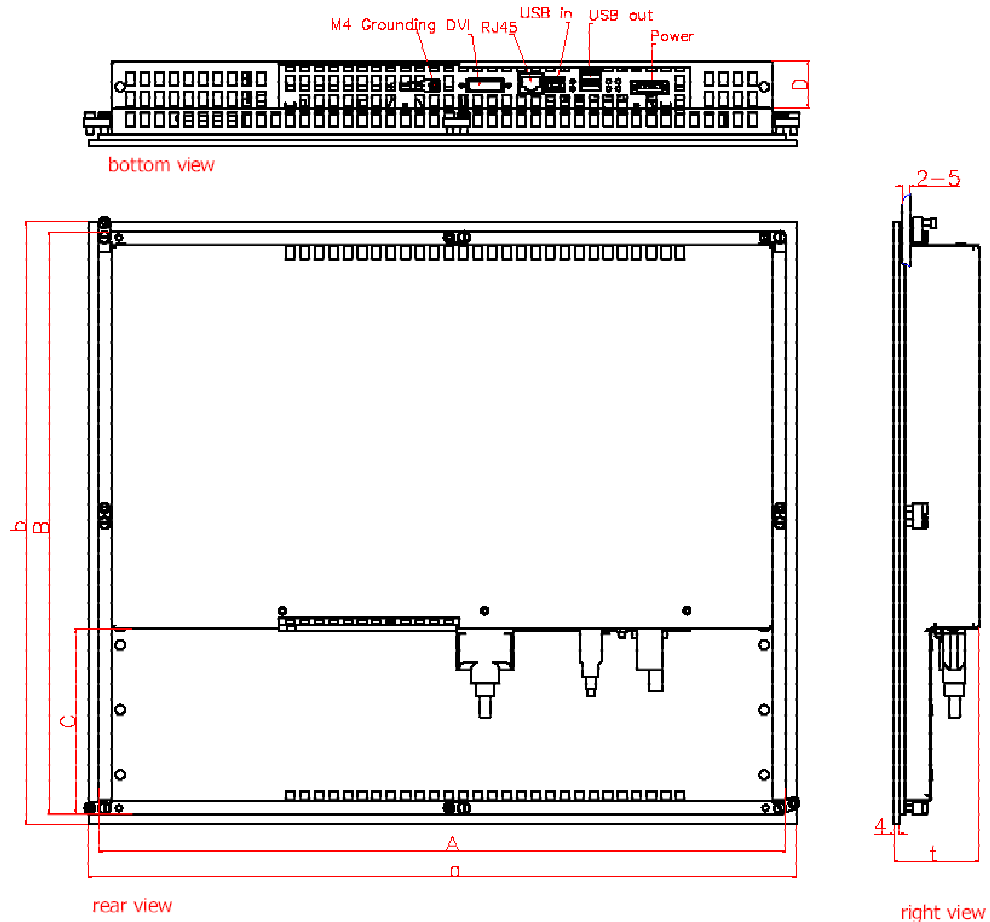

 Warning	<p>Notice mounting orientation</p> <p>The assembly of the unit must take place with the orientation diagrammed here.</p>
---	---

Control Panel
CP69xx



Dimensions CP690x		a	b	t	A	B	C	D
CP6909	6.5"-Display	240	175	55	226	161	26.6	30.5
CP6901	12"-Display	330	275	58	316	261	24.6	32.5
CP6902	15"-Display	380	315	59	366	301	41.2	33
CP6903	19"-Display	455	390	67	441	376	77.2	33
CP6904	24"-Display	583	411	75	581	409	54.5	33
Dimensions CP691x		a	b	t	A	B	C	D
CP6919	6.5"-Display	272.3	221	55	258.3	207	70	30.5
CP6911	12"-Display	372.2	342.2	58	358.2	328.2	67	32.5
CP6912	15"-Display	430.4	403	59	416.4	389	86.5	33
CP6913	19"-Display	508.4	463	67	494.4	449	116.2	33
Dimensions CP692x		a	b	t	A	B	C	D
CP6929	6.5"-Display	340.4	221	55	326.4	207	70	30.5
CP6921	12"-Display	414	336	58	400	322	51.5	32.5
CP6921-0002	12"-Display	444.2	336	58	430.2	322	51.5	32.5
CP6922	15"-Display	519.4	378.2	59	505.4	364.2	70.9	33
CP6923	19"-Display	567.4	434	67	553.4	420	93.5	33
Dimensions CP693x		a	b	t	A	B	C	D
CP6931	12"-Display	410.4	378.2	58	396.4	364.2	115.7	32.5
CP6931-0002	12"-Display	430.4	378.2	58	416.4	364.2	115.7	32.5
CP6932	15"-Display	489.4	418.2	59	475.4	404.2	128.3	33
CP6933	19"-Display	508.4	543	67	494.4	529	195.8	33

8 Technical Data

 Danger	<p>Risk of explosion!</p> <p>Do not use the Control Panel in areas of explosive hazard!</p>
 Note	<p>Pixel errors</p> <p>Pixel errors in the TFT display are production-caused and represent no complaint-reason!</p>

Product name	CP69xx												
Dimensions (B x H x T)	See chapter Assembly dimensions												
Supply voltage	24 V _{DC} (20.4 – 28.8 V _{DC})												
Power consumption	<table style="width: 100%; border: none;"> <tr> <td style="width: 33%;">approx. 8 W with 5.7" display</td> <td style="width: 33%;">approx. 15 W with 6.5" display</td> <td style="width: 33%;"></td> </tr> <tr> <td>approx. 17 W with 10" display</td> <td>approx. 19 W with 12" display</td> <td></td> </tr> <tr> <td>approx. 30 W with 15" display</td> <td>approx. 37 W with 19" display</td> <td></td> </tr> <tr> <td>approx. 59 W with 24" display</td> <td></td> <td></td> </tr> </table>	approx. 8 W with 5.7" display	approx. 15 W with 6.5" display		approx. 17 W with 10" display	approx. 19 W with 12" display		approx. 30 W with 15" display	approx. 37 W with 19" display		approx. 59 W with 24" display		
approx. 8 W with 5.7" display	approx. 15 W with 6.5" display												
approx. 17 W with 10" display	approx. 19 W with 12" display												
approx. 30 W with 15" display	approx. 37 W with 19" display												
approx. 59 W with 24" display													
Integrated DVI/USB extension technology	<ul style="list-style-type: none"> • DVI-E and USB-E 2.0 enable remote panel operation at a distance of up to 50 m from the PC • USB-E 2.0 transmits USB 2.0 with 480 Mbit/s • DVI-E input is compatible to the standard DVI output of a PC 												
Interfaces CP69xx	2-Port-USB 2.0/ USB 1.1, see chapter Interfaces CP69xx												
Protection class	Front side IP65, rear side IP20												
Shock resistance (Sinusoidal vibration)	<table style="width: 100%; border: none;"> <tr> <td style="width: 33%;">EN 60068-2-6:</td> <td style="width: 33%;">10 to 58 Hz:</td> <td style="width: 33%;">0.035 mm</td> </tr> <tr> <td></td> <td>58 to 500 Hz:</td> <td>0.5 G (~ 5 m/ s²)</td> </tr> </table>	EN 60068-2-6:	10 to 58 Hz:	0.035 mm		58 to 500 Hz:	0.5 G (~ 5 m/ s ²)						
EN 60068-2-6:	10 to 58 Hz:	0.035 mm											
	58 to 500 Hz:	0.5 G (~ 5 m/ s ²)											
Shock resistance (Shock)	EN 60068-2-27: 5 G (~ 50 m/ s ²), duration: 30 ms												
EMC compatibility	Resistance to interference conforms to EN 61000-6-2												
EMC compatibility	Emission of interference conforms to EN 61000-6-4												
Permissible ambient temperature	Operation: 0°C to +55°C Transport/ storage: -20°C to +65°C												
Permissible relative humidity	to 95%, no condensation												
Transport and storage	The same values for atmospheric humidity and shock resistance are to be observed during transport and storage as in operation. Suitable packaging of the Panel PC can improve the resistance to impact during transport.												
Certifications	CE												

9 Appendix

9.1 Beckhoff Support and Service

Beckhoff and their partners around the world offer comprehensive support and service, making available fast and competent assistance with all questions related to Beckhoff products and system solutions.

9.1.1 Beckhoff branches and partner companies

Please contact your Beckhoff branch office or partner company for [local support and service](#) on Beckhoff products!

The contact addresses for your country can be found in the list of Beckhoff branches and partner companies: www.beckhoff.com. You will also find further [documentation](#) for Beckhoff components there.

9.1.2 Beckhoff company headquarters

Beckhoff Automation GmbH & Co. KG
Huelshorstweg 20
33415 Verl
Germany

Phone: + 49 (0) 5246/963-0
Fax: + 49 (0) 5246/963-198
E-mail: info@beckhoff.de
Web: <http://www.beckhoff.de/>

Beckhoff Support

Support offers you comprehensive technical assistance, helping you not only with the application of individual Beckhoff products, but also with other, wide-ranging services:

- world-wide support
- design, programming and commissioning of complex automation systems
- and extensive training program for Beckhoff system components

Hotline: + 49 (0) 5246/963-157
Fax: + 49 (0) 5246/963-9157
E-mail: support@beckhoff.com

Beckhoff Service

The Beckhoff Service Center supports you in all matters of after-sales service:

- on-site service
- repair service
- spare parts service
- hotline service

Hotline: + 49 (0) 5246/963-460
Fax: + 49 (0) 5246/963-479
E-mail: service@beckhoff.com

If servicing is required, please quote the **project number** of your product.

9.2 Approvals for USA and Canada

9.3 FCC Approvals for the United States of America

FCC: Federal Communications Commission Radio Frequency Interference Statement

This equipment has been tested and found to comply with the limits for a Class A digital device, pursuant to Part 15 of the FCC Rules. These limits are designed to provide reasonable protection against harmful interference when the equipment is operated in a commercial environment. This equipment generates, uses, and can radiate radio frequency energy and, if not installed and used in accordance with the instruction manual, may cause harmful interference to radio communications. Operation of this equipment in a residential area is likely to cause harmful interference in which case the user will be required to correct the interference at his own expense.

**Note****Technical modifications**

Technological changes to the device may cause the loss of the FCC approval.

9.4 FCC Approval for Canada

FCC: Canadian Notice

This equipment does not exceed the Class A limits for radiated emissions as described in the Radio Interference Regulations of the Canadian Department of Communications.