

# **OSP-U100M OSP-U10M**

---

---

## **ALARM & ERROR LIST (3rd Edition)**

Pub. No. 4187-E-R2 (ME37-004-R3) Oct. 2002

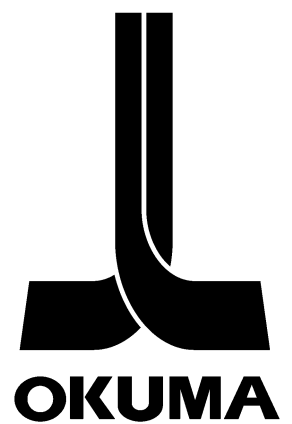

# SAFETY PRECAUTIONS

The machine is equipped with safety devices which serve to protect personnel and the machine itself from hazards arising from unforeseen accidents. However, operators must not rely exclusively on these safety devices: they must also become fully familiar with the safety guidelines presented below to ensure accident-free operation.

This instruction manual and the warning signs attached to the machine cover only those hazards which Okuma can predict. Be aware that they do not cover all possible hazards.

## 1. Precautions Relating To Machine Installation

- (1) Install the machine at a site where the following conditions (the conditions for achievement of the guaranteed accuracy) apply.
  - Ambient Temperature : 17 to 25 °C
  - Ambient humidity : 75% or less (no condensation)
  - Site not subject to direct sunlight or excessive vibration; environment as free of dust, acid, corrosive gases, and salt spray as possible.
- (2) Prepare a primary power supply that complies with the following requirements.
  - Voltage : 200V
  - Voltage fluctuation :  $\pm 10\%$  max.
  - Power supply frequency : 50/60 Hz
  - Do not draw the primary power supply from distribution panel that also supplies a major noise source (for example an electric welder or electric discharge machine) since this could cause malfunction of the NC unit.
  - If possible connect the machine to a ground not used by any other equipment. If there is no choice but to use a common ground, the other equipment must not generate a large amount of noise (such as an electric welder or electric discharge machine).
- (3) Installation Environment

Observe the following points when installing the electrical control cabinet.

  - Make sure that the NC unit will not be subject to direct sunlight.
  - Make sure that the electrical control cabinet will not be splashed with chips, water, or oil.
  - Make sure that the electrical control cabinet and operation panel are not subject to excessive vibrations or shock.
  - The permissible ambient temperature range for the electrical control cabinet is 0 to 40°C.
  - The permissible ambient humidity range for the electrical control cabinet is 30 to 95% (no condensation).
  - The maximum altitude at which the electrical control cabinet can be used is 1000 m (3281 ft.).

## **2. Points To Check Before Turning On The Power**

- (1) Close all the doors of the electrical control cabinet and operation panel to prevent the entry of water, chips, and dust.
- (2) Make absolutely sure that there is nobody near the moving parts of the machine, and that there are no obstacles around the machine, before starting machine operation.
- (3) When turning on the power, turn on the main power disconnect switch first, then the CONTROL ON switch on the operation panel.

## **3. Precautions Relating To Operation**

- (1) After turning on the power, carry out inspection and adjustment in accordance with the daily inspection procedure described in this instruction manual.
- (2) Use tools whose dimensions and type are appropriate for the work undertaken and the machine specifications. Do not use badly worn tools since they can cause accidents.
- (3) Do not for any reason touch the spindle or tool while spindle indexing is in progress since the spindle could rotate: this is dangerous.
- (4) Check that the workpiece and tool are properly secured.
- (5) Never touch a workpiece or tool while it is rotating: this is extremely dangerous.
- (6) Do not remove chips by hand while machining is in progress since this is dangerous. Always stop the machine first, then remove the chips with a brush or broom.
- (7) Do not operate the machine with any of the safety devices removed. Do not operate the machine with any of the covers removed unless it is necessary to do so.
- (8) Always stop the machine before mounting or removing a tool.
- (9) Do not approach or touch any moving part of the machine while it is operating.
- (10) Do not touch any switch or button with wet hands. This is extremely dangerous.
- (11) Before using any switch or button on the operation panel, check that it is the one intended.

## **4. Precautions Relating to the ATC**

- (1) The tool clamps of the magazine, spindle, etc., are designed for reliability, but it is possible that a tool could be released and fall in the event of an unforeseen accident, exposing you to danger: do not touch or approach the ATC mechanism during ATC operation.
- (2) Always inspect and change tools in the magazine in the manual magazine interrupt mode.
- (3) Remove chips adhering to the magazine at appropriate intervals since they can cause misoperation.  
Do not use compressed air to remove these chips since it will only push the chips further in.
- (4) If the ATC stops during operation for some reason and it has to be inspected without turning the power off, do not touch the ATC since it may start moving suddenly.

## 5. On Finishing Work

- (1) On finishing work, clean the vicinity of the machine.
- (2) Return the ATC, APC and other equipment to the predetermined retraction position.
- (3) Always turn off the power to the machine before leaving it.
- (4) To turn off the power, turn off the CONTROL ON switch on the operation panel first, then the main power disconnect switch.

## 6. Precautions During Maintenance Inspection and When Trouble Occurs

In order to prevent unforeseen accidents, damage to the machine, etc., it is essential to observe the following points when performing maintenance inspections or during checking when trouble has occurred.

- (1) When trouble occurs, press the emergency stop button on the operation panel to stop the machine.
- (2) Consult the person responsible for maintenance to determine what corrective measures need to be taken.
- (3) If two or more persons must work together, establish signals so that they can communicate to confirm safety before proceeding to each new step.
- (4) Use only the specified replacement parts and fuses.
- (5) Always turn the power off before starting inspection or changing parts.
- (6) When parts are removed during inspection or repair work, always replace them as they were and secure them properly with their screws, etc.
- (7) When carrying out inspections in which measuring instruments are used - for example voltage checks - make sure the instrument is properly calibrated.
- (8) Do not keep combustible materials or metals inside the electrical control cabinet or terminal box.
- (9) Check that cables and wires are free of damage: damaged cables and wires will cause current leakage and electric shocks.
- (10) Maintenance inside the Electrical Control Cabinet
  - a) Switch the main power disconnect switch OFF before opening the electrical control cabinet door.
  - b) Even when the main power disconnect switch is OFF, there may be some residual charge in the servo amplifier and spindle drive unit, and for this reason only service personnel are permitted to perform any work on these units. Even then, they must observe the following precautions.
    - Servo amplifier  
Discharge the residual voltage one minute after turning off the breaker inside the unit.
    - Spindle drive unit  
Discharge the residual voltage one minute after turning off the main power disconnect switch.

- c) The electrical control cabinet contains the NC unit, and the NC unit has a printed circuit board whose memory stores the machining programs, parameters, etc. In order to ensure that the contents of this memory will be retained even when the power is switched off, the memory is supplied with power by a battery. Depending on how the printed circuit boards are handled, the contents of the memory may be destroyed and for this reason only service personnel should handle these boards.
- (11) Periodic Inspection of the Electrical Control Cabinet
- a) Cleaning the cooling unit
- The cooling unit in the door of the electrical control cabinet serves to prevent excessive temperature rise inside the electrical control cabinet and increase the reliability of the NC unit.
- Inspect the following points every three months.
- Is the fan motor inside the cooling unit working?  
The motor is normal if there is a strong draft from the unit.
  - Is the external air inlet blocked?  
If it is blocked, clean it with compressed air.

## 7. General Precautions

- (1) Keep the vicinity of the machine clean and tidy.
- (2) Wear appropriate clothing while working, and follow the instructions of someone with sufficient training.
- (3) Make sure that your clothes and hair cannot become entangled in the machine. Machine operators must wear safety equipment such as safety shoes and safety goggles.
- (4) Machine operators must read the instruction manual carefully and make sure of the correct procedure before operating the machine.
- (5) Memorize the position of the emergency stop button so that you can press it immediately at any time and from any position.
- (6) Do not access the inside of the control panel, transformer, motor, etc., since they contain high-voltage terminals and other components which are extremely dangerous.
- (7) If two or more persons must work together, establish signals so that they can communicate to confirm safety before proceeding to each new step.

## 8. Symbols Used in This Manual

The following warning indications are used in this manual to draw attention to information of particular importance. Read the instructions marked with these symbols carefully and follow them.

 : Indicates an imminent hazard which, if not avoided, will result in death or serious injury.

 : Indicates unsafe practices which, if not avoided, could result in death or serious injury.

 : Indicates unsafe practices which, if not avoided, could result in minor injuries or damage to devices or equipment.

 : Indicates precautions relating to operation or use.

TABLE OF CONTENTS

	<u>PAGE</u>
SECTION 1 SAFETY PRECLASSIFICATION OF ALARMS .....	1
SECTION 2 CPU ALARM .....	9
SECTION 3 ALARM P .....	16
SECTION 4 ALARM A .....	88
SECTION 5 ALARM B .....	174
SECTION 6 ALARM C .....	349
SECTION 7 ALARM D .....	410
SECTION 8 ERRORS .....	477

## SECTION 1 CLASSIFICATION OF ALARMS

Alarms related with the OSP are classified into six types such as CPU alarm, Alarm P, A, B, C and D.

### Alarm Classifications

Alarm	Machine Conditions When ALARM Lamp Comes ON	Operative NC Functions Thereafter
CPU	Stops NC operation. Stops; - axis feed - spindle rotation - coolant supply Axis drive power is switched OFF. CPU status is displayed on the operation panel.	All NC functions are inoperative. Concerning the control, cancel the alarm by turning power on again after turning it off once.
P	Stops NC operation. Stops; - axis feed - spindle rotation - coolant supply Axis drive power is switched OFF. Alarm display is given on the operation panel.	All NC functions are inoperative. Concerning the control, cancel the alarm by turning power on again after turning it off once.
A	Stops; - axis feed - spindle rotation - coolant supply Axis drive power is switched OFF. Alarm display is given on the operation panel.	Operations for display are possible. The machine remains inoperative until the control is reset and the alarm condition is removed.
B	The commands in the active block are completed. Spindle rotation and coolant supply do not stop. Axis drive power is not switched OFF. Alarm display is given on the operation panel.	Operations for display are possible. The machine remains inoperative until the control is reset and the alarm condition is removed.
C	The part program being run is executed to the end (up to M02 command). Spindle rotation and coolant supply do not stop. Axis drive power is not switched OFF. Alarm display is given on the operation panel.	Operations for display are possible. New program cannot be executed until the alarm is released.
D	This alarm does not give any influence to the machine operation. Alarm display is given on the operation panel.	Operations on the operation panel are all operative. Alarm status cannot be reset unless the cause of alarm is removed.

The display format of CPU alarm, alarm P, A, B, C and D is indicated on pages 2 and 4.



Display Format of CPU Alarms (Bus error)

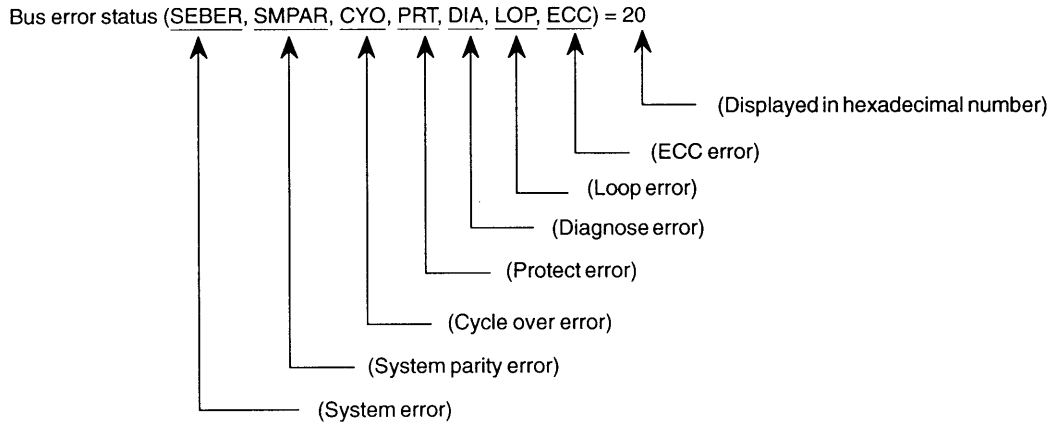
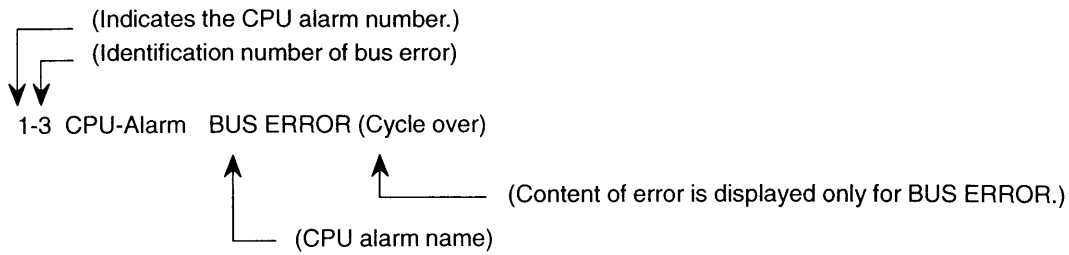

Special status word = 0165

Access address = 00104250

D0 = 43520000	D1 = 00000000	D2 = 0000000B	D3 = 00000210	(Indicates the data register D0 through D7.)
D4 = 0000000A	D5 = 00000000	D6 = 00000000	D7 = 00000000	
A0 = FFFFCC06	A1 = 00000000	A2 = FFFFF7C7	A3 = 00000000	(Indicates the data register A0 through A7.)
A4 = 00000000	A5 = 00000000	A6 = 00000600	A7 = 0007FC84	
US = 0007FC84	IS = 000FFEE4	MS = 0000CFB0	SR = 0000100D	
PC = 0002E704				

## Display Format of CPU Alarms (Address error)

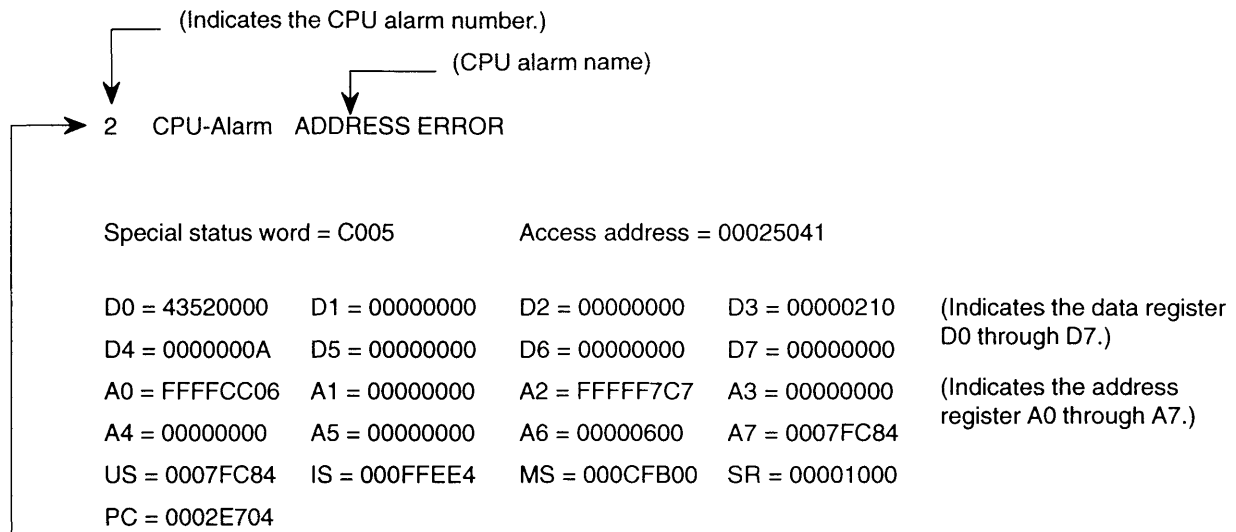

Depending on the alarm content, following display is given.

3. CPU alarm	Illegal instruction error	17 CPU alarm	Format error
4. CPU alarm	Zero divide error	18 CPU alarm	Uninitialized interrupt error
5. CPU alarm	CHK instruction error	19 CPU alarm	Floating-point coprocessor unordered condition error
6. CPU alarm	TRAPV instruction error	20 CPU alarm	Floating-point coprocessor inexact result error
7. CPU alarm	Privilege violation error	21 CPU alarm	Floating-point coprocessor divide by zero error
8. CPU alarm	Trace error	22 CPU alarm	Floating-point coprocessor underflow error
9. CPU alarm	Line 1010 emulator error	23 CPU alarm	Floating-point coprocessor operand error
10. CPU alarm	Line 1111 emulator error	24 CPU alarm	Floating-point coprocessor overflow error
11. CPU alarm	Exception vector error	25 CPU alarm	Floating-point coprocessor signaling NAN error
12. CPU alarm	Spurious interrupt error		
13. CPU alarm	Interrupt error		
14. CPU alarm	TRAP instruction error		
15. CPU alarm	User interrupt error		
16. CPU alarm	Coprocessor protocol violation error		

---

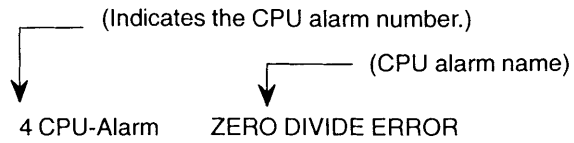
 Display Format of CPU Alarms (Typical exception)

D0 = 43520000	D1 = 00000000	D2 = 0000000B	D3 = 00000210	(Indicates the data register D0 through D7.)
D4 = 0000000A	D5 = 00000000	D6 = 00000000	D7 = 00000000	
A0 = FFFFCC06	A1 = 00000000	A2 = FFFFF7C7	A3 = 00000000	(Indicates the address register A0 through A7.)
A4 = 00000000	A5 = 00000000	A6 = 00000600	A7 = 0007C234	
US = 0007C234	IS = 000FFEE0	MS = 000CE470	SR = 00001008	
PC = 00024250				

## Display Format of Alarm P, A, B, C and D

□□□□-◇◇	<b>ALARM-A</b>	*****	○○○	△△△	‘▽▽▽’	
①	②	③	④	⑤	⑥	⑦
	①	.....	Alarm number			
	②	.....	Object number			
	③	.....	Alarm level			
	④	.....	Alarm message			
	⑤	.....	Object message			
	⑥	.....	Alarm code			
	⑦	.....	Alarm character-string			

## Object Number and Object Message

The object number and the object message show the programming system and the control axis where the alarm has occurred by the number and message as shown in the table below:

Object No.	Meaning	Object message
01	Linear axis	X-axis
02	Linear axis	Y-axis
03	Linear axis	Z-axis
04	Linear axis	U-axis
05	Linear axis	V-axis
06	Linear axis	W-axis
07	Rotary axis	A-axis
08	Rotary axis	B-axis
09	Rotary axis	C-axis
10	Crossrail (EC-W) axis	WA-axis
11	ATC magazine axis 1	MA-axis
12	ATC magazine axis 2	MB-axis
13	ATC magazine axis 3	MC-axis
14	Tool change arm swing axis	TS-axis
15	Tool change arm insert/extract axis	TI-axis
16	APC axis 1	PA-axis
17	APC axis 2	PB-axis
18	Multi-pallet magazine axis	PL-axis
19	Attachment axis	AT-axis
20	Attachment magazine axis 1	AA-axis
21	Attachment magazine axis 2	AB-axis
22	ATC carrier axis	CA-axis
23	ATC carrier axis	CB-axis

- As indicated above, the object numbers and messages to be used are determined by the machine specifications.

**Alarm Codes:**

In this manual, alarm codes are explained using such as “X”, “XX”, and “XXYY”.

Explanation is given in the following methods:

- 1) The alarm code indicated in this text can be used directly as the key to find the contents of error.
- 2) The alarm code indicated in this text should first be converted into bit expression (pattern), which is then used as the key to find the contents of error.

In the case of 2), the procedure to convert the alarm code into bit pattern is shown below.

Bit conversion method:

Alarm Code (Expressed in hexadecimal)	Bit Pattern
0	0000
1	0001
2	0010
3	0011
4	0100
5	0101
6	0110
7	0111
8	1000
9	1001
A	1010
B	1011
C	1100
D	1101
E	1110
F	1111

How to check alarm contents:

The method to find the details of the alarm indicated by the bit pattern is explained below using an example

Example:

[Code] XX

XX Bit 0	Battery error
Bit 1	EC I/O power shut off error
Bit 2	ECC error
Bit 3	Not used
Bit 4	Not used
Bit 5	EDRQ INT signal
Bit 6	ECP INT signal
Bit 7	ECP RUN signal

If an alarm occurs, a hexadecimal number is displayed. If "\$C1" is displayed, for example, first convert this "\$C1" into bits.

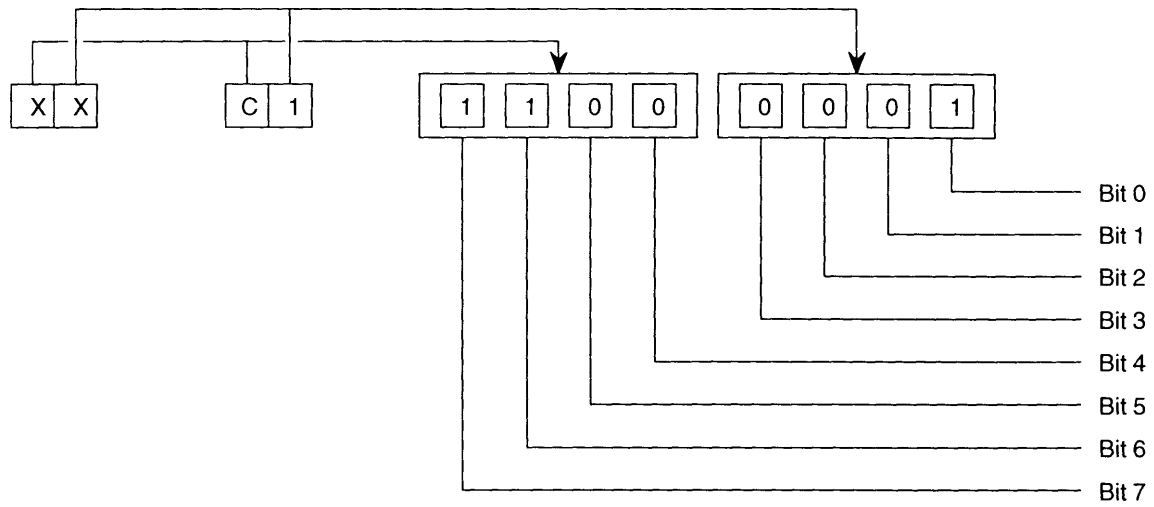

After the conversion, it is known that Bit0, Bit6, and Bit7 are ON. See the information above and you will find that these error codes correspond to "battery error", "ECP INT signal", and "ECP RUN signal", respectively.

## Error Display Format

□□□□      \*\*\*\*\*      ERROR      ΔΔΔ      '▽▽▽'  
①                      ②                      ③                      ④                      ⑤

- ① ..... Error number
- ② ..... Error message
- ③ ..... Indication of ERROR
- ④ ..... Error code
- ⑤ ..... Error character-string

---

## SECTION 2 CPU ALARM

Alarm No.	Alarm Message
1	BUS
2	ADDRESS
3	ILLEGAL INSTRUCTION
4	ZERO DIVIDE
5	CHK INSTRUCTION
6	TRAPV INSTRUCTION
7	PRIVILEGE VIOLATION
8	TRACE
9	LINE 1010 EMULATOR
10	LINE 1111 EMULATOR
11	EXCEPTION VECTOR
12	SPURIOUS INTERRUPT
13	INTERRUPT
14	TRAP INSTRUCTION
15	USER INTERRUPT
16	COPROCESSOR PROTOCOL VIOLATION
17	FORMAT
18	UNINITIALIZED INTERRUPT
19	FPCP UNORDERED CONDITION
20	FPCP INEXACT RESULT
21	FPCP DIVIDE BY ZERO
22	FPCP UNDERFLOW
23	FPCP OPERAND
24	FPCP OVERFLOW
25	FPCP SIGNALING NAN



**★ 1 BUS ERROR**

This alarm is caused when the bus error exception has occurred with the CPU.

Details of BUS error:

When the bus error occurs, the CPU status is displayed in hexadecimal numbers.

At the same time, the red LED at the CPU rack lights up.

The bus error includes the following five types of errors:

- 1) Cycle time over error
- 2) ECC error
- 3) Protect error
- 4) Loop error
- 5) System bus error
- 6) Double-bus error

Note:Error display is not available in the case of double-bus error.

[Index] None

[Character-string] None

[Code] CPU status

[Probable Faulty Locations]

- 1) Printed circuit boards
- 2) Mother board
- 3) Loose card edge connector connection
- 4) Loose flat cable connection
- 5) Switch settings

[Measures to Take]

Depending on the type of error encountered, check the following points.

- 1) ECC error . . . . . Mainboard, Memory board
- 2) Protect error . . . . . Main board
- 3) Cycle time over error . . . Judge the faulty PCB from the access address.
- 4) Loop error. . . . . PCB which generates the interruption in question; judge the interruption level from the . . . . . status register.
- 5) System bus error . . . . . All main boards
- 6) Double-bus error . . . . . All PCB's

Then, carry out the following steps.

- 1) Check the switch settings.  
Make sure that the boards are free of foreign material.  
Make sure that flat cables are inserted correctly.  
Make sure that card edge connectors are clean.
- 2) Change the card insertion slots; check if the problem occurrence status changes.
- 3) Replace the suspectable boards.

**★ 2 ADDRESS**

This error occurs when the CPU has accessed word operands, long word operands or instructions by an odd number address.

[Index] None

[Character-string] None

[Code] None

[Probable Faulty Locations] Main board

[Measures to Take] Replace the main board.

**★ 3 ILLEGAL INSTRUCTION**

This error occurs when the CPU has read an unallowable instruction.

[Index] None

[Character-string] None

[Code] None

[Probable Faulty Locations] Main board

[Measures to Take] Replace the main board.

**★ 4 ZERO DIVIDE**

This error occurs when the CPU executes a division command with a divisor of <#007F>0".

[Index] None

[Character-string] None

[Code] None

[Probable Faulty Locations] Main board

[Measures to Take] Replace the main board.

**★ 5 CHK INSTRUCTION**

This error occurs when the CPU executes the CHK instruction under certain conditions (such that the register value is less than 0 or that the register value is greater than the upper limit in the operand word.)

[Index] None

[Character-string] None

[Code] None

[Probable Faulty Locations] Main board

[Measures to Take] Replace the main board

**★ 6 TRAPV INSTRUCTION**

This error occurs when the overflow condition bit is turned on in the status register when the TRAPV instruction is executed by the CPU.

[Index] None

[Character-string] None

[Code] None

[Probable Faulty Locations] Main board

[Measures to Take] Replace the main board.

**★ 7 PRIVILEGE VIOLATION**

This error occurs when the CPU executes a privilege instruction (instructions that can be executed only in the supervisor condition) in the user condition.

[Index] None

[Character-string] None

[Code] None

[Probable Faulty Locations] Main board

[Measures to Take] Replace the main board.

**★ 8 TRACE**

This error occurs when the CPU executes an instruction in the trace condition.

[Index] None

[Character-string] None

[Code] None

[Probable Faulty Locations] Main board

[Measures to Take] Replace the main board.

**★ 9 LINE 1010 EMULATOR**

This error occurs when the instruction having the word pattern of "<#007F>1010" is executed.

[Index] None

[Character-string] None

[Code] None

[Probable Faulty Locations] Main board

[Measures to Take] Replace the main board.

**★ 10 LINE 1111 EMULATOR**

This error occurs when the instruction having the word pattern of "1111" is executed.

[Index] None

[Character-string] None

[Code] None

[Probable Faulty Locations] Main board

[Measures to Take] Replace the main board.

**★ 11 EXCEPTION VECTOR**

This error occurs when the CPU has referenced the exception vector which is not referenced normally.

[Index] None

[Character-string] None

[Code] None

[Probable Faulty Locations] Main board

[Measures to Take] Replace the main board.

**★ 12 SPURIOUS INTERRUPT**

This error occurs when a spurious interruption to the CPU has been made.

[Index] None

[Character-string] None

[Code] None

[Probable Faulty Locations] Main board

[Measures to Take] Replace the main board.

**★ 13 INTERRUPT**

This error occurs when an unusual interruption to the CPU has been made.

[Index] None

[Character-string] None

[Code] None

[Probable Faulty Locations]

- 1) All printed circuit boards which generate interruption
- 2) Error in setting interruption level

[Measures to Take]

- 1) Check the setting of interruption level setting switches at individual printed circuit boards.
- 2) Judge the interruption level from the value at the status register (SR) when an error has occurred.  
The third digit from the right-most digit indicates the interruption level.  
Change the printed circuit board which generates the judged interruption.
- 3) Replace the main board.
- 4) Replace the mother board.

**★ 14 TRAP INSTRUCTION**

This error occurs when the CPU has referenced the TRAP exception vector which is not referenced normally.

[Index] None

[Character-string] None

[Code] None

[Probable Faulty Locations] Main board

[Measures to Take] Replace the main board.

**★ 15 USER INTERRUPT**

This error occurs when unusual user interruption has occurred.

[Index] None

[Character-string] None

[Code] None

[Probable Faulty Locations] Main board

[Measures to Take] Replace the main board.

**★ 16 COPROCESSOR PROTOCOL VIOLATION**

This error occurs when communication fails between the CPU and the coprocessor.

[Index] None

[Character-string] None

[Code] None

[Probable Faulty Locations] Main board

[Measures to Take] Replaces the main board

**★ 17 FORMAT**

This error occurs when the CPU detects an improper value as a result of data check required for operation control.

[Index] None

[Character-string] None

[Code] None

[Probable Faulty Locations] Main board

[Measures to Take] Replaces the main board

**★ 18 UNINITIALIZED INTERRUPT**

This error occurs when an interruption occurs before initialization of the vector numbers of peripheral devices.

[Index] None

[Character-string] None

[Code] None

[Probable Faulty Locations] Main board

[Measures to Take] Replaces the main board

**★ 19 FPCP UNORDERED CONDITION**

This error occurs when the floating-point coprocessor attempts execution of a comparison command with non-numerals.

[Index] None

[Character-string] None

[Code] None

[Probable Faulty Locations] Main board

[Measures to Take] Replaces the main board

**★ 20 FPCP INEXACT RESULT**

This error occurs when the floating-point coprocessor loses some digits in arithmetic operation.

[Index] None

[Character-string] None

[Code] None

[Probable Faulty Locations] Main board

[Measures to Take] Replaces the main board

**★ 21 FPCP DIVIDE BY ZERO**

This error occurs when the floating-point coprocessor attempts division by a number having a denominator of "0" in execution of a division command.

[Index] None

[Character-string] None

[Code] None

[Probable Faulty Locations] Main board

[Measures to Take] Replaces the main board

**★ 22 FPCP UNDERFLOW**

This error occurs when the floating-point coprocessor obtains a value too small to express as a result of arithmetic operation.

[Index] None

[Character-string] None

[Code] None

[Probable Faulty Locations] Main board

[Measures to Take] Replaces the main board

★ 23 **FPCP OPERAND**

This error occurs when the floating-point coprocessor executes an arithmetic instruction having no solution.

[Index] None

[Character-string] None

[Code] None

[Probable Faulty Locations] Main board

[Measures to Take] Replaces the main board

★ 24 **FPCP OVERFLOW**

This error occurs when the floating-point coprocessor obtains a value too large to express as a result of arithmetic operation.

[Index] None

[Character-string] None

[Code] None

[Probable Faulty Locations] Main board

[Measures to Take] Replaces the main board

★ 25 **FPCP SIGNALING NAN**

This error occurs when the floating-point coprocessor executes an arithmetic instruction having operands of signaling non-numerals.

[Index] None

[Character-string] None

[Code] None

[Probable Faulty Locations] Main board

[Measures to Take] Replaces the main board

## SECTION 3 ALARM P

Alarm No.	Alarm Message
0721	DeviceNet error
0722	FCP Board Error
0723	I/O Data Combined File Reading
0800	Spindle D/A control data file read
0801	TCP/IP illegal
0802	Load information file not found
0803	File load illegal
0804	MSB file is not same
0805	MOP-TOOL PARAMETER PBU LOAD
0806	MOP-TOOL TOOL-DATA PBU LOAD
0807	ACP panel status receive error
0808	Speed change ratio failure
0809	FCP illegal
0810	NCIO data file read
0811	FCP IO link communication error
0812	MCS start
0813	MCS communication error
0814	MCS data file
0815	PLC Real time task loop error
0816	PLC initial error
0817	MCS Error
0818	ADP START
0829	SPMC Program load
0830	SPMC Execution stop
0831	SPM Exception processing
0832	SPM System Call error
0833	MCS Option-program-file not send
0834	MCS Servo-data error
0835	MCS Communication
0839	Specification Condition Failure
0840	Super-Hi-NC specification unmatching
0841	FCP4 illegal
0842	Safety-monitor Spec Error
0850	MCS Undefined alarm number
0851	MCS Exception processing
0852	MCS Processing trouble
0853	MCS CON APA deviation
0854	MCS Power-Supply-Unit Error
0855	MCS Converter-link error
0856	MCS DC-bus voltage alarm
0857	MCS Motor over current
0858	MCS Power unit over heat

Alarm No.	Alarm Message
0859	MCS Power unit over load
0860	MCS Supply voltage flutter
0861	MCS Power unit version error
0862	MCS Winding-change failed
0863	MCS Encoder-link error
0864	MCS Encoder error
0865	MCS Encoder initialize failed
0866	MCS Encoder with shaft error
0867	MCS Encoder with shaft initial
0868	MCS ABSO SCALE error
0869	MCS ABSO SCALE initialize
0870	MCS Magnetic encoder alarm
0871	MCS Resolver alarm
0872	MCS Pulse generator count over
0873	MCS Motor over heat
0874	MCS Servo-link error
0875	MCS Servo-link disconnect
0876	MCS Servo-link protocol error
0877	MCS Servo data error
0878	MCS Illegal command
0879	MCS CON speed over
0880	MCS Speed command over
0881	MCS DIFF over
0882	MCS APA speed over
0883	MCS Full-closed APA error
0884	MCS Over speed
0885	MCS Velocity deviation over
0886	MCS Collision detected
0887	MCS Urgent-stop time over
0888	MCS Belt is broken
0889	MCS Axis change control error
0890	MCS Independent encoder init
0891	MCS APA error
0892	MCS Motor over load
0893	MCS Safety Speed Monitor E-LINK Error
0900	SVP start conditions uncertain
0901	SVP processing trouble
0902	SVP CON APA deviation
0903	SVP error
0904	SVP exception processing
0905	SVP APA pattern data
0906	SVP APA speed
0907	SVP CON speed



Alarm No.	Alarm Message
0908	SVP DIFF over
0909	SVP servo amp
0910	SVP APA check data
0911	SVP speed command over
0912	SVP servo data setting
0913	SVP Belt is broken
0914	SVP F-TYPE encoder error
0915	SVP full closed loop error
0916	SVP F-TYPE encoder with shaft error
0917	SVP F with shaft APA pattern data
0918	SVP cannot plant error offset data
0919	SVP encoder application (MOTOR SHAFT)
0920	SVP encoder application (WITH SHAFT)
0921	SVP collision detection
0922	SVP SA overload
0923	SVP SA communication error
0924	SVP SA version error
0925	SVP SA motor cable overcurrent
0926	SVP SA inverter bridge short circuit
0927	SVP SA overheating
0928	SVP SA power circuit overvoltage
0929	SVP SA power circuit low voltage
0930	SVP SA regenerative resistor overheat
0931	SVP SA control circuit power voltage
0932	SVP SA error
0933	SVP board version error
0934	SVP control error
0935	SVP data file read
0936	SVP data file data address
0937	SVP data file check
0938	VAC start
0939	VAC data file read
0940	Time sharing task control
0941	Real time task control
0942	Real time task loop error
0943	Main processor name incorrect
0944	Slave processor name incorrect
0945	Memory board / battery life
0946	TFP illegal
0947	TFP data file read
0948	TFP Field net communication error
0949	IO DIAGNOSTICS data file read
0950	IO MACRO data file read

Alarm No.	Alarm Message
0951	SMP illegal
0952	Processor Board not equip
0954	Peripheral processor start
0955	Spec. code: data file
0956	Backup data file read
0957	Graphic Back up data file read
0958	Pitch compensate data file read
0959	IGF Specification unmatching
0960	IGF Backup data file read
0961	IGF illegal
0962	CCP Reader file load
0963	CCP Application file load
0964	CCP Parameter file load
0965	Configuration file format error
0966	Configuration file open error
0967	Array limit check table is bad
0968	No specification
0969	Memory size is not same
0970	Synchronous axis specification code
0971	Cache data / initialization error
0972	SVP INDEXING high-speed indexing over
0973	SVP INDEXING low-speed indexing over
0974	SVP INDEXING unclamp time over
0975	SVP INDEXING clamp time over
0976	SVP INDEXING positioning direction
0977	SVP INDEXING incorrect command
0978	SVP INDEXING servo data setting
0981	SVP LE sum check error
0982	SVP LE data error
0983	SVP LE incre. abso. error
0984	SVP LE comparator AD error
0985	SVP LE face rotation error
0986	SVP LE initial transfer data error
0987	SVP LE application error
0988	DNC-DT Preload task start error
0989	CPU information table data unsuitable
0990	TASK generate error
0991	TASK information table data unsuitable
0992	PLC backup data file read
0993	TCP/IP board error
0994	TCP/IP configuration file error
0995	Machine axis data file
0996	PLC axis data file

Alarm No.	Alarm Message
0997	PLC monitor backup data file read
0998	PLC sequence program load
0999	Synchronous tap's data file read

★ 0721 DeviceNet error

\* This alarm is common to OSP-U100, E100 and P100.

[Index] None

[Character-string]

CH\* SC\$

\*: Channel where an error occurred

\$. Sequence counter

[Code] XXYYZZZZ

XX : MacID of the slave where the error occurred

YY : Error status of the slave identified by XX.

0x00: Normal state or absence of slave

0x46: Double use of MacID

0x48: The device has stopped communication.

0x49: The device ID information does not match the value in the scan list.

0x4D: The data size is different from the set value.

0x4E: No response from the device in connection

0x50: The device is in idle mode.

0x53: An error was received in connection.

0x54: The response time out occurred in connection.

0x56: The device has entered the idle state.

0x5B: Bus OFF

0x5C: Network power supply OFF

(When the alarm has been caused not by the slave but by other reason such as communication delay, XXYY becomes OxFFFF.)

ZZZZ : Scanner error status

bit0: Memory check error (at memory initialization)

bit1: Scan list initialization error

bit2: Scan list matching check error (MacID)

bit3: Scan list matching check error (Input data)

bit4: Scan list matching check error (Output data)

bit5: Double use of MacID

bit6: Status error of network power supply

bit7: Memory parity error

bit8: Input data receiving error (once)

bit9: Input data receiving error (twice in a low)

bit10: Output data sending error (once)

bit11: Output data sending error (twice in a low)

bit12: Slave communication delay (once)

bit13: Slave communication delay (twice in a low)

bit14: Bus OFF

bit15: Diagnostic information access control error

[Probable Faulty Locations]

- Hardware failure
- Software failure

★ 0722 **FCP Board Error**

The FCP board is in abnormal state.

[Character-string]

AAAABB

AAAA: Name of task under execution

BB: Running program module

[Code]

VWXXYYZZ

V=1 Indicates FCP-DN board

W=0

XXYYZZ is the same as the code displayed with Alarm P809.

W=1 Indicates OS error.

XX=00 PLT0 task

XX=01 PLT1 task

XX=09 PLSY task

XX=10 PLR2 task

XX=20 PLR3 task

YYZZ=(Indicates the content.)

YYZZ=0001 Task forced termination failure

YYZZ=0002 Task start failure

YYZZ=0003 Task restart failure

YYZZ=0004 Task restart failure within a waiting time of 1.6 ms

W=2 Indicates internal memory check error

XXYYZZ indicates the head address in the check area.

★ 0723 **I/O Data Combined File Reading**

The NC failed to read I/O data combined file.

[Code]

Load status of I/O data combined file (in hexadecimal)

2-> File open error (no file)

3-> File read error (no data)

4-> File attribute error (not 'PBU1')

5-> File close error

6-> File size error (smaller)

7-> File size error (larger)

100-> Machine type for PLC is wrong.

200-> PLC class is wrong.

300-> File version is wrong.

★ 0800 **Spindle D/A control data file read**

The NC failed to properly read the spindle D/A control data file.

[Index] None

[Character-string] None

[Code] XY

X = Gear set number (Initially found problem gear set number. If Y = any of 1 to 6, X will not be displayed.)

Y = 1 No data file

2 Data file type is not PBU1.

3 Larger data file size

- 4 Improper data file size
- 5 The number of gear sets does not match the data file size.
- 6 The number of gear sets is other than 1 to 4.
- 7 Motor speed limit or spindle speed limit is 0.
- 8 Maximum spindle speed is 0.

[Probable Faulty Locations] Error in creation of the spindle D/A control data file

[Measures to Take] Correctly create a spindle D/A control data file.

[Related Specifications] Spindle D/A control specification

**★ 0801 TCP/IP illegal**

During activation of DNC-T1, T2, T3, or DT function, a CPU error occurred on TCP/IP board.

[Index] None

[Character-string] None

[Code] XXYYZZ

XX -> Board status in hexadecimal  
bit7bit6bit5bit4bit3bit2 bit1 bit0  
RUNHALTCPUOFF0SNMI00 0

YY -> Bus error status in hexadecimal  
bit7bit6bit5bit4bit3bit2 bit1 bit0  
0 00 0PROT DAI LOOP ECC

ZZ -> Always 0

[Probable Faulty Locations]

- 1) Hardware error on TCP/IP board
- 2) Software error on TCP/IP firmware

**★ 0802 Load information file not found**

In file creation by the custom software production system, the load information file which agrees with the specification code was not found.

Or, a file described in the load information file was not found.

[Index] None

[Character-string] Problem file name

[Code] None

However, there may be a case where an error message is output in the console line.

[Probable Faulty Locations] Defective installation, software production error, or specification code error

[Measures to Take]

Reinstall the software.

Reissue the install floppy disk.

**★ 0803 File load illegal**

In file creation by the custom software production system, the software which agrees with the specification code was not found

[Index] None

[Character-string] Problem software file name

[Code]

- 1 -> The file ended without loading any character.
- 3 -> The file ended during file loading.
- 9 -> The device name was wrongly specified.

10 -> The file name was wrongly specified.

11 -> The file was not found.

[Probable Faulty Locations] Defective installation, software production error, or specification code error

[Measures to Take]

- 1) Reinstall the software.
- 2) Reissue the install floppy disk.

**★ 0804 MSB file is not same**

The MSB file used for IMAP-B and interactive programming B does not satisfy the NC software requirements.

[Index] None

[Character-string] None

[Code] X

- 1 -> The MSB file for IMAP-B and interactive programming B is not compatible with the NC software.

[Probable Faulty Locations] A wrong MSB file is selected for the NC software.

[Measures to Take] Use an MSB file of revision B or later for IMAP-B and interactive programming B.

**★ 0805 MOP-TOOL PARAMETER PBU LOAD**

The backup file (MMTUB\*.PBU) is not found, or its type or size is wrong.

[Index] None

[Character-string] None

[Code] X

- 1 -> The parameter PBU file (MMTUB\*.PBU) is not found in MD0:
- 2 -> The parameter PBU file (MMTUB\*.PBU) does not start from "PBU1" or has an improper length (other than 18 sectors).

[Probable Faulty Locations]

- 1) If the alarm occurred during normal NC operation, the PBU file has been deleted or its data has been destroyed.
- 2) If the alarm occurred without NC operation after installation of control floppy disk, the PBU file type was wrong or no PBU file was stored in the memory.

[Measures to Take]

- 1) If the alarm occurred before NC operation, create a correct control floppy.
- 2) If the alarm occurred during NC operation, reinstall the control floppy disk.

[Related Specifications] OSP7000M built-in type MOP-TOOL

**★ 0806 MOP-TOOL TOOL-DATA PBU LOAD**

The backup file (MMTUA\*.PBU) is not found, or its type or size is wrong.

[Index] None

[Character-string] None

[Code] X

- 3 -> The tool data PBU file (MMTUA\*.PBU) is not found in MD0:
- 4 -> The tool data PBU file (MMTUA\*.PBU) does not start from "PBU1" or has an improper length (other than 125 sectors).

[Probable Faulty Locations]

- 1) If the alarm occurred during normal NC operation, the PBU file has been deleted or its data has been destroyed.
- 2) If the alarm occurred without NC operation after installation of control floppy disk, the PBU file type was wrong or no PBU file was stored in the memory.

[Measures to Take]

- 1) If the alarm occurred before NC operation, create a correct control floppy.
- 2) If the alarm occurred during NC operation, reinstall the control floppy disk.

[Related Specifications] OSP7000M built-in type MOP-TOOL

**★ 0807 ACP panel status receive error**

The ACP board received abnormal data on operation panel status.

ObjectNone

[Character-string] None

[Code] XX (operation panel status data)

- bit7: Invalid panel status
- bit6: Operation panel CPU error
- bit3 to 5: Software version applied to operation panel firmware
- bit0 to 2: Operation panel type

**★ 0808 Speed change ratio failure**

For the machine with scroll machining function, a speed change ratio of X, Y, Z, or C-axis is defectively set. Or, a wrong type of position encoder is used.

[Index] None

[Character-string] None

[Code]

- 1 -> X-axis speed change ratio is set by a code.
- 2 -> Y-axis speed change ratio is set by a code.
- 3 -> Z-axis speed change ratio is set by a code.
- 4 -> C-axis speed change ratio is set by a code.
- 5 -> X-axis speed change ratio exceeds the setting range.
- 6 -> Y-axis speed change ratio exceeds the setting range.
- 7 -> Z-axis speed change ratio exceeds the setting range.
- 8 -> C-axis speed change ratio exceeds the setting range.
- 9 -> A wrong type of position encoder is used.

[Probable Faulty Locations]

Defective speed change ratio data in the servo data PBU file or wrong encoder type

[Measures to Take] Correct the data in the servo data PBU file.

[Related Specifications] Scroll machining function

**★ 0809 FCP illegal**

The FCP board is in abnormal state.

[Index] None

[Character-string] 'AAAABB'

AAAA->Name of task being processed

BB-> Program module number (hexadecimal) being executed

However, no character-string appears when transmission of the module is stopped or double bus error occurs.

[Code] XXYYZZ

XX:

01 -> Transmission module has stopped.

YYZZ=0000

02 -> Exception error



- YY:Exception error number(\*1)
- ZZ:FCP Bus error status(\*2)
- 03 -> Double bus error
  - YY:Exception error number(\*1)
  - ZZ:FCP Bus error status(\*2)
- 04 -> FCP was reset as soon as SNMI occurred at FCP.
  - YY:SNMI status(\*3)
  - ZZ:FCP Bus error status(\*2)
- \*1 -> Exception error No.
  - 01 -> Bus error
  - 02 -> Address error
  - 03 -> Illegal instruction
  - 04 -> Zero divide
  - 05 -> CHK instruction error
  - 06 -> TRAPV instruction error
  - 07 -> Privilege violation error
  - 08 -> Trace error
  - 09 -> Line 1010 emulator
  - 0A -> Line 1111 emulator
  - 0B -> Exception vector error
  - 0C -> Spurious interruption error
  - 0D -> Interruption error
  - 0E -> TRAP instruction error
  - 0F -> User interruption error
- \*2 -> FCP Bus error status
  - bit7-> System bus error
  - bit6 -> System bus parity error
  - bit5 -> Cycle over error
  - bit4 -> Protect error
  - bit3 -> Loop error
  - bit2 -> Loop error cancel
  - bit1 -> Memory parity error
  - bit0 -> Always 0
- \*3 -> SNMI status
  - bit7 -> Bus error at FCP
  - bit6 -> FCP executed SNMI command.
  - bit5 -> Oscillator module stopped oscillation.

★ 0810 **NCIO data file read**

The NC failed to read I/O data file.

[Index] None

[Character-string] None

[Code] I/O data file load status (in hexadecimal)

- 2 -> File open error (no file)
- 3 -> File read error (no data)
- 4 -> File attribute error (not ábPBU1\*/)
- 5 -> File close error
- 6 -> File size error (smaller size)
- 7 -> File size error (larger size)

100 -> Wrong PLC machine type  
200 -> Wrong PLC class  
300 -> Wrong file version

[Measures to Take] Consult the machine maker.

**★ 0811 FCP IO link communication error**

A communication error occurred in the I/O link on FCP board.

[Index] None

[Character-string] None

[Code] XxYYZZZZ

XX:

01 -> Channel number where FCP board error was detected  
x=0 -> Errors (other than below)  
x=1 -> Faulty connection of optical fibers  
x=2 -> Initialization error

YY:

bit7 -> Double transmission error  
bit6 -> Double reception error  
bit5 -> Format error  
bit4 -> CRC error  
bit3 -> Parity error (transmission/reception buffer)  
bit2 -> Disconnection command detected  
bit1 -> Time out error  
bit0 -> Undefined

ZZZZ:

bit15 -> Slave station error detected  
bit14 -> Undefined  
bit13 -> Undefined  
bit12 -> Start bit error  
bit11 -> Stop bit error  
bit10 -> Undefined  
bit9, 8 -> 00 ... Master station, slave station  
-> 01 ... Repeater No. 1  
-> 10 ... Repeater No. 2  
bit7 to 0 -> Slave station number where the error was detected (master station: \$00)

[Measures to Take] Consult the machine maker.

**★ 0812 MCS start**

An error occurred in initialization of MCS when the power was supplied.

[Index] None or axis name

[Character-string] Varies with the code.

[Code] XXXXYYYY

XXXX: Kind of generated alarm

YYYY: Further information on the alarm (Varies with XXXX.)

XXXX

FFFF...YYYY is 00UV. Where, U: Faulty channel number - 1

0= Channel 1

1= Channel 2

2= Channel 3

V: Cause of alarm (V=1 indicates that servo link mode has not been established.)

2 -> Two or more safety speed monitors are connected with one channel.

FF01...Memory error occurred in read/write test of the servo link I/O buffer.

YYYY=0 (always)

Character-string shows the address where the error occurred.

FF00...Communication LSI caused an error in read/write test of the servo link I/O buffer.

YYYY=Error status

Character-string shows the address where the error occurred.

F000...

YYYY=bit 7:Same ID number used

bit 6:Improper ID number

bit 5:Missing ID number

bit 4:Too many CH4 controllers

bit 3:Too many CH3 controllers

bit 2:Too many CH2 controllers

bit 1:Too many CH1 controllers

bit 0:

With this error, connection data appears in the screen center.

EF00...The servo link does not connect with all the required axes or connects with an improper axis.

YYYY=ID number of required axis controller

Character-string shows the problem axis name.

With this alarm, connection data appears in the screen center.

EE00...An error occurred in downloading an optional file.

High-order digit of YYYY shows the cause while low-order part is an error code.

If high-order digit=

1: File is not in OSP format.

2: File attribute is not contiguous.

3: File opening error. Low-order part is an error code.

4: Error in initial data reading. Low-order part is an error code.

5: File does not start with "MCS1".

6: File name is not followed by "OPFS".

7: The number of file sets is 0.

8: Data reading error. Low-order part is an error code.

9: File data has a sector length of 0.

A: The number of bytes transferred is 0.

B: File data has a sector length smaller than the number of bytes transferred.

C: Data reading error. Low-order part is an error code.

ED00...An error occurred when manual mode is switched to auto mode. High-order digit of YYYY shows the cause while low-order part is an error code.

High order digit=1: World clock does not start.

EC01...Time difference occurred in setting CH1 timer.

YYYY is the difference.

EC02...Time difference occurred in setting CH2 timer.

YYYY is the difference.

EC03...Time difference occurred in setting CH3 timer.

YYYY is the difference.

D001...In buffering the initial data in AT (auto) receive mode, the software synchronization bit does not come on within 3 [s].

YYYY is always 0.

D002...In buffering the initial data in AT (auto) receive mode, the buffer A received a wrong format code.

Two low-order characters of YYYY are the received format code.

D003...In buffering the initial data in AT (auto) receive mode, the buffer B received a wrong format code in the first block.

YYYY is the received format code.

D004...In buffering the initial data in AT (auto) receive mode, the buffer B received a wrong format code in the second block.

YYYY is the received format code.

D005...In buffering the initial data in AT (auto) receive mode, the buffer B received a wrong format code in the third block.

YYYY is the received format code.

D006...In buffering the initial data in AT (auto) receive mode, the buffer B received a wrong format code in the fourth block.

YYYY is the received format code.

D007...In buffering the initial data in AT (auto) receive mode, the buffer B received a wrong format code in the fifth block.

YYYY is the received format code.

D008...In buffering the initial data in AT (auto) receive mode, the buffer B received a wrong format code in the sixth block.

YYYY is the received format code.

D009...In buffering the initial data in AT (auto) receive mode, the buffer B received a wrong format code in the seventh block.

YYYY is the received format code.

D00A...In buffering the initial data in AT (auto) receive mode, the buffer B received a wrong format code in the eighth block.

YYYY is the received format code.

D010...In buffering the initial data in AT (auto) receive mode, the received self-diagnostic data is not \$55.

YYYY is the received diagnostic data.

D011...In buffering the initial data in AT (auto) receive mode, the buffer A received the bit data which is wrong at bit No. 0 and No. 1.

YYYY is the received data.

D012...In buffering the initial data in AT (auto) receive mode, the buffer A received the bit data which is wrong at bit No. 2 and No. 3.

YYYY is the received data.

D013...In buffering the initial data in AT (auto) receive mode, the buffer A received the bit data which is wrong at bit No. 4 and No. 5.

YYYY is the received data.

D080...Initial data buffered in AT (auto) receive mode includes wrong data at ID data No. 441C.

YYYY is the received data.

D081...Initial data buffered in AT (auto) receive mode includes wrong data at ID data No. 2428.

D090...Initial data buffered in AT (auto) receive mode includes wrong data at ID data No. 4405.

YYYY is the received data.

D091...Initial data buffered in AT (auto) receive mode includes wrong data at ID data No. 4404.

YYYY is the received data.

D092...Initial data buffered in AT (auto) receive mode includes wrong offset data for compensating positioning points.

YYYY is the received data.

[Probable Faulty Locations]

- Invertor unit (Check the LED of the invertor unit.)
- Improper ID number set in MCS

- Specification code setting error
- Erroneous connection with MCS

★ 0813 **MCS communication error**

When the power was supplied, an error occurred in communication with MCS.

If servo link information is displayed at the center of the screen, judge the cause by taking into consideration the message in the servo link information.

[Index] None

[Character-string]

[command name]-[channel No.]-network address (controller No.)

[Code] XXXXYYYY

XXXX:

1 -> The NC received the data that the NC had broadcasted.

YYYY: information of the received frame

2 -> Data is received from a station other than the slave station that broadcasted the data.

YYYY: information of the received frame

3 -> The received data size is 2 bytes or less.

YYYY: always 0

4 -> Data is received from a station other than the slave station that sent the date.

YYYY: information of the received frame

5 -> The NC received the data that the NC had transmitted in a way other than broadcasting.

YYYY: information of the received frame

6 -> Data is received from a the station of which network address is 0.

YYYY: information of the received frame

7 -> Data reception response is not sent within 1 or 0.1 second after data transmission.

YYYY: Always 0

'SI' command is specified before at least one MCS is normally activated in the link or before the power is supplied.

Open the box and check the LEDs of all the MCS units connected to the error-caused channel.

Normal units are indicated with '22'.

8 -> Data transmission does not end within 0.1 second.

YYYY: Always 0

9 -> Communication error occurred after reception of data.

YYYY: Error status

A -> Communication error occurred while the NC was waiting for data reception or immediately after data transmission.

YYYY: Error status

B -> Communication error occurred while the NC was waiting for data transmission.

YYYY: Error status

C -> Data transmission was attempted during data transmission.

YYYY: NC operation status

D -> Data transmission was attempted in the state of communication error.

YYYY: Error status

E -> An error command was received.

Two high-order digits of YYYY are a code (45: exception; 41: alarm; 57: warning; 54: error) while low-order digits are the number.

[Refer to the shake-hand communication error list (5-10) in external specification for MCS controller function.]

100 -> The received first 2 bytes are improper as a response to the transmitted data.

YYYY: Received first 2 bytes

101 -> The received data size is improper as a response to the transmitted data. High-order digits of YYYY is the received data size while the low-order half is a normal value.

102 -> Data No. 1 attached to the received data is improper.

YYYY: Two high-order bytes of the data judged to be improper

SI command : slave station connection No.

AS command : slave station connection No.

ID command : communication code + auxiliary code

103 -> Data No. 2 attached to the received data is improper.

YYYY: Two high-order bytes of the data judged to be improper

SI command : cumulative relay time

ID command : data ID

104 -> Data No. 3 attached to the received data is improper.

YYYY: two high-order bytes of the data judged to be improper

ID command : reserved

105 -> Data No. 4 attached to the received data is improper.

YYYY: Two high-order bytes of the data judged to be improper

ID command : ID data (4 bytes or less)

106 -> Data No. 5 attached to the received data is improper.

YYYY: Two high-order bytes of the data judged to be improper

SI command : The number of controllers

ID command : ID data (8 bytes)

200 -> Data sizes differ from those specified with ID numbers.

Faulty software

[Probable Faulty Locations]

- Invertor unit (Check the LED of the invertor unit.)
- FCP board
- MCS connection error
- MCS connection cable is faulty
- Faulty software

★ 0814 **MCS data file**

When the power was supplied, an error occurred in reading or transferring the servo link data file.

Or, the data file includes abnormal data.

[Index]

[Character-string]

[axis name] [device name] [file name] or none

[Code] XYZZAAAA

X: Axis kind; Y: Rough classification; ZZ: Minute classification; AAAA: Data

X: 1= NC-controlled axis

2= spindle

3= PLC-controlled axis

Y:0= Error in reading servo data file

ZZ:

01= Error occurred in retrieval of the file. AAAA=error code AAAA indicates that the data file does not exist at 000B: or the required axis data does not exist in the file.

02= File attribute is not contiguous.

03= File is not in OSP format.

04= File opening error. AAAA=error code

05= File data reading error. AAAA=error code

- 06= File does not start with "PBU1".
  - 07= File name is not followed by "M1".
  - 08= The relevant axis data has exceeded the maximum number of data sets stored in the file before the specified number of data sets are transferred.
  - 09= File closing error. AAAA=error code
  - 0A= A set of data size is larger than 8 sectors. AAAA=number of data sectors
  - 0B= Data reading error. AAAA=error code
  - 0C= The data file does not contain the previously specified number of data sets.
  - 0D= The data serial number does not match.
  - 0E= The data type does not match.
  - 0F= The whole number of data sets does not match.
  - 10= File closing error. AAAA=error code
  - 11= Servo data does not exist in the file where NC axis data exists.
- Y: 1= Error in checking servo data file
- ZZ:
- 01= The NC axis data file of NC axis control for heavy workpiece specification is not found.
  - 02= Axis specification (rotary or limited) or unit system does not match. AAAA=axis specification data
  - 03= Acceleration/deceleration method does not match.
  - 04= Inductosyn is not provided.
  - 05= The number of data sets is abnormal (the number of spindle data sets is not within 1 to 32). AAAA=the number of data sets
  - 06= The speed-time constant characteristic data includes faulty data with reversed inequality.  
AAAA=Two high-order digits show the axis number while low-order digits are the error content.
- High-order AA:
- 00 -> X-axis
  - 01 -> Y-axis
  - 02 -> Z-axis
  - 03 -> 4th axis
  - 04 -> 5th axis
- Low-order AA:
- 11 -> FT1max=0
  - 12 -> FT1max<FT1min
  - 13 -> FT1max=FT1min and T1max<T1min
  - 14 -> FT1max>FT1min and T1max<T1min
  - 21 -> FT2max=0 (FT2max is determined by internal calculation.)
  - 22 -> FT2max<FT2min
  - 23 -> FT2max=FT2min and T2max<T2min
  - 24 -> FT2max>FT2min and T2max<T2min
  - =31 -> FT1pmax=0
  - =32 -> FT1pmax<FT1pmin
  - =33 -> FT1pmax=FT1pmin and T1pmax<T1pmin
  - =34 -> FT1pmax>FT1pmin and T1pmax<T1pmin
  - =41 -> FT2pmax=0(FT2pmax is determined by internal calculation.)
  - =42 -> FT2pmax<FT2pmin
  - =43 -> FT2pmax=FT2pmin and T2pmax<T2pmin
  - =44 -> FT2pmax>FT2pmin and T2pmax<T2pmin (50 to 5E are the alarms related with turning cut parameters.)
  - =50 -> In the parameters used only for turning cut, the set numbers of the basic three axes do not match.
  - =51 -> In the parameters used only for turning cut, the T1min values of the basic three axes do not match.
  - =52 -> In the parameters used only for turning cut, the T1max values of the basic three axes do not match.

=53 -> In the parameters used only for turning cut, the T1pmax values of the basic three axes do not match.  
=54 -> In the parameters used only for turning cut, the FT1min values of the basic three axes do not match.  
=55 -> In the parameters used only for turning cut, the FT1max values of the basic three axes do not match.  
=56 -> In the parameters used only for turning cut, the FTpmax values of the basic three axes.  
=57 -> FT1max=0  
=58 -> FT1max<FT1min  
=59 -> FT1max>FT1min and T1max<T1min  
=5A -> FT1max=FT1min and T1max<T1min  
=5B -> FT1pmax=0  
=5C -> FT1pmax<FT1pmin  
=5D -> FT1pmax>FT1pmin and T1pmax<T1pmin  
=5E -> FT1pmax=FT1pmin and T1pmax<T1pmin  
07= The servo data to be used with the NC axis data for heavy workpiece specification is not found.  
AAAA is the weight set as the NC axis data.

[Probable Faulty Locations]

- Axis data file

#### ★ 0815 PLC Real time task loop error

The real time task indicated by the character-string failed to end within the preset processing time.

[Index] None

[Character-string] AAAABB

AAAA -> Task name being processed when the loop error was detected.

BB -> Program module number being executed (hexadecimal)

[code]

XXXXXXXX-> Program counter value (hexadecimal) at the time of error detection

[Probable Faulty Locations]

- Level 2 or level 3 task in the PLC sequence program failed to end processing within the preset time.
- Timing error of synchronous signal
- Wrongly set synchronous signal frequency

#### ★ 0816 PLC initial error

An error was detected in the checking process for activating the PLC.

[Index] None

[Character-string] None

[Code] XX

=1 -> NC-PLC synchronous parameter is not found.

[Measures to Take] Consult the machine maker.

#### ★ 0817 MCS Error

An error occurred under the control by MCS.

[Index] Axis name or none

[Character-string] None

[Code] XXZZAAAA

XYZZ: 0

AAAA:

1= Processing does not end within 5 seconds after MCS reset 1.

2= Processing does not end within 5 seconds after MCS reset 2.

3 = Processing does not end within 5 seconds after PLC reset processing 1.



4 = Processing does not end within 5 seconds after PLC reset processing 2.

X: 1 to 3

X: Channel number

YZZAAAA: Communication error status

ZZ: Slave station where the error has occurred.

bit 7: Error occurred during data transmission/reception at slave station No. 8.

bit 6: Error occurred during data transmission/reception at slave station No. 7.

bit 0: Error occurred during data transmission/reception at slave station No. 0.

AAAA: Cause of the error

bit 15: Error occurred (always 1)

bit 14 -12: Always 0

11 -> Access error in MT mode

10 -> Transmission loop error in AT mode

9: Excessive number of data pieces at reception IF

8: Disconnection error

7: Always 0

6: Modulation code error

5: Reception CRC error

4: Format error

3: Double transmission error

2: Double reception error

1: Memory parity error

0: Time-out error

[Probable Faulty Locations]

- MCS controller is defective.
- Defect of FCP board servo link
- Defective software

**★ 0818 ADP START**

An alarm occurred while the AD conversion processor board was initialized after power ON.

[Index] None

[Character-string] None

[Code] X

X=1: Synchronous counter value remains 1.

X=2: A system alarm occurred when the synchronous counter value was 1.

X=3: Synchronous counter value remains 3.

X=4: A system alarm occurred when the synchronous counter value was 3.

[Probable Faulty Locations] 1 ADP(AD conversion processor board)

[Measures to Take] Replace the ADP(AD conversion processor board).

[Related Specifications] Thermal deviation compensation

**★ 0829 SPMC Program load**

Error occurred when loading program of SUPER MAIN CARD(SPMC).

[Code] XYZAAAA

X : Module number of load program

YY : Subroutine number in module

Z : Error number in subroutine

AAAA : A numerical value is entered as the case may be.

[Probable Faulty Locations]

- 1) Defective installation or software production error
- 2) Faulty software
- 3) Faulty SPMC
- 4) Faulty SUPER MAIN BOARD(SPMB)

**★ 0830 SPMC Execution stop**

A replying value to the execution beginning request, the reset request, or the data transfer request from SUPER MAIN CARD (SPMC) was not prescribed one.

[Code] XXYY

XX=10:No reply was sent within 20 seconds after sending the execution beginning request to SPMC.

XX=18:No reply was sent within 20 seconds after sending the reset request to SPMC.

XX=20:The replying value from SPMC to the data transfer request was not prescribed one.

YY : In case of 32 to 61, the possibility that the exception occurs in SPMC is high and (\$YY-\$32) shows an exception kind.

In the case except it, the possibility of faulty software is high.

[Probable Faulty Locations]

- 1) Faulty SPMC
- 2) Faulty SUPER MAIN BOARD(SPMB)
- 3) Faulty software

**★ 0831 SPM Exception processing**

Fatal abnormality has occurred in processing by hardware or software of SUPER MAIN CARD(SPMC).

[Code]

200 -> Machine Check Exception

300 -> Data Access Exception

400 ->Instruction Access Exception

600 -> Alignment Exception

700 -> Program Exception

800 -> Floating-Point Unavailable Exception

D00 ->Trace Exception

1000 -> Instruction Translation Miss Exception

1100 -> Data Load Translation Miss Exception

1200 -> Data Store Translation Miss Exception

1300 -> Instruction Address Breakpoint Exception

1400 -> System Management Interrupt

[Probable Faulty Locations]

- 1) Faulty SPMC
- 2) Faulty SUPER MAIN BOARD(SPMB)
- 3) Faulty software

**★ 0832 SPM System Call error**

In the system call processing with the SUPER MAIN CARD(SPMC), error was detected.

[Code] 2XXXXXXX

XXXXXXX: Error code which was returned from system call.

[Probable Faulty Locations] Faulty software

**★ 0833 MCS Option-program-file not send**

The optional program file for MCS has not been transferred to the MCS.

[Index] Axis name or none

[Character-string] None

[Code] None

[Probable Faulty Locations]

- MCS optional program file has not been transferred.
- MCS optional program file is not found.
- MCS optional program file does not contain the program that matches the MCS software version.

[Measures to Take]

- Install the MCS optional program file.
- Change the MCS optional program file.

**★ 0834 MCS Servo-data error**

Erroneous servo data has been transferred to MCS.

[Index] Axis name or none

[Character-string] None

[Code]XXXXYYZZ

XXXX =ID number

YY = Parameter number

ZZ = Error content

01: Out of setting range

02: Set timing error

03: No data transfer

04: Calculation error

05: Others

[Probable Faulty Locations]

- The servo data file does not match the MCS software version.
- NC software

[Measures to Take]

- Change the servo data file.

**★ 0835 MCS Communication**

An error occurred during shake-hand communication with MCS.

[Index] Axis name or none

[Character-string] Shake-hand communication error number (2 digits), error data (8 digits), and [command name]-[channel number]-net address (controller number)

[Code] None

[Probable Faulty Locations]

- Faulty application software
- Faulty MCS software

[Measures to Take]

- Change the application software.
- Change the MCS software.

**★ 0839 Specification Condition Failure**

Specification code, software system,or the hardware configuration is faulty.

[Index] None

[Character-string] None

[Code] X

=1 -> Operation processor required for Hi-cut specification is not provided on the compact main board.

[Probable Faulty Locations]

=1 NC specification configuration defect or hardware configuration assign defect

[Measures to Take]

=1 Remove the Hi cut specification code, or use the compact main board (UCMB+F) with the operation processor.

**★ 0840 Super-Hi-NC specification unmatching**

The actual NC specifications do not match the requirements for Super Hi-NC function or NURBS command function.

[Index] None

[Character-string] None

[Code]

1 -> The 2nd main board is not a high-speed main board. Or, the 3rd main board is not a super main board.

[Probable Faulty Locations] High-speed main board or super main board

[Measures to Take]

Change the 2nd main board to a high-speed main board, and the 3rd main board to a super main board.

[Relating Specification] Super Hi-NC Function, NURBS Command function

**★ 0841 FCP4 illegal**

FCP4 board became abnormal.

[Index] None

[Character-string] AAAABB

AAAA: Task name being executed

BB Program module number being executed (hexadecimal number)

[Code] WWXXYYZZ

If WW is omitted, XXYYZZ is the same with the code displayed with the alarm 809 "FCP illegal".

If WW is 0, refer to [Measures to Take].

WW=10 The OS is abnormal.

XX: Task

XX=00 PLT0 task

XX=01 PLT1 task

XX=09 PLSY task

XX=10 PLR2 task

XX=20 PLR3 task

YYZZ: Contents of failure

YYZZ=0001 Forced termination of the task failed.

YYZZ=0002 Task start failure

YYZZ=0003 Failure in waiting for task start

YYZZ=0004 Failure in waiting for task start by 1.6ms delay

WW=20 The built-in memory is abnormal.

XXYYZZ: Top address of the checked area

[Measures to Take]

If the code is 0, there is a following possibility only when the FCP board is changed to the FCP4 board.

When the data trace is set to "Effective" with the power ON in the settings for data trace function, and the NC read the settings of backup data where the trace data has been set.

In this case, 1 byte of sector 6@81 is set to 0 in the PLC variable data file (PLCUA\*.PUB) in MD0.

★ 0842 **Safety-monitor Spec Error**

In the safety speed monitor function, an abnormality was found in the specification conditions.

[Index] None

[Character-string] None

[Code] WXXYYZZ

W=1 The connected position of the safety speed monitor for the displayed axis is different from the position registered in software.

The guard number of each axis in the safety speed monitor data file for the axis control is different from the monitor position to which the axis is connected.

W=2 The guard number of the displayed axis is other than 1 to 9.

XX: shows the controller ID of the axis where the abnormal was found (hexadecimal number).

YY: Guard numbers in the safety speed monitor data file for axis control of axis for which the abnormal was found (hexadecimal number).

ZZ: The number of the safety speed monitor checked when the alarm is generated

W=3 The (second) safety speed monitor does not exist in the specifications for the machine with attachment spindle.

[Measures to Take]

W=1 Check if the safety speed monitor is connected to the correct position.

W=2 Change in safety speed monitor data file for axis control.

W=3 Or, add the safety speed monitor.

★ 0850 **MCS Undefined alarm number**

The MCS caused an error related with axis control.

[Index] Axis name or none (spindle)

[Character-string] Alarm number in decimal

[Code] Alarm code

[Probable Faulty Locations]

- Depends on the number indicated in the character-string.  
Inform us of the code and the character string.

★ 0851 **MCS Exception processing**

A fatal alarm occurred while the MCS inverter unit and MCS software are executing their processing.

[Index] Axis name or none (spindle)

[Character-string] Cause of alarm detected

"#1" -> Control board error

"#2" -> Voltage drop of +-12 V battery for control board

"#3"-> OPF error

"#11" -> Voltage drop of 5 V battery for control board

"#12" -> Inverter bridge shorted

"#13" -> IPM protective function activated

"#14" -> Motor overcurrent

"#20" -> INT loop error

"#21" -> INT5 loop error

"#22" -> INT4 loop error

"#23" -> INT3 loop error

"#24" -> INT2 loop error

"#25" -> INT1 loop error

"#26" -> Access denied

"#27" -> Ram check error in initialization  
"#28" -> Party error  
"#29" -> Watchdog error  
"#30" -> IRQ7 interruption  
"#31" -> NMI interruption  
"#32" -> General illegal command  
"#33" -> Slot illegal command  
"#34" -> CPU address error  
"#35" -> DMA address error  
"#36" -> Undefined trap error  
"#37" -> Undefined interruption  
"#38" -> DMAC  
"#39" -> ITU  
"#40" -> SCI  
"#41" -> REF  
"#42" -> A/D  
"#43" -> System reserved  
"#44" -> User break

[Code]

In the case of #1, the code shows the error content of the control board.

In the case of #3, the code shows the error content of the optional program file.

- 1: Identification code "OPF1" error
- 2: End code "ED" error
- 3: Sum check error
- 4: Board name error

In the case of #11-14, #20-21, #25-26 and #30-31, the code shows the data in the error status register.

[Probable Faulty Locations]

In the case of #1,

- Inverter unit

In the case of #3,

- Optional program file
- Optional program file incompatible with inverter unit

In the case of #2 or #11,

- Power unit (when this alarm occurred in several inverter units)

In the case of #12, #13, or #14,

- Inverter unit

In other cases,

- Inverter unit

★ 0852 MCS Processing trouble

MCS

[Index] Axis name or none (spindle)

[Character-string] None

[Code] XXZZAAAA

XX:

- 04 -> The self-diagnostic data has an error. (ZZ: Received data)
- 06 -> Software sync bit or format code of buffer A is wrong.
- 07 -> Software sync bit or format code of buffer B is wrong.

08 -> An error occurred in data communication.

ZZ shows the data kind. AAAA is always 0.

ZZ:

- 1 -> Speed command (8408)
- 2 -> Laser linear scale value (4413)
- 3 -> Backlash (4406)
- 4 -> Actual position without positioning error compensation (440A)
- 5 -> Positioning error compensation amount
- 6 -> Full-closed loop encoder value (4410)
- 7 -> Semi-closed loop encoder value (4411)
- 8 -> ODIFF(4415)
- 10 -> APA in divided stroke (4404)
- 11 -> Acceleration/deceleration time for positioning (4422)
- 12 -> Zero offset amount
- 13 -> In-position width (4420)
- 14 -> Maximum of divided stroke (4405)
- 15 -> Point data change
- =16: ODIF amount (4415)
- =17: Checking point table number (140D)
- =18: Changing point table number (1409)

[Probable Faulty Locations]

- Faulty MCS controller
- Faulty software

**★ 0853 MCS CON APA deviation**

Difference between CON and APA values has exceeded the allowable limit. The CON-APA deviation is the absolute value of difference between [calculated value written in MCS] and [actual position read from MCS]. The NC control software monitors this deviation. The MCS normally monitors DIFF value.

This alarm appears if the MCS causes a fatal error and cannot monitor the DIFF value.

[Index] Axis name

[Character-string] None

[Code] Absolute value of deviation in hexadecimal (reference unit)

[Probable Faulty Locations]

- Faulty MCS controller
- Mismatch between MCS data and NC data

**★ 0854 MCS Power-Supply-Unit Error**

The power unit caused an error.

[Index] Axis name or none (spindle)

[Character-string] None

[Code] AAAAAAXX

AAAAAA is always 0.

X Alarm number

0: DC voltage alarm

1: Abnormal input voltage

2: Abnormal control power

3: Abnormal control status

4: Overload in regenerative circuit

5: Heat sink overheat  
6: CPU error  
7: Spare  
Y: Power unit status  
bit3 1: An alarm occurred in the power unit. (Warning signal status: 0)  
bit2 1: DC power is being supplied  
bit1 1: OPRON input is closed bit0 1:PWON input is closed.  
ZZ: Data  
X(alarm No.): 0 ... Detected DC voltage in hexadecimal [3.9V]  
X(alarm No.): 1 ... Detected AC voltage in hexadecimal [3.1V]  
X(alarm No.): 2  
1:+5V abnormal voltage  
2:+12V abnormal voltage  
3:-12V abnormal voltage  
X(alarm No.): 3  
1: Converter over current  
2: Abnormal power element  
3: Converter short circuit  
4: Abnormal regenerative circuit(type in power regenerative circuit)  
5: Abnormal regenerative circuit(type in resistor discharge)  
X(alarm No.): 4 Uncertain  
X(alarm No.): 5 Uncertain  
X(alarm No.): 6 Uncertain

[Probable Faulty Locations]

In the case of abnormal control power,

- Power unit

In the case of low voltage,

- Input voltage drop, power failure, blown fuse in input power circuit, or instantaneous power interruption

In the case of high voltage

- Power unit

★ 0855 MCS Converter-link error

The convertor link (used for communication between power unit and inverter unit) caused an error, disabling the NC from monitoring the power unit condition.

[Index] Axis name or none (spindle)

[Character-string] None

[Code] XAAAAAY

AAAAA is always 0.

X=0:communication error

X=1:Time-out error (communication interrupted)

YY=communication status

When X is ONE(1),always 0

[Probable Faulty Locations]

- Converter link cables or connectors
- Power unit
- Inverter unit control board



★ 0856 **MCS DC-bus voltage alarm**

The DC-bus voltage in the inverter unit has abnormally risen or fallen, disabling the inverter from supplying the current.

[Index] Axis name or none (spindle)

[Character-string] None

[Code] XXXXYYYY

XXXX=Detected overvoltage in hexadecimal [15.3 mV]

YYYY=Detected undervoltage in hexadecimal [15.3 mV]

[Probable Faulty Locations]

In the case of voltage rise,

- Power unit

In the case of voltage drop,

- Power unit
- Inverter unit
- Instantaneous power interruption

★ 0857 **MCS Motor over current**

The inverter unit has detected excessive current flowing in the motor cable.

[Index] Axis name or none (spindle)

[Character-string] None

[Code] XXXXYYYY

XXXX=U-phase current detected when this alarm occurs, expressed in signed hexadecimal [Tolerance: 3FFF]

YYYY=V-phase current detected when this alarm occurs, expressed in signed hexadecimal [Tolerance: 3FFF]

[Probable Faulty Locations]

- Inverter unit
- Faulty motor insulation

★ 0858 **MCS Power unit over heat**

The inverter unit has detected excessive current flowing in the motor cable.

The inverter unit temperature has risen abnormally.

[Index] Axis name or none (spindle)

[Character-string] None

[Code] 1 (fixed)

[Probable Faulty Locations]

- Inverter unit
- Overload operation

★ 0859 **MCS Power unit over load**

The inverter load has exceeded the specified value, activating the overload protection function.

[Index] Axis name or none (spindle)

[Character-string] None

[Code] YYYYZZZZ

YYYY ->Gamma of the protection curve used to detect overload

ZZZZ ->Internally calculated overload data

[Probable Faulty Locations]

- Inverter unit
- Overload operation

★ 0860 **MCS Supply voltage flutter**

The power unit input voltage is abnormally high or low.

[Index] Axis name or none (spindle)

[Character-string] None

[Code] Detected abnormal voltage in hexadecimal [Volt]

[Probable Faulty Locations]

- Power unit
- Power cables or connectors
- Instantaneous power interruption

★ 0861 **MCS Power unit version error**

The inverter unit allowable current is smaller than the current limit specified in the servo data file.

[Index] Axis name or none (spindle)

[Character-string] None

[Code] 1 (fixed)

[Probable Faulty Locations]

- Inverter unit
- Servo data file

★ 0862 **MCS Winding-change failed**

The winding-change magnet switch does not come on.

[Index] Axis name or none (spindle)

[Character-string] None

[Code] YYYYZZZZ

If YYYY = 0000

ZZZZ = 0001: Magnet conductor for low-speed winding is ON.

ZZZZ = 0002: Magnet conductor for high-speed winding is ON.

ZZZZ = 0003: Magnet conductors for both windings are ON.

ZZZZ = 0004: Winding change time-out

If YYYY = 1010

ZZZZ = 0001: Faulty servo data file

[Probable Faulty Locations]

- Winding-change magnet switch

★ 0863 **MCS Encoder-link error**

An error occurred in the encoder communication link, disabling the encoder from detecting positioning speed.

[Index] Axis name or none (spindle)

[Character-string] None

[Code] XYYZZZZ

XX = FF (fixed)

YY = 00: Error is detected at the motor encoder.

01: Error is detected at the position encoder with shaft.

02: Error is detected at the independent position encoder.

03: Error is detected at ABSO SCALE.

ZZZZ=Encoder link error status at the time of error detection.

Each bit represents the kind of communication error.

- bit 15 1: Error in communication with a stand-alone encoder
- bit 14 1: Error in communication with ABSO SCALE 2
- bit 13 1: Error in communication with ABSO SCALE or encoder with shaft
- bit 12 1: Error in communication with motor encoder
- bit 11 1: Undefined
- bit 10 1: Transmission loop error in AT (auto) mode
- bit 9 1: Data over error in data receiving part of interface
- bit 8 1: Undefined
- bit 7 1: Undefined
- bit 6 1: Modulation code error
- bit 5 1: CRC error
- bit 4 1: Format error
- bit 3 1: Double transmission error
- bit 2 1: Double reception error
- bit 1 1: Parity error
- bit 0 1: Time-out error

[Probable Faulty Locations]

- Motor encoder, ABSO SCALE, encoder with shaft, or stand-alone encoder of the problem axis
- Encoder link cables or connectors
- Invertor unit control board

**★ 0864 MCS Encoder error**

The motor encoder has become unable to detect positional data.

[Index] Axis name or none (spindle)

[Character-string] None

[Code] XXYYZZZZ

XX= Encoder error code depending on the encoder type

YY= Detailed encoder status. The status varies with the encoder type.

ZZZZ=Multi-turn position data. This data appears when the multi-turn position data has exceeded the rotating range.

XX = 0 (fixed)

YY = 1 (fixed)

ZZZZ =Multi-turn position data

[Probable Faulty Locations]

- Motor encoder

**★ 0865 MCS Encoder initialize failed**

An error occurred in initialization of the motor encoder.

[Index] Axis name or none (spindle)

[Character-string] None

[Code] XXYYZZZZ

XX= Encoder link sequence number at the time of error detection

0: Reset

1: Network address setting

2: Request of basic information on communication

3: Change of communication version

4: Acquisition of device information

5: Parameter change

6: AT (auto) mode start

YY= Error content

0: Communication error

1: Transmission start time over

2: Transmission finish time over

3: Reception finish time over

4: Abnormal response address

5: Abnormal response code

6: Parameter error

ZZZZ= Additional data

If YY=0, the encoder link error status C2ERR at the time of error detection appears.

If YY=1, 2, or 3, the transferred frame information QC2MTINF appears.

If YY=4, the network address of the responding device appears.

If YY=5, the received frame information QC2RXINF appears.

If YY=6, the number of parameter that caused the alarm appears.

1= Not all the necessary parameters are received.

2= Basic information on communication is incompatible.

3= Multi-rotation detection range does not match.

[Probable Faulty Locations]

- Motor encoder
- Encoder link cables or connectors
- Invertor unit control board

**★ 0866 MCS Encoder with shaft error**

The encoder with shaft has become unable to detect positional data.

[Index] Axis name or none (spindle)

[Character-string] None

[Code] Same with <MCS Encoder error>

[Probable Faulty Locations]

- Encoder with shaft

**★ 0867 MCS Encoder with shaft initial**

An error occurred in initialization of the encoder with shaft.

[Index] Axis name or none (spindle)

[Character-string] None

[Code] Same with <MCS Encoder initialize failed>

[Probable Faulty Locations]

- Encoder with shaft
- Encoder link cables or connectors
- Invertor unit control board

**★ 0868 MCS ABSO SCALE error**

An error occurred in initialization of ABSO SCALE.

[Index] Axis name or none (spindle)

[Character-string] None

[Code] None

[Probable Faulty Locations]

- ABSO SCALE

★ 0869 **MCS ABSO SCALE initialize**

An error occurred in initialization of ABSO SCALE.

[Index] Axis name or none (spindle)

[Character-string] None

[Code] Same with <MCS Encoder initialize failed>

[Probable Faulty Locations]

- ABSO SCALE
- Encoder link cables or connectors
- Invertor unit control board

★ 0870 **MCS Magnetic encoder alarm**

The magnetic pulse generator has become unable to detect the motor speed. Or, the number of magnetic encoder gear teeth does not match the data in the MCS data file.

[Index] Axis name or none (spindle)

[Character-string] None

[Code] XXXXYYYY

XXXX= Error content

A -> A-phase voltage is abnormal.

B -> B-phase voltage is abnormal.

C -> Magnetic encoder data error

Others -> Servo data file set value detected when the count over error occurred in the magnetic encoder (No. of PG gear teeth \* 4 - 1)

YYYY= Additional error data (Varies with XXXX.)

If XXXX is A, A-phase voltage appears.

If XXXX is B, B-phase voltage appears.

If XXXX is C, 0 (fixed) appears.

Others -> Detected count value of magnetic encoder (No. of PG gear teeth \* 4 - 1)

[Probable Faulty Locations]

- Magnetic encoder or its wiring, or large gap between magnetic encoder and gear
- Mismatch between the number of gear teeth of magnetic encoder and the servo data file data

★ 0871 **MCS Resolver alarm**

The resolver does not send any signal.

[Index] Axis name or none (spindle)

[Character-string] None

[Code] 1 (fixed)

[Probable Faulty Locations]

- Resolver trouble, or disconnection or contact failure of the resolver cable

★ 0872 **MCS Pulse generator count over**

The PG (pulse generator) count value per one turn differs from the corresponding data specified in servo data file.

[Index] Axis name or none (spindle)

[Character-string] None

[Code] XXXXYYYY

XXXX= PBU set value (Count number for one PG turn)

YYYY= Actual count number

[Probable Faulty Locations]

- Faulty PG
- Mismatch between the number of PG gear teeth and the servo data file data

**★ 0873 MCS Motor over heat**

The motor temperature is abnormally high.

[Index] Axis name or none (spindle)

[Character-string] None

[Code] YYYYZZZZ

YYYY =0 (fixed)

ZZZZ = 0010: Motor overheat

ZZZZ = 0011: Motor overheat is detected at the motor.

ZZZZ = 0012: Motor overheat is detected at the position encoder.

ZZZZ = 0013: Motor overhead is detected at the motor and the encoder.

[Probable Faulty Locations]

- Malfunction of VAC motor fan, dirty heat sink, CW/CCW turns and stops at high frequency
- BL motor
- Motor encoder (BL motor detects overheat by its encoder.)

**★ 0874 MCS Servo-link error**

A communication error occurred in the servo link, disabling the servo unit from receiving commands from the NC.

[Index] Axis name or none (spindle)

[Character-string] None

[Code] XXXXYYYY

XXXX=0 (fixed)

YYYY= Bit number indicating the kind of communication error (Servo link error status at the time of error detection)

bit 15 1: 2nd B-buffer error

bit 14 1: 2nd A-buffer error

bit 13 1: 1st B-buffer error

bit 12 1: 1st A-buffer error

bit 11 1: MT buffer error

bit 10 1: Relay processing error

bit 9 1: Data over error in data receiving part of interface

bit 8 1: Disconnection

bit 7 1: Address pointer error

bit 6 1: Modulation code error

bit 5 1: CRC error

bit 4 1: Format error

bit 3 1: Double transmission error

bit 2 1: Double reception error

bit 1 1: Parity error

bit 0 1: Time-out error

[Probable Faulty Locations]

- Invertor unit control board
- Servo link cables or connectors

- FCP board

★ 0875 **MCS Servo-link disconnect**

The servo link is disconnected, disabling the servo unit from receiving commands from the NC.

[Index] Axis name or none (spindle)

[Character-string] None

[Code] XXXXYYYY

XXXX=Disconnected position

0 -> Disconnected right in front of the problem unit

8000 -> Disconnected before the problem unit

YYYY=Servo link error status at the time of error detection

[Probable Faulty Locations]

- Servo cables or connectors
- Inverter unit control board
- FCP board

★ 0876 **MCS Servo-link protocol error**

The NC and the inverter unit exchange commands and responses at constant intervals according to the specified protocol through the servo link. In this communication, a wrong protocol or abnormal timing was used to transfer the data from NC to the inverter unit.

[Index] Axis name or none (spindle)

[Character-string] None

[Code] Number indicating the error content

1: A-buffer Software synchronization error

2: A-buffer Format code error

3: B-buffer Software synchronization error

4: B-buffer Format code error

5: B-buffer Block number error

[Probable Faulty Locations]

- Inverter unit control board
- NC software
- Inverter unit control board not compatible with NC software
- FCP board

★ 0877 **MCS Servo data error**

The servo data sent from the NC for initialization or operation is not applicable to the inverter unit.

If this alarm occurs after change of inverter unit, the servo data file is not applicable to the inverter unit.

If this alarm occurs after adjustment or change of the servo data, the servo data is wrongly changed.

[Index] Axis name or none (spindle)

[Character-string] None

[Code] XXXXYYYY

XXXX=Data ID number of the data that caused the error

YY= Data set number of the data that caused the error

ZZ= Error content

1: Out of setting range

2: Wrongly set timing

3: No transmission

4: Calculation error

5: Others

[Probable Faulty Locations]

- Servo data file not compatible with inverter unit
- Inverter unit not compatible with NC software
- Inverter unit control board
- NC software

**★ 0878 MCS Illegal command**

The NC and the inverter unit exchange commands and responses through the servo link. In this communication, the NC sent an abnormal or inexecutable command to the inverter unit.

[Index] Axis name or none (spindle)

[Character-string] None

[Code] XXXXYYYY

XXXX=

- 10: Positioning mode Command point number over
- 11: Positioning mode Negative command value
- 12: Positioning mode Larger command value (specified position > 360 deg for rotary axis)
- 13: Positioning mode RPositioning point table not transmitted
- 14: Positioning mode Non-rotating axis
- 15: Positioning mode Command format other than points
- 16: Positioning mode Positioning sub-mode error
- 21: Parameter change Parameter number out of specifiable range
- 22: Mode Undefined mode
- 23: Mode Positioning/tool path mode condition
- 24: Coordinate system Coordinate system designation error
- 30: Unused bit is ON in the bit commands for controlling the S-link A buffer.
- 31: Unused bit is ON among the bit data in the S-link B buffer.
- 40: AT mode is selected without reception of time synchronization command.

YYYY= Error data

X in the range from 10 to 16 shows the positioning sub-mode.

0:Program mode 1:Search mode 2:PH mode 3:Teach mode

[Probable Faulty Locations]

- Inverter unit not compatible with NC software
- Inverter unit control board
- NC software

**★ 0879 MCS CON speed over**

Increments for positioning command (SRCOND) issued from the NC to the inverter unit exceed the allowable limit.

If this alarm occurs in the axis to be positioned, the servo data file has wrong data. (This is because the inverter unit calculates the increments for the axis to be positioned.)

[Index] Axis name or none (spindle)

[Character-string] None

[Code]

Absolute value of increments processed for acceleration/deceleration  $[(pr/65536)/Tp]$

Where, pr= One turn of position encoder; Tp= Position control frequency

The following codes, however, have specific meanings:

- 1: The increments were so large that they were judged erroneous in preliminary check.



2: The position command (SRCON) exceeds the absolute value of the encoder measuring range (linear axis only).

[Probable Faulty Locations]

- Servo data file
- NC software

**★ 0880 MCS Speed command over**

Speed command value issued from the NC to the inverter unit exceeds the allowable limit.

[Index] Axis name or none (spindle)

[Character-string] None

[Code] Speed command [(rev/4294967269)/Tv]

rev= One motor turn; Tv= Speed control frequency

]Probable Faulty Locations]

- Servo data file
- NC software

**★ 0881 MCS DIFF over**

Axis movement caused a large positioning error.

While the axis is in a target position or stopped, the target value and the calculated value are the same. With an axis movement command, the NC starts creating calculation values (RCON) until the target point is reached. At this time, the actual position follows the calculated value with a certain delay. This delay is called "following error" and calculated by ([calculation value] - [actual value]). If the "following error" exceeds the allowable limit, the above alarm occurs.

[Index] Axis name or none (spindle)

[Character-string] None

[Code] Absolute value of following error [pr/65536]

pr = One turn of position encoder

]Probable Faulty Locations]

- Overload due to faulty ball screw or bearing
- Motor
- Inverter unit
- Servo data file

**★ 0882 MCS APA speed over**

The position encoder value (RAPA) changes as the motor rotates.

The NC checks this change with preset frequency.

This alarm occurs if the change per unit time exceeds the allowable range consecutively. For example, an axis feedrate is abnormally high compared with the normal rapid feedrate, or the encoder value changes irregularly due to malfunction of the position encoder.

[Index] Axis name or none (spindle)

[Character-string] None

[Code]

Absolute value of the change in encoder value per position control frequency [encoder's 1/65536 turn/position control frequency]

The following codes, however, have specific meanings:

- 1= Linear axis has exceeded its travel range.
- 2= Rotary axis has exceeded its travel range (360 deg) or limited axis has negative positional data.
- 3= Limited axis has exceeded its travel range.

]Probable Faulty Locations]

- Motor encoder (BL motor)
- Encoder link cables or connectors (BL motor)
- PG or magnetic encoder (VAC motor)
- PG or magnetic encoder cables or connectors (VAC motor)
- Invertor unit control board

**★ 0883 MCS Full-closed APA error**

Difference between the full-closed loop encoder value and the motor encoder value exceeds the allowable range.

[Index] Axis name or none (spindle)

[Character-string] None

[Code] Number of times the error has been detected

[Probable Faulty Locations]

- Synthetic offset data is not set at the full-closed loop encoder or wrong data is set.
- ABSO SCALE or position encoder with shaft
- Excessive lost motion in axis drive system (The motor is not rigidly connected with the movable part.)
- Slippage or breakage of shaft belt
- Loose coupling between motor and ball screw
- Improper positional loop gain (too high)

**★ 0884 MCS Over speed**

Actual motor speed is too high.

[Index] Axis name or none (spindle)

[Character-string] None

[Code] Motor speed detected when this alarm occurred [(rev/4294967296)/Tv]

Where, rev= One motor turn; Tv= Speed control frequency

[Probable Faulty Locations]

- Motor encoder (BL motor)
- Encoder link cables or connectors (VAC motor)
- Resolver or magnetic encoder (VAC motor)
- Resolver or magnetic encoder cables or connectors (VAC motor)
- Invertor unit control board

**★ 0885 MCS Velocity deviation over**

Actual motor speed excessively deviates from the speed command.

[Index] Axis name or none (spindle)

[Character-string] None

[Code]XXXXYYYY

XXXX: Detected torque (sum of the torque data collected for 3.2 ms)

+2<sup>-12</sup>[MAXTRQ]

If Tv = 0.4 ms, the momentary maximum torque is H'7FFF.

If Tv = 0.8 ms, the momentary maximum torque is H'3FFF.

YYYY: Detected acceleration (average value measured for 3.2 ms)

+2<sup>-16</sup>[vr/3.2 ms/3.2 ms]

= about 0.1 [rpm/ms]

The code number 00000001 means that the error data is replaced by zero because of exponent underflow.

[Probable Faulty Locations]

- The motor does not turn because of (mechanical lock or) application of large load.

★ 0886 **MCS Collision detected**

The NC torque limiter has detected collision of axis by monitoring the relation between motor output torque and motor acceleration.

[Index] Axis name or none (spindle)

[Character-string] None

[Code] XXXXYYYY

XXXX: Detected torque (sum of torque data collected for 3.2 ms)

+2<sup>-12</sup>[MAXTRQ]

If Tv = 0.4ms, the momentary maximum torque is H'7FFF.

If Tv = 0.8 ms, the momentary maximum torque is H'3FFF.

YYYY: Detected acceleration (average torque measured for 3.2 ms)

+2<sup>-16</sup>[vr/3.2 ms/3.2 ms]

= about 0.1 [rpm/ms]

[Probable Faulty Locations]

- Collision
- Motor encoder
- NC torque limiter set value

★ 0887 **MCS Urgent-stop time over**

The axis cannot stop within a preset time after reception of emergency stop command.

[Index] Axis name or none (spindle)

[Character-string] None

[Code] XXXXXXXX

1: Emergency stop time over

2: Deceleration time over at emergency stop

3: Deceleration time over at alarm stop

[Probable Faulty Locations]

- Invertor unit control board
- NC software

★ 0888 **MCS Belt is broken**

Breakage of belt was detected in the belt-driven axis.

[Index] Axis name or none (spindle)

[Character-string] None

[Code] Load torque (hexadecimal) at the time of alarm detection

[Probable Faulty Locations]

- Broken belt

★ 0889 **MCS Axis change control error**

NC failed to change axes normally. (This is not the alarm caused at MCS.)

[Object] Newly selected axis

[Character-string] None

[Code]

1: MCS was not reset within 10[s].

2: The specified and active parameter numbers do not match or the control

3: NC failed to receive the maximum APA value in the divided travel from the encoder within 10[s].

6: NC failed to change the in-position amount or zero offset amount within 10 seconds.

A: NC failed to change the in-position amount or zero offset amount within 10 seconds after alarm occurrence.

[Probable Faulty Locations]

- Faulty MCS controller for PLC axes
- Faulty software

**★ 0890 MCS Independent encoder init**

An error occurred during initialization of MCS independent encoder.

[Index] Axis name or none (spindle)

[Character-string] None

[Code] Same with the alarm No. 865 "MCS encoder initialization error".

[Probable Faulty Locations]

- Independent position encoder
- Encoder link cables and connectors
- Invertor unit control board

**★ 0891 MCS APA error**

An error occurred during calculation of APA value.

[Index] Axis name or none (spindle)

[Character-string] None

[Code]XXXXXXXX

- 1: Linear axis divided travel over
- 2: Overflow during conversion of semi-position from [pr] to [pf]
- 3: Underflow in synthesizing the axis data
- 4: Overflow in synthesizing the axis data
- 5: Overflow of input values used for hybrid control
- 6: Overflow during initialization for hybrid control

[Probable Faulty Locations]

- Motor encoder, encoder with shaft, or ABSO SCALE
- Invertor unit control board
- Servo data file

If the alarm code is "1" or "3", the position encoder may not be properly offset to zero.

If the alarm code is "4", the servo data file may be defective.

If the alarm code is "5" or "6", the motor coupling, encoder with shaft, or ABSO SCALE may be loosely mounted.

**★ 0892 MCS Motor over load**

The motor load has exceeded the preset value, activating the overload protection function.

[Index] Axis name or none (spindle)

[Character-string] None

[Code] YYYYZZZZ

YYYY ->Gamma of the protection curve used to detect overload

ZZZZ ->Internally calculated overload data

[Probable Faulty Locations]

- Motor
- Overload caused by machine operation
- Servo data file

★ 0893 **MCS Safety Speed Monitor E-LINK Error**

All the axes needed for the speed monitor function is not connected with the safety speed monitor through E-LINK.

[Index] None

[Character-string] None

[Code] XX: Controller ID of the unconnected axis

[Probable Faulty Locations]

- The MIV unit of the code of the shown axis is connected to E-LINK.
- E-LINK cable is disconnected.

[Measures to Take]

- Connect the MIV unit of axis shown by code to E-LINK.
- Check the E-LINK cable.

★ 0900 **SVP start conditions uncertain**

SVP hardware or software conditions were not met, which made it impossible to start up the SVP.

[Index] AXIS

[Code] XYYZZZZ

X=1 -> Hardware-related conditions are not met.

YY=1->The SVP board is not mounted.

ZZZZ=0000

YY=2->The SVP is in abnormal status.

ZZZZSVP status

YY=3->The system bus related to the SVP hardware is in abnormal status.

ZZZZ: System bus status

X=2 -> SVP data conditions are not met.

YY=1->Wrong synchronous signal number is selected.

ZZZZ: Selected synchronous signal number

YY=2->Synchronous shift time is wrongly designated.

ZZZZ: Designated synchronous shift time

X=3->Software-related conditions are not met.

YY=1->The SVP software is not installed.

ZZZZ=0000

YY=2->Servo parameters are not installed.

ZZZZ=0000

[Probable Faulty Locations]

- 1) SVP hardware of the problem axis
- 2) Control software such as that for NC
- 3) NC specifications

★ 0901 **SVP processing trouble**

The SVP is in the trouble indicated by the following codes.

[Index] AXIS

[Character-string] None

[Code] XYYZZZZ

X=1 -> Internal error

The SVP has caused either parity loop error or protect error.

YY=Internal error status

ZZZZ=Two high-order bytes of the SVP system address in trouble

X=2 -> Time out

The SVP does not send any response within 20[s] at the time of start up. Minute investigation should be made to locate the cause.

Since the SVP cannot detect the start up signal, it cannot execute the start up sequence.

YY=00

ZZZZ=000000

X=3 -> Double bus error

During bus error exception processing by SVP, a bus error has occurred again. The SVP hardware will probably be defective.

YY=System bus status

ZZZZ=000000

X=4 -> SVP command execution

The SVP has obtained wrong diagnostic results of CPU command execution. The CPU will probably be defective.

YY=Diagnostic results

ZZZZ=000000

X=5 -> SVP trouble detected by the control software such as that for NC

Some trouble has occurred in the SVP.

[Probable Faulty Locations]

- 1) SVP hardware of the problem axis
- 2) SVP software of the problem axis
- 3) Control software such as that for NC

**★ 0902 SVP CON APA deviation**

Deviation between CON and APA has exceeded the preset limit.

The deviation can be obtained by the formula: [Calculated value written in SVP] - [Actual position read from SVP]. This value is monitored by the control software such as that for NC.

The SVP usually monitors DIFF. However, when the SVP becomes unable to monitor DIFF due to fatal abnormality, this monitoring function will prevent the system overrun.

[Index] AXIS

[Character-string] None

[Code] Absolute deviation value in hexadecimal [reference unit]

[Probable Faulty Locations] SVP of the problem axis

**★ 0903 SVP error**

The control software such as that for NC has detected a system alarm signal sent from the SVP hardware. For details, refer to the specification for the mounted SVP version.

[Index] AXIS

[Character-string] None

[Code] \*??##&&

\* -> Axis number of which SVP board's CPU has caused the error  
(If 2, the problem SVP board is that for the 2nd axis.)

?? -> Board status in hexadecimal

bit7bit6bit5bit4bit3bit2 bit1 bit0  
RUNHALTCPUOFF000 SNMI MSTP

## -> Bus error status in hexadecimal

bit7bit6bit5bit4bit3bit2 bit1 bit0  
SBERSBPARCYCER0PROTDAILOOPECC

&& -> Always 00

[Probable Faulty Locations]

- 1) Hardware defect of the SVP board indicated with the code \*
- 2) Software defect

**★ 0904 SVP exception processing**

Fatal abnormality has occurred in processing by SVP software.

[Index] AXIS

[Character-string] Detected error factor

- # 1 -> Bus error
- # 2 -> Address error
- # 3 -> Illegal instruction error
- # 4 -> Zero divide error
- # 5 -> CHK instruction error
- # 6 -> TRAPV instruction error
- # 7 -> Privilege violation error
- # 8 -> Trace error
- # 9 -> Line 1010 emulator error
- #10 -> Line 1111 emulator error
- #11 -> Unused area error
- #12 -> Coprocessor illegal protocol error
- #13 -> Format error
- #14 -> Uninitialized interrupt error
- #15 -> Spurious interrupt error
- #16 -> Interrupt error
- #17 -> INT7 error
- #18 -> Debugger interrupt alarm
- #19 -> INT2 loop error
- #20 -> INT5 loop error
- #21 -> Speed command calculation delay alarm
- #22 -> TRAP error
- #23 -> Floating-point coprocessor error
- #24 -> PMMU error
- #25 -> User interrupt error
- #26 -> Board version error
- #27 -> Memory test error

[Code]

The CPU program counter value is displayed except when the following character-strings appear.

With #26, SVP hardware ID number is displayed as a code.

With #27, the memory address at the time of abnormality detection is displayed as a code.

[Probable Faulty Locations]

- 1) SVP board
- 2) SVP software

**★ 0905 SVP APA pattern data**

The SVP has successively detected wrong patterns of positional data sent from the position encoder.

Ex.) Displayed code: 8000

Conversion into the octal number

8000 (hexadecimal number) -> 100000 (octal number)

Since the E8 unit reads up to 5 digits and ignores the sixth digit, all the digits become 0, causing the OSP to judge that no data is output from the encoder.

[Index] AXIS

[Character-string] None

[Code]

Pattern of the read positional data (APA high-order digit)

[Probable Faulty Locations]

- 1) Position encoder of the problem axis
- 2) SVP hardware of the problem axis
- 3) Timing signal from the NC unit

**★ 0906 SVP APA speed**

The position encoder value (RAPA) changes according to the motor speed. The NC checks the variation of position encoder values at regular intervals. If the feedrate of each axis is abnormally high compared with the normal rapid traverse rate, or the value changes in abnormal manner due to malfunction of the position encoder, the variation per unit time exceeds a fixed allowable limit, causing this alarm.

[Index] AXIS

[Character-string] None

[Code]

Variation of the position encoder values in hexadecimal

[encoder unit/3.2ms]

However, the following codes represents special meanings.

FFFFFFFF= The variation has exceeded the liner axis stroke.

FFFFFFFFE= The variation has exceeded the rotary axis stroke (360 deg), or the positional data of the infinite axis has changed to a negative value.

FFFFFFFFD= The variation has exceeded the infinite axis stroke.

[Probable Faulty Locations]

- 1) Position encoder of the problem axis or the cables connected with the encoder.
- 2) Motor for driving the problem axis
- 3) Drive unit of the problem axis
- 4) SVP hardware of the problem axis

**★ 0907 SVP CON speed**

When the axis is in the target position or at a standstill, the target value, operation value, and actual position data are the same. With designation of an axis moving command, the NC starts calculating the path to the target position, thus creating operation values (RCON). The NC then monitors the variation of the operation values at regular intervals. If the value changes in abnormal manner for some reason exceeding the allowable limit, this alarm occurs.

[Index] AXIS

[Character-string] None

[Code]

Absolute feedrate command value in hexadecimal [encoder unit / feedrate control time]

However, the following codes represents special meanings.

FFFFFFFF= The NC violates the protocol (time limit).

FFFFFFFFE= The feedrate command values is larger than the over alarm level or the alarm detection level.

FFFFFFFFC= The SVP internal command position exceeds the encoder division stroke.

[Probable Faulty Locations]

- 1) Servo parameter of the problem axis
- 2) Control software such as that for NC



3) SVP hardware of the problem axis

**★ 0908 SVP DIFF over**

When the axis is in the target position or at a standstill, the target value, operation value, and actual position data are the same. With designation of an axis moving command, the NC starts calculating the path to the target position, thus creating operation values (RCON). This time, the actual position data follows the operation values with a certain delay. This delay amount obtained by subtracting [actual position] from [operation value] is termed following error. If the following error exceeds the allowable limit, this alarm occurs.

[Index] AXIS

[Character-string] None

[Code]

Absolute DIFF value in hexadecimal [encoder unit]

[Probable Faulty Locations]

- 1) Mechanical trouble of ball screw, bearing or any other parts, which makes the axis movement heavy.
- 2) Encoder, motor or drive unit of the problem axis
- 3) Servo parameters of the problem axis
- 4) SVP hardware of the problem axis

**★ 0909 SVP servo amp**

Fatal abnormality has occurred in the servo amplifier.

[Index] AXIS

[Character-string] None

[Code] YYZZ

YY = Internal error status

ZZ = Servo amplifier IF status

[Probable Faulty Locations] Drive unit of the of the problem axis.

**★ 0910 SVP APA check data**

The high-order digit read from the position encoder does not match the high-order digit obtained by incremental operation.

Ex. Displayed code: 14E914A9

When this code is converted into the octal number (by carrying high-order digit for F or E type encoder or carrying octal number for E8 unit), the following result can be obtained.

12351	12251
Encoder digit data	Operation data

Judging from the difference by 1 in the third place's number, the third digit or the second digit which generates the carry signal must be showing the cause of this alarm, i.e. phase difference in gear connection.

[Index] AXIS

[Character-string] None

[Code] YYYYZZZZ

YYYY->Hexadecimal number of the high-order digit read from the encoder

ZZZZ->Hexadecimal number of the high-order digit obtained by calculation from the lower-order digit

[Probable Faulty Locations]

- 1) Position encoder of the problem axis
- 2) SVP board of the problem axis
- 3) Synchronous signals of the system

[Measures to Take] Convert the code to octal number.

If all the digits are shifted as in 1234523456

->SVP board is defective in most cases.

If the first digit is discrepant as in 1234512344

->MPR or bearing is defective in most cases.

If this alarm occurs in several axes

->Synchronous signals of TFP or SVP board are defective in most cases.

**★ 0911 SVP speed command over**

The speed command calculated by SVP has successively exceeded the allowable limit. Here, the allowable limit means the speed command over alarm level.

[Index] AXIS

[Character-string] None

[Code]

Hexadecimal number of the absolute feedrate command value at the time of abnormality detection [encoder unit/ feedrate control time]

[Probable Faulty Locations]

Excessive load is applied due to the mechanical reason.

Refer to the cause of SVP DIFF over alarm.

**★ 0912 SVP servo data setting**

The SVP has received non-applicable servo data. This alarm occurs when an abnormal value is set in the NC as servo data or when the servo processor cannot receive the set data.

Occurrence of this alarm during maintenance service implies that there may be an incompatibility between the servo parameter file and SVP software.

[Index] AXIS

[Character-string] None

[Code] Servo data number

- = 21-> Kv value
- = 22-> Hardware servo coefficient
- = 23-> Slow up/down coefficient
- = 26-> HB control slow up/down coefficient
- = 2B-> Inductosyn special pitch
- = 39-> Backlash compensation
- = 3A-> CON speed limit
- = 3B-> Mantissa of speed change ratio (straight line)
- = 3C-> Exponent part of speed change ratio (straight line)
- = 3D-> Speed change ratio (rotary)
- = 41-> V-AMP output filter constant group
- = 4F-> New speed detection G1
- = 50-> New speed detection G2
- = 51-> New speed detection HPF constant
- = 52-> New speed detection LPF constant
- = 53-> 1st speed acceleration/deceleration constant
- = 54-> HB control constant
- = 57-> 2nd speed acceleration/deceleration constant
- = 58-> Notch filter constant group
- = 62-> Encoder accuracy designation
- = 71-> Amplifier communication speed
- = 86-> DIFF. MIN (DIFF-G variable)

- = 87-> DIFF. MAX (DIFF-G variable)
- = 88-> ATTF calculation constant
- = 89-> Integration limit value
- = 100-> FLSUD change timing abnormal
- = 101-> 1st speed change timing abnormal
- = 102-> 2nd speed change timing abnormal
- = 103-> exp change timing abnormal
- = 104-> QITGMD change timing abnormal
- = 105-> Wrong interpolation mode
- = FFFF-> No authorization
- = FFFE-> Infinite/rotary axis
- = FFFD-> Infinite axis
- = FFFC-> Speed change ratio
- = FFFB-> Speed control cycle

[Probable Faulty Locations]

- 1) Servo parameter file of the problem axis
- 2) Control software such as that for NC
- 3) SVP software of the problem axis

**★ 0913 SVP Belt is broken**

The SVP has detected breakage of the belt for belt-driven axis.

[Index] AXIS

[Character-string] None

[Code] Hexadecimal number of the torque applied at the time of breakage

**★ 0914 SVP F-TYPE encoder error**

Error compensation data for one turn cannot be set in the position encoder.

[Index] AXIS

[Character-string] None

[Code] The number indicating the setting impossible reason

- 1-> Data read disabled
- 2-> Data check sum error
- 4-> Data overflow
- 5-> Error compensation data does not return to 0.

[Probable Faulty Location] Position encoder of the problem axis

**★ 0915 SVP full closed loop error**

Deviation between the full-closed loop and semi-closed loop is abnormally large.

[Index] AXIS

[Character-string] None

[Code] The number of abnormality detection times

[Probable Faulty Locations]

- 1) Separately mounted position encoder or inductosyn of the problem axis
- 2) Excessive lost motion of the problem axis
- 3) Slippage or breakage of the belt on the problem axis
- 4) Coupling compensation is not set or wrong data is set in the problem axis.
- 5) The positional loop gain of the problem axis is not proper (too high).

★ 0916 **SVP F-TYPE encoder with shaft error**

It is impossible to set the rotation error compensation data of F type position encoder with shaft.

[Index] AXIS

[Character-string] None

[Code] The number indicating the setting disable reason.

- 1-> Data read disabled
- 2-> Data check sum error
- 4-> Data overflow
- 5-> Error compensation data does not return to 0.

[Probable Faulty Location] Position encoder of the problem axis

★ 0917 **SVP F with shaft APA pattern data**

The position encoder with shaft has successively read positional data of wrong patterns.

[Index] AXIS

[Character-string] None

[Code] Pattern of the read positional data (APA high-order digit)

[Probable Faulty Locations]

- 1) Position encoder of the problem axis
- 2) SVP hardware of the problem axis
- 3) Timing signal from the NC unit

★ 0918 **SVP cannot plant error offset data**

When the extended pitch error compensation function is provided, the SVP memory does not have enough capacity for storing the data.

[Index] AXIS

[Character-string] None

[Code] None

[Probable Faulty Locations]

- 1) SVP board controlling the problem axis
- 2) Extended pitch error compensation file containing extended pitch error compensation data of the problem axis

★ 0919 **SVP encoder application (MOTOR SHAFT)**

The encoder type mounted on the motor does not conform to the encoder accuracy data.

[Index] AXIS

[Character-string] None

[Code] None

★ 0920 **SVP encoder application (WITH SHAFT)**

The encoder type mounted on the shaft does not conform to the encoder accuracy data.

[Index] AXIS

[Character-string] None

[Code] None

★ 0921 **SVP collision detection**

The SVP has detected collision of the driving unit with something.

[Index] AXIS

[Character-string] None

[Code] YYYYZZZZ

YYYY->Average motor output torque

ZZZZ->Average motor acceleration

**★ 0922 SVP SA overload**

The servo amplifier has overheated exceeding the protection curve set in the SVP control software.

[Index] AXIS

[Character-string] None

[Code] YYYYZZZZ

YYYY->gamma of the protection curve used for overload detection

ZZZZ->theta [n] at overload detection

[Probable Faulty Locations]Servo amplifier of the problem axis

**★ 0923 SVP SA communication error**

Abnormality has occurred in communication between SVP and servo amplifier.

[Index] AXIS

[Character-string] None

[Code]Cause indication number

1-> Parity error in SVP

2-> The sent data does not match the received data.

3-> Servo amplifier ID is not properly received.

4-> No signal is sent from the servo amplifier

5-> Parity error has occurred in servo amplifier.

[Probable Faulty Locations]Servo amplifier of the problem axis

**★ 0924 SVP SA version error**

Version check by the amplifier version control function proved that the mounted servo amplifier version is newer than the versions applicable to the SVP software.

[Index] AXIS

[Character-string] None

[Code] Version data

1000000->BL=-D is mounted though BL-D is required.

XXYYZZ:

XX-> SVP version

YY-> Servo amplifier version applicable to SVP

ZZ-> Servo amplifier version

[Probable Faulty Locations]Servo amplifier of the problem axis

**★ 0925 SVP SA motor cable overcurrent**

The servo amplifier has detected an excessive current flow in the motor cables.

A warning lamp IOCM on the servo amplifier is lit.

[Index] AXIS

[Character-string] None

[Code] None

[Probable Faulty Locations]Servo amplifier of the problem axis

★ 0926 **SVP SA inverter bridge short circuit**

The servo amplifier has detected short-circuit of the inverter bridge in the amplifier.  
A warning lamp IOCS on the servo amplifier is lit.

[Index] AXIS

[Character-string] None

[Code] None

[Probable Faulty Locations] Servo amplifier of the problem axis

★ 0927 **SVP SA overheating**

The servo amplifier has detected overheating of the amplifier.  
A warning lamp SVTH on the servo amplifier is lit.

[Index] AXIS

[Character-string] None

[Code] None

[Probable Faulty Locations] Servo amplifier of the problem axis

★ 0928 **SVP SA power circuit overvoltage**

The servo amplifier has detected overvoltage applied to the power circuit of the amplifier. A warning lamp HV on the servo amplifier is lit.

[Index] AXIS

[Character-string] None

[Code] None

[Probable Faulty Locations] Servo amplifier of the problem axis

★ 0929 **SVP SA power circuit low voltage**

The servo amplifier has detected voltage drop in the amplifier power circuit. A warning lamp LV on the servo amplifier is lit.

[Index] AXIS

[Character-string] None

[Code] None

[Probable Faulty Locations] Servo amplifier of the problem axis

★ 0930 **SVP SA regenerative resistor overheat**

The servo amplifier has detected excessive power consumption in the regenerative resistance of the amplifier. A warning lamp DROH on the servo amplifier is lit.

[Index] AXIS

[Character-string] None

[Code] None

[Probable Faulty Locations] Servo amplifier of the problem axis

★ 0931 **SVP SA control circuit power voltage**

The servo amplifier has detected the abnormal voltage applied to the amplifier control circuit. A warning lamp VR on the servo amplifier is lit.

[Index] AXIS

[Character-string] None

[Code] None

[Probable Faulty Locations] Servo amplifier of the problem axis

★ 0932 **SVP SA error**

The servo amplifier is in some trouble. For details, refer to the specification suitable for the mounted SVP or servo amplifier version.

[Index] AXIS

[Character-string] None

[Code] None

[Probable Faulty Locations] Servo amplifier of the problem axis

★ 0933 **SVP board version error**

The SVP hardware version is wrong.

[Index] AXIS

[Character-string] None

[Code] 1=SVP hardware ID is not 1.

[Probable Faulty Locations] SVP board controlling the problem axis

★ 0934 **SVP control error**

The SVP board is in a trouble related to the axis control.

For details, refer to the specification suitable for the mounted SVP or servo amplifier version.

[Index] AXIS

[Character-string] None

[Code] Alarm data

[Probable Faulty Locations] SVP software controlling the problem axis

★ 0935 **SVP data file read**

At the start up of NC, data reading from SVMU was disabled.

[Index] None

[Character-string] None

[Code]

FFFF -> Abnormality in configuration file.

8000 -> The file's DB0 sector is not PBU1.

-> File attribute is wrong.

-> Device is wrongly formatted.

8001 -> In data reading, EOF was received before reading even one character.

8002 -> In indirect data transfer, the file buffer size is not 2048 bytes.

-> In direct data transfer, the object buffer size is not a multiple of 256 bytes.

8003 -> EOF was received in the middle of reading.

-> The designated axis is not found in the SVMU file.

8004 -> Free SAT was not found.

8005 -> Attempt was made to open the protected file in sequential output mode.

8006 -> In file opening, there were input parameters contradicting each other.

8007 -> Attempt was made to open more than 16 files.

8008 -> File opening was attempted by the already executed sequential output command. The already opened file was made to reopen in sequential output mode.

8009 -> Wrong device name was designated.

800A -> Wrong file name was designated.

800B -> The object file was not found in file searching.

800C -> PUT or GET command was designated in a mode other than open mode.

9001 -> There is no SVMU file for heavy parts.

[Measures to Take]

- 1) Create a SVMU file.
- 2) Recreate the configuration file.
- 3) Reload the control floppy disk.

**★ 0936 SVP data file data address**

The address where SVMU\*.PBU, PBU file for servo processor, will be loaded is not the legal servo processor address.

[Index] None

[Character-string] None

[Code] Abnormal load address

[Probable Faulty Locations]

Defective SVMU file (The number of axes does not agree with the specifications, or SVMU file was created in wrong procedure, etc.)

[Measures to Take] Recreate the SVMU file.

**★ 0937 SVP data file check**

- 1) Checking the SVP data file with the servo data file SVMU\*.PBU. proved that the rotary/linear axis specifications registered in SVMU are different from those registered in the specification code file.
- 2) The declared number of control axes is different from that of additional axes.

[Index] None

[Character-string] None

[Code] XYYZZ

X=1: The SVP data file is different from the servo data file in specification codes.

YY =00:X-axis

=01:Y-axis

=02:Z-axis

=03:4th axis

=04:5th axis

ZZ =00:Linear axis

=01:Rotary axis

X=2: The number of additional axes declared in the specification code file is different from the actual number of additional axes.

YY =:The number of additional axes

ZZ =:NC specification code No. 14

X=3: There is an error in inequality between the characteristic data of feedrate-time constants.

YY =00: X-axis

=01: Y-axis

=02: Z-axis

=03: 4th axis

=04: 5th axis

ZZ =11: FT1max=0

=12: FT1max<FT1min

=13: FT1max=FT1min and T1max<T1min

=14: FT1max>FT1min and F1max<T1min

=21: FT2max=0 (FT2max is determined by internal calculation)

=22: FT2max<FT2min

=23: FT2max=FT2min and T2max<T2min



=24: FT2max>FT2min and T2max<T2min

[Measures to Take]

- 1) Check the servo data file or specification code file and correct its data.
- 2) Match the declared number of additional axes to the number of additional axis names in the specification code file.
- 3) Correct the characteristic data of the feedrate-time constants stored in the problem servo data file.

★ 0938 VAC start

An error detected in the communication with the VAC.

[Code] XXXXYYYY

Error Code;Error Cintents

1001FFFF	Data link with the VAC has not been established with 20[s]
1002****	When the data link with the VAC is established,a communication error occurred. The least significant two bytes indicate the error status. (Refer to the Supplement below.)
2001FFFF	In the transmission of the first data file,the communication time out error occurred when the first data file transmission command was executed.
2002****	In the transmission of the first data file, the communication error occurred when the first data file transmission command was executed. The least significant two bytes indicate the error status. (Refer to the Supplement below.)
2101FFFF	In the transmission of the first data file,the communication time out error occurred when the first data file transmission request command was executed.
2102****	In the transmission of the first data file, the communication error occurred when the first data file transmission request command was executed. The least significant two bytes indicate the error status. (Refer to the Supplement below.)
2103****	In the transmission of the first data file,unexpected data was sent from the VAC when the first data file transmission request command was executed. The least significant two bytes indicate the data which was sent.
2201FFFF	In the transmission of the first data file, the communication time out error occurred while one sector of the first data file was transmitted
2202****	In the transmission of the first data file, the communication error occurred while one sector of the first data file was transmitted. The least significant two bytes indicate the error status. (Refer to the Supplement below.)
2301FFFF	In the transmission of the first data file, the communication time out error occurred in the one sector receive check of the first data file.
2302****	In the transmission of the first data file, the communication error occurred in the one sector receive check of the first data file. The least significant two bytes indicate the error status. (Refer to the Supplement below.)
2303****	In the transmission of the first data file,unexpected data was sent from the VAC in the one sector receive check of the first data file. The least significant two bytes indicate the data which was sent.
24002310	In the transmission of the first data file, the error retry(3 times) error due to the NG command of the one sector receive check of the first data file occurred.
4001FFFF	In the transmission of the VAC initialization data, the communication time out error occurred when the VAC initialization data transmission command was executed.
4002****	In the transmission of the VAC initialization data, the communication error occurred when the VAC initialization data transmission command was executed. The least significant two bytes indicate the error status.(Refer to the Supplement below.)
4101FFFF	In the transmission of the VAC initialization data, the communication time out error occurred when the VAC initialization data transmission request command was executed.
4102****	In the transmission of the VAC initialization data, the communication error occurred when the VAC initialization data transmission request command was executed. The least significant two bytes indicate the error status.(Refer to the Supplement below.)
4201FFFF	In the transmission of the VAC initialization data, the communication time out error occurred while the VAC initialization data was transmitted.

---

4202****	In the transmission of the VAC initialization data, the communication error occurred while the VAC initialization data was transmitted. The least significant two bytes indicate the error status. (Refer to the Supplement below.)
4301FFFF	In the transmission of the VAC initialization data, the communication time out error occurred in the VAC initialization data transmission receive check.
4302****	In the transmission of the VAC initialization data, the communication error occurred in the VAC initialization data transmission receive check. The least significant two bytes indicate the error status.(Refer to the Supplement below.)
4303****	In the transmission of the VAC initialization data, unexpected data was sent from the VAC in the VAC initialization data transmission receive check. The least significant two bytes indicate the data which was sent.
5001FFFF	When the synchronization is established, the communication time out error occurred when the synchronization establishing command was executed.
5002****	When the synchronization is established, the communication error occurred when the synchronization establishing command was executed. The least significant two bytes indicate the error status. (Refer to the Supplement below.)
5101FFFF	When the synchronization is established, the communication time out error occurred when the synchronization establishing request command was executed.
5002****	When the synchronization is established, the communication error occurred when the synchronization establishing command was executed. The least significant two bytes indicate the error status. (Refer to the Supplement below.)
5101FFFF	When the synchronization is established, the communication time out error occurred when the synchronization establishing request command was executed.
5102****	When the synchronization is established, the communication error occurred when the synchronization establishing command was executed. The least significant two bytes indicate the error status. (Refer to the Supplement below.)
5201FFFF	When the synchronization is established, the previous transmission was not completed when the synchronization signal was transmitted.
5202****	When the synchronization is established, the communication error was occurred when the synchronization signal was transmitted. The least significant two bytes indicate the error status. (Refer to the Supplement below.)
5301FFFF	When the synchronization is established, the synchronization establish response was not returned from the VAC.
5302****	When the synchronization is established, the communication error was occurred in the synchronization establish response receive check. The least significant two bytes indicate the error status. (Refer to the Supplement below.)
5401FFFF	When the axis synchronization is established, the previous transmission was not completed when the axis synchronization establishing command was executed.
5402****	When the axis synchronization is established, the communication error was occurred When the axis synchronization command was executed. The least significant two bytes indicate the error status. (Refer to the Supplement below.)
5501FFFF	When the axis synchronization is established, the previous transmission was not completed when the axis synchronization request command was executed.
5502****	When the axis synchronization is established, the communication error was occurred When the axis synchronization request command was executed. The least significant two bytes indicate the error status.(Refer to the Supplement below.)
5601FFFF	When the axis synchronization is established, the previous transmission was not completed when the axis synchronization (A) signal was transmitted.
5602****	When the axis synchronization is established, the communication error was occurred When the axis synchronization (A) signal was transmitted. The least significant two bytes indicate the error status. (Refer to the Supplement below.)
5701FFFF	When the control is being set ready,the previous transmission was not completed when the control command was executed.
5702****	When the control is being set ready,the communication error was occurred When the control ready command was executed. The least significant two bytes indicate the error status.(Refer to the Supplement below.)

1FFFF	When the control is being set ready,the control ready complete notification was not returned from the VAC.
2****	When the control is being set ready,the communication error was occurred When the control ready complete notification check. The least significant two bytes indicate the error status. (Refer to the Supplement below.)
5801FFFF	The previous transmission failed to end before the control became ready to start.
5802****	A communication error occurred when the VAC control became ready to start. The least significant two bytes indicate the error status. (Refer to the Supplement below.)
FF0000**	The control status of the control ready complete notification which was sent from the VAC is in the alarm state. The least significant one byte indicates the VAC alarm number.
FE0000**	The self-diagnosis of the control ready complete notification which was sent from the VAC is not \$55. The least significant one byte is the self-diagnosis data which was sent.
F001****	An error occurred in the communication buffer read/write test. The least significant two bytes indicate the relative address of the memory involved with the error.
F002****	The error occurred with the communication LSI in the communication buffer read/write test. The least significant two bytes indicate the error status. (Refer to the Supplement below.)
Supplement: Bit 15 ->Double-transmission error	
->Bit 14 Double-receive error	
->Bit 13 Format error	
->Bit 12 CRC error	
->Bit 11 Parity error	

[Probable Faulty Locations]

- 1) High-precision VAC drive unit
- 2) SPC6 card

**★ 0939 VAC data file read**

The NC has failed to correctly read the VAC data file.

[Index] None

[Character-string] None

[Code]

- 1-> VAC data file is not found.
- 2-> Type of VAC data file is wrong.
- 3-> VAC data file is too large.
- 4-> DB size for VAC data file is too large.
- 5-> DB size for VAC data file is too small.
- 6-> Though the number of a gear tooth of data files for VAC does not do work spindle PG nothing of NC specification, it is not \$FFFF.
- 7-> Though in the number of a gear tooth of data files for VAC makes it done work spindle PG nothing of NC specification there is not, it is \$FFFF.

[Probable Faulty Locations]

Software contents do not conform to the hardware specifications

- 6-> An establishment mistake of data files for NC specification or VAC.
- 7-> An establishment mistake of data files for NC specification or VAC.

[Measures to Take] Check the software contents.

**★ 0940 Time sharing task control**

Time sharing task control is impossible.

[Index] None

[Character-string] 'A'

- A = 1 to 7 Main board number which detected this alarm

= B The FCP board detected this alarm.

[Code]

Hexadecimal number of the data at address 8 of the supervisor stack, when interruption is activated

[Probable Faulty Locations]

- 1) Function error of the PTM (programmable timer) on the main board
- 2) Problem with software
- 3) Malfunction of TMINT on FCP board

**★ 0941 Real time task control**

Real time task control is impossible because the supervisor state remains between two consecutive real time task control interruption occurrences.

[Index] None

[Character-string] 'A'

A = 1 to 7 Main board number which detected this alarm

= B The FCP board detected this alarm.

[Code]

Hexadecimal number of the data at an address eight addresses ahead of the supervisor stack, when interruption is activated

[Probable Faulty Locations]

- 1) Faulty timing board (TFP board or FCP board)
- 2) Faulty servo processor (SVP board or FCP board)

**★ 0942 Real time task loop error**

The real time task displayed in character strings has not been completed within a preset processing time.

[Index] None

[Character-string] Task name

[Code] Program counter value at detection of the loop error.

[Probable Faulty Locations]

- 1) Timing error of synchronous signal
- 2) Wrong setting of synchronous signal cycle
- 3) Defective software

**★ 0943 Main processor name incorrect**

An illegal character string is used to designate the main processor name in the configuration file.

[Index] None

[Character-string] Main processor name specified in the configuration file.

[Code] None

**★ 0944 Slave processor name incorrect**

An illegal character string is used to designate a slave processor name in the configuration file, or non-existent slave processor name is designated.

[Index] None

[Character-string] Slave processor name specified in the configuration file.

[Code] None

**★ 0945 Memory board / battery life**

The battery of memory board has finished its service life.

[Index] None

[Character-string] None

[Code] None

[Probable Faulty Locations] Battery in the memory board

[Measures to Take] Change the battery in the memory board and reinstall the software and user data.

★ 0946 **TFP illegal**

The TFP board is in abnormal condition.

[Index] None

[Character-string] None

[Code] XXYYZZ

XX =

01-> TFP data transmission module has stopped.

02-> Exception error

YY =

01-> FNP bus error

02-> Address error

03-> Illegal instruction

04-> Zero divide error

05-> CHK instruction error

06-> TRAPV instruction error

07-> Privilege violation

08-> Trace error

09-> Line 1010 emulator error

0A-> Line 1111 emulator error

0B-> Exception vector error

0C-> Spurious interrupt error

0D-> Interrupt error

0E-> TRAP instruction error

0F-> User interrupt error

ZZ =

bit 7-> System bus error

bit 6-> System bus parity error

bit 5-> Cycle over error

bit 4-> Protect error

bit 3-> Loop error

bit 2-> Loop error cancel

bit 1-> RAM (program area) parity error

bit 0-> RAM (data buffer) parity error

XX =

03-> No data file

04-> Main CPU abnormal (occupied by output code data)

05-> Download parameter type abnormal

06-> Defective connection of optical fiber cables

07-> Defective initialization of HSCC

[Probable Faulty Locations]

1) Defective TFP board

2) Defective software

[Measures to Take]

- 1) Change the TFP board.
- 2) Revise the software.

★ 0947 **TFP data file read**

The NC has failed to read the TFP data.

[Index] None

[Character-string] None

[Code]

- 1-> File not found
- 2-> Wrong file attribute

[Probable Faulty Locations]

- 1) If the NC was normally running before occurrence of this alarm, the TFP data file must have been deleted or destroyed.
- 2) If the NC had never run after installation of the control software until occurrence of this alarm, the TFP data file must be wrong in type or the control software did not include the file.

[Measures to Take]

- 1) Reinstall the control software.
- 2) Check the control floppy (for file name, etc.) and remake the floppy.

★ 0948 **TFP Field net communication error**

An error has occurred in communication between TFP board and fieldnet.

[Index] None

[Character-string] None

[Code] XXYYZZZZ

XX =

01-04-> TFP board channel number where the error has been detected

YY =

bit 7-> Double transmission error

bit 6-> Double reception error

bit 5-> Format error

bit 4-> CRC error

bit 3-> Parity error (transmission/reception buffer)

bit 2-> Detection of disconnection signal

bit 1-> Time out error

bit 0-> Reception finish time over

ZZZZ =

bit 15->Error detection at slave station

bit 14->Undefined instruction

bit 13->Undefined instruction

bit 12->Start bit error

bit 11->Stop bit error

bit 10->Undefined instruction

bit 9, 8-> Repeat number

bit 7-0-> Slave station number where the error has been detected (Master station: \$00)

[Probable Faulty Locations]

- 1) Defective TFP board
- 2) Defective slave station unit
- 3) Defective optical fiber cable

[Measures to Take]

- 1) Change the TFP board.
- 2) Change the slave station unit.
- 3) Check the optical fiber cable.

**★ 0949 IO DIAGNOSTICS data file read**

The NC has failed to read the I/O diagnostic data file.

[Index] None

[Character-string] None

[Code]

- 1-> File not found
- 2-> Wrong file attribute

[Probable Faulty Locations]

- 1) If the NC was normally running before occurrence of this alarm, the I/O diagnostic data file must have been deleted or destroyed.
- 2) If the NC had never run after installation of the control software until occurrence of this alarm, the I/O diagnostic data file must be wrong in type or the control software did not include the file.

[Measures to Take]

- 1) Reinstall the control software.
- 2) Check the control floppy (for file name, etc.) and remake the floppy.

**★ 0950 IO MACRO data file read**

The NC has failed to read the macro data file.

[Index] None

[Character-string] None

[Code]

- 1-> File not found
- 2-> Wrong file attribute
- 3-> Wrong data arrangement in I/O macro data file

[Probable Faulty Locations]

- 1) If the NC was normally running before occurrence of this alarm, the I/O macro data file must have been deleted or destroyed.
- 2) If the NC had never run after installation of the control software until occurrence of this alarm, the I/O macro data file must be wrong in type or the control software did not include the file.

[Measures to Take]

- 1) Reinstall the control software.
- 2) Check the control floppy (for file name, etc.) and remake the floppy.

**★ 0951 SMP illegal**

CPU error has occurred on the main board other than the 1st main board.

[Index] None

[Character-string] None

[Code] \*%%&&??

- \* -> Main board number where error was detected (Ex.2: 2nd main board)
- %% -> Board status in hexadecimal
- && -> Bus error status in hexadecimal
- ?? -> Always 00

[Probable Faulty Locations]

- 1) Hardware defect of the main board indicated by the code \*
- 2) Software defect

**★ 0952 Processor Board not equip**

The name of an unmounted board is written in the configuration file.

[Index] None

[Character-string]

Main processor name or slave processor name written in the configuration file. Such processor is not actually mounted.

[Code] None

**★ 0954 Peripheral processor start**

At the start up of NC, no answer is sent from the peripheral processor within a preset time (20[s]).

[Index] None

[Character-string] None

[Code] XY

X=

A-> TFP

1-> 1st main board

2-> 2nd main board

3-> 3rd main board

4-> 4th main board

When X= A,B

Y= Internal sequence counter at the start up of NC

When X= 1-4

Y=

1-> Main processor start time out

2-> Task initialization time out

4-> Task could not be initiated.

[Probable Faulty Location]

Hardware defect

Initial data of each processor (PBU file data)

Program example: None

Operation example: None

[Measures to Take]

- 1) Check the initial data of the processor indicated by the alarm code.
- 2) Check the hardware.
- 3) Locate the problem peripheral processor by referring to the alarm code and check the sequence counter value.

**★ 0955 Spec. code: data file**

[Code] ABCCCCC

A:

1-> NC specification code file (FR0A:)

2-> EC specification code file (FR0A:)

3-> NC specification code file for PLC created by MTB (FR0G:)

4-> NC specification code file for PLC created by MTB (MD0G:)

B:

1-> No file is found.



- 2-> File attribute and sector size do not conform to 'SPC1'.
  - 3-> Mismatch of the machine number
  - 3-> Mismatch of the machine name
  - 4-> Mismatch of the specification code data
  - 6= -
  - 7= Mismatch of the specification code data (such as machine number, machine name, and coded data) except for the data stored in the specification code change file
  - 8= The file is not OSP-formatted.
  - 9= File open error
  - A= File read error
- CCCCCC: 000000 ... BÂÇ5  
XXYYZZ ... B=5  
XX: Byte position of the mismatched specification code  
YY: Mismatched specification code data  
ZZ: Specification code data (before change)

★ 0956 **Backup data file read**

- The back up file (MNCUA, MNCUB, MIMUA) is not found or is wrong in type or size.
- MIMUA\*.PBU (Back up file for interactive function)
- MNCUB\*.PBU (Back up file for system parameters)
- MNCUA\*.PBU (Back up file for general data and parameters)

[Index] None

[Character-string] None

[Code]XY

Code X: File that caused the alarm

Code Y: Alarm content

A one-character code indicates that the code X of the file is 0

Code X:

- 0-> MNCUA\*.PBU or MIMUA\*.PBU (only when interactive function is supported.)
- 1-> MNCUB\*.PBU
- 2-> MNCUC\*.PBU(Graphic)or MNCUE\*.PBU(AT comp.)
- 3-> VAMU\*.PBU
- 4-> MNCUF\*.PBU (Thermal deviation compensation)
- 5-> MNCUG\*.PBU (New PPC)
- 6-> MNCUZ\*.PBU(B# A)
- 7-> MNCUZ\*.PBU(B# B)
- 8-> MNCUZ\*.PBU(B# C)
- 9-> MNCUZ\*.PBU(B# D)
- E-> MECUA\*.PBU(machine data backup)
- F-> MMFUA\*.PBU(machining management)

CodeY:

- 1-> File is not found.
- 2-> File type is not PBU1.
- 3-> Larger file size
- 4-> Smaller file size
- 5-> Address table or pointer table has not been set.
- 6-> Address table has not been set.

[Probable Faulty Locations]

- 1) If NC had been running before alarm occurrence, PBU file must have been deleted or its data must have been destroyed.
- 2) If the alarm occurred before running the NC after control floppy loading, the PBU file is wrong in type or no PBU file exists.

★ 0957 **Graphic Back up data file read**

★ 0958 **Pitch compensate data file read**

For the NC provided with the ball screw pitch error compensation function or inductosyn compensation function, the pitch error compensation data file(MT0....POL) is not found in the memory at the time of power supply.

[Index] None

[Character-string] None

[Code]

FFFFFFFF-> No compensation data file is found.

Other codes->The compensation data file has wrong data size.

[Probable Faulty Locations] Pitch error compensation file

[Measures to Take] Reinstall the control floppy.

★ 0959 **IGF Specification unmatching**

In initialization of IGF, the NC has detected a mismatch in specifications.

[Index] None

[Character-string] None

[Code]

1-> The common table in NCGEN does not match that in IGFMAIN.

2-> The number of controlled axes in IGF does not match the number determined by each axis data (such as axis name, linear/rotary axis).

[Probable Faulty Locations]

1) Defect in combined use of control programs

2) Defective software

★ 0960 **IGF Backup data file read**

Some trouble has occurred in reading PBU file for IGF.

[Index] None

[Character-string] None

[Code]

1-> MIGUC\*. PBU is not found.

2-> MIGUC\*. PBU is wrong in attribute.

3-> MIGUC\*. PBU is wrong in size.

11-> MIGUM\*. PBU is not found.

12-> MIGUM\*. PBU is wrong in attribute.

13-> MIGUM\*. PBU is wrong in size.

21-> MIGUG\*. PBU is not found.

22-> MIGUG\*. PBU is wrong in attribute.

23-> MIGUG\*. PBU is wrong in size.

31-> MIGU1\*. PBU is not found.

32-> MIGU1\*. PBU is wrong in attribute.

33-> MIGU1\*. PBU is wrong in size.

41-> MIGU4\*. PBU is not found.

42-> MIGU4\*. PBU is wrong in attribute.

43-> MIGU4\*. PBU is wrong in size.

[Probable Faulty Locations]

- 1) Defective memory board
- 2) Defective software

**★ 0961 IGF illegal**

An error has occurred in initialization of IGF, making it impossible to start up the IGF.

[Index] None

[Character-string] None

[Code] None

[Probable Faulty Locations]

- 1) Defective software

**★ 0962 CCP Roader file load**

The load module file for the CCP loader cannot be loaded when the data communications function is activated with the DNC-C specification.

[Index] None

[Character-string] None

[Code]

- 1-> No CCP loader software (CLA\*.LOB)
- 2-> The CCP loader software is other than "LOB1".
- 3-> An error was present in load address information of the CCP loader software.
- 4-> Unsuccessful CCP loader software
- 5-> Mismatch occurred in verification after CCP loader software.

[Probable Faulty Locations]

- 1) Faulty load object "CLA\*.LOB" for the CCP loader
- 2) Faulty software when 4 is indicated as the code.
- 3) Faulty CCP board when 5 is indicated as the code.

**★ 0963 CCP Application file load**

The load module file for the CCP application cannot be loaded when the data communications function is activated with the DNC-C specification.

[Index] None

[Character-string] None

[Code]

- 1-> No CCP loader software (CBA\*.LOB)
- 2-> The CCP loader software is other than "LOB1".
- 3-> An error was present in load address information of the CCP loader software.
- 4-> Unsuccessful CCP loader software
- 5-> Mismatch occurred in verification after CCP loader software.

[Probable Faulty Locations]

- 1) Faulty load object "CBA\*.LOB" or "CBZ\*.LOB" for the CCP loader
- 2) Faulty software when 4 is indicated as the code.
- 3) Faulty CCP board when 5 is indicated as the code.

**★ 0964 CCP Parameter file load**

An attempt to read data from the backup file (MHU, MIU) has failed when the data communications function is activated with the DNC-C specification.

[Index] None

[Character-string] None

[Code]

- 1-> No one-line data file (MHU\*.PBU) or no communications parameter data file (MIU\*.PBU)
- 2-> The type of the on-line data file is other than "PAR1". Or the type of the communications parameter data file is other than "PAR2".

[Probable Faulty Locations]

Faulty on-line data file (MHU\*.PBU) or faulty communications parameter data file (MIU\*.PBU).

**★ 0965 Configuration file format error**

The configuration file contains wrong data.

[Index] None

[Character-string] Environmental variable in the wrong data line

[Code] None

[Probable Faulty Locations] Defective creation of the configuration file

**★ 0966 Configuration file open error**

The NC has failed to properly open the configuration file.

[Index] None

[Character-string] None

[Code]

- 1-> File size over
- 2-> Format (Different from OSP format)
- 3-> Format (Wrong file attribute, etc.)
- 4-> The NC has read no data or received EOF before reading the whole data.
- §80??-> An error has occurred in the system program (SP). (?: SP Code)

[Probable Faulty Locations]

- 1) Defective creation of the configuration file
- 2) No configuration file exists.

**★ 0967 Array limit check table is bad**

An alarm occurs if the system variable number to be set is not found in the array limit check table when setting this table of the array type system variable according to the specification code.

[Index] None

[Character-string] None

[Code] None

[Measures to Take] In the MMSC,

- 1) Check CQARCKT1 and CQARCKT2.
- 2) Confirm that the code corresponding to the system variable number which caused the alarm has been registered in the table.

**★ 0968 No specification**

Though the interactive programming function on monographic display (I-MAP) is not provided with the pattern cycle function, the loaded program includes POL for additional milling or cylindrical cutting.

[Index] None

[Character-string] None

[Code]

- 1-> Cylindrical milling cycle is designated.

2-> Additional pattern cycle is designated.

[Measures to Take] Check the NC specifications again.

**★ 0969 Memory size is not same**

Mismatch between the operation buffer size and the capacity of the RAM actually set

RAM Capacity	Operation Buffer (m)	Operation Buffer Specification code
512K	80	PSCOD24.12 = 0
1M	160	PSCPSCOD24.12 bit 1 :ON
	320	OD24.12 bit 0 :ON
2M	640	PSCOD24.12 bit 2 :ON
	1280	PSCOD24.12 bit 3 :ON
	2560	PSCOD24.12 bit 4 :ON

[Index] None

[Character-string] None

[Code] 1 only

[Probable Faulty Locations]

The operation buffer specification code does not correctly correspond to the RAM size as indicated above.

[Measures to Take]

- 1) Check the specification code.
- 2) If the specification code is set correctly, change the RAM size as indicated in the table.

**★ 0970 Synchronous axis specification code**

Improper setting of the specification code to designate the simultaneously controlled axes

- 1) The number of axes, including the slave axes, is larger than six.
- 2) A rotary axis is designated as the simultaneously controlled axis.

[Index] None

[Character-string] None

[Code]

One-digit: Alarm due to 1) above  
The total number of axes, including the slave axis

Two-digit: Alarm due to 2) above  
Axis index of the designated rotary axis  
60-> 4th-axis  
80-> 5th-axis

[Probable Faulty Locations]

Wrong specification code

[Measures to Take]

Create the specification code again.

[Related Specifications]

Simultaneously controlled axis specification

**★ 0971 Cache data / initialization error**

**★ 0972 SVP INDEXING high-speed indexing over**

In high-speed indexing controlled by SVP, the positioning speed has exceeded the preset speed.

[Index] AXIS

[Character-string] None

[Code] None

★ 0973 **SVP INDEXING low-speed indexing over**

In low-speed indexing controlled by SVP, the positioning speed has exceeded the preset speed.

[Index] AXIS

[Character-string] None

[Code] None

★ 0974 **SVP INDEXING unclamp time over**

Unclamp operation is disabled or takes time.

[Index] AXIS

[Character-string] None

[Code] None

[Probable Faulty Locations]

- 1) Maladjustment of the unclamp limit switch
- 2) Low oil pressure
- 3) Malfunction of the solenoid valve

★ 0975 **SVP INDEXING clamp time over**

Clamp operation is disabled or takes time.

[Index] AXIS

[Character-string] None

[Code] None

[Probable Faulty Locations]

- 1) Maladjustment of the clamp limit switch
- 2) Low oil pressure
- 3) Malfunction of the solenoid valve
- 4) Wrong offset data is set on the position encoder.
- 5) Wrong positional data is set for positioning.

★ 0976 **SVP INDEXING positioning direction**

The direction of rotation for positioning is opposite to the designated direction.

[Index] AXIS

[Character-string] None

[Code] None

★ 0977 **SVP INDEXING incorrect command**

The NC has given an incorrect command to the positioning unit.

[Index] AXIS

[Character-string] None

[Code] None

[Probable Faulty Locations]

The turret indexing command value exceeds the maximum number of points.

★ 0978 **SVP INDEXING servo data setting**

Data error in the servo data file for positioning.

This alarm occurs when the servo data set in the NC is numerically abnormal or cannot be received by the servo processor.

Occurrence of this alarm during maintenance service shows that there is an incompatibility between the servo data file and software for positioning function.

[Index] AXIS

[Character-string] None

[Code] Internal address in the servo data area

- 30-> Number of positioning points
- 32-> Torque limit value for unclamp/clamp operation
- 34 -> Acceleration coefficient
- 36-> Deceleration time
- 38-> Positioning speed (high-speed)
- 3A-> Positioning speed (low-speed)
- 3C-> In-position answer output coefficient 1
- 3E-> In-position answer output coefficient 2
- 100-> Interval timer for positioning command reception
- 104-> Unclamp timer
- 108-> Droop
- 10C-> Encoder zero offset
- 114-> Maximum value of in-position answer output command
- 118-> Unclamp check time
- 11C-> Clamp check time
- 120-> IN-P width
- 200-3FC-> Corresponds to the index positions, point numbers from 1 to 128.

The table below shows the correspondence between point numbers and codes assuming that the code is XYZ.

When X = 2, the value determined by YZ shows the point number.

When X = 3, the value obtained by adding 64 to the value determined by YZ shows the point number.

[Probable Faulty Locations]

- 1) The address data indicated in the alarm data is larger than the allowable limit or wrong.
- 2) SVP hardware or software conditions were not met, which made it impossible to start the SVP.

[Index] AXIS

[Character-string] None

[Code] XYYZZZZ

- X = 1-> Hardware conditions are not met.
- YY= 1-> The SVP board is not mounted.
- ZZZZ = 0000
- YY= 2-> The SVP is in abnormal status.
- ZZZZ -> SVP status
- YY= 3-> Abnormality has occurred in the system bus related to the SVP hardware.
- ZZZZ -> System bus status
- X = 2-> SVP data conditions are not met.
- YY= 1-> Synchronous signal number is wrongly selected.
- ZZZZ -> Selected synchronous signal number
- YY= 2-> Synchronous shift time is wrongly designated.
- ZZZZ-> Designated synchronous shift time
- X = 3-> Software conditions are not met.
- YY= 1-> SVP software is not installed.
- ZZZZ = 0000
- YY= 2-> Servo parameters are not installed.
- ZZZZ = 0000

[Probable Faulty Locations]

- 1) SVP hardware of the problem axis
- 2) Control software such as that for NC
- 3) NC specifications

★ 0981 **SVP LE sum check error**

A sum check error occurred in the communication data sent from LE (linear encoder).

[Index] AXIS

[Character-string] None

[Probable Faulty Locations]

- 1) Contact failure or disconnection in LE transmission cable
- 2) Faulty PCB in LE slider

[Measures to Take]

- 1) Check the cables and connectors, and repair or replace them if defective.
- 2) Change the slider.

★ 0982 **SVP LE data error**

The linear encoder generated an alarm. This alarm mainly indicates the abnormal amplitude of internal signal waveform.

[Index] AXIS

[Character-string] None

[Probable Faulty Locations] Damaged PCB or LED in the slider

[Measures to Take] Change the slider.

★ 0983 **SVP LE incre. abso. error**

The 80 MUm-division incremental APA data does not match the 2 mm & 80 MUm-division absolute APA data.

[Index] AXIS

[Character-string] None

[Probable Faulty Locations]

- 1) Faulty PCB in the slider
- 2) Soiled main scale, low air supply pressure to the main scale unit, defective or broken air piping, clogged air filter, or contaminated air
- 3) Condensation in the main scale unit

[Measures to Take]

- 1) Change the slider.
- 2) Check the air supply pressure and piping connections. Change the air filter. Wipe the main scale glass surface.
- 3) After checking the air supply pressure, wait for about three [min] before resupplying the power.

★ 0984 **SVP LE comparator AD error**

The 80 MUm-division comparator output does not match the A/D converter value.

[Index] AXIS

[Character-string] None

[Probable Faulty Locations]

- 1) Faulty PCB in the slider
- 2) Soiled main scale, low air supply pressure to the main scale unit, broken air piping, clogged air filter, or contaminated air
- 3) Condensation in the main scale unit



[Measures to Take]

- 1) Change the slider.
- 2) Check the air supply pressure and piping connections. Change the air filter. Wipe the main scale glass surface.
- 3) After checking the air supply pressure, wait for about three [min] before resupplying the power.

**★ 0985 SVP LE face rotation error**

The slider made an in-plane rotation and exceeded the allowable limit for scale matching.

[Index] AXIS

[Character-string] None

[Probable Faulty Locations]

Large pitching of the LE-mounted table caused the LE to exceed the scale matching limit. Or, the LE is mounted with deviation in the pitching direction.

[Measures to Take]

Check the table pitching amount and LE slider mounted condition.

**★ 0986 SVP LE initial transfer data error**

An error occurred in the data initially transferred from LE with the power on.

[Index] AXIS

[Character-string] None

[Probable Faulty Locations]

- 1) Faulty LE cable, disengaged connectors
- 2) Contact failure in cable, loose connectors (Transmission failed during data transmission.)
- 3) LE version does not agree with SVP control software.(Code:16)

**★ 0987 SVP LE application error**

The connected optical linear encoder is of an inapplicable type.

[Index] AXIS

[Code] XXXXXXXX

XXXXXXXX:->Connected optical linear encoder type

**★ 0988 DNC-DT preload task start error**

The preload task was not normally started.

[Index] None

[Character-string] None

[Code]

- 0011: Already started (started twice)
- 100E: Wrong start parameter
- 993: Faulty TCP/IP board
- TCP/IP board has a failure.

[Index] None

[Character-string] None

[Code]

- 1-> TCP/UP board has not been completely initialized.
- 2-> TCP/IP board system has not been ready to operate.

[Probable Faulty Locations] Faulty TCP/IP board hardware

★ 0989 CPU information table data unsuitable

The CPU information table contains a value exceeding the setting range.

[Index] None

[Character-string] None

[Code] XXYYZZZZ

XX: Main processor number that detected the error

1-> Main board No. 1

2-> Main board No. 2

3-> Main board No. 3

4-> Main board No. 4

5-> Main board No. 5

6-> Main board No. 6

YY:

1-> Application information No. 1 table

2-> Application information No. 2 table

3-> Application information No. 3 table

4-> Application information No. 4 table

5-> Application information No. 5 table

ZZZZ:->Table index value

★ 0990 TASK generate error

The NC failed to create a task.

[Index] None

[Character-string] 'ABBBB'

A = 1 to 7 Main board number which detected this alarm

= B The FCP board detected this alarm.

BBBB= Task name

[Code] XXXXYYYYY

XXXX:->ID of failed task

YYYY:

1-> Task ID error (The objective task is already present.)

2-> No TCB range (The number of tasks exceeded 16.)

★ 0991 TASK information table data unsuitable

The task information table number is 0.

[Index] None

[Character-string] None

[Code] XXYYZZZZ

XX: Main processor number that detected the error

1-> Main board No. 1

2-> Main board No. 2

3-> Main board No. 3

4-> Main board No. 4

5-> Main board No. 5

6-> Main board No. 6

YY:

1-> Application information No. 1 table

2-> Application information No. 2 table

- 3-> Application information No. 3 table
- 4-> Application information No. 4 table
- 5-> Application information No. 5 table
- ZZZZ:->Table index value

**★ 0992 PLC backup data file read**

The PLC backup data or M code data file cannot be read from the memory.

[Index] None

[Character-string] None

20001:The M code data file is not found or a wrong file name is specified.

20002:The M code data file cannot be opened.

`30001`= The head of logic table data file is not PBU1.

`30002`= An error occurred in reading the logic table data file.

[Code]

None->M code data file error

1-> The PLC backup file is not found or a wrong file name is specified.

2-> The PLC backup file cannot be opened.

When the character-string is 30001 or 30002, it shows the kind of the logic table.

1= Logic table file for ATC (FR2H: PLTUA01-MA\*.CNS)

2= Logic table file for APC (FR2H: PLTUA01-MB\*.CNS)

3= Logic table file for AAC (FR2H: PLTUA01-MC\*.CNS)

4= Logic table file for ATC (FR2H: PLTUA02-MA\*.CNS)

5= Logic table file for APC (FR2H: PLTUA02-MB\*.CNS)

6= Logic table file for AAC (FR2H: PLTUA02-MC\*.CNS)

7= Logic table file for ATC (FR2H: PLTUA03-MA\*.LOB)

8= Logic table file for APC (FR2H: PLTUA03-MB\*.LOB)

9= Logic table file for AAC (FR2H: PLTUA03-MC\*.LOB)

[Probable Faulty Locations]

- 1) If the alarm occurred during normal NC operation, the file has been deleted or its data has been destroyed.
- 2) If the alarm occurred without NC operation after installation of control software, the file type was wrong or no such file was stored in the memory.

[Measures to Take]

- 1) In the case of the above 1), reinstall the control software.
- 2) In the case of the above 2), check the control floppy disk data (such as file name) and recreate the floppy disk.

[Related Specifications] PLC specification

**★ 0993 TCP/IP board error**

An error occurred on TCP/IP board.

[Index] None

[Character-string] None

[Code]

=1-> Initialization of TCP/IP board is not completed.

=2-> Preparation for system operation of TCP/IP board is not completed.

**★ 0994 TCP/IP configuration file error**

The TCP/IP configuration file includes an error.

[Index] None

[Character-string] None

[Code]

- =1: Configuration file (MD0: ADAPTCNTRL.SY3) not found
- =2: Configuration file attribute error
- =3: Configuration file opening error
- =4: Wrong IP address specified at destination station
- =5: Wrong port number specified at destination station
- =6: Wrong port number specified at sending station
- =7: Logging ON/OFF setting error
- =8: Wrong IP address specified at sending station
- =9: Network mask designation error
- =10: Broadcast address designation error
- =B: Use or nonuse of the running file name is wrongly specified.  
The following are the error codes used for TCP/IP driver.
- =C: Sector device designation error
- =D: Sector device not set
- =E: Descriptor error
- =F: Parameter setting error
- =2E: Specified configuration file not found
- =2F: Configuration file opening error
- =30: Configuration file closing error
- =31: Configuration file reading error
- =32: No data in configuration file
- =33: IP address error
- =34: No IP address

**★ 0995 Machine axis data file**

The axis control constant data does not match the actual machine axes (such as magazine axis).

[Index] None

[Character-string] Machine axis name

[Code]

- 1-> An axis name in the data downloaded from the machine axis data file does not correspond to the name of axis actually mounted.

[Probable Faulty Locations]

- 1) Defective creation of the machine axis data file
- 2) Data input error in creation of the control software

**★ 0996 PLC axis data file**

The PLC axis control constants do not match the machine specifications.

[Index] None

[Character-string] PLC axis name

[Code]

- 1-> The axis names downloaded from PLC axis data file do not match the actually mounted axis names.
- 2-> The file type is not "PBU1".
- 3-> The file has too large DB.
- 4-> The specification data in the PLC axis data file is different from that in the SVP data file.
- 5-> Memory location table of the axis backup data of the PLC axis data file is not found.
- 6-> Memory location table of the axis parameters of the PLC axis data file is not found.

- 7-> An error occurred when opening the PLC axis data file.  
File is short. File name or device name is incorrect.
- 8-> Although the axis name in the PLC axis data file is the Okuma specification name, it differs from the registered name.
- 9-> PLC axis data file is too small.
- 15-> For OSP7030 / OSP730, the number of PLC axes exceeds 8.
- 16-> For OSP7030 / OSP730, a PLC axis number exceeds 8.
- 17-> For OSP7030 / OSP730, the rotary axis gear transmission ratio of the master axis is 0 although the axis changeover specification (function generation specification B bit 0) is set.
- 18-> For OSP7030 / OSP730, the rotary axis gear transmission ratio of the slave axis is 0 although the axis changeover specification (function generation specification B bit 0) is set.
- 19-> For OSP7030 / OSP730, pitch data of the master axis is 0 although the axis changeover specification (function generation specification B bit 0) is set.
- 1A-> For OSP7030 / OSP730, pitch data of the slave axis is 0 although the axis changeover specification (function generation specification B bit 0) is set.
- 1B-> For OSP7030 / OSP730, the rotary axis specification (servo data file) is not set although the point positioning specification(function generation specification B bit 6) is set.
- 1C-> For OSP7030 / OSP730, the linear axis specification (servo data file) is not set although the arbitrary positioning specification (function generation specification B bit 7) is set.
- 1D-> For OSP7030 / OSP730, the master axis of the axes with an independent position sensor is not found, or the master axis is not set.
- 1E-> For OSP7030 / OSP730, multiple axes are specified as the master axis of the axes with an independent position sensor.
- 1F-> For OSP7030 / OSP730, detected speed of the axis with an independent position sensor is 0. This data is set by MCS when the power is turned on.
- 20-> For OSP7030 / OSP730, the rotary axis gear transmission ratio (EQDGT) or the convert factor (ESRDGT) of the axis with an independent position sensor is not set. (setting value: 0)
- 21-> The axis changeover code and the table changeover code were specified at the same time with OSP7030/OSP730.

[Probable Faulty Locations]

Error in creation of PLC axis data file

- 21-> Power is shut off during axis changeover control.

★ 0997 **PLC monitor backup data file read**

The backup data for PLC monitor cannot be read from the memory.

[Index] None

[Character-string] None

[Code]

- 1-> The file is not found or its name is wrong.
- 2-> The file cannot be opened.
- 3-> The file cannot be read (no file data or any other reason).
- 4-> A file other than backup file was specified.
- 5-> The file cannot be closed.
- 6-> Smaller file size
- 7-> Larger file size

[Probable Faulty Locations]

- 1) If the alarm occurred during normal NC operation, the backup data file has been deleted or its data has been destroyed.
- 2) If the alarm occurred without NC operation after installation of control software, the file type was wrong or no such file was stored in the memory.

[Measures to Take]

- 1) In the case of the above 1), reinstall the control software.
- 2) In the case of the above 2), check the control floppy disk data (such as file name) and recreate the floppy disk.

[Related Specifications] PLC specification

**★ 0998 PLC sequence program load**

Loading the PLC sequence program file failed.

[Index] None

[Character-string] None

[Code] XXXX

- 1-> The file ended before the NC loads any character.
- 3-> The file ended while it is being loaded.
- 9-> Device name is wrongly specified.
- A-> File name is wrongly specified.
- B-> The program file is not found.
- 100-> PLC machine type is wrong.
- 200-> PLC class is different.
- 300-> file version is wrong.

[Measures to Take] Consult the machine maker.

**★ 0999 Synchronous tap's data file read**

The synchronous tapping data file cannot be read.

[Index] None

[Character-string] None

[Code] YYYYY

- X= 1-> The required file was not found.
- X= 2-> An error occurred during file loading.
- YYYY= 0001->The file ended without loading even a character.
- YYYY= 0002->The file ended during file loading.

## SECTION 4 ALARM A

Alarm No.	Alarm Message
1000	SVP start conditions uncertain
1001	SVP processing trouble
1002	SVP CON APA deviation
1003	SVP error
1004	SVP exception processing
1005	SVP APA pattern data
1006	SVP APA speed
1007	SVP CON speed
1008	SVP DIFF over
1009	SVP servo amp
1010	SVP APA check data
1011	SVP speed command over
1012	SVP servo data setting
1013	SVP belt is broken
1014	SVP F-TYPE encoder error
1015	SVP full closed loop error
1016	SVP F-TYPE encoder with shaft error
1017	SVP F with shaft APA pattern data
1018	SVP cannot plant error offset data
1019	SVP encoder application (MOTOR SHAFT)
1020	SVP encoder application (WITH SHAFT)
1021	SVP collision detection
1022	SVP SA overload
1023	SVP SA communication error
1024	SVP SA version error
1025	SVP SA motor current overload
1026	SVP SA inverter bridge short circuit
1027	SVP SA overheating
1028	SVP SA power circuit overvoltage
1029	SVP SA power circuit low voltage
1030	SVP SA regenerative resistor overheat
1031	SVP control circuit power voltage
1032	SVP SA error
1033	SVP board version error
1034	SVP control error
1035	VAC communication alarm
1036	VAC self-diagnostics error
1037	VAC position control switch
1038	VAC alarm number; error
1039	VAC pulse generator count error
1040	VAC motor acceleration rate

Alarm No.	Alarm Message
1041	VAC APA speed
1042	VAC CON speed
1043	VAC DIFF over
1044	VAC resolver error
1045	VAC RAM parity error
1046	VAC communication error
1047	VAC instruction (command)
1048	VAC motor cable overcurrent
1049	VAC inverter bridge short circuit
1050	VAC regeneration transistor short
1051	VAC power circuit overvoltage
1052	VAC input voltage drop
1053	VAC phase defect
1054	VAC arithmetic unit volt drop
1055	VAC power circuit low voltage
1056	VAC interval loop error
1057	VAC motor overload
1058	VAC heat sink overload
1059	VAC VAC data setting
1060	VAC VAC motor internal speed command over
1061	VAC magnetic pulse generator
1062	VAC pulse generator rotation marker data
1063	VAC cycle overflow error
1064	VAC watchdog error
1065	VAC analog-to-digital access alarm
1066	VAC master CPU error
1067	VAC slave CPU error
1068	VAC speed deviation too large
1069	VAC coil switch
1070	VAC RAM error
1071	Memory board / battery hurry exchange
1072	SVP INDEXING high-speed indexing over
1073	SVP INDEXING low-speed indexing over
1074	SVP INDEXING unclamp time over
1075	SVP INDEXING clamp time over
1076	SVP INDEXING positioning direction
1077	SVP INDEXING incorrect command
1078	SVP INDEXING servo data setting
1080	VAC high speed motor parameter setting
1082	SVP LE sum check error
1083	SVP LE data error
1084	SVP LE incre. abso. error
1085	SVP LE comparator AD error



Alarm No.	Alarm Message
1086	SVP LE face rotation error
1087	SVP LE initial transfer data error
1088	SVP LE application error
1089	PLC alarm No. illegal
1090	VAC master CPU down
1091	PLC alarm message file not load
1092	PLC backup data file write
1093	PLC backup data file not load
1094	PLC backup data file read
1097	Safety speed monitor error
1104	DeviceNet slave idle mode
1150	MCS Undefined alarm number
1151	MCS Exception processing
1152	MCS Processing trouble
1153	MCS CON APA deviation
1154	MCS Power-Supply-Unit Error
1155	MCS Converter-link error
1156	MCS DC-bus voltage alarm
1157	MCS Motor over current
1158	MCS Power unit over heat
1159	MCS Power unit over load
1160	MCS Supply voltage flutter
1161	MCS Power unit version error
1162	MCS Winding-change failed
1163	MCS Encoder-link error
1164	MCS Encoder error
1165	MCS Encoder initialize failed
1166	MCS Encoder with shaft error
1167	MCS Encoder with shaft initial
1168	MCS ABSO SCALE error
1169	MCS ABSO SCALE initialize
1170	MCS Magnetic encoder alarm
1171	MCS Resolver alarm
1172	MCS Pulse generator count over
1173	MCS Motor over heat
1174	MCS Servo-link error
1175	MCS Servo-link disconnect
1176	MCS Servo-link protocol error
1177	MCS Servo data error
1178	MCS Illegal command
1179	MCS CON speed over
1180	MCS Speed command over
1181	MCS DIFF over

Alarm No.	Alarm Message
1182	MCS APA speed over
1183	MCS Full-closed APA error
1184	MCS Over speed
1185	MCS Velocity deviation over
1186	MCS Collision detected
1187	MCS Urgent-stop time over
1188	MCS Belt is broken
1189	MCS Axis change control error
1190	MCS independent encoder init
1191	MCS APA error
1192	MCS Motor over load
1200	APA BCD data
1201	Plus travel limit over
1202	Minus travel limit over
1203	Barrier
1204	Spindle drive unit
1205	Spindle MS OFF
1206	Spindle drive motor overload
1207	Spindle speed over
1208	Hydraulic pump motor overload
1209	Hydraulic pressure
1210	Hydraulic balancer pressure
1211	Spindlehead lube motor overload
1212	Spindle lube motor OFF
1213	Axis drive motor overload
1214	Axis interlock
1215	Spindle rotation interlock
1216	No spindle gear change confirmation
1217	Travel limit over
1218	Coolant motor overload
1219	Axis lube motor overload
1220	Active tool NG3
1221	Carrier system checking
1222	Magazine system checking
1223	Axis drive unit
1224	Sequence count over
1225	No S command
1226	Gear change disable
1227	Home position command strobe
1228	Inductosyn power unit
1229	Spindle orientation motor overload
1230	Spindle speed change gear shift motor overload
1231	Spindlehead lubricant return pump motor overload

Alarm No.	Alarm Message
1232	Spindlehead lubricant level
1233	Spindlehead lubricant pressure supply low
1234	CA axis travel limit over
1235	Hydraulic unit preparation completion
1236	Hydraulic unit pressure low
1237	Hydraulic unit oil level low
1238	Spindlehead lube oil level low
1239	Attached unit error 1
1240	Oil-hole motor overload
1241	Thru-the-tool coolant filter
1242	Spindle overload
1243	CON 0 pass
1244	User reserve code
1245	Pallet check NG
1246	Synchronous error limit over
1247	Quill safety bolt unusual
1248	MSB reserved
1249	Stroke end limit reset
1250	Spindle wiring change impossible
1251	Clamp IN-P
1252	CRP exception
1253	Panel/CRP receive
1254	CRP diagnosis
1255	Outside
1256	CRP parity error
1257	Emergency stop
1258	Door open confirmation
1259	Excessive deviation velocity
1260	Air pressure low
1261	Oil-air lube motor overload
1262	Oil-air lube
1263	Oil-air lube level low
1264	Mist air lube unit
1265	Hydraulic unit
1266	Tolerance control error
1267	Fieldnet communication
1268	Spindle revolution condition error
1269	Spindle air curtain pressure low
1270	VAC operation command mismatch with conditions
1271	Interference
1272	Thermal deviation compensation
1273	Attachment Index Limit
1274	Compressor Breakdown

Alarm No.	Alarm Message
1275	VAC master CPU down
1276	Door interlock reset
1277	Door interlock
1278	Door open/close limit switch N.G.
1279	Axis movement prohibition
1280	Axis change control unusual
1288	Conflict emergency stop
1289	Tool breakage detection undertravel
1290	Tool breakage
1291	B position error
1292	Work clamp miss
1293	Adaptive control communication error
1294	Shift value error
1295	Tailstock quill over advance
1296	Tailstock quill condition
1297	Chuck condition
1298	Robot / Loader escape position
1299	Axis overload
1300	Fixed cycle Thread feed
1301	External rotary table error
1302	Cycle time over
1303	SPM Data transfer
1304	SPM Undefined error information
1305	SPM Control error
1306	Door close/open answer
1307	Thermal deviation compensation
1308	Limit Switch error
1309	Vacuum system abnormal
1310	Sub program select
1311	Super Hi-NC Control cannot execute
1312	Safety Speed over
1313	Safety speed monitor error
1314	Hi-CUT Pro 2 Control cannot execute
1315	Touch probe Conflict prevention
1316	Servo data error
1317	Axis oscillation command stroke over
1318	Axis oscillation CON speed over
1319	DIFF over
1326	Abnormal temperature rise
1701	Emergency stop
1702	Axis motor overload
1703	Axis interlock
1704	Stroke end over

Alarm No.	Alarm Message
1705	Sequencer counter over
1706	Spindle over-speed
1707	Spindle rotation interlock
1708	Magazine system being checked
1709	Outside
1710	Excessive speed deviation
1711	Air pressure drop
1712	Travel end limit release
1713	Axis change control error
1714	VAC not ready
1715	Coolant low level
1716	Thru-the-tool coolant filter clog
1717	Parameter transfer error
1718	Hydraulic motor overload
1719	Control circuit breaker
1720	Transformer overheat
1721	Power ON/OFF sequence error
1722	Door interlock reset
1723	Door interlock
1724	Door open/close limit N.G.
1725	Door open confirmation
1726	Spindle overload
1727	PLC system error
1728	Oil air lube
1729	PLC data file
1730	Cycle time over
1731	Work clamp miss
1732	Machine axis travel limit over
1733	PLC system data
1734	Sequence counter over
1735	Hydraulic unit oil level low
1736	Spindlehead libe motor overload
1737	Spindlehead libe oil level low
1738	Door open/close answer
1739	Compressor breakdown
1740	Hydraulic pressure drop
1741	Tailstock advance limit
1742	Tailstock condition
1743	Coolant unit
1744	Robot/Loader condition
1745	Locking switch N.G.
1746	Mist air lube unit
1748	Attachment index limit

Alarm No.	Alarm Message
1749	Faulty mode switch
1750	Spindlehead lubricant return motor
1751	Spindlehead lubricant level
1752	Spindlehead lubricant pressure low
1753	Spindle air curtain pressure low
1754	Inductosyn power unit
1755	Spindle lube level low
1756	Sitting abnormal
1757	Tool clamp unit error

★ 1000 SVP start conditions uncertain

SVP hardware or software conditions were not met, which made it impossible to start up the SVP.

[Index] AXIS

[Code] XYYZZZZ

X=1-> Hardware-related conditions are not met.

YY=1->The SVP board is not mounted.

ZZZZ=0000

YY=2->The SVP is in abnormal status.

ZZZZSVP status

YY=3->The system bus related to the SVP hardware is in abnormal status.

ZZZZ:System bus status

X=2-> SVP data conditions are not met.

YY=1->Wrong synchronous signal number is selected.

ZZZZ:Selected synchronous signal number

YY=2->Synchronous shift time is wrongly designated.

ZZZZ:Designated synchronous shift time

X=3-> Software-related conditions are not met.

YY=1->The SVP software is not installed.

ZZZZ=0000

YY=2->Servo parameters are not installed.

ZZZZ=0000

[Probable Faulty Locations]

- 1) SVP hardware of the problem axis
- 2) Control software such as that for NC
- 3) NC specifications

★ 1001 SVP processing trouble

The SVP is in the trouble indicated by the following codes.

[Index] AXIS

[Code] XYYZZZZ

X=1-> Internal error

The SVP has caused either parity loop error or protect error.

YY-> Internal error status

ZZZZ:Two high-order bytes of the SVP system address in trouble

X=2-> Time out

The SVP does not send any response within 20[s] at the time of start up. Minute investigation should be made to locate the cause.

Since the SVP cannot detect the start up signal, it cannot execute the start up sequence.

YY=00

ZZZZ=000000

X=3-> Double bus error

During bus error exception processing by SVP, a bus error has occurred again. The SVP hardware will probably be defective.

YY:System bus status

ZZZZ=000000

X=4-> SVP command execution

The SVP has obtained wrong diagnostic results of CPU command execution. The CPU will probably be defective.

YY:Diagnostic results

ZZZZ=000000

X=5->SVP trouble detected by the control software such as that for NC. Some trouble has occurred in the SVP.

[Probable Faulty Locations]

- 1) SVP hardware of the problem axis
- 2) SVP software of the problem axis
- 3) Control software such as that for NC

**★ 1002 SVP CON APA deviation**

Deviation between CON and APA has exceeded the preset limit.

The deviation can be obtained by the formula: [Calculated value written in SVP] - [Actual position read from SVP].

This value is monitored by the control software such as that for NC.

The SVP usually monitors DIFF. However, when the SVP becomes unable to monitor DIFF due to fatal abnormality, this monitoring function will prevent the system overrun.

[Index] AXIS

[Code] Absolute deviation value in hexadecimal [reference unit]

[Probable Faulty Locations] SVP of the problem axis

**★ 1003 SVP error**

The control software such as that for NC has detected a system alarm signal sent from the SVP hardware. For details, refer to the specification for the mounted SVP version.

[Index] AXIS

[Character-string] None

[Code] \*??##&&

\* -> Axis number of which SVP board's CPU has caused the error (If 2, the problem SVP board is that for the 2nd axis.)

?? -> Board status in hexadecimal

bit7bit6bit5bit4bit3bit2 bit1 bit0  
RUNHALTCPUOFF000 SNMI MSTP

## -> Bus error status in hexadecimal

bit7bit6bit5bit4bit3bit2 bit1 bit0  
SBERSBPARCYCER0PROTDAILOOPECC

&& -> Always 00

[Probable Faulty Locations]

- 1) Hardware defect of the SVP board indicated with the code \*
- 2) Software defect

**★ 1004 SVP exception processing**

Fatal abnormality has occurred in processing by SVP software.

[Index] AXIS

[Character-string] Detected error factor

- # 1-> Bus error
- # 2-> Address error
- # 3-> Illegal instruction error
- # 4-> Zero divide error
- # 5-> CHK instruction error
- # 6-> TRAPV instruction error
- # 7-> >Privilege violation error
- # 8-> Trace error



- # 9-> Line 1010 emulator error
- #10-> Line 1111 emulator error
- #11-> Unused area error
- #12-> Coprocessor illegal protocol error
- #13-> Format error
- #14-> Uninitialized interrupt error
- #15-> Spurious interrupt error
- #16-> Interrupt error
- #17-> INT7 error
- #18-> Debugger interrupt alarm
- #19-> INT2 loop error
- #20-> INT5 loop error
- #21-> Speed command calculation delay alarm
- #22-> TRAP error
- #23-> Floating-point coprocessor error
- #24-> PMMU error
- #25-> User interrupt error
- #26-> Board version error
- #27-> Memory test error

[Code]

The CPU program counter value is displayed except when the following character-strings appear.

With #26, the SVP hardware ID number is displayed as a code.

With #27, the memory address at the time of abnormality detection is displayed as a code.

[Probable Faulty Locations]

- 1) SVP board
- 2) SVP software

#### ★ 1005 SVP APA pattern data

The SVP has successively detected wrong patterns of positional data sent from the position encoder.

Ex. Displayed [Code] 8000

Conversion into the octal number

8000(hexadecimal number)->100000 (octal number) Since the E8 unit reads up to 5 digits and ignores the sixth digit, all the digits become 0, causing the OSP to judge that no data is output from the encoder.

[Index]AXIS

[Code]Pattern of the read positional data(APA high-order digit)

[Probable Faulty Locations]

- 1) Position encoder of the problem axis
- 2) SVP hardware of the problem axis
- 3) Timing signal from the NC unit

#### ★ 1006 SVP APA speed

The position encoder value (RAPA) changes according to the motor speed. The NC checks the variation of position encoder values at regular intervals. If the feedrate of each axis is abnormally high compared with the normal rapid traverse rate, or the value changes in abnormal manner due to malfunction of the position encoder, the variation per unit time exceeds a fixed allowable limit, causing this alarm.

[Index] AXIS

[Code] Variation of the position encoder values in hexadecimal [encoder unit /3.2ms]

However, the following codes represents special meanings.

FFFFFFFF-> The variation has exceeded the linear axis stroke.

FFFFFFFE-> The variation has exceeded the rotary axis stroke (360-deg), or the positional data of the infinite axis has changed to a negative value.

FFFFFFFD-> The variation has exceeded the infinite axis stroke.

[Probable Faulty Locations]

- 1) Position encoder of the problem axis or the cables connected with the encoder.
- 2) Motor for driving the problem axis
- 3) Drive unit of the problem axis
- 4) SVP hardware of the problem axis

#### ★ 1007 SVP CON speed

When the axis is in the target position or at a standstill, the target value, operation value, and actual position data are the same. With designation of an axis moving command, the NC starts calculating the path to the target position, thus creating operation values (RCON). The NC then monitors the variation of the operation values at regular intervals. If the value changes in abnormal manner for some reason exceeding the allowable limit, this alarm occurs.

[Index] AXIS

[Code] Absolute feedrate command value in hexadecimal [encoder unit/feedrate control time]

However, the following codes represents special meanings:

FFFFFFFF-> The NC violates the protocol (time limit).

FFFFFFFE-> The feedrate command values is larger than the over alarm level or the alarm detection level.

FFFFFFFC-> The SVP internal command position exceeds the encoder division stroke.

[Probable Faulty Locations]

- 1) Servo parameter of the problem axis
- 2) Control software such as that for NC
- 3) SVP hardware of the problem axis
- 4) Excessively high feedrate (except G00)

#### ★ 1008 SVP DIFF over

When the axis is in the target position or at a standstill, the target value, operation value, and actual position data are the same. With designation of an axis moving command, the NC starts calculating the path to the target position, thus creating operation values (RCON). This time, the actual position data follows the operation values with a certain delay. This delay amount obtained by subtracting [actual position] from [operation value] is termed following error. If the following error exceeds the allowable limit, this alarm occurs.

[Index] AXIS

[Code] Absolute DIFF value in hexadecimal [encoder unit]

[Probable Faulty Locations]

- 1) Mechanical trouble of ball screw, bearing or any other parts, which makes the axis movement heavy
- 2) Encoder, motor or drive unit of the problem axis
- 3) Servo parameters of the problem axis
- 4) SVP hardware of the problem axis

#### ★ 1009 SVP servo amp

Fatal abnormality has occurred in the servo amplifier.

[Index] AXIS

[Code] YYZZ

YY= Internal error status

ZZ= Servo amplifier IF status

[Probable Faulty Locations] Drive unit of the of the problem axis.

★ 1010 SVP APA check data

The high-order digits read from the position encoder do not match the high-order digits obtained by incremental operation.

Ex. Displayed [Code] 14E914A9

When this code is converted into the octal number (by carrying high-order digit for F or E type encoder or carrying octal number for E8 unit), the following result can be obtained.

12351	12251
Encoder digit data	Operation data

Judging from the difference by 1 in the third place\'s number, the third digit or the second digit which generates the carry signal must be showing the cause of this alarm, i.e. phase difference in gear connection.

[Index] AXIS

[Code] YYYYZZZZ

YYYY=Hexadecimal number of the high-order digit read from the encoder

ZZZZ=Hexadecimal number of the high-order digit obtained by calculation from the lower-order digit

[Probable Faulty Locations]

- 1) Position encoder of the problem axis
- 2) SVP board of the problem axis
- 3) Synchronous signals of the system

[Measures to Take]

Convert the code to octal number.

If all the digits are shifted as in 1234523456

-> SVP board is defective.

If the first digit is discrepant as in 1234512344

-> MPR or bearing is defective in most cases.

If this alarm occurs in several axes

-> Synchronous signals of TFP or SVP board are defective

★ 1011 SVP speed command over

The speed command calculated by SVP has successively exceeded the allowable limit. Here, the allowable limit means the speed command over alarm level.

[Index] AXIS

[Code]

Hexadecimal number of the absolute feedrate command value at the time of abnormality detection [encoder unit/feedrate control time]

[Probable Faulty Locations]

Excessive load is applied due to the mechanical reason.

Refer to the cause of SVP DIFF over alarm.

★ 1012 SVP servo data setting

The SVP has received non-applicable servo data. This alarm occurs when an abnormal value is set in the NC as servo data or when the servo processor cannot receive the set data.

Occurrence of this alarm during maintenance service implies that there may be an incompatibility between the servo parameter file and SVP software.

[Index] AXIS

[Code] Servo data number

21-> Kv value

22-> Hardware servo coefficient

23-> Slow up/down coefficient

- 26-> HB control slow up/down coefficient
- 2B-> Inductosyn special pitch
- 39-> Backlash compensation
- 3A-> CON speed limit
- 3B-> Mantissa of speed change ratio (straight line)
- 3C-> Exponent part of speed change ratio (straight line)
- 3D-> Speed change ratio (rotary)
- 41-> V-AMP output filter constant group
- 4F-> New speed detection G1
- 50-> New speed detection G2
- 51-> New speed detection HPF constant
- 52-> New speed detection LPF constant
- 53-> 1st speed acceleration/deceleration constant
- 54-> HB control constant
- 57-> 2nd speed acceleration/deceleration constant
- 58-> Notch filter constant group
- 62-> Encoder accuracy designation
- 71-> Amplifier communication speed
- 86-> DIFF. MIN (DIFF-G variable)
- 87-> DIFF. MAX (DIFF-G variable)
- 88-> ATTF calculation constant
- 89-> Integration limit value
- 100-> FLSUD change timing abnormal
- 101-> 1st speed change timing abnormal
- 102-> 2nd speed change timing abnormal
- 103-> Exp change timing abnormal
- 104-> QITGMD change timing abnormal
- 105-> Wrong interpolation mode
- FFFF-> No authorization
- FFFE-> Infinite/rotary axis
- FFFD-> Infinite axis
- FFFC-> Speed change ratio
- FFFB-> Speed control cycle

[Probable Faulty Locations]

- 1) Servo parameter file of the problem axis
- 2) Control software such as that for NC
- 3) SVP software of the problem axis

**★ 1013 SVP belt is broken**

The SVP has detected breakage of the belt for the belt-driven axis.

[Index] AXIS

[Code] Hexadecimal number of the torque applied at the time of breakage

**★ 1014 SVP F-TYPE encoder error**

Error compensation data for one turn cannot be set in the position encoder.

[Index] AXIS

[Code] The number indicating the setting impossible reason

- 1-> Data read disabled
- 2-> Data check sum error

- 4-> Data overflow
- 5-> Error compensation data does not return to 0.

[Probable Faulty Locations] Position encoder of the problem axis

**★ 1015 SVP full closed loop error**

Deviation between the full-closed loop and semi-closed loop is abnormally large.

[Index] AXIS

[Code] The number of abnormality detection times

[Probable Faulty Locations]

- 1) Separately mounted position encoder or inductosyn of the problem axis
- 2) Excessive lost motion of the problem axis
- 3) Slippage or breakage of the belt on the problem axis
- 4) Coupling compensation is not set or wrong data is set in the problem axis.
- 5) The positional loop gain of the problem axis is not proper (too high).
- 6) Phase shift by collision of the problem axis

**★ 1016 SVP F-TYPE encoder with shaft error**

It is impossible to set the rotation error compensation data of F type position encoder with shaft.

[Index] AXIS

[Code] The number indicating the setting disable reason.

- 1-> Data read disabled
- 2-> Data check sum error
- 4-> Data overflow
- 5-> Error compensation data does not return to 0.

[Probable Faulty Locations] Position encoder of the problem axis

**★ 1017 SVP F with shaft APA pattern data**

The position encoder with shaft has successively read positional data of wrong patterns.

[Index] AXIS

[Code] Pattern of the read positional data(APA high-order digit)

[Probable Faulty Locations]

- 1) Position encoder of the problem axis
- 2) SVP hardware of the problem axis
- 3) Timing signal from the NC unit

**★ 1018 SVP cannot plant error offset data**

When the extended pitch error compensation function is provided, the SVP memory does not have enough capacity for storing the data.

[Index] AXIS

[Probable Faulty Locations]

- 1) SVP board controlling the problem axis
- 2) Extended pitch error compensation file containing extended pitch error compensation data of the problem axis

**★ 1019 SVP encoder application (MOTOR SHAFT)**

The encoder type mounted on the motor does not conform to the encoder accuracy data.

[Index] AXIS

★ 1020 **SVP encoder application (WITH SHAFT)**

The encoder type mounted on the shaft does not conform to the encoder accuracy data.

[Index] AXIS

★ 1021 **SVP collision detection**

The SVP has detected collision of the driving unit with something.

[Index]AXIS

[Code]YYYYZZZZ

YYYY:Average motor output torque

ZZZZ:Average motor acceleration

★ 1022 **SVP SA overload**

The servo amplifier has overheated exceeding the protection curve set in the SVP control software.

[Index] AXIS

[Code] YYYYZZZZ

YYYY:Set value of the protection curve used for overload detection

ZZZZ:Detected value [n] at overload detection

[Probable Faulty Locations] Servo amplifier of the problem axis

★ 1023 **SVP SA communication error**

Abnormality has occurred in communication between SVP and servo amplifier.

[Index]AXIS

[Code]Cause indication number

1-> Parity error in SVP

2-> The sent data does not match the received data.

3-> Servo amplifier ID is not properly received.

4-> No signal is sent from the servo amplifier

5-> Parity error has occurred in servo amplifier.

[Probable Faulty Locations] Servo amplifier of the problem axis

★ 1024 **SVP SA version error**

Version check by the amplifier version control function proved that the mounted servo amplifier version is newer than the versions applicable to the SVP software.

[Index]AXIS

[Code]Version data

1000000-> BLII-D is mounted though BL-D is required.

XXYYZZ:

XX:SVP version

YY:Servo amplifier version applicable to SVP

ZZ:Servo amplifier version

[Probable Faulty Locations]

1-> Servo amplifier of the problem axis

2-> A wrong version of servo amplifier was mounted.

★ 1025 **SVP SA motor current overload**

The servo amplifier has detected an excessive current flow in the motor cables. A warning lamp IOCM on the servo amplifier is lit.

[Index]AXIS

[Probable Faulty Locations] Servo amplifier of the problem axis

★ 1026 **SVP SA inverter bridge short circuit**

The servo amplifier has detected short-circuit of the inverter bridge in the amplifier. A warning lamp IOCS on the servo amplifier is lit.

[Index] AXIS

[Probable Faulty Locations] Servo amplifier of the problem axis

★ 1027 **SVP SA overheating**

The servo amplifier has detected overheating of the amplifier.  
A warning lamp SVTH on the servo amplifier is lit.

[Index]AXIS

[Probable Faulty Locations] Servo amplifier of the problem axis

★ 1028 **SVP SA power circuit overvoltage**

The servo amplifier has detected overvoltage applied to the power circuit of the amplifier. A warning lamp HV on the servo amplifier is lit.

[Index]AXIS

[Probable Faulty Locations] Servo amplifier of the problem axis

★ 1029 **SVP SA power circuit low voltage**

The servo amplifier has detected voltage drop in the amplifier power circuit. A warning lamp LV on the servo amplifier is lit.

[Index] AXIS

[Probable Faulty Locations] Servo amplifier of the problem axis

★ 1030 **SVP SA regenerative resistor overheat**

The servo amplifier has detected excessive power consumption in the regenerative resistance of the amplifier. A warning lamp DROH on the servo amplifier is lit.

[Index]AXIS

[Probable Faulty Locations] Servo amplifier of the problem axis

★ 1031 **SVP control circuit power voltage**

The servo amplifier has detected the abnormal voltage applied to the amplifier control circuit. A warning lamp VR on the servo amplifier is lit.

[Index]AXIS

[Probable Faulty Locations] Servo amplifier of the problem axis

★ 1032 **SVP SA error**

The servo amplifier is in some trouble.

[Index]AXIS

[Probable Faulty Locations] Servo amplifier of the problem axis

★ 1033 **SVP board version error**

The SVP hardware version is wrong.

[Index]AXIS

[Code]

1-> SVP hardware ID is not 1.

[Probable Faulty Locations]

1-> SVP board controlling the problem axis

2-> A wrong version of SVP was mounted.

**★ 1034 SVP control error**

The SVP board is in a trouble related to the axis control.

[Index] AXIS

[Code] Alarm data

25-> Though the emergency stop was attempted by the emergency stop function, APA does not stop within the preset time.

The preset time is the value of QSDWD104.146(S0 @C2) in servo data. If this value is set at 0, the emergency stop should take place within 2000 (2 s).

[Probable Faulty Locations] SVP software controlling the problem axis

**★ 1035 VAC communication alarm**

The communication alarm occurred between high-precision VAC driver and TFP board in the NC unit.

[Code] XXXXYYYY

XXXX: Cause of communication alarm

Bit15->Communication processing from NC to VAC not complete

Bit14->No communication from VAC to NC

Bit13->Communication processing from VAC to NC not complete

Bit12->Defective communication LSI in TFP board

YYYY: Cause of defect in TFP board communication LSI

Bit15->Dual-transmission error

Bit14->Dual-receive error

Bit13->Format error

Bit12->CRC error

Bit11->Parity error

[Probable Faulty Locations]

- 1) VAC3 driver
- 2) TFP board

[Measures to Take] Replace the defective unit.

**★ 1036 VAC self-diagnostics error**

An error in the VAC self-diagnostics data sent from the VAC to the NC

[Code]:FFFFXXXX: The self-diagnostics count data is not updated.

XXXX: indicates the previous count data.

YYYY->The self-diagnostics data is not \$55.

YYYY: indicates the self-diagnostics data when the error is detected.

[Probable Faulty Locations]

VAC board or VAC card

Measures to Take Replace the unit involved with the error.

**★ 1037 VAC position control switch**

When the VAC control mode is switched to the C-axis control mode, the mode is neither the absolute control mode nor the incremental control mode.

[Probable Faulty Locations] VAC board or VAC card

[Measures to Take] Replace the unit involved with the error.

**★ 1038 VAC alarm number; error**

The alarm number, which is sent from the VAC if a VAC alarm occurs, is not correct.



[Code] XX Alarm number sent from the VAC

[Probable Faulty Locations]

VAC board or VAC card

Measures to Take Replace the unit involved with the error.

**★ 1039 VAC pulse generator count error**

One PG(Pulse Generator) revolution count data of the VAC differs from the SYSTEM data.

[Code]XXXXXXXX

XXXX: PBU setting

YYYY: Count data

One PG revolution count data

[Probable Faulty Locations] Magnetic PG or PG gears

[Measures to Take]

- 1) Replace the PG.
- 2) Replace the PG gears.

**★ 1040 VAC motor acceleration rate**

The actual VAC motor speed is excessively high.

[Code]XXXXXXXX:Motor speed when the alarm is detected (4 bytes)

[Probable Faulty Locations]

Defective VAC board or encoder (PG or resolver)

[Measures to Take]

- 1) Replace the VAC board.
- 2) Replace the encoder.
- 3) Check related wiring.

**★ 1041 VAC APA speed**

The actual VAC spindle speed is excessively high.

[Code]XXXXXXXX:Spindle speed when the alarm is detected (4 bytes)

[Probable Faulty Locations] Defective VAC board, card or PG

[Measures to Take]

- 1) Replace the PCB.
- 2) Replace the PG.
- 3) Check related wiring.

**★ 1042 VAC CON speed**

The speed command in the spindle control mode or the feed unit amount in the C-axis control mode is excessively large.

[Code] XXXXXXXX Speed command when the alarm is detected (4 bytes)

-1-> Excessive RCOND

-2-> Calculation of the SRCON is behind the communication timing.

[Probable Faulty Locations] Set feed unit amount.

[Measures to Take]Set a smaller feed unit amount.

**★ 1043 VAC DIFF over**

The DIFF over occurred in the C-axis control mode.

[Code] XXXXXXXX DIFF when the alarm is detected (4 bytes)

[Probable Faulty Locations]

Mechanical factors such as insufficient lubricating oil or mechanical interference

[Measures to Take]

Eliminate mechanical faulty causes to reduce resistance for spindle rotation.

★ 1044 **VAC resolver error**

There is no signal from the resolver.

[Probable Faulty Locations] Faulty resolver, or broken resolver wire

[Measures to Take]

- 1) Replace the resolver.
- 2) Check the resolver signal cable.

★ 1045 **VAC RAM parity error**

Error in RAM read/write.

[Code] The hardware involved with the error

- 1-> VAC board
- 2-> VAC card

[Probable Faulty Locations]

VAC board, or card

Measures to Take Replace the unit involved with the error.

★ 1046 **VAC communication error**

During communication with the NC, communication data is lost or parity error occurred with the communication data.

[Code] XX (1 byte)

- Bit7-> Double-transmission error
- Bit6-> Double-receive error
- Bit5-> Format error
- Bit4-> CRC error
- Bit3-> Parity error
- Bit2-> Wire broken command detection
- Bit1-> Time out error
- Bit0-> Timing error

[Probable Faulty Locations] Axis/M-tool VAC card, VAC card, TFP board, optical cable

[Measures to Take]

- 1) Replace the unit involved with the error.
- 2) Check the communication cable wiring.

★ 1047 **VAC instruction (command)**

During communication with the NC, the instruction sent to the VAC is an undefined command or is not executable.

[Code]XXYYZZZZ

XX:

- 1-> Undefined
- 2-> Mode transfer impossible

YY:

- 1-> Basic command
- 2-> Additional command

ZZZZ: Command transmitted

[Probable Faulty Locations]

- 1) VAC board or VAC card
- 2) Forbidden command is designated.

[Measures to Take] Replace the unit involved with the error.

**★ 1048 VAC motor cable overcurrent**

A temporary overcurrent in the motor cable is detected.

[Probable Faulty Locations]

- 1) Faulty transistor in the VAC driver
- 2) Motor is grounded.

[Measures to Take]

- 1) Replace the VAC driver transistor.
- 2) Replace the faulty motor.

**★ 1049 VAC inverter bridge short circuit**

Short of inverter bridge arm.

[Probable Faulty Locations]

- 1) Faulty VAC driver transistor

[Measures to Take] Replace the faulty VAC driver transistor.

**★ 1050 VAC regeneration transistor short**

Overcurrent in the regeneration main circuit.

[Probable Faulty Locations]

- 1) Faulty VAC driver transistor
- 2) Momentary power failure while the VAC motor is stopped

[Measures to Take] Replace the VAC driver transistor.

**★ 1051 VAC power circuit overvoltage**

Excessively high main circuit DS voltage.

[Probable Faulty Locations] Faulty VAC transistor (regeneration circuit), or faulty VAC board

[Measures to Take]

- 1) Replace the VAC transistor.
- 2) Replace the VAC board.

**★ 1052 VAC input voltage drop**

The 3-phase input voltage is lower than the specified value.

[Probable Faulty Locations] Faulty power supply

[Measures to Take] Allowable power supply range: 200V AC (-10%) to 220V AC (+10%), 50/60 Hz

**★ 1053 VAC phase defect**

One of three AC input phases is lost.

[Probable Faulty Locations] Power failure

**★ 1054 VAC arithmetic unit volt drop**

Supply voltage for the control dropped.

[Probable Faulty Locations] Faulty VAC board

[Measures to Take] Replace the VAC board.

★ 1055 **VAC power circuit low voltage**

DC voltage in the power circuit is not raised.

[Probable Faulty Locations] Faulty VAC driver

[Measures to Take] Replace the VAC driver.

★ 1056 **VAC interval loop error**

An error occurs if interrupt processing cannot be executed correctly.

[Code]XXYY

XX:

Bit5-> INT1 RQ

Bit4-> INT2 RQ

Bit3-> INT3 RQ

Bit2-> INT4 RQ

Bit1-> INT5 RQ

Bit0-> LEVEL 6

Bit5-> INT5

Bit4-> FN INT

Bit3-> MR2 INT

Bit2-> INT2

Bit1-> INT4

Bit0-> INT6

[Probable Faulty Locations] Faulty interrupt circuit in the VAC board or VAC card

[Measures to Take] Replace the unit involved with the error.

★ 1057 **VAC motor overload**

Motor temperature is higher than the specified upper limit value.

[Probable Faulty Locations] Faulty VAC motor fan,Frequent use of CW, CCW, and STOP commands

[Measures to Take]

1-> Replace the VAC motor fan.

2-> Correct the program.

★ 1058 **VAC heat sink overload**

The heat sink temperature is higher than the specified upper limit value.

[Probable Faulty Locations] Faulty VAC driver fan,Frequent use of CW, CCW, and STOP commands

[Measures to Take]

1-> Replace the VAC driver fan.

2-> Correct the program.

★ 1059 **VAC VAC data setting**

An error with the VAC PBU file data or the VAC online change parameter.

[Probable Faulty Locations] VAC PBU file error

[Measures to Take] Correct the PBU file data.

★ 1060 **VAC VAC motor internal speed command over**

Velocity command in the speed control or position control excessively high.

[Code] Speed command when the error is detected

[Probable Faulty Locations]

VAC board, card, or driver (Follow the same procedure as taken when the VAC DIFF over alarm occurred.)

[Measures to Take]

- 1) Replace the unit involved with the error.
- 2) Remove the cause of the machine failure to decrease the spindle rotation load.

**★ 1061 VAC magnetic pulse generator**

An error with the VAC magnetic pulse generator

[Code] XXXXXXXY

XXXX:

- A-> A-phase voltage error (YYYY: A-phase voltage)
- B-> B-phase voltage error (YYYY: B-phase voltage)
- C-> PG data error (YYYY:0)

[Probable Faulty Locations]

Magnetic PG, PG wiring, or large clearance between magnetic PG and PG gears

[Measures to Take]

- 1) Replace the PG.
- 2) Check wiring.

**★ 1062 VAC pulse generator rotation marker data**

The count data, counted until the first marker is detected after the power is turned on, differs from the SYSTEM data.

[Code] XXXXXXXY

XXXX: PBU setting

YYYY: Detected value (The number of PG teeth)\*4-1

[Probable Faulty Locations]

Magnetic PG, PG wiring, or PG gears (Follow the same procedure as taken when the VAC PG count error occurred.)

[Measures to Take]

- 1) Replace the PG.
- 2) Replace the PG gears.
- 3) Check wiring.

**★ 1063 VAC cycle overflow error**

Cycle overflow error

[Code] The code indicates the hardware involved with the error.

- 1-> VAC board
- 2-> VAC card

[Probable Faulty Locations]

VAC board, VAC card, wiring, loose connection

[Measures to Take]

- 1) Replace the unit involved with the error.
- 2) Check wiring and connectors.

**★ 1064 VAC watchdog error**

Watchdog timer is not cleared.

[Probable Faulty Locations] VAC board

[Measures to Take] Replace the unit involved with the error.

★ 1065 **VAC analog-to-digital access alarm**

During A/D conversion, A/D converter is accessed.

[Probable Faulty Locations] A/D converter in the VAC board

[Measures to Take] Replace the VAC board.

★ 1066 **VAC master CPU error**

The CPU error of the VAC board

[Code]

- 1-> Bus error
- 2-> Address error
- 3-> Illegal instruction error
- 4-> Zero divide error
- 5-> CHK instruction error
- 6-> TRAPV instruction error
- 7-> Privilege violation error
- 8-> Trace error
- 9-> Line 1010 emulator error
- 10-> Line 1111 emulator error
- 11-> Unused area
- 12-> Spurious interrupt error
- 13-> INT7 interrupt error
- 14-> Interrupt error
- 15-> TRAP instruction error
- 16-> User interrupt error

[Probable Faulty Locations] VAC board

[Measures to Take] Replace the unit involved with the error.

★ 1067 **VAC slave CPU error**

The CPU error of the VAC card

[Code]

- 1-> Bus error
- 2-> Address error
- 3-> Illegal instruction error
- 4-> Zero divide error
- 5-> CHK instruction error
- 6-> TRAPV instruction error
- 7-> Privilege violation error
- 8-> Trace error
- 9-> Line 1010 emulator error
- 10-> Line 1111 emulator error
- 11-> Unused area
- 12-> Spurious interrupt error
- 13-> INT7 interrupt error
- 14-> Interrupt error
- 15-> TRAP instruction error
- 16-> User interrupt error

[Probable Faulty Locations] VAC card

[Measures to Take] Replace the unit involved with the error.

★ 1068 **VAC speed deviation too large**

The motors speed deviation is excessively large.

[Probable Faulty Locations] The VAC motor does not rotate (mechanical lock), or load is too large.

[Measures to Take]

- 1) Remove the locked state.
- 2) Lower the load.

★ 1069 **VAC coil switch**

The coil switch MS is not turned on.

[Probable Faulty Locations] Faulty magnet switch (for coil switch)

[Measures to Take] Replace the magnet switch.

★ 1070 **VAC RAM error**

The RAM cannot be cleared with the power ON.

[Probable Faulty Locations]

Defective VAC board

Measures to Take Change the above defective unit.

★ 1071 **Memory board / battery hurry exchange**

The battery of memory board has finished its service life.

[Probable Faulty Locations] Battery in the memory board

[Measures to Take] Change the battery in the memory board.

★ 1072 **SVP INDEXING high-speed indexing over**

In high-speed indexing controlled by SVP, the positioning speed has exceeded the preset speed.

[Index] AXIS

★ 1073 **SVP INDEXING low-speed indexing over**

In low-speed indexing controlled by SVP, the positioning speed has exceeded the preset speed.

[Index]AXIS

★ 1074 **SVP INDEXING unclamp time over**

Unclamp operation is disabled or takes time.

[Index] AXIS

[Probable Faulty Locations]

- 1) Maladjustment of the unclamp limit switch
- 2) Low oil pressure
- 3) Malfunction of the solenoid valve

★ 1075 **SVP INDEXING clamp time over**

Clamp operation is disabled or takes time.

[Index] AXIS

[Probable Faulty Locations]

- 1) Maladjustment of the clamp limit switch
- 2) Low oil pressure
- 3) Malfunction of the solenoid valve
- 4) Wrong offset data is set on the position encoder.
- 5) Wrong positional data is set for positioning.

★ 1076 **SVP INDEXING positioning direction**

The direction of rotation for positioning is opposite to the designated direction.

[Index] AXIS

★ 1077 **SVP INDEXING incorrect command**

The NC has given an incorrect command to the positioning unit.

[Index]AXIS

[Probable Faulty Locations]

The turret indexing command value exceeds the maximum number of points.

★ 1078 **SVP INDEXING servo data setting**

Data error in the servo data file for positioning.

This alarm occurs when the servo data set in the NC is numerically abnormal or cannot be received by the servo processor.

Occurrence of this alarm during maintenance service shows that there is an incompatibility between the servo data file and software for positioning function.

[Index]AXIS

[Code]Internal address in the servo data area

- 30-> Number of positioning points
- 32-> Torque limit value for unclamp/clamp operation
- 34-> Acceleration coefficient
- 36-> Deceleration time
- 38-> Positioning speed (high-speed)
- 3A-> Positioning speed (low-speed)
- 3C-> In-position answer output coefficient 1
- 3E-> n-position answer output coefficient 2
- 100-> Interval timer for positioning command reception
- 104-> Unclamp timer
- 108-> Droop
- 10C-> Encoder zero offset
- 114-> Maximum value of in-position answer output command
- 118-> Unclamp check time
- 11C-> Clamp check time
- 120-> IN-P width
- 200-3FC->Corresponds to the index positions, point numbers from 1 to 128.

[Probable Faulty Locations]

- 1) The address data indicated in the alarm data is larger than the allowable limit or wrong.

★ 1080 **VAC high speed motor parameter setting**

For VAC,abnormal data is set at the high speed motor parameters in the PBU file for high-accuracy VAC.

[Probable Faulty Locations] PBU file for high-accuracy VAC

[Measures to Take]

- 1) Check the high speed motor parameter values set in the PBU file for high-accuracy VAC.
- 2) Replace the PBU file for high-accuracy VAC.



★ 1082 **SVP LE sum check error**

A sum check error occurred in communication data sent from an optical linear encoder.

[Index] AXIS

XX: Check sum received from the optical linear encoder on occurrence of this alarm

YY: Check sum calculated by SVP

★ 1083 **SVP LE data error**

The optical linear encoder generated an alarm.

[Index] AXIS

[Code] XXYYYYYYY

XX: Optical linear encoder alarm detected on occurrence of this alarm

YYYYYYY: Position data sent from the optical linear encoder on occurrence of this alarm

★ 1084 **SVP LE incre. abso. error**

An optical linear encoder generated an incre-abso error.

[Index] AXIS

[Code] XXYYYYYYY

XX: Optical linear encoder alarm detected on occurrence of this alarm

YYYYYYY: Position data sent from the optical linear encoder on occurrence of this alarm

★ 1085 **SVP LE comparator AD error**

An optical linear encoder generated an comparator AD error.

[Index] AXIS

[Code] XXYYYYYYY

XX: Optical linear encoder alarm detected on occurrence of this alarm

★ 1086 **SVP LE face rotation error**

An optical linear encoder generated a face rotation error.

[Index] AXIS

[Code] XXYYYYYYY

XX: Optical linear encoder alarm detected on occurrence of this alarm

YYYYYYY: Position data sent from the optical linear encoder on occurrence of this alarm

★ 1087 **SVP LE initial transfer data error**

An error occurred in the initial transfer data from an optical linear encoder.

[Index] AXIS

[Code]

1-> Data reading impossible

2-> Data sum check error

16-> Inapplicable control software version

★ 1088 **SVP LE application error**

The connected linear encoder is of an inapplicable type.

[Index] AXIS

[Code] XXXXXXXXX

XXXXXXXXX: Connected optical linear encoder type

★ 1089 **PLC alarm No. illegal**

The alarm number requested by PLC is out of the setting range.

[Code] YYYY

X: Requested alarm level

A-> Request of alarm A

B-> Request of alarm B

C-> Request of alarm C

D-> Request of alarm D

YYYY: Requested alarm number in hexadecimal

[Measures to Take] Consult the machine maker.

★ 1090 **VAC master CPU down**

The master CPU on the VAC board has stopped. (For the slave CPUs, the stopped state is detected by the alarm "VAC self diagnostic error".) On occurrence of this alarm, the motor stops after free run. To be more specific, the master CPU increases the counter value every 3.2 ms and a slave CPU monitors this counter every 3.2 ms. If this counter stops, the slave CPU causes this alarm.

[Probable Faulty Locations]

Defective VAC card

Defective VAC software

[Measures to Take] Change the unit having the above defective part.

[Related Specifications] High-accuracy VAC

★ 1091 **PLC alarm message file not load**

The PLC alarm message file is not found, disabling normal alarm proces

[Index] None

[Code] PLC alarm message file loading status (hexadecimal)

1-> End of file was received without loading any character.

3-> End of file was received during file loading.

9-> The device name was wrongly specified.

A-> The file name was wrongly specified.

B-> The file was not found.

[Measures to Take] Consult the machine maker.

★ 1092 **PLC backup data file write**

Backup copy onto the PLC backup file was attempted in vain.

[Index] None

[Code] XXXXYYYY

XXXX: Status of backup processing

YYYY: Backup cycle number

[Measures to Take] Consult the machine maker.

★ 1093 **PLC backup data file not load**

The PLC backup data file is not found, disabling backup processing.

[Index] None

[Code] PLC backup data file loading status (hexadecimal)

1-> End of file was received without loading any character.

3-> End of file was received during file loading.

9-> The device name was wrongly specified.

- A-> The file name was wrongly specified.
- B-> The file was not found.
- 100-> Wrong PLC machine type
- 200-> Wrong PLC class
- 300-> Wrong file version

[Measures to Take] Consult the machine maker.

★ 1094 **PLC backup data file read**

It was failed in reading of PLC backup data files.

[Code] XXXX

- 2-> file open errors (file without)
- 3-> file lead errors (data without)
- 4-> file generic errors ('PBU1 not be)
- 5-> file close errors
- 6-> file size errors (file size smallness)
- 7-> file size errors (file size size)
- 100-> A machine type of PLC differs
- 200-> A class of PLC differs
- 300-> Version of files differs

[Measures to Take] It is inquired of machine maker.

★ 1097 **Safety speed monitor error**

The safety speed monitor is faulty.

[Index] None

[Character-string] None

[Code] XY

- =1Y The safety speed monitor that monitors the axis connected to Y-th guard does not operate properly. Or, the monitored speed does not match the NC data.
- =2 The signal in deceleration control mode is not sent from PLC.

[Measures to Take]

- 1Y Check the safety speed monitor (guard signal wires) or replace the monitor.
- 2 Check the PLC program.

★ 1104 **DeviceNet slave idle mode**

The DeviceNet slave entered in idle mode.

[Index] None

[Character-string]

CH\* SC\$

- \*: Channel where an error occurred
- \$: Sequence counter

[Code] XXYYZZZZ

- XX : MacID of the slave where the error occurred
- YY : Error status of the slave identified by XX.
  - 0x00: Normal state or absence of slave
  - 0x46: Double use of MacID
  - 0x48: The device has stopped communication.
  - 0x49: The device ID information does not match the value in the scan list.
  - 0x4D: The data size is different from the set value.

0x4E: No response from the device in connection

0x50: The device is in idle mode.

0x53: An error was received in connection.

0x54: The response time out occurred in connection.

0x56: The device has entered the idle state.

0x5B: Bus OFF

0x5C: Network power supply OFF

(When the alarm has been caused not by the slave but by other reason such as communication delay, XXYY becomes OxFFFF.)

ZZZZ : Scanner error status

bit0: Memory check error (at memory initialization)

bit1: Scan list initialization error

bit2: Scan list matching check error (MacID)

bit3: Scan list matching check error (Input data)

bit4: Scan list matching check error (Output data)

bit5: Double use of MacID

bit6: Status error of network power supply

bit7: Memory parity error

bit8: Input data receiving error (once)

bit9: Input data receiving error (twice in a low)

bit10: Output data sending error (once)

bit11: Output data sending error (twice in a low)

bit12: Slave communication delay (once)

bit13: Slave communication delay (twice in a low)

bit14: Bus OFF

bit15: Diagnostic information access control error

[Probable Faulty Locations]

- Hardware failure
- Software failure

#### ★ 1150 MCS Undefined alarm number

The MCS caused an error related with axis control.

[Index] Axis name or none (spindle)

[Character-string] Alarm number in decimal

[Code] Alarm code

[Probable Faulty Locations]

- Depends on the number indicated in the character-string.  
Inform us of the code and the character string.

#### ★ 1151 MCS Exception processing

A fatal alarm occurred while the MCS inverter unit and MCS software are executing their processing.

[Index] Axis name or none (spindle)

[Character-string] Cause of alarm detected

"#1"-> Control board error

"#2"-> Voltage drop of +-12 V battery for control board

"#3"-> OPF error

"#11"-> Voltage drop of 5 V battery for control board

"#12"-> Inverter bridge shorted

"#13"-> IPM protective function activated

"#14"->Motor overcurrent  
"#20"->INT loop error  
"#21"->INT5 loop error  
"#22"->INT4 loop error  
"#23"->INT3 loop error  
"#24"->INT2 loop error  
"#25"->INT1 loop error  
"#26"->Access denied  
"#27"->Ram check error in initialization  
"#28"->Party error  
"#29"->Watchdog error  
"#30"->IRQ7 interruption  
"#31"->NMI interruption  
"#32"->General illegal command  
"#33"->Slot illegal command  
"#34"->CPU address error  
"#35"->DMA address error  
"#36"->Undefined trap error  
"#37"->Undefined interruption  
"#38"->DMAC  
"#39"->ITU  
"#40"->SCI  
"#41"->REF  
"#42"->A/D  
"#43"->System reserved  
"#44"->User break

[Code]

In the case of #1, the code shows the error content of the control board.

In the case of #3, the code shows the error content of the optional program file.

- 1: Identification code "OPF1" error
- 2: End code "ED" error
- 3: Sum check error
- 4: Board name error

In the case of #11-14, #20-21, #25-26 and #30-31, the code shows the data in the error status register.

[Probable Faulty Locations]

In the case of #1,

- Inverter unit

In the case of #3,

- Optional program file
- Optional program file incompatible with inverter unit

In the case of #2 or #11,

- Power unit (when this alarm occurred in several inverter units)

In the case of #12, #13, or #14,

- Inverter unit

In other cases,

- Inverter unit

★ 1152 MCS Processing trouble

MCS

[Index] Axis name or none (spindle)

[Character-string] None

[Code] XXZZAAAA

XX:

04-> The self-diagnostic data has an error. (ZZ: Received data)

06-> Software sync bit or format code of buffer A is wrong.

07-> Software sync bit or format code of buffer B is wrong.

08-> An error occurred in data communication.

ZZ shows the data kind. AAAA is always 0.

ZZ:

1-> Speed command (8408)

2-> Laser linear scale value (4413)

3-> Backlash (4406)

4-> Actual position without positioning error compensation (440A)

5-> Positioning error compensation amount

6-> Full-closed loop encoder value (4410)

7-> Semi-closed loop encoder value (4411)

8-> ODIFF (4415)

10-> APA in divided stroke (4404)

11-> Acceleration/deceleration time for positioning (4422)

12-> Zero offset amount

13-> In-position width (4420)

14-> Maximum of divided stroke (4405)

15-> Point data change

[Probable Faulty Locations]

- Faulty MCS controller
- Faulty software

**★ 1153 MCS CON APA deviation**

Difference between CON and APA values has exceeded the allowable limit. The CON-APA deviation is the absolute value of difference between [calculated value written in MCS] and [actual position read from MCS]. The NC control software monitors this deviation. The MCS normally monitors DIFF value.

This alarm appears if the MCS causes a fatal error and cannot monitor the DIFF value.

[Index] Axis name

[Character-string] None

[Code] Absolute value of deviation in hexadecimal (reference unit)

[Probable Faulty Locations]

- Faulty MCS controller
- Mismatch between MCS data and NC data

**★ 1154 MCS Power-Supply-Unit Error**

The power unit caused an error.

[Index] Axis name or none (spindle)

[Character-string] None

[Code] AAAAAAXX

AAAAAA is always 0.

X Alarm number

0: DC voltage alarm

- 1: Abnormal input voltage
- 2: Abnormal control power
- 3: Abnormal control status
- 4: Overload in regenerative circuit
- 5: Heat sink overheat
- 6: CPU error
- 7: Spare
- Y: Power unit status
- bit3 1: An alarm occurred in the power unit. (Warning signal status: 0)
- bit2 1: DC power is being supplied
- bit1 1: OPRON input is closed
- bit0 1: PWON input is closed.

ZZ: Data

X(alarm No.): 0 ... Detected DC voltage in hexadecimal [3.9V]

X(alarm No.): 1 ... Detected AC voltage in hexadecimal [3.1V]

X(alarm No.): 2

- 1: +5V abnormal voltage
- 2: +12V abnormal voltage
- 3: -12V abnormal voltage

X(alarm No.): 3

- 1: Converter over current
- 2: Abnormal power element
- 3: Converter short circuit
- 4: Abnormal regenerative circuit(type in power regenerative circuit)
- 5: Abnormal regenerative circuit(type in resistor discharge)

X(alarm No.): 4 Uncertain

X(alarm No.): 5 Uncertain

X(alarm No.): 6 Uncertain

[Probable Faulty Locations]

In the case of abnormal control power,

- Power unit

In the case of low voltage,

- Input voltage drop, power failure, blown fuse in input power circuit, or instantaneous power interruption

In the case of high voltage

- Power unit

★ 1155 **MCS Converter-link error**

The convertor link (used for communication between power unit and inverter unit) caused an error, disabling the NC from monitoring the power unit condition.

[Index] Axis name or none (spindle)

[Character-string] None

[Code] XAAAAAYY

AAAAA is always 0.

X=0: communication error

X=1: Time-out error (communication interrupted)

YY=communication status

When X is ONE(1),always 0

[Probable Faulty Locations]

- Converter link cables or connectors
- Power unit
- Inverter unit control board

★ 1156 **MCS DC-bus voltage alarm**

The DC-bus voltage in the inverter unit has abnormally risen or fallen, disabling the inverter from supplying the current.

[Index] Axis name or none (spindle)

[Character-string] None

[Code] XXXXYYYY

XXXX=Detected overvoltage in hexadecimal [15.3 mV]

YYYY=Detected undervoltage in hexadecimal [15.3 mV]

[Probable Faulty Locations]

In the case of voltage rise,

- Power unit

In the case of voltage drop,

- Power unit
- Inverter unit
- Instantaneous power interruption

★ 1157 **MCS Motor over current**

The inverter unit has detected excessive current flowing in the motor cable.

[Index] Axis name or none (spindle)

[Character-string] None

[Code] XXXXYYYY

XXXX=U-phase current detected when this alarm occurs,expressed in signed hexadecimal [Tolerance: 3FFF]

YYYY=V-phase current detected when this alarm occurs,expressed in signed hexadecimal [Tolerance: 3FFF]

[Probable Faulty Locations]

- Inverter unit
- Faulty motor insulation

★ 1158 **MCS Power unit over heat**

The inverter unit has detected excessive current flowing in the motor cable.

The inverter unit temperature has risen abnormally.

[Index] Axis name or none (spindle)

[Character-string] None

[Code] 1 (fixed)

[Probable Faulty Locations]

- Inverter unit
- Overload operation

★ 1159 **MCS Power unit over load**

The inverter load has exceeded the specified value, activating the overload protection function.

[Index] Axis name or none (spindle)

[Character-string] None



[Code] YYYYZZZZ

YYYY->Gamma of the protection curve used to detect overload

ZZZZ->Internally calculated overload data

[Probable Faulty Locations]

- Invertor unit
- Overload operation

★ 1160 **MCS Supply voltage flutter**

The power unit input voltage is abnormally high or low.

[Index] Axis name or none (spindle)

[Character-string] None

[Code] Detected abnormal voltage in hexadecimal [Volt]

[Probable Faulty Locations]

- Power unit
- Power cables or connectors
- Instantaneous power interruption

★ 1161 **MCS Power unit version error**

The invertor unit allowable current is smaller than the current limit specified in the servo data file.

[Index] Axis name or none (spindle)

[Character-string] None

[Code] 1 (fixed)

[Probable Faulty Locations]

- Invertor unit
- Servo data file

★ 1162 **MCS Winding-change failed**

The winding-change magnet switch does not come on.

[Index] Axis name or none (spindle)

[Character-string] None

[Code] YYYYZZZZ

If YYYY = 0000

ZZZZ =0001: Magnet conductor for low-speed winding is ON.

ZZZZ =0002: Magnet conductor for high-speed winding is ON.

ZZZZ =0003: Magnet conductors for both windings are ON.

ZZZZ =0004: Winding change time-out

If YYYY = 1010

ZZZZ =0001: Faulty servo data file

[Probable Faulty Locations]

- Winding-change magnet switch

★ 1163 **MCS Encoder-link error**

An error occurred in the encoder communication link, disabling the encoder from detecting positioning speed.

[Index] Axis name or none (spindle)

[Character-string] None

[Code] XXYYZZZZ

XX = FF (fixed)

YY = 00: YY = 00: Error is detected at the motor encoder.  
01: Error is detected at the position encoder with shaft.  
02: Error is detected at the independent position encoder.  
03: Error is detected at ABSO SCALE.

ZZZZ= Encoder link error status at the time of error detection.

Each bit represents the kind of communication error.

bit 15 1: Error in communication with a stand-alone encoder  
bit 14 1: Error in communication with ABSO SCALE 2  
bit 13 1: Error in communication with ABSO SCALE or encoder with shaft  
bit 12 1: Error in communication with motor encoder  
bit 11 1: Undefined  
bit 10 1: Transmission loop error in AT (auto) mode  
bit 9 1: Data over error in data receiving part of interface  
bit 8 1: Undefined  
bit 7 1: Undefined  
bit 6 1: Modulation code error  
bit 5 1: CRC error  
bit 4 1: Format error  
bit 3 1: Double transmission error  
bit 2 1: Double reception error  
bit 1 1: Parity error  
bit 0 1: Time-out error

[Probable Faulty Locations]

- Motor encoder, ABSO SCALE, encoder with shaft, or stand-alone encoder of the problem axis
- Encoder link cables or connectors
- Invertor unit control board

**★ 1164 MCS Encoder error**

The motor encoder has become unable to detect positional data.

[Index] Axis name or none (spindle)

[Character-string] None

[Code] XXYYZZZZ

XX= Encoder error code depending on the encoder type

YY = Detailed encoder status. The status varies with the encoder type.

ZZZZ =Multi-turn position data. This data appears when the multi-turn position data has exceeded the rotating range.

XX = 0 (fixed)

YY = 1 (fixed)

ZZZZ =Multi-turn position data

[Probable Faulty Locations]

- Motor encoder

**★ 1165 MCS Encoder initialize failed**

An error occurred in initialization of the motor encoder.

[Index] Axis name or none (spindle)

[Character-string] None

[Code] XXYYZZZZ

XX= Encoder link sequence number at the time of error detection

- 0: Reset
- 1: Network address setting
- 2: Request of basic information on communication
- 3: Change of communication version
- 4: Acquisition of device information
- 5: Parameter change
- 6: AT (auto) mode start

YY= Error content

- 0: Communication error
- 1: Transmission start time over
- 2: Transmission finish time over
- 3: Reception finish time over
- 4: Abnormal response address
- 5: Abnormal response code
- 6: Parameter error

ZZZZ=Additional data

If YY=0, the encoder link error status C2ERR at the time of error detection appears.

If YY=1, 2, or 3, the transferred frame information QC2MTINF appears.

If YY=4, the network address of the responding device appears.

If YY=5, the received frame information QC2RXINF appears.

If YY=6, the number of parameter that caused the alarm appears.

1= Not all the necessary parameters are received.

2= Basic information on communication is incompatible.

3= Multi-rotation detection range does not match.

[Probable Faulty Locations]

- Motor encoder
- Encoder link cables or connectors
- Invertor unit control board

**★ 1166 MCS Encoder with shaft error**

The encoder with shaft has become unable to detect positional data.

[Index] Axis name or none (spindle)

[Character-string] None

[Code] Same with <MCS Encoder error>

[Probable Faulty Locations]

- Encoder with shaft

**★ 1167 MCS Encoder with shaft initial**

An error occurred in initialization of the encoder with shaft.

[Index] Axis name or none (spindle)

[Character-string] None

[Code] Same with <MCS Encoder initialize failed>

[Probable Faulty Locations]

- Encoder with shaft
- Encoder link cables or connectors
- Invertor unit control board

★ 1168 **MCS ABSO SCALE error**

An error occurred in initialization of ABSO SCALE.

[Index] Axis name or none (spindle)

[Character-string] None

[Code] None

[Probable Faulty Locations]

- ABSO SCALE

★ 1169 **MCS ABSO SCALE initialize**

An error occurred in initialization of ABSO SCALE.

[Index] Axis name or none (spindle)

[Character-string] None

[Code] Same with <MCS Encoder initialize failed>

[Probable Faulty Locations]

- ABSO SCALE
- Encoder link cables or connectors
- Invertor unit control board

★ 1170 **MCS Magnetic encoder alarm**

The magnetic pulse generator has become unable to detect the motor speed. Or, the number of magnetic encoder gear teeth does not match the data in the MCS data file.

[Index] Axis name or none (spindle)

[Character-string] None

[Code] XXXXYYYY

XXXX=Error content

A-> A-phase voltage is abnormal.

B-> B-phase voltage is abnormal.

C-> Magnetic encoder data error

Others-> Servo data file set value detected when the count over error occurred in the magnetic encoder  
(No. of PG gear teeth \* 4 - 1)

YYYY=Additional error data (Varies with XXXX.)

If XXXX is A, A-phase voltage appears.

If XXXX is B, B-phase voltage appears.

If XXXX is C, 0 (fixed) appears.

Others-> Detected count value of magnetic encoder (No. of PG gear teeth \* 4 - 1)

[Probable Faulty Locations]

- Magnetic encoder or its wiring, or large gap between magnetic encoder and gear
- Mismatch between the number of gear teeth of magnetic encoder and the servo data file data

★ 1171 **MCS Resolver alarm**

The resolver does not send any signal.

[Index] Axis name or none (spindle)

[Character-string] None

[Code] 1 (fixed)

[Probable Faulty Locations]

- Resolver trouble, or disconnection or contact failure of the resolver cable

★ 1172 **MCS Pulse generator count over**

The PG (pulse generator) count value per one turn differs from the corresponding data specified in servo data file.

[Index] Axis name or none (spindle)

[Character-string] None

[Code] XXXXYYYY

XXXX=PBU set value (Count number for one PG turn)

YYYY=Actual count number

[Probable Faulty Locations]

- Faulty PG
- Mismatch between the number of PG gear teeth and the servo data file data

★ 1173 **MCS Motor over heat**

The motor temperature is abnormally high.

[Index] Axis name or none (spindle)

[Character-string] None

[Code]YYYYZZZZ

YYYY =0 (fixed)

ZZZZ =0010: Motor overheat

ZZZZ =0011: Motor overheat is detected at the motor.

ZZZZ =0012: Motor overheat is detected at the position encoder.

ZZZZ =0013: Motor overhead is detected at the motor and the encoder.

[Probable Faulty Locations]

- Malfunction of VAC motor fan, dirty heat sink, CW/CCW turns and stops at high frequency
- BL motor
- Motor encoder (BL motor detects overheat by its encoder.)

★ 1174 **MCS Servo-link error**

A communication error occurred in the servo link, disabling the servo unit from receiving commands from the NC.

[Index] Axis name or none (spindle)

[Character-string] None

[Code] XXXXYYYY

XXXX=0 (fixed)

YYYY=Bit number indicating the kind of communication error  
(Servo link error status at the time of error detection)

bit 15 1: 2nd B-buffer error

bit 14 1: 2nd A-buffer error

bit 13 1: 1st B-buffer error

bit 12 1: 1st A-buffer error

bit 11 1: MT buffer error

bit 10 1: Relay processing error

bit 9 1: Data over error in data receiving part of interface

bit 8 1: Disconnection

bit 7 1: Address pointer error

bit 6 1: Modulation code error

bit 5 1: CRC error

bit 4 1: Format error

- bit 3 1: Double transmission error
- bit 2 1: Double reception error
- bit 1 1: Parity error
- bit 0 1: Time-out error

[Probable Faulty Locations]

- Invertor unit control board
- Servo link cables or connectors
- FCP board

★ 1175 **MCS Servo-link disconnect**

The servo link is disconnected, disabling the servo unit from receiving commands from the NC.

[Index] Axis name or none (spindle)

[Character-string] None

[Code] XXXXYYYY

XXXX=Disconnected position

0-> Disconnected right in front of the problem unit

8000->Disconnected before the problem unit

YYYY=Servo link error status at the time of error detection

[Probable Faulty Locations]

- Servo cables or connectors
- Invertor unit control board
- FCP board

★ 1176 **MCS Servo-link protocol error**

The NC and the invertor unit exchange commands and responses at constant intervals according to the specified protocol through the servo link. In this communication, a wrong protocol or abnormal timing was used to transfer the data from NC to the invertor unit.

[Index] Axis name or none (spindle)

[Character-string] None

[Code] Number indicating the error content

- 1: A-buffer Software synchronization error
- 2: A-buffer Format code error
- 3: B-buffer Software synchronization error
- 4: B-buffer Format code error
- 5: B-buffer Block number error

[Probable Faulty Locations]

- Invertor unit control board
- NC software
- Invertor unit control board not compatible with NC software
- FCP board

★ 1177 **MCS Servo data error**

The servo data sent from the NC for initialization or operation is not applicable to the invertor unit.

If this alarm occurs after change of invertor unit, the servo data file is not applicable to the invertor unit.

If this alarm occurs after adjustment or change of the servo data, the servo data is wrongly changed.

[Index] Axis name or none (spindle)

[Character-string] None

[Code] XXXXYYYY

XXXX=Data ID number of the data that caused the error

YY= Data set number of the data that caused the error

ZZ= Error content

- 1: Out of setting range
- 2: Wrongly set timing
- 3: No transmission
- 4: Calculation error
- 5: Others

[Probable Faulty Locations]

- Servo data file not compatible with inverter unit
- Inverter unit not compatible with NC software
- Inverter unit control board
- NC software

**★ 1178 MCS Illegal command**

The NC and the inverter unit exchange commands and responses through the servo link. In this communication, the NC sent an abnormal or inexecutable command to the inverter unit.

[Index] Axis name or none (spindle)

[Character-string] None

[Code] XXXXYYYY

XXXX=

- 10: Positioning mode Command point number over
- 11: Positioning mode Negative command value
- 12: Positioning mode Larger command value (specified position > 360 deg for rotary axis)
- 13: Positioning mode RPositioning point table not transmitted
- 14: Positioning mode Non-rotating axis
- 15: Positioning mode Command format other than points
- 16: Positioning mode Positioning sub-mode error
- 21: Parameter change Parameter number out of specifiable range
- 22: Mode Undefined mode
- 23: Mode Positioning/tool path mode condition
- 24: Coordinate system Coordinate system designation error
- 30: Unused bit is ON in the bit commands for controlling the S-link A buffer.
- 31: Unused bit is ON among the bit data in the S-link B buffer.
- 40: AT mode is selected without reception of time synchronization command.

YYYY= Error data

X in the range from 10 to 16 shows the positioning sub-mode.

0: Program mode 1:Search mode 2:PH mode 3:Teach mode

[Probable Faulty Locations]

- Inverter unit not compatible with NC software
- Inverter unit control board
- NC software

**★ 1179 MCS CON speed over**

Increments for positioning command (SRCOND) issued from the NC to the inverter unit exceed the allowable limit.

If this alarm occurs in the axis to be positioned, the servo data file has wrong data. (This is because the inverter unit calculates the increments for the axis to be positioned.)

[Index] Axis name or none (spindle)

[Character-string] None

[Code]

Absolute value of increments processed for acceleration/deceleration [(pr/65536)/Tp]

Where, pr= One turn of position encoder; Tp= Position control frequency

The following codes, however, have specific meanings:

- 1: The increments were so large that they were judged erroneous in preliminary check.
- 2: The position command (SRCON) exceeds the absolute value of the encoder measuring range (linear axis only).

[Probable Faulty Locations]

- Servo data file
- NC software

**★ 1180 MCS Speed command over**

Speed command value issued from the NC to the inverter unit exceeds the allowable limit.

[Index] Axis name or none (spindle)

[Character-string] None

[Code] Speed command [(rev/4294967269)/Tv]

rev= One motor turn; Tv= Speed control frequency

[Probable Faulty Locations]

- Servo data file
- NC software

**★ 1181 MCS DIFF over**

Axis movement caused a large positioning error.

While the axis is in a target position or stopped, the target value and the calculated value are the same. With an axis movement command, the NC starts creating calculation values (RCON) until the target point is reached. At this time, the actual position follows the calculated value with a certain delay. This delay is called "following error" and calculated by ([calculation value] - [actual value]). If the "following error" exceeds the allowable limit, the above alarm occurs.

[Index] Axis name or none (spindle)

[Character-string] None

[Code] Absolute value of following error [pr/65536]

pr = One turn of position encoder

[Probable Faulty Locations]

- Overload due to faulty ball screw or bearing
- Motor
- Inverter unit
- Servo data file

**★ 1182 MCS APA speed over**

The position encoder value (RAPA) changes as the motor rotates.

The NC checks this change with preset frequency.

This alarm occurs if the change per unit time exceeds the allowable range consecutively. For example, an axis feedrate is abnormally high compared with the normal rapid feedrate, or the encoder value changes irregularly due to malfunction of the position encoder.

[Index] Axis name or none (spindle)

[Character-string] None



[Code]

Absolute value of the change in encoder value per position control frequency [encoder's 1/65536 turn/position control frequency]

The following codes, however, have specific meanings:

- 1= Linear axis has exceeded its travel range.
- 2= Rotary axis has exceeded its travel range (360 deg) or limited axis has negative positional data.
- 3= Limited axis has exceeded its travel range.

[Probable Faulty Locations]

- Motor encoder (BL motor)
- Encoder link cables or connectors (BL motor)
- PG or magnetic encoder (VAC motor)
- PG or magnetic encoder cables or connectors (VAC motor)
- Invertor unit control board

**★ 1183 MCS Full-closed APA error**

Difference between the full-closed loop encoder value and the motor encoder value exceeds the allowable range.

[Index] Axis name or none (spindle)

[Character-string] None

[Code] Number of times the error has been detected

[Probable Faulty Locations]

- Synthetic offset data is not set at the full-closed loop encoder or wrong data is set.
- ABSO SCALE or position encoder with shaft
- Excessive lost motion in axis drive system (The motor is not rigidly connected with the movable part.)
- Slippage or breakage of shaft belt
- Loose coupling between motor and ball screw
- Improper positional loop gain (too high)

**★ 1184 MCS Over speed**

Actual motor speed is too high.

[Index] Axis name or none (spindle)

[Character-string] None

[Code] Motor speed detected when this alarm occurred [(rev/4294967296)/Tv]

Where, rev= One motor turn; Tv= Speed control frequency

[Probable Faulty Locations]

- Motor encoder (BL motor)
- Encoder link cables or connectors (VAC motor)
- Resolver or magnetic encoder (VAC motor)
- Resolver or magnetic encoder cables or connectors (VAC motor)
- Invertor unit control board

**★ 1185 MCS Velocity deviation over**

Actual motor speed excessively deviates from the speed command.

[Index] Axis name or none (spindle)

[Character-string] None

[Code] XXXXYYYY

XXXX: Detected torque (sum of the torque data collected for 3.2 ms)  
+2<sup>-12</sup>[MAXTRQ]

If Tv = 0.4 ms, the momentary maximum torque is H'7FFF.

If Tv = 0.8 ms, the momentary maximum torque is H'3FFF.

YYYY: Detected acceleration (average value measured for 3.2 ms)  
+2<sup>-16</sup>[vr/3.2 ms/3.2 ms]

= about 0.1 [rpm/ms]

The code number 00000001 means that the error data is replaced by zero because of exponent underflow.

[Probable Faulty Locations]

- The motor does not turn because of (mechanical lock or) application of large load.

★ 1186 **MCS Collision detected**

The NC torque limiter has detected collision of axis by monitoring the relation between motor output torque and motor acceleration.

[Index] Axis name or none (spindle)

[Character-string] None

[Code] XXXXYYYY

XXXX: Detected torque (sum of torque data collected for 3.2 ms)  
+2<sup>-12</sup>[MAXTRQ]

If Tv = 0.4 ms, the momentary maximum torque is H'7FFF.

If Tv = 0.8 ms, the momentary maximum torque is H'3FFF.

YYYY: Detected acceleration (average torque measured for 3.2 ms)  
+2<sup>-16</sup>[vr/3.2 ms/3.2 ms]

= about 0.1 [rpm/ms]

[Probable Faulty Locations]

- Collision
- Motor encoder
- NC torque limiter set value

★ 1187 **MCS Urgent-stop time over**

The axis cannot stop within a preset time after reception of emergency stop command.

[Index] Axis name or none (spindle)

[Character-string] None

[Code] XXXXXXXX

- 1: Emergency stop time over
- 2: Deceleration time over at emergency stop
- 3: Deceleration time over at alarm stop

[Probable Faulty Locations]

- Invertor unit control board
- NC software

★ 1188 **MCS Belt is broken**

Breakage of belt was detected in the belt-driven axis.

[Index] Axis name or none (spindle)

[Character-string] None

[Code] Load torque (hexadecimal) at the time of alarm detection

[Probable Faulty Locations]

- Broken belt

★ 1189 **MCS Axis change control error**

Axis change was not performed normally. (This is not an alarm caused in MCS.)

[Index] Axis to be selected by axis change

[Character-string] None

[Code]

- 1 MCS was not reset within 10[s].
- 2 Parameter set numbers matching signal or control ready signal failed to come ON within 10[s].
- 3 MCS failed to receive the maximum APA value from the split encoder within 10 seconds.
- 6 MCS controller failed to change in-position amount or zero offset amount within 10 seconds.
- A MCS controller failed to change in-position amount or zero offset amount within 10 seconds after alarm occurrence.

[Probable Faulty Locations]

- Faulty MCS controller for PLC axis
- Faulty software

★ 1190 **MCS independent encoder init**

An error occurred during initialization of the MCS independent encoder.

[Index] Axis name or none (spindle)

[Character-string] None

[Code] XXYYZZZZ

XX-> Encoder link sequence number

- 0: Reset
- 1: Net address setting
- 2: Request to send the basic information for communication
- 3: Change of communication software version
- 4: Acquisition of device information
- 5: Parameter change
- 6: AT mode start

YY-> Alarm content

- 0: Communication error
- 1: Transmission start time over
- 2: Transmission end time over
- 3: Reception end time over
- 4: Wrong response address
- 5 Wrong response code
- 6: Parameter error

ZZZZ->Data

YY = 0: Encoder link error status C2ERR established on detection of the error

YY = 1, 2, or 3: Transmitted frame information QC2MTINF

YY = 4: Net address of the corresponding device

YY = 5: Received frame information QC2RXINF

YY = 6: Parameter number at which the error is detected

- 1 = Reception of insufficient number of parameters
- 2 = Basic information for communication being incompatible
- 3 = Multi-turn detection range over

[Probable Faulty Locations]

- Independent position encoder
- Encoder link cables and connectors

- Invertor unit control board

★ 1191 **MCS APA error**

An error occurred during calculation of APA value.

[Index] Axis name or none (spindle)

[Character-string] None

[Code] XXXXXXXX

- 1: Linear axis divided travel over
- 2: Overflow during conversion of semi-position from [pr] to [pf].
- 3: Underflow in synthesizing the axis data
- 4: Overflow in synthesizing the axis data
- 5: Overflow of input values used for hybrid control
- 6: Overflow during initialization for hybrid control

[Probable Faulty Locations]

- Motor encoder, encoder with shaft, or ABSO SCALE
- Invertor unit control board
- Servo data file

If the alarm code is "1" or "3", the position encoder may not be properly offset to zero.

If the alarm code is "4", the servo data file may be defective.

If the alarm code is "5" or "6", the motor coupling, encoder with shaft, or ABSO SCALE may be loosely mounted.

★ 1192 **MCS Motor over load**

The motor load has exceeded the preset value, activating the overload protection function.

[Index] Axis name or none (spindle)

[Character-string] None

[Code] YYYYZZZZ

YYYY->Gamma of the protection curve used to detect overload

ZZZZ->Internally calculated overload data

[Probable Faulty Locations]

- Motor
- Overload caused by machine operation
- Servo data file

★ 1200 **APA BCD data**

Position encoders are used to detect actual position. The position encoders have up to six digits, with each digit represented by a number ranging from 0 to 9 since each digit number is expressed by BCD (binary coded decimal). If a number of any digit exceeds 10 due to faulty position encoder or short of the position encoder cables, the APA BCD data alarm occurs.

Note: The output value from the position encoder is also referred to as RAPA.

[Code] XY

X:Read-in digit

No-> Divided by "5"

1-> 1st figure

2-> 2nd figure

3-> 3rd figure

4-> 4th figure

5-> 5th figure

6-> 6th figure

Y:Read-in BCD data

A-> through E Interface error

F-> Encoder error

Meanwhile figures other than 0, 1, 3, 7, F given for half division figure

[Probable Faulty Locations]

- 1) Position encoder or its cables
- 2) SVP board (or SPC-1) of the axis indicated
- 3) Distributor

**★ 1201 Plus travel limit over**

The target point for the return to manual intervention point operation exceeds the plus travel limit. During cutting feed operations, the calculated value exceeds the plus travel limit (programmable plus travel limit in the case of G22 mode).

[Index] AXIS

[Code]

- 1-> During cutting feed operation
- 2-> During return to manual intervention point

[Probable Faulty Locations]

Travel limit value is changed during operations.

[Measures to Take]

Re-set the travel limit value to the correct value.

**★ 1202 Minus travel limit over**

The target point of the return to manual intervention point operation exceeds the minus travel limit.

During cutting feed operations, the calculated value exceeds the minus travel limit (programmable minus travel limit in the case of G22 mode).

[Index] AXIS

[Code]

- 1-> During cutting feed operation
- 2-> During return to manual intervention point

[Probable Faulty Locations]

Travel limit value is changed during operations.

[Measures to Take]

Re-set the travel limit value to the correct value.

**★ 1203 Barrier**

With MC-H series machining centers, an interference occurs if both Y and Z axes enter a certain zone. Such a zone is designated by the barrier which is set by system parameters.

This alarm occurs if both Y and Z axes enter this interference zone at the same time.

[Probable Faulty Locations] Y or Z command error in a program

[Measures to Take] Check the program.

[Related Specifications] MC-H series

**★ 1204 Spindle drive unit**

This is an alarm with the spindle motor drive unit.

This alarm occurs if the VAC faulty signal is turned off.

[Code]

None->The faulty signal or normal signal is turned off.

- 1-> Velocity over signal is turned ON.

[Probable Faulty Locations]

- 1) Faulty spindle drive motor
- 2) Blown fuse in drive unit blown
- 3) Faulty control PCB inside drive unit

★ 1205 **Spindle MS OFF**

This is an alarm with the spindle motor drive unit.  
This alarm occurs if the VAC faulty signal is turned off.

[Code]

None->The faulty signal or normal signal is turned off.  
1-> Velocity over signal is turned ON.

[Probable Faulty Locations]

- 1) Faulty spindle drive motor
- 2) Blown fuse in drive unit blown
- 3) Faulty control PCB inside drive unit

★ 1206 **Spindle drive motor overload**

The overload relay protecting the spindle drive motor is tripped.  
This alarm occurs if the thermostat installed inside the spindle drive motor is actuated.

[Probable Faulty Locations]

- 1) Cutting under overloaded condition
- 2) Spindle drive motor cooling fan is not operating.
- 3) Faulty spindle drive motor

[Measures to Take]

Turn off power supply to cool the motor.

★ 1207 **Spindle speed over**

The rated maximum speed of the spindle drive motor is exceeded.  
The actual spindle speed detected by the spindle pulse generator exceeds 125% of the maximum speed of the selected spindle speed range.  
Ex. The actual spindle speed is over 500[1/min] in the low speed range while the rated maximum speed in this range is 400 [1/min].

[Code] Actual spindle speed (hexadecimal)

[Probable Faulty Locations]

- 1) Faulty spindle motor drive unit
- 2) Faulty spindle pulse generator (EC-P card 3)

★ 1208 **Hydraulic pump motor overload**

The overload relay protecting the hydraulic pump motor is tripped.

(1) VR -40

The hydraulic pump normal signal from the hydraulic power unit for APC is turned off.

(2) MC-40VA/50VA/60VA

The hydraulic pump motor ON signal from the hydraulic power unit (combination unit), which is installed at the back of the column, is turned off.

(3) MC-400H

The hydraulic pump motor in-operation signal from the hydraulic power unit (combination unit), which is installed at the back of the column, is turned off.

(4) MC-500H/600H/800H

The hydraulic pump motor ON signal from the hydraulic power unit (combination unit), which is installed at the back of the column, is turned off.

- (5) MDB-A, MCV-A
  - a) OL17 for spindlehead hydraulic pump motor is tripped.
  - b) Hydraulic pump motor ON signal from the combination unit, which is installed at the rear of the table, is turned off.
  - c) The hydraulic pump motor ON signal from the hydraulic power unit for APC is turned off.
  - d) The hydraulic pump motor ON signal from the hydraulic power unit for W-axis balancer is turned off.
- (6) MDB-B, MCV-B, MCM, MCR
  - a) The hydraulic pump motor ON signal from the combination unit, which is installed at the rear of the table, is turned off.
  - b) The hydraulic pump motor ON signal from the hydraulic power unit for APC is turned off.
  - c) The hydraulic pump motor ON signal from the hydraulic power unit for W-axis balancer is turned off.
- (7) MCR-B
  - a) The hydraulic pump motor in-operation signal from the combination unit, which is installed at the rear of the table, is turned off.

[Character-string]

None->Combination unit  
ATC-> Hydraulic power unit for ATC  
APC-> Hydraulic power unit for APC  
W-> Hydraulic power unit for W-axis balancer  
SPIN->Hydraulic motor for spindlehead (only for A series)

[Probable Faulty Locations] Faulty hydraulic pump motor

[Measures to Take]

Reset the overload relay inside the hydraulic power unit or the combination unit.  
Clean the filter.

★ 1209 **Hydraulic pressure**

Hydraulic pressure has dropped below the specified level.

- (1) MC-400H
  - The hydraulic pressure normal signal from the hydraulic power unit (combination unit), which is installed at the back of the column, is turned off.
- (2) MC-500H/600H/800H
  - The hydraulic pressure normal signal from the hydraulic power unit (combination unit), which is installed at the back of the column, is turned off.
  - a) The hydraulic pressure normal signal from the hydraulic power unit (combination unit), which is installed at the back of the column, is turned off.
- (3) MDB-A, MCV-A
  - a) The hydraulic pressure normal signal from the combination unit, which is installed at the rear of the table, is turned off.
  - b) The hydraulic pressure normal signal from the hydraulic power unit for APC is turned off.

- c) The hydraulic pressure normal signal from the hydraulic power unit for W-axis balancer is turned off.
- (4) MDB-B, MCV-B, MCR, MCM
  - a) The hydraulic pressure normal signal from the combination unit, which is installed at the rear of the table, is turned off.
  - b) The hydraulic pressure normal signal from the hydraulic power unit for APC is turned off.
  - c) The hydraulic pressure normal signal from the hydraulic power unit for W-axis balancer is turned off.
- (5) MCR-B
  - The hydraulic pressure normal signal from the combination unit, which is installed at the rear of the table, is turned off.

[Character-string]

None->Combination unit  
ATC-> Hydraulic power unit for ATC  
APC-> Hydraulic power unit for APC  
W-> Hydraulic power unit for W-axis balancer

[Probable Faulty Locations]

- 1) Setting error of the pressure switch inside the combination unit or the hydraulic power unit
- 2) Hydraulic pressure is not built up due to defective hydraulic power unit pump.

★ 1210 **Hydraulic balancer pressure**

Z-axis balancer pressure is lowered (for MCR and MCM). This alarm occurs when the pressure normal signal is turned off.

Machine Input Signal No. 23 bit 4

[Index] AXIS

[Probable Faulty Locations]

- 1) Setting error of the hydraulic balancer pressure switch
- 2) Source pressure from the hydraulic power unit is lowered.

★ 1211 **Spindlehead lube motor overload**

The overload sensor of the spindlehead lubricating motor/cooling unit pump motor is activated.

- (1) MC-30VA
  - The unit normal signal sent from the spindlehead cooling unit installed on the left side of the column is OFF.
- (2) MC-50VA/60VA
  - The spindlehead lubrication normal signal sent from the combination unit installed on the back of the column is OFF.
- (3) MC-400H
  - The spindlehead cooling unit normal signal sent from the combination unit installed on the back of the column is OFF.
- (4) MC-500H/600H/800H
  - The spindlehead cooling unit normal signal sent from the combination unit installed on the back of the column is OFF.
- (5) MDB-A/B, MCV-A/B, MCR, MCM
  - The cooling unit normal signal sent from the combination unit installed at the rear of the table is OFF.
- (6) MCR-B
  - The lubricating pump operation signal sent from the combination unit installed at the rear of the table is OFF.



[Probable Faulty Locations]

The lubricating pump or cooling unit pump inside the combination unit is defective.  
Referential Document Instruction manual for combination unit/spindle cooling unit

★ 1212 **Spindle lube motor OFF**

The overload relay protecting the spindlehead lubricating oil circulation/cooling pump motor is tripped.

(1) MC-30VA

The unit normal signal from the spindlehead cooling unit, installed at the left side of the column, is turned off.

(2) MC-50VA/60VA

The spindlehead lubrication normal signal from the combination unit, which is installed at the back of the column, is turned off.

(3) MC-400H

The spindlehead cooling unit normal signal from the combination unit, which is installed at the back of the column, is turned off.

(4) MC-500H/600H/800H

The spindlehead cooling unit normal signal from the combination unit, which is installed at the back of the column, is turned off.

(5) MDB-A/B, MCV-A/B, MCR, MCM

The cooler normal signal from the combination unit, which is installed at the rear of the table, is turned off.

(6) MCR-B

The lubrication pump motor in-operation signal from the combination unit, which is installed at the rear of the table, is turned off.

[Probable Faulty Locations]

Faulty circulation pump or cooling pump inside the combination unit.

★ 1213 **Axis drive motor overload**

The overload relays for X-, Y- or Z-axis is tripped. The overload relays are installed inside the axis drive motors.

This alarm occurs when the thermostat is actuated.

[Index] AXIS

[Probable Faulty Locations]

- 1) Cutting under overloaded condition
- 2) Motor load is high due to insufficient slideway lubrication.
- 3) Faulty axis drive motor(s)

[Measures to Take] Turn off power supply to cool the motor.

★ 1214 **Axis interlock**

Axis movable conditions for the axis for which axis movement command is given during automatic mode operation have been off for more than five[s].

The pulse handle shift switch is turned on during ATC or APC operations.

[Index] AXIS

[Code]

1-1FF-> The input condition which must be ON is turned OFF.

The code displayed is a hexadecimal of [(machine input No. - 1) \* 8 + (bit No.) + 1].

200-3FF->The input condition which must be OFF is turned ON.

The code displayed is a sum of 200 and hexadecimal of [(machine input No. - 1) \* 8 + (bit No.) + 1].

Examples:

- 1) Machine input No. 21 bit 1 (ON condition) is turned OFF.

$$(21 - 1) * 8 + 1 + 1 = 162 = A2 \text{ (hexadecimal)}$$

- 2) Machine input No. 21 bit 2 (OFF condition) is turned ON.  
 $(21 - 1) * 8 + 2 + 1 = 163 = A3$  (hexadecimal) + 200 = 2A3

[Probable Faulty Locations]

- 1) The axes are mechanically placed in the axis move disabled condition. (Dog or LS position is shifted.)
- 2) Malfunctioning LS's which constitute axis move conditions
- 3) Faulty input card

★ 1215 **Spindle rotation interlock**

The alarm occurs if spindle rotation enable conditions are turned off or on for more than 0.5[s] during spindle rotation.

[Code]

- 1-> Low spindle speed range confirmation LS is turned off.
- 2-> Middle spindle speed range (high spindle speed range for 2-speed model) confirmation LS is turned off.
- 3-> High spindle speed range confirmation LS is turned off.
- 5-1FF-> The input condition which must be ON is turned off.

The code displayed is a hexadecimal of [(machine input No. - 1) \* 8 + (bit No.) +1].

200-3FF->The input condition which must be OFF is turned on.

The code displayed is a sum of 200 and hexadecimal of [(machine input No. - 1) \* 8 + (bit No.) +1].

Examples:

- 1) Machine input No. 21 bit 1 (ON condition) is turned OFF.  
 $(21 - 1) * 8 + 1 + 1 = 162 = A2$  (hexadecimal)
- 2) Machine input No. 21 bit 2 (OFF condition) is turned ON.  
 $(21 - 1) * 8 + 2 + 1 = 163 = A3$  (hexadecimal) + 200 = 2A3

[Probable Faulty Locations]

- 1) The spindle is mechanically placed in the rotation disabled condition. (Dog or LS position is shifted.)
- 2) Malfunctioning LS's which constitute spindle rotation conditions
- 3) Faulty input card

★ 1216 **No spindle gear change confirmation**

Signals for checking spindle rotation enable conditions are OFF or ON for 0.5[s] or over during spindle rotation.

[Code]

- 1-> The spindle low-speed gear confirmation LS is OFF.
- 2-> The spindle middle-speed (high-speed for 2-speed model) gear confirmation LS is OFF.
- 3-> The spindle high-speed gear confirmation LS is OFF.

Examples:

- 1) When the input ON condition of the bit 1 of the machine input signal No. 21 is OFF, the following code appears:  
 $(21 - 1) * 8 + 1 + 1 = 162 = A2$  (hexadecimal)
- 2) When the input OFF condition of the bit 2 of the machine input signal No. 21 is ON, the following code appears:  
 $(21 - 1) * 8 + 2 + 1 = 163 = A3$  (hexadecimal)  
 $A3 + 200 = 2A3$

[Probable Faulty Locations]

- 1) The spindle is mechanically placed in the rotation disabled condition. (Dog or LS position is shifted.)
- 2) Malfunctioning LS's which constitute spindle rotation conditions
- 3) Faulty input card

★ 1217 **Travel limit over**

A travel end limit switch of X-, Y-, or Z-axis is activated.

This alarm occurs when the NC axis emergency stop signal goes OFF.

[Probable Faulty Locations]

- 1) Defective setting of the system parameters
- 2) Malfunction of the limit switch

[Measures to Take]

Fine out which limit switch is activated on the check panel.  
Move the overtraveling axis toward the middle of the travel.  
Referencial Document Maintenance manual

★ 1218 **Coolant motor overload**

★ 1219 **Axis lube motor overload**

★ 1220 **Active tool NG3**

This alarm occurs with the control which has the tool management function. If a tool whose life has been expired is designated by a T command in a program and if there is no spare tool for it, the life expired tool is selected and set in the spindle by the M06 command.

This alarm occurs when such a tool is set in the spindle.

[Measures to Take]

First, change the life expired tool with a new tool. Set the SET TIME and LEFT TIME data at the TOOL MANAGEMENT screen, then change the NG flag to the OK flag.

[Related Specifications]

Tool management function

★ 1221 **Carrier system checking**

This alarm occurs when the carrier system check mode is set by setting a proper parameter data to carry out adjustments for the machine of the DC or brushless motor specification for the ATC carrier. It does not usually occur during normal machine operation.

[Probable Faulty Locations]

Setting of machine user parameter No. 40 is the carrier check mode.

[Measures to Take]

Clear the machine user parameter No. 40.

★ 1222 **Magazine system checking**

This alarm occurs when the magazine system checking mode is set by setting a proper parameter data to carry out adjustments the machine of the DC or brushless motor specification for the ATC carrier. It does not usually occur during normal machine operation.

[Probable Faulty Locations]

Setting of machine user parameter No. 40 is the magazine check mode.

[Measures to Take] Clear the machine user parameter No. 40.

★ 1223 **Axis drive unit**

An alarm with the transistor axis drive unit (for the DC motor specification model) is detected.

Contents of alarm indication of LDU-TR and DC-PS are briefly explained below.

(1) LDU-TR

Alarm Indication->Description

PH-LOSS->Phase open of 3-phase input

VR-LOSS->PCB control voltage +12 (-12)V has dropped to a level lower than about 80% of the rating.

IOCM->Current more than 120% of limit value has flowed.

IOCS->More than 120% of rated transistor current has flowed the transistor bridge.

HV->DC supply voltage has exceeded 450 V.

LV->DC supply voltage has dropped below 200 V.

(2) DC-PS

Alarm Indication->Description

HV->Same as LDU-TR

LV->Same as LDU-TR

PH LOSS->Same as LDU-TR

OVER DIS->Discharge circuit of the regeneration circuit has functioned for a period longer than the specification.

★ 1224 **Sequence count over**

Abnormal ATC, APC or AAC operation sequence number

[Code]

None->ATC

80-> APC

100-> AAC (floor type)

480-> AACT (table type)

[Probable Faulty Locations]

Contents in the battery back up memory on the ECP-II board become unreliable.

[Measures to Take]

1) Replace ECP card 1 (or ECP-C1-II).

2) Replace the ECP-II board.

★ 1225 **No S command**

★ 1226 **Gear change disable**

★ 1227 **Home position command strobe**

★ 1228 **Inductosyn power unit**

An alarm with inductosyn power supply (for X, Y and Z axes) is detected.

[Probable Faulty Locations]

1) Fuse inside the power supply is blown.

2) Faulty inductosyn preamplifier

3) Faulty power supply

★ 1229 **Spindle orientation motor overload**

The overload relay for spindle orientation motor is tripped (only for MCV of AC spindle drive motor specification).

[Probable Faulty Locations]

1) Faulty spindle orientation motor

2) Malfunctioning overload relay

3) Motor overloaded due to mechanical problems

★ 1230 **Spindle speed change gear shift motor overload**

The overload relay for spindle speed range change motor is tripped (only for MDB and MCV of AC spindle drive motor specification).

[Probable Faulty Locations]

1) Faulty spindle speed range change motor

2) Malfunctioning overload relay

3) Motor overloaded due to mechanical problems

★ 1231 **Spindlehead lubricant return pump motor overload**

The overload relay for spindlehead lubricating oil return pump motor is tripped.

[Probable Faulty Locations]

- 1) Faulty lubricating oil return pump motor
- 2) Malfunctioning overload relay
- 3) Motor overloaded due to faulty lubrication return pump
- 4) Single-phase operation due to contact failure of magnet switch

★ 1232 **Spindlehead lubricant level**

Overflow of lubricating oil in the spindlehead gearbox is detected by a float switch.

[Probable Faulty Locations]

- 1) Malfunctioning float switch
- 2) Lubricating oil is not returned due to faulty return pump.
- 3) Imbalance between the supply pump and return pump inside the combination unit.

★ 1233 **Spindlehead lubricant pressure supply low**

Lubricating oil is not correctly supplied to the spindlehead.

The lubricating oil supply normal signal detected by the pressure switch inside the spindlehead or the combination unit is turned off.

[Probable Faulty Locations]

- 1) Malfunctioning oil supply pump inside the combination unit
- 2) Malfunctioning pressure switch

★ 1234 **CA axis travel limit over**

The ATC carrier axis travel end LS is tripped. This alarm occurs when the EC axis emergency stop signal is turned off.

[Probable Faulty Locations]

- 1) Setting error of carrier position, which is set by a system parameter
- 2) Malfunctioning LS

★ 1235 **Hydraulic unit preparation completion**

The hydraulic power unit pump motor ON signal is turned off.

This signal is input from the combination unit, the APC hydraulic unit, or the W-axis balancer hydraulic unit which is installed at the rear of the table.

[Probable Faulty Locations] Faulty hydraulic power unit pump

[Measures to Take]

- 1-> Reset the tripped overload relay in the combination unit or the hydraulic power unit.
- 2-> Blown fuse

★ 1236 **Hydraulic unit pressure low**

The hydraulic pressure normal signal is turned off. This signal is input from the combination unit, the APC hydraulic unit, or the W-axis balancer hydraulic unit which is installed at the rear of the table.

[Probable Faulty Locations]

- 1) Pressure is not built up due to faulty hydraulic power unit pump.
- 2) Setting error of the pressure switch inside the combination unit or the hydraulic power unit

★ 1237 **Hydraulic unit oil level low**

Oil level in the hydraulic power unit tank is low.

The oil level normal signal is turned off. This signal is input from the combination unit, the APC hydraulic unit, or the W-axis balancer hydraulic unit which is installed at the rear of the table.

[Character-string]

None->Combination unit  
APC-> APC hydraulic unit  
W-> W-axis balancer hydraulic unit

[Probable Faulty Locations]

- 1) Insufficient hydraulic oil level
- 2) Malfunctioning float switch

[Measures to Take] Replenish the hydraulic oil.

★ 1238 **Spindlehead lube oil level low**

Oil level in the spindlehead lubricating oil tank is low.

The oil level normal signal which is input from the combination unit at the rear of the table is turned off.

[Probable Faulty Locations]

- 1) Insufficient lubricating oil level
- 2) Malfunctioning float switch

[Measures to Take] Replenish the lubricating oil.

★ 1239 **Attached unit error 1**

The spindlehead lubricating oil has reduced.

The lubricating oil level normal signal sent from the combination unit installed at the rear of the table is OFF.

[Probable Faulty Locations]

- 1) Lubricating oil shortage
- 2) Malfunction of float switch

[Measures to Take] Supply the lubricating oil.

★ 1240 **Oil-hole motor overload**

★ 1241 **Thru-the-tool coolant filter**

The filter inside the through-the-tool coolant tank is clogged.

[Probable Faulty Locations]

- 1) The filter is clogged.
- 2) Malfunctioning clogging detection pressure switch

[Measures to Take] Clean the filter.

★ 1242 **Spindle overload**

The spindle load detection meter relay or the overload monitor has been turned on due to overload.

Overload monitor XXXXYYYY

XXXX:Overload monitoring parameter number

YYYY:Overload (%) when alarm occurs

[Probable Faulty Locations]

- 1) Cutting under overloaded condition
- 2) Setting error of the spindle load detection meter relay
- 3) Error in setting the startup current immune period (SPDL OVERLOAD TIME) which is set at machine user parameter (word) No. 9.

★ 1243 CON 0 pass

The SRSCON (final command value) value becomes negative..

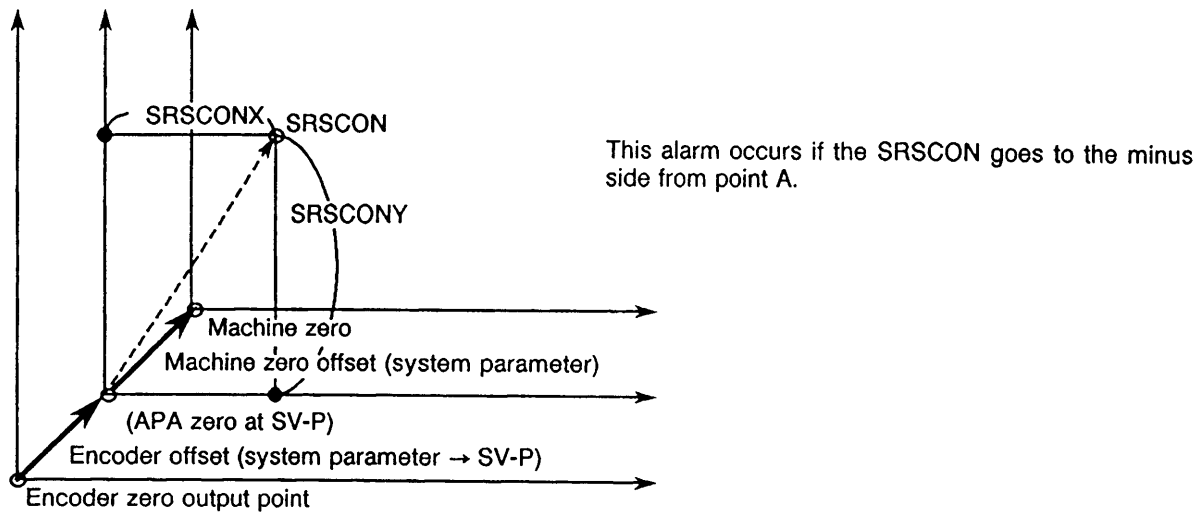

[Index] AXIS

[Code] SRSCON value (hexadecimal) at an occurrence of alarm

[Probable Faulty Locations]

- 1) Setting error of system parameter (machine zero)
- 2) Wrong command value (point left to the machine zero is specified)

Operation Example: An alarm occurs when X-axis moves beyond X0 under the following setting:

Machine zero : 2000.000

-travel limit :-2500.000

Programmed command : G0 X-2001.000

[Measures to Take]

- 1) Reset the machine zero at system parameter.
- 2) Change the command value (must be to the plus side from the machine zero).

★ 1244 User reserve code

VDOUT[993]=\*\*\*

The above command is specified in a program for the control supporting the user task 2 specification.

[Code]

The value specified at the right part of the expression above is displayed along with the user alarm comment which is designated by VUACM[\*]=\*\*\*\*. For \*\*\*\*, a decimal number within a range of 0 to 9999 is allowed. On the display, leading zeros are suppressed.

For other numbers, 'FFFFFFF' is displayed.

Program Example VUACM[1] = 'ABC' WRITE

VDOUT[993] = 1234 WRITE

-> Alarm A 151 User reserve code 1234 ABC

[Related Specifications] User task 2

★ 1245 Pallet check NG

The pallet check NG lamp lights up if the pallet number sent from the NC and the pallet number of the pallet on the setup do not match.

★ 1246 **Synchronous error limit over**

Applies only to systems with "synchronous axis" function.

- 1) This condition in which the synchronization error greater than allowable limit B continued for more than 100 msec when power supply is turned on.
- 2) The condition in which the synchronization error greater than allowable limit A continued for more than 100 msec in cases other than when power supply is turned on.

Synchronization error allowable limit A: Optional parameter (word) No. 50

Synchronization error allowable limit B: Optional parameter (word) No. 51

[Code] Synchronization error at an occurrence of alarm in hexadecimal number

[Probable Faulty Locations]

- 1) After power off, the master or the slave axis fell. Problem with the brake.
- 2) Load on the master or the slave axis increased during operation. Faulty servo system.

[Measures to Take]

- 1) Select the synchronization error correction mode, move the axis with the pulse handle set at \* 1 position, then press the reset button after canceling the correction mode.
- 2) Turn off power supply once and then turned it back on.

Related Specifications Synchronous axis specification

★ 1247 **Quill safety bolt unusual**

★ 1248 **MSB reserved**

This alarm outputs the check results of the Maker subprogram.

[Code] Refer to the Operation Manual for the relevant Maker subprogram.

[Measures to Take]

Check the following items.

- 1) Transfer parameter
- 2) NC status
- 3) Setting data

★ 1249 **Stroke end limit reset**

The stroke end limit reset button is pressed in other than the MDI mode.

[Measures to Take] Perform stroke end limit reset operation in the MDI mode.

★ 1250 **Spindle wiring change impossible**

The spindle wiring change is not completed.

[Probable Faulty Locations] Malfunction of the magnet switch (for wiring change)

[Measures to Take] Replace the magnet switch.

★ 1251 **Clamp IN-P**

Follow-up error (DIFF) of the axis which is not moving exceeds the clamp IN-P width set at the user parameter one[s] or more in succession.

[Index] AXIS

[Probable Faulty Locations]

- 1) Cutting in overload condition
- 2) Faulty mechanical clamp

★ 1252 **CRP exception**

Occurrence of CRP exception error

[Code] XXXX:

Bit0-> User interrupt exception



Bit1-> TRAP instruction exception  
Bit2-> Unused interrupt exception  
Bit3-> Spurious interrupt exception  
Bit4-> Undesignated exception  
Bit5-> Non-executive exception  
Bit6-> Trace exception  
Bit7-> Privilege violation exception  
Bit8-> TRAPV instruction exception  
Bit9-> CHK instruction exception  
Bit10->Zero divide exception  
Bit11->Illegal instruction exception  
Bit12->Address error exception  
Bit13->Bus error exception  
Bit15->RAM check error exception

[Probable Faulty Locations]

- 1) Defective CRP
- 2) Defective operation panel

[Measures to Take]

- 1) Replace the CRP.
- 2) Replace the operation panel.

**★ 1253 Panel/CRP receive**

In the serial data transmission/receive processing, receive error has occurred two cycles in succession.

[Code] X:

Bit0-> ACIA reception error  
Bit1-> Reception data check sum error, protocol error  
Bit2-> Operation panel serial interface error  
Bit3-> Operation panel switch error  
Bit4-> Operation panel self-diagnosis error

[Probable Faulty Locations]

- 1) Defective operation panel
- 2) Defective operation panel serial interface
- 3) Defective CRP

[Measures to Take]

- 1) Check the operation panel serial interface.
- 2) Check the operation panel.
- 3) Check the CRP.

**★ 1254 CRP diagnosis**

CRP self-diagnosis data is not normal.

[Code] Self-diagnosis

[Probable Faulty Locations] Defective CRP board

[Measures to Take] Check the CRP board.

**★ 1255 Outside**

An alarm occurs with the external devices such as a robot and loader.

With machines having the robot or the loader specification, an alarm with the robot or loader controller is detected.

[Probable Faulty Locations] Defective control device for a robot and loader

★ 1256 **CRP parity error**

Read/write during CRP RAM access was not correct. Or the memory error occurred in the CRP RAM test executed when the power was turned on.

[Code]

- 1-> An error occurred during CRP RAM access.
- 2-> An error occurred in CRP RAM test executed when the power was turned on.

[Probable Faulty Locations]

RAM on CRP board  
Operation Example Power turning on

[Measures to Take] Replace the CRP board.

★ 1257 **Emergency stop**

Emergency stop button is pressed.

[Measures to Take]

After removing the cause for which the emergency stop button has been pressed, reset it and then press the control power ON button.

★ 1258 **Door open confirmation**

The APC door open confirmation has been impossible for more than one[s]. The door open condition is not detected one [min] after the door open command is executed.

[Character-string] 'OFF '

The APC door open confirmation stays ON for five seconds or over after the door close command was given.

[Code] None

For APC of crosswise loading type

[Code]

- None ->A-pallet
- 1-> B-pallet

★ 1259 **Excessive deviation velocity**

The actual spindle speed is higher than 125% of the commanded spindle speed. Or the actual spindle speed is lower than 75% of the commanded spindle speed.

[Code] Hexadecimal number of actual rotation speed

[Probable Faulty Locations]

- 1) Spindle pulse generator
- 2) VAC board

★ 1260 **Air pressure low**

Pressure of the air supplied to the machine is lower than the specified value.

[Index] None

[Character-string] None

[Code]

- None The air pressure has dropped.
- 10 The pressure normal signal for the wind-up unit of built-in attachment (B/C-axis 1()) is OFF for two seconds or over.

★ 1261 **Oil-air lube motor overload**

The oil-air lubricating unit motor overload input signal is turned off when the air drier in-operation input signal is on.

★ 1262 **Oil-air lube**

The oil-air lubricating unit motor OK input signal stays off for more than 1[s] when the air drier in-operation input signal is on.

[Index] None

[Character-string] None

[Code] None

On ST-20, the oil-air unit for tool lubrication does not operate normally.

[Index] None

[Character-string] None

[Code]

- 1-> The proximity switch for confirming oil air pressure (OAIR) is OFF for one second or over.
- 2-> The pressure normal signal (OLPS) from the proximity switch for oil-air lubrication unit does not come ON while oil-air lubrication is activated.

[Probable Faulty Locations]

Wrong data setting or malfunction of the oil-air unit On S-30, the oil-air unit for tool lubrication does not operate normally.

[Index] None

[Character-string] None

[Code]

- 30-> After the oil-air lubricating output (OAON) on, even though it passed 60 seconds, the pressure normal signal (OLPS) from the proximity switch for oil-air lubrication unit did not turn it on.
- 31-> Before the oil-air lubricating output (OAON) was turned off, the pressure normal signal (OLPS) from the proximity switch for oil-air lubrication unit turned it off.
- 32-> When the oil-air lubricating output (OAON) turned it on, the pressure normal signal (OLPS) from the proximity switch for oil-air lubrication unit has turned it on.
- 33-> The proximity switch for confirming oil air pressure (OAIR) is OFF for two seconds or over.

★ 1263 **Oil-air lube level low**

The lubricating oil unit level lower and the lubricating oil level normal sensor input signal stays off for more than 3 [s] when the air drier in-operation input signal is on.

[Index] None

[Character-string] None

[Code] None

★ 1264 **Mist air lube unit**

The signal for indicating normal condition of the attachment mist lubricating unit is OFF.

[Probable Faulty Locations]

Trouble in the attachment mist lubricating unit

Referencial Document Instruction manual for attachment mist lubricating unit

★ 1265 **Hydraulic unit**

An alarm occurred with the user-specification hydraulic unit.

An alarm occurred with the hydraulic unit which is prepared by the user or its related unit.

[Character-string] None (See Note 1.)

[Code] None (See Note 2.)

[Probable Faulty Locations]

- 1) Hydraulic unit
- 2) Hydraulic unit related units

Note 1: Character-string is displayed according to the user-specification.

Note 2: Code is displayed according to the user-specification.

[Related Specifications] Instruction manual for user-specification unit

**★ 1266 Tolerance control error**

The tolerance control could not be executed due to an error in the NC control software processing.

Note: This alarm is not related with operators error.

[Code]

1-> Writing to the GD buffer was not successful while the tolerance control module was executed under the condition that the tolerance control mode was selected and that the high-speed mode setting was not "0".  
Or, reading from the GD buffer was not successful while the interpolation module was executed.

100-> Though it computing centrum by smoothing processing of tolerance control mode, it failed.

[Probable Faulty Locations] Problem with software

[Measures to Take] Inform us.

**★ 1267 Fieldnet communication**

Communication error in fieldnet

[Character-string] None.

[Code] AAXXYYZZ

AAXX (error information word)

AA :

bit15: 1 is set when the start-bit error, stop-bit error, or CRC error has been detected in the slave station.

1 is set when the dual send error, buffer error, or parity error has been detected.;

bit12: 1 is set when the start-bit error has been detected.

bit11: 1 is set when the stop-bit error has been detected.

bit9.8: 0 and 0 Slave and master stations

0 and 1 Regenerative repeater No. 1

1 and 0 Regenerative repeater No. 2

XX :

bit 7-bit 0:Slave station number

The slave se station number in which an error has been detected "00" is set when an error has been detected first in the master station. Data at bit 5 indicated whether an error has been detected or not. When "1" is set at bit 5 on receipt of data, it indicates that an error has been detected before the current station.

YY (error occurrence condition) :

1-> Field network input data reading

2-> Data communication is not complete by the next interruption during field network communication

4-> A error is generated more than four times in field network initial scanning.

8-> A error is generated more than one time in field network bus initial scanning

ZZ (error information from the FN card) :

2-> Timeout

4-> Broken line command detection

8-> Parity error

10-> CRC error

20-> Format error

40-> Dual receive error

80-> Dual send error

More than one time

★ 1268 **Spindle revolution condition error**

★ 1269 **Spindle air curtain pressure low**

★ 1270 **VAC operation command mismatch with conditions**

The condition in which the operation command output from the EC to the VAC and the response input from the VAC to the EC do not agree with each other has continued for more than 2[s].

[Code] Address of the command which caused the mismatch at the EC-P's internal IF-B.

3F52-> Basic command

(Speed control mode/Position control mode);

3F53-> Individual command

(Rotation-stop/Forward-reverse/Shorter-/longer-path/Reset);

3F54-3F57: Additional commands

[Probable Faulty Locations]

- 1) VAC card
- 2) SPC-6 or FN card
- 3) Wiring for serial communication

[Measures to Take]

Replace the unit involved with the error.

Related Specifications High-precision VAC

★ 1271 **Interference**

Activated when the axis Overload Monitor setting value (at PARAMETER screen) is exceeded (this error applies to the MCR-B-II Model with Interference Monitoring function).

[Index] Monitored axis

[Measures to Take]

Defective SVP Board, or improper Overload Monitor setting value

Check to see if the actual axis load exceeds the Overload Monitor setting value.

★ 1272 **Thermal deviation compensation**

In compensation of thermal deviation, variation in the temperature data sent from the temperature sensor (TMP) has exceeded the limit set at the thermal deviation compensation parameter.

[Character-string] The problem sensor channel number

[Code]

1-> The temperature measured by TMP has exceeded the temperature monitoring range determined based on the reference channel temperature.

2-> It is impossible to calculate the compensation amount suitable for the temperature measured by TMP. The measured temperature has exceeded the range for setting thermal deviation compensation data.

[Probable Faulty Locations]

- 1) A small value is set as the temperature limit of the relevant channel at the thermal deviation compensation parameter, or the machine generates excessive heat.
- 2) The temperature measured at the problem channel exceeds the setting range of thermal deviation compensation data. (The machine generates excessive heat).

[Measures to Take]

Set a larger value at the thermal deviation compensation parameter or remove the cause of abnormal temperature of the machine.

[Related Specification] Thermal deviation compensation function (used only by the user)

★ 1273 **Attachment Index Limit**

The BC-axis attachment has hit an emergency limit.

[Code]

- 1-> The attachment has hit the B-axis emergency limit.
- 2-> The attachment has hit the C-axis emergency limit.

★ 1274 **Compressor Breakdown**

The air compressor breakdown signal has come ON. (User-selectable specification)

★ 1275 **VAC master CPU down**

The master CPU on the VAC board has stopped. (For the slave CPUs, the stopped state is detected by the alarm "VAC self diagnostic error".) On occurrence of this alarm, the motor stops after free run. To be more specific, the master CPU increases the counter value every 3.2 ms and a slave CPU monitors this counter every 3.2 ms. If this counter stops, the slave CPU causes this alarm.

[Probable Faulty Locations]

- Defective VAC card
- Defective VAC software

[Measures to Take] Change the unit having the above defective part.

[Related Specifications] High-accuracy VAC

★ 1276 **Door interlock reset**

When the D/U status is changed from OFF to ON on the machine with the door interlock function having D/U shutoff function, the distance between commanded position and encoder-detected position exceeds the limit.

[Index] AXIS

[Code]

Difference between commanded position and encoder- detected position in hexadecimal number [reference unit]

[Probable Faulty Locations] The axis was manually moved while D/U was OFF.

[Measures to Take] Reset the NC.

[Related Specifications] D/U shutoff function of door interlock function

★ 1277 **Door interlock**

On the machine with door interlock function, the door was opened during axis movement, spindle rotation, or ATC movement.

[Code] X

None: The door was opened during axis movement, spindle rotation, or ATC/ APC operation.

10: The safety rubber switch was OFF when the front door close command was given.

11: The signal from safety rubber switch went OFF while the front door was closed.

[Probable Faulty Locations]

- 1) Operation error
- 2) Malfunction of the door close confirmation limit switch or defective dog position

[Measures to Take]

- 1) Do not open the door during axis movement or spindle rotation
- 2) Replace the limit switch if defective. Adjust the dog position so that the confirmation limit switch comes ON when the door is closed.

★ 1278 **Door open/close limit switch N.G.**

When the power is supplied, the open/close end limit switches of the operation door or front door are both ON or OFF.

[Probable Faulty Locations] Malfunction of door open/close end limit switches

[Measures to Take] Check and replace a faulty door open/close end limit switch.

★ 1279 **Axis movement prohibition**

During B-axis movement, X-axis is not located within 10 mm from the machine zero or the door open confirmation signal is OFF.

Or, during B-axis movement, Z-axis is not located within 50 mm from the plus limit.

Or, X or Y-axis movement was prohibited during the turning cut cycle.

[Index] AXIS

[Character-string] None

[Code]

- 1) X-axis is over +-10 mm away from machine zero.
- 2) The door open confirmation signal is OFF.
- 3) Z-axis is not within 50 mm from plus limit.
- 4-> During B-axis movement, the other axes command (X, Y or Z) was specified.
- 5-> X-axis shifted from its home position No.1 during B-axis movement.
- 6-> Z-axis shifted is from its home position No. 3 exceeding the allowable range of +-100 mm.
- 100-> During the turning cut cycle, X/Y-axis traverse was prohibited for some reason, resulting in deceleration stop of the infinite circular interpolation.

★ 1280 **Axis change control unusual**

The changed axis is in abnormal state or the axis change cannot be morally controlled.

[Code]

- 100-> MA-axis enabling LS and TS-axis enabling LS are both ON.

★ 1288 **Conflict emergency stop**

During axis movement, the collision detection sensor is activated by sensing collision, causing the machine to make an emergency stop.

[Code]

- 1) Ring sensor detected collision.
- 2) Touch switch detected collision.

[Probable Faulty Locations]

There is no problem if the machine is in contact with the workpiece. If, however, this alarm occurs when the machine is separated from the workpiece, the sensor may be at fault.

If the tool is provided with a collision preventive sensor, the tool and its tool holder may not be perfectly insulated.

[Measures to Take]

If this alarm occurs due to contact with the workpiece, set on the collision preventing function disabling switch to separate the machine from the workpiece. If this alarm occurs though the machine is away from the workpiece, check the sensor for operation or the tool for insulated condition.

★ 1289 **Tool breakage detection undertravel**

When a fixed cycle was attempted in the fixed cycle mode including tool breakage detection (G195), the breakage detector contacted the tool before reaching the anticipated position (LP command value) and the difference between anticipated position and actual contact position is larger than the allowable limit (set at the NC optional parameter long word No. 46).

[Index] AXIS

[Probably Faulty Location]

Improper tool length offset data, or wrongly selected tool number, tool length, or zero point

[Measures to Take] Correct the wrong data.

★ 1290 **Tool breakage**

When a fixed cycle was attempted in the fixed cycle mode including tool breakage detection (G195), the breakage detector passed the anticipated position(LP command value) and contacted the tool at a position exceeding the allowable limit(a position specified by LD command or set at the NC optional parameter long word No. 45) or failed to contact. Thus, NC caused this alarm.

[Index] AXIS

[Code]

- 1-> The sensor contacted the tool at a position where the distance from the anticipated position is larger than the allowable limit.
- 2-> The allowable limit was exceeded without contact.

[Probable Faulty Locations]

The tool is broken.

Improper tool length offset data, or wrongly selected tool number, tool length, or zero point

[Measures to Take]

- Replace the broken tool.
- Set correct values.

★ 1291 **B position error**

When B-axis was not located either in 0° or 90° position on DCC, skip feed (G31) was specified in automatic tool length offset, automatic tool brakeage detection or the other operation. Or, B-axis moved from 0° or 90° position during skip feed.

When B-axis is located either in 0° or 90° position on DCC, displaying the interactive gauging screen was attempted.

Or, B-axis moved from 0° or 90° position while the interactive gauging screen was displayed.

[Probable Faulty Locations] B-axis angle

[Measures to Take]

To carry out skip feed (G31) or display the interactive gauging screen, ensure that the B-axis is in 0° or 90° position.

★ 1292 **Work clamp miss**

This alarm occurs on the machine with clamp-miss detecting function in the following case:

While the constant monitoring is selected and the spindle is rotating, the proximity switch fails to send work clamp confirmation signal for 0.5 second or over.

This alarm also occurs on the machine with chucking error detecting function, if the chucking error signal is sent during spindle rotation.

[Index] None

[Character-string]

None->Constant monitoring is selected and the proximity switch failed to send signal for 0.5 second or over during spindle rotation.

- 2-> Chucking error was detected (by the chucking error detecting function).

[Related specifications] Chucking error detecting function

★ 1293 **Adaptive control communication error**

It was generated error in adaptive control mode.

[ Code ] XYZZ

X=0:(error code 4 figure below at the time of)

->YYZZ=An adaptive control communication error number

X=1:

An open instruction ended up an error.

YY= error code, ZZ= error details code



->When YY,ZZ is NONE(0),An open instruction was not completed within a specific time.

X=2:

A compulsion close was not completed within a specific time.

**★ 1294 Shift value error**

[Index] Axis

[Code] X

X=1-> When it was not in shift superposition, a shift quantity was not 0 and became. (status no check)

X=2-> As the result that a shift quantity was added, CON became negative.

X=3-> As the result that a shift quantity was added, CON surpassed plus variable limit.

X=4-> As the result that a shift quantity was added, CON surpassed minus variable limit.

X=5-> A shift quantity did not solidarity with lock state anticus at the time of shift quantity lock state quittance.

**★ 1295 Tailstock quill over advance**

Tailstock quill over advance

When the main program is not in performance,it becomes alarm B.

[index] None

[character string] None

[code] None

[Probable Faulty Locations]

1-> Before a place of tailstock is too remote and came in contact with it in workpiece, it attacked a limit switch of over go-ahead.

2-> It was not related that there is not workpiece and performed advance request of tailstock quill.

[Measures to Take]

1-> It brings close a place of tailstock to workpiece.

Or, it adjusts dog.

2-> It attaches workpiece and performs advance request of tailstock quill.

**★ 1296 Tailstock quill condition**

When there was a cycle instruction of the main shaft, tailstock quill was not a fixed place.

[index] None

[character string] None

[Code]

1-> Tailstock quill deviated from a fixed place in a main shaft cycle.

[Probable Faulty Locations] Inferiority of a limit switch, Adjustment inferiority of dog.

[Measures to Take]

It switching limit.

It performs readjustment of dog.

**★ 1297 Chuck condition**

When there was a cycle instruction of the main shaft, a Chucking was not clamping.

[index] None

[character string] None

[Code]

1-> A Chucking was not clamping in a main shaft cycle and became.

2-> Before a chuck close case of outside diameter grasp, a timer counted it up,before which a chuck close end position turned off or a chuck close case of an inside diameter grasp, a timer counted it up, a chuck close end position turned it off.

[Probable Faulty Locations] Inferiority of a limit switch, Adjustment inferiority of dog

[Measures to Take]

It switching a limit switch.

It performs readjustment of dog.

★ 1298 **Robot / Loader escape position**

The NC with a robot/loader interface received a cycle start or ceiling door close command while the robot escape position input was OFF.

[Index]

[Character-string]

[Code] X

X=1-> Reception of a cycle start command

X=2-> Reception of a ceiling door close command

[Probable Faulty Locations] Faulty robot command

[Measures to Take] Issue a proper robot command.

★ 1299 **Axis overload**

Axis load has exceeded the limit value set for monitoring overload.

[Index]Axis

[Character-string] None

[Code]

Overload monitored

XYYYY

X: Overload monitoring parameter No.

YYYY: Load that caused the alarm [%]

[Probable Faulty Locations]

- The ongoing cutting causes overload.
- An improper value was set at the axis load detection meter.

★ 1300 **Fixed cycle Thread feed**

'Feed' became a negative value during the thread-cutting operation. (Unsuitable for 'F' thread pitch command and 'E' variable pitch command.)

★ 1301 **External rotary table error**

The [NC DU OK] signal went OFF when the external rotary table is under NC control.

Or, no response was sent within the preset time.

[Index] None

[Character-string] None

[Code] XYYYY

X: Axis No. being controlled

1: 4th axis

2: 5th axis

3: 6th axis

YYYY: Control mode selected when the alarm occurred

0000: Axis command output mode

0001: Waiting after strobe is turned ON

0002: Answer ON monitor mode

0003: Answer OFF monitor mode

0004: Waiting until the next axis command is output

[Probable Faulty Locations]

External rotary table or its related part is faulty, or improper time is set at the optional parameter long word No. 42.

★ 1302 **Cycle time over**

The time required to execute one cycle (from cycle start to reception of M02 or M30) has exceeded the time set at the parameter.

[Index] None

[Character-string] None

[Code] None

★ 1303 **SPM Data transfer**

In the data transferring task of SUPER MAIN CARD (SPMC), an error was detected in the data transferring with SUPER MAIN BOARD (SPMB).

[Code] 3XYZZZZZ

X: The transfer kind

=0: SPMB-->SPMC

=1: SPMB-->SPMC (Multi forwarding)

=8: SPMB<--SPMC

=9: SPMB<--SPMC (Multi forwarding)

Y: The transfer unit (The number of bytes)

ZZZZZ: The least significant 20 bits of an error occurrence address

[Probable Faulty Locations]

- 1) Faulty SPMC
- 2) Faulty SPMB
- 3) Faulty software

★ 1304 **SPM Undefined error information**

The error information format out of the prescription was received from SUPER MAIN CARD (SPMC).

[Code] Received error information format

[Probable Faulty Locations] Faulty software

★ 1305 **SPM Control error**

Fatal abnormality that the processing can not be continued by the control program of SUPER MAIN CARD (SPMC) was detected.

[Code]

- 2000100: B Buffer Abnormality of Super Control Interval Code
- 2000200: B Buffer Abnormality of G code
- 2001000: B Buffer Abnormality of Dryrun Function Flag
- 2001100: B Buffer Abnormality of Feedrate Override Function Flag
- 2001110: B Buffer Abnormality of Soft Feedrate Override Function Flag
- 2001120: B Buffer Abnormality of Feedrate Override Function Flag
- 2001200: B Buffer Abnormality of Spindle Override Function Flag
- 2001300: B Buffer Abnormality of Single Block Function Flag
- 2001400: B Buffer Abnormality of Slide Hold Function Flag
- 2002000: B Buffer Abnormality of F1 Feedrate Order Number
- 2002100: B Buffer Abnormality of NC Program Instructions Unit
- 2002300: B Buffer Abnormality of Data Block Sequence Number
- 2002400: B Buffer Abnormality of F1 Feedrate Override

2002500: B Buffer Abnormality of F code direct Feedrate  
2002600: B Buffer Abnormality of S code direct Spindle Velocity  
2002700: B Buffer Abnormality of Program Tolerance  
2002800: B Buffer Abnormality of Machining Tolerance  
2003200: B Buffer Abnormality of ARC:Vector(Start->Center)  
2003210: B Buffer Abnormality of ARC:Vector(Center Axis)  
2003220: B Buffer Abnormality of ARC:Vector(End->Center)  
2003240: B Buffer Abnormality of ARC:Radius  
2003300: B Buffer Abnormality of HELICAL:Vector(Start->Center)  
2003310: B Buffer Abnormality of HELICAL:Vector(Center Axis)  
2003320: B Buffer Abnormality of HELICAL:Vector(End->Center)  
2003340: B Buffer Abnormality of HELICAL:Radius  
2003400: B Buffer Abnormality of NURBS:Degree(Order-1)  
2003420: B Buffer Abnormality of NURBS:Knot Sequence  
3002300: C Buffer Abnormality of Data Block Sequence Number  
4000000: E Process Can't interpolate NURBS Data (0-differential).  
4002300: D Buffer Abnormality of Data Block Sequence Number  
5000000: F Process Can't interpolate NURBS Data (0-differential).  
5002300: E Buffer Abnormality of Data Block Sequence Number  
5006000: F Process data block length error  
6000600: F Buffer Abnormality of Interpolation Data Sequence Number  
F000000: T Process Abnormality of Control Parameter  
10000000: TB Data Manager The abnormal (end of the beginning) detection on the continuous sequence  
10000001: TB Data Procedure The G code violation in implementation block  
10000002: TB Data Procedure The plane specification violation in implementation block (Unreasonable axis index)  
10000004: T Ground Manager Data Transfer Replying Timeout  
10000005: TH Data Manager Serial Number Irregular

[Probable Faulty Locations] Faulty software

★ 1306 **Door close/open answer**

The automatic door open/close command was issued but the command output did not match the status input. As a result, the answer did not come back within the time set (in seconds) at the machine user parameter (word) No. 35.

[Index] None

[Character-string] None

[Code] X

X: 1 Operator door

[Probable Faulty Locations] Automatic door

★ 1307 **Thermal deviation compensation**

Temperature rise calculated board on the axis deviation amounts of the individual axis exceeded the temperature limits set for them.

[Index] None

[Character-string]

Temperature of 'HOT SENSOR' ,temperature of 'BASE TMP SENSOR' (in decimal , unit of designated [0.1 cent.]

[Code]XY

X=1-> Temperature rise exceeded the limit.

Y=1-> X-axis thermal deviation1  
Y=2-> X-axis thermal deviation2  
Y=3-> X-axis thermal deviation3  
Y=4-> Y-axis thermal deviation1  
Y=5-> Y-axis thermal deviation2  
Y=6-> Y-axis thermal deviation3  
Y=7-> Z-axis thermal deviation1  
Y=8-> Z-axis thermal deviation2  
Y=9-> Z-axis thermal deviation3  
Y=A-> Deviation of attachment spindle.

[Probable Faulty Locations]

- 1) TMP error. Or, the machine is generating abnormal heat.
- 2) A too small value is set as the limit for the problem channel at the thermal deviation compensation parameter.  
Or, the machine is generating abnormal heat. (The machine is generating abnormal heat.)

[Measures to Take]

Increase the limit value set at the thermal deviation compensation parameter. Or, find and eliminate the cause of the abnormal heat generated in the machine.

[Related Specifications] Thermal deviation compensation function

★ 1308 **Limit Switch error**

[Character-string] None

[Code] None

[Probable Faulty Locations] Limit switch

★ 1309 **Vacuum system abnormal**

The pressure normal signal for vacuum chuck is OFF for three seconds or over.

[Index] None

[Character-string] None

[Code] None

[Probable Faulty Locations] Abnormality occurs in the vacuum unit pump.

★ 1310 **Sub program select**

An invalid sub program was selected.

[Index] None

[Character-string] None

[Code] None

[Probable Faulty Locations]

The selected sub program issued a command for calling a sub program other than those already registered on the stack as the custom macro (MSB & LIB).

[Measures to Take]

Reedit the selected sub program so that it does not call an invalid sub program. Or, register the sub program to be called as a custom macro to the library.

★ 1311 **Super Hi-NC Control cannot execute**

Super Hi-NC control is attempted though the conditions for enabling such control are not met.

[Code] XYY

X=1: Processing for NURBS interpolation and function generation other than NURBS commands are executed at the same time.

YY: Other commands specified together with the NURBS interpolation command

bit 0: Positioning command (G00)

1: Linear interpolation command (G01)

2: Circular interpolation or helical cutting (G02/G03)

3: Dwell (G04)

4: Manual shift amount cancel (G191)

7: Tolerance control mode ON (G187)

[Probable Faulty Locations]

Error in designing NC control software

X=F: The return search is executed to return to the middle of NURBS block.

YY =01: Option code MX is specified.

=02: Option code MY is specified.

=03: Option code MZ is specified.

=04: Option code TS is specified.

[Measures to Take]

The above option codes are not usable for return search to the middle of NURBS block. Execute return search without specifying these option codes.

**★ 1312 Safety Speed over**

The speed exceeds the safety speed limit.

[Index] None

[Character-string] None

[Code]XY

X=1: NC-axis has exceeded the safety speed.

X=2: PLC-axis has exceeded the safety speed.

X=3: The spindle has exceeded the safety speed.

Y: Indicates the axis number that caused this alarm.

To release this alarm, turning off the power and turn it back on.

**★ 1313 Safety speed monitor error**

The safety speed monitor needs to be recovered if it enters the emergency stop state for reasons such as speed over alarm.

This alarm notifies that it is necessary to turn off the power and turn it back on to recover the monitor.

[Index] None

[Character-string] None

[Code] None

To release this alarm, turning off the power and turn it back on.

**★ 1314 Hi-CUT Pro 2 Control cannot execute**

Execution of Hi-CUT Pro 2 Control was attempted though such conditions are not met.

[Index] None

[Character-string] None

[Code] XYY

XYY=200->Teaching mode was detected in the super Hi-NC control state.

[Measures to Take]

Turn off the teaching mode before executing the super Hi-NC control.

★ 1315 **Touch probe Conflict prevention**

An axis movement command was issued after the NC received the contact signal from the touch probe mounted on the spindle.

But the command value exceeds a travel limit for preventing collision of the touch probe. These travel limit values are set at the optional parameter (long word) No. 62.

[Index] Axis

[Character-string] None

[Code] None

★ 1316 **Servo data error**

Servo data that corresponds to the specified servo data number does not exist. Or, more than one servo data corresponds to the specified servo data number.

[Index] None

[Character-string] None

[Code]

- 1: There is no servo data that corresponds to the specified servo data number.
- 2: More than one servo data corresponds to the specified servo data number.

[Probable Faulty Locations] Servo data file

[Measures to Take]

To release this alarm, set the servo data number that corresponds to a single piece of servo data, and then turn off the power and turn it back on.

★ 1317 **Axis oscillation command stroke over**

The axis oscillation speed has exceeded the maximum rapid traverse.

[Index] Axis

[Character-string] None

[Code] Commanded stroke value (Axis oscillation stroke value \* compensation amount K)

[Probable Faulty Locations] The oscillation stroke value (VOSTK) is too large.

★ 1318 **Axis oscillation CON speed over**

The sum of the axis oscillation speed and the feedrate has exceeded the allowable speed range.

[Index] Axis

[Character-string] None

[Code] Variation amount of RCON (calculated value) in hexadecimal

★ 1319 **DIFF over**

The following error (calculated value - actual position) has exceeded the allowable limit set at the parameter.

[Index] Axis

[Character-string] None

[Code] Absolute value of DIFF in hexadecimal

[Probable Faulty Locations]

- 1 The ball screw or bearings of the problem axis is faulty, which causes high sliding resistance.
- 2 The encoder, motor or drive unit (D/C) of the problem axis
- 3 The servo parameters of the problem axis
- 4 SVP board of the problem axis

★ 1326 **Abnormal temperature rise**

The temperature rise value has exceeded the set limit.

[Index] None

[Character-string]

Measured value of the 1st temperature CH, the 2nd temperature CH, the 3rd temperature CH, or the reference temperature CH (displayed as a decimal number in units of 0.1 degree)

[Code] XX: = Estimated temperature No. 1 to 16

[Probable Faulty Locations]

Abnormal temperature rise of the machine

Sensor error at the problem temperature CH

TMP board error

Improper data is set as the temperature limit parameter.

[Measures to Take]

Check the problem temperature sensor and its periphery to remove the cause of abnormal temperature rise.

Check the problem temperature sensor to see if it is properly installed.

Replace the problem temperature sensor.

Replace the TMP board.

Review the temperature limit parameter.

[Non-generative conditions]

This alarm does not occur if "0" is set at the temperature limit parameter.

★ 1701 **Emergency stop**

Emergency stop button is pressed.

[Index] None

[Character-string] None

[Code] None

[Measures to Take]

After removing the cause for which the emergency stop button has been pressed, reset it and then press the CONTROL ON button.

★ 1702 **Axis motor overload**

The overload relays for X-, Y- or Z-axis is tripped.

[Index] AXIS

[Character-string] None

[Code] None

[Probable Faulty Locations]

- 1) Cutting under overload condition.
- 2) Motor load is high due to insufficient slideway lubrication.
- 3) Faulty axis drive motor(s).

[Measures to Take] Turn off power supply to cool the motor.

★ 1703 **Axis interlock**

Axis movable conditions for the axis for which axis movement command is given during automatic mode operation have been off for five seconds or over The pulse handle shift switch is turned on during ATC or APC operations.

[Index] AXIS

[Character-string] None



[Code] Machine diagnostic number in hexadecimal

★ **1704 Stroke end over**

A travel end limit switch of X-,Y- or Z-axis is activated.

[Index] None

[Character-string] None

[Code] None

[Probable Faulty Locations]

- 1) Defective setting of the system parameters
- 2) Malfunction of the limit switch

[Measures to Take]

Fine out which limit switch is activated on the check panel.  
Move the overtraveling axis toward the middle of the travel.

[Referential Instruction Manual] Maintenance Manual

★ **1705 Sequencer counter over**

Abnormal ATC, APC or AAC operation sequence number

[Index] None

[Character-string] None

[Code]

None: ATC  
80: APC  
100: AAC

[Probable Faulty Locations]

- 1) Faulty PLC program
- 2) FCP board

[Measures to Take]

- 1) Run the PLC program of a new version.
- 2) Change the FCP board.

★ **1706 Spindle over-speed**

The actual spindle speed has exceeded 125% of the maximum speed set for each gear or winding.

[Index] None

[Character-string] None

[Code] None

[Probable Faulty Locations]

- 1) Spindle VAC data file
- 2) Spindle VAC drive unit
- 3) Spindle pulse generator

★ **1707 Spindle rotation interlock**

The alarm occurs is spindle rotation enable condition are turned off or for 0.5 second or over during spindle rotation.

[Index] None

[Character-string] None

[Code] Machine diagnostics number in hexadecimal

[Probable Faulty Locations]

- 1) The spindle is mechanically placed in the rotation disabled condition.
- 2) Malfunctioning LS's which constitute spindle rotation conditions.

★ 1708 **Magazine system being checked**

No measures are taken to cope with this alarm.

★ 1709 **Outside**

An error has occurred in an external device, such as a robot or loader.

[Index] None

[Character-string] None

[Codes]

None->An alarm exists in the robot or loader control unit for the machine equipped with a robot or loader.

10-> An alarm has occurred in the indexing table.

[Probable Faulty Locations]

- 1) The robot or loader control unit is faulty.
- 2) The indexing table is faulty.

★ 1710 **Excessive speed deviation**

No measures are taken to this alarm.

★ 1711 **Air pressure drop**

The pressure of the air supplied to the machine has dropped.

[Index] None

[Character-string] None

[Codes]

10-> The oil shot air pressure normal signal went OFF when an oil shot command was issued.

11-> The hoist pressure normal signal remained OFF for more than 0.5 seconds during C-axis indexing.

20-> The air dryer clogging signal remained OFF for more than 30 seconds.

★ 1712 **Travel end limit release**

The stroke end limit reset button is pressed in other than the manual operation mode.

[Index] None

[Character-string] None

[Code] None

[Measures to Take] Perform stroke end limit reset operation in the manual mode.

★ 1713 **Axis change control error**

A trouble occurred in the ATC axis change process.

[Index] None

[Character-string] None

[Code]

3-> The limit switch failed to come on within five seconds after the gear change signal was sent to the solenoid valve.

[Probable Faulty Locations]

- 1) The shift gear shaft pin is not aligned with the pin hole.

[Measures to Take]

- 1) Align the pin with the pin hole.

★ 1714 **VAC not ready**

Though the axis power ON signal was activated, the NC failed to send the spindle operation ready signal within the "1.MCS charging time" set at the [7.MCS] machine system parameter.

[Index] None

[Character-string] None

[Code] None

[Measures to Take]

- 1) Increase the parameter-set time.
- 2) Change the VAC unit.

★ 1715 **Coolant low level**

The coolant level is low.

The float switch within the coolant tank turned OFF the coolant normal signal or turned ON the coolant error signal when a high-pressure oil hole command was executed.

[Index] None

[Character-string] None

[Codes]

- 1-> The oil lower limit signal from the separation tank 2 remained OFF for more than three seconds.
- 2-> The water lower level signal from the separation tank 2 remained OFF for more than three seconds.
- 10-> The low coolant level signal remained ON for more than three seconds.

[Measures to Take] Supply coolant to the tank.

★ 1716 **Thru-the-tool coolant filter clog**

The filter within the oil hole coolant tank is clogged.

[Index] None

[Character-string] None

[Code] None

- 10-> Filter clogging was detected during output of the coolant pump motor signal.

[Probable Faulty Locations]

- 1) The filter is clogged.
- 2) The clogging detection pressure switch is faulty.

[Measures to Take] Clean the filter.

★ 1717 **Parameter transfer error**

Data transfer is not normally carried out between the built-in PLC and the NC.

[Index] None

[Character-string] None

[Code] XXYYZZZZ

XX: Classification No. (hexadecimal)

YY: Item No. (hexadecimal)

XX = 01: Common variable

YY = 00 (always)

XX = 14: Magazine tool data

YY = 00: Active tool

YY = 01: Next tool

YY = 02: Magazine pot tool

XX = 65: PLC axis data

YY = 00 (always)  
ZZZZ: Error code (hexadecimal)  
= 0001: Window function data  
= 0002: Window data classification number  
= 0003: Window data item number  
= 0004: Window data axis number  
= 0005: Window data number  
= 0006: Window data format  
= 0007: Window data size  
= 0008: Number of window data pieces  
= 000B: Setting range over  
= 000C: Write error  
= 000D: Data overflow  
= 000E: Data underflow  
= 000F: Empty

**★ 1718 Hydraulic motor overload**

The overload relay protecting the hydraulic pump motor is tripped.

[Index] None

[Character-string] None : Combination unit

'ATC': Hydraulic power unit for ATC

'APC': Hydraulic power unit for APC

'W': Hydraulic power unit for W-axis balancer

[Code] None

[Probable Faulty Locations]

1) Faulty hydraulic pump motor

[Measures to Take]

Reset the overload relay inside the hydraulic pump unit or the combination unit.

[Referential Instruction Manual] Instruction manual for the combination unit

**★ 1719 Control circuit breaker**

The EC control circuit breaker is tripped.

[Index] None

[Character-string] None

[Code] 1

[Measures to Take]

Return the breaker to the close position and turn off the power. Then, turn on the power again.

**★ 1720 Transformer overheat**

The line voltage conversion transformer has overheated.

[Index] None

[Character-string] None

[Code] 1

[Measures to Take] Shut off the power and cool down the transformer.

**★ 1721 Power ON/OFF sequence error**

The NC found an abnormality in the power circuit by checking the axis control ON relay for actuation when the power is turned off and when the power is turned on.

[Index] None

[Character-string] None

[Code] 3

[Probable Faulty Locations]

Malfunction of the 100-ms delay timer for emergency stop and the axis control ON relay that turns on or off the PLC.

★ 1722 **Door interlock reset**

When D/U status is changed from OFF to ON on the machine with the door interlock function having D/U shutoff function, the distance between commanded position and encoder-detected position exceeds the limit.

Or, when D/U status is changed from ON to OFF or when D/U status is changed from OFF to ON during synchronized tapping on the machine with the door interlock function having D/U shutoff function, the difference between commanded spindle degree and encoder-detected spindle degree exceeds the limit angle (more than 1 degree).

[Index] Axis name or none (spindle)

[Character-string] None

[Code]

Difference between commanded position and encoder-detected position in hexadecimal number (reference unit)

[Probable Faulty Locations]

The axis (spindle or linear axis) was manually moved while D/U was OFF.

[Measures to Take] Reset the NC.

[Related Specification] D/U shutoff function of door interlock function.

★ 1723 **Door interlock**

On the machine with the door interlock function, the door was opened during operation of the axes, spindle, ATC, and APC.

[Index] None

[Character-string] None: Door

'BARR': Photoelectric switch

[Code] X

[Probable Faulty Locations]

- 1: Incorrect operation.
- 2: The door close confirmation limit switch is faulty, or the dog is out of position.
- 10: The safety rubber switch is turned OFF when a front door close command is issued.
- 11: The safety rubber switch is turned OFF while the front door is closing.

[Measures to Take]

- 1: Keep the door closed while the axes are operating or the spindle is running.
  - 2: Replace the door close confirmation limit switch if it is faulty.
- When the door is closed, adjust the dog by tapping the door close confirmation limit switch.
- 10, 11: If something is caught in the door, remove it.
- Inspect the safety rubber switch.

★ 1724 **Door open/close limit N.G.**

When the power is supplied, the open/close end limit switches of the operator door or front door are both ON or OFF.

[Index] None

[Character-string] None

[Code] None

[Probable Faulty Locations] Malfunction of door open/close end limit switches

[Measures to Take] Check and replace a faulty door open/close end limit switch.

★ 1725 **Door open confirmation**

[Index] None

[Code] None

Code for crosswise APC: None = Pallet A

Code for crosswise APC: 1 = Pallet B

Code for crosswise APC: OFF = The door open limit switch remains ON for more than five seconds during execution of a door close command.

★ 1726 **Spindle overload**

The spindle load detection meter relay has been turned on due to overload.

[Index] None

[Character-string] None

[Code] None

[Probable Faulty Locations]

- 1) Cutting under overload condition
- 2) Setting error of the spindle load detection mater relay
- 3) Error in setting the startup current immune period which is set at the "4.Spindle overload time" [6.Spindle] machine user parameter.

★ 1727 **PLC system error**

No PLC system code data file is loaded in the memory.

[Index] None

[Character-string] None

[Code] 1

★ 1728 **Oil air lube**

An error has occurred in the oil-air lubrication unit.

[Index] None

[Character-string] None

[Codes] None

The oil-air lubrication unit normal signal remained OFF for more than one second during output of the oil-air lubrication unit. Or, the oil-air lubrication unit error signal remained ON for more than one minute.

20-> The oil-air lubrication pump normal signal remained OFF for more than one second.

21-> The oil-air low pressure detector did not become OFF when the pump start switch was OFF.

22-> The oil-air pressure increase detector failed to come ON within 45 seconds after the pump start switch was turned ON.

23-> The oil-air pressure increase detector became deactivated before the pump start output signal went OFF.

24-> The oil-air pressure increase detector became activated before the pump start output signal came ON.

★ 1729 **PLC data file**

A PLC-related data file was not loaded properly.

[Index] None

[Character-string] None

[Codes]

- 1 = PLC constant data file
- 2 = ATC logic data file
- 3 = APC logic data file
- 4 = AAC logic data file

[Probable Faulty Locations]

The data file is not installed.

[Measures to Take] Install the data file.

★ 1730 **Cycle time over**

A cycle (the time from the startup to M02 or M30) exceeded the set parameter value.

[Index] None

[Character-string] None

[Code] None

★ 1731 **Work clamp miss**

In a machine equipped with the chucking error detecting function, the seated condition confirmation signal remained OFF for more than 0.5 seconds during constant monitoring of seated condition.

The jig fitting confirmation signal input remained OFF for more than 0.5 seconds during constant jig fitting confirmation monitoring.

[Index] None

[Character-string]

L = Work left side

R = Work right side

JIG1 = Jig 1 or chuck 1

JIG2 = Jig 2 or chuck 2

JIG3 = Jig 3 or chuck 3

[Codes]

1 = The seated condition confirmation signal went OFF while the spindle was running.

20 = The jig fitting confirmation signal went OFF while the spindle was running.

★ 1732 **Machine axis travel limit over**

The travel end limit switch for the machine axis (the straight axis of the ATC carrier, AAC carrier, APC carrier, etc.) became active.

This alarm occurs when the PLC axis emergency stop signal is turned OFF.

[Index] None

[Character-string] None

[Code] None

[Probable Faulty Locations]

1) The machine axis parameter is not set properly.

2) The limit switch is faulty.

★ 1733 **PLC system data**

This alarm occurs when there is any problem with the logic data for the ATC, APC, etc.

[Index] None

[Code] Data address

[Character-string]

'ATC' = Logic data for the ATC

'APC' = Logic data for the APC

[Measures to Take] Reinstall the control software.

★ 1734 **Sequence counter over**

This alarm occurs when the operation number of the ATC, APC, etc. is an improper value.

[Index] None

[Code]

None =ATC

80 = APC

100 = AAC

[Character-string] None

[Measures to Take] Reinstall the control software.

★ 1735 **Hydraulic unit oil level low**

The combination unit hydraulic oil level normal signal remained OFF for more than three seconds while the hydraulic unit was ON.

Or, the hydraulic oil level error signal remained ON for more than three seconds.

[Index] None

[Character-string]

None: Combination unit

'APC': Hydraulic unit for APC

[Code] None

★ 1736 **Spindlehead libe motor overload**

The combination unit lubrication pump operation signal remained OFF for more than one second while the hydraulic unit was ON.

[Index] None

[Character-string] None

[Code] None

★ 1737 **Spindlehead libe oil level low**

The combination unit hydraulic oil level normal signal remained OFF for more than three seconds while the hydraulic unit was ON.

Or, the hydraulic oil level error signal remained ON for more than three seconds.

[Index] None

[Character-string] None

[Code] None

★ 1738 **Door open/close answer**

After a door open/close command was issued, the command output and the status input did not match within the time set at M/C system parameter No. 12 "1. Door open/close monitoring time", and no door open/close answer was returned.

[Index] None

[Character-string] None

[Codes]

1 = The opening of the door was not confirmed.

2 = The closing of the door was not confirmed.

3 = Retraction of the door lock pin was not confirmed.

[Probable Faulty Locations]

1) The door is faulty.



- 2) The door open/close confirmation limit switch is faulty.
- 3) Something or a person is caught in the door.
- 4) The door lock pin is faulty.

[Measures to Take]

- 1) Adjust the door so that it will smoothly open and close.
- 2) Adjust the limit switch so that it will properly operate, or replace it.
- 3) Remove what is caught in the door.

[Related function] Automatic door open/close

★ 1739 **Compressor breakdown**

The air compressor error signal remained ON for more than one second.  
Or, the normal signal remained OFF for more than one second.

[Index] None

[Character-string] None

[Code] None

★ 1740 **Hydraulic pressure drop**

Jig hydraulic unit

The hydraulic pressure normal signal remained OFF for more than three seconds. Or, the abnormal signal remained ON for more than three seconds.

[Index] None

[Character-string]

None: Combination unit

'APC': Hydraulic unit for APC

[Code] None

★ 1741 **Tailstock advance limit**

The tailstock passed beyond the advance limit after a tailstock advance command was issued while the spindle was running.

[Index] None

[Character-string] None

★ 1742 **Tailstock condition**

The tailstock constant rate conformation limit switch remained OFF for more than 0.5 seconds while the spindle was running.

[Index] None

[Character-string] None

[Code]

★ 1743 **Coolant unit**

The coolant unit normal signal went OFF, or the abnormal signal came ON.

[Index] None

[Character-string] None

[Codes]

None = The coolant tank level normal signal went OFF, or the abnormal signal came ON.

10 = The normal signal from the high-pressure coolant unit remained OFF for more than three seconds while the oil wheel was in operation. Or, the abnormal signal kept ON for more than three seconds.

11 = The suction pump abnormal detection signal came ON.

★ 1744 **Robot/Loader condition**

The robot or loader condition is not normal when the system link mode is selected.

[Index] None

[Character-string] None

[Codes] None

10 = The robot/loader retract position signal went OFF while the APC was in operation.

★ 1745 **Lock switch N.G.**

The door lock pin is faulty.

If the door lock pin for the operation door is faulty, this alarm will be displayed without a character-string.

'ATC' will be displayed as a character-string when the door lock pin for the magazine door is faulty.

When there are two or more magazine doors, 'ATC2' is displayed for the front door and 'ATC1' is displayed for the rear door.

[Index] None

[Character-string]

None: Operation door

'ATC' : magazine door

'ATC1' : magazine 1 door, rear magazine door

'ATC2' : magazine 2 door, front magazine door

'ATC3' : magazine 3 door

'ATC4' : magazine 4 door

'APC' : APC setup door

[Codes]

1 = The door was not locked within one second after a door lock command was issued.

2 = The door was not unlocked within one second after a door lock command was canceled.

★ 1746 **Mist air lube unit**

An error occurred in the spindle mist lubrication unit.

[Index] None

[Character-string] None

[Codes]

1 = The oil mist lubrication drop sensor remained ON for more than two seconds.

2 = The oil mist drop lubrication sensor was not turned ON at all for two consecutive cycles performed when the air is turned ON for driving the oil mist lubrication pump.

3 = When the power is supplied, the air ON cycle is performed for driving the oil mist lubrication pump. This cycle was repeated 100 times before the oil mist drop lubrication sensor came ON three consecutive times.

4 = The cumulative operation time of air ON output for driving oil mist lubrication unit exceeded 24 hours with the oil mist coolant level normal signal OFF.

5 = The oil mist lubrication drive pressure normal signal went OFF when the air ON output for driving the oil mist lubrication unit came ON.

6 = The spindle oil mist lubrication drop sensor remained ON for more than two seconds.

7 = The spindle oil mist drop lubrication sensor was not turned ON at all for two consecutive cycles when the air ON cycle is performed for driving spindle oil mist lubrication pump.

8 = When the power is supplied, the air ON cycle is performed for driving spindle oil mist lubrication pump. This cycle was repeated 100 times before the oil mist drop lubrication sensor came ON three consecutive times.

9 = The cumulative operation time of air ON output for driving spindle oil mist lubrication unit exceeded 24 hours with the spindle oil mist coolant level normal signal OFF.

- 10 = The spindle oil mist lubrication drive pressure normal signal went OFF when the air ON output for driving the spindle oil mist lubrication unit came ON.
- 11 = The "air through lubrication unit oil level normal" signal went OFF when a through spindle air blow command was issued.

★ 1748 **Attachment index limit**

The indexing limit for the B-axis or C-axis attachment became active.

[Index] None

[Character-string] None

[Codes]

- 1 = B-axis attachment  
2 = C-axis attachment

★ 1749 **Faulty mode switch**

[Index] None

[Character-string]

None: Interlock mode switch

'ATC' Magazine manual indexing switch

'APC' APC manual indexing switch

[Codes]

- 1 = No signal is input from the mode selector switch.  
2 = Two or more signals are not input from the mode selector switch.

★ 1750 **Spindlehead lubricant return motor**

The overload relay for the spindlehead lubricant return pump motor became activated.

[Index] None

[Character-string] None

[Code] None

★ 1751 **Spindlehead lubricant level**

The float switch within the spindlehead gearbox detected overflow of lubricant.

[Index] None

[Character-string] None

[Code] None

★ 1752 **Spindlehead lubricant pressure low**

The lubricant is not supplied properly to the spindlehead.

The pressure switch within the spindlehead or combination unit turned OFF the lubricant supply normal signal or turned ON the lubricant supply error signal.

[Index] None

[Character-string] None

[Code] None

★ 1753 **Spindle air curtain pressure low**

The air pressure confirmation signal went OFF when the spindle air curtain solenoid came ON.

[Index] None

[Character-string] None

[Code] None

★ 1754 **Inductosyn power unit**

An alarm occurred within the X-/Y-/Z-axis inductosyn power unit.

[Index] None

[Character-string] None

[Code] None

★ 1755 **Spindle lube level low**

The spindle lubricant level is low.

The hydraulic unit (combination unit) installed behind the column failed to issue the coolant level normal signal. Or, the coolant level abnormal signal was ON.

[Index] None

[Character-string] None

[Code] None

[Measures to Take] Supply spindle coolant.

★ 1756 **Sitting abnormal**

In a machine equipped with the work seated condition monitoring function, the seated condition confirmation signal input remained OFF for more than 0.5 seconds during constant monitoring of seated condition.

[Character-string] BP = Base plate

[Code]

1 = The seated condition confirmation signal went OFF while the spindle was running.

★ 1757 **Tool clamp unit error**

The tool clamp unit normal signal is not turned ON.

[Index] None

[Character-string] None

[Code] None

## SECTION 5 ALARM B

Alarm No.	Alarm Message
2000	SVP start conditions uncertain
2001	SVP processing trouble
2002	SVP CON APA deviation
2003	SVP error
2004	SVP exception processing
2005	SVP APA pattern data
2006	SVP APA speed
2007	SVP CON speed
2008	SVP DIFF over
2009	SVP servo amp
2010	SVP APA check data
2011	SVP speed command over
2012	SVP servo data setting
2013	SVP belt is broken
2014	SVP F-TYPE encoder
2015	SVP full closed loop error
2016	SVP F-TYPE encoder with shaft
2017	SVP F with shaft APA pattern data
2018	SVP cannot plant error offset data
2019	SVP encoder application (MOTOR SHAFT)
2020	SVP encoder application (WITH SHAFT)
2021	SVP collision detection
2022	SVP SA overload
2023	SVP SA communication error
2024	SVP SA version error
2025	SVP SA motor current overload
2026	SVP SA inverter bridge short circuit
2027	SVP SA overheating
2028	SVP SA power circuit overvoltage
2029	SVP SA power circuit low voltage
2030	SVP SA regenerative resistor overheat
2031	SVP control circuit power voltage
2032	SVP SA error
2033	SVP board version error
2034	SVP control error
2042	SVP LE sum check error
2043	SVP LE data error
2044	SVP LE incre. abso. error
2045	SVP LE comparator AD error
2046	SVP LE face rotation error
2047	SVP LE initial transfer data error

Alarm No.	Alarm Message
2048	SVP LE application error
2049	PLC axis stroke end over
2050	PLC axis command
2051	PLC axis continuous positioning over
2150	MCS Undefined alarm number
2151	MCS Exception processing
2152	MCS Processing trouble
2153	MCS CON APA deviation
2154	MCS Power-Supply-Unit Error
2155	MCS Converter-link error
2156	MCS DC-bus voltage alarm
2157	MCS Motor over current
2158	MCS Power unit over heat
2159	MCS Power unit over load
2160	MCS Supply voltage flutter
2161	MCS Power unit version error
2162	MCS Winding-change failed
2163	MCS Encoder-link error
2164	MCS Encoder error
2165	MCS Encoder initialize failed
2166	MCS Encoder with shaft error
2167	MCS Encoder with shaft initial
2168	MCS ABSO SCALE error
2169	MCS ABSO SCALE initialize
2170	MCS Magnetic encoder alarm
2171	MCS Resolver alarm
2172	MCS Pulse generator count over
2173	MCS Motor over heat
2174	MCS Servo-link error
2175	MCS Servo-link disconnect
2176	MCS Servo-link protocol error
2177	MCS Servo data error
2178	MCS Illegal command
2179	MCS CON speed over
2180	MCS Speed command over
2181	MCS DIFF over
2182	MCS APA speed over
2183	MCS Full-closed APA error
2184	MCS Over speed
2185	MCS Velocity deviation over
2186	MCS Collision detected
2187	MCS Urgent-stop time over
2188	MCS Belt is broken

Alarm No.	Alarm Message
2189	MCS Axis change control error
2190	MCS independent encoder init
2191	MCS APA error
2192	MCS Motor over load
2200	Schedule program: 'Q'
2201	Schedule program: mnemonic code
2202	Schedule program: program end
2203	Schedule program: main program load
2204	Expression: right side
2205	Expression: operation
2206	Expression: syntax
2207	Expression: factor
2208	Expression: buffer over
2209	Expression: local variable
2210	Program bad direct: G code
2211	Program bad direct: M code
2212	Program bad direct: common variable
2213	Program bad direct: system variable
2214	Program bad direct: sequence name
2215	Program bad direct: numerical data
2216	Program factor over
2217	Program bad direct: use of character
2218	Program bad direct: program name
2219	Sub program: repeat
2220	Sub program: stack
2221	Sub program: program name
2222	Mnemonic or local variable
2223	Branch (IF, GOTO): sequence name
2224	Branch (IF, GOTO): condition
2225	Unusable: G code
2226	Special G code table
2227	Unusable: M code
2228	Unusable: M code
2229	Equal is not exist
2230	Unusable: direct of left side
2231	Direct of subscript
2232	Bad value of system variable
2233	Local variable use over
2234	Program bad direct: unit designation
2235	Program name not selected
2236	Program end code not found
2237	Unusable: Optional block skip
2238	Unusable: RSTRT

Alarm No.	Alarm Message
2239	Unusable: OMIT
2240	Unusable: LAA
2241	Unusable: ARC
2242	Unusable: print
2243	Data word: 'D'
2244	Data word: 'F'
2245	Data word: 'H'
2246	Data word: 'I', 'J' or 'K'
2247	Data word: 'P'
2248	Data word: 'Q'
2249	Data word: 'R'
2250	Data word: 'RT'
2251	Data word: 'S'
2252	Data word: 'T'
2253	Data word: axis command
2254	Data word: radius
2255	Data word: arc calculation
2256	Data word: plane selection
2257	Data word: machine coordinate (H00) selecting
2258	Data word: scaling
2259	Data word: coordinate conversion
2260	Data word: mirror image
2261	Data word: programmable travel limit
2262	Data word: spec code
2263	Data word: G code
2264	Data word: M code
2265	MDI: special G code
2266	Main sequence
2267	Sequence restart
2268	Plus travel limit over
2269	Minus travel limit over
2270	No operation function
2271	No system variable function
2272	No subprogram function
2273	No input/output variable function
2274	Backup data file write
2275	Fixed cycle: 'P'
2276	Fixed cycle: 'Q'
2277	Fixed cycle: 'R'
2278	Fixed cycle: axis command
2279	Fixed cycle: cycle axis
2280	Fixed cycle: R and Z position relationship
2281	Fixed cycle: retract amount



Alarm No.	Alarm Message
2282	Fixed cycle: shift amount
2283	Fixed cycle: command impossible
2284	Fixed cycle: plane command
2285	Fixed cycle: no G71 command
2286	Fixed cycle: M code
2287	Fixed cycle: M code command
2288	Coordinate computation: H,V command
2289	Coordinate computation: I command
2290	Coordinate computation: J command
2291	Coordinate computation: K command
2292	Coordinate computation: P command
2293	Coordinate computation: Q command
2294	Coordinate computation: R command
2295	Coordinate computation: maximum number over
2296	Coordinate computation: G code
2297	Coordinate computation: mode
2298	Cutter radius comp.: operation
2299	Cutter radius comp.: no intersecting point
2300	Cutter radius comp.: cancel G00/G01
2301	Cutter radius comp.: startup impossible
2302	Cutter radius comp.: number
2303	Cutter radius comp.: amount command
2304	Cutter radius comp.: interference
2305	UNTENDED: gauging impossible
2306	UNTENDED: hole dia. error over
2307	UNTENDED: off centerline
2308	INTENDED: command missing
2309	UNTENDED: tool breakage
2310	UNTENDED: zero offset impossible
2311	UNTENDED: no subprogram function
2312	UNTENDED: center distance error over
2313	Area machining: no cycle axis command
2314	Area machining: tool dia. = 0
2315	Area machining: area command
2316	Area machining: no R command
2317	Area machining: R level & finish surface
2318	Area machining: circular interpolation mode
2319	Area machining: large finish allowance
2320	B method: buffer over
2321	Data Word: 'AG'
2322	3-dimension tool comp.: axis command
2323	Area machining: 'F'
2324	Area machining: 'D'

Alarm No.	Alarm Message
2325	Area machining: 'I'
2326	Area machining: 'J'
2327	Area machining: 'K'
2328	Area machining: 'P'
2329	Area machining: 'Q'
2330	Area machining: 'R'
2331	Area machining: plane command
2332	Area machining: mode
2333	Data word: indexing axis command
2334	No tool command
2335	Program bad direct: T code
2336	Wrong T command
2337	ATC M command
2338	APC M command
2339	Axis lube motor overload
2340	Axis lube pressure ON confirmation
2341	Axis lube pressure OFF confirmation
2342	Coolant motor overload
2343	Thru-the-tool coolant motor overload
2344	Clamp command ON
2345	Clamp confirmation
2346	Unclamp confirmation
2347	Axis interlock releasing
2348	Unusable: print character string
2349	Tool change motor overload
2350	EC system data code
2351	Spindle gear change command
2352	Spindle pulse generator
2353	Spindle gear change impossible
2354	Spindle orient position OFF
2355	Tool dia. enlarge solenoid
2356	No S command
2357	Unusable: S code
2358	Tool management number 0
2359	Data word: rotating axis command
2360	Shower coolant motor overload
2361	Hydraulic oil cooling unit
2362	VAC thermo protect
2363	Area machining: M52 command
2364	Unusable: address character
2365	Data word: 'RS'
2366	APA read
2367	Axis drive motor overload

Alarm No.	Alarm Message
2368	ATC hydraulic motor overload
2369	Spindle REVERSE command
2370	Cross rail vertical drive motor overload
2371	Swivel head index compensation
2372	Spindle orientation time over
2373	Spindle orientation answer error
2374	No pallet program
2375	No user program
2376	No attachment offset
2377	Crossrail unclamp motor overload
2378	LTC M command
2379	AAC1 M command
2380	AAC2 M command
2381	Crossrail positioning sensor
2382	Spindlehead cooling unit
2383	Detachable axis move
2384	Outside
2385	Limit confirmation impossible
2386	BDU
2387	BDU ready
2388	Data word: 'E'
2389	Graphic program instruction
2390	Multi volume next program load
2391	BFR task program load
2392	S, T, M time over
2393	In-position observation time over
2394	Data word: 'RH'
2395	User reserve code
2396	Unusable: output variable NO.
2397	Unusable: input variable NO.
2398	Work clamp miss
2399	Bad value for output variable
2400	Program bad direct: character string
2401	Program bad direct: hexadecimal data
2402	SAC unit
2403	Coolant circulation motor overload
2404	MSB reserved
2405	Graphic no spec.
2406	UGC: Program end code none
2407	UGC: Delete syntax
2408	UGC: DEF syntax
2409	UGC: Figure entry
2410	UGC: Illegal numerical

Alarm No.	Alarm Message
2411	UGC: Illegal character
2412	UGC: User variable
2413	UGC: System variable
2414	UGC: Illegal command
2415	UGC: Program factor over
2416	UGC: Coordinate data
2417	UGC: END syntax
2418	UGC: Figure entry command over
2419	UGC: Command format
2420	UGC: Additional parameter
2421	UGC: Expression
2422	UGC: Entry area over
2423	UGC: Delete unable
2424	Synchronous error recovering operation
2425	Quill cycle time over
2426	DNC-B remote operation
2427	ATC cycle time over
2428	Air pressure low
2429	Chip flush-out motor overload
2430	Axis interlock
2431	APC pallet index condition
2432	ATC tool change arm door
2433	Coolant unit
2434	Ball screw lube confirmation
2435	Work washing gun motor overload
2436	Active tool NG2
2437	Improper M code
2438	Data word: 'TN'
2439	Spindle orientation gear
2440	Axis lubrication cycle
2441	Wrong actual number
2442	Pattern cycle command miss
2443	Cooling unit
2444	Linear positioning limit
2445	Data word: 'RM'
2446	Active tool No. BCD input data NG
2447	Synchronous tap's torque low
2448	Coordinate change instruction missing
2449	Coordinate change operation
2450	Cylindrical side cutting unit convert
2451	Spindle wiring change command
2452	Pallet discrimination NG
2453	Data word: 'RP'

Alarm No.	Alarm Message
2454	Data word: WP
2455	Update
2456	Manual skip function
2457	Interactive gauging: touch probe
2458	Interactive gauging: impossible
2459	Attachment index unusual
2460	Data word: 'RI'
2461	Chamfering commands illegal
2462	Spindle neutral gear select time over
2463	Tool clamp/unclamp time over
2464	Swivel head index unusual
2465	DF
2466	L (Area machining)
2467	Spindle deflection offset position (Fixed cycle)
2468	D (Fixed cycle)
2469	Reference position (Home position)
2470	DATA word:'NP'
2471	Cutting feed impossible
2472	Attachment Control
2473	EC reset sequence
2474	Machine axis travel limit over
2475	Sub command except STM invalid value
2476	Inductosyn mode change time over
2477	arc I,J command error
2478	Barrier
2479	same block
2480	Axis change control unusual
2481	DATA word:'WS'
2489	sensor
2490	'LP'
2491	'LD'
2492	I-PACK special G code
2493	READ/WRITE buffer over
2494	READ/WRITE device NO.
2495	READ/WRITE data
2496	GET/PUT buffer over
2497	GET/PUT number of figure
2498	GET/PUT variable
2499	GET numeric data
2500	READ communication error
2501	WRITE communication error
2502	READ/WRITE no function
2503	GET/PUT no function

Alarm No.	Alarm Message
2504	DATA word:'BT'
2505	Bolt hole chamfering error
2506	Profile generation error
2509	Fine profile:invalid start point
2510	Illegal AP file
2511	Fine profile: 'F' command
2512	AP file transfer failure
2513	Fine profile:running method
2514	TPRF mode
2515	TPRF:mismatch tool position
2516	TPRF:tool shift direction
2517	READ/WRITE No empty SAT
2518	READ/WRITE File open
2519	Unusable PRINT request
2520	Cycle time over
2521	Cooling tank unit abnormal
2522	Spindle overload
2523	Remote buffer operation error
2524	No magazine tool to be selected
2525	Tool input NO.
2526	Tailstock quill over advance
2527	Tailstock quill condition
2528	Chuck condition
2529	R/W head time over
2530	DNC-DT Path name
2531	DNC-DT Program select
2532	DNC-DT Program drive
2533	Fixed cycle top face detection error
2534	Fixed cycle 'LL'
2535	Fixed cycle 'L'
2536	Compound fixed cycle 'L'
2537	Data word Thread cycle
2538	Data word 'E'
2539	Axis swivel interlock
2540	Compound fixed cycle mode
2541	Compound fixed cycle 'Q' illegal order
2542	Compound fixed cycle 'QB' illegal order
2543	Compound fixed cycle 'H' illegal order
2544	Compound fixed cycle 'QA' illegal order
2545	Compound fixed cycle 'F' illegal order
2546	Compound fixed cycle axis command
2547	Compound fixed cycle start point
2548	Compound fixed cycle QB-QA less than Q(M294)

Alarm No.	Alarm Message
2549	Compound fixed cycle I,J,K illegal order
2550	Compound fixed cycle angle
2551	Compound fixed cycle QA grater than QB
2552	Data word: A
2553	Data word: B
2554	Data word: C
2555	'NP' Command is invalidity
2556	CUTTING TOOL GROOVE PROCESS
2557	Draw Pump motor overload
2558	Data word: HS
2559	Data word: DS
2560	Cycle time over
2561	Bad direct
2562	Data word: 'I'
2563	Data word: 'J'
2564	Data word: 'K'
2565	Data word: 'L'
2566	Coolant flow
2567	Tool name direct
2568	Inverse time feed
2569	Bad direct: offset data input
2570	Fixed cycle: I
2571	Fixed cycle: J
2572	Fixed cycle: K
2573	Fixed cycle: Q, K
2574	Data word: L
2575	Super Hi-NC control cannot execute
2576	NURBS data word incorrect
2577	NURBS interpolation mode
2578	NURBS command miss
2579	Diameter instruction axis command
2580	Reset button error
2581	Turning cut mode
2582	DNC-DT preload error
2583	UNTENDED: gauging sphere error over
2584	Coolant level low
2585	DNC-DT delete error
2586	Manual shift total is not 0
2587	Spindle cooling-unit
2588	Spindle cooling-unit oil level low
2701	No tool command
2702	Program bad direct : T code
2703	ATC M command

Alarm No.	Alarm Message
2704	Axis lube motor overload
2705	Axis lube pressure ON confirmation
2706	Axis lube pressure OFF confirmation
2707	Coolant motor overload
2708	Thru - the - tool coolant motor overload
2709	Spindle orient position OFF
2710	Clamp command ON
2711	Clamp confirmation
2712	Unclamp confirmation
2713	Axis interlock releasing
2714	APC M command
2715	Wrong T command
2716	No S command
2717	Unusable: S code
2718	Axis drive motor overload
2719	Sequence restart
2720	Machine axis travel limit over
2721	Axis change control unusual
2722	Coolant level low
2723	Thru-the-tool coolant filter clogged
2724	Shower coolant motor overload
2725	Next tool No.
2726	Spindlehead cooling unit
2727	Improper M command
2728	Machine system data code
2729	Improper TN code
2730	Pallet discrimination NG
2731	Data word: RP
2732	Data word: RH
2733	Data word: RS
2734	Crossrail positioning sensor
2735	Cycle time over
2736	Work clamp miss
2737	Hydraulic oil cooling unit
2738	NP command unsuitable
2739	Cross rail vertical drive motor
2740	ATC tool data setting
2741	Tailstock advance limit
2742	Coolant unit unusual
2743	Air pressure drop
2744	Carrier system check now
2745	Spindle gear change impossible
2746	Spindle gear change command



---

Alarm No.	Alarm Message
2747	Cooling unit
2748	Attachment indexing unusual
2749	Attachment control
2750	Data word: 'RI'
2751	Limit confirmation impossible
2752	AAC M command
2753	Mist air lube unit
2754	Touch probe battery
2755	Outside
2756	Sitting abnormal
2757	Axis interlock
2758	Hydraulic unit error
2759	Warming up

★ 2000 SVP start conditions uncertain

SVP hardware or software conditions were not met, which made it impossible to start up the SVP.

[Index] AXIS

[Code] XYYZZZZ

X=1-> Hardware-related conditions are not met.

YY=1-> The SVP board is not mounted.

ZZZZ=0000

YY=2-> The SVP is in abnormal status.

ZZZZSVP status

YY=3-> The system bus related to the SVP hardware is in abnormal status.

ZZZZ:System bus status

X=2-> SVP data conditions are not met.

YY=1-> Wrong synchronous signal number is selected.

ZZZZ:Selected synchronous signal number

YY=2-> Synchronous shift time is wrongly designated.

ZZZZ:Designated synchronous shift time

X=3-> Software-related conditions are not met.

YY=1-> The SVP software is not installed.

ZZZZ=0000

YY=2-> Servo parameters are not installed.

ZZZZ=0000

[Probable Faulty Locations]

- 1) SVP hardware of the problem axis
- 2) Control software such as that for NC
- 3) NC specifications

★ 2001 SVP processing trouble

The SVP is in the trouble indicated by the following codes.

[Index] AXIS

[Code] XYYZZZZ

X=1-> Internal error

The SVP has caused either parity loop error or protect error.

YY-> Internal error status

ZZZZ:Two high-order bytes of the SVP system address in trouble

X=2-> Time out

The SVP does not send any response within 20[s] at the time of start up. Minute investigation should be made to locate the cause.

Since the SVP cannot detect the start up signal, it cannot execute the start up sequence.

YY=00

ZZZZ=000000

X=3-> Double bus error

During bus error exception processing by SVP, a bus error has occurred again. The SVP hardware will probably be defective.

YY:System bus status

ZZZZ=000000

X=4-> SVP command execution

The SVP has obtained wrong diagnostic results of CPU command execution. The CPU will probably be defective.

YY:Diagnostic results

ZZZZ=000000

X=5-> SVP trouble detected by the control software such as that for NC. Some trouble has occurred in the SVP.

[Probable Faulty Locations]

- 1) SVP hardware of the problem axis
- 2) SVP software of the problem axis
- 3) Control software such as that for NC

**★ 2002 SVP CON APA deviation**

Deviation between CON and APA has exceeded the preset limit.

The deviation can be obtained by the formula: [Calculated value written in SVP] - [Actual position read from SVP].

This value is monitored by the control software such as that for NC.

The SVP usually monitors DIFF. However, when the SVP becomes unable to monitor DIFF due to fatal abnormality, this monitoring function will prevent the system overrun.

[Index] AXIS

[Code] Absolute deviation value in hexadecimal [reference unit]

[Probable Faulty Locations] SVP of the problem axis

**★ 2003 SVP error**

The control software such as that for NC has detected a system alarm signal sent from the SVP hardware. For details, refer to the specification for the mounted SVP version.

[Index] AXIS

[Character-string] None

[Code] \*??##&&

\* -> Axis number of which SVP board's CPU has caused the error (If 2, the problem SVP board is that for the 2nd axis.)

?? -> Board status in hexadecimal

bit7bit6bit5bit4bit3bit2 bit1 bit0  
RUNHALTCPUOFF000 SNMI MSTP

## -> Bus error status in hexadecimal

bit7bit6bit5bit4bit3bit2 bit1 bit0  
SBERSBPARCYCER0PROTDAILOOPECC

&& -> Always 00

[Probable Faulty Locations]

- 1) Hardware defect of the SVP board indicated with the code \*
- 2) Software defect

**★ 2004 SVP exception processing**

Fatal abnormality has occurred in processing by SVP software.

[Index] AXIS

[Character-string] Detected error factor

- # 1-> Bus error
- # 2-> Address error
- # 3-> Illegal instruction error
- # 4-> Zero divide error
- # 5-> CHK instruction error
- # 6-> TRAPV instruction error
- # 7-> Privilege violation error
- # 8-> Trace error

- # 9-> Line 1010 emulator error
- #10-> Line 1111 emulator error
- #11-> Unused area error
- #12-> Coprocessor illegal protocol error
- #13-> Format error
- #14-> Uninitialized interrupt error
- #15-> Spurious interrupt error
- #16-> Interrupt error
- #17-> INT7 error
- #18-> Debugger interrupt alarm
- #19-> INT2 loop error
- #20-> INT5 loop error
- #21-> Speed command calculation delay alarm
- #22-> TRAP error
- #23-> Floating-point coprocessor error
- #24-> PMMU error
- #25-> User interrupt error
- #26-> Board version error
- #27-> Memory test error

[Code]

The CPU program counter value is displayed except when the following character-strings appear.  
With #26, the SVP hardware ID number is displayed as a code.  
With #27, the memory address at the time of abnormality detection is displayed as a code.

[Probable Faulty Locations]

- 1) SVP board
- 2) SVP software

**★ 2005 SVP APA pattern data**

The SVP has successively detected wrong patterns of positional data sent from the position encoder.

Ex. Displayed [Code] 8000

Conversion into the octal number

8000(hexadecimal number)->100000 (octal number) Since the E8 unit reads up to 5 digits and ignores the sixth digit, all the digits become 0, causing the OSP to judge that no data is output from the encoder.

[Index]AXIS

[Code] Pattern of the read positional data(APA high-order digit)

[Probable Faulty Locations]

- 1) Position encoder of the problem axis
- 2) SVP hardware of the problem axis
- 3) Timing signal from the NC unit

**★ 2006 SVP APA speed**

The position encoder value (RAPA) changes according to the motor speed. The NC checks the variation of position encoder values at regular intervals. If the feedrate of each axis is abnormally high compared with the normal rapid traverse rate, or the value changes in abnormal manner due to malfunction of the position encoder, the variation per unit time exceeds a fixed allowable limit, causing this alarm.

[Index] AXIS

[Code]

Variation of the position encoder values in hexadecimal [encoder unit /3.2ms]

However, the following codes represents special meanings.

FFFFFFF-> The variation has exceeded the liner axis stroke.

FFFFFFFE-> The variation has exceeded the rotary axis stroke (360-deg), or the positional data of the infinite axis has changed to a negative value.

FFFFFFFD-> The variation has exceeded the infinite axis stroke.

[Probable Faulty Locations]

- 1) Position encoder of the problem axis or the cables connected with the encoder.
- 2) Motor for driving the problem axis
- 3) Drive unit of the problem axis
- 4) SVP hardware of the problem axis

#### ★ 2007 SVP CON speed

When the axis is in the target position or at a standstill, the target value, operation value, and actual position data are the same. With designation of an axis moving command, the NC starts calculating the path to the target position, thus creating operation values (RCON). The NC then monitors the variation of the operation values at regular intervals. If the value changes in abnormal manner for some reason exceeding the allowable limit, this alarm occurs.

[Index] AXIS

[Code]

Absolute feedrate command value in hexadecimal [encoder unit/feedrate control time]

However, the following codes represents special meanings:

FFFFFFF-> The NC violates the protocol (time limit).

FFFFFFFE-> The feedrate command values is larger than the over alarm level or the alarm detection level.

FFFFFFFC-> The SVP internal command position exceeds the encoder division stroke.

[Probable Faulty Locations]

- 1) Servo parameter of the problem axis
- 2) Control software such as that for NC
- 3) SVP hardware of the problem axis
- 4) Excessively high feedrate (except G00)

#### ★ 2008 SVP DIFF over

When the axis is in the target position or at a standstill, the target value, operation value, and actual position data are the same. With designation of an axis moving command, the NC starts calculating the path to the target position, thus creating operation values (RCON). This time, the actual position data follows the operation values with a certain delay. This delay amount obtained by subtracting [actual position] from [operation value] is termed following error. If the following error exceeds the allowable limit, this alarm occurs.

[Index] AXIS

[Code] Absolute DIFF value in hexadecimal [encoder unit]

[Probable Faulty Locations]

- 1) Mechanical trouble of ball screw, bearing or any other parts, which makes the axis movement heavy
- 2) Encoder, motor or drive unit of the problem axis
- 3) Servo parameters of the problem axis
- 4) SVP hardware of the problem axis

#### ★ 2009 SVP servo amp

Fatal abnormality has occurred in the servo amplifier.

[Index] AXIS

[Code] YYZZ

YY=Internal error status

ZZ=Servo amplifier IF status

[Probable Faulty Locations] Drive unit of the of the problem axis.

**★ 2010 SVP APA check data**

The high-order digits read from the position encoder do not match the high-order digits obtained by incremental operation.

Ex. Displayed [Code] 14E914A9

When this code is converted into the octal number (by carrying high-order digit for F or E type encoder or carrying octal number for E8 unit), the following result can be obtained.

12351	12251
Encoder digit data	Operation data

Judging from the difference by 1 in the third place's number, the third digit or the second digit which generates the carry signal must be showing the cause of this alarm, i.e. phase difference in gear connection.

[Index] AXIS

[Code] YYYYZZZZ

YYYY=Hexadecimal number of the high-order digit read from the encoder

ZZZZ=Hexadecimal number of the high-order digit obtained by calculation from the lower-order digit

[Probable Faulty Locations]

- 1) Position encoder of the problem axis
- 2) SVP board of the problem axis
- 3) Synchronous signals of the system

[Measures to Take]

Convert the code to octal number.

If all the digits are shifted as in 1234523456

-> SVP board is defective.

If the first digit is discrepant as in 1234512344

-> MPR or bearing is defective in most cases.

If this alarm occurs in several axes

-> Synchronous signals of TFP or SVP board are defective.

**★ 2011 SVP speed command over**

The speed command calculated by SVP has successively exceeded the allowable limit. Here, the allowable limit means the speed command over alarm level.

[Index] AXIS

[Code]

Hexadecimal number of the absolute feedrate command value at the time of abnormality detection [encoder unit/feedrate control time]

[Probable Faulty Locations]

Excessive load is applied due to the mechanical reason.

Refer to the cause of SVP DIFF over alarm.

**★ 2012 SVP servo data setting**

The SVP has received non-applicable servo data. This alarm occurs when an abnormal value is set in the NC as servo data or when the servo processor cannot receive the set data.

Occurrence of this alarm during maintenance service implies that there may be an incompatibility between the servo parameter file and SVP software.

[Index] AXIS

[Code] Servo data number

21-> Kv value

- 22-> Hardware servo coefficient
- 23-> Slow up/down coefficient
- 26-> HB control slow up/down coefficient
- 2B-> Inductosyn special pitch
- 39-> Backlash compensation
- 3A-> CON speed limit
- 3B-> Mantissa of speed change ratio (straight line)
- 3C-> Exponent part of speed change ratio (straight line)
- 3D-> Speed change ratio (rotary)
- 41-> V-AMP output filter constant group
- 4F-> New speed detection G1
- 50-> New speed detection G2
- 51-> New speed detection HPF constant
- 52-> New speed detection LPF constant
- 53-> 1st speed acceleration/deceleration constant
- 54-> HB control constant
- 57-> 2nd speed acceleration/deceleration constant
- 58-> Notch filter constant group
- 62-> Encoder accuracy designation
- 71-> Amplifier communication speed
- 86-> DIFF. MIN (DIFF-G variable)
- 87-> DIFF. MAX (DIFF-G variable)
- 88-> ATTF calculation constant
- 89-> Integration limit value
- 100-> FLSUD change timing abnormal
- 101->1st speed change timing abnormal
- 102->2nd speed change timing abnormal
- 103->Exp change timing abnormal
- 104->QITGMD change timing abnormal
- 105->Wrong interpolation mode
- FFFF-> No authorization
- FFFE-> Infinite/rotary axis
- FFFD-> Infinite axis
- FFFC-> Speed change ratio
- FFFB-> Speed control cycle

[Probable Faulty Locations]

- 1) Servo parameter file of the problem axis
- 2) Control software such as that for NC
- 3) SVP software of the problem axis

**★ 2013 SVP belt is broken**

The SVP has detected breakage of the belt for the belt-driven axis.

[Index] AXIS

[Code] Hexadecimal number of the torque applied at the time of breakage

**★ 2014 SVP F-TYPE encoder**

Error compensation data for one turn cannot be set in the position encoder.

[Index] AXIS

[Code] The number indicating the setting impossible reason

- 1-> Data read disabled
- 2-> Data check sum error
- 4-> Data overflow
- 5-> Error compensation data does not return to 0.

[Probable Faulty Locations] Position encoder of the problem axis

**★ 2015 SVP full closed loop error**

Deviation between the full-closed loop and semi-closed loop is abnormally large.

[Index] AXIS

[Code] The number of abnormality detection times

[Probable Faulty Locations]

- 1) Separately mounted position encoder or inductosyn of the problem axis
- 2) Excessive lost motion of the problem axis
- 3) Slippage or breakage of the belt on the problem axis
- 4) Coupling compensation is not set or wrong data is set in the problem axis.
- 5) The positional loop gain of the problem axis is not proper (too high).
- 6) Phase shift by collision of the problem axis

**★ 2016 SVP F-TYPE encoder with shaft**

It is impossible to set the rotation error compensation data of F type position encoder with shaft.

[Index] AXIS

[Code] The number indicating the setting disable reason.

- 1-> Data read disabled
- 2-> Data check sum error
- 4-> Data overflow
- 5-> Error compensation data does not return to 0.

[Probable Faulty Locations] Position encoder of the problem axis

**★ 2017 SVP F with shaft APA pattern data**

The position encoder with shaft has successively read positional data of wrong patterns.

[Index] AXIS

[Code] Pattern of the read positional data (APA high-order digit)

[Probable Faulty Locations]

- 1) Position encoder of the problem axis
- 2) SVP hardware of the problem axis
- 3) Timing signal from the NC unit

**★ 2018 SVP cannot plant error offset data**

When the extended pitch error compensation function is provided, the SVP memory does not have enough capacity for storing the data.

[Index] AXIS

[Probable Faulty Locations]

- 1) SVP board controlling the problem axis
- 2) Extended pitch error compensation file containing extended pitch error compensation data of the problem axis

**★ 2019 SVP encoder application (MOTOR SHAFT)**

The encoder type mounted on the motor does not conform to the encoder accuracy data.

[Index] AXIS



★ 2020 **SVP encoder application (WITH SHAFT)**

The encoder type mounted on the shaft does not conform to the encoder accuracy data.

[Index] AXIS

★ 2021 **SVP collision detection**

The SVP has detected collision of the driving unit with something.

[Index] AXIS

[Code] YYYYZZZZ

YYYY:Average motor output torque

ZZZZ:Average motor acceleration

★ 2022 **SVP SA overload**

The servo amplifier has overheated exceeding the protection curve set in the SVP control software.

[Index] AXIS

[Code] YYYYZZZZ

YYYY:Set value of the protection curve used for overload detection

ZZZZ:Detected value [n] at overload detection

[Probable Faulty Locations] Servo amplifier of the problem axis

★ 2023 **SVP SA communication error**

Abnormality has occurred in communication between SVP and servo amplifier.

[Index] AXIS

[Code] Cause indication number

- 1-> Parity error in SVP
- 2-> The sent data does not match the received data.
- 3-> Servo amplifier ID is not properly received.
- 4-> No signal is sent from the servo amplifier
- 5-> Parity error has occurred in servo amplifier.

[Probable Faulty Locations] Servo amplifier of the problem axis

★ 2024 **SVP SA version error**

Version check by the amplifier version control function proved that the mounted servo amplifier version is newer than the versions applicable to the SVP software.

[Index]AXIS

[Code]Version data

10000000-> BLII-D is mounted though BL-D is required.

XXYYZZ:

XX:SVP version

YY:Servo amplifier version applicable to SVP

ZZ:Servo amplifier version

[Probable Faulty Locations]

- 1-> Servo amplifier of the problem axis
- 2-> A wrong version of servo amplifier was mounted.

★ 2025 **SVP SA motor current overload**

The servo amplifier has detected an excessive current flow in the motor cables. A warning lamp IOCM on the servo amplifier is lit.

[Index]AXIS

[Probable Faulty Locations] Servo amplifier of the problem axis

★ 2026 **SVP SA inverter bridge short circuit**

The servo amplifier has detected short-circuit of the inverter bridge in the amplifier. A warning lamp IOCS on the servo amplifier is lit.

[Index] AXIS

[Probable Faulty Locations] Servo amplifier of the problem axis

★ 2027 **SVP SA overheating**

The servo amplifier has detected overheating of the amplifier.  
A warning lamp SVTH on the servo amplifier is lit.

[Index]AXIS

[Probable Faulty Locations] Servo amplifier of the problem axis

★ 2028 **SVP SA power circuit overvoltage**

The servo amplifier has detected overvoltage applied to the power circuit of the amplifier. A warning lamp HV on the servo amplifier is lit.

[Index]AXIS

[Probable Faulty Locations] Servo amplifier of the problem axis

★ 2029 **SVP SA power circuit low voltage**

The servo amplifier has detected voltage drop in the amplifier power circuit. A warning lamp LV on the servo amplifier is lit.

[Index] AXIS

[Probable Faulty Locations] Servo amplifier of the problem axis

★ 2030 **SVP SA regenerative resistor overheat**

The servo amplifier has detected excessive power consumption in the regenerative resistance of the amplifier. A warning lamp DROH on the servo amplifier is lit.

[Index]AXIS

[Probable Faulty Locations] Servo amplifier of the problem axis

★ 2031 **SVP control circuit power voltage**

The servo amplifier has detected the abnormal voltage applied to the amplifier control circuit. A warning lamp VR on the servo amplifier is lit.

[Index]AXIS

[Probable Faulty Locations] Servo amplifier of the problem axis

★ 2032 **SVP SA error**

The servo amplifier is in some trouble.

[Index]AXIS

[Probable Faulty Locations] Servo amplifier of the problem axis

★ 2033 **SVP board version error**

The SVP hardware version is wrong.

[Index] AXIS

[Code]

1-> SVP hardware ID is not 1.

[Probable Faulty Locations]

1-> SVP board controlling the problem axis

2-> A wrong version of SVP was mounted.

★ 2034 **SVP control error**

The SVP board is in a trouble related to the axis control.

[Index] AXIS

[Code] Alarm data

[Probable Faulty Locations] SVP software controlling the problem axis

★ 2042 **SVP LE sum check error**

A sum check error occurred in communication data sent from an optical linear encoder.

[Index] AXIS

XX: Check sum received from the optical linear encoder on occurrence of this alarm

YY: Check sum calculated by SV

★ 2043 **SVP LE data error**

The optical linear encoder generated an alarm.

[Index] AXIS

[Code] XXYYYYYY

XX: Optical linear encoder alarm detected on occurrence of this alarm

YYYYYY: Position data sent from the optical linear encoder on occurrence of this alarm

★ 2044 **SVP LE incre. abso. error**

An optical linear encoder generated an incre-abso error.

[Index] AXIS

[Code] XXYYYYYY

XX: Optical linear encoder alarm detected on occurrence of this alarm

YYYYYY: Position data sent from the optical linear encoder on occurrence of this alarm

★ 2045 **SVP LE comparator AD error**

An optical linear encoder generated an comparator AD error.

[Index] AXIS

[Code] XXYYYYYY

XX: Optical linear encoder alarm detected on occurrence of this alarm

★ 2046 **SVP LE face rotation error**

An optical linear encoder generated a face rotation error.

[Index] AXIS

[Code] XXYYYYYY

XX: Optical linear encoder alarm detected on occurrence of this alarm

YYYYYY: Position data sent from the optical linear encoder on occurrence of this alarm

★ 2047 **SVP LE initial transfer data error**

An error occurred in the initial transfer data from an optical linear encoder.

[Index] AXIS

[Code]

1-> Data reading impossible

2-> Data sum check error

16-> Inapplicable control software version

★ 2048 **SVP LE application error**

The connected linear encoder is of an inapplicable type.

[Index] AXIS

[Code] XXXXXXXX

XXXXXXXX: Connected optical linear encoder type

★ 2049 **PLC axis stroke end over**

A PLC axis is moved exceeding its travel end limit.

[Index] None

[Character-string] None

[Code] None

[Probable Faulty Locations]

- 1) The travel end limit of the PLC axis is wrongly set.
- 2) Programming error of the sequence for moving the PLC axis.

[Measures to Take]

- 1) Consult the machine maker.

★ 2050 **PLC axis command**

The PLC axis command is improper.

[Index] Axis

[Character-string] None

[Code] XYYYYY

XX: Control command code (The positioning command, however, is represented by FF instead of 00.)

YYYY:

0001->The continuous positioning start command is followed by a command other than the stop command. Or, the continuous positioning stop command is issued before the start command.

0002->The control command code is improper.

0003->An axis movement control command such as positioning or dwell command is issued though the servo amplifier is not ready to operate.

0004->The feedrate data is abnormal.

0005->The specified data is out of the allowable range.

0006->The specified number of blocks does not match the actual number of blocks executed at the same time.

0007->The target position exceeds the travel end.

0008->The continuous positioning start command does not include the positioning direction.

0009->The simultaneous start mode ON command is issued during that mode.

000A->The specified control code is not usable for PLC-axis specification.

[Probable Faulty Locations]

- 1) Programming error of the sequence for moving the PLC axis

[Measures to Take]

- 1) Consult the machine maker.

★ 2051 **PLC axis continuous positioning over**

The continuous positioning command includes an improper final target position.

[Index] Axis

[Character-string] None

[Code]

Hexadecimal number that represents the difference between the distance required for deceleration and the remaining distance to the target position

[Probable Faulty Locations]

- 1) Programming error of the sequence for moving the PLC axis

[Measures to Take]

- 1) Consult the machine maker.

**★ 2150 MCS Undefined alarm number**

The MCS caused an error related with axis control.

[Index] Axis name or none (spindle)

[Character-string] Alarm number in decimal

[Code] Alarm code

[Probable Faulty Locations]

- Depends on the number indicated in the character-string.  
Inform us of the code and the character string.

**★ 2151 MCS Exception processing**

A fatal alarm occurred while the MCS inverter unit and MCS software are executing their processing.

[Index] Axis name or none (spindle)

[Character-string] Cause of alarm detected

- "#1"-> Control board error
- "#2"-> Voltage drop of +-12 V battery for control board
- "#3"-> OPF error
- "#11"->Voltage drop of 5 V battery for control board
- "#12"->Inverter bridge shorted
- "#13"->IPM protective function activated
- "#14"->Motor overcurrent
- "#20"->INT loop error
- "#21"->INT5 loop error
- "#22"->INT4 loop error
- "#23"->INT3 loop error
- "#24"->INT2 loop error
- "#25"->INT1 loop error
- "#26"->Access denied
- "#27"->Ram check error in initialization
- "#28"->Party error
- "#29"->Watchdog error
- "#30"->IRQ7 interruption
- "#31"->NMI interruption
- "#32"->General illegal command
- "#33"->Slot illegal command
- "#34"->CPU address error
- "#35"->DMA address error
- "#36"->Undefined trap error
- "#37"->Undefined interruption
- "#38"->DMAC
- "#39"->ITU
- "#40"->SCI
- "#41"->REF
- "#42"->A/D

"#43"->System reserved

"#44"->User break

[Code]

In the case of #1, the code shows the error content of the control board.

In the case of #3, the code shows the error content of the optional program file.

1: Identification code "OPF1" error

2: End code "ED" error

3: Sum check error

4: Board name error

In the case of #11-14, #20-21, #25-26 and #30-31, the code shows the data in the error status register.

[Probable Faulty Locations]

In the case of #1,

- Inverter unit

In the case of #3,

- Optional program file
- Optional program file incompatible with inverter unit

In the case of #2 or #11,

- Power unit (when this alarm occurred in several inverter units)

In the case of #12, #13, or #14,

- Inverter unit

In other cases,

- Inverter unit

★ 2152 MCS Processing trouble

MCS

[Index] Axis name or none (spindle)

[Character-string] None

[Code] XXZZAAAA

XX:

04-> The self-diagnostic data has an error. (ZZ: Received data)

06-> Software sync bit or format code of buffer A is wrong.

07-> Software sync bit or format code of buffer B is wrong.

08-> An error occurred in data communication.

ZZ shows the data kind. AAAA is always 0.

ZZ:

1-> Speed command (8408)

2-> Laser linear scale value (4413)

3-> Backlash (4406)

4-> Actual position without positioning error compensation (440A)

5-> Positioning error compensation amount

6-> Full-closed loop encoder value (4410)

7-> Semi-closed loop encoder value (4411)

8-> ODIFF (4415)

10-> APA in divided stroke (4404)

11-> Acceleration/deceleration time for positioning (4422)

12-> Zero offset amount

13-> In-position width (4420)

14-> Maximum of divided stroke (4405)

15-> Point data change

[Probable Faulty Locations]

- Faulty MCS controller
- Faulty software

**★ 2153 MCS CON APA deviation**

Difference between CON and APA values has exceeded the allowable limit. The CON-APA deviation is the absolute value of difference between [calculated value written in MCS] and [actual position read from MCS]. The NC control software monitors this deviation. The MCS normally monitors DIFF value.

This alarm appears if the MCS causes a fatal error and cannot monitor the DIFF value.

[Index] Axis name

[Character-string] None

[Code] Absolute value of deviation in hexadecimal (reference unit)

[Probable Faulty Locations]

- Faulty MCS controller
- Mismatch between MCS data and NC data

**★ 2154 MCS Power-Supply-Unit Error**

The power unit caused an error.

[Index] Axis name or none (spindle)

[Character-string] None

[Code] AAAAAAXX

AAAAAA is always 0.

X Alarm number

0: DC voltage alarm

1: Abnormal input voltage

2: Abnormal control power

3: Abnormal control status

4: Overload in regenerative circuit

5: Heat sink overheat

6: CPU error

7: Spare

Y: Power unit status

bit3 1: An alarm occurred in the power unit. (Warning signal status: 0)

bit2 1: DC power is being supplied

bit1 1: OPRON input is closed

bit0 1: PWON input is closed.

ZZ:Data

X(alarm No.):0 ... Detected DC voltage in hexadecimal [3.9V]

X(alarm No.):1 ... Detected AC voltage in hexadecimal [3.1V]

X(alarm No.):2

1: +5V abnormal voltage

2: +12V abnormal voltage

3: -12V abnormal voltage

X(alarm No.):3

1: Converter over current

2: Abnormal power element

3: Converter short circuit

- 4: Abnormal regenerative circuit(type in power regenerative circuit)
- 5: Abnormal regenerative circuit(type in resistor discharge)
- X(alarm No.):4 Uncertain
- X(alarm No.):5 Uncertain
- X(alarm No.):6 Uncertain

[Probable Faulty Locations]

In the case of abnormal control power,

- Power unit

In the case of low voltage,

- Input voltage drop, power failure, blown fuse in input power circuit, or instantaneous power interruption

In the case of high voltage

- Power unit

**★ 2155 MCS Converter-link error**

The convertor link (used for communication between power unit and inverter unit) caused an error, disabling the NC from monitoring the power unit condition.

[Index] Axis name or none (spindle)

[Character-string] None

[Code] XAAAAAYY

AAAAA is always 0.

X=0:communication error

X=1:Time-out error (communication interrupted)

YY=communication status

When X is ONE(1),always 0

[Probable Faulty Locations]

- Converter link cables or connectors
- Power unit
- Inverter unit control board

**★ 2156 MCS DC-bus voltage alarm**

The DC-bus voltage in the inverter unit has abnormally risen or fallen, disabling the inverter from supplying the current.

[Index] Axis name or none (spindle)

[Character-string] None

[Code] XXXXYYYY

XXXX= Detected overvoltage in hexadecimal [15.3 mV]

YYYY= Detected undervoltage in hexadecimal [15.3 mV]

[Probable Faulty Locations]

In the case of voltage rise,

- Power unit

In the case of voltage drop,

- Power unit
- Inverter unit
- Instantaneous power interruption

**★ 2157 MCS Motor over current**

The inverter unit has detected excessive current flowing in the motor cable.

[Index] Axis name or none (spindle)



[Character-string] None

[Code] XXXXYYYY

XXXX=U-phase current detected when this alarm occurs,expressed in signed hexadecimal [Tolerance: 3FFF]

YYYY=V-phase current detected when this alarm occurs,expressed in signed hexadecimal [Tolerance: 3FFF]

[Probable Faulty Locations]

- Invertor unit
- Faulty motor insulation

**★ 2158 MCS Power unit over heat**

The invertor unit has detected excessive current flowing in the motor cable.

The invertor unit temperature has risen abnormally.

[Index] Axis name or none (spindle)

[Character-string] None

[Code] 1 (fixed)

[Probable Faulty Locations]

- Invertor unit
- Overload operation

**★ 2159 MCS Power unit over load**

The invertor load has exceeded the specified value, activating the overload protection function.

[Index] Axis name or none (spindle)

[Character-string] None

[Code] YYYYZZZZ

YYYY->Gamma of the protection curve used to detect overload

ZZZZ->Internally calculated overload data

[Probable Faulty Locations]

- Invertor unit
- Overload operation

**★ 2160 MCS Supply voltage flutter**

The power unit input voltage is abnormally high or low.

[Index] Axis name or none (spindle)

[Character-string] None

[Code] Detected abnormal voltage in hexadecimal [Volt]

[Probable Faulty Locations]

- Power unit
- Power cables or connectors
- Instantaneous power interruption

**★ 2161 MCS Power unit version error**

The invertor unit allowable current is smaller than the current limit specified in the servo data file.

[Index] Axis name or none (spindle)

[Character-string] None

[Code] 1 (fixed)

[Probable Faulty Locations]

- Invertor unit
- Servo data file

★ 2162 **MCS Winding-change failed**

The winding-change magnet switch does not come on.

[Index] Axis name or none (spindle)

[Character-string] None

[Code] YYYYZZZZ

If YYYY = 0000

ZZZZ = 0001: Magnet conductor for low-speed winding is ON.

ZZZZ = 0002: Magnet conductor for high-speed winding is ON.

ZZZZ = 0003: Magnet conductors for both windings are ON.

ZZZZ = 0004: Winding change time-out

If YYYY = 1010

ZZZZ = 0001: Faulty servo data file

[Probable Faulty Locations]

- Winding-change magnet switch

★ 2163 **MCS Encoder-link error**

An error occurred in the encoder communication link, disabling the encoder from detecting positioning speed.

[Index] Axis name or none (spindle)

[Character-string] None

[Code] XXYYZZZZ

XX = FF (fixed)

YY = 00: Error is detected at the motor encoder.

01: Error is detected at the position encoder with shaft.

02: Error is detected at the independent position encoder.

03: Error is detected at ABSO SCALE.

ZZZZ=Encoder link error status at the time of error detection.

Each bit represents the kind of communication error.

bit 15 1: Error in communication with a stand-alone encoder

bit 14 1: Error in communication with ABSO SCALE 2

bit 13 1: Error in communication with ABSO SCALE or encoder with shaft

bit 12 1: Error in communication with motor encoder

bit 11 1: Undefined

bit 10 1: Transmission loop error in AT (auto) mode

bit 9 1: Data over error in data receiving part of interface

bit 8 1: Undefined

bit 7 1: Undefined

bit 6 1: Modulation code error

bit 5 1: CRC error

bit 4 1: Format error

bit 3 1: Double transmission error

bit 2 1: Double reception error

bit 1 1: Parity error

bit 0 1: Time-out error

[Probable Faulty Locations]

- Motor encoder, ABSO SCALE, encoder with shaft, or stand-alone encoder of the problem axis
- Encoder link cables or connectors
- Invertor unit control board

★ 2164 **MCS Encoder error**

The motor encoder has become unable to detect positional data.

[Index] Axis name or none (spindle)

[Character-string] None

[Code] XXYYZZZZ

XX= Encoder error code depending on the encoder type

YY = Detailed encoder status. The status varies with the encoder type.

ZZZZ =Multi-turn position data. This data appears when the multi-turn position data has exceeded the rotating range.

XX = 0 (fixed)

YY = 1 (fixed)

ZZZZ =Multi-turn position data

[Probable Faulty Locations]

- Motor encoder

★ 2165 **MCS Encoder initialize failed**

An error occurred in initialization of the motor encoder.

[Index] Axis name or none (spindle)

[Character-string] None

[Code] XXYYZZZZ

XX= Encoder link sequence number at the time of error detection

0: Reset

1: Network address setting

2: Request of basic information on communication

3: Change of communication version

4: Acquisition of device information

5: Parameter change

6: AT (auto) mode start

YY= Error content

0: Communication error

1: Transmission start time over

2: Transmission finish time over

3: Reception finish time over

4: Abnormal response address

5: Abnormal response code

6: Parameter error

ZZZZ= Additional data

If YY=0, the encoder link error status C2ERR at the time of error detection appears.

If YY=1, 2, or 3, the transferred frame information QC2MTINF appears.

If YY=4, the network address of the responding device appears.

If YY=5, the received frame information QC2RXINF appears.

If YY=6, the number of parameter that caused the alarm appears.

1= Not all the necessary parameters are received.

2= Basic information on communication is incompatible.

3= Multi-rotation detection range does not match.

[Probable Faulty Locations]

- Motor encoder
- Encoder link cables or connectors

- Invertor unit control board

★ 2166 **MCS Encoder with shaft error**

The encoder with shaft has become unable to detect positional data.

[Index] Axis name or none (spindle)

[Character-string] None

[Code] Same with <MCS Encoder error>

[Probable Faulty Locations]

- Encoder with shaft

★ 2167 **MCS Encoder with shaft initial**

An error occurred in initialization of the encoder with shaft.

[Index] Axis name or none (spindle)

[Character-string] None

[Code] Same with <MCS Encoder initialize failed>

[Probable Faulty Locations]

- Encoder with shaft
- Encoder link cables or connectors
- Invertor unit control board

★ 2168 **MCS ABSO SCALE error**

An error occurred in initialization of ABSO SCALE.

[Index] Axis name or none (spindle)

[Character-string] None

[Code] None

[Probable Faulty Locations]

- ABSO SCALE

★ 2169 **MCS ABSO SCALE initialize**

An error occurred in initialization of ABSO SCALE.

[Index] Axis name or none (spindle)

[Character-string] None

[Code] Same with <MCS Encoder initialize failed>

[Probable Faulty Locations]

- ABSO SCALE
- Encoder link cables or connectors
- Invertor unit control board

★ 2170 **MCS Magnetic encoder alarm**

The magnetic pulse generator has become unable to detect the motor speed. Or, the number of magnetic encoder gear teeth does not match the data in the MCS data file.

[Index] Axis name or none (spindle)

[Character-string] None

[Code] XXXXYYYYY

XXXX=Error content

A-> A-phase voltage is abnormal.

B-> B-phase voltage is abnormal.

C-> Magnetic encoder data error

Others-> Servo data file set value detected when the count over error occurred in the magnetic encoder  
(No. of PG gear teeth \* 4 - 1)

YYYY=Additional error data (Varies with XXXX.)

If XXXX is A, A-phase voltage appears.

If XXXX is B, B-phase voltage appears.

If XXXX is C, 0 (fixed) appears.

Others-> Detected count value of magnetic encoder (No. of PG gear teeth \* 4 - 1)

[Probable Faulty Locations]

- Magnetic encoder or its wiring, or large gap between magnetic encoder and gear
- Mismatch between the number of gear teeth of magnetic encoder and the servo data file data

**★ 2171 MCS Resolver alarm**

The resolver does not send any signal.

[Index] Axis name or none (spindle)

[Character-string] None

[Code] 1 (fixed)

[Probable Faulty Locations]

- Resolver trouble, or disconnection or contact failure of the resolver cable

**★ 2172 MCS Pulse generator count over**

The PG (pulse generator) count value per one turn differs from the corresponding data specified in servo data file.

[Index] Axis name or none (spindle)

[Character-string] None

[Code] XXXXYYYY

XXXX=PBU set value (Count number for one PG turn)

YYYY=Actual count number

[Probable Faulty Locations]

- Faulty PG
- Mismatch between the number of PG gear teeth and the servo data file data

**★ 2173 MCS Motor over heat**

The motor temperature is abnormally high.

[Index] Axis name or none (spindle)

[Character-string] None

[Code] YYYYZZZZ

YYYY =0 (fixed)

ZZZZ =0010: Motor overheat

ZZZZ =0011: Motor overheat is detected at the motor.

ZZZZ =0012: Motor overheat is detected at the position encoder.

ZZZZ =0013: Motor overhead is detected at the motor and the encoder.

[Probable Faulty Locations]

- Malfunction of VAC motor fan, dirty heat sink, CW/CCW turns and stops at high frequency
- BL motor
- Motor encoder (BL motor detects overheat by its encoder.)

★ 2174 **MCS Servo-link error**

A communication error occurred in the servo link, disabling the servo unit from receiving commands from the NC.

[Index] Axis name or none (spindle)

[Character-string] None

[Code] XXXXYYYY

XXXX=0 (fixed)

YYYY=Bit number indicating the kind of communication error  
(Servo link error status at the time of error detection)

bit 15 1: 2nd B-buffer error

bit 14 1: 2nd A-buffer error

bit 13 1: 1st B-buffer error

bit 12 1: 1st A-buffer error

bit 11 1: MT buffer error

bit 10 1: Relay processing error

bit 9 1: Data over error in data receiving part of interface

bit 8 1: Disconnection

bit 7 1: Address pointer error

bit 6 1: Modulation code error

bit 5 1: CRC error

bit 4 1: Format error

bit 3 1: Double transmission error

bit 2 1: Double reception error

bit 1 1: Parity error

bit 0 1: Time-out error

[Probable Faulty Locations]

- Invertor unit control board
- Servo link cables or connectors
- FCP board

★ 2175 **MCS Servo-link disconnect**

The servo link is disconnected, disabling the servo unit from receiving commands from the NC.

[Index] Axis name or none (spindle)

[Character-string] None

[Code] XXXXYYYY

XXXX=Disconnected position

0-> Disconnected right in front of the problem unit

8000->Disconnected before the problem unit

YYYY=Servo link error status at the time of error detection

[Probable Faulty Locations]

- Servo cables or connectors
- Invertor unit control board
- FCP board

★ 2176 **MCS Servo-link protocol error**

The NC and the invertor unit exchange commands and responses at constant intervals according to the specified protocol through the servo link. In this communication, a wrong protocol or abnormal timing was used to transfer the data from NC to the invertor unit.

[Index] Axis name or none (spindle)

[Character-string] None

[Code] Number indicating the error content

- 1: A-buffer Software synchronization error
- 2: A-buffer Format code error
- 3: B-buffer Software synchronization error
- 4: B-buffer Format code error
- 5: B-buffer Block number error

[Probable Faulty Locations]

- Inverter unit control board
- NC software
- Inverter unit control board not compatible with NC software
- FCP board

**★ 2177 MCS Servo data error**

The servo data sent from the NC for initialization or operation is not applicable to the inverter unit.

If this alarm occurs after change of inverter unit, the servo data file is not applicable to the inverter unit.

If this alarm occurs after adjustment or change of the servo data, the servo data is wrongly changed.

[Index] Axis name or none (spindle)

[Character-string] None

[Code] XXXXYYYY

XXXX=Data ID number of the data that caused the error

YY= Data set number of the data that caused the error

ZZ= Error content

- 1: Out of setting range
- 2: Wrongly set timing
- 3: No transmission
- 4: Calculation error
- 5: Others

[Probable Faulty Locations]

- Servo data file not compatible with inverter unit
- Inverter unit not compatible with NC software
- Inverter unit control board
- NC software

**★ 2178 MCS Illegal command**

The NC and the inverter unit exchange commands and responses through the servo link. In this communication, the NC sent an abnormal or inexecutable command to the inverter unit.

[Index] Axis name or none (spindle)

[Character-string] None

[Code] XXXXYYYY

XXXX=

- 10: Positioning mode Command point number over
- 11: Positioning mode Negative command value
- 12: Positioning mode Larger command value (specified position > 360 deg for rotary axis)
- 13: Positioning mode RPositioning point table not transmitted
- 14: Positioning mode Non-rotating axis
- 15: Positioning mode Command format other than points
- 16: Positioning mode Positioning sub-mode error

- 21: Parameter change Parameter number out of specifiable range
  - 22: Mode Undefined mode
  - 23: Mode Positioning/tool path mode condition
  - 24: Coordinate system Coordinate system designation error
  - 30: Unused bit is ON in the bit commands for controlling the S-link A buffer.
  - 31: Unused bit is ON among the bit data in the S-link B buffer.
  - 40: AT mode is selected without reception of time synchronization command.
- YYYY= Error data  
X in the range from 10 to 16 shows the positioning sub-mode.  
0: Program mode 1:Search mode 2:PH mode 3:Teach mode

[Probable Faulty Locations]

- Inverter unit not compatible with NC software
- Inverter unit control board
- NC software

**★ 2179 MCS CON speed over**

Increments for positioning command (SRCOND) issued from the NC to the inverter unit exceed the allowable limit.

If this alarm occurs in the axis to be positioned, the servo data file has wrong data. (This is because the inverter unit calculates the increments for the axis to be positioned.)

[Index] Axis name or none (spindle)

[Character-string] None

[Code]

Absolute value of increments processed for acceleration/deceleration  $[(pr/65536)/Tp]$

Where, pr= One turn of position encoder; Tp= Position control frequency

The following codes, however, have specific meanings:

- 1: The increments were so large that they were judged erroneous in preliminary check.
- 2: The position command (SRCON) exceeds the absolute value of the encoder measuring range (linear axis only).

[Probable Faulty Locations]

- Servo data file
- NC software

**★ 2180 MCS Speed command over**

Speed command value issued from the NC to the inverter unit exceeds the allowable limit.

[Index] Axis name or none (spindle)

[Character-string] None

[Code] Speed command  $[(rev/4294967269)/Tv]$

rev= One motor turn; Tv= Speed control frequency

[Probable Faulty Locations]

- Servo data file
- NC software

**★ 2181 MCS DIFF over**

Axis movement caused a large positioning error.

While the axis is in a target position or stopped, the target value and the calculated value are the same.

With an axis movement command, the NC starts creating calculation values (RCON) until the target point is reached. At this time, the actual position follows the calculated value with a certain delay. This delay is called "following error" and calculated by  $([calculation\ value] - [actual\ value])$ . If the "following error" exceeds the allowable limit, the above alarm occurs.



[Index] Axis name or none (spindle)

[Character-string] None

[Code] Absolute value of following error [pr/65536]

pr = One turn of position encoder

[Probable Faulty Locations]

- Overload due to faulty ball screw or bearing
- Motor
- Invertor unit
- Servo data file

**★ 2182 MCS APA speed over**

The position encoder value (RAPA) changes as the motor rotates.

The NC checks this change with preset frequency.

This alarm occurs if the change per unit time exceeds the allowable range consecutively. For example, an axis feedrate is abnormally high compared with the normal rapid feedrate, or the encoder value changes irregularly due to malfunction of the position encoder.

[Index] Axis name or none (spindle)

[Character-string] None

[Code]

Absolute value of the change in encoder value per position control frequency [encoder's 1/65536 turn/position control frequency]

The following codes, however, have specific meanings:

- 1= Linear axis has exceeded its travel range.
- 2= Rotary axis has exceeded its travel range (360 deg) or limited axis has negative positional data.
- 3= Limited axis has exceeded its travel range.

[Probable Faulty Locations]

- Motor encoder (BL motor)
- Encoder link cables or connectors (BL motor)
- PG or magnetic encoder (VAC motor)
- PG or magnetic encoder cables or connectors (VAC motor)
- Invertor unit control board

**★ 2183 MCS Full-closed APA error**

Difference between the full-closed loop encoder value and the motor encoder value exceeds the allowable range.

[Index] Axis name or none (spindle)

[Character-string] None

[Code] Number of times the error has been detected

[Probable Faulty Locations]

- Synthetic offset data is not set at the full-closed loop encoder or wrong data is set.
- ABSO SCALE or position encoder with shaft
- Excessive lost motion in axis drive system (The motor is not rigidly connected with the movable part.)
- Slippage or breakage of shaft belt
- Loose coupling between motor and ball screw
- Improper positional loop gain (too high)

**★ 2184 MCS Over speed**

Actual motor speed is too high.

[Index] Axis name or none (spindle)

[Character-string] None

[Code]

Motor speed detected when this alarm occurred [(rev/4294967296)/Tv]

Where, rev= One motor turn; Tv= Speed control frequency

[Probable Faulty Locations]

- Motor encoder (BL motor)
- Encoder link cables or connectors (VAC motor)
- Resolver or magnetic encoder (VAC motor)
- Resolver or magnetic encoder cables or connectors (VAC motor)
- Invertor unit control board

**★ 2185 MCS Velocity deviation over**

Actual motor speed excessively deviates from the speed command.

[Index] Axis name or none (spindle)

[Character-string] None

[Code] XXXXYYYY

XXXX: Detected torque (sum of the torque data collected for 3.2 ms)

+2<sup>-12</sup>[MAXTRQ]

If Tv = 0.4 ms, the momentary maximum torque is H'7FFF.

If Tv = 0.8 ms, the momentary maximum torque is H'3FFF.

YYYY: Detected acceleration (average value measured for 3.2 ms)

+2<sup>-16</sup>[vr/3.2 ms/3.2 ms]

= about 0.1 [rpm/ms]

The code number 00000001 means that the error data is replaced by zero because of exponent underflow.

[Probable Faulty Locations]

- The motor does not turn because of (mechanical lock or) application of large load.

**★ 2186 MCS Collision detected**

The NC torque limiter has detected collision of axis by monitoring the relation between motor output torque and motor acceleration.

[Index] Axis name or none (spindle)

[Character-string] None

[Code] XXXXYYYY

XXXX: Detected torque (sum of torque data collected for 3.2 ms)

+2<sup>-12</sup>[MAXTRQ]

If Tv = 0.4 ms, the momentary maximum torque is H'7FFF.

If Tv = 0.8 ms, the momentary maximum torque is H'3FFF.

YYYY: Detected acceleration (average torque measured for 3.2 ms)

+2<sup>-16</sup>[vr/3.2 ms/3.2 ms]

= about 0.1 [rpm/ms]

[Probable Faulty Locations]

- Collision
- Motor encoder
- NC torque limiter set value

**★ 2187 MCS Urgent-stop time over**

The axis cannot stop within a preset time after reception of emergency stop command.

[Index] Axis name or none (spindle)

[Character-string] None

[Code] XXXXXXXX

- 1: Emergency stop time over
- 2: Deceleration time over at emergency stop
- 3: Deceleration time over at alarm stop

[Probable Faulty Locations]

- Invertor unit control board
- NC software

**★ 2188 MCS Belt is broken**

Breakage of belt was detected in the belt-driven axis.

[Index] Axis name or none (spindle)

[Character-string] None

[Code] Load torque (hexadecimal) at the time of alarm detection

[Probable Faulty Locations]

- Broken belt

**★ 2189 MCS Axis change control error**

Axis change was not performed normally. (This is not an alarm caused in MCS.)

[Index] Axis to be selected by axis change

[Character-string] None

[Code]

- 1-> MCS was not reset within 10[s].
- 2-> Parameter set numbers matching signal or control ready signal failed to come ON within 10[s].
- 3-> MCS failed to receive the maximum APA value from the split encoder within 10[s].
- 6-> MCS controller failed to change in-position amount or zero offset amount within 10[s].
- A-> MCS controller failed to change in-position amount or zero offset amount within 10[s] after alarm occurrence.

[Probable Faulty Locations]

- Faulty MCS controller for PLC axis
- Faulty software

**★ 2190 MCS independent encoder init**

An error occurred during initialization of the MCS independent encoder.

[Index] Axis name or none (spindle)

[Character-string] None

[Code] XXYYZZZZ

XX-> Encoder link sequence number at the alarm occurrence

- 0: Reset
- 1: Net address setting
- 2: Request to send the basic information for communication
- 3: Change of communication software version
- 4: Acquisition of device information
- 5: Parameter change
- 6: AT mode start

YY-> Alarm content

- 0: Communication error
- 1: Transmission start time over

- 2: Transmission end time over
- 3: Reception end time over
- 4: Wrong response address
- 5: Wrong response code
- 6: Parameter error

ZZZZ->Data

YY = 0: Encoder link error status C2ERR established on detection of the error

YY = 1, 2, or 3: Transmitted frame information QC2MTINF

YY = 4: Net address of the corresponding device

YY = 5: Received frame information QC2RXINF

YY = 6: Parameter number at which the error is detected

1 = Reception of insufficient number of parameters

2 = Basic information for communication being incompatible

3 = Multi-turn detection range over

[Probable Faulty Locations]

- Independent position encoder
- Encoder link cables and connectors
- Inverter unit control board

**★ 2191 MCS APA error**

An error occurred during calculation of APA value.

[Index] Axis name or none (spindle)

[Character-string] None

[Code] XXXXXXXX

- 1: Linear axis divided travel over
- 2: Overflow during conversion of semi-position from [pr] to [pf].
- 3: Underflow in synthesizing the axis data
- 4: Overflow in synthesizing the axis data
- 5: Overflow of input values used for hybrid control
- 6: Overflow during initialization for hybrid control

[Probable Faulty Locations]

- Motor encoder, encoder with shaft, or ABSO SCALE
- Inverter unit control board
- Servo data file

If the alarm code is "1" or "3", the position encoder may not be properly offset to zero.

If the alarm code is "4", the servo data file may be defective.

If the alarm code is "5" or "6", the motor coupling, encoder with shaft, or ABSO SCALE may be loosely mounted.

**★ 2192 MCS Motor over load**

The motor load has exceeded the preset value, activating the overload protection function.

[Index] Axis name or none (spindle)

[Character-string] None

[Code] YYYYZZZZ

YYYY->Gamma of the protection curve used to detect overload

ZZZZ->Internally calculated overload data

[Probable Faulty Locations]

- Motor
- Overload caused by machine operation

- Servo data file

★ 2200 **Schedule program: 'Q'**

Illegal Q command of the schedule program

[Code]

1-> Data other than address character is designated where Q command must be designated.

4-> Address character other than Q is designated where Q command must be designated.

Others-> Numerical value of Q is not  $0 < Q \leq 9999$ .

Hexadecimal number of Q value

[Probable Faulty Locations]

Schedule program

Program Example:

PSELECT A.MIN ,, 20->Code 1

PSELECT B.MIN ,, P 10->Code 4

PSELECT C.MIN ,, Q 20000->Code D020 (Hexadecimal number of 20000)

[Measures to Take]

Correct the Q command in the schedule program.

Example: PSELECT A.MIN ,, Q 20

★ 2201 **Schedule program: mnemonic code**

Illegal schedule program command Instructions other than PSELECT, IF, GOTO, VSET and END are designated.

[Code] Hexadecimal number of ASCII code of the first four characters of the instruction

[Probable Faulty Locations]

Schedule program

Program Example:

N100 PSELECTA.MIN,, Q10

N200 G00 X100 Z200

[Measures to Take] Delete the wrong command(s) in the schedule program.

★ 2202 **Schedule program: program end**

No program end command is designated in the schedule program.

[Code] 1

[Probable Faulty Locations]

Schedule program

Program Example:

N010 VSET V1=1

N020 PSELECT LOADER.MIN

N030 PSELECT SHAFTR.MIN

N040 VSET V1=V1+1

N050 IF [V3 LE 10] N020

[Measures to Take]

Designate the END command at the end of the schedule.

Example:

N010 VSET V1=1

N050 IF [V3 LE 10] N020

N060 END

★ 2203 **Schedule program: main program load**

When the schedule program selection is executed, the OSP writes the main program in the schedule program to the operation buffer from the bubble memory. An alarm occurs if an error is detected within the main program during this writing process.

[Code] X

- 1-> No Automatic operation mode established.
- 2-> Command buffer not empty.
- 3-> Error occurs when reading out main program in PD0 task.

XYZZAABB:

X=1-> Automatic selection alarm

BB:

- Bit0-> Designated schedule program file is not present.
- Bit1-> Designated main program file is not present.
- Bit2-> Designated subprogram file is not present.
- Bit3-> Designated main program is not present.
- Bit4-> Designated subprogram is not present.
- Bit5-> M02 or M30 is not specified up to the end of the main program.
- Bit6-> RTS command is not specified up to the end of the subprogram.
- Bit7-> The program cannot be stored in the program buffer.

AA:

- Bit0-> The number of sequence names in the main program has exceeded 31.
- Bit1-> The number of characters in a sequence name exceeds 5, including N.
- Bit2-> No subprogram name is specified following CALL statement.
- Bit3-> The number of characters in a subprogram name exceeds 5, including O.
- Bit4-> Undefined G or M code macro is designated.
- Bit5-> The number of subprograms to be called exceeds 63.
- Bit6-> A block containing more than 156 characters presents.
- Bit7-> The sum of characters of main file name and extension exceeds 20 characters.

ZZ:

- Bit0-> A figure is specified at the beginning of the main file name and the extension of the designated file name.
- Bit1-> The number of characters in the device name exceeds 3, or no colon ( : ) is specified following the device name.
- Bit2-> Character "O" is not specified at the beginning of the designated program name.
- Bit3-> The program name designated contains other than alphabets and numbers.
- Bit4-> The number of characters in the specified program name exceeds 5, including O.
- Bit5-> The number of characters for option specification exceeds 16.
- Bit6-> The multi-volume identification is not present within 8 characters in the main file name.
- Bit7-> Program selection request is present during the execution of the schedule program.

Y:

- Bit-> 0 Program selection request is present during the execution of the main program.
- Bit-> 1 An attempt to select the program in the specification not supported
- Bit-> 2 The order number of the multi-volume file exceeds 99.
- Bit-> 3 Floppy disk drive is specified as a device name.

X=2 Faulty bubble memory

\* or ? symbols are present within the specified file name.

[Measures to Take] Correct the main program to be selected.

[Related Specifications] Schedule program

★ 2204 **Expression: right side**

An illegal command is designated in the right side of the expression. Commands other than numerical data, input variables, system variables, common variables, local variables and extended address characters are designated.

[Code]

- 2-> Output variable (VDOUT)
- IC-> (=) 2E Address character (A - F, H - L, P - Z)
- 30-> M code Mnemonic M code';
- 32-> G code Mnemonic G code';
- 36-> Sequence name
- 38-> Program name
- 3C-> M code macro
- 3E-> Printed character-string (" -- ")
- 40-> Apostrophe character-string (' -- ')
- 44-> Alarm comment variable (VUACM)
- 63-> Others

[Probable Faulty Locations]

Program error

Program Example:

VC1 = X WRITE

[Measures to Take] Correct the program.

★ 2205 **Expression: operation**

Calculation error of expression

[Code] XYYY

XX:

- Bit0-> Overflow in addition
- Bit1-> Overflow in converting ABS data into integer
- Bit2-> Conversion from BCD to BIN
- Bit3-> Conversion from BIN to BCD
- Bit4-> DROUND, DFIX and DFUP commands were designated in other than mm (inch) unit system.

YY: Floating-point calculation error

- Bit0-> Overflow in converting into integer
- Bit1-> Exponential underflow
- Bit2-> Exponential overflow
- Bit3-> Calculation of root of a negative number
- Bit4-> Division by 0
- Bit5-> Angle overflow

[Probable Faulty Locations]

Result of calculation

Program Example:

VC1 = 0

VC2 = VC2/VC1 -> Code 10 Division by 0

[Measures to Take]

Check the calculation result and correct the expression or a value.

★ 2206 **Expression: syntax**

Syntax error of expression

[Code]

- 1-> Calculation of subscript expression is intended within calculation of subscript expression.
- 2-> No left bracket "[" at the beginning of the subscript expression
- 3-> More than three subscript expressions
- 4-> The number of the left bracket "[" and that of the right bracket "]" do not match.
- 5-> The number of operands and their handling elements do not match.
- 6-> The sequence terminates within the expression.
- 7-> There are more than one solution.

[Probable Faulty Locations]

Program error

Program Example:

```
VC1 = VG COD [VC[10*2]]
```

Delete one "]" symbol.

[Measures to Take] Correct the program.

★ 2207 **Expression: factor**

Subscript expression is wrong.

[Code]

- None-> More than one subscript expression  
Others-> Result of subscript expression exceeds the range of subscript.

[Probable Faulty Locations]

Program error

Program Example:

```
X = VC [1, 6] WRITE
```

[Measures to Take] Correct the program.

★ 2208 **Expression: buffer over**

The number of expressions too large, making calculation impossible.

[Code]

- 1-> Overflow of operator stack in calculation of subscript expressions and operation expressions (more than 16)
- 2-> Overflow of operator data stack in calculation of operation expressions (more than 8)

[Probable Faulty Locations] Program error

[Measures to Take] Correct the program.

★ 2209 **Expression: local variable**

The local variable designated is not registered. (The local variable in question is specified at the right part in the block it appears first.)

[Code] ASCII of the entered local variable code in hexadecimal

[Probable Faulty Locations]

Program error

Program Example: This alarm occurs if the following expression is written at the beginning of a program.

```
VC1 = AB WRITE
```

Alarm [Code] "41420000"



[Measures to Take]

- 1) Correct the program.
- 2) Set the local variable before using it.

**★ 2210 Program bad direct: G code**

Illegal G code

Numerical value greater than 399 or less than 00 is assigned to the address character G (00 < G < 399).

[Code] Hexadecimal number of the designated G code

[Probable Faulty Locations] Program error

[Measures to Take] Check the G code.

**★ 2211 Program bad direct: M code**

Illegal M code

Numerical value greater than 399 or less than 00 is assigned to the address character M (00 < G < 399).

[Code] Hexadecimal number of the designated M code

[Probable Faulty Locations] Program error

[Measures to Take] Check the M code.

**★ 2212 Program bad direct: common variable**

Wrong common variable designation

The alarm occurs when

- a) a character other than alphanumeric character is designated following V, or
- b) V0 is designated.

[Code]

None-> Characters other than alphanumerics are designated following address character V, or V0 is programmed.

Others-> Variable number other than  $1 \leq V \leq 128$  and  $901 \leq V \leq 932$  is designated.

Hexadecimal number of the designated variable number

[Measures to Take] Check the program.

**★ 2213 Program bad direct: system variable**

Wrong system variable command

Name not registered in the system variable is entered, or more than four characters follow V.

[Code] ASCII code of first four letters following V of entered system variable name in hexadecimal

[Measures to Take] Check the system variable.

**★ 2214 Program bad direct: sequence name**

Illegal sequence name designation

- a) Character-string beginning with "N" is not correct.
- b) Character-string beginning with "N" contains a character other than alphanumerics.
- c) The number of characters following address character N is more than four.

[Code]

1-> Characters other than alphanumerics follow N.

2-> The number of characters following address character N is more than five.

[Probable Faulty Locations]

Sequence name configuration

Program Example:

N12345 (Number of characters too large)

[Measures to Take] Correct the sequence name.

★ 2215 **Program bad direct: numerical data**

Error in designating numerical data

- a) The data contains more than one decimal point.
- b) The data contains more than eight digits (decimal point not included).

[Code]

8-> The number of digits of the numerical data is more than 8.

Others-> More than one decimal point is specified.

The number of digits left to the 2nd decimal point

Example: If VC1 = 123.456.78, the code is "6".

[Probable Faulty Locations]

Numerical data

Program Example:

VC1 = 123456789 (Too many digits)

VC1 = 123.4.5 (More than one decimal point)

[Measures to Take] Correct the numerical data.

★ 2216 **Program factor over**

Overflow of the stack to register factor classification codes and parameters (more than 126 items)

Overflow of the factor data stack (more than 64 items)

[Code]

1-> Overflow of the stack to register factor classification codes and parameters

2-> Overflow of the factor data stack

[Probable Faulty Locations]

The number of program elements in one block is too large, i.e., the program is too long.

Program Example:

```
AA=0+1+2+3+4+5+6+7+8+9+0+1+ ... +9+0+1+2
   ^^^^^^^^^^^^^^^^^^^^^^^^^^^^^^^^^^^^^ ^^^^^^   ^^^
                   1           2...6           Code 1
P=0 P=1 P=2 P=3 P=4 P=5 P=6 P=7 P=8 P=9
Q=0 ... Q=9 R=0 ... R=9 I=0 I=1 I=2 I=3
                                   ^^^ Code 2
```

[Measures to Take] Correct the program by dividing one block data into two blocks.

★ 2217 **Program bad direct: use of character**

Illegal symbols are designated.

Designatable symbols are "]", "[", "=", "\*", "/", "+", "-", ".", DEL, BS, CR, HT and SP.

[Code]Hexadecimal number of ASCII code of the designated symbol

[Probable Faulty Locations]

Symbols in the program

Program Example:

IF < VC1 EQ 10] N10

^ This symbol causes an alarm.

Alarm [Code] 3C

[Measures to Take] Correct the commands.

★ 2218 **Program bad direct: program name**

Program name (a command beginning with address character O) contains characters other than alphanumerics or it contains too many characters.

[Code]

- 1-> No character follows address character O, or characters other than alphanumerics follow it.
- 2-> The number of characters following address character O is more than four.

[Probable Faulty Locations]

Program name in the program

Program Example:

P1\*AB -> Alarm code 1  
    ^

OABCDE -> Alarm code 2  
  ^^ ^^^^ 5 characters

[Measures to Take] Specify the O command value correctly.

★ 2219 **Sub program: repeat**

A subprogram repetition number other than 1 through 9999 is designated in the Q command.

In the CALL command, which calls out a subprogram, and the MODIN command, which calls out a subprogram after the completion of axis movement, the number of subprogram repetitions is specified by a Q command.

[Code] Hexadecimal number of designated repetition number

[Probable Faulty Locations]

The data of a Q command in the CALL or MODIN block

Program Example:

CALL O\*\*\* Q-

MODIN O\*\*\* Q-

[Measures to Take] Check and correct the Q command data in the CALL or MODIN block.

★ 2220 **Sub program: stack**

Subprogram nesting level is higher than eight.

Or the number of RTS statements used to return to the program where the subprogram was called has exceeded the number of CALL statements calling for a subprogram. Or the number of MODOUT statements canceling MODIN mode is larger than the number of MODIN statements.

[Code]

- 1-> The number of RTS statements is too large.
- 2-> Nesting level of subprograms is higher than eight.
- 3-> The number of MODOUT statements is too large.
- 4-> Nesting level of MODIN mode is higher than eight.
- 5-> Mismatch in levels where MODIN mode is called and canceled.

[Probable Faulty Locations]

The number of CALL, RTS, MODIN, and MODOUT statements in a part program  
Program Example:

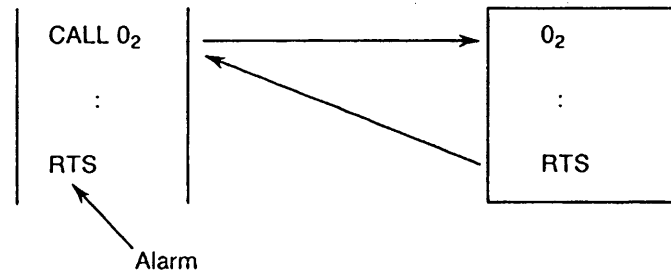

[Measures to Take]

Check the nesting level and the number of CALL, RTS, MODIN and MODOUT statements in a part program, then correct as needed.

★ 2221 **Sub program: program name**

No subprogram name is designated in the sequence containing a CALL or MODIN statement. Or the subprogram name designated in such a sequence is not registered in the program name registering stack.

[Code]

- 1-> No subprogram name is designated.
- 2-> The programmed subprogram name is not registered in the program name registering stack.

[Probable Faulty Locations]

Program name designated in CALL or MODIN command in the program.

Program Example:

- 1) CALL  ← Subprogram not specified
- 2) CALL X○△ ← Wrong subprogram name

[Measures to Take] Designate a correct subprogram name.

★ 2222 **Mnemonic or local variable**

The local variable name contains more than four characters.

Spelling of the reserved word (mnemonic) is wrong.

- \* If no space is placed following a mnemonic, the two words consisting of the mnemonic and the word specified following it is handled as a single word therefore causing an alarm.

[Character-string] Designated local variable name or reserved word

[Probable Faulty Locations]

An alarm usually occurs with a character-string consisting of five or more characters; either spelling error of a mnemonic or no space following a mnemonic.

Program Example:

Local variable->LPTNT = LP1 + 1 (more than 4 characters)

Mnemonic-> FMILRX100 Y100 Z100  
                  ^1000000000

(no space between mnemonic and axis command X)

[Measures to Take]

- 1) In the case of a local variable, check the number of characters and assign the correct data.
- 2) In the case of a mnemonic, place a space between the mnemonic and the following command.

★ 2223 **Branch (IF, GOTO): sequence name**

Command of sequence name for branching by IF or GOTO statement is wrong.

[Code]

- 1-> Sequence name where branching is to be made is not designated.
- 2-> Designated sequence name is not found.

[Probable Faulty Locations]

Sequence name in IF or GOTO statement block

Program Example:

GOTO \_\_\_\_\_  
          ^ Sequence name is not designated.

[Measures to Take] Designate the designation sequence name for branching correctly.

★ 2224 **Branch (IF, GOTO): condition**

Wrong command following IF statement, or condition evaluation data is incorrect.

[Code]

- 1-> No "(" following IF
- 2-> The data in ( ) following IF is not a comparison expression.

[Probable Faulty Locations]

Syntax error

- 1) No "(" following the IF statement
- 2) The data in ( ) following IF is not a comparison expression.

Program Example:

IF \_ CV1 LT 5) N100  
   ^ "(" not designated

[Measures to Take] Designate the command correctly.

★ 2225 **Unusable: G code**

G code not available with the selected specification is designated.

[Code] Hexadecimal number of the designated G code

[Probable Faulty Locations]

Hexadecimal number of the designated G code

Program Example:

N001 G99 X100 (G99 is not used)  
      ^^^

[Measures to Take] Designate the G code in the specification.

★ 2226 **Special G code table**

The table in which special G codes (CALL, RTS, MODIN, MODOUT, G code macro, NOEX, MSG, NMSG, RTMDI, RTMCR, GRON, GROF, etc.) are registered is destroyed or is not registered correctly.

[Code] Hexadecimal number of the designated G code

[Probable Faulty Locations]

- 1) Problem with control software
- 2) Problem with special G code table (not registered, registered incorrectly, table other than mnemonic G code registered)

★ 2227 **Unusable: M code**

- (1) In the designation following "M=", the number to be assigned to the M code is a number within a range of M code macro code (201 - 210).
- (2) An M code macro is designated by the "M=" type.

[Code] Hexadecimal number of the designated M code

[Probable Faulty Locations]

An M code macro is designated in the M= command.

Program Example:

M=VC1 (assume VC1=205)

M=209

[Measures to Take]

Since "M=" type designation is not allowed when designating an M code macro, change the number specified following M= or delete the "=" symbol.

**★ 2228 Unusable: M code**

In a mode other than the synchronized tapping mode, any of the following codes has been designated; M396, M397, M398, and M399.

[Code] Designated M code in hexadecimal

[Measures to Take]

Review the M codes in the program.

The M codes from M396 to M399 are effective only in the synchronized tapping mode.

**★ 2229 Equal is not exist**

For the following commands, a character-string other than a number or an equal (=) symbol is specified following them and thus a substitute expression is not formed:

G codes, M codes, extended address characters, local variables, common variables, system variables, output variables.

[Code]

Classification code and parameter of the factor designated at a position where "=" should be designated.

XXYY:

XX:Factor classification code (Refer to Appended Table 1.)

YY:Factor parameter (Refer to Appended Table 1.)

[Probable Faulty Locations]

A character other than a number or an equal symbol is specified following the commands specified above.

Program Example:

G+1 M \* 3 PA3 (Must be PA=3)

^ ^ Must be an "=" sign.

[Measures to Take] Correct the command.

**★ 2230 Unusable: direct of left side**

Illegal command in the left part of the expression Schedule program:

Left part is not system variable, common variable (VC1 through VC128) or output variable in VSET sequence.

Main program, Subprogram:

The left part contains other than G codes, M codes, address characters, extended address characters, local variables, system variables, and output variables.

Code Classification code of factor and parameter designated (Refer to Appended Table 1.)

[Probable Faulty Locations]

- 1) Error in VSET command in the schedule program
- 2) In the case of a main program, a code or a character which cannot be specified at the left part of an expression is specified.

Program Example:

1) VSET PTOR = 500 . . . . . Local variable command

2) VDIN[1] = VC1 . . . . . Input variable at a left part

[Measures to Take]

Check the cause of wrong commands from the factor classification code and make corrections.

★ 2231 **Direct of subscript**

Subscript expression

Subscript value used for a common variable, a system variable or an input/output variable is outside the specified range (too large or too small).

[Code]

When subscript outside the specified range is designated, hexadecimal number of the designated subscript

[Probable Faulty Locations]

- 1) Subscript expression
- 2) Designation of variable (common variable, etc.) used as a subscript

[Probable Faulty Locations]

VC[129]=1 (Range of subscript is 1 to 128 for common variable.)

VTOFH[X[350] = 300 (The maximum number of tools is exceeded.)

[Measures to Take] Check and correct the subscript value.

★ 2232 **Bad value of system variable**

System variable is not used correctly.

[Code]

1-> The system variable of read-only type is specified at the left part of an expression.

2-> System variables for EC-P are specified although EC-P is not supported.

\*\*-> An attempt is made to set a value which is outside the range for system variable.

\*\* is hexadecimal expression of the commanded value. For system variables related with programmable travel limit, a value in which zero offset is added to the commanded value.

Program Example:

VINCH = 2 (read-only type)

VATOL = 1 (alarm if EC-P is not supported)

VZOFX[1] = 999999.99 (commanded value is outside the range)

[Measures to Take]

Determine the wrong command from the code number and correct the command.

★ 2233 **Local variable use over**

The total number of local variables used in the main program, the subprogram called from the main program, the library program, etc. exceeds 255.

Note: Even if local variables assigned with the same name are used in the routine to call out other routine and in the routine called out, they are treated as different local variables and thus counted as two.

[Code]1

[Probable Faulty Locations]

The total number of the local variables used in a main and subprograms exceeds 255.

Program Example:

CALL O01 PA = LA

^^ (assume this is the 255th local variable.)

:

O01

PA = VC1

^^ An alarm occurs with this local variable.

[Measures to Take] Correct the programs to reduce the number of local variables.

★ 2234 **Program bad direct: unit designation**

When G20 (inch input confirmation) or G21 (metric input confirmation) is specified, the system checks whether the unit system selected by the setting at NC optional parameter (bit) No. 3 bit 0 matches the unit system designated by the specified G code. An alarm occurs if the unit systems do not match each other.

- a) An alarm occurs if the unit system selected is metric when G20 command is designated.
- b) An alarm occurs if the unit system selected is inch system when G21 command is designated.

[Measures to Take] Check the setting of NC optional parameter (bit) No. 3 bit 0.

★ 2235 **Program name not selected**

Wrong program name command

A program name different from the name of the program currently being executed is designated.

[Code]

Hexadecimal number of the ASCII code of the four characters specified following address character O

[Probable Faulty Locations]

- 1) More than one program name is specified in a single program.
- 2) Program name is not designated at the beginning of the program.

Program Example:

```
O100  
G00 X0  
O200  
G00 Y0  
:
```

[Measures to Take]

- 1) Delete unnecessary program names.
- 2) Designate a program name at the beginning of the program.

★ 2236 **Program end code not found**

The end of program code is not designated.

[Code]

- 1-> There is no end of program code.
- 2-> A right parenthesis ")" is not specified corresponding to a left parenthesis "(".
- 3-> No G40 code (radius compensation cancel)

[Measures to Take] Specify the end of program code at the end of a program.

★ 2237 **Unusable: Optional block skip**

Improper value is specified following a slash code (/).

[Code] Command value in hexadecimal

[Probable Faulty Locations]

- 1) At the beginning of a block or just after a sequence name
- 2) Improper designation of a block skip number

Program Example:

```
/4 ...
```

^ This causes an alarm.

[Measures to Take] Designate a correct value.



★ 2238 Unusable: RSTRT

An R command value is outside the allowable range.  
Allowable range:  $1 \leq R \leq 65535$

[Code] Command value in hexadecimal

[Probable Faulty Locations]

- 1) R command in RSTRT instruction
- 2) Error in R command range designation

Program Example:

```
RSTRT R65555
      ^^^^^ This causes an alarm.
```

[Measures to Take] Specify an R command value within the specified range.

[Related Specifications] Coordinate computation function

★ 2239 Unusable: OMIT

The total number of specified R command sets exceeds 30.

[Code]

- 0-> More than 30 sets of R commands are specified.
- Others-> Command value in hexadecimal
- Setting error of R command range ( $1 \leq R \leq 65535$ )

[Probable Faulty Locations]

- 1) R command in OMIT instruction
- 2) More than 30 sets of R commands are specified.
- 3) Error in range setting

Program Example:

```
OMIT R100 R1000 R10000 R100000
      ^^^^^ This causes an alarm.
```

[Measures to Take]

- 1) Reduce the number of R command sets. (30 or less)
- 2) Designate R value within a specified range.

[Related Specifications] Coordinate computation function

★ 2240 Unusable: LAA

Wrong I, J and K commands

[Code]

- 0-> The order of I and K command specification is wrong. (initial)
- 1-> The number of I and K command pairs exceeds 10.
- 3-> The K command value is outside the specified range. ( $1 \leq K \leq 65535$ )
- 4-> The order of I and K command specification is wrong. (halfway)

[Probable Faulty Locations]

I, J and K commands in LAA instruction

Program Example:

```
LAA Hp_ Hp_ Kn1 I+(-)d1 I+(-)d2 Km2 K0 ... J+(-)0
      ^^^Code1      ^^^Code4  ^^[Code] 3
```

Code1-> K specified at the beginning

Code4-> K specified in succession

Code3-> numerical value error

[Measures to Take] Specify the I and K commands in the correct order with correct values.

[Related Specifications] Coordinate computation function

★ 2241 **Unusable: ARC**

In the coordinate calculation function (ARC), designation of Q (vari-angle pitch) or K (repetitions of angle specified by Q) is wrong.

[Code]

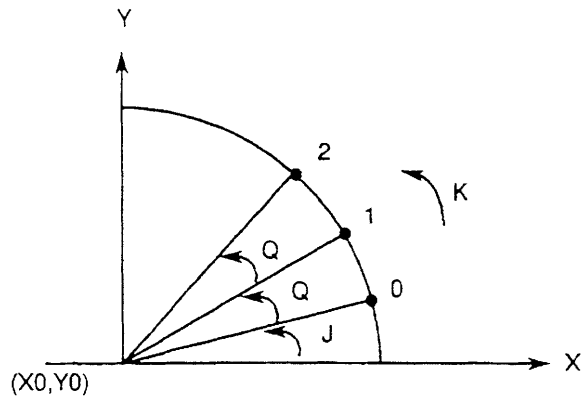

None->Q specified preceding K

- 1-> More than 10 sets of Q commands specified
- 2-> The K command value is outside the specified range ( $1 < K < 65535$ ).
- 3-> K commands are specified in succession.

[Probable Faulty Locations]

Program error (Q or K command)

Program Example:

[Code]

None->ARC X0 Y0 I50 K3 Q15  
                                  ^^^^^^

1-> ARC X0 Y0 I50 Q1 Q2 Q3 ... Q10 Q11  
                                  ^^^^^^^^^^^^^^^^^^^^^^^^^^^^

2-> ARC X0 Y0 I50 Q0.001 K65536  
                                  ^^^^^^

3-> ARC X0 Y0 I50 Q1 K2 K10  
                                  ^^^^^^

[Measures to Take] Correct the program.

[Related Specifications] Coordinate computation function

★ 2242 **Unusable: print**

Illegal print statement

[Code]

- 1-> Print is specified for other than variables, characters, numerical values, and extended address characters (FA, FB, RT and AG).
- 4-> Value VOK1 is outside 0 through 5 and 10 through 15.
- 5-> Value VOK2 is not 1 or 2.

[Probable Faulty Locations]

- Code1-> Character-string which cannot be designated by the PRINT statement is designated.
- Code4-> The VOK1 value specified by the PRINT statement
- Code5-> The VOK2 value specified by the PRINT statement

Program Example:

Code1-> PRINT X

Code4-> VOK1 = 7  
          PRINT VOK1

Code5-> VOK2 = 0  
PRINT VOK2';

[Measures to Take]

Code1-> Delete character-string which is not acceptable.  
Code4-> Change VOK1 value.  
Code5-> Change VOK2 value.

[Related Specifications] Print function

★ 2243 Data word: 'D'

Improper D command

[Code] Specified D command value in hexadecimal

[Probable Faulty Locations]

The G41 or G42 command (cutter radius compensation) block has a D command (cutter radius compensation number) of which value is out of the setting range. Or, G187 command (tolerance control mode ON) block has a D command (filter amount) of which value is out of the setting range.

Or, the G131 command (Super Hi-NC control mode ON) block has a D command (Program Tolerance value) of which value is out of the setting range.

[Measures to Take]

Refer to the instruction manual, and order the Program Tolerance value which is appropriate for the G131 command block.

Or, data setting range:

Cutter radius compensation number...1 to maximum number of data sets Filter amount ... 0 - 0.03[mm]

★ 2244 Data word: 'F'

Improper F command

[Code]

None-> The G187 command block has no F command.  
Or, the G131 command block has a F command of which value is out of the setting range.  
2-> The G01 mode has no F command.  
Others-> Specified F command in hexadecimal

[Probable Faulty Locations]

The G187 command (tolerance control mode ON, Hi-cut control mode ON) block has no F command (feedrate upper limit).

The F command value is out of the setting range.

Or, the G131 command (Super Hi-NC control mode ON) block has a F command (Feedrate Upper Limit value) of which value is out of the setting range.

[Measures to Take]

In G01 mode, specify the feedrate by F command.

In G187 command block, specify the feedrate upper limit by F command.

Or, refer to the instruction manual, and order the Feedrate

Upper Limit value which is appropriate for the G131 command block.

Data setting range:

G94 feedrate . . . 1 to 24000.0 mm/min

G95 feedrate . . . 1 to 500.000 mm/rev

Dwell time . . . 1 to 99999.999 [s]

★ 2245 Data word: 'H'

Improper 'H' command

[Code]

1-> The G15 or G16 command was specified in any of the following modes; G41, G42, G44, G51, G11 or COPY.

Others-> Specified H command value in hexadecimal

[Probable Faulty Locations]

Any of the G54 to G59 command (tool length offset) blocks has an H command (tool length offset No.) of which value is out of the setting range.

Or, the work coordinate system was selected during tool offset, coordinate shift, graphic conversion, or copy mode. Or, the G187 command (tolerance control mode ON) block has an H command (high speed mode) of which value is out of the setting range.

[Measures to Take]

Correct the program.

Data setting range:

Tool offset number . . . . 1 to maximum number of data sets

High speed mode . . . . 1 to 3

★ 2246 Data word: 'I', 'J' or 'K'

Improper I, J, or K command

[Code]

None-> The G256 command has two or more I, J, or K values.

Others-> Specified I, J, or K command in hexadecimal

[Probable Faulty Locations]

The G02 or G03 (circular cutting) command block has an I, J, or K command (coordinate of arc center) of which value is out of the setting range.

Or, the G187 command (tolerance control mode ON) block has an I, J, K command (selection of control axis) of which value is out of the setting range.

[Measures to Take]

Data setting range:

Coordinate of arc center . . . . +99999.999 mm (+99999.999 inch)

Selection of control axis . . . . 0 to 1

★ 2247 Data word: 'P'

Improper 'P' command value

[Code]

None-> The G0 block has no P command.

1-> Calculation error occurred during execution of P command in G51 block.

2-> Alarm is activated when  $P \leq 0$  at G178 or G179.

3-> Alarm is activated when  $P > 99999999$  at G178 or G179.

Others -> Specified P command value in hexadecimal

[Probable Faulty Locations]

The G30 block has no P command.

The G51 command block has an H command of which value is out of the setting range.

Or, the G11 (parallel/rotation shift of coordinate) block has a P command (rotation shift angle) of which value is out of the setting range.

Or, the COPY or COPYE command block has a P command (initial value/increment of rotation shift angle) is out of the setting range.

Or, the G30 command (movement to home position) block has a P command (home position number) of which value is out of the setting range.

Or, the G51 command (enlargement/reduction of geometry) block has a P command (magnification) of which value is out of the setting range.

Or, the G187 command (tolerance control mode ON) block has a P command(filter mode) of which value is out of the setting range

Or, the G131 command (Super Hi-NC control mode ON) block has a P command (Program Filter value: Length) of which value is out of the setting range.

[Measures to Take]

In the G30 command block, specify the home position No. with P command.

Or, refer to the instruction manual, and order the Program Filter value: Length which is appropriate for the G131 command block.

Data setting range:

Rotation shift angle . . . . . -360° to 360°

Home position number . . . . . 1 to 8 (1 to 32 depending on machine type)

Magnification for enlargement/reduction . . . 0.001 to 100.000

Filter mode . . . . . 1 or 2

★ 2248 Data word: 'Q'

'Q' command value is outside 0 through 999.

'Q' command value in the COPY mode is outside 1 through 9999.

The G131 command (Super Hi-NC control mode ON) block has a Q command (Program Filter value: Angle) of which value is out of the setting range.

[Code] Q command value in hexadecimal

[Probable Faulty Locations]

Q command in NC program

Program Example:

COPY\_Q10000 WRITE

[Measures to Take]

Specify correct command value.

Or, refer to the instruction manual, and order the Program Filter value: Angle which is appropriate for the G131 command block.

★ 2249 Data word: 'R'

'R' command value for arc radius command is outside the allowable range:(-99999.999) - (+99999.999) or zero (0).

The R command value in the G175 mode (cylindrical side surface cutting ON) is outside 1 to 5,000 mm.

Or, the G131 command (Super Hi-NC control mode ON) block has a R command (Minimum Block Length on Shape Reconstruction) of which value is out of the setting range.

[Code]

1-> With G178 or G179, the taper angle command R and the gap between taper start and end points (K, I) were specified at the same time.

2-> 'R' command is 0.

3-> A calculation error occurred during analysis of the taper angle command R specified with G178 or G179.

Others-> Command value in hexadecimal

[Probable Faulty Locations]

'R' command value in a program

Program Example:

G0X0Y0

G2X100R0F100 <- Alarm code 2

[Measures to Take]

Specify the correct command value.

Or, refer to the instruction manual, and order the value of Minimum Block Length on Shape Reconstruction which is appropriate for the G131 command block.

★ 2250 **Data word: 'RT'**

'RT' command value for tool radius compensation revolution number is outside the allowable range (-32768 to +32767)

[Code]

0-> OH specification

Others-> 'RT' command value in hexadecimal

[Probable Faulty Locations]

'RT' command value in a program

Program Example RT32768 WRITE

[Measures to Take] Specify the correct command value.

★ 2251 **Data word: 'S'**

Spindle speed 'S' command is outside the allowable range (0 - 20000).

[Code] 'S' command value in hexadecimal

[Probable Faulty Locations]

'S' command value in a program

Program Example:

S20001 WRITE

[Measures to Take] Specify the correct command value.

★ 2252 **Data word: 'T'**

Tool number 'T' command value is outside the allowable range (0 - 9999).

[Code] 'T' command value in hexadecimal

Program Example:

T10000 WRITE

[Measures to Take] Specify the correct command value.

★ 2253 **Data word: axis command**

Axis command value is outside the allowable range or is defective.

1) Rotary axis:

Axis command value is outside the allowable range\*, or it is not a multiple of five. allowable range: -360° to +360°

0 - 360° for units provided with a limit switch

2) Other than rotary axis:

Axis command value is outside the allowable range (-99999.999 to +99999.999).

3) Programmable mirror image (G62):

Axis command value is other than 0 (normal mode) and 1 (mirror image).

4) COPYE mode:

Parallel shift amount on the local coordinate system (sum of axis command value and parallel shift incremental amount) is outside the allowable range (-99999.999 to +99999.999).

5) G02 or G03 is specified although the control is not provided with the helical cut specification.

6) G02 or G03 is specified for a rotary axis.

7) An axis name has been designated by G14.

An axis command value other than -3, -2, -1, 0, +1, +2, and +3 has been designated.

Any of the X, Y, and Z- axis have not been designated.

[Character-string] Data word

[Code] Axis command value in hexadecimal

Any of the X-, Y-, and Z-axis have not been designated:

- 1-> Only the X-axis has been designated.
- 2-> Only the Y-axis has been designated.
- 3-> Only the X- and Y-axis have been designated.
- 4-> Only the Z-axis has been designated.
- 5-> Only the X- and Z-axis have been designated.
- 6-> Only the Y- and Z-axis have been designated.
- 10-> Only the A-axis have been designated.(B#301)
- 20-> Only the C-axis have been designated.(B#301)
- 1000->The specified X-axis command includes axis movement that passes the origin of the work coordinate system. (B#728)

[Such an X-axis command cannot be specified together with the infinite circular interpolation start command (G165 and G166) or the shape designation command for turning cut cycle].

2000->The Y-axis work coordinate is not 0.

[The Y-axis must be zero when the infinite circular interpolation start command (G165 and G166) is given.]

A pattern not allowed in the G14 mode has been designated:

0X0Y0Z00:

- X-> The machine axis number corresponding to program axis X
- Y-> The machine axis number corresponding to program axis Y
- Z-> The machine axis number corresponding to program axis Z

[Probable Faulty Locations]

Axis command value in a program

Program Example G00Z999999.99 (with the reference unit system)

[Measures to Take] Specify the correct command value.

**★ 2254 Data word: radius**

In a circular interpolation command, I, J and K commands and arc radius command R are specified in the same block. (When an R command is specified, I, J, and K commands must not be specified.)

[Code] 1

[Probable Faulty Locations]

An R command and a combination of I, J and K commands are specified in the same G02 or G03 block.

Program Example:

```
G02 X100 Y100 R70.711 I50 J50 F1000
      ^^^^^^^^  ^^^ ^^^
```

I and J commands are specified in the block in which an R command is specified.

[Measures to Take] Delete the I, J and K commands.

**★ 2255 Data word: arc calculation**

Arc center cannot be calculated with given arc radius command, or arc radius error is greater than the permissible value which is set at optional parameter (long word) No. 3.

[Code]

- 1-> An 'R' command value is smaller than one-half of the distance between the start and end points. An error does not occur when the amount smaller than this value is within the permissible error range set at NC optional parameter (long word) No. 3.
- 2-> An error occurred during coordinate calculation of the other axis.
- 3-> Radius error exceeds permissible value which is set at NC optional parameter (long word) No. 3. (local coordinate system)
- 4-> Commanded radius is zero (0), or the radius command is not specified.

- 5-> Another axis parallel to the plane currently selected, or the corresponding rotary axis is specified.
- 6 or 10-> Radius error exceeds permissible value which is set at NC optional parameter(long word)No.3.  
(work coordinate system)
- 7-> Calculation error during calculation of a radius
- 8-> In 3-D circular interpolation, the plane on which the arc is defined cannot be determined. (No P, Q or R command)
- 9-> When the projection plane is designated, the arc rotating direction in the designated plane cannot be determined.
- 11-> In 3-D circular interpolation. The designated axis has been canceled.
- 12-> In 3-D circular interpolation, the 3-D coordinate conversion command or an axis other than the rotary axis copied in the G11 mode has been designated.
- 13-> The value being specified for the cutter radius compensation is larger than the arc radius.

[Probable Faulty Locations]

- 1) Calculation error of arc radius R, or I, J and K commands in the circular interpolation mode
- 2) Setting error of optional parameter (long word) No. 3

Program Example:

```
G0X0Y0 Optional parameter (long word) No. 3: 10  
G2X100I49.99 F100
```

[Measures to Take]

- 1) Check the program for arc radius calculation error.
- 2) Check the setting of optional parameter (long word) No. 3.

★ 2256 **Data word: plane selection**

With a plane designation G code(G17 (XY plane), G18 (ZX plane), G19 (YZ plane)), an axis parallel to the horizontal or vertical axis of the plane selected, or the corresponding rotary axis is specified.

[Code]

- None-> Two or more of the following has been designated  
simultaneously: X-axis, U-axis, rotary axis corresponding to the X-axis
- 1-> Two or more of the following has been designated  
simultaneously: Y-axis, V-axis, rotary axis corresponding to the Y-axis
- 2-> Two or more of the following has been designated  
simultaneously: Z-axis, W-axis, rotary axis corresponding to the Z-axis
- 3-> With the Z-axis oscillation specification machine, a circular interpolation command has been designated in other than the Xp-Yp plane (designated by G17) in the M291 (oscillation start) mode.
- 4-> With the Z-axis oscillation specification machine, M291 (oscillation start) has been designated in a plane other than the Xp-Xp plane (designated by G17).
- 5-> The infinite circular interpolation start command (G165/G166) was given without selection of Z-X (G18) plane.

[Probable Faulty Locations]

Error in designating G17, G18 or G19 command

Program Example:

```
G17X0W0
```

[Measures to Take] Correct the program.

★ 2257 **Data word: machine coordinate (H00) selecting**

While the machine coordinate system is selected, G92 (work coordinate system selection), G11 (parallel/rotational shift of coordinates) or COPY command is designated.

[Code] 1

[Probable Faulty Locations]

G92, G11 or COPY command in a program



Program Example:

G15H0

G11X100Y100P25 WRITE

[Measures to Take]

Correct the program so that G92, G11 or COPY command is not designated while the machine coordinate system is selected.

★ 2258 **Data word: scaling**

Operation error occurred during enlargement and reduction processing (scaling) (G51).

[Code]

1-> Operation error during positive or reverse conversion

2-> Operation error during calculation of multiplication factor

[Probable Faulty Locations] Error in the calculation during scaling processing

[Measures to Take] Change the multiplication factor.

★ 2259 **Data word: coordinate conversion**

Operation error occurred during coordinate system conversion between the work and the local coordinate system.

[Code]

1-> Operation error occurred during conversion from local coordinate system to work coordinate system.

Operation error occurred while rotation copy of the normal vector of 3-D circular interpolation is being executed in the G11 mode.

2-> Operation error occurred during conversion from work coordinate system to local coordinate system.

[Probable Faulty Locations] Operation error during conversion

★ 2260 **Data word: mirror image**

Mirror image setting change command given in the mode in which such change is not allowed.

[Code]

1-> In arc mode

2-> In coordinate calculation mode

[Probable Faulty Locations]

Program error

Program Example:

G0X0Y0

G2X100I50F100

G62X1Y1

[Measures to Take] Correct the program.

★ 2261 **Data word: programmable travel limit**

Improper programmable travel limit value specified in the G22 block.

[Code] G22 command value in hexadecimal

[Probable Faulty Locations]

Command value specified in the G22 block is outside the soft-limit range set at a system parameter.

[Measures to Take]

Change a command value in the G22 block so that it is within the soft-limit range.

[Related Specifications] Programmable travel limit specification

★ 2262 Data word: spec code

A code not usable in the selected specifications was programmed.  
Commands which cannot be executed at the same time were specified.

[Code]

- 1-> G60 command is specified although the control is not provided with the G60 specification. G10 or G11 command is specified during the execution of G236.
- 2-> G31 command is specified although the control is not provided with the G31 specification. G10, G11 or G237 command is specified during the execution of G51.
- 3-> G92 command is specified although the control is not provided with the G92 specification. G10, G11 or G237 command is specified during the calculation of coordinate values.
- 4-> G43 or G44 command is specified although the control is not provided with the G43 or G44 specification. G30 command is specified in other than a normal mode.
- 5-> G09, G61 or G64 command is specified although the control is not provided with G09, G61 or G64 specification. G92 command is specified in other than a normal mode.
- 6-> G62 is specified although the control is not provided with the G62 specification. G92 command is specified during the execution of G51.
- 7-> G50 or G51 is specified although the control is not provided with the G50 or G51 specification. G92 command is specified during the execution of G11.
- 8-> The 3D offset command is specified although the control is not provided with the 3D offset specification.
- 9-> G31 is specified in other than a normal mode.
- 10-> G95 is specified although the control is not provided with the G95 specification.
- 12-> G231 is specified although the control is not provided with the G231 specification.
- 13-> G10, G11, G236 or G237 is specified although the control is not provided with the G10, G11, G236 or G237 specification.
- 15-> G22 or G23 is specified although the G22 or G23 specification.
- 16-> G241 or G242 is specified although the control is not provided with the G241 or G242 specification.
- 17-> G403 is specified although the control is not provided with the G403 specification.
- 18-> G400, G401, G402 or G404 is specified although the control is not provided with the G400, G401, G402 or G404 specification.
- 19-> The print function is specified although the control is not provided with the print function specification.
- 20-> G212, G213, G214, G217 or G218 is specified although the control is not provided with the G212, G213, G214, G217 or G218 specification.
- 21-> The graphic display (animated display) command is specified although the control is not provided with the graphic display (animated display) specification.
- 22-> A chamfering command (CHFC, CHFR) is specified although the arbitrary angle chamfering specification is not provided.
- 23-> G14 is specified although the axis name designation specification is not provided.
- 24-> A command between G180 and G185 is specified although the attachment rotation compensation specification is not provided.
- 25-> The 3-D circular interpolation command is specified although the 3-D circular interpolation specification is not provided.
- 26-> G174 or G175 is specified although the cylindrical side surface machining specification is not selected.
- 27-> G68 or G69 is specified although the 3-D coordinate conversion specification is not provided.
- 32-> G186 or G187 is specified although the Hi-NC (tolerance control) specification is not provided.
- 33-> G274 or G284 is specified although the synchronized tapping specification is not provided.
- 34-> G132 or 'NURBS' command was specified though super Hi-NC function is not provided.

[Probable Faulty Locations] Error in program or specification code error

[Measures to Take]

Correct the program error which is specified by the alarm code displayed.

★ 2263 Data word: G code

Wrong G code command

[Code]

- 1-> G11/G69 (parallel/rotation shift of coordinate) and G10/G68 (cancel of parallel/rotation shift of coordinate) are specified during the G236 (copy) mode.
- 2-> G11/G69 (parallel/rotation shift of coordinate), G10/G68 (cancel of parallel/rotation shift of coordinate) and G237 (copy mode off) are specified in the G51 (shape enlargement/reduction) mode.
- 3-> G11/G69 (parallel/rotation shift of coordinate), G10/G68 (cancel of parallel/rotation shift of coordinate) and G237 (copy mode off) are specified during coordinate calculation.
- 4-> G30 (positioning at home position) is specified in other than a normal mode.
- 5-> G92 (work coordinate system setting) is specified in other than a normal mode.
- 6-> G92 (work coordinate system setting) is specified in the G51 (shape enlargement/reduction) mode.
- 7-> G92 (work coordinate system setting) is specified in the G10/G68 (cancel of parallel/rotation shift of coordinate) or G236 (copy) mode.
- 8-> G41 (cutter offset to left) or G42 (cutter offset to right) is specified in other than a normal mode.
- 9-> G31 (skip) command is specified in other than a normal mode.
- 14-> G41 (cutter offset to left) or G42 (cutter offset to right) is specified during the execution of the graphic function.
- 15-> The fixed thread cutting cycle is specified during parallel or rotation shift of the coordinate in the G11 mode.  
     .G178, G179, TRDL, or TRDT command was executed during the following operations;  
     Enlargement/reduction(G51), coordinate parallel or rotational shift(G10), copy(G236).
- 16-> The cutter radius compensation command is specified in the 3-D circular interpolation mode.
- 17-> The 3-D circular interpolation command is specified in the cutter radius compensation mode.
- 18-> The axis name designation (G14) is specified while any of the following operations is in progress.
  - 1) Local coordinate system setting (G11)
  - 2) Scaling (G51)
  - 3) Fixed cycle
  - 4) Cutter radius compensation (G41 or G42)
  - 5) 3-D tool compensation (G44)
  - 6) Tool length offset (G54, G55, G56)
  - 7) Circular interpolation mode including 3-D circular interpolation (G02, G03, G172, or G173)
  - 8) 3-D coordinate conversion (G69)
  - 9) Cylindrical surface side machining (G175)
  - 10) An address character other than O and N is not designated after the designation of cutter radius compensation cancel (G40).
- 20-> Work coordinate system setting (G92) is specified during 3-D coordinate conversion (G69).
- 21-> The 3-D coordinate conversion ON or OFF command (G68 or G69) is specified in the G14 mode.
- 22-> The 3-D coordinate conversion ON or OFF command (G68 or G69) is specified in the G11 mode.
- 23-> The cylindrical side surface machining ON or OFF command (G175 or G174) is specified while any of the following operations is in progress.
  - 1) Fixed cycle
  - 2) Area machining
  - 3) Cutter radius compensation
- 24-> The cylindrical side surface machining ON or OFF command (G175 or G174) is specified while coordinate calculation or arbitrary angle chamfering is in progress.
- 25-> The cylindrical side surface machining ON or OFF command (G175 or G174) is specified during 3-D coordinate conversion (G69).
- 26-> The cylindrical side surface machining ON command (G175) is specified when the plane not including a rotary axis is selected.

Note: This alarm occurs if the cylindrical side surface machining is attempted on the machine not provided with a rotary axis having a limited or unlimited rotation range.

- 27-> The 3-D coordinate conversion command (G69) is specified in the cylindrical side surface machining mode (G175).
- 28-> A 3-D circular interpolation command is specified in the 3-D coordinate conversion mode (G69).
- 29-> NURBS (G132) mode is specified when Super Hi-NC execution mode is OFF.
- 30-> G code not included in G00 group is specified in NURBS (G132) mode.
- 31-> G code other than G132 is specified in the block where NURBS (G132) mode is specified.
- 32-> In the NURBS (G132) mode...
  - G code other than G132 is specified in the block where NURBS (G132) mode is specified.
  - The G code at the start of the block is not the one for ending G132.
- 33-> In the NURBS (G132) mode...
  - G code for ending G132 is not at the top of the block.
  - G code other than the one for ending G132 is specified.
- 34-> NURBS (G132) mode is specified during cutter radius compensation (G41,G42).
- 35-> NURBS (G132) mode is specified during 3-D tool offset (G44).
- 36-> NURBS (G132) mode is specified when feed-per-minute is not selected.
- 37-> NURBS (G132) mode is specified when an axis name is designated (G14).
- 38-> NURBS (G132) mode is specified during cylindrical side machining (G175).
- 39-> A mode signal other than the normal mode is detected NURBS (G132) mode.
- 40-> A NURBS (G132) command was specified during the turning cut cycle.
- 41-> The graphic enlargement/reduction command (G51) was specified during the turning cut cycle.
- 42-> The work coordinate system was selected (by G15/G16) in the turning cut mode.
- 43-> A slope coordinate system was selected (by G69) in the turning cut cycle.
- 44-> The turning cut mode was selected (by G149) during STM lock.
- 45-> The infinite circular interpolation start command (G165/G166) was specified during parallel/rotation shift of the coordinate system (by G11).
- 46-> The infinite circular interpolation start command (G165/G166) was specified in the copy mode (G236).
- 47-> The infinite circular interpolation start command (G165/G166) was specified during enlargement/reduction of graphic data (G51).
- 48-> The infinite circular interpolation start command (G165/G166) was specified during selection of a slope coordinate system (by G69).
- 49-> The turning cut mode was selected (by G149) while the feed-per-revolution is effective (G95).

[Probable Faulty Locations]

G code in a program

Program Example:

G52X0 WRITE

[Measures to Take]

Correct the program error which is specified by the alarm code displayed.

★ 2264 **Data word: M code**

An M code is specified in a mode other than the normal mode or in NURBS (G132) mode.

Modes other than the normal mode: fixed cycle, cutter radius compensation, 3D tool offset, area machining, and home position.

[Code]

- 1-> M code is specified in a mode other than the normal mode.
- 2-> M code is specified in NURBS (G132) mode.
- 3-> An M code for changing tools was specified in the turning cut mode.

[Probable Faulty Locations] M code in a program

[Measures to Take]

Do not specify M code in the NC program when a mode other than the normal mode or the NURBS (G132) mode is selected.

★ 2265 **MDI: special G code**

G code which cannot be executed in MDI mode is specified.

[Code]

- 1-> The specified G code is not executable in MDI mode.
- 2-> NURBS (G132) mode is specified in the MDI mode.
- 3-> MDI interrupt mode is selected and a cutting feed command is specified during the NURBS (G132) mode.

[Probable Faulty Locations]

G codes which cannot be executed in the MDI mode:

G101 - G110

G300 - G349

Special G codes such as MODIN, MODOUT, IF, GOTO

Operation Example:

MODIN 02 input in the MDI mode.

[Measures to Take]

- 1) Select the automatic operation mode before executing The M code.
- 2) MDI interruption is not allowed in NURBS (G132) mode.

★ 2266 **Main sequence**

Main sequence alarm

[Code] 1

★ 2267 **Sequence restart**

Wrong sequence restart command

[Code] X:

- 1-> CYCLE START pressed after executing restart command.
  - 2-> CYCLE START pressed before pressing RESTART button after the completion of search. (Alarm A)
  - 3-> Restart command programmed when main program not selected.
- There was not restart sequence until M02.

XYYYZZZ:

- 1-> Mismatch of the next tool
- 2-> Mismatch of the active tool
- 3-> Mismatch of both the next and active tools

YYY:Next tool number in the program

ZZZ:Active tool number in the program

[Probable Faulty Locations]

Operation error in sequence restart

- a) CYCLE START pressed mistakenly instead of SEQ. RESTART.
- b) Wrong restart sequence is specified.

Operation Example:

RS N10 WRITE

CYCLE START pressed

->SEQ. RESTART is to be pressed.

(Alarm code 2)

[Measures to Take]

Reset the control and carry out the operation correctly from the beginning.

★ 2268 Plus travel limit over

Target command value is greater than the positive travel limit value.

[Index] AXIS

[Code]

- 1-> The command value exceeds the positive travel limit while changeover of coordinate system is inhibited (during the execution of fixed cycle command M52, etc.).
- 2-> The command value exceeds the positive travel limit (positive programmable travel limit in the case of G22 mode) in cutting mode operation.
- 3-> The rapid feed command value exceeds the positive travel limit (positive programmable travel limit in the case of G22 mode) during fixed cycle mode operations.
- 4-> The rapid feed command value exceeds the positive travel limit (positive programmable travel limit in the case of G22 mode) during the area machining mode.
- 5-> The index table command exceeds the positive travel limit.
- 6-> The rapid feed command value exceeds the positive travel limit.
- 7-> The rapid feed command value exceeds the second positive travel limit.
- 8-> Directive value exceeded B axis revolution P stroke end limit by sending orders (#301)

[Probable Faulty Locations]

- 1) Wrong command values
- 2) Travel end limit values to be set by system parameters and user parameters are wrong or not set.
- 3) The establishment value which or has not established stroke end limit of B axis revolution systematic parameters is wrong.

[Measures to Take]

- 1) Check the command values.
- 2) Set the parameter data correctly.

★ 2269 Minus travel limit over

Target command value is smaller than the negative travel limit value.

[Index] AXIS

[Code]

- 1-> The command value exceeds the negative travel limit while changeover of coordinate system is inhibited (during the execution of fixed cycle command M52, etc.).
- 2-> The command value exceeds the negative travel limit (negative programmable travel limit in the case of G22 mode) in cutting mode operation.
- 3-> The rapid feed command value exceeds the negative travel limit (negative programmable travel limit in the case of G22 mode) during fixed cycle mode operations.
- 4-> The rapid feed command value exceeds the negative travel limit (negative programmable travel limit in the case of G22 mode) during the area machining mode.
- 5-> The index table command exceeds the negative travel limit.
- 6-> The rapid feed command value exceeds the negative travel limit.
- 7-> The rapid feed command value exceeds the second negative travel limit.
- 8-> Directive value exceeded B axis revolution N stroke end limit by sending orders (#301)

[Probable Faulty Locations]

- 1) Wrong command values
- 2) Travel end limit values to be set by system parameters and user parameters are wrong or not set.
- 3) The establishment value which or has not established stroke end limit of B axis revolution systematic parameters is wrong.

[Measures to Take]

- 1) Check the command values.
- 2) Set the parameter data correctly.

★ 2270 **No operation function**

Operation function is specified although the operation functions are not supported (User task 2).  
EOR, OR, AND, NOT, SIN, COS, TAN, ATAN, SQRT, ABS, BIN, BCD, ROUND, FIX, FUP, DROUND,  
DFIX, DFUP, ATAN2, or MOD programmed.

[Probable Faulty Locations]

Operation commands stated above are used within a program.

[Measures to Take]

Change the program to delete the unusable operation function commands from the program.

★ 2271 **No system variable function**

System variable is specified although the system variables not supported.

[Probable Faulty Locations] System variables are used within a program.

[Measures to Take]

Change the program to delete the system variables from the program.

★ 2272 **No subprogram function**

Subprogram is called although the subprogram specification is not supported.

[Probable Faulty Locations] Subprograms are used within a program.

[Measures to Take]

Change the program to delete the subprograms from the program.

★ 2273 **No input/output variable function**

Input/output variable is specified although the input/output variable\* function is not supported.

\* Input/output variable: VDIN[\*]  
VDOUT[\*]

[Code]

None-> User task 2 is not provided.

XYYYY-> The input/output variable function is not provided.

X=1: Output variable

X=2: Input variable

YYYY=0001 to 0014: Variable No. 1 to 20 in hexadecimal

[Probable Faulty Locations]

Input/output variables are used within a program.

[Measures to Take]

Change the program to delete the input/output variables from the program.

★ 2274 **Backup data file write**

An error occurred while backup data is being written to the bubble memory. Writing to the bubble memory is impossible.

[Code] Memory sector number (in hexadecimal) of bubble memory

[Probable Faulty Locations] Defective sector which is indicated by the alarm code

[Measures to Take]

- 1) Replace the bubble memory.
- 2) Initialize the bubble memory and reload the system software.

★ 2275 Fixed cycle: 'P'

Improper dwell time P specified or operation error

[Code]

- 0-> Operation error
- 2-> Improper command value

[Probable Faulty Locations]

- 1) Calculated dwell period exceeds the maximum dwell period (99999.999 [s]).
- 2) Selection of a wrong command unit system

[Program Example] G81 X100 Y100 Z100 R150 P100000 F1000

[Measures to Take]

- 1) Change the command unit system by the setting at NC optional parameter (bit) No. 3. For the example program above, select a unit system smaller than 0.1[s].
- 2) Change P command value; it must be smaller than 99999.999.

★ 2276 Fixed cycle: 'Q'

- 1) Improper Q command value (dwell period at point R level) is specified for the reverse tapping cycle (G74) or the tapping cycle (G84).
- 2) Improper Q command value (infeed amount or shift amount) is specified for the high-speed deep hole drilling cycle (G73), the deep hole drilling cycle (G83), the fine boring cycle (G76) or the back boring cycle (G87).

[Code]

- 0-> Q=0 is designated.
- Others-> Wrong command value (in hexadecimal)

[Probable Faulty Locations] Q command in fixed cycle commands

Program Example:

- 1) G73 X\_ Y\_ Z\_ R\_ P\_ Q100000 R\_ F\_ (unit: 1 [s])  
G83 X\_ Y\_ Z\_ R\_ Q0 P\_ F\_

[Measures to Take]

- 1) Change the command unit system by the setting at NC optional parameter (bit) No. 3. For the example program above, select a unit system smaller than 0.1 sec.  
Change Q command value; it must be smaller than 99999.999.
- 2) Specify correct values, or designate infeed amount or tool withdrawal amount using I and J commands.

★ 2277 Fixed cycle: 'R'

Wrong level R value or operation error

[Code]

- 0-> Operation error  
No level R value entry
- 1-> At G178 or G179, the taper angle 'R' command was executed simultaneously with the taper start/end point discrepancy 'J' (K,I) command.
- 3-> At G178 or G179, a calculation error occurred during analysis of the taper angle 'R' command.
- Others-> Command value in hexadecimal

[Probable Faulty Locations]

R command in fixed cycle commands

Program Example:

G73 X\_ Y\_ Z\_ P\_ Q\_ F ... Alarm code 0

[Measures to Take] Specify correct R command value.



★ 2278 **Fixed cycle: axis command**

Parallel axes are programmed simultaneously.

[Code]

- 0-> X-axis
- 1-> Y-axis
- 2-> Z-axis
- 3-> Parallel axis

[Probable Faulty Locations]

Axis command in fixed cycle

Program Example:

```
G17 X_ Y_  
G81 X_ Y_ Z_ W_ R_ F_  
      ^^ ^^
```

An alarm occurs since cycle-axis cannot be determined whether Z- or W-axis.

[Measures to Take] Designate either of the axes as the cycle-axis.

★ 2279 **Fixed cycle: cycle axis**

No cycle axis movement is programmed for the cycle-axis.

Or axis movement command is programmed for the additional axis.

[Probable Faulty Locations]

Axis movement command during fixed cycle

Program Example G17 X\_ Y\_ No cycle-axis (Z-axis) programmed

G81 X\_ Y\_ (W\_) R\_ F\_ (Additional axis (W-axis) programmed)

[Measures to Take] Designate axis movement command using the basic axis.

★ 2280 **Fixed cycle: R and Z position relationship**

Improper relationship between level R and level Z

The point designated using the G71 code in the M53 mode (return to the point designated by G71) is smaller than point R.

[Code]

- 1-> Level R and level Z are identical.
- 2-> Level R is set higher than level Z.
- 3-> Level R is set lower than level Z.

[Probable Faulty Locations]

Points R and Z commands within a fixed cycle

Program Example:

```
G17 G00 X_ Y_  
G71 Z80.0 Designated point  
G81 X_ Y_ Z_ 90.0 R90.0 F_ M53
```

- 1) Point R and point Z at the same level
- 2) Point R is higher than the designated point.

[Measures to Take] Correct the Z and R commands.

★ 2281 **Fixed cycle: retract amount**

Tool retract amount "d" set at NC optional parameter(long word) No. 1 and No. 2 is improper for the high-speed deep hole drilling cycle (G73) or the deep hole drilling cycle (G83).

[Code] Command values in hexadecimal

[Probable Faulty Locations]

Tool retract amounts set at NC optional parameter (long word) No. 1 and No. 2 used for the G73 and the G83 cycles are wrong.

Program Example:

G73 X\_ Y\_ Z\_ R\_ P\_ Q\_ F\_

[Measures to Take]

Set proper tool retract amounts at NC optional parameter (long word) No. 1 and No. 2.

★ 2282 **Fixed cycle: shift amount**

Shift amounts set by I and J commands, used for the fine boring cycle (G76) and the back fine boring cycle (G87) are improper.

[Code]

-1 -> Shift amount zero

0 -> Value programmed is outside the programmable range.

[Probable Faulty Locations]

Shift amount in the fixed cycle mode (G76, G87)

Program Example:

G76 X\_ Y\_ Z\_ R\_ P\_ F\_ No shift amount command

[Measures to Take]

Program proper shift amount with Q, or I and J commands.

★ 2283 **Fixed cycle: command impossible**

Fixed cycle is called in impossible mode.

[Code]

1-> Fixed cycle call command programmed after axis movement mode

2-> Fixed cycle call command programmed during cutter radius compensation mode, three-dimensional tool offset mode, or area machining mode

[Probable Faulty Locations] Program error

[Measures to Take] Correct the program.

★ 2284 **Fixed cycle: plane command**

Plane other than G17 is commanded although Z-axis is selected as the cycle-axis by parameter.

[Probable Faulty Locations] G18 or G19 command in the program

Program Example:

G18 Z100 X100 (NC optional parameter (bit) No. 17 bit 0: ON)

G76 X100 Y100 Z100 R150 F1000

[Measures to Take] Correct the program.

★ 2285 **Fixed cycle: no G71 command**

For designating the M53 (return to the designated point) mode in executing a fixed cycle, it is necessary to designate the return level using the G71 code prior to specifying the M53 mode. The alarm occurs if such return level has not been set when M53 mode is called out.

[Code]

0-> Cycle axis is X-axis.

1-> Cycle axis is Y-axis.

2-> Cycle axis is Z-axis.

[Probable Faulty Locations]

No G71 command prior to calling M53 mode

Program Example:

G81 X100 Y100 Z-60 R0 Q20 F100 M53  
^^^^^ No G71 prior to M53

[Measures to Take]

Designate the return point level with G71 before calling the M53 mode.

★ 2286 **Fixed cycle: M code**

The return to the upper limit level (M52) mode is specified although the cycle-axis for the fixed cycle is not Z-axis. M52 code is specified although the direction of infeed is positive (+).

[Code]

52-> This indicates that the programmed M52 has caused the alarm.

[Probable Faulty Locations]

The M52 return to the upper point level is designated in the block\* which does not allow the use of such mode.

\* The block in which the cycle-axis is other than Z-axis or the infeed direction is positive (+).

Program Example:

G18 G81 X100 Y100 Z-60 R0 Q10 F100 M52

^^^ An alarm occurs because M52 is specified in the G18 mode.

[Measures to Take] Delete the M52 command; change the mode to either M53 or M54.

★ 2287 **Fixed cycle: M code command**

An M code which cannot be specified is specified during the fixed cycle mode.

[Code]

6-> M06 is specified.

60-> M60 is specified.

[Probable Faulty Locations]

M06 or M60 is specified in the fixed cycle mode.

Program Example:

G81 X100 Y100 Z-60 R0 Q20 F100 M06  
^^^^

[Measures to Take]

Before programming M06 or M60, cancel the fixed cycle mode by specifying G80.

★ 2288 **Coordinate computation: H,V command**

Axis movement amount, obtained as the result of coordinate calculation, for the vertical or horizontal axis exceeds the allowable limit (-99999.999 to +99999.999 [mm]).

[Code] Result of calculation for the horizontal or the vertical axis (in hexadecimal)

[Probable Faulty Locations]

1) Improper horizontal or vertical axis command

2) Improper unit system selected

Program Example:

LAA X50000. I50000 . K5000 J30  
^

If a decimal point is used, the control assumes the unit of millimeters and thus an alarm occurs since this value is handled as 5,000 mm.

[Measures to Take]

Check the horizontal or vertical command value; correct as necessary.

[Related Specifications] Coordinate computation function

★ 2289 **Coordinate computation: I command**

- 1) At the beginning of coordinate calculation, no I command is specified in the block which contains a mnemonic instruction.  
Note that an I command must be specified even when I=0.
- 2) The commanded I value is outside the range indicated below:  
-99999999 < I < 99999999 [1/1000-deg, 1/10000-deg]  
-99999.999 < I < 99999.999 [mm]

[Code]

FFFFFFFF-> No I command

Others-> I command value (in hexadecimal)

[Probable Faulty Locations]

- 1) No I command
- 2) Improper I command value

Program Example:

I200

GRDX J200 K3 P2 F2000

No I command specified in the GRDX block

[Measures to Take]

- 1) Add an I command.
- 2) Check the I command value and the unit system.

[Related Specifications] Coordinate computation function

★ 2290 **Coordinate computation: J command**

- 1) At the beginning of coordinate calculation, no J command is specified in the block which contains a mnemonic instruction.  
Note that a J command must be specified even when J=0.
- 2) The commanded J value is outside the range indicated below:  
-99999999 < J < 99999999 [1/1000-deg, 1/10000-deg]  
-99999.999 < J < 99999.999 [mm]

[Code]

FFFFFFFF-> No J command

Others-> J command value (in hexadecimal)

[Probable Faulty Locations]

- 1) No J command
- 2) Improper J command value

Program Example:

J200

GRDX I300 K2 P3 F2000

No J command specified in the GRDX block

[Measures to Take]

- 1) Add a J command.
- 2) Check the J command value and the unit system.

[Related Specifications] Coordinate computation function

★ 2291 **Coordinate computation: K command**

- 1) No K command is specified in the block which contains a mnemonic instruction specified below:  
GRDX (Y), DGRDX (Y), SQRX (Y)  
Note that a K command must be specified even when K=1.
- 2) The commanded K value is outside the range indicated below:

$1 < K < 65535$  microns

[Code]

FFFFFFFF-> No K command

Others-> K command value (in hexadecimal)

[Probable Faulty Locations]

- 1) No K command
- 2) Improper K command value

Program Example:

GRDX I20. J20. P20

K20

No K command specified in the GRDX block

[Measures to Take]

- 1) Specify a K command in the block which contains a mnemonic instruction.
- 2) Correct the K command value.

[Related Specifications] Coordinate computation function

★ 2292 **Coordinate computation: P command**

- 1) No P command is specified in the block which contains the mnemonic codes specified below:

GRDX (Y), DGRDX (Y), SQRX (Y)

Note that P1 is not omissible.

- 2) The commanded P value is outside the range indicated below:

$1 < P < 65535$

[Code]

FFFFFFFF-> No P command

Others-> P command value (in hexadecimal)

[Probable Faulty Locations]

- 1) No P command
- 2) Improper P command value

Program Example:

GRDX X500. Y500. I20. J20. K2

P3

[Measures to Take]

- 1) Specify a P command in the block which contains a mnemonic instruction.
- 2) Correct the P command value.

[Related Specifications] Coordinate computation function

★ 2293 **Coordinate computation: Q command**

- 1) No Q command is specified in the block which contains the mnemonic code ARC.
- 2) Q command value is outside the range indicated below when a Q command is specified in the block containing mnemonic code DGRDX (Y).  $-99999999 < Q < 99999999$

[Code]

FFFFFFFF-> No Q command

Others-> Q command value (in hexadecimal)

[Probable Faulty Locations]

- 1) No Q command
- 2) Improper Q command value

Program Example:

ARC X300. Y300. V20.

Q30. K4

[Measures to Take]

- 1) Specify Q command in the block which contains a mnemonic instruction.
- 2) Check the Q command value and the unit system, and correct the Q command.

[Related Specifications] Coordinate computation function

★ 2294 **Coordinate computation: R command**

An R command value is outside the allowable range indicated below:

-99999999 < R < 99999999 [1/1000-deg, 1/10000-deg]

-99999.999 < R < 99999.999 [mm]

[Code] R command value (in hexadecimal)

[Probable Faulty Locations]

Improper R command value

Program Example:

DGRX X500. Y500. I20000 J20000 K3 P2 Q100

R999999.

(The data with a decimal point is handled in units of millimeters, thus causing an alarm.)

[Measures to Take]

- 1) Check the R command value and the unit system.
- 2) Correct the program.

[Related Specifications] Coordinate computation function

★ 2295 **Coordinate computation: maximum number over**

The number of coordinate points to be calculated using the coordinate computation function exceeds the allowable limit (1 - 65535).

- 1) The number of times specified by K is too large.
- 2) The total number of coordinate points obtained using the coordinate computation function is too large.

[Code] The maximum number of coordinate points calculated (in hexadecimal)

[Probable Faulty Locations]

The K command value is too large or the number of coordinate points to be calculated is too large.

Error in specifying Q and K commands

Program Example:

LAA X500. Y500 I20. K65560

BHC X500. Y500. Q5 K3000 ... J0

^^ ^^^^^Error in specifying Q and K commands

[Measures to Take]

- 1) Check the K command for the coordinate computation function.
- 2) Check the calculation method for the coordinate points.
- 3) Check the maximum number of coordinate points to be calculated.

[Related Specifications] Coordinate computation function

★ 2296 **Coordinate computation: G code**

G code not used for the coordinate computation function is specified.

[Probable Faulty Locations]

- 1) Defective main board
- 2) Problem with the control software (G code check table, mnemonic check table, G code data)

[Related Specifications] Coordinate computation function

★ 2297 **Coordinate computation: mode**

A coordinate computation function (LAA, ARC, GRDX, GRDY, DGRDX, DGRDY, SQRX, SQRY, BHC) is specified in the following modes:

- 1) Cutter radius compensation mode (G41, G42)
- 2) 3D tool offset mode (G44)
- 3) Circular interpolation mode (G02, G03)
- 4) Coordinate computation function
- 5) A rotary axis is selected in plane designation but the cylindrical side surface machining mode (G175) is not selected.

[Probable Faulty Locations]

Mode selected prior to the execution of the coordinate computation command

Program Example:

```
G02 X100 Y100 F2000
```

```
LAA I20 K3 J30 <- alarm occurs
```

[Measures to Take]

Check the mode selected prior to the execution of the coordinate computation command.

[Related Specifications] Coordinate computation function

★ 2298 **Cutter radius comp.: operation**

An error occurs during the floating-point calculation in the cutter radius compensation mode.

Data for variables used for the cutter radius compensation function are first calculated by converting the variables into floating-point numbers and the results of calculation are converted into integers.

[Code] XYYY

XX: Indicates the location where the variable, which caused the floating-point calculation error, is accessed.

YY: Indicates the calculation error status in the floating-point calculation.

Calculation Error Status (YY)

bit0-> FIMR overflow (overflow in converting into integers)

bit1-> Exponent underflow

bit2-> Exponent overflow

bit3-> Square root of a negative data

bit4-> Divisor = 0

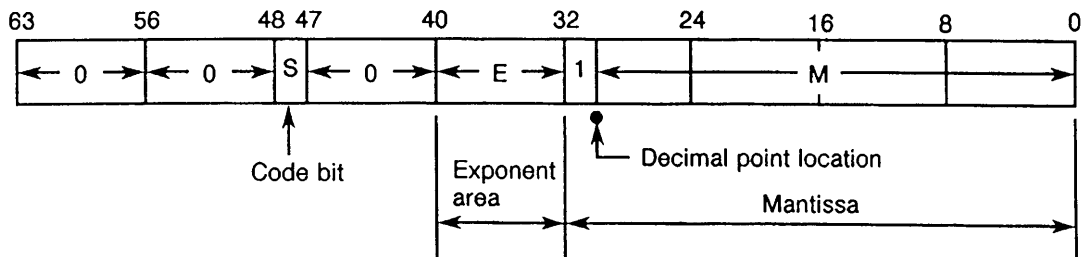
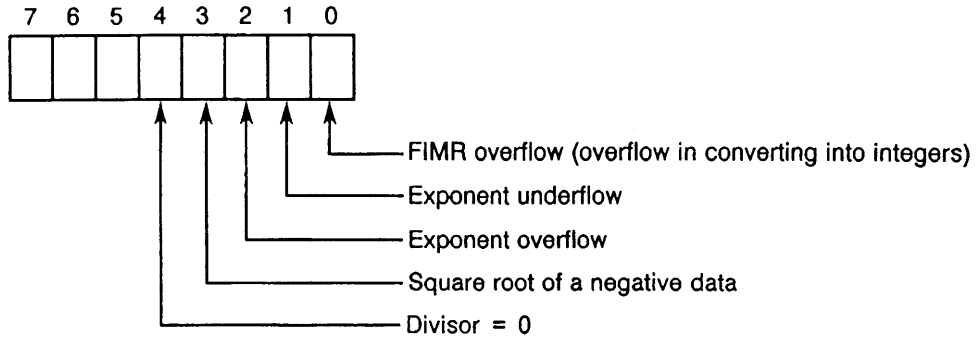

$$0 \leq E \leq 255$$

Value 128 is taken as the standard.  
E < 0 . . . . . Exponent underflow  
E > 256 . . . Exponent overflow

$$\underline{(-1)^S \cdot M \cdot 2^{(E-128)}}$$

XX:

- 1-> Computation error in calculating imaginary point based on the I and J commands at the start-up
- 7-> Computation error in converting into floatingzero point data to transfer the data from the command buffer (CDB or CDA) to cutter radius compensation buffer (TRB or TRA)
- 10-> Computation error in calculating the vertical vector which has the magnitude as the cutter radius compensation data (STRATOF) for the shape having the start or end point at the point in question

XX:

- 11-> Computation error in calculating for judgment of inside or outside cutting
- 12-> Computation error in calculating for judgment of obtuse angle or acute angle formed in the figure
- 13-> Computation error in calculating extend point
- 14-> Computation error in calculating equation of tangent
- 15-> Computation error in calculating arc factor
- 16-> Computation error in calculating automatic deceleration/acceleration for inside arc
- 17-> Computation error in calculating for judgment between minute arc and full circle
- 18-> Computation error in calculating for interference check
- 20-> Computation error in calculating to shift the corner offset data (floating-point) to the execution buffer (integer)
- 21-> Computation error in calculating I and J values of an arc from the active point data (HC, VC) and the center (AA, AB)
- 22-> Computation error in calculating line coefficient (AB, BB, CB)



- 23-> Computation error in calculating arc coefficient (AB, BB, CB)
- 24-> Computation error in calculating the arc radius for which cutter radius compensation is active
- 25-> Computation error in calculating the crosspoint between two circles
- 26-> Computation error in calculating the crosspoint between a line and a circle
- 27-> Computation error in calculating the crosspoint between two lines
- 28-> Computation error in calculating for judgment of the point to be taken in the case where two calculated cross-points exist
- 29-> Computation error in calculating the execution data when canceling the cutter radius compensation function
- 30-> Computation error in calculating the decelerated feedrate
- 31-> Computation error in calculating the deceleration start point on a plane
- 32-> Computation error in calculating for the comparison between the corner internal angle and the deceleration execution angle
- 33-> Computation error in calculating the deceleration end point on a plane
- 34-> Computation error in calculating to set the dividing point (floating-point) on a plane at the deceleration buffer (integer)
- XX:
- 35-> Computation error in calculating to set the dividing points (floating-point) on other than a plane at the deceleration buffer
- 36-> Computation error in calculating to check if the arc can be designated after the execution of the cutter radius compensation
- 37-> Computation error in calculating arc length after obtaining the central angle from the start and end points of an arc
- 38-> Computation error in calculating COS and SIN of the central angle after obtaining it from the arc length and the arc radius
- 39-> Computation error in calculating for arc coordinate rotation
- 40-> Computation error in calculating to set the division points for the end point on a plane other than the one currently selected to the deceleration buffer
- 41-> Computation error in calculating the distance between two points

[Probable Faulty Locations]

- 1) Defective main board
- 2) Problem with the control software

**★ 2299 Cutter radius comp.: no intersecting point**

In the cutter radius compensation function, a cross-point for the commands between two blocks cannot be obtained.

[Code]

- 200-> When making outside obtuse angle cut
- 300-> When making inside cut
- 400-> When making circular cut, or when compensation is made in the reverse direction

[Probable Faulty Locations]

Error in a program or cutter radius compensation data

[Measures to Take]

- 1) Check the program.
- 2) Set the correct cutter radius compensation data.

**★ 2300 Cutter radius comp.: cancel G00/G01**

The cutter radius compensation cancel G code (G40, G43) is programmed in the circular interpolation mode (G02, G03).

[Code] 500

[Probable Faulty Locations]

A block several blocks before the block containing the cutter radius compensation mode cancel command

Program Example:

```
G41 X100 D01 F1000  
G02 X200 I-100 J0  
G40 <- An alarm occurs
```

[Measures to Take]

Select the G00 or G01 mode before canceling the cutter radius compensation mode.

★ 2301 **Cutter radius comp.: startup impossible**

3-dimensional tool comp.: startup impossible

- 1) Start-up of the cutter radius compensation mode is impossible.

This alarm occurs when G41 or G42 calling the cutter radius compensation function is specified in the G02 or G03 mode.

- 2) Start-up of the 3D offset mode is impossible.

This alarm occurs when G43 calling the 3D offset function is specified in the G02 or G03 mode.

[Code]

600-> An attempt to start up the cutter radius compensation mode in the G02 or G03 mode

11-> An attempt to start up the 3D offset mode in the G02 or G03 mode

[Probable Faulty Locations]

G41, G42 or G43 command in the G02 or G03 mode.

Program Example:

```
G02 X_ Y_ I_ J_  
G42 X_ Y_ I_ J_  
G01 X_ Y_
```

[Measures to Take]

Specify G41, G42 or G43 command only in the G00 or G01 mode.

[Related Specifications] 3D tool offset function

★ 2302 **Cutter radius comp.: number**

A cutter radius compensation number is not specified.

[Code]

600-> In the 3D tool offset mode

800-> In the tool offset mode

[Probable Faulty Locations]

- 1) Defective main board
- 2) Problem with the control software

★ 2303 **Cutter radius comp.: amount command**

D command which changes the cutter radius compensation amount is specified during the circular interpolation mode or when the interpolation mode changes from the linear interpolation mode to the circular interpolation mode with the cutter radius compensation mode active.

[Code] 900

[Probable Faulty Locations]

The D command in the G02 mode

Program Example:

```
G01 G41 X100 Y100 D01 F200 D01=10 mm  
G02 X200 R100 D02 D02=20 mm
```

^^^

[Measures to Take]

Always specify a D command prior to the circular interpolation command. Never change it while the cutter radius compensation mode is active.

★ 2304 **Cutter radius comp.: interference**

An interference occurs between the cutting width, added to the cutter radius compensation data, and the area which should not be cut. (The angle between the programmed cutter movement direction and the direction of movement created after the compensation is between 90-deg and 270-deg.)

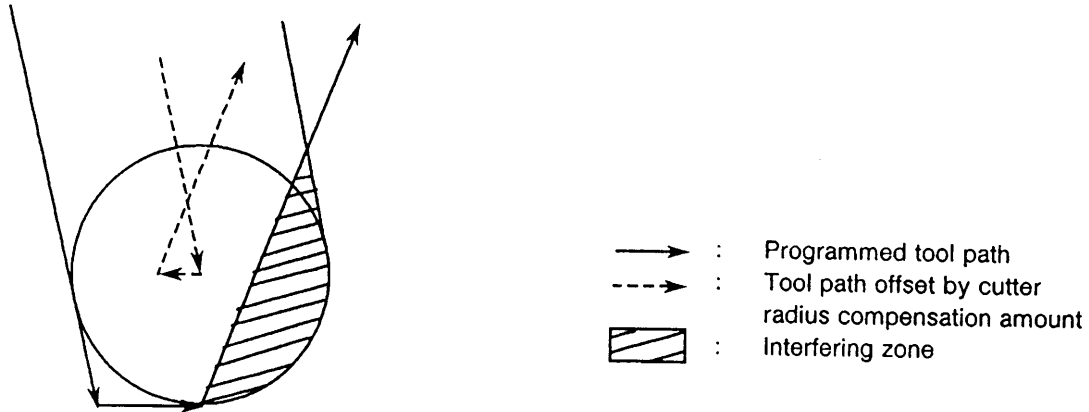

[Code] 1900

[Probable Faulty Locations]

- 1) Cutter radius compensation data D is too large.
- 2) Programmed command is improper (depth of cut too large).

Program Example:

Assume that "30" is set at D1.

```
G00 X0 Y0
G42 G01 X50 Y-50 F100
X25
X100 Y0
```

[Measures to Take]

- 1) Reduce the cutter radius compensation data so that an interference will not occur. (Change a cutting tool also.)
- 2) Change the command values. (Tool paths will also be changed.) Referential Document OSP7000M programming manual (cutter radius compensation)

★ 2305 **UNTENDED: gauging impossible**

The condition in which the gauging cycle cannot be executed occurs during the execution of an automatic gauging cycle. Or an attempt is made to execute an automatic gauging cycle in the condition where such an execution is not allowed.

[Code]

- 1-> Cause: A maker subprogram is called while the machine coordinate system (H0) is selected.  
Measures: Call a maker subprogram after selecting a work coordinate system (G15 H1, for example).  
Subprogram:OO10 OO30 OO50
- 2-> Cause: The mirror image function is active.  
Subprogram:OO10 OO30 OO50  
Measures: Cancel the mirror image function first.
- 3-> Cause: Manual shift amount (total) remains.  
Measures: Cancel the manual shift amount (total) to zero.  
Subprogram:OO10 OO30 OO50
- 4-> Cause: Parallel or rotation shift (G11) of the coordinate is being executed.

- Measures: Cancel the G11 mode first.  
Subprogram:OO10
- 5-> Cause: Shape enlargement/reduction (G51) is being executed.  
Measures: Cancel the G51 mode first.  
Subprogram:OO10
- 6-> Cause: T number is zero (0). No tool is set.  
Measures: Specify a tool number. Specify the PTLN command.  
Subprogram:OO30
- 7-> Cause: The number of T numbers or PTLN commands exceeds the allowable offset pair number.  
Measures: Reduce the number of T numbers or PTLN commands to the allowable value.  
Subprogram:OO30
- 8-> Cause: The power to the probe is not on when the flash on cycle is attempted.  
Measures: Check if there are obstacles between the receiver head and the probe.  
Is the spindle index angle for the probe correct?  
Does the receiver head flash?  
Subprogram:OO15
- 9-> Cause: The offset amount of the positioning point for cycle start from the touch sensor zero point is greater than PCHK (only for Y and Z axes).  
Measures: When positioning Y and Z axes, reduce offset amount from the touch sensor zero point to within PCHK.  
Subprogram:OO30
- A-> Cause: The touch probe microcomputer stays on.  
Measures: Check whether chips are accumulating on the proximity switch.  
Subprogram:OO10
- B-> Cause: The result of touch probe test is NG. The touch probe signal cannot be confirmed.  
Measures: Check the touch probe battery.  
Subprogram:OO10
- C-> Cause: The touch probe contacts the workpiece while it is being fed at a rapid approach speed (X-axis).  
Measures: Check the gauging cycle start point.  
Check the PUDT setting.  
Subprogram:OO10
- D-> Cause: The touch probe fails to contact the workpiece while it is being fed at a middle approach speed (X-axis).  
Measures: Check the assumed gauging cycle target point.  
Check the POVVT setting.  
Subprogram:OO10
- E-> Cause: The touch probe fails to contact the workpiece while it is being fed at the final approach speed (X-axis).  
Measures: Check the touch probe battery.  
Subprogram:OO10
- F-> Cause: The proximity switch is not turned on although the touch probe is brought into contact with a workpiece (X-axis).  
Measures: Check if the touch probe has chattered.  
Subprogram:OO10
- 10-> Cause: The touch probe contacts the workpiece while it is being fed at a rapid approach speed (Y-axis).  
Measures: Check the gauging cycle start point.  
Check the PUDT setting.  
Subprogram:OO10
- 11-> Cause: The touch probe fails to contact the workpiece while it is being fed at a middle approach speed (Y-axis).

- Measures: Check the assumed gauging cycle target point. Check the POVT setting.  
Subprogram:OO10
- 12-> Cause: The touch probe fails to contact the workpiece while it is being fed at the final approach speed (Y-axis).  
Measures: Check the touch probe battery.  
Subprogram:OO10
- 13-> Cause: The proximity switch is not turned on although the touch probe is brought into contact with a workpiece (Y-axis).  
Measures: Check if the touch probe has chattered.  
Subprogram:OO10
- 14-> Cause: The touch probe contacts the workpiece while it is being fed at a rapid approach speed (Z-axis).  
Measures: Check the gauging cycle start point.  
Check the PUDT setting.  
Subprogram:OO10
- 15-> Cause: The touch probe fails to contact the workpiece while it is being fed at a middle approach speed (Z-axis).  
Measures: Check the assumed gauging cycle target point.  
Check the POVT setting.  
Subprogram:OO10
- 16-> Cause: The touch probe fails to contact the workpiece while it is being fed at the final approach speed (Z-axis), or an FM type touch probe signal reception error has occurred.  
Measures: Check the touch probe battery.  
Subprogram:OO10
- 17-> Cause: The proximity switch is not turned on although the touch probe is brought into contact with a workpiece (Z-axis).  
Measures: Check if the touch probe has chattered.  
Subprogram:OO10
- 18-> Cause: The touch probe contacts the workpiece during the approach to the external diameter in the OD gauging cycle.  
Measures: Check the start point of the gauging cycle.  
Check the assumed OD value.  
Subprogram:OO10
- 19-> Cause: PLH is not designated.  
Measures: Set tool length offset number for PLH.
- 1A-> Cause: PDH is not designated  
Measures: Set cutter radius compensation number for PDH.
- 1B-> Cause: In the C-axis gauging cycle, contact is detected during the approach to the gauging point.  
Measures: Check whether the start position is correct, PDI value is correct, or PGI value is correct.  
Subprogram:OO10
- 1C-> Cause: Touch probe contact is not detected in X-axis direction motion within a range of PUDT and POVT. (Contact value error);  
Measures: NC software error (change to software of new version) or faulty SVP board (replace.).  
Subprogram:OO100
- 1D-> Cause: Touch probe contact is not detected in Y-axis direction motion within a range of PUDT and POVT. (VSAPY faulty)  
Measures: Change the NC software or SVP board.  
Subprogram:OO100
- 1E-> Cause: Touch probe contact is not detected in Z-axis direction motion within a range of PUDT and POVT. (VSAPZ faulty)  
Measures: Change the NC software or SVP board.

- Subprogram:OO100
- 1F-> Cause: In the touch sensor zero setting cycle for the vertical spindle longitudinal direction, the cutting tool fails to contact the sensor.  
Measures: Check the start position of the cycle; is it close to the touch sensor (within 10 mm)?  
Subprogram:OO30
- 20-> Cause: In the touch sensor zero setting cycle for the vertical spindle radial direction, the cutting tool fails to contact the sensor.  
Measures: Check the start position of the cycle; is it close to the touch sensor (within 10 mm)?  
Subprogram:OO30
- 21-> Cause: In the touch sensor zero setting cycle for horizontal spindle longitudinal direction, the cutting tool fails to contact the sensor.  
Measures: Check the start position of the cycles; is it close to the touch sensor (within 10 mm)?  
Subprogram:OO30
- 22-> Cause: In the automatic tool length offset and automatic tool breakage detection cycles for the horizontal spindle in the radial direction, the cutting tool fails to contact the sensor.  
Measures: Check the start position of the cycle; is it close to the touch sensor (within 10 mm)?  
Subprogram:OO30
- 23-> Cause: When the axis moves 0.5 mm in the positive direction from the contact detect point, the probe contact signal has been on. (X direction)  
Subprogram:OO100
- 24-> Cause: When the axis moves 0.5 mm in the positive direction from the contact detect point, the probe contact signal has been on. (Y direction)
- 25-> Cause: When the axis moves 0.5 mm in the positive direction from the contact detect point, the probe contact signal has been on. (Z direction)
- 26-> Cause: When the axis returns 0.5 mm from the contact position detected after approach (X direction), the value is taken as the coordinate value in the workpiece gauging direction again.
- 27-> Cause: When the axis returns 0.5 mm from the contact position detected after approach (Y direction), the value is taken as the coordinate value in the workpiece gauging direction again.
- 28-> Cause: When the axis returns 0.5 mm from the contact position detected after approach (Z direction), the value is taken as the coordinate value in the workpiece gauging direction again.
- 29-> Cause: In the automatic tool length offset and automatic tool breakage detection cycles for the vertical spindle in the longitudinal direction, the cutting tools fails to contact the sensor.  
Measures: Is the assumed tool length correct? (for tool length offset cycle)  
Subprogram:OO30
- 2A-> Cause: In the automatic tool length offset and automatic tool breakage detection cycles for the vertical spindle in the radial direction, the cutting tool fails to contact the sensor.  
Measures: Is the assumed cutter radius correct? (for tool length offset cycle)  
Is the cutter radius offset data set? (for tool breakage detection cycle)  
Subprogram:OO30
- 2B-> Cause: In the automatic tool length offset and automatic tool breakage detection cycles for the horizontal spindle in the longitudinal direction, the cutting tool fails to contact the sensor.  
Measures: Is the assumed tool length correct? (for tool length offset cycle)  
Is the tool length offset data set? (for tool breakage detection cycle)  
Subprogram:OO30
- 2C-> Cause: In the automatic tool length offset and automatic tool breakage detection cycles for the horizontal spindle in the radial direction, the cutting tool fails to contact the sensor.  
Measures: Is the assumed cutter radius correct? (for tool length offset cycle)  
Is the cutter radius offset data set? (for tool breakage detection cycle)  
Subprogram:OO30
- 2D-> Cause: In the automatic tool length offset cycle in the X-axis direction (with angular attachment), the cutting tool fails to contact the sensor.

- Measures: Check if PL1 is appropriate.  
Subprogram:OO30
- 33-> Cause: In the U-center zero setting cycle, cutting bit contacts the sensor or the contact signal is input in the sequence in which it should not contact the sensor.  
Measures: Check the following points:  
- Is the sensor zero setting done correctly?  
- Is the cutting bit free of chips?  
- Is the sensor signal correct?  
Subprogram:OO40
- 34-> Cause: In the U-center zero setting cycle, no contact signal is input.  
Measures: Is the PD value correct?  
Is the sensor signal correctly input to the NC?  
Subprogram:OO40
- 35-> Cause: In the U-center radius adjusting cycle, the cutting bit contacts the touch sensor while Y-axis is being fed in the sequence in which contact must not be detected.  
Measures: Check the following points:  
- Is the command value correct?  
- Is the sensor signal correctly input to the NC?  
- Is the cutting bit free of chips?  
Subprogram:OO50
- 36-> Cause: In the U-center radius adjusting cycle, the cutting bit fails to contact the touch sensor while U-axis is being fed.  
Measures: Check the following points:  
- Is the U-axis command too large?  
- Is the sensor signal correctly input to the NC?  
Subprogram:OO50
- 37-> Cause: In the U-center radius adjusting cycle, the cutting bit fails to contact the touch sensor in the sequence in which the U-axis adjusted amount is checked with the Y-axis.  
Measures: Check whether the sensor signal is correctly input.  
Subprogram:OO50
- 38-> Cause: In the tool breakage detection cycle, the cutting bit contacts the touch sensor while the Y-axis is being fed in the sequence in which it should not contact the touch sensor.  
Measures: Check the following points:  
- Is the sensor zero setting correct?  
- Is the sensor signal correctly input to the NC?  
- Is the cutting bit free of chips?  
Subprogram:OO60
- 39-> Cause: In the wear compensation cycle, the cutting bit contacts the touch sensor in the sequence in which the Y-axis positioning is executed at a point away from the current position by the compensation amount.  
Measures: Check the following points:  
- Is the command value correct?  
- Is the U-center bit free of chips?  
- Is the sensor signal correctly input to the NC?  
Subprogram:OO60
- 3A-> Cause: In the wear compensation cycle, the cutting bit fails to contact the touch sensor in the sequence the cutting bit radial position is compensated in the U-axis adjusting cycle.  
Measures: Check the following point:  
- Is the sensor signal correctly input to the NC?  
Subprogram:OO60

- 3B-> Cause: After the completion of U-axis compensation in the wear compensation cycle, the cutting bit fails to contact the touch sensor in the sequence in which the adjusted amount is checked with the Y-axis movement.  
Measures: Check the following point:  
- Is the sensor signal correctly input to the NC?  
Subprogram:OO60
- 3C-> Cause: When the gauging cycle is executed with a touch probe set in the vertical spindle of the MCM, swivel head orientation is not M75 position.  
Measures: On the MCM, tool change cycle for the vertical spindle is carried out at the M75 position; set the touch probe in the automatic or MDI mode.  
Subprogram:OO10
- 3D-> Cause: In the touch sensor zero setting cycle for the vertical spindle in the longitudinal direction on the MCM, the swivel head is not indexed at the front position, or the horizontal spindle is being used.  
Measures: Carry out the cycle after indexing the front position (M73) of the swivel head.  
Is the PAXI data correct?  
Subprogram:OO30
- 3E-> Cause: In the touch sensor zero setting cycle for the vertical spindle in the radial direction on the MCM, the swivel head is not indexed at the front position, or the horizontal spindle is being used.  
Measures: Carry out the cycle after indexing the front position (M73) of the swivel head.  
Is the PAXI data correct?  
Subprogram:OO30
- 3F-> Cause: In the touch sensor zero setting cycle for the horizontal spindle in the longitudinal direction on the MCM, swivel head is not indexed at the right position, or the vertical spindle is being used.  
Measures: Carry out the cycle after indexing the right position (M76) of the swivel head.  
Is the PAXI data correct?  
Subprogram:OO30
- 40-> Cause: In the touch sensor zero setting cycle for the horizontal spindle on the MCM, swivel head is not indexed at the right position, or the right tool is being used.  
Measures: Carry out the cycle after indexing the right position (M76) of the swivel head.  
Is the PAXI data correct?  
Subprogram:OO30
- 41-> Cause: The tool number for the angular attachment is T52 or T53. For the angular attachment tool, only T51 (90-deg angular attachment) can be used for tool length offset.  
Measures: Check if the T command is correct.
- 42-> Cause: The power supply for the optical type touch probe cannot be turned on.  
Subprogram:OO16
- 43-> Cause: The power supply for the optical type touch probe cannot be turned off.  
Subprogram:OO17
- 4E-> Cause: When the FM type touch probe was being fed at a rapid approach speed (X-axis), a signal reception error occurred.  
Subprogram:OO10
- 4F-> Cause: When the FM type touch probe was being fed at a middle approach speed (X-axis), a signal reception error occurred.  
Subprogram:OO10
- 50-> Cause: When the FM type touch probe was being fed at a final approach speed (X-axis), a signal reception error occurred.  
Subprogram:OO10
- 51-> Cause: When the FM type touch probe was being fed at a rapid approach speed (Y-axis), a signal reception error occurred.  
Subprogram:OO10



- 52-> Cause: When the FM type touch probe was being fed at a middle approach speed (Y-axis), a signal reception error occurred.  
Subprogram:OO10
- 53-> Cause: When the FM type touch probe was being fed at a final approach speed (Y-axis), a signal reception error occurred.  
Subprogram:OO10
- 54-> Cause: When the FM type touch probe was being fed at a rapid approach speed (Z-axis), a signal reception error occurred.  
Subprogram:OO10
- 55-> Cause: When the FM type touch probe was being fed at a middle approach speed (Z-axis), a signal reception error occurred.  
Subprogram:OO10
- 56-> Cause: When the FM type touch probe was being fed at a final approach speed (Z-axis), a signal reception error occurred.  
Subprogram:OO10  
[Related Specifications]  
Untended specifications
- 58-> Cause: PLI is smaller than VMTL or [PLI-POVT] is smaller than [VMTL-10]. (10 is a default overtravel distance.)  
PLI: expected tool length; VMTL: data set at optional parameter long word No. 43; POVT: overtravel distance  
This code is used only for MMSA001C-JPN.MSB.  
Sub program: 0030  
[Related Specifications]  
Interference preventive measure for auto tool length offset/tool breakage detection sensor
- 59-> Cause: VTOFH[PH] is smaller than VMTL or [VTOFH[PH]-POVT] is smaller than [VMTL-10] (10 is a default overtravel distance.)  
PH: active tool number; VMTL: data set at optional parameter long word No. 43; POVT: overtravel distance  
This code is used only for MMSA001C-JPN.MSB.  
Sub program: 0030  
[Related Specifications]  
Interference preventive measure for auto tool length offset/tool breakage detection sensor
- 101-> Cause: The maker sub program is called in the machine coordinate system (H0).  
Measure: Select the work coordinate system (by specifying G15H1 for example) before calling the sub program.  
Sub program name 0071
- 102-> Cause:mirror image.  
Measure:which is is turned off mirror image, and carried out.  
Sub program name: OO71
- 103-> Cause:manually operated interruption shift quantity (sum total) has been left.  
Measure:manually operated interruption shift quantity (sum total) is cleared, and carried out.  
Sub program name: OO71
- 104-> Cause:Z directional touch sensor origin establishment cycle which did not touch a sensor in the 1st approach  
Measure:there is a position of start which did not touch a sensor neighborhood (10mm within) of a touch sensor confirms.  
Sub program name: OO71
- 105-> Cause:Z directional touch sensor origin establishment cycle which did not touch a sensor in the 2nd approach of cause.  
sub program name: OO71

- 106-> Cause:X directional touch sensor origin establishment cyclewhich did not touch a sensor in the 1st approach of cause.  
Measure:there is a position of start which did not touch a sensor neighborhood (10mm within) of a touch sensor confirms.  
Sub program name: OO71
- 107-> A sensor was not touched in the 2nd approach of cause: X directional touch sensor origin establishment cycle  
Sub program name: OO71
- 108-> A sensor was not touched in the 1st approach of cause: Y directional touch sensor origin establishment cycle.  
Measure:there is a position of start neighborhood (10mm within) of a touch sensor confirms.  
Sub program name: OO71
- 109-> Which did not touch a sensor in the 2nd approach of cause: Y directional touch sensor origin establishment cycle.  
Sub program name: OO71
- 110-> A sensor was not touched in the 1st approach of cause: Z directional automatic tool length offset cycle.  
Measure: whether expected tool length PLI of value of POVT whose a position of start is righconfirmed is right adequate confirms.  
Sub program name: OO71
- 111-> Which did not touch a sensor in the 2nd approach of cause: Z directional automatic fset cycle.  
Sub program name: OO71
- 112-> A sensor was not touched in the 1st approach of cause: X directional automatic toolet cycle.  
Whether radius PDL of value of POVT whose a position of countermeasure: start is right of expected tool which or is confirmed is right adequate confirms.  
Sub program name: OO71
- 113-> Which did not touch a sensor in the 2nd approach of cause: X directional automatic offset cycle.  
Sub program name: OO71
- 114-> A sensor was not touched in the 1st approach of cause: Y directional automatic toolet cycle.  
Measure: whether radius PDL of value of POVT whose a position of countermeasure: start is rid tool which or is confirmed is right adequate confirms.  
Sub program name: OO71
- 115-> Which did not touch a sensor in the 2nd approach of cause: Y directional automatic tool diameter offset cycle.  
Sub program name: OO71

[Related Specifications]

Portable touch sensor automatic tool length offset/automatic tool fold unprofitable detection.

★ 2306 **UNTENDED: hole dia. error over**

In the ID and OD automatic gauging cycle, the difference between the assumed diameter and the results of the gauging cycle exceeds the allowable limit.

An alarm occurs if;

$|\text{assumed diameter} - \text{measured diameter}| > \text{allowable limit}$

[Code] 2

[Probable Faulty Locations]

- 1) Faulty cutting
- 2) Assumed diameter and tolerance (allowable limit)

Program Example:

CALL OO10 PMOD=7 PDI=100 PEE=0.01 ; ID gauging cycle

★ 2307 **UNTENDED: off centerline**

In the ID/OD gauging cycle and X/Y/Z end face gauging cycle, the difference between the assumed value and the results of the gauging cycle exceeds the allowable limit.

An alarm occurs if;

$$|\text{assumed value} - \text{measured value}| > \text{allowable limit}$$

[Code] 3

[Probable Faulty Locations]

- 1) Faulty cutting
- 2) Assumed diameter and tolerance (allowable limit)

Program Example:

CALL OO10 PMOD=1 PEI=0 PEE=0.01

★ 2308 **INTENDED: command missing**

In the automation subprograms (MSB), variables to be assigned are not assigned, or the contents of variables assigned are not correct.

- 1) CALL OO10

Variables to be Assigned[Setting Data]

PMOD ; Automatic measurement mode[1, 2, 3, 6, 7, 8, 9, 14, 15]

PDI ; Assumed diameter (ID, OD gauging, touch probe radius compensation)

PEI ; Assumed end face position (X/Y/Z end face position, touch probe length offset)

- 2) CALL OO20

PHN ; The number of work coordinate system for which zero set is carried out

[1 - (the number of work coordinate systems)]

[Code] 4

[Probable Faulty Locations]

- 1) During the execution of automatic gauging cycle (CALL OO10)
- 2) During the execution of automatic zero offset (CALL OO20)

Program Example:

CALL OO10

M2

An alarm occurs because PMOD is not specified.

[Measures to Take] Correct the program.

★ 2309 **UNTENDED: tool breakage**

This alarm occurs during the execution of the automatic tool breakage detection cycle (MSB) if any of the following are detected:

- a) The cutting tool fails to contact the touch sensor.
- b) The difference between the tool offset value and the measured value exceeds the allowable limit.

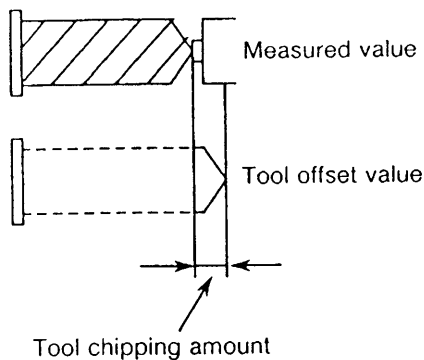

The tool broken alarm occurs if:

Broken judgment value

< Tool chipping amount (default: 0.1 mm)

[Code] 5

[Probable Faulty Locations]

- 1) The cutting tool has been broken.
- 2) The tool offset data is not set.
- 3) The tool breakage judgment value (PLE1) is not correct.

Program Example:

CALL OO30 VFST=0

[Measures to Take]

- 1) Select a spare tool or replace with a new tool to allow the cutting cycle to be continued.
- 2) Set the tool offset data in the automatic tool offset cycle.

★ 2310 **UNTENDED: zero offset impossible**

In the execution of the zero offset cycle (OO20), there is no data for zero offset. When an automatic gauging cycle has been executed prior to the call of subprogram OO20, results of the gauging cycle should have been set at VC913, VC914 and VC915.

If data at VC913, VC914 and VC915 are zero or EMPTY, the control judges that an automatic gauging cycle has not been conducted and generates an alarm.

Since contents at VC913, VC914 and VC915 are cleared by the control reset operation, an alarm occurs even when CALL OO20 is executed after resetting the control.

[Code] 6

[Probable Faulty Locations]

- 1) An attempt is made to offset the zero point on an axis other than the one on which the gauging cycle has been carried out.
- 2) Automatic gauging cycle (CALL OO10) has not been conducted before CALL OO20 command execution.
- 3) After the execution of an automatic gauging cycle, the control is reset, and operation is resumed from the CALL OO20 command using the sequence restart function.

Program Example:

CALL OO10 PMOD=1 PEI=0 ; X end face gauging cycle  
CALL OO20 PY=0 ; Y-axis zero offset  
(An alarm occurs in this case.)

[Measures to Take]

If a part program is wrong, correct the program and begin the cycle from the automatic gauging cycle (CALL OO10).

★ 2311 **UNTENDED: no subprogram function**

- 1) The CALL OO10 command is executed although the control has no automatic gauging specification.
- 2) The CALL OO20 command is executed although the control has no automatic zero offset specification.
- 3) The CALL OO30 (automatic cutter radius compensation cycle) command is executed although the control has no automatic cutter radius compensation function.
- 4) The CALL OO30 (automatic tool breakage detection cycle) is executed although the control has no automatic tool breakage detection specification.

[Code]7

[Probable Faulty Locations]

- 1) Setting error of VFST
- 2) Subprogram number setting

Program Example:

CALL OO30 VFST=0

An alarm occurs if an automatic tool breakage detection cycle is called out while the control is not provided with the automatic tool breakage detection specification.

★ 2312 **UNTENDED: center distance error over**

In the automatic gauging subprogram (MSB), differences between the assumed values and the calculation results of the two center points and the distance between them exceed the allowable limit.

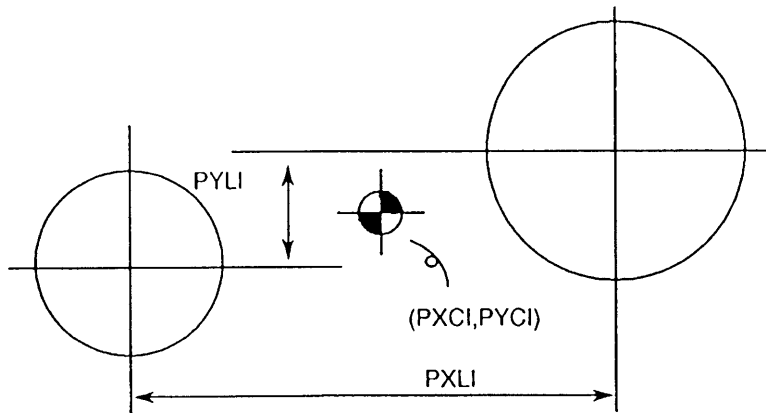

An alarm occurs if;

$$| P^*CI - P^*CM | > P^*CE$$

$$| P^*LI - P^*LM | > P^*LE$$

\*: X, Y, Z

P\*LI : Assumed distance

P\*LM : Calculated distance

P\*LE : Allowable error limit  
for distance

P\*CI : Assumed values for  
center positions

P\*CM : Calculated values for  
center positions

P\*CE : Allowable error limit  
for center positions

[Code] 8

[Probable Faulty Locations]

- 1) Faulty cutting
- 2) Assumed diameter and tolerance (allowable limit)

Program Example:

CALL OO10 PMOD=14 PXCE=0.01 P\*LI=0.01

★ 2313 **Area machining: no cycle axis command**

In the area machining commands, the cycle axis is not specified, or an axis parallel to the cycle axis is specified with the cycle axis.

Example:

- 1) On the XY plane, the Z-axis or W-axis (NC axis) is not specified.
- 2) On the XY plane, both the Z-axis and W-axis (NC axis) are specified.

[Probable Faulty Locations]

Cycle axis command for area machining

Program Example:

- 1) FMILR X100. Y100. I100. J200. Q50. R0. D10. F200
- 2) FMILF X100. Y100. Z-100. I500. J300. Q60. R-50. W100.  
D10. F200

[Measures to Take]

Program Example

- 1) Specify the Z-axis (cycle axis).
- 2) Delete either the Z- or W-axis.

★ 2314 **Area machining: tool dia. = 0**

The following commands are given in the area machining commands.

- 1) Offset value of the D number specified is zero (0).
- 2) When the offset value of the D number specified is doubled and then multiplied by P (cutting width ratio), the calculation result is smaller than 0.001[mm].

Cutter radius compensation data  $2 * P/100 < 1$

This alarm does not occur when a Q command is given in the round mill mode.

- 3) The calculation result for the infeed amount is zero (0).

[Code]

- 1-> Contents of D command is zero (0).
- 2-> Problem as stated in 2) above
- 3-> Problem as stated in 3) above

[Probable Faulty Locations]

- 1) Wrong P command
- 2) Setting error of cutter radius compensation data

[Measures to Take]

- 1) Check the specified D number.
- 2) Check whether the offset values are set.
- 3) Check whether P value is correct.

★ 2315 **Area machining: area command**

Machining area which cannot be specified is specified.

- 1) The result of addition of an I or J command value to the start point does not fall within the range below when converted into microns.  
 $-99999999 < I \text{ (or } J) < +99999999$
- 2) When a Q command is omitted in the RMILI, the following inequality is satisfied:  
 $(\text{cutter radius compensation value} + K + 5\text{mm})^2 \Rightarrow \text{shorter side length}$
- 3) In the PMIL and PMILR, the following inequalities are satisfied:  
 PMIL  
 $\text{Shorter side length} - (1\text{mm} + \text{finish allowance} + \text{cutter radius})^2 > 5\text{mm}$   
 PMILR  
 $\text{Shorter side length} - (\text{finish allowance} + \text{cutter radius})^2 > 5\text{mm}$
- 4) When a Q command is specified in the RMILI, the following inequality is satisfied:  
 $(\text{cutter radius compensation value} + Q + 5\text{mm})^2 \Rightarrow \text{shorter side length}$

[Code]

In the case of 1) above:

Result of calculation (in hexadecimal)

In the case of 3) above:

$(1 \text{ mm} + \text{finish allowance} + \text{cutter radius}) * 2 \text{ or}$

$(\text{finish allowance} + \text{cutter radius}) * 2 \text{ (in hexadecimal)}$

In the case of 4) above:

$(\text{cutter radius compensation value} + Q + 5\text{mm})^2 \text{ (in hexadecimal)}$

[Probable Faulty Locations]

Area machining commands

Program Example:

G00 X0 Y0 Z100 D1=20 mm

RMILI X100 Y50 Z10 I100 J50 K5 R20 F400 D1  
^^ ^^

Cutter radius data or K value (finish allowance) is too large.

[Measures to Take] Correct the program.

★ 2316 **Area machining: no R command**

R level is not specified in the area machining commands.

[Probable Faulty Locations]

R command in the area machining mode

Program Example:

G0 X0 Y0 Z100

PMIL X100 Y50 Z10 I100 J50 K5 Q10 F400 D1  
No R command

[Measures to Take] Specify an R command.

★ 2317 **Area machining: R level & finish surface**

Commands which designate the R point level and finish surface level (cycle-axis command) at the same level are specified.

[Code] 1

[Probable Faulty Locations]

R command or finish surface level command in area machining commands

Program Example:

G0 X0 Y0 Z100

PMIL X100 Y50 Z10 I100 J50 K5 Q10 R10 F400 D1  
:                   <sup>^^^</sup>   <sup>^^^</sup> Specify different levels.

[Measures to Take] Correct the R command and the cycle-axis command.

★ 2318 **Area machining: circular interpolation mode**

Area machining commands are specified while the circular interpolation mode is effective.

[Probable Faulty Locations]

Circular interpolation cancel command is not specified in a block prior to the area machining command block.

Program Example:

G0 X0 Y0 Z100

G2 X10 Y10 R20 F400  
<sup>^^</sup>

PMIL X100 Y50 Z10 I100 J50 K5 Q10 R20 D1

Cancel the G02 mode.

[Measures to Take]

Select either the G00 or G01 mode before calling the area machining modes.

★ 2319 **Area machining: large finish allowance**

- 1) In the area machining round mill commands, stock amount (Q) is equal to or less than finish allowance (K).  
 $Q \leq K$
- 2) Finish allowance (K) is equal to or greater than the distance between the R point level and the finish surface.  
 $|R \text{ point level} - \text{finish allowance}^*| \leq \text{finish allowance}$   
\* cycle-axis command

[Code] Finish allowance (K) (in hexadecimal)

[Probable Faulty Locations]

K, Q, R or cycle-axis command

Program Example:

G0 X0 Y0 Z100

PMIL X100 Y50 Z10 I100 J50 <sup>^^^</sup> K10 <sup>^^^</sup> Q10 R20 F400 D1

Q should be greater than K. ( $Q > K$ )

[Measures to Take] Correct the K, Q, R and/or cycle-axis command.

★ 2320 **B method: buffer over**

This alarm occurs if the size of the character-string at the assigning variable setting area is more than 2047 when variables are assigned at the stage of subprogram call in the operation method B.

[Code]1

[Probable Faulty Locations]

Length of character-string at the assigning variable area

Program Example:

```
CALL O*** LA01=100 LA99=900
          ^^^^^^^^ ^^^^^^^^ More than 2047
```

[Measures to Take]

Check the character-string length at the variable assigning area.

**★ 2321 Data Word: 'AG'**

When an angle command (AG) is specified, both of the axes on a plane are designated or neither of them is designated.

[Index]None

[Character-string]None

[Code]

- 1-> Both the vertical and horizontal axes are designated, or neither of them is designated.
- 2-> Computation error during the execution of an angle command.
- 3-> The angle command (AG) is specified during the turning cut cycle.

[Probable Faulty Locations]

Axis command (both axes are specified, or neither are specified)

Program Example:

```
G0 X0 Y0
G0 X200 Y200 AG=45
```

An alarm occurs since both of the axes are designated.

[Measures to Take]

With an angle (AG) command, specify one of the two axes on a plane.

**★ 2322 3-dimension tool comp.: axis command**

At the start-up of 3D offset, the wrong axis command is specified.

[Code]

- 200-> The first axis and its parallel axis are specified simultaneously during 3D offset mode.
- 300-> The second axis and its parallel axis are specified simultaneously during 3D offset mode.
- 400-> The third axis and its parallel axis are specified simultaneously during 3D offset mode.

[Probable Faulty Locations]

Axis commands at 3D offset start-up block

Program Example:

```
G44 X100 Y100 Z0 U200 I1 J1 K1 D10 F100
    ^^^^          ^^^^ Parallel axes specified in the same block
```

[Measures to Take] Check the program.

**★ 2323 Area machining: 'F'**

As a feedrate command for the area machining operation, value F is zero (0) with FB omitted.

[Code]

- 4-> Value FB cannot be calculated from value F. (FB default is 25% of value F)

[Probable Faulty Locations]

F command

Program Example:



---

PMIL X10 Y10 Z10 I100 J100 K1 Q5 R20 F0 D1 WRITE  
^^

An alarm occurs since value F is zero (0).

[Measures to Take]

Specify a value other than zero (0) for F, or specify a value for FB.

**★ 2324 Area machining: 'D'**

In the area machining commands, a D command is omitted, or a D number not usable when the specification selected is specified.

[Code]

1-> No D command

2-> D command outside the specification

Number of Tools[Programmable Range]

100[1 - 100]

200[1 - 200]

300[1 - 300]

[Probable Faulty Locations]

D command in the area machining mode

Program Example:

PMIL X10 Y10 Z10 I100 J100 K1 Q5 R20 F400 WRITE

An alarm occurs because no D command is specified.

[Measures to Take] Correct the D command value.

**★ 2325 Area machining: 'I'**

In the area machining commands, no I command is specified or the specified value is zero (0).

[Probable Faulty Locations]

I command in the area machining mode

Program Example:

G0 X0 Y0 Z100

PMIL X100 Y50 Z10 J50 K5 Q10 R20 F400 D1

:

An alarm occurs because no I command is specified.

[Measures to Take] Correct the I command value.

**★ 2326 Area machining: 'J'**

In the area machining commands, no J command is specified or the specified value is zero (0).

[Probable Faulty Locations]

J command in the area machining mode

Program Example:

G0 X0 Y0 Z100

PMIL X100 Y50 Z10 I100 K5 Q10 R20 F400 D1

An alarm occurs because no J command is specified.

[Measures to Take] Correct the J command value.

**★ 2327 Area machining: 'K'**

Wrong K command (finish allowance) is specified: a negative value or a value which exceeds 99999999 after converted into micron unit value.

[Code] Command value in hexadecimal

[Probable Faulty Locations]

K command in the area machining mode

Program Example:

G0 X0 Y0 Z100

PMIL X100 Y50 Z10 I100 J50 K-5 Q10 R20 F400 D1  
                                  ^^^

K command must be a value within the range of 0 and 99999.999.

[Measures to Take] Correct the K command value.

★ 2328    **Area machining: 'P'**

For a P command value in the area machining mode, a value outside 1 to 100 is specified.

[Code] Command value in hexadecimal

[Probable Faulty Locations]

P command in the area machining mode

Program Example:

G0 X0 Y0 Z100

PMIL X100 Y50 Z10 I100 J50 K5 Q10 P200 R20 F400 D1  
  ^^^^

P command must be a value within the range of 1 to 100.

[Measures to Take] P command must be a value within the range of 1 to 100.

★ 2329    **Area machining: 'Q'**

Wrong Q command (depth of cut) is specified: a negative value or a value which exceeds 99999999 after converted into micro unit value.

[Code] Command value in hexadecimal

[Probable Faulty Locations]

Q command in the area machining mode

Program Example:

G0 X0 Y0 Z100

PMIL X100 Y50 I100 J50 Z10 K5 Q-5 R20 F400 D1  
  ^^^

Q command must be a value within a range of 0 and 99999.999.

[Measures to Take] Correct the Q command value.

★ 2330    **Area machining: 'R'**

In the area machining mode, an R command value outside the range of -99999999 to +99999999 is specified.

[Code] Command value in hexadecimal

[Probable Faulty Locations]

R command in the area machining mode

Program Example:

G0 X0 Y0 Z100

PMIL X100 Y50 I100 J50 Z10 K5 Q10 R99999.999  
  ^^^^^^^^^^^

F400 D01

:

[Measures to Take] Correct the R command value.

★ 2331 **Area machining: plane command**

Area machining commands are given on a plane other than G17 (XY plane) although the cycle-axis for fixed cycles (including area machining) is fixed at Z-axis by the setting at NC optional parameter (bit) No. 17 bit 0.

[Probable Faulty Locations]

- 1) Designation of plane for area machining execution
- 2) Setting error at NC optional parameter (bit) No. 17 bit 0

Program Example:

G18 X0 Y0 Z100

PMIL X100 Y50 I100 J50 Z10 K5 Q10 R20 F400 D1

NC optional parameter (bit) No. 17 bit 0 = 1

[Measures to Take]

Select the G17 (XY) plane, or set "0" at NC optional parameter (bit) No. 17 bit 0.

★ 2332 **Area machining: mode**

Area machining mode is called during the fixed cycle, cutter radius compensation, or 3D offset mode.

[Code]

- 1-> During fixed cycle mode
- 2-> During cutter radius compensation mode
- 3-> During 3D offset mode

[Probable Faulty Locations]

The above mode is not canceled before calling the area machining mode.

Program Example:

G0 X0 Y0 Z100

G41 X50

^^^

PMIL X100 Y50 Z10 I100 J50 K5 Q10 R20 F400 D01

[Measures to Take]

Cancel the mode indicated above before calling the area machining mode.

★ 2333 **Data word: indexing axis command**

An index table command is specified with other linear axis in the G01 mode.

[Code] 6

[Probable Faulty Locations]

Program error

Program Example:

G01 X100 B100 F1000

[Measures to Take] Correct the program.

★ 2334 **No tool command**

- (1) For the ATC, M06 (vertical tool change), M77 (horizontal tool change) or M177 (angular attachment change) is specified while a T command (tool number command) has not been specified.
- (2) For the floor type, table type or column type AAC, M170 (AAC attachment change for floor type) or M171 (AAC attachment change for table type) or M173 (AAC attachment change for column type) is specified while a T command (attachment number command) has not been specified.

[Measures to Take] Check the program.

★ 2335 **Program bad direct: T code**

A T number greater than the allowable maximum tool number is specified.

Maximum tool number = ATC tool number + AAC attachment number (0 for the specification not supported);

[Measures to Take]

- 1) Check the program.
- 2) Make sure that the machine specification and the T command match each other.

★ 2336 **Wrong T command**

T command designation is wrong.

[Code]

- 1-> The T number specified is the same as the active tool number.
- 2-> T code is specified two times.
- 3-> T code is specified at other than ATC start position.
- 4-> T00 is specified during the execution of an ATC cycle.
- 5-> T00 is specified at other than the ATC start position.
- 10-> ATC memory random  
Pot command is designated while the next tool is present.
- 11-> ATC memory random  
A command value greater than the maximum number of pots is designated.
- 12-> ATC memory random  
The pot to which a large tool cannot be returned is designated.
- 13-> The tool number specified as the T code is registered at more than one location in the pot/tool number correspondence table.
- 14-> The tool number specified as the T code is not registered in the pot/tool number correspondence table.
- 15-> ATC memory random  
A large tool cannot be returned to the pot by designating M06.
- 16-> ATC memory random  
Actual tool is already in the magazine.
- 17-> ATC memory random  
A tool is present in the indexed pot.
- 18-> Simple 5-face AT(=simplicity 5 surface attachment automatic format AAC (floor type):  
The tool/attachment table includes unregistered attachment tool No.
- 19-> Simple 5-face AT(=simplicity 5 surface attachment automatic format AAC (floor type):  
The tool/attachment table includes unregistered attachment data
- 20-> Simple 5-face AT(=simplicity 5 surface attachment automatic format AAC (floor type):  
The specified attachment data has not been registered.
- 21-> A T command identical to the active AAC AT number is specified.
- 22-> A T command of the AAC is specified two times. (A T command is specified when the AAC next process is other than 0.)
- 23-> A T command is specified at other than the AAC start position (AAC operation sequence number "1").  
AAC (table type):
- 31-> A T command identical to the active AAC AT number is specified.
- 32-> A T command of the AAC is specified two times. (A T command is specified when the AAC next process is other than 0.)
- 33-> A T command is specified at other than the AAC start position (AAC operation sequence number "1").  
AAC (column type):
- 41-> A T command identical to the active AAC AT number is specified.
- 42-> A T command of the AAC is specified two times. (A T command is specified when the AAC next process is other than 0.)

- 43-> A T command is specified at other than the AAC start position (AAC operation sequence number "1").
- FFFFFFF-> The magazine has no tool that has the specified tool group number.
- 51-> A tool number of TN orders is already registered with pot-tool correspondence table.
- 60-> The next tool command was specified when a heavy tool was set in the spindle. Or, a heavy tool is specified as the next tool when an active tool exists in the spindle (MCP-B).

[Measures to Take] Check the program referring to the code number indicated.

**★ 2337 ATC M command**

ATC M command specification is wrong.

[Code]

- 1-> M63 is specified after the T code has been specified.
- 2-> M63 is specified while the active tool is the adaptor.
- 3-> M63 is specified at other than the ATC start point.
- 4-> M64 is specified while the next tool is not present.
- 5-> M65 is specified during the ATC cycle.
- 6-> M65 is specified at other than the ATC start position.
- 7-> M66 is specified after the T code has been specified.
- 8-> M66 is specified after the T code has been specified.
- 9-> M66 is specified at other than the AT start position.
- 10-> M66 is specified while the active tool is the adaptor.
- 11-> M66 is specified while the active tool is not present.
- 12-> M67 is specified while the next tool is not present.
- 13-> M67 is specified while the next tool is not present.
- 14-> After continuous tool change cycle for different tools, M06 is specified while a horizontal spindle tool is not set.
- 15-> M06 is specified while the horizontal spindle holds a tool.  
With the memory-random ATC specification machine, M63 is designated while an empty toolpot is not present.
- 16-> After continuous tool change cycle for different tools, M77 is specified while a vertical spindle tool is not set.
- 17-> M77 is specified while the vertical spindle holds a tools.
- 18-> M166 is specified after the T code has been specified.
- 19-> M166 is specified at other than the ATC start point.
- 20-> M166 is specified while the active tool is not present.
- 21-> M66 is specified when the adaptor is not mounted.
- 22-> M67 is specified when the adaptor is not mounted.
- 23-> M177 is specified while an attachment is not set.
- 24-> M06 is specified while the U-axis is jointed.
- 25-> M06, M63 or M64 is specified while the tool change arm is not at the standby position.
- 26-> Concerning tool switching pattern of "normal-tool normal tool" exception of simplicity 5 surface attachment specifications, it instructed M64.
- 27-> M77, M66, M67 or M166 was specified though the machine was not equipped with the swivel head.
- 28-> M77 was specified when the large-diameter tool code is set in the next tool data. Or, M 6 was specified though the large-diameter tool code is set in the active tool for the horizontal spindle.

[Measures to Take] Check the program referring to the code number indicated.

★ 2338 **APC M command**

APC M command specification is wrong.

[Code]

- 1-> M60 is specified at other than ATC start position.
- 2-> The pallet number of the pallet currently on the table is specified.
- 3-> A number greater than the maximum pallet number is specified.
- 4-> A carrier number not registered is specified.
- 5-> M60 is specified while the circular table is in connection.

[Measures to Take]

Check the program referring to the code number indicated.

★ 2339 **Axis lube motor overload**

The overload relay for the axis lubrication motor is tripped.

- (1) MC-30VA  
The overload relay (OL3) for the X/Y/Z-axis slideway lubrication motor is tripped.
- (2) MC-40VA/50VA/60VA  
The overload relay (FR-3) for the X/Y/Z-axis slideway lubrication motor is tripped.
- (3) MC-400H  
The overload relay (FR-3) for the X/Y/Z-axis slideway lubrication motor is tripped.
- (4) MC-500H/600H/800H  
The overload relay (OL3) for the X/Y/Z-axis slideway lubrication motor is tripped.
- (5) MDB-A/B, MCV-A/B, MCR, MCM
  - a) The overload relay (OL3, 11) for the X/Y/Z-axis slideway lubrication motor is tripped.
  - b) The overload relay (OL10) for the crossrail slideway lubrication motor is tripped.
- (6) MCR-B
  - a) The overload relay (OL13) for the X/Y/Z-axis slideway lubrication motor is tripped.
  - b) The overload relay (OL10) for the crossrail slideway lubrication motor is tripped.
- (7) S-20  
The overload relay for the X/Y/Z-axis slideway lubrication motor is tripped.  
An alarm occurs when the signal LUBM is turned off.

[Character-string]

None->X-, Y-, Z-axis  
W-> Crossrail

[Probable Faulty Locations] Defective lubrication motor

[Measures to Take] Reset the tripped overload relay.

★ 2340 **Axis lube pressure ON confirmation**

The pressure switch is not turned on within a predetermined period (motor ON time \* 2) after the lubrication pump motor is turned on.

- (1) MC-30VA  
X/Y/Z-axis slideway lubricating oil pressure switch
- (2) MC-40VA/50VA/60VA  
X/Y/Z-axis slideway lubricating oil pressure switch
- (3) MC-400H  
X/Y/Z-axis slideway lubricating oil pressure switch
- (4) MC-500H/600H/800H

- X/Y/Z-axis slideway lubricating oil pressure switch
- (5) MDB-A/B, MCV-A/B, MCR, MCM
    - a) X-axis slideway lubricating oil pressure switch
    - b) Y/Z-axis slideway lubricating oil pressure switch
    - c) Crossrail slideway lubricating oil pressure switch
  - (6) MCR-B
    - a) X-axis slideway lubricating oil pressure switch
    - b) Y/Z-axis slideway lubricating oil pressure switch
    - c) Crossrail slideway lubricating oil pressure switch
  - (7) S-20
    - Lubricating oil pressure confirmation switch (LBPR)

[Character-string]

None->X-, Y-, Z-axis

X-> X-axis

Y, Z-> Y-, Z-axis

W-> Crossrail

[Probable Faulty Locations]

- 1) Defective lubrication motor
- 2) Defective pressure switch
- 3) Defective lubrication piping

★ 2341 **Axis lube pressure OFF confirmation**

The pressure switch is not off when an axis lubrication motor is turned on.

Or the pressure switch is not turned off within a predetermined period (motor ON time \* 2) after the lubrication motor is turned off.

- (1) MC-30VA
  - X/Y/Z-axis slideway lubricating oil pressure switch
- (2) MC-40VA/50VA/60VA
  - X/Y/Z-axis slideway lubricating oil pressure switch
- (3) MC-400H
  - X/Y/Z-axis slideway lubricating oil pressure switch
- (4) MC-500H/600H/800H
  - X/Y/Z-axis slideway lubricating oil pressure switch
- (5) MDB-A/B, MCV-A/B, MCR, MCM
  - a) X-axis slideway lubricating oil pressure switch
  - b) Y/Z-axis slideway lubricating oil pressure switch
  - c) Crossrail slideway lubricating oil pressure switch
- (6) MCR-B
  - a) X-axis slideway lubricating oil pressure switch
  - b) Y/Z-axis slideway lubricating oil pressure switch
  - c) Crossrail slideway lubricating oil pressure switch

[Character-string]

None->X-, Y-, Z-axis

X-> X-axis

Y, Z-> Y-, Z-axis

W-> Crossrail

CA-> Carrier

[Probable Faulty Locations]

- 1) Defective pressure switch

- 2) Clogged lubrication piping

★ 2342 **Coolant motor overload**

The overload relay for the coolant pump motor is tripped.

- (1) MC-30VA  
OL2 is tripped.
- (2) VR-40  
FR7 is tripped.
- (3) MC-40VA/50VA/60VA  
FR7 is tripped.
- (4) MC-400H  
FR7 is tripped.
- (5) MC-500H/600H/800H  
OL7 is tripped.
- (6) MDB-A/B, MCV-A/B, MCR, MCM  
OL7 is tripped.
- (7) MCR-B  
OL7 is tripped.

[Probable Faulty Locations]

- 1) Defective coolant pump motor
- 2) Clogged lubrication pump

★ 2343 **Thru-the-tool coolant motor overload**

The overload relay for the through-the-tool coolant pump motor is tripped.

- (1) MC-30VA  
OL8 is tripped.
- (2) VR-40  
FR16 is tripped.
- (3) MC-40VA/50VA/60VA  
FR16 is tripped.
- (4) MC-400H  
FR8 is tripped.
- (5) MC-500H/600H/800H  
OL8 is tripped.
- (6) MDB-A/B, MCV-A/B, MCR, MCM  
OL16 is tripped.
- (7) MCR-B  
OL16 is tripped.

[Probable Faulty Locations]

- 1) Defective through-the-tool coolant pump motor
- 2) Clogged lubrication pump
- 3) The through-the-tool coolant command is specified although the through-the-tool coolant specification is not supported.

★ 2344 **Clamp command ON**

G01 is specified while an axis is clamped.

For the axes which are clamped and unclamped by M code commands, cutting mode (G01, G02 and G03) is specified while the axis is clamped.

[Index] AXIS

[Probable Faulty Locations]



Axis feed command of the W-axis is specified before the W-axis unclamp command (M58) is specified.

[Measures to Take] Correct the program.

★ 2345 **Clamp confirmation**

Clamp confirmation signal is not output.

The clamp confirmation LS is not turned on or the unclamp confirmation LS is not turned off within five seconds after the axis is clamped.

[Index] AXIS

[Character-string] None

[Code] None

[Probable Faulty Locations]

The axis is not clamped mechanically.

Defective clamp or unclamp confirmation LS

Defective clamp or unclamp SOL

Defective output card or fuse in the output card

★ 2346 **Unclamp confirmation**

Unclamp confirmation signal is not output.

The unclamp confirmation LS is not turned on or the clamp confirmation LS is not turned off within five[s] after the axis is unclamped (M\*\*).

[Index] AXIS

[Probable Faulty Locations]

- 1) The axis is not unclamped mechanically.
- 2) Defective clamp or unclamp confirmation LS
- 3) Defective clamp or unclamp SOL
- 4) Defective output card or fuse in the output card

★ 2347 **Axis interlock releasing**

This alarm indication shows that the axis interlock condition is released by setting "1" at machine user parameter (word) No. 40 to move an axis stopped due to axis interlock function.

This alarm does not appear under normal operation conditions.

★ 2348 **Unusable: print character string**

More than 159 characters are written following the quotation symbol (") in the print statement.

[Probable Faulty Locations]

PRINT statement

Program Example:

PRINT "ABCDEF..."

Alarm occurs when more than 159 characters are specified.

[Measures to Take] Correct the program.

[Related Specifications] Print function

★ 2349 **Tool change motor overload**

Overload of the tool change motor is detected.

(1) MC-30VA

Overload of the ATC motor is detected during tool change operation.

(2) MC-40VA/50VA/60VA

The inverter normal signal of the inverter for the tool change arm is turned off during tool change operation.

(3) MC-400H

The inverter normal signal of the inverter for the tool change arm is turned off during tool change operation.

(4) MC-500H/600H/800H

The inverter normal signal of the inverter for the tool change arm or the sub arm is turned off during tool change operation.

[Character-string] TA Tool change arm

SA Sub arm

[Probable Faulty Locations]

- 1) Defective tool change motor
- 2) Defective tool change motor control unit
- 3) Clamp operation without a tool

★ 2350 **EC system data code**

- (1) Logical error in various data (auto test data, manual test data, auto branch data, manual branch data, A/B mode test data, etc.) of input logic (PSCIF10.0 - 10.12).
- (2) Logical error in various data (out data, solenoid off data, A/B mode out data, etc.) of output logic (PSCOF10.0 - 10.12).
- (3) Logical error in interlock data (magazine, axes, spindle rotation, etc.).
- (4) EC alarm message is not registered in the NC control software.

[Code]

Absolute address of the data whose logical error is detected.

[Measures to Take]

- 1) Replace the memory. (Replacement of the memory is rarely required.)

★ 2351 **Spindle gear change command**

- (1) During spindle rotation, a spindle speed not available within the currently selected spindle speed range is commanded with S and M commands.
- (2) When selecting a spindle speed, the designated spindle speed is outside the allowable spindle speed, or a spindle speed which requires the change of spindle speed range is specified during spindle rotation.

[Code] S command value (in hexadecimal)

[Measures to Take] Check S or M command in a program.

★ 2352 **Spindle pulse generator**

The spindle pulse generator is not functioning normally.

- (1) Marker signal is not confirmed within a predetermined period (10 [s]) during spindle orientation.
- (2) Variation amount of the marker counter is greater than the specified number of pulses.  
The marker signal is turned on within 360-deg.
- (3) The difference between the feed counter and the marker counter is greater than the specified number of pulses.  
The marker signal is not turned on during pulse generator rotation.

[Character-string]

MARK-> Marker counter

FEED-> Feed counter

[Code]

None-> No marker signal

- 1) MARK:  
XXXX:Variation amount of marker counter (in hexadecimal)
- 2) FEED:  
XXXX:Difference between marker counter and feed counter (in hexadecimal)

[Probable Faulty Locations]

- 1) Defective pulse generator

★ 2353 **Spindle gear change impossible**

Spindle speed range gear match is not confirmed.

When an S command or spindle rotation command is specified, the spindle speed range is changed as commanded. The spindle speed range gear match is not confirmed in this spindle speed range change operation.

The spindle speed range change is retried up to three times.

[Code]

- 1-> Low range
- 2-> Middle range (high range for 2-speed model)
- 3-> High range (free for 2-speed model)
- 4-> Free

[Probable Faulty Locations]

- 1) Mechanical gear change error; dog or LS position shifted
- 2) Defective spindle speed range confirmation LS
- 3) Defective spindle speed range change SOL
- 4) Defective output card or blown fuse on it

★ 2354 **Spindle orient position OFF**

The spindle is offset by 15° or more from the orientation position.

For PLC specification, the orient-stopped spindle has moved from the oriented position over the position set at the optional parameter long word No. 20.

Difference between actual and oriented spindle positions in hexadecimal (PLC specification)

[Probable Faulty Locations]

- 1) The spindle is rotated by hand after spindle orientation.
- 2) Defective spindle drive unit
- 3) Defective spindle pulse generator
- 4) Defective ECP board

★ 2355 **Tool dia. enlarge solenoid**

★ 2356 **No S command**

- (1) An S command is not specified when a spindle rotation command (M03, M04) is executed.
- (2) An S command is not specified when a spindle speed range change command (M40, M41, M42, M43) is executed.

[Measures to Take] Check the program.

★ 2357 **Unusable: S code**

An S command which cannot be executed with the specification selected is specified.

[Code] S command value (in hexadecimal)

[Measures to Take] Check the S command in a program.

★ 2358 **Tool management number 0**

With the spare tool selection function or the tool life management function, the management number of the active tool is zero (0).

[Code] Magazine No. (in hexadecimal)

[Probable Faulty Locations] Data is not set on the tool management table.

[Measures to Take] Set the toolpot/tool number correspondence table.

[Related Specifications] Tool management function

★ 2359 **Data word: rotating axis command**

Wrong rotating axis command

[Code]

- 1-> Rotary table or index table command programmed during the following modes or programmed simultaneously with a G code establishing them.
- Circular interpolation mode (G02, G03) [index table only]
  - Tool length offset mode (G54 - G59)
  - Cutter radius compensation mode (G41, G42)
  - Three dimensional compensation mode (G44)
  - Figure enlargement or reduction mode (G51)
  - Coordinate computation mode
  - Area machining mode
- Note: In the cylindrical side surface machining mode (G175), this alarm occurs only when the tool length offset command or 3-D tool compensation command is specified.
- 2-> Index table command programmed during the following modes or programmed simultaneously with a G code establishing them.
- Skip function (G31)
  - Local coordinate system specification mode (G11)
  - During copy function
  - Work coordinate system specification command (G92)
- 3-> Index axis command programmed simultaneously with another axis during G01 mode.
- 4-> Command for a rotary axis of the circular table which has been removed.

[Probable Faulty Locations]

Wrong G code active when the rotary axis command is specified.

[Measures to Take]

Check the error condition, and then specify the correct command.

★ 2360 **Shower coolant motor overload**

Overloaded shower coolant motor

- (1) VR-40  
FR10 is tripped.
- (2) MC-40VA/50VA/60VA  
FR10 is tripped.
- (3) MC-400H  
FR9 is tripped.
- (4) MC-500H/600H/800H  
OL9 is tripped.

[Probable Faulty Locations]

- 1) Defective shower coolant motor
- 2) Clogged lubrication pump

★ 2361 **Hydraulic oil cooling unit**

The normal operation signal from the hydraulic oil cooling unit is turned off.

[Probable Faulty Locations] Defective hydraulic oil cooling unit

★ 2362 **VAC thermo protect**

The thermostat incorporated in the YE spindle drive motor is tripped.

[Probable Faulty Locations]

- 1) Cutting under overloaded condition
- 2) Defective spindle drive motor

[Measures to Take] Turn off the power supply and cool the motor.

★ 2363 **Area machining: M52 command**

M52 is specified when the cycle-axis is not the Z-axis.

[Probable Faulty Locations]

Axis designation or M52 command

Program Example:

G18 X0 Y0 Z100

PMIL X100 Y50 Z10 I100 J50 K5 Q10 R20 F400 D01 M52

:

[Measures to Take] Delete M52 or select the Z-axis (XY plane) as the cycle-axis.

★ 2364 **Unusable: address character**

Address characters which can be specified only once in a single block are specified more than one time.  
These address characters are F, C, B, A, X, Y, Z, U, V, and W.

[Code] 1

[Probable Faulty Locations]

Program error

Program Example:

G00 X0 Y0 X100

[Measures to Take] Correct the program.

★ 2365 **Data word: 'RS'**

An angle command outside 0° - 359° is specified for the multi-point spindle orientation function.

[Code] RS command value (in hexadecimal)

[Probable Faulty Locations]

Wrong RS command

Program Example RS=360 M19 WRITE

[Measures to Take] Correct the RS command value (to within 0 - 359°).

★ 2366 **APA read**

Upper digit data read from the position encoder is wrong.

[Character-string]

MG-> Magazine

CA-> carrier

W-> crossrail

[Code]

Upper digit data read from the position encoder(in hexadecimal)

[Probable Faulty Locations]

Faulty position encoder

- ECP board

★ 2367 **Axis drive motor overload**

The thermostat incorporated in the EC-axis drive motor is tripped.

(1) 30VA

a)

Magazine

(2) VR-40

- a) Magazine
- b) APC
- (3) MDB-A/B, MCV-A/B, MCR, MCM
  - a) Crossrail
  - b) Magazine
  - c) Carrier
- (4) MCR-B
  - a) Crossrail
  - b) Magazine

[Character-string]

MG-> Magazine

CA-> Carrier

W-> Crossrail

[Probable Faulty Locations]

- 1) Excessive motor load due to mechanical problem
- 2) Defective axis drive motor
- 3) Defective axis drive unit

[Measures to Take] Turn off the power supply and cool the motor.

★ 2368 **ATC hydraulic motor overload**

The overload relay for the ATC hydraulic motor is tripped.

- (1) MCV-A (24-tool ATC)  
OL5 is tripped.

[Probable Faulty Locations]

- 1) The ATC is operated for more than 30 minutes continuously (motor rating: 30 min).
- 2) Defective ATC hydraulic motor

★ 2369 **Spindle REVERSE command**

On the AC spindle motor specification model, the spindle reverse rotation command is specified after changing the spindle speed range.

Program Example:

NOOOS10

NOOOM04 <- Alarm

[Measures to Take]

After a new spindle speed command is specified or tool change cycle is completed, it is necessary to rotate the spindle forward before rotating it in the reverse direction.

★ 2370 **Cross rail vertical drive motor overload**

The overload relay for the crossrail vertical movement motor is tripped.

- (1) MDB-A/B, MCV-A/B, MCR, MCM  
OL2 is tripped.  
Machine Input Signal No. 14 bit 0

[Probable Faulty Locations]

- 1) Crossrail drive motor is overloaded.
- 2) Faulty crossrail drive motor

★ 2371 **Swivel head index compensation**

Mismatch between the specified swivel head index direction and direction of the compensation command. (Phase difference in each direction is 90-deg.)

[Probable Faulty Locations]

Actual swivel head direction and command compensation direction has a phase difference of 90-deg.

Program Example:

M73 (swivel head front direction: X-axis direction)

G55 X100. Y50. D01 (tool length offset in Y-axis direction)

[Measures to Take]

Specify the compensation data taking the swivel head position into consideration.

[Related Specifications] Swivel head index compensation

★ 2372 **Spindle orientation time over**

★ 2373 **Spindle orientation answer error**

★ 2374 **No pallet program**

In the pallet pool line control (PPC), an error has occurred during selection of the pallet change program (09999).

[Code]

1) X:

1-> The automatic operation mode is not selected.

2-> The command buffer is not empty.

3-> An error occurred when reading the main program by PDO task.

2) XYZZAABB:

X = 1 -> Automatic selection alarm

BB:

bit0-> The specified schedule program file is not found.

bit1-> The specified main program file is not found.

bit2-> The specified subprogram file is not found.

bit3-> The specified program is not found.

bit4-> The specified subprogram is not found.

bit5-> M02 or M03 is not designated before the end of main program.

bit6-> RTS is not designated before the end of subprogram.

bit7-> The program is too large to be stored in the program buffer.

AA:

bit0-> The number of sequence names in the main program has exceeded 31.

bit1-> A sequence name consists of more than 5 characters including N.

bit2-> The CALL statement is not followed by a subprogram name.

bit3-> A subprogram name consists of more than 5 characters including O.

bit4-> The program name of G or M code macro has not been defined.

bit5-> The number of subprograms to be called has exceeded 63.

bit6-> The program has a block of more than 156 characters.

bit7-> The sum of main file name and extended file name has exceeded 20 characters.

ZZ:

bit0-> The specified main file name and extended file name start with numerals.

bit1-> The device name is specified with more than 3 letters or a colon ':' is omitted after the device name.

bit2-> The specified program name does not begin with O.

bit3-> The specified program name contains non-alphanumeric characters.

bit4-> The program name is specified with more than 5 characters including O.

bit5-> More than 16 options are specified.

bit6-> The flag of multivolume file is not included within a main file name of 8 characters.

bit7-> The program selection request signal is designated during execution of schedule program.

Y =

- bit0-> The program selection request command is designated during execution of the main program.
- bit1-> Program selection is attempted in an invalid mode.
- bit2-> The serial number of the multi volume file has exceeded 99.
- bit3-> A floppy is designated as a device name.
  - X = 2 Memory defect
  - The specified file name contains \* or ?.

[Probable Faulty Locations]

The pallet change program (09999) is not stored in the memory.

[Measures to Take]

Check if there is the program (09999) in the file of PPC\*. MIN in the memory (MD1:).

**★ 2375 No user program**

In the pallet pool line control (PPC), an error occurred during machining program selection.

[Code] Refer to Alarm No. 2374.

[Probable Faulty Locations]

Program name set at the PPC is not found in the bubble memory.

[Measures to Take]

Using the OPERATION GUIDE function in the EDIT AUX. mode operation, check whether the program number to be selected is registered in the memory (MD1:).

**★ 2376 No attachment offset**

**★ 2377 Crossrail unclamp motor overload**

With the MDB and MCV equipped with the crossrail unclamp hydraulic motor, the overload relay for the unclamp motor is tripped.

[Probable Faulty Locations]

- 1) The crossrail unclamp state has been continued for a long time (motor rating: 15 min).
- 2) Defective crossrail unclamp motor

**★ 2378 LTC M command**

An M command related to the LTC is not correctly specified.

**★ 2379 AAC1 M command**

An M command related to AAC operations is not correctly specified.

[Code]

- 1-> M46 or M157 (next attachment adaptor command) is specified while the next AAC operation sequence number is not zero (0).
- 2-> M46 or M157 is specified while the active AAC operation process is the adaptor.
- 3-> M46 or M157 is specified while the AAC is not at the start position (AAC operation sequence number "1").
- 5-> M45 or M159 (active attachment adaptor command) is specified during the execution of AAC cycle.
- 6-> M45 or M159 is specified while the AAC is not at the start position.
- 7-> M44 or M158 (next attachment clear) is specified during the execution of AAC cycle.
- 8-> M44 or M158 is specified while the AAC is not at the start position.

[Measures to Take] Check the program.

**★ 2380 AAC2 M command**

An M command related to the table type AAC operations is not correctly specified.

[Code]

- 1-> M47 (next attachment adaptor command) is specified while the next AAC operation sequence number is not zero (0).



- 2-> M47 is specified while the active AAC operation process is the adaptor.
- 3-> M47 is specified while the AAC is not at the start position (AAC operation sequence number "1").
- 5-> M49 (active attachment adaptor command) is specified during the execution of AAC cycle.
- 6-> M49 is specified while the AAC is not at the start position.
- 7-> M48 (next attachment clear) is specified during the execution of AAC cycle.
- 8-> M48 is specified while the AAC is not at the start position.

[Measures to Take] Check the program.

★ 2381 **Crossrail positioning sensor**

The crossrail auto positioning was not normally completed.

[Code]

- 1-> After being positioned, the crossrail has moved 2 mm or over from the specified position.
- 2-> During positioning, the magnet sensor signal failed to come ON though the crossrail passed the parameter-set position over 10 mm.
- 3-> The positive limit was reached during positioning.

[Probable Faulty Locations]

- 1) Faulty magnet sensor
- 2) Faulty fieldnet
- 3) Slipped dog position
- 4) Parameter setting error

★ 2382 **Spindlehead cooling unit**

The overload relay of the spindlehead cooling unit motor has been tripped.

VR-40 This alarm occurs when the normal signal from the spindlehead cooling unit located at the right side of the column is turned off.

MC-40VA This alarm occurs when the normal signal from the spindlehead cooling unit located at the right side of the spindlehead is turned off.

MC-50VA/60VA This alarm occurs when the spindlehead cooling unit normal signal from the hydraulic power unit (combination unit) provided at the rear of the column.

S-20 The spindlehead oil temperature regulator is in abnormal state.

The spindlehead cooling motor (OCR/) has been OFF for more than one[s]. Or, the spindlehead cooling unit abnormal signal (OCUA) has been ON for more than one[s].

[Probable Faulty Locations]

Problem with the lubricating oil cooling unit in the combination unit

★ 2383 **Detachable axis move**

For machines equipped with the detachable rotary table, the rotary table axis is designated while it is detached.

[Index] AXIS

[Probable Faulty Locations] Program error

[Measures to Take] Check the program.

★ 2384 **Outside**

An alarm occurred with an external coupled device such as a robot and loader.

An alarm with the loader controller for machines provided with a robot or loader.

[Probable Faulty Locations]

- 1) Problem with the robot or loader
- 2) Defective input card

★ 2385 **Limit confirmation impossible**

No signal is input from the swivel head position detection LS.

During swivel head indexing, the counter data exceeds the designated swivel head position counter data by 45° or more.

[Code]

- 1-> Front
- 2-> Left
- 3-> Rear
- 4-> Right

[Probable Faulty Locations]

- 1) Swivel head position confirmation dog is offset.
- 2) Swivel head position confirmation LS is faulty.
- 3) Defective input card

★ 2386 **BDU**

EC-axis drive unit is not operating normally, or the EC-axis normal signal is turned off.

- (1) VR-40
  - a) Magazine
  - b) APC
- (2) MDB-A, MCV-A, MDB-B, MCV-B, MCR, MCM
  - a) Crossrail
- (3) MCV-B, MCR, MCM
  - a) Magazine
  - b) Carrier
- (4) MCR-B
  - a) Crossrail
  - b) Magazine

[Character-string]

- W-> Crossrail
- MG-> Magazine
- CA-> Carrier

[Probable Faulty Locations] Defective brushless drive unit (BDU-D)

★ 2387 **BDU ready**

When the EC-axis is clamped, the servo system is reset.

This alarm occurs if the servo amplifier is not reset within a predetermined period, or the reset state is canceled (axis movement enabled signal is turned on).

- (1) MDB-A, MCV-A, MDB-B, MCV-B, MCR, MCM
  - a) Crossrail
- (2) MCV-B, MCR, MCM
  - a) Magazine
- (3) MCR-B
  - a) Crossrail
  - b) Magazine

[Character-string]

- W-> Crossrail
- MG-> Magazine
- APC-> Multi-pallet PME type APC

[Probable Faulty Locations] Defective brushless drive unit (BDU-D)

★ 2388 **Data word: 'E'**

Improper E command

[Code]

- None-> The G187 command block has no E command.
- 2-> During calculation of feedrate in thread cutting, the feedrate turned to a negative value.
- Others-> Specified E command value in hexadecimal

[Probable Faulty Locations]

The G187 command (tolerance control mode ON, Hi-cut control mode ON) block has no E command (machining tolerance).

The variable pitch command E or feedrate F command value is out of the allowable range. Even if the value is within the range, the final feedrate is a negative value.

Or, the G131 command (Super Hi-NC control mode ON) block has a E command (Machining Tolerance value) of which value is out of the setting range.

[Measures to Take]

In the G187 command block, specify the machining tolerance with E command.

Or, refer to the instruction manual, and order the Machining Tolerance value which is appropriate for the G131 command block.

Or, enter the variable pitch within the following range:

-5000000 to 5000000.

★ 2389 **Graphic program instruction**

Syntax error or error in setting GRST when special G codes related to the graphic functions such as GRON, GROF, GRER, or GRST is specified.

[Code]

- 1-> With GRST, factor classification code other than address character is specified. Correct the syntax.
- 2-> Address character other than those specified by GRST is specified. Address characters usable are X, Y, Z, I, J, K, P, Q, and H.
- 3-> In the block containing GRON, GROF, and GRER, which must be specified in a block without other commands, other commands are specified.
- 4-> With GRST, the graphic zero point setting values having X, Y, and Z components and specified following address characters X, Y, and Z exceed the limit value.  
-9999.999mm <= Setting value <= 9999.999mm
- 5-> With GRST, drawing range setting values having X, Y, and Z components and specified following address characters X, Y, and Z exceed the limit value.  
4.000 mm <= Setting value <= 9999.999 mm
- 6-> With GRST, view direction and view angle height setting values specified following address characters P and Q exceed the limit value.  
0 <= direction setting value <= 359  
-89 <= View angle height setting value <= 89
- 7-> With GRST, drawing plane number setting value specified following address character H exceeds the limit value.  
0 <= Setting value <= 7

[Measures to Take] Correct the command.

★ 2390 **Multi volume next program load**

In the multi-volume operation, loading (P-SELECT) of the next file was not successful.

[Code]

- 1) X:
  - 1-> Automatic mode is not selected.
  - 2-> The command buffer is not empty.
  - 3-> An error when reading a main program in the PDO task.

2) XYZZAABB:

-X=1:

BB:

Bit0-> No specified schedule program file

Bit1-> No specified main program file

Bit2-> No specified subprogram file

Bit3-> No specified main program

Bit4-> No specified subprogram

Bit5-> No M02 or M03 up to the end of main program

Bit6-> No RTS up to the end of subprogram

Bit7-> Program buffer cannot register the entire program.

AA:

Bit0-> The main program has more than 31 sequence names.

Bit1-> A sequence name consists of more than five characters including N.

Bit2-> No subprogram name is specified following CALL statement.

Bit3-> A subprogram name consists of more than five characters including 0.

Bit4-> G and M code macro program names have not been defined.

Bit5-> More than 63 subprograms are called.

Bit6-> A block contains more than 156 characters.

Bit7-> Main file name and extension have a total of more than 20 characters.

ZZ:

Bit0-> Main file name and extension begin with a numeric character.

Bit1-> A device name consists of more than three characters or no colon ( : ) is designated following a device name.

Bit2-> A program name does not begin with "O".

Bit3-> A program name contains characters other than alphanumeric characters.

Bit4-> A program name has more than five characters including "O".

Bit5-> Option designation is made with more than 16 characters.

Bit6-> Multi-volume file ID is not found within eight characters.

Bit7-> Request for program selection is found during execution of a schedule program.

Y:

Bit0-> Request for program selection is found during execution of a main program.

Bit1-> An attempt to select a program in a mode which is not supported

Bit2-> The order number of multi-volume files exceeds 99.

Bit3-> A floppy disk drive is designated as a device name.

-X=2:

Defective memory

Symbols "\*" and "?" are specified in a file name.

[Probable Faulty Locations]

- 1) The file to be loaded next is not within the memory.
- 2) Due to a memory problem, access to the memory cannot be done correctly.

[Measures to Take]

- 1) Check whether the file to be loaded is registered in the memory.
- 2) If the file to be loaded is registered in the memory, select the file (P-SELECT) with an ;M command.
- 3) When the program selection is satisfactory, resume operation.

★ 2391 **BFR task program load**

If an error occurs in other than program selection in the BFR task, an alarm occurs.

- (1) Error in memory read operation
- (2) Access to sector in an area which is not accessible.
- (3) In the B, S, or M method operation, an error occurred while the selected program is read.

[Code]

None or XXXXYYYYY

XXXX:Physical sector number with which an error occurred

YYYY:Error number (error list number)

[Probable Faulty Locations]

- 1) Error in memory read operation
- 2) Access to the inaccessible area

[Measures to Take]

Call out the program currently selected by the edit operation and advance the program to the end using the page key. If an error occurs during this operation, it indicates a memory memory read out error. Refer to "Measures to Take" for the corresponding number of the Error List.

★ 2392 **S, T, M time over**

When S, T, M, RS or RT command is executed, an alarm occurs if no answer signal of the command executed is returned from the ECP within the period set at NC optional parameter (word) No. 18.

This alarm occurs only when the setting at optional parameter (bit) No. 15 bit 5 (STM cycle time over check function) is "1".

[Code]

bit 0-> RS

1-> RT

2-> M

3-> T

4-> S

Bit data corresponding to the command whose answer signal is not returned is turned on (1). Indicated in one byte hexadecimal. More than one bit may be turned on at the sametime.

[Probable Faulty Locations]

- 1) Operations of the commanded S, T, M, RT or RS commands cannot be accomplished smoothly.
- 2) Setting at NC optional parameter (word) No. 18 is too small.

Initial setting is 120[min].

Program Example:

If an alarm occurs with the command M06T3, for example, the alarm code is "C".

[Measures to Take] Set 120 at NC optional parameter (word) No. 18.

★ 2393 **In-position observation time over**

In-position status is not confirmed within a predetermined period (set at NC optional parameter (word) No. 19) after the completion of axis movements.

[Index] AXIS

[Probable Faulty Locations]

- 1) Setting error of in-position width (system parameter)
- 2) Setting error of NC optional parameter (word) No. 19
- 3) Problem with the servo system (poor positioning accuracy)

[Measures to Take]

- 1) Re-set the in-position width.
- 2) Reset the data at NC optional parameter (word) No. 19.

3) Check the servo system.

★ 2394 **Data word: 'RH'**

Command value of attachment angle command RH is outside 0° to 359°, or an angle not supported by the specification is specified (usually, attachment is indexed in units of 5°, 15° or 45°).

[Code] RH command value in hexadecimal

[Probable Faulty Locations]

Program error

Program Example:

N000 RH=360 M94 WRITE

★ 2395 **User reserve code**

With the user task 2 specification, VDOUT [992] = \*\*\*\* is specified in a program.

[Code]

The value designated at the right part of this command and the user alarm comment designated in the command format of VUACM [\*] = '\*\*\*\*\*' are displayed.

Decimal numbers from 0 to 9999 are allowed for "\*\*\*\*\*", and display is given with leading zeros suppressed. For a number other than those indicated above, "FFFFFFF" is displayed.

Program Example:

VUACM [1] = 'ABC' WRITE

VDOUT [992] = 1234 WRITE';

-> 2395 Alarm B User reserve code 1234 ABC

[Related Specifications] User task 2

★ 2396 **Unusable: output variable NO.**

An output variable number not available with the selected specification is designated.

[Code]

Hexadecimal number of the designated output variable number

[Probable Faulty Locations]

Output variable number

Program Example VDOUT [\*\*]

Number not available by specification

[Measures to Take]

Change the output variable number to a number allowed by the specification.

★ 2397 **Unusable: input variable NO.**

An input variable number not available with the selected specification is designated.

[Code]

Hexadecimal number of the designated input variable number

[Probable Faulty Locations]

Input variable number

Program Example:

VDIN [\*\*]

Number not available by specification

[Measures to Take]

Change the input variable number to a number allowed by the specification.

★ 2398 **Work clamp miss**

With the chucking error detection specification, the chuck close end position confirmation LS is not turned on during the execution of the chuck close command. The control judges a status such as that the workpiece has not been clamped, and thus an alarm occurs.

This alarm also occurs on the machine with seated condition checking function when the proximity switch for checking work seated condition does not come ON, or the switch is OFF for 0.5 second or over.

This alarm also occurs on the machine with chucking error detecting function, if the chucking error signal is sent when chuck clamp command is effective.

[Index] None

[Character-string]

None: Constant monitoring is selected and the proximity switch failed to send signal for 0.5 second or over during spindle rotation.

2: Chucking error was detected (by the chucking error detecting function).

[Related Specifications] Chucking error detection specification

★ 2399 **Bad value for output variable**

For output variable VDOUT [n], a command value exceeding the allowable value (number of bytes) is set.

[Code] Command value specified (in hexadecimal)

[Probable Faulty Locations]

Output variable VDOUT [n]

Program Example:

VDOUT [1] = 2  
          ^ Alarm 2

[Measures to Take]

Take the following points into consideration.

n=1 - 16 (bit data) 0, 1

n=17, 18 (byte data) 0 - 255

n=20 (work data) 0 - 65535

★ 2400 **Program bad direct: character string**

Illegal designation of apostrophe type character-string

[Code]

1-> No character-string

2-> Character-string containing more than 16 characters

3-> LF is found within a character-string. (no continuity line allowed for character-string)

[Probable Faulty Locations]

Apostrophe type character-string

Program Example:

'Character-string'

[Measures to Take] Specify the character-string correctly.

★ 2401 **Program bad direct: hexadecimal data**

Error in hexadecimal character-string in the command for picture hexa data.

\$ Hexadecimal number This classification is regarded as character data.

[Code]

1-> No data

Code other than 0 through 9, A through F is specified immediately after the \$ symbol.

2-> More than eight digits

[Probable Faulty Locations]

Character-string of picture hexa data

Program Example:

```
$ * D9  
  ^ Alarm code 1
```

[Measures to Take] Specify the character-string correctly.

**★ 2402 SAC unit**

During the execution of the tool wear compensation cycle, an error signal from the SAC II unit is turned on.

[Code]

- 1-> The TIME signal is turned on during the execution of the SAC II tool wear compensation cycle.
- 2-> The +NG signal is turned on during the execution of the SAC II tool wear compensation cycle.
- 3-> The -NG signal is turned on during the execution of the SAC II tool wear compensation cycle.
- 4-> The FAULT signal is turned on during the execution of the SAC II tool wear compensation cycle.
- 5-> The COMP. END signal is not turned on within 20 seconds after the output of the SAC II tool compensation cycle start signal.

[Probable Faulty Locations]

- 1) Code 1  
Engagement between the hexagonal hole in the SAC II and the hexagonal bolt in the boring bar
- 2) Code 2  
Chips on the tool tip. Tool diameter specified.
- 3) Code 3  
Broken tool tip. Tool diameter specified. If the tip has been chipped, replace it.
- 4) Code 4  
Problem with the SAC II unit.
- 5) Code 5  
The mode of the SAC II unit (must be AUTO). Error with the SAC II unit.

**★ 2403 Coolant circulation motor overload**

With the special coolant tank specification (coolant tank with filtering unit), this alarm occurs if the circulation motor ON signal of the coolant circulation pump motor stays off for more than one second.

[Probable Faulty Locations]

The overload relay for the coolant circulation pump motor is tripped.

[Related Specifications] Special coolant tank specification

**★ 2404 MSB reserved**

This alarm outputs the check results of the Maker subprogram.

[Code]

Refer to the Operation Manual for the relevant Maker subprogram

[Measures to Take]

Check the following items.

- 1) Transfer parameter
- 2) NC status
- 3) Setting data

**★ 2405 Graphic no spec.**

An attempt is made to execute a graphic command although the control is provided with the graphic specification.

[Index] TURRET



[Probable Faulty Locations]

Program error

Program Example:

:

DEF WORK

PS LL, [0, 0], [100, 100], 4

END

:

[Measures to Take] Delete the graphic commands.

[Related Specifications] Graphic display

**★ 2406 UGC: Program end code none**

End of program code is read in the conversion process of the user graphic command characters.

[Code]

1-> When converting user graphic command execution statement

2-> When skipping user graphic command comment lines

[Probable Faulty Locations]

An error in the UGC command string in the part program

Program Example:

DEF WORK (UGC WORK)

PS LL, [0, 0], [100, 100], 4

:

END

[Measures to Take]

Check the UGC program.

In the example program, there is an error in the comment line.

Correct Program:

DEF WORK (UGC WORK)

PS LL, [0, 0] [100, 100], 4

:

END

**★ 2407 UGC: Delete syntax**

Illegal delete command designated

[Code] User graphic internal code

[Probable Faulty Locations]

[Character-string]

designated in the DELETE statement in the user graphic command

Program Example:

DELETE PAINT

[Measures to Take]

Check the character-string following the DELETE statement; correct it.

[Related Specifications] Color, monochrome graphic display

**★ 2408 UGC: DEF syntax**

Illegal registration declare command designated

[Code] User graphic internal code

[Probable Faulty Locations]

[Character-string]

designated in the DEF statement in the user graphic command

Program Example:

```
DEF PAINT
```

```
:
```

[Measures to Take]

Check the character-string following the DEF statement; correct it.

[Related Specifications] Color, monochrome graphic display

**★ 2409 UGC: Figure entry**

No user graphic command to be registered

[Code]

1-> There is no user graphic command between the registration declaration statement and the end declaration statement (excluding standard procedure statement).

[Probable Faulty Locations]

User graphic command string

Program Example:

```
:
```

```
DEF WORK
```

```
END
```

```
:
```

[Measures to Take]

Add the user graphic command for which the shape is to be defined.

```
:
```

```
DEF WORK
```

```
PS LL, [0, 0] [100, 100], 4
```

```
END
```

```
:
```

[Related Specifications] Color, monochrome graphic display

**★ 2410 UGC: Illegal numerical**

Illegal numerical data input

[Code] 5 Number of digits overflow

[Probable Faulty Locations]

Numerical data in the user graphic command

Char[3 574 0]{CntInfo="Program Example DEF WORK

```
PS LL, [0, 0], [1000000, 100], 4
```

```
^^^^^^
```

```
END
```

[Measures to Take]

Check the numerical data and correct it.

```
DEF WORK
```

```
PS LL, [0, 0], [100, 100], 4
```

```
END
```

[Related Specifications] Color, monochrome graphic display

★ 2411 **UGC: Illegal character**

Illegal code not applicable to operator code designated

[Code]

1-> Hexadecimal number of ASCII

[Probable Faulty Locations]

User graphic command string

Program Example:

```
DEF WORK
PS LL, [0, 0], [100&100], 4
END
```

[Measures to Take]

Change characters other than those listed below into the corresponding character or function operator.

0 through 9, A through Z, ], ,, +, -, \*, /, [, =

```
DEF WORK
PS LL, [0, 0], [100, 100], 4
END
```

[Related Specifications] Color, monochrome graphic display

★ 2412 **UGC: User variable**

Illegal user variable designated

[Code]

0-> No user variable number entry  
1-> Entry of a number following user variable number  
2-> Number of digits overflow in designating user variable number

[Probable Faulty Locations]

[Character-string]

which begins with "D" in the user graphic command string

Program Example:

```
DEF WORK
PS LL, [0, 0], [D100, 100], 4
                ^^^^^^^^^^^^^
END
```

[Measures to Take]

Correct in the correct user time variables (D0 - D99) or character-string.

```
DEF WORK
PS LL, [0, 0], [D10, 100], 4
END
```

[Related Specifications] Color, monochrome graphic display

★ 2413 **UGC: System variable**

Illegal system variable designated

[Code]

0-> No system variable number entry  
1-> Entry of a number following system variable number  
2-> Number of digits overflow in designating system variable number

[Probable Faulty Locations]

[Character-string]

which begins with "S" in the user graphic command string

Program Example:

```
DEF WORK
PS LL, [0, 0], [S100, 100], 4
      ^^^^
END
```

[Measures to Take]

Correct to the proper user time variables (S0 - S9) or character-string.

```
DEF WORK
PS LL, [0, 0], [S10, 100], 4
END
```

[Related Specifications] Color, monochrome graphic display

★ 2414 **UGC: Illegal command**

Illegal character-string designated

[Code]

Hexadecimal number of ASCII, or user graphic internal code

[Probable Faulty Locations]

User graphic command string

Program Example:

```
DEF WORK
PS LZ, [0,0], [100, 100], 4
END
```

[Measures to Take]

Check and correct the user graphic command string.

```
DEF WORK
PS LL, [0,0], [100, 100], 4
END
```

[Related Specifications] Color, monochrome graphic display

★ 2415 **UGC: Program factor over**

Overflow of factor code stack or factor data stack

[Code]

- 1-> Factor code stack overflow at character-string conversion
- 2-> Factor data stack overflow at character-string conversion
- 3-> Factor code stack overflow at command creation
- 4-> Factor data stack overflow at command creation

[Probable Faulty Locations]

User graphic command string

Program Example:

```
D1 = D1 + 1 + 1 + 1 .... + 1
      <----->125 or more
```

[Measures to Take]

User graphic command string

Reduce the number of the factor codes and factor data sets, or divide the expression using the substitute statement.

```
D1 = D1 + 1 + 1 .... + 1
      <----->Within 124
```

[Related Specifications] Color, monochrome graphic display

★ 2416 **UGC: Coordinate data**

Mismatch of the numbers of the left and right brackets, illegal factor code, inconsistency of the number of command coordinates

[Index] TURRET

[Code]

- 1-> Mismatch of the numbers of left and right brackets, illegal factor code, excess number of brackets with the commands excluding assignment statement
- 2-> Mismatch of the number of left and right brackets with the commands excluding assignment statement
- 3-> Mismatch of the numbers of left and right brackets, illegal factor code, inconsistency of the number of command coordinates and excess number of brackets with the commands excluding assignment statement

[Probable Faulty Locations]

User graphic command

Program Example:

```
:  
PF 3, [0, 0], [10, 0], [0, 10], [7, 8], 4  
:                ^^^^
```

[Measures to Take]

Check and correct the user graphic command format.

```
:  
PF 3, [0, 0], [10, 0], [0, 10], 4  
:
```

[Related Specifications] Color, monochrome graphic display

★ 2417 **UGC: END syntax**

Illegal end declaration statement

[Index] TURRET

[Code]

- 1-> No LF for end declaration

[Probable Faulty Locations]

END statement in the user graphic command string

Program Example:

```
:  
DEF WORK  
:  
END X
```

[Measures to Take]

Delete the character-string just after the END statement.

```
:  
DEF WORK  
:  
END
```

[Related Specifications] Color, monochrome graphic display

★ 2418 **UGC: Figure entry command over**

Overflow of user graphic command stack area

[Code]

1-> Overflow with user graphic command string storage area (stack)

[Probable Faulty Locations]

User graphic command string

Program Example:

:

\* DEF

|:

\* END

\*\_\* More than 600 bytes

[Measures to Take]

Reduce the number of the commands in the command-string, or reduce the necessary memory space using the macro.

:

\* DEF

|:

\* END

\*\_\* Reduce to less than 600 bytes

[Related Specifications] Color, monochrome graphic display

★ 2419 **UGC: Command format**

Syntax error with:

POINT statement, VIEW statement, WINDOW statement, LINE statement, CIRCLE statement, PAINT statement, PAINTI statement, PAINTS statement, PAINTP statement, CALL statement, PLAIN statement, and assignment statement.

[Code] User graphic internal code

[Probable Faulty Locations]

User graphic command

Program Example:

:

PS L, [0, 0], [100, 100], 4

:

[Measures to Take]

Check the syntax of the user graphic commands; make correction as needed.

:

PS LL, [0, 0], [100, 100], 4

:

[Related Specifications] Color, monochrome graphic display

★ 2420 **UGC: Additional parameter**

Illegal additional parameter programmed

Code 1 Illegal circle rotation direction

(other than omission, L and R)

Illegal triangle angle

(other than omission, 0, 1 and 2)

Illegal line style, tile pattern and color designation

(other than omission and 0 - 7)

[Probable Faulty Locations]

Additional parameter of the user graphic command

Program Example:

LI [100, 100], 9

:

[Measures to Take]

Check the user graphic command additional parameter; correct as needed.

:

LI [100, 100], 6

:

[Related Specifications] Color, monochrome graphic display

★ 2421 **UGC: Expression**

Expression syntax error

[Code]

1-> More than one solution

2-> Program end code in expression

3-> Operand stack area over

4-> Mismatch between the numbers of operands

5-> Operand classification code stack area over Mismatch between the numbers of left brackets "[" and right brackets "]"

6-> More than two subscript expressions

[Probable Faulty Locations]

Substitution statement and quadratic expression in the user graphic command

Program Example:

:

PS LL, [0, 0], [100, 100, 100], 4

:

^^^^^^^^^^^^^^

[Measures to Take]

Check and correct the syntax of the substitution statement and quadratic expression.

:

PS LL. [0, 0], [100, 100], 4

:

[Related Specifications] Color, monochrome graphic display

★ 2422 **UGC: Entry area over**

The total of the previously registered area and the presently registered area exceeds the allowable value of the shape registration area.

[Code]

1-> Empty area for shape registration is not available.

[Probable Faulty Locations]

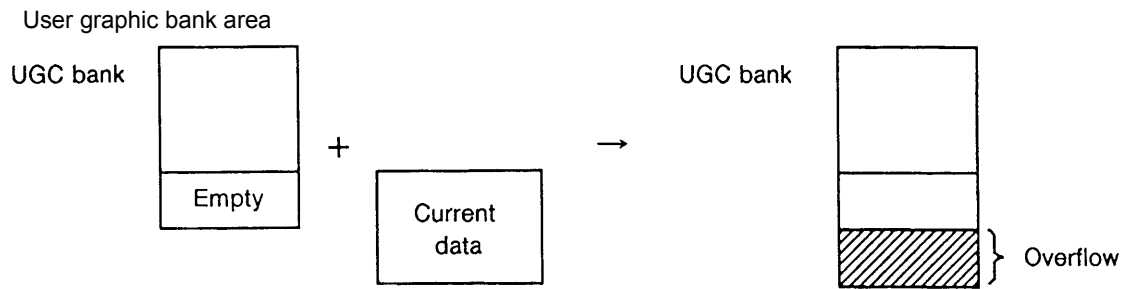

[Measures to Take]

Delete the current user graphic command string, or delete the unnecessary user graphic command string which is already registered before registering the current data.

[Related Specifications] Color, monochrome graphic display

★ 2423 **UGC: Delete unable**

No user graphic command string to be deleted.

[Code]

1-> User graphic command to be deleted is not registered.

[Probable Faulty Locations]

DELETE statement of the user graphic command

Program Example:

```

:
DELETE MACRO [8]
:

```

[Measures to Take] Check and correct the command string to be deleted.

[Related Specifications] Color, monochrome graphic display

★ 2424 **Synchronous error recovering operation**

This indicates that the synchronization error correction mode is ON or synchronized position shift amount setting mode is ON in the synchronized axis control operation.

[Code] Synchronization error (in hexadecimal)

[Probable Faulty Locations]

This indicates that the mode established is for the correction of synchronization error.

Operation Example When the optional parameter (bit) No. 37 bit 0 or bit 1 is set at "1", the synchronization error correction mode or the synchronized position shift amount setting mode is established.

[Measures to Take]

This alarm message simply indicates the mode, and no special measures should be taken. Cancel the mode established and reset the control. The alarm will be cleared.

[Related Specifications] Synchronous axis specification

★ 2425 **Quill cycle time over**

★ 2426 **DNC-B remote operation**

During DNC-B remote mode operations, an error has occurred.

[Index] None

[Character-string]

Communication alarm number (such as 4218, 4219, 4220 or 4037) or error number

[Code]

When a communication alarm occurs, the character-string shows the alarm number.  
For the cause of the alarm, refer to the alarm D of the displayed number.



When an error occurs, the character-string shows the error number.  
For the cause of the error, refer to the error of the displayed number.

[Probable Faulty Locations]

An error or a communication alarm occurred during remote operation through DNC-B.

[Measures to Take] Refer to the corresponding alarm or error.

[Related Specifications]

DNC-B

★ 2427 **ATC cycle time over**

(1) MC-30VA

Tool change arm operation is not completed within a predetermined period.

[Code]

1-> Tool change arm operation continues for seconds or more.

2-> The spindle unclamp state is not established in 3 seconds after the tool change arm has started operation and the spindle unclamp signal has been output.

(2) VR-40

Tool change arm operation is not completed within a predetermined period (4 seconds).

(3) MC-400H

Tool change arm operation is not completed within a predetermined period.

[Character-string]

TA-> Tool change arm operation continues for 2.5 seconds or more.

(4) MC-500H/600H/800H

Tool change arm operation or sub arm operation is not completed within a predetermined period.

[Character-string]

TA-> Tool change arm operation continues for 5 seconds or more.

SA-> Sub arm operation continues for 9 seconds or more.

★ 2428 **Air pressure low**

With MC-30VA/VR-40/S-20:

This alarm occurs if pneumatic source pressure drops (source pressure confirmation pressure switch signal OFF).

Source pressure confirmation pressure switch signal:

[Probable Faulty Locations] Compressor not operating normally

★ 2429 **Chip flush-out motor overload**

For machines provided with chip flush-out specification:

This alarm occurs if the bed flush-out normal signal is turned off while the bed flush-out pump operation signal is being output.

[Probable Faulty Locations]

The overload relay for the bed flush-out pump motor is tripped.

[Related Specifications] Chip flush-out specification

★ 2430 **Axis interlock**

(1) A B-axis command is specified while the X-axis is not within 10 mm from the machine zero.

(2) A B-axis command is specified while the door is not open.

[Index] AXIS

[Character-string]None

[Code]

6-> On DCC-15/25/25Y, B-axis command was specified without locating Y-axis in the machine zero.

- 7-> On DCC-15/25/25Y, Y-axis and B-axis commands were specified at the same time.
- 8-> The B-axis command was specified though the X-axis was not located in the X-axis home position No. 1.
- 9-> The B-axis command was specified though the Z-axis was not located in +/-100 mm from the Z-axis home position No. 3.
- A-> The B-axis command was specified while the A-pallet was in the machine.

★ 2431 **APC pallet index condition**

The pallet position confirmation signal for a multiple-pallet APC is not read correctly.

- (1) Character-string 'PR' Parity error with pallet position LS

[Code] XYYY Data read from the LS's

YY:

Bit0-> No. 1 LS

Bit1-> No. 2 LS

Bit2-> No. 4 LS

Bit4-> No. 8 LS

XX:

Bit8-> Parity LS

- (2) Character-string 'NO' The pallet numbers do not change correctly.

[Code]XYY:Data read from the LS's

X:

1-> Forward rotation

2-> Reverse rotation';

YY: Pallet number

- (3) Character-string 'COM' The pallet number of the pallet which is being positioned is specified while pallet indexing is stopped.

[Code] Pallet number designated

- (4) Character-string 'PLEX' The pallet presence detection limit switch (at the pallet magazine side) is not turned on when the pallet loading cycle to the setup station is completed.

★ 2432 **ATC tool change arm door**

The door close confirmation limit switch is not turned on within five seconds after the ATC tool change arm door close command has been given.

★ 2433 **Coolant unit**

For coolant tanks with a filter unit, the coolant level of the dirty oil tank reaches the upper level causing the float switch to turn on.

★ 2434 **Ball screw lube confirmation**

An alarm occurred with the ball screw lubricating unit.

[Code]

None->The ball screw lubrication motor has not been turned on for more than 70 minutes.

1-> The ball screw lubrication pressure confirmation switch is not off when the ball screw lubricating motor is turned on.

2-> The ball screw lubrication pressure confirmation switch is not turned on 30 seconds after the ball screw lubricating motor is turned on.

★ 2435 **Work washing gun motor overload**

The overload relay for the workpiece washing gun motor is tripped.

★ 2436 **Active tool NG2**

This alarm occurs when the life of a tool designated by a T code ends, and there is no available spare tool.

[Code]AABB:

AA: Tool change classification

Bit7-> NG3

Bit6-> NG2

Bit5-> NG1

Bit3-> SP

Bit2-> ORG

Bit1-> Commanded tool

BB: Holding the alarm cause

Bit7-> User NG

Bit5-> Tool breakage detection (touch type)

Bit4-> Tool breakage detection (AE)

Bit3-> Tool overload (torque type)

Bit2-> Tool overload (MOP)

Bit1-> Tool wear (MOP)

Bit0-> Tool life

[Measures to Take]

Replace the life expired tools with new tools and set the life and remaining time data on the tool management function screen and set OK for OK/NG flag column.

[Related Specifications] Tool management function

★ 2437 **Improper M code**

There is an error in M code designation method.

The head indexing command (M code) is designated for a double-column machining center although the swivel head is not indexable.

[Code]

1-> The spindle is rotating.

2-> The Y-axis is outside the head indexable range.

4-> The door cannot be opened when the M33 code (door open) is executed because the Y-axis is within the door open inhibit.

5-> M144 (touch sensor unit advance) cannot be specified without locating the X-axis at the touch sensor zero point because it will cause the X-axis to collide with the coolant trough. zone (set with a parameter).

6-> Concerning simplicity 5 surface attachment automatic formatting, W shaft performed attachment gyration instruction (M73 - M76, M94, M95) in a gyration possibility excess.

7-> M339 order was performed in spindle revolution.

8-> M333 When (present tool entry order) was done,

1) A next tool was not TN tool.

2) A next tool met "0".

3) A present tool number was not "0".

★ 2438 **Data word: 'TN'**

For the tool management function of machines which do not use the ATC, the TN command value (TN=\*\*) is outside the allowable range. (\*\*: 0 to the number of tool offset pairs)

[Code]

TN-> command value in hexadecimal

★ 2439 **Spindle orientation gear**

★ 2440 **Axis lubrication cycle**

★ 2441 **Wrong actual number**

The tool group number in the block to which program execution has returned by sequence restart or in the program history where STM lock has been released (programmed tool group number) differs from that of the active tool. (The tool group number must be registered even when the tool command is given by the tool name.)

[Index] None

[Character-string] None

[Code]

1-> Mismatch is found at STM lock release

2-> Mismatch is found at sequence restart

[Related Specifications] Tool ID function

★ 2442 **Pattern cycle command miss**

There is an error in the data which is designated in interactive program B (solid shape machining/ridge machining cycle).

There is erroneous data in interactive program B (solid shape machining/ridge machining cycle).

[Code] XX:

11-> Data for designating a convex quadrangular pyramid is erroneous.

12-> Data for designating a concave quadrangular pyramid is erroneous.

13-> Data for designating a convex circular cone is erroneous.

14-> Data for designating a concave circular cone is erroneous.

15-> Data for designating a convex semi-sphere is erroneous.

16-> Data for designating a concave semi-sphere is erroneous.

21-> Data for designating a convex horizontal circular cone is erroneous.

22->

1) The recalculated arc radius of the convex horizontal circular cone has a minus value.

2) The Z-coordinate value is outside the following range:  $-D/2 < Z < \text{Radius of the smaller arc}$ .

23-> Data for designating a concave horizontal circular cone is erroneous.

24-> The cutter radius or finishing stock is too large in the data for designating a convex horizontal circular cone.

27-> Data for designating 3-D slant surface interpolation is erroneous.

28-> Data for designating cam curve interpolation is erroneous.

30-> The center position of the convex/concave arc in ridge machining causes the system error. (Start the program by pressing the RESET button.)

31-> Data for designating a straight line in ridge machining is erroneous.

32-> Data for designating a convex arc in ridge machining is erroneous.

33-> Data for designating a concave arc in ridge machining is erroneous.

34-> Data for designating a straight line and an upper contact circle in ridge machining is erroneous.

★ 2443 **Cooling unit**

An alarm occurred with the cooling unit.

[Code]

None->The ball screw lubricating oil cooling operation on signal has been off for more than one second while the ball screw lubricating oil cooling unit is operating.

1-> The ball screw lubricating oil level low signal has been on for more than three seconds while the ball screw lubricating oil cooling unit is operating.

- 2-> The ball screw lubricating oil level normal signal has been off for more than three seconds while the ball screw lubricating oil cooling unit is operating.
- 3-> On S-20, the oil temperature regulator for ball screw and C-axis is in abnormal state. Or, the ball screw cooling unit operation signal (BAC/) has been OFF for more than one second.

**★ 2444 Linear positioning limit**

While the linear positioning function is executed, a designated positioning point of an axis exceeds the limit.

**★ 2445 Data word: 'RM'**

An improper AT number designated with the RM AAC magazine index command.

[Code]

RM-> command value in hexadecimal

**★ 2446 Active tool No. BCD input data NG**

**★ 2447 Synchronous tap's torque low**

The spindle load torque has exceeded the set value during the execution of synchronized tapping.

[Probable Faulty Locations]

Overloaded cutting

Setting or selection of the tapping torque monitoring parameter is incorrect.

The startup current ineffective time determined by the NC optional parameter Nos. 61 and 62 is improper.

**★ 2448 Coordinate change instruction missing**

The 3-D coordinate conversion command (G69) is improper.

[Code]

- 1-> Addresses X, Y, Z, P, Q, R, and address H are designated simultaneously following G69.
- 2-> The value for the H command which is designated following G69 is other than 1.
- 3-> No rotary axis command (P, Q, or R) is designated following G69, or more than one rotary axis command is designated in one block.
- 4-> The axis command is canceled during coordinate conversion, or "G69 H1" is designated while no data is set at the coordinate conversion parameter.

[Measures to Take] Correct the faulty command.

**★ 2449 Coordinate change operation**

An error during floating-point arithmetic in coordinate conversion

When obtaining values for the variables used in coordinate conversion, each variable is first converted into a floating point, and, after a value has been obtained, it is converted into an integer.

[Code] XYY:

X:

- 1-> Matrix calculation error(automatic operation)
- 2-> Coordinate conversion calculation error(automatic operation)
- 3-> Master axis calculation error(manual operation) 1
- 4-> Master axis calculation error(manual operation) 2
- 5-> Matrix calculation error(manual operation)
- 6-> Coordinate conversion calculation error(manual operation)
- 7-> Coordinate conversion calculation error(manual operation)

YY: (1 byte) - Calculation error status in floating point arithmetic:

Bit5-> Trigonometric function angle overflow

Bit4-> Division by "0"

Bit3-> Calculation of the root of a negative number

Bit2-> Exponential overflow

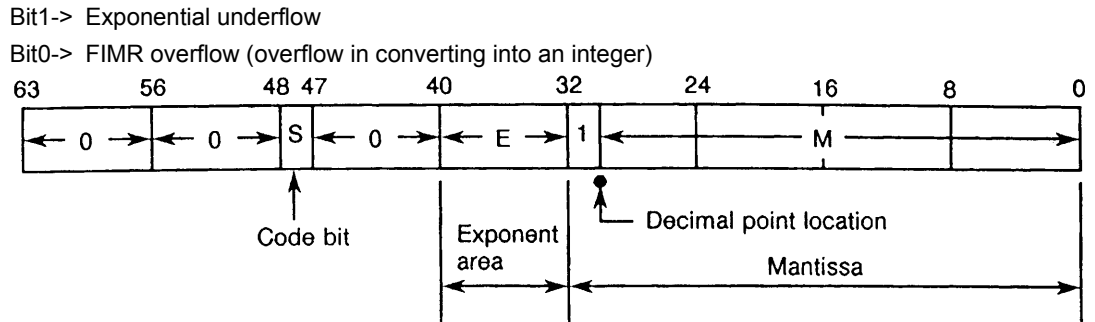

$$0 \leq E \leq 255$$

↑  
128 as the reference

E < 0 . . . . Exponential underflow  
E > 256 . . . Exponential overflow

$$\underline{(-1)^S \cdot 1.M \cdot 2^{(E-128)}}$$

★ 2450 **Cylindrical side cutting unit convert**

The following range has been exceeded during conversion "from length to angle" or "from angle to length" in cylindrical side

surface machining:

-99999999 - 99999999 [microns, 1/1000°, 1/10000°]

[Code]

- 1-> During calculation in cutter radius compensation
- 2-> During calculation in area machining
- 3-> During arc radius calculation

[Measures to Take]

- Make sure that G175 is designated correctly.
- Change the program by shifting the zero point so that the command has a smaller value.

★ 2451 **Spindle wiring change command**

★ 2452 **Pallet discrimination NG**

When the pallet is checked according to the "M289 RP=\*" command, the pallet being checked is not the designated one.

[Measures to Take]

Press the RESET button, and execute the command again. At this time, check the VPLTN system variable to determine the pallet type.

★ 2453 **Data word: 'RP'**

RP command value is improper.

[Code] Hexadecimal of RP command value caused an alarm

[Measures to Take]

Press the RESET button and designate again.  
Designate 1 or 2 for an RP command value.

★ 2454 **Data word: WP**

★ 2455 **Update**

An error caused during automatic selection of a schedule program precludes the completion of program selection.

[Code] X:

- 1-> Not in the automatic operation mode
- 2-> Command buffer is not empty.
- 3-> Error when reading a main program with the PD0 task.

[Code] XYZZAABB:

1) X=1 Automatic selection alarm

BB:

- Bit0-> Designated schedule program file not found
- Bit1-> Designated main program file not found
- Bit2-> Designated subprogram file not found
- Bit3-> Designated main program not found
- Bit4-> Designated subprogram not found
- Bit5-> M02 or M03 not found until the end of main program
- Bit6-> RTS not found until the end of subprogram
- Bit7-> Entire program cannot be stored in program buffer.

AA:

- Bit0-> More than 31 main program sequence names
- Bit1-> Sequence name containing more than five characters including "N"
- Bit2-> No subprogram name following CALL statement
- Bit3-> Subprogram name containing more than five characters including "O"
- Bit4-> Program name of G, M code macro not defined
- Bit5-> More than 63 subprograms called
- Bit6-> One block containing more than 156 characters
- Bit7-> Main file name and extension containing more than 20 characters

ZZ:

- Bit0-> Main file name and extension beginning with a number
- Bit1-> Designated device name containing more than 3 characters, or no colon ":" entered following a device name
- Bit2-> No character "O" at the beginning of the designated program name
- Bit3-> A character other than alphanumeric included in the designated program name
- Bit4-> Designated program name containing more than 5 characters including character "O"
- Bit5-> More than 16 options designated
- Bit6-> There is no multi-volume identifier within the first 8 characters of main file name.
- Bit7-> There is a program selection request while a schedule program is executed.

Y:

- Bit0-> There is a program selection request while a main program is executed.
- Bit1-> An attempt was made to select a program in the mode which is not included in the specification.
- Bit2-> The multi volume file order number exceeds 99.
- Bit3-> Floppy disk is designated for a device name.

2) X=2 Faulty memory

An asterisk ( \* ) or a question mark ( ? ) contained in the designated file name

[Measures to Take]

Correct the program for which selection is attempted.

[Related Specifications] Schedule program specification

**★ 2456 Manual skip function**

**★ 2457 Interactive gauging: touch probe**

While an axis is being fed (skip feed) in the workpiece gauging cycle of the semi-automatic mode (interactive) gauging, the touch probe emergency signal is turned on.

[Probable Faulty Locations] Battery error of the touch probe

[Related Specifications] Interactive gauging function

★ 2458 **Interactive gauging: impossible**

While an axis is being fed (skip feed) in the workpiece gauging cycle of the semi-automatic mode (interactive) gauging, it is determined that skip feed cannot be continued any more.

An alarm is generated after the axis has been returned to the approach start point.

[Code]

- 1-> There is no contact detected while the axis has been fed by the maximum skip feed amount in the first approach.
- 2-> The axis has reached the travel limit during the first approach.
- 3-> There is no contact detected while the axis has been fed by the maximum skip feed amount in the second approach.
- 4-> The axis has reached the travel limit during the second approach.
- 5-> A contact is detected when the spindle axis is being fed to the gauging point level in the OD center gauging cycle.
- 6-> The axis has reached the travel limit while the spindle axis is being fed to the gauging point level in the OD center gauging cycle.

[Probable Faulty Locations] Error in the probe skip start position

[Measures to Take]

Restart the cycle after resetting the control and confirming the positional relationship between the workpiece and probe.

[Related Specifications] Interactive gauging function

★ 2459 **Attachment index unusual**

After the completion of the spindle indexing, which is carried out prior to the start of attachment indexing, the difference between the active value and the previous command value is greater than  $\pm 5^\circ$ .

★ 2460 **Data word: 'RI'**

The RI command (attachment B-axis angle command) value is other than 0, 30, 45, 60, or 90.

[Code] Hexadecimal of RI command value caused an alarm

★ 2461 **Chamfering commands illegal**

[Code] XYYZZ:

X:

- 1-> Data word

When chamfering command at arbitrary angles is designated, the relevant sequence or the next sequence read in advance has a wrong command format.

YY = 00

ZZ:

- 01-> Chamfering command is designated in a mode other than G01 mode.
- 02-> In the sequence designating the chamfering command (1st sequence), the start and end points are the same.
- 03-> In the sequence read in advance (2nd sequence), the start and end points are the same.
- 04-> No L command is designated.
- 05-> The L command value is out of the setting range (0 to 99999999).
- 06-> The Q command value is out of the setting range (0 to 99999999).
- 07-> The prefetched sequence is neither G00 nor G01 mode.
- 08-> A chamfering command was specified during execution of a macro command. Or, a coordinate calculation command was specified in the prefetched sequence.
- 09-> The planes selected by sequence No. 1 and sequence No. 2 are not the same.



0A-> Chamfering was attempted on a plane including the rotary axis in a mode other than cylindrical side surface machining (G175).

X=2 Data word: calculation

A calculation error occurred during shape definition by an arbitrary angle command.

YY=02 Calculation for obtaining the coefficient of the straight line passing through the specified point and the point specified by the previous sequence (1st straight line)

YY=03 Calculation for obtaining the coefficient of the straight line passing through the specified point and the point specified by the prefetched sequence(2nd straight line)

ZZ:

bit0-> Overflow in conversion of a value into an integer

bit1-> Exponent underflow

bit2-> Exponent overflow

bit3-> Attempt to calculate the square root of a negative value

bit4-> Attempt to divide a value by 0

bit5-> Angle overflow in calculation of Sin,Cos,Tan,Cot values

X=3 Calculation for chamfering

An error occurred during calculation for automatic chamfering at any angles.

YY:

01-> Calculation of chamfering start point

02-> Calculation of chamfering end point

03-> Calculation of rounding arc center

04-> Calculation of rounding start and end points

05-> Calculation for determining chamfering direction

ZZ: Same with ZZ displayed when X=2

X=4 Chamfering

Chamfering is impossible because the corner to be chamfered has an angle of 180°.

YY=00

ZZ=00

X=5 Chamfering amount>travel amount

Chamfering is impossible because the chamfering amount is larger than the travel to the specified point.

★ 2462 Spindle neutral gear select time over

★ 2463 Tool clamp/unclamp time over

★ 2464 Swivel head index unusual

★ 2465 DF

★ 2466 L (Area machining)

★ 2467 Spindle deflection offset position (Fixed cycle)

★ 2468 D (Fixed cycle)

★ 2469 Reference position (Home position)

When the FS-9 tape convert function is activated with the NC optional parameter (bit) No. 47 bit 7 set to "1", the G27 command value does not match the reference return position.

[Probable Faulty Locations]

G27 command value is wrong or the parameter is wrongly set.

[Measures to Take]

Designate the correct command or match the reference return condition to the command by correcting the set value at the NC optional parameter (bit).

[Related Specifications]

FS-9 tape convert function (used only by the user)

★ 2470 **DATA word:'NP'**

The NP command value for specifying the next pallet is other than 1 to 14.

[Code] Alarm-caused NP command value in hexadecimal

★ 2471 **Cutting feed impossible**

G1, G2, or G3 command was issued while an axis is on its travel limit.

[Code] 1

★ 2472 **Attachment Control**

A BC-axis attachment command was issued while the attachment is not in movable condition.

[Code]

1-> Attachment B-axis command

2-> Attachment C-axis command

[Measures to Take]

Return the BC-axis attachment to its normal state before issuing the command.

★ 2473 **EC reset sequence**

NC reset processing by EC software took 5 seconds or over.

The software is probably waiting for the answer from VAC.

[Measure to Take] Check the microswitches on the VAC.

★ 2474 **Machine axis travel limit over**

A machine axis has exceeded its travel limit.

[Code]

1-> Software limit was exceeded.

None->A travel end LS was hit.

★ 2475 **Sub command except STM invalid value**

A sub command value other than STM commands is too large.

[Code] Sub command (except STM) type number: 1 to 8

[Probable Faulty Locations]

Sub command value or magnification other than STM command

[Measures to Take]

Issue a sub command so that its command value multiplied by magnification can be expressed in 4 bytes. For details, consult the machine maker.

[Related Specifications] PLC specification

★ 2476 **Inductosyn mode change time over**

Though the Inductosyn ON/OFF switch is turned ON, no answer is returned from the corresponding SVP.

[Index] AXIS

[Probable Faulty Locations]

1-> SVP of the relevant axis

2-> Control software such as that for NC

★ 2477 **arc I,J command error**

The arc command specified with B number for vector radius compensation does not include either I or J value.

[Code] 200

[Probable Faulty Locations] Arc command program

[Measures to Take] Correct the program.

★ 2478 **Barrier**

The axis command specified in AUTO or MDI mode causes the axis to enter the interference barrier area.

[Code]

1-> Both X-axis and B-axis enter the barrier.

2-> Both Z-axis and B-axis enter the barrier.

[Measures to Take]

Correct the program.

Correct the "Barrier set value" set at the system parameter.

★ 2479 **same block**

The B-axis command is specified simultaneously with the other axis command.

[Code]

1-> Specified with X-axis command.

2-> Specified with Y-axis command.

4-> Specified with Z-axis command.

★ 2480 **Axis change control unusual**

Change of axis control was not normally performed.

[Index] Axis index after control change

[Character-string] Newly controlled axis name

[Code]

1-> Though axis control change ready command was sent to SVP, the SVP sequence counter value did not change to 6 within 1[s].

2-> Though the NC set "7" at SVP sequence counter, the SVP sequence counter did not change to 6 within 1[s].

3-> Though the solenoid output signal was sent, the conformation LS did not come ON within 5[s].

4-> For the axis selected before axis change, the difference between actual moving amount and specified moving amount (a pitch between pots multiplied by an integer) is larger than the half of a pot.

★ 2481 **DATA word:'WS'**

The WS command value is out of the setting range (larger than the maximum number of pallets).

[Code] The alarm-caused WS command value in hexadecimal

[Measures to Take] Check the WS command in the program.

★ 2489 **sensor**

When a fixed cycle was attempted in the fixed cycle mode including tool breakage detection (G195), the sensor was in contact with something or an automated cycle was being carried out.

[Code]

1-> Sensor is in contact with something.

2-> An automated cycle is under execution.

[Probable Faulty Locations] Defective program or sensor

[Measures to Take]

In the case of code 1, separate the machine from the workpiece.

If the alarm still occurs, check the sensor unit or TFP board.

In the case of code 2, cancel the automated cycle.

★ 2490 'LP'

Improper data is given to the LP command which specifies the anticipated position on the workpiece in the fixed cycle mode including tool breakage detection (G195).

[Code]

1-> Defective LP command

2-> No LP command is given before the fixed cycle in the fixed cycle mode with tool breakage detection (G195).

[Probable Faulty Locations] Programming error

[Measures to Take] Correct the program.

★ 2491 'LD'

Improper data is given to the LD command which specifies the tolerance in the fixed cycle mode including tool breakage detection (G195).

[Code]

1-> Defective LD command

2-> The specified LD command has a negative value.

[Probable Faulty Locations] Programming error

[Measures to Take] Correct the program.

★ 2492 I-PACK special G code

A G code not executable in I-PACK operation was specified.

[Code] Internal G code

[Probable Faulty Locations]

Commands not executable in I-PACK mode such as COPY, COPYE, IF, and GOTO

Special G code

Operation Example: GOTO N001 in I-PACK mode

[Measures to Take]

Use these special codes in automatic operation mode.

★ 2493 READ/WRITE buffer over

In execution of READ/WRITE command, data to be handled exceeds 160 bytes.

[Code]

1-> In execution of READ command

2-> In execution of WRITE command

★ 2494 READ/WRITE device NO.

A wrong device number was specified for executing READ/WRITE command.

[Code]

1-> The device name was not specified with a number.

2-> The specified device number is other than 0 to 4.

★ 2495 READ/WRITE data

The READ/WRITE command has wrong data.

[Code]

1-> Parity error occurred in data reading.

2-> The WRITE data contains a transfer end code.

★ 2496 **GET/PUT buffer over**

In execution of GET/PUT command, the number of data is too small or too large.

[Code]

- 1-> In execution of GET command, the number of received data is larger than the number of readout pointers.
- 2-> In execution of PUT command, the data size exceeds 160 bytes.

★ 2497 **GET/PUT number of figure**

In execution of GET/PUT command, the number of digits was wrongly specified.

[Code]

- 1-> In execution of GET command
- 2-> In execution of PUT command

★ 2498 **GET/PUT variable**

In execution of GET/PUT command, the data includes improper elements.

[Code] XYZ

X:

- 1-> In execution of GET command
- 2-> In execution of PUT command

★ 2499 **GET numeric data**

During execution of GET command, an error was found in numerical data.

[Code]

- 1-> Elements other than number or space were found.
- 2-> Two or more decimal points were found.
- 3-> A figure with 10 or more digits was found.

★ 2500 **READ communication error**

An error occurred during data reception.

[Character-string] Error number (4 digits)

[Code] Status code detected on occurrence of the error

★ 2501 **WRITE communication error**

An error occurred during data transmission.

[Character-string] Error number (4 digits)

[Code] Status code detected on occurrence of the error

★ 2502 **READ/WRITE no function**

The READ/WRITE command specification (user task 2) is not provided.

★ 2503 **GET/PUT no function**

The GET/PUT command specification (user task 2) is not provided.

★ 2504 **DATA word: 'BT'**

The BT value, B-axis angle command on DCC, is not in the range from 0° to 90°.

Or, an angle not permitted in the specification was specified. (B-axis angle: 15° pitch)

[Code] Alarm-caused BT command value in hexadecimal

[Probable Faulty Locations] Programming error

★ 2505 Bolt hole chamfering error

The bolt hole chamfering command was wrongly specified.

[Code]

- 1-> The X-axis command (machine coordinate) exists inside the hole specified for rear chamfering (bolt hole chamfering).
- 2-> A chamfering command (G264, G265) was specified in the arc mode (G2, G03).
- 3-> A chamfering command was specified in feed per revolution (G95) mode.
- 4-> A bolt hole chamfering command (G264, G265) was specified while the Y-axis was not located at 0 position (machine coordinate).

[Probable Faulty Locations] Programming error

★ 2506 Profile generation error

The profile generation command was wrongly specified.

[Code]

- 11-> The profile generation ON command (G138) was specified during a fixed cycle.
- 12-> The profile generation ON command (G138) was specified during cutter radius compensation.
- 13-> The profile generation ON command (G138) was specified during three-dimensional tool length offset.
- 14-> The profile generation ON command (G138) was specified during area machining.
- 15-> The profile generation ON command (G138) was specified during home positioning.
- 16-> The profile generation ON command (G138) was specified when a local coordinate system was selected.
- 17-> The profile generation ON command (G138) was specified while the copy function was activated.
- 18-> The profile generation ON command (G138) was specified during enlargement or reduction of the drawing.
- 19-> The profile generation ON command (G138) was specified during slope machining.
- 1A-> The profile generation ON command (G138) was specified during cylindrical side machining.
- 1B-> The profile generation ON command (G138) was specified in the incremental command mode.
- 1C-> The profile generation ON command (G138) was specified on a plane (selected by G18, G19) other than G17 plane.
- 1D-> The profile generation ON command (G138) was specified during designation of axis names.
- 1E-> The profile generation ON command (G138) was specified in the macro mode.
- 1F-> The profile generation ON command (G138) was specified while the Y-axis was not located at 0 position (machine coordinate).
- 21-> A C-axis command was specified during profile generation.
- 22-> A plane other than G17 was selected (by G18, G19) during profile generation.
- 23-> The coordinate conversion command (G69) was specified during profile generation.
- 24-> The cylindrical side machining command(G175) was specified during profile generation.
- 25-> The axis name designation command was specified during profile generation.
- 26-> The rear chamfering (bolt hole chamfering) command was specified during profile generation.
- 27-> The profile generation conversion start command is not followed by a block including rapid traverse (G00).
- 28-> With G01 special movement command, a command other than X-Y command such as Z-axis movement was specified.
- 30-> The profile generation OFF (G137) command was given to the index table rotary axis with limited rotation range.
- 31-> The profile generation OFF command (G137) was specified during a fixed cycle.
- 32-> The profile generation OFF command (G137) was specified during cutter radius compensation.
- 33-> The profile generation OFF command (G137) was specified during three-dimensional tool length offset.
- 34-> The profile generation OFF command (G137) was specified during area machining.
- 35-> The profile generation OFF command (G137) was specified during home positioning.

- 36-> The profile generation OFF command (G137) was specified when a local coordinate system was selected.
- 37-> The profile generation OFF command (G137) was specified while the copy function was activated.
- 38-> The profile generation OFF command (G137) was specified during enlargement or reduction of the drawing.
- 3B-> The profile generation OFF command (G137) was specified in the incremental command mode.
- 3E-> The profile generation OFF command (G137) was specified in the macro mode.

[Probable Faulty Locations] Programming error

**★ 2509 Fine profile:invalid start point**

When high-speed profile generation (TPRF) was specified, the actual position did not match the first point of each axis specified in AP data.

[Code] AP data indicating the first point in hexadecimal

[Probable Faulty Locations] Faulty program

[Program Example]

TPRF FN[A.CAP]

Actual X-axis position=100,first X-axis point data specified in  
A.CAP=150 -> Not the same.

[Measures to Take] Correct the program.

[Related Specifications] Scroll machining specification

**★ 2510 Illegal AP file**

AP file specified in TPRF is defective.

[Code]

1-> The parameter sampling cycle on the AP file specified in TPRF is not  $160 \cdot 2^{**n}$  ( $n = 0-3$ ).

[Probable Faulty Locations] Faulty program or AP file

[Program Example]

TPRF FN[A.CAP]

Sampling cycle specified in A.CAP is 170  
-> Not equal to  $160 \cdot 2^{**n}$ .

[Measures to Take] Correct the program or AP file.

[Related Specifications] Scroll machining specification

**★ 2511 Fine profile: 'F' command**

The high-speed profile generation (TPRF) command was specified with improper feedrate (F).

[Code] F command in hexadecimal

[Probable Faulty Locations] Faulty program

[Program Example]

TPRF F=-10 (A negative value is specified with F command.)

[Measures to Take] Check the program to correct errors.

[Related Specifications] Scroll machining specification

**★ 2512 AP file transfer failure**

An error occurred during file transfer/generation in execution of TPRF.

[Code]

1-> An error occurred when generating an AP file in MD1.

[Related Specifications] Scroll machining specification

★ 2513 **Fine profile:running method**

High speed profile generation (TPRF) command was specified in a method other than "operation method A".

[Code]

1-> High speed profile generation (TPRF) command was specified without using "operation method A".

[Probable Faulty Locations]

- 1) A program other than option A (method A) was specified in program selection.
- 2) Data other than 0 (method A) was set at the NC optional parameter word No. 11.

[Program Example]

1-1)PS A. MIN;B (method B is specified)  
1-2)SS A. SDF  
PSELECT A.MIN;B in A.SDF (method B is specified)

[Measures to Take]

- 1) Specify A as an option for program selection or do not specify any option.
- 2) Set 0 (method A) at the NC optional parameter word No. 11.

[Related Specifications] Scroll machining specification

★ 2514 **TPRF mode**

High speed profile generation (TPRF) command was specified in any of the following modes.

[Code]

- 1-> Cutter radius compensation mode
- 2-> 3-D offset mode
- 3-> Drawing enlarge/reduce mode
- 4-> Drawing rotational shift mode
- 5-> Machine coordinate mode
- 6-> Fixed cycle mode
- 7-> Tolerance control mode
- 8-> Slope machining mode
- 9-> Cylindrical side machining mode
- 10-> Rotary table multi-turn mode (C-axis)
- 11-> Axis command cancel mode (axis used for TPRF)

[Probable Faulty Locations] Faulty program

[Measures to Take] Check the program to correct errors.

[Related Specifications] Scroll machining specification

★ 2515 **TPRF:mismatch tool position**

Zero offset amount (positional difference) between the work coordinate system and local coordinate system does not agree with the tool position data specified in the AP file.

[Code]

- 1-> The tool offset direction specified in the tool position data differs from that specified in the local coordinate system
- 2-> Though the tool position data is XP or XN, the Y-axis offset amount in the local coordinate system is not 0. Or, when the tool position data is YP or YN, the offset amount in the local coordinate system is not 0.

[Probable Faulty Locations] Faulty program

[Program Example]

- 1) G11X100 (positive offset direction)  
Tool position data in A.CAP is XN (negative offset direction)
- 2) G11X100Y100 (Y-axis offset amount is not 0.)



Tool position data in A.CAP is XP.

[Measures to Take] Correct the program or AP file.

[Related Specifications] Scroll machining specification

**★ 2516 TPRF:tool shift direction**

A remaining moving distance is specified for the axis which is commanded not to move by the tool position data in the AP file.

[Code]

1-> Though the tool position data is for XP or XN, the remaining moving distance is given to Y-axis. Or, though the tool position data is for YP or YN, the remaining moving distance is given to X-axis.

2-> Though no tool position data is specified, a remaining moving distance is given to X- or Y-axis.

[Probable Faulty Locations] Faulty program

[Program Example]

1) TPRF X=10 Y=10 (Y-axis remaining distance is not 0.)

Tool position data in A.CAP is XP.

2) TPRF X=10 (X-axis remaining distance is not 0.)

No tool position data is specified in A.CAP.

[Measures to Take] Correct the program or AP file.

[Related Specifications] Scroll machining specification

**★ 2517 READ/WRITE No empty SAT**

A file cannot be created using FWRITC or WRITE C command because the output device does not have enough free area.

[Code] Generated error No. in hexadecimal

**★ 2518 READ/WRITE File open**

This alarm occurs in file operation using FOPENA/B or FWRITC command.

[Code]

1-> FOPENA/B was used to open two or more files.

2-> FWRITC was used to open two or more files.

3-> The writing file already exists.

4-> The reading file is not found.

5-> READ command was given without opening a file.

6-> WRITE command was given without opening a file.

7-> File closing failed.

8-> The file close command is normally specified.

9-> File attribute error: the reading file is not a sequential one.

4 digits (or 3 digits)-> generated error number in decimal

**★ 2519 Unusable PRINT request**

A PRINT command was given during activation of READ/WRITE or GET/PUT function.

[Measures to Take]

Do not issue any PRINT command during activation of READ/WRITE or GET/PUT function.

**★ 2520 Cycle time over**

The M command operation was not completed within the time set at the machine user parameter word No. 30.

[Character-string]

None (Desired character-string can be displayed by a user-selectable specification.)

[Code]

None (Desired code can be displayed by a user-selectable specification.)

[Probable Faulty Locations]

Refer to the instruction manual for user-selectable specifications.

[Related Specifications]

Instruction manual for user-selectable specifications

**★ 2521 Cooling tank unit abnormal**

S-20 ... An abnormality occurred on the coolant tank.

[Code]

1-> On S-20, the cooling unit motor normal signal has been OFF for more than one[s]; one of the motors in the coolant unit is overloaded.

2-> On S-20, the coolant unit sludge conveyor normal signal (CSL) has been OFF for more than one[s].  
The sludge conveyor is not normally rotating in the coolant unit.

[Probable Faulty Locations] Coolant tank unit

**★ 2522 Spindle overload**

The load applied to the spindle has exceeded the value set as an overload monitor limit.

[Code]XXXXYYYY

XXXX: Parameter number for monitoring overload

YYYY: Overload rate (%) detected on occurrence of the alarm

**★ 2523 Remote buffer operation error**

Something was wrong with the part program of a remote buffer operating.

[Code] X

X=1-> There was not a receiving program at all.

X=2-> There was not head % block.

X=3-> There was only head % block.

X=4-> EOF In it is made to be done (If) code nothing, part program block data has ended.

X=5-> Record length is too long.

X=6-> In a program, IF or GOTO statement fitted.

X=7-> At the time of cycle start, an adaptive control communication was not normal.

X=9-> MODIN/MODOUT instruction fitted in a program.

X=A-> On a FTP function busy, remote buffer operation was turned into use.

**★ 2524 No magazine tool to be selected**

The M06 command is invalid because all the tools in the specified tool group, whose number has been previously set by T command, are faulty.

[Index] None

[Character-string]

Tool group number for TG command

Tool group number and tool serial number for TF command

Tool name for TD command

[Code] Faulty tool number in hexadecimal

[Probable Faulty Locations]

All the tools in the specified tool group are faulty.

The magazine has no specified tools.

[Measures to Take]

Set nondefective tools of the specified group number in the magazine.

★ 2525 **Tool input NO.**

Tool command is wrongly specified.

[Index] None

[Character-string] None

[Code]

- 1-> T command (T\*\*\*\*) was specified in T command disabled state.
- 2-> T command format is wrong.  
TG = (G and = are spaced out.)  
TF =  
TD =  
TGA (The used local variable is headed by TG, TF, or TD.)  
TG, TF, or TD command has no "=".
- 3-> An invalid character is used.
- 4-> TG, TF, or T command is used though the tool name system is selected.  
TD command is used though the tool number system is selected.  
Tool No./name selection parameter (NC optional parameter bit No. 57 bit 4)

★ 2526 **Tailstock quill over advance**

Tailstock has advanced excessively.

If this alarm occurs during execution of main program, alarm A will result.

[Index] None

[Character-string] None

[Probable Faulty Locations]

- 1) Since being located in a distant position, the tailstock actuated the overtravel limit switch before touching the workpiece.
- 2) A tailstock advance command was issued without loading a workpiece.

★ 2527 **Tailstock quill condition**

Spindle rotation command was issued when the tailstock was not in the specified position.

Tailstock advance/retract command was issued while the spindle was rotating.

[Index]None

[Character-string]None

[Code]

- 1-> Tailstock advance/retract command issued during spindle rotation.
- 2-> Spindle rotation command issued without the tailstock in position.

[Probable Faulty Locations] Check if the program operation is correct.

★ 2528 **Chuck condition**

Spindle rotation command was issued without clamping the chuck.

Chuck open/close command was issued during spindle rotation.

[Index] None

[Character-string] None

[Code]

- 1-> Chuck open/close command during spindle rotation
- 2-> Spindle rotation command issued with the chuck open

[Probable Faulty Locations] Wrong program operation

[Measures to Take] Check if the program operation is correct.

★ 2529 R/W head time over

Go-ahead-backspace operation of R/W head was not completed within a setting time of parameter.

[index] None

[character string] None

[Code]

- 1-> R/W head operation was not completed within a setting time of MC user parameter No. 51.
- 2-> A backspace operation of R/W head was not completed within a setting time of MC user parameter No. 52.

[Probable Faulty Locations]

Inferiority of go-ahead-backspace solenoid of R/W head, a limit switch In terms of set value of MC user parameter NO. 51, 52 zero

[Measures to Take]

Adjustment of go-ahead-backspace solenoid of R/W head, a limit switch or switching.  
Setting of MC user parameter NO. 51, 52.

★ 2530 DNC-DT Path name

Program selection by DNC-DT failed because of faulty file name.

The number of characters composed of device name, path name, and file name exceeds 120.

[Index] None

[Character-string] None

[Code] X

- X=1: Faulty file name
- X=2: Faulty extension code
- X=3: Over 120 characters
- X=5: A device name other than HD0 was specified for file deletion.

[Probable Faulty Locations] Schedule program

[Measures to Take] Review the schedule program.

★ 2531 DNC-DT Program select

An alarm occurred during program selection by DNC-DT.

[Index] None

[Character-string] None

[Code] YY: YY application error NO.

- 800000XX: XX communicative error NO.
- FFFFFFFF: NC programmes over of a letter of 1 line are edited
- FFFFFFFFD: program buffer overflow
- XX=6F: Buffer in TCP/IP driver is too small.
- XX=72: Descriptor transferred to TCP/IP driver is faulty.
- XX=73: Parameters transferred to TCP/IP driver is faulty.
- XX=74: There is no empty port in the shared memory.
- XX=75: DNC is not connected.
- XX=7B: The abort command was ignored.
- XX=7D: "ftp\_ms\_open" abnormal termination
- XX=7E: "ftp\_ms\_close" abnormal termination
- XX=7F: "ftp\_ms\_type" abnormal termination
- XX=80: "ftp\_ms\_user" abnormal termination
- XX=81: "ftp\_ms\_pass" abnormal termination

- XX=82: "ftp\_ms\_acct" abnormal termination
- XX=83: "ftp\_ms\_delete" abnormal termination
- XX=84: "ftp\_ms\_fopen" abnormal termination
- XX=85: "ftp\_ms\_fopen\_uni" abnormal termination
- XX=86: "ftp\_ms\_net\_drecv\_f" abnormal termination
- XX=87: "ftp\_ms\_net\_dsend\_f" abnormal termination
- XX=88: "ftp\_ms\_fclose" abnormal termination
- XX=89: "ftp\_ms\_abort" abnormal termination
- XX=8A: "ftp\_ms\_chdir" abnormal termination
- XX=8B: "ftp\_ms\_mkdir" abnormal termination
- XX=8C: "ftp\_ms\_rmdir" abnormal termination
- XX=8D: "ftp\_ms\_pwd" abnormal termination
- XX=8E: "ftp\_ms\_cdup" abnormal termination
- XX=8F: "ftp\_ms\_dopen" abnormal termination
- XX=90: "ftp\_ms\_dread" abnormal termination
- XX=91: "ftp\_ms\_dclose" abnormal termination
- XX=97: IP address abnormal
- XX=98: No IP address
- XX=99: Interruption by time out
- XX=9A: Disconnection command from the remote host
- XX=9B: Abnormal termination of initialization of OS (MORE) on TCP/IP board
- XX=9C: Abnormal termination of initialization of packet driver or TCP/IP module on TCP/IP board
- XX=9D: Abnormal termination of initialization of TELNET client module on TCP/IP board
- XX=9E: Abnormal termination of initialization of TELNET server module on TCP/IP board
- XX=9F: Abnormal termination of initialization of FTP module on TCP/IP board
- XX=A0: Abnormal termination of initialization of socket interface module on TCP/IP board
- XX=A1: Abnormal termination of initialization of TCP/IP board
- YY=13: Incorrect channel number
- YY=16: Closing the communication line was attempted though it had not been open.
- YY=11: Opening the communication line was attempted though it had been open.
- YY=11: The program has been activated.
- YY=06: A time-out occurred in initialization of TCP/IP board (TCP/IP board is inoperable).  
The specified device rejects renaming, canceling its write-protected state, or offering file system information.  
Unknown (unsupported) command was used.
- YY=0D: No communication board is mounted.
- YY=02: The selected program is not found.
- YY=08: Execution failed.

[Probable Faulty Locations] Faulty TCP/IP board; communication error; faulty NC program

[Measures to Take]

- Properly set the OSP environment setting file.
- Correct the communication environment.
- Specify an existing file.

★ 2532 **DNC-DT Program drive**

An alarm occurred during program operation by DNC-DT.

[Index] None

[Character-string] None

[Code] YY:YY application error NO.

FFFFFFF: NC programmes over of a letter of 1 line are edited

FFFFFFE: Inferiority of partial program which an error caused by a search of the several management tables

YY=13: Incorrect channel number

YY=16: Closing the communication line was attempted though it had not been open.

YY=11: Opening the communication line was attempted though it had been open.

YY=06: A time-out occurred in initialization of TCP/IP board (TCP/IP board inoperable).

The specified device rejects renaming, changing its write-protected state, or offering file system information.

Unknown (unsupported) command was used.

YY=0D: No communication board is mounted.

YY=02: The selected program is not found.

YY=08: Execution failed.

[Probable Faulty Locations]

Faulty hard disk, faulty application interface software.

Appearance of the code 1000001 indicates that the too long program is defined by the mnemonics COPY and COPYE in the part program.

[Measures to Take]

Replace or initialize the hard disk.

Review the part program.

**★ 2533 Fixed cycle top face detection error**

In the fixed cycle mode for controlling hole depth (G193), the LL or Z command is wrong or its unit system is wrong.

Offsets such as work zero have not been properly set.

[Index] None

[Character-string] None

[Code]

1-> Though the fixed cycle includes top face detection, hole depth control mode is not established.

2-> Contact position has not been saved.

3-> No contact is made.

[Probable Faulty Locations] Programming error

[Measures to Take] Specify a correct command in the program.

**★ 2534 Fixed cycle 'LL'**

In the fixed cycle mode for controlling hole depth (G193), the LL command or its unit system is wrong. Or, the command was specified for an invalid fixed cycle.

[Index] None

[Character-string] None

[Code]

1-> Defective data

2-> Floating-point calculation error

3-> The specified fixed cycle is other than G73,G81,G82, or G83.

[Probable Faulty Locations] Programming error

[Measures to Take] Specify a proper command in the program.

★ 2535 **Fixed cycle 'LI'**

In the fixed cycle mode for controlling hole depth (G193), the LI command or its unit system is wrong. Or, the command was specified for an invalid fixed cycle.

[Index] None

[Character-string] None

[Code]

XX-> Specified fixed cycle data

XXXXXXXX->LI command value

None->LI command value = 0, or floating-point calculation error

[Probable Faulty Locations] Programming error

[Measures to Take] Specify a proper command in the program.

★ 2536 **Compound fixed cycle 'L' (fixed cycle , Compound fixed cycle)**

Alarm is activated when command value is not as follows:

99999999 >= command value >= 0

(code is hexadecimal of command value.)

★ 2537 **Data word Thread cycle**

[Index] None

[Character-string] None

[Code]

1-> Unsuitable for taper command of thread-cutting fixed cycle.

2-> Unsuitable for shift amount designation of thread-cutting fixed cycle.

3-> Calculation error during pattern check at thread-cutting cycle.

★ 2538 **Data word 'E'**

[Index] None

[Character-string] None

[Code]

2-> 'Feed' became a negative value during thread-cutting feed rate calculation.  
(Unsuitable for 'F' thread pitch command and 'E' variable pitch command.)

Other-> Command value is not within the 5000000 to -5000000 range (code is hexadecimal of command value).

★ 2539 **Axis swivel interlock**

[Index] Axis

[Character-String] None

[Code ]None

In automatic operation/MDI operational mode, a movement order of axis table (A,C) that there is an opportunity outside was performed.

★ 2540 **Compound fixed cycle mode**

[Index] None

[Character-string] None

[Code]

1-> Command was executed at other than normal (drilling fixed cycle, cutter-R comp., 3-D tool offset, area machining).

2-> Command was executed during coordinate calculation function, or during compound fixed cycle operation.

★ 2541 **Compound fixed cycle 'Q' illegal order**

[Index] None

[Character-string] None

[Code]

FFFFFFFF-> There was no 'Q' command.

other-> Command value is not within the following range:  
99999999 >= command value > 0  
(code is hexadecimal of command value.)

★ 2542 **Compound fixed cycle 'QB' illegal order**

[Index] None

[Character-string] None

[Code]

FFFFFFFF-> There was no 'QB' command.

other-> Command value is not within the following range:  
99999999 >= command value > 0  
(code is hexadecimal of command value.)

★ 2543 **Compound fixed cycle 'H' illegal order**

One of the following occurred:

'TAN(H/2) < 0' or 'TAN(H/2) = +-infinity'  
(code is the mantissa of TAN(H/2).)

★ 2544 **Compound fixed cycle 'QA' illegal order**

Command value was not within the following range:  
99999999 >= command value >= 0  
(code is hexadecimal of command value.)

★ 2545 **Compound fixed cycle 'F' illegal order**

[Index] None

[Character-string] None

[Code]

FFFFFFFF-> There was no 'F' command.

other-> Command value was not within the following range:  
99999999 >= command value > 0  
(code is hexadecimal of command value.)

★ 2546 **Compound fixed cycle axis command**

Axis was not designated for the thread-cutting plane.

G17: X(U), Y(V) were not designated.

G18: Z(W), X(U) were not designated.

G19: Y(V), Z(W) were not designated.

[Index] None

[Character-string] None

[Code]

(code axis Nos.: 1:X, 2:Y, 3:Z, 4:4th, 5:5th, 6:6th)



★ 2547 **Compound fixed cycle start point**

[Index] None

[Character-string] None

[Code] None

Compound fixed cycle pattern was unsuitable.

- If cutting end point < start point: Alarm will be activated when the start point is  $\leq$  (cutting end point + thread ridge height).
- If cutting end point  $\geq$  start point: Alarm will be activated when the start point is  $\geq$  cutting end point - thread ridge height).

There are no codes.

★ 2548 **Compound fixed cycle QB-QA less than Q(M294)**

[Index] None

[Character-string] None

[Code] None

When M294 is designated, alarm will be activated when the rough machining depth (QB-QA) is less than Q.

There are no codes.

★ 2549 **Compound fixed cycle I,J,K illegal order**

[Index] None

[Character-string] None

When taper angle 'R' command is designated, alarm will be activated when the taper thread start/end point discrepancy 'J' (K,I) command occurs.

[Code]

- 1-> 'I' command is superfluous.
- 2-> 'J' command is superfluous.
- 3-> 'K' command is superfluous.

★ 2550 **Compound fixed cycle angle**

[Index] None

[Character-string] None

Alarm is activated when  $\text{TAN}(R)$  is [infinity] at TRDL.

Alarm is activated when  $\text{COT}(R)$  is [infinity] at TRDT.

[Code]

According to calculation error status shown below.

Calculation error status

bit 7-> None

bit 6-> None

bit 5-> None

bit 4-> Divisor = 0

bit 3-> Attempt was made to obtain square root of negative value.

bit 2-> Exponent overflow

bit 1-> Exponent underflow

bit 0-> FIMR overflow (overflow during conversion to integer)

;

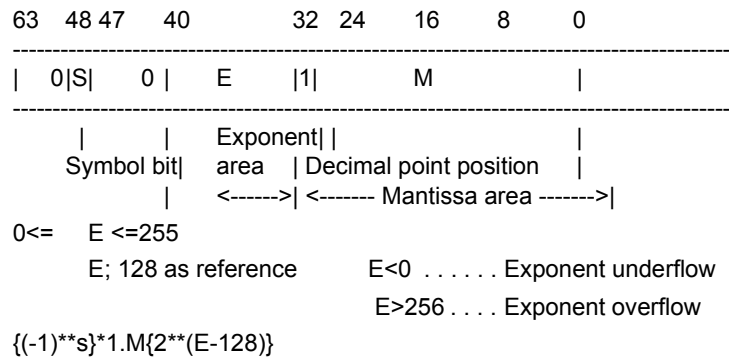

★ 2551 **Compound fixed cycle QA grater than QB**

[Index] None

[Character-string] None

[Code]None

Alarm is activated when QA is greater or equal to QB.

There are no codes.

★ 2552 **Data word: A**

Improper data was specified as a data word A.

[Index] None

[Character-string] None

[Code] Specified A value in hexadecimal

[Probable Faulty Locations]

A command value exceeding the range from -360 to 360 deg was specified in the part program.

Or, the specified command value exceeds the setting range.

[Measures to Take] Specify a proper command in the program.

★ 2553 **Data word: B**

Improper data was specified as a data word B.

[Index] None

[Character-string] None

[Code] Specified B value in hexadecimal

[Probable Faulty Locations]

A command value exceeding the range from -360 to 360 deg was specified in the part program.

Or, the specified command value exceeds the setting range.

[Measures to Take] Specify a proper command in the program

★ 2554 **Data word: C**

Improper data was specified as a data word C.

[Index] None

[Character-string] None

[Code] Specified C value in hexadecimal

[Probable Faulty Locations]

A command value exceeding the range from -360 to 360 deg was specified in the part program.

Or, the specified command value exceeds the setting range.

[Measures to Take] Specify a proper command in the program.

★ 2555 **'NP' Command is invalidity**

In PPC specification time, a next palette order was ordered at the time of PPC entering.

[Index] None

[Character-String] None

[Code] None

[Probable Faulty Locations]

In PPC specification time, a next palette order was ordered at the time of PPC entering.

[Measures to Take] program turne into a regular order.

★ 2556 **CUTTING TOOL GROOVE PROCESS**

A used way of G code of cutting tool groove processing is wrong.

[Index] None

[Character-String] None

[Code]

X=1 The cutting tool grooving G code (G141) was specified without selection of the grooving mode.

X=2 The cutting tool grooving ON command (G142) is specified in the cutting tool grooving mode.

[Probable Faulty Locations] Part program

[Measures to Take] Correct the part program.

★ 2557 **Draw Pump motor overload**

An overload for a drawing up pump motor worked.

[Index] None

[Character-String] None

[Code] None

[Probable Faulty Locations]

- Inferior of a drawing up pump motor
- drawing up pump motor does eye rebuking

★ 2558 **Data word: HS**

An order of HS in inadequate

[Index] None

[Chracter-String]None

[Code]

1-> G15/G16 orders were performed by G41, 42, 44, 51, 11 or COPY mode.

others-> A hexadecimal number of value of HS which was ordered

[Probable Faulty Locations]

- In-G15, 16 order (work coordinate system selection) blocks, HS order (work coordinber) is beyond the range.
- In-G54 to G59 order (tool head revision) blocks, HS order (tool length offset numbere range.
- Or, work seat table system selection is ordered in a tool offset, coordinate movemmatial conversion, a copy mode.

[Measures to Take] A program is turned into a regular order.

★ 2559 **Data word: DS**

An order of DS in inadequate

[Index] None

[Character-String] None

[Code] A hexadecimal number of value of DS which was ordered

[Probable Faulty Locations]

- In G41 to G42 order (tool diameter offset) blocks, DS order (tool diameter offset) is out of the range.

[Measures to Take] A program is turned into a regular order.

**★ 2560 Cycle time over**

The time required to execute one cycle (from cycle start to reception of M02 or M30) has exceeded the time set at the parameter.

[Index] None

[Character-string] None

[Code] None

**★ 2561 Bad direct**

first (interrupt program)

The interrupt program is used in a wrong manner.

[Index] None

[Character-string] None

[Code]

- 1-> A command between M900 and M905 is issued during execution of the interrupt program.
- 2-> No interrupt program (O901 to O905) is registered.
- 3-> RTI command is used in a program other than the interrupt program.

[Probable Faulty Locations]

- Programming error
- Unregistered interrupt programs

[Measures to Take]

- 1) Delete M900 to M905 commands from the interrupt program.
- 2) Register the programs O901 to O905 in the interrupt program file (A.INT). Then, resupply the power.
- 3) Check and correct the program.

**★ 2562 Data word: 'I'**

Improper I command

[Code] Specified I command value in hexadecimal

[Probable Faulty Locations]

The G131 command (Super Hi-NC control mode ON) block has a I command (Shape Reconstruction Utilization mode) of which value is out of the setting range.

[Measures to Take]

Refer to the instruction manual, and order the Shape Reconstruction Utilization mode value which is appropriate for the G131 command block.

**★ 2563 Data word: 'J'**

Improper J command

[Code] Specified J command value in hexadecimal

[Probable Faulty Locations]

The G131 command (Super Hi-NC control mode ON) block has a J command (Machining mode) of which value is out of the setting range.

[Measures to Take]

Refer to the instruction manual, and order the Machining mode value which is appropriate for the G131 command block.

★ 2564 **Data word: 'K'**

Improper K command

[Code] Specified K command value in hexadecimal

[Probable Faulty Locations]

The G131 command (Super Hi-NC control mode ON) block has a K command (Program Filter mode) of which value is out of the setting range.

[Measures to Take]

Refer to the instruction manual, and order the Program Filter mode value which is appropriate for the G131 command block.

★ 2565 **Data word: 'L'**

Improper L command

[Code] Specified L command value in hexadecimal

[Probable Faulty Locations]

The G131 command (Super Hi-NC control mode ON) block has a L command (Maximum Block Length on Shape Reconstruction) of which value is out of the setting range.

[Measures to Take]

Refer to the instruction manual, and order the value of Maximum Block Length on Shape Reconstruction which is appropriate for the G131 command block.

★ 2566 **Coolant flow**

The coolant flow confirmation signal went OFF for ten seconds or over during coolant flow (when the coolant motor is ON).

[Index] None

[Character-string] None

[Code] None

[Probable Faulty Locations]

- Coolant motor
- Coolant flow confirmation PS
- Lack of coolant

★ 2567 **Tool name direct**

[Index] None

[Character-string] None

[Code]

- 1-> The specified tool name is not registered in "Pot & Tool Name Screen".  
Or, the tool number that corresponds to the specified tool is not registered in the "Pot & Tool No. Table".
- 2-> The specified tool name exists in more than one location in the "Pot & Tool Name Screen".

[Probable Faulty Locations]

[Measures to Take]

Register the specified tool name in the "Pot & Tool Name Screen".  
Specify the tool name registered in the "Pot & Tool Name Screen".

★ 2568 **Inverse time feed**

The specified G/M code cannot be used in the inverse time feed mode.

G/M codes not usable in the inverse time feed mode:

Fixed cycle, cutter radius compensation, 3-D tool offset, home position, and area machining

M code not usable in the inverse time feed mode:

M code with home position

[Index] None

[Character-string] None

[Code] None

[Probable Faulty Locations] Program error

[Measures to Take] Correct the program.

★ 2569 **Bad direct: offset data input**

While the TOSNUC88 tape conversion function is ON, data is wrongly set for G58/G59 (programmable data input) and G185 (offset input).

[Index] None

[Character-string] None

[Code]

1-> Offset No. H or D is omitted.

2-> Offset No. H and D are specified simultaneously.

3-> The D command (cutter radius compensation) was specified with G158 (fixture offset input).

4-> The X, Y or Z-axis command was specified with the D command (cutter radius compensation).

5-> The value of H (tool length offset or fixture offset number) does not match the R or X/Y/Z values.

[Probable Faulty Locations] Program error

[Measures to Take] Correct the program.

★ 2570 **Fixed cycle: I**

In TOSNUC 88 tape conversion function, an improper value is entered as "I" for the multiple boring cycle (TOSNUC88 G [Code] 186, and OSP G [Code] 88).

[Index] None

[Character-string] None

[Code]

0-> Calculation error

1-> Value range error

[Probable Faulty Locations] Program error

[Measures to Take] Correct the program.

★ 2571 **Fixed cycle: J**

[Index] None

[Character-string] None

[Code]

0-> Calculation error

1-> Value range error

[Probable Faulty Locations] Program error

[Measures to Take] Correct the program.

★ 2572 **Fixed cycle: K**

In TOSNUC88 conversion function, an improper value is entered as "K" for the following cycles:

Multiple boring cycle (TOSNUC88 G [Code]186, OSP G [Code] 88)

Variable pitch cycle (TOSNUC88 G [Code] 78, OSP G [Code] 79)

Step & pitch cycle (TOSNUC88 G [Code] 77, OSP G [Code] 75)

[Index] None

[Character-string] None

[Code]

0-> Calculation error

1-> Value range error

[Probable Faulty Locations] Program error

[Measures to Take] Correct the program.

★ 2573 **Fixed cycle: Q, K**

In TOSNUC88 conversion function, there is a mismatch between the Q and K values for the variable pitch cycle (TOSNUC88 G [Code] 78, OSP G [Code] 79).

[Index] None

[Character-string] None

[Code] None

[Probable Faulty Locations] Q and K commands in the fixed cycle

[Measures to Take] Correct the Q and K commands.

★ 2574 **Data word: L**

L command is improper.

[Index] None

[Character-string] None

[Code]

0-> Calculation error

1-> Value range error

[Probable Faulty Locations]

In TOSNUC88 tape conversion function, an improper value is specified as the number of times (L) the fixed cycle is repeated.

[Measures to Take] Correct the L command.

★ 2575 **Super Hi-NC control cannot execute**

Super Hi-NC control is attempted though the conditions for enabling such control are not met.:

[Code]

1000000-> NURBS (G132) mode is specified when Super Hi-NC execution mode is OFF.

1010100-> The servo is being adjusted offline in NURBS (G132) mode.

1010200-> The servo is being adjusted online in NURBS (G132) mode.

1010300-> The command cancel state is established in NURBS (G132) mode.

1020006-> Cutter radius compensation mode is selected in NURBS (G132) mode.

1020007-> 3-D tool offset mode is selected in NURBS (G132) mode.

102000A-> Fixed cycle mode is selected in NURBS (G132) mode.

102000C-> Feed-per-minute mode is not selected in NURBS (G132) mode.

102003F-> Axis name designation mode is selected in NURBS (G132) mode.

1020041-> Tolerance control mode is selected in NURBS (G132) mode.

102004D-> Cylindrical side machining mode is selected in NURBS (G132) mode.

1020060-> Rapid traverse mode is selected in NURBS (G132) mode.

[Probable Faulty Locations] Programming error

[Measures to Take] Correct the program.

★ 2576 **NURBS data word incorrect**

An invalid data word is specified in NURBS (G132) mode.

[Code]

- 20100000-> Though previous block is not the end of NURBS (G132) section, a G code in the G00 group is specified.
- 20110000-> Hexadecimal number is used as X, Y, Z, Q, or R command value in NURBS (G132) mode.
- 20200000-> There are too many blocks for Q single command (knot) specified at the end of NURBS (G132) section.
- 20210000-> The Q command (knot) value specified at the end of NURBS (G132) section does not match the actual number of knots.
- 20300000-> The P command (rank) exists in a block besides the first block of the NURBS (G132) section.
- 20310000-> The Q command (knot) value specified at the top of NURBS (G132) section does not match the actual number of knots.
- 20320000-> The Q single command (knot) is specified though NURBS (G132) segment is not defined (because the number of blocks is smaller than the rank).
- 20330000-> At least one of X, Y, Z, R (, P: top of NURBS (G132) section) commands is required in a block having neither G132 command nor Q single command (end of NURBS (G132) section) + F.
- 20400000-> The specified address character is not usable in NURBS (G132) mode.
- 20500000-> The P command (rank) is out of the allowable range.
- 20600000-> The Q command (knot) value or R command (weight) value exceeds the setting range.
- 30100000-> The coordinate values of the end point of NURBS (G132) section or its mirror image exceeds the calculation range.
- 4010XXXX-> Calculation for interpolation in NURBS (G132) segment is terminated abnormally.
- XXXX =0001->Degree (rank-1) is not correct.
  - =0002->Q[i] command value is larger than Q[i+1] command value.
  - =0003->Q[i] command value is equal to or larger than Q[i + rank] command value.
  - =0004->Error in calculating the start point
  - =0005->Error in calculating the end point
- 401100XX-> The distance between the previous target position and the NURBS (G132) segment start position exceeds the allowable range (set at the optional parameter long word No.27).
- XX: Axis index
  - =00-> X-axis
  - =20-> Y-axis
  - =40-> Z-axis

[Probable Faulty Locations]

Data word specified in the block for establishing NURBS (G132) mode or in the block preceding or following the NURBS block.

[Measures to Take]

Specify a proper data word by referring to the instruction manual.

★ 2577 **NURBS interpolation mode**

The conditions for enabling the NURBS (G132) mode are not met, or the conditions have been changed or lost during execution of NURBS command.

[Code]

- 1-> The mirror image switch is operated during the NURBS (G132) mode.
- 2-> The NURBS (G132) mode is specified in the state of axis command cancel, or such state is established during the NURBS (G132) mode.

[Measures to Take]

During NURBS (G132) mode...

- 1) Do not operate the mirror image switch.



2) Do not establish the axis command cancel state.

**★ 2578 NURBS command miss**

NURBS (G132) mode command is wrong.

[Code]

1-> The data word for X, Y, Z, Q, or R is other than the numerical data.

Example: X=VC1 (common variable)

[Probable Faulty Locations] Programming error

[Measures to Take] Correct the program.

**★ 2579 Diameter instruction axis command**

The diameter command was specified though the currently activated function does not permit such command.

[Index] Exists

[Character-string] None

[Code]

1-> Area machining

2-> Coordinate calculation function

[Probable Faulty Locations] Program error

[Measures to Take] Correct the program.

**★ 2580 Reset button error**

The reset button or external reset button keeps sending the reset signal for ten seconds or over continuously.

[Index] None

[Character-string] None

[Code]

1-> Reset button

2-> External reset button

3-> Reset button/external reset button

[Probable Faulty Locations]

Reset state continues because of malfunction of the reset button or external reset button.

[Measures to Take] Replace the reset button or the external reset button.

**★ 2581 Turning cut mode**

G code for the turning cut mode is wrongly used.

[Index] None

[Character-string] None

[Code]

10-> G code for canceling the turning cut mode (G148) is specified though the turning cut mode is not selected.

20-> G code for selecting the turning cut mode (G149) is specified though the turning cut mode is already selected.

30-> The Y-axis command was specified with the shape command for infinite circular interpolation.

40-> Command other than G1 to G3 was specified during the turning cut cycle.

50-> Command for infinite circular interpolation (G164, 164, or G166) was specified without selection of the turning cut mode.

60-> The command block (G165/G166) for starting infinite circular interpolation does not include any X-axis command.

70-> The command block (G165/G166) for starting infinite circular interpolation includes a command of the axis other than X- and Z-axes.

[Probable Faulty Locations] Part program

[Measures to Take] Correct the part program.

**★ 2582 DNC-DT preload error**

The DNC-DT preload process was not normally performed.

[Index] None

[Character-string] None

[Code]

100-> Faulty hardware (hardware disk, etc.)

XXYYZZ

XX=

6F-> Small buffer size in TCP/IP driver

72-> Faulty descriptor transferred to TCP/IP driver

73-> Faulty parameter transferred to TCP/IP driver

74-> No empty port in the shared memory

75-> Unconnected

7B-> Abort command ignored

7D-> `ftp ms open' abnormal termination

7E-> `ftp ms close' abnormal termination

7F-> `ftp ms type' abnormal termination

80-> `ftp ms user' abnormal termination

81-> `ftp ms pass' abnormal termination

82-> `ftp ms acct' abnormal termination

83-> `ftp ms delete' abnormal termination

84-> `ftp ms fopen' abnormal termination

85-> `ftp ms fopen uni' abnormal termination

86-> `ftp ms net drecv f' abnormal termination

87-> `ftp ms net dsend f' abnormal termination

88-> `ftp ms fclose' abnormal termination

89-> `ftp ms abort' abnormal termination

8A-> `ftp ms chdir' abnormal termination

8D-> `ftp ms pwd' abnormal termination

8F-> `ftp ms dopen' abnormal termination

90-> `ftp ms dread' abnormal termination

91-> `ftp ms dclose' abnormal termination

97-> IP address error

98-> No IP address

99-> Interruption due to time-out

9A-> Disconnection command from the remote host

9B-> Abnormally terminated initialization of OS (MORE) on TCP/IP board

9C-> Abnormally terminated initialization of packet driver or TCP/IP module on TCP/IP board

9F-> Abnormally terminated initialization of FTP module on TCP/IP board

A0-> Abnormally terminated initialization of socket interface module on TCP/IP board

A1-> Abnormally terminated initialization of TCP/IP board

YY=

10-> Preload task started

- 20-> Preload process initialized
- 30-> Preload requested
- 40-> Number of completed preload processes acquired
- 50-> Preload file taken out
- 60-> Number of remaining preload file tables acquired
- 70-> Preload aborted
- 80-> Preload file unlocked
- 90-> Preload requested
- A0-> Preload file unlocked
- B0-> File transfer error
- ZZ=
- FF-> Communication error
- 02-> File does not exist.
- 03-> Preload task not started
- 05-> No transferred file
- 08-> Preload process not initialized  
Previous preload process not completed
- 0D-> File protected
- 0E-> Wrong preload task start parameter
- 11-> File present. Preload task already started.
- 13-> Wrong file device name
- 16-> Wrong initialization parameter. Not started up. Wrong program name.

★ 2583 **UNTENDED: gauging sphere error over**

A large error was detected in measurement of sphericity.

[Index] None

[Character-string] None

[Code] None

[Probable Faulty Locations] Measuring instrument is faulty.

[Measures to Take]

Using the spare measuring instrument or any other appropriate instrument to measure the sphericity.

[Instruction Manuals to Refer]

★ 2584 **Coolant level low**

Coolant is getting short.

The float switch in the coolant tank failed to detect the coolant normal signal when the coolant or oil-hole command was issued.

This alarm is output as a level A alarm if it occurs when an oil-hole command is issued on a double-column machining center.

[Index] None

[Character-string] None

[Code] None

[Measures to Take] Supply coolant.

★ 2585 **DNC-DT delete error**

A file was not normally deleted by the schedule program delete function.

[Index] None

[Character-string] None

[Code]

FFFFFFF-> No file. File protected.

★ 2586 **Manual shift total is not 0**

The shift amount was not 0 when a program was run.

[Index] Axis

[Character-string] None

[Code] Shift amount

[Measures to Take] Set the shift amount to 0.

★ 2587 **Spindle cooling-unit**

The overload sensor was activated in the spindle cooling pump motor.

1->MCR-A

The spindle cooling-unit failed to send the lubrication pump run signal.

[Index] None

[Character-string] None

[Code] None

[Probable Faulty Locations]

The circulating pump or the cooling pump in the combination unit is faulty.

Reference: Instruction manual for combination unit or spindle cooling-unit

★ 2588 **Spindle cooling-unit oil level low**

The spindle cooling-unit is running short of oil.

The oil level normal signal from the spindle cooling unit went OFF.

[Index] None

[Character-string] None

[Code] None

[Probable Faulty Locations]

The spindle cooling oil is lacking.

The float switch is faulty.

[Measures to Take] Supply the cooling oil.

★ 2701 **No tool command**

M06 (vertical spindle tool change) command was issued without any T command (tool number command) at the ATC.

[Index] None

[Character-string] None

[Codes]

None->M06 command was issued without any T command.

1-> M06 command was issued when the next tool was a TN tool.

[Measures to Take] Check the program.

★ 2702 **Program bad direct : T code**

A T number greater than the allowable maximum tool number is specified.

[Index] None

[Character - string] None

[Code] None

[Measures to Take]

- 1) Check the program.
- 2) Make sure that the machine specification and the T command match each other.

★ 2703 **ATC M command**

M commands relating to the ATC are not used properly.

[Index] None

[Character-string] None

[Codes]

- 1-> M63 command was issued after a T command.
- 2-> M63 command was issued when the active tool number was a cover tool.
- 3-> M63 command was issued in a position other than the ATC start position.
- 4-> M64 command was issued without any next tool command.
- 5-> M65 command was issued during an ATC cycle.
- 6-> M65 command was issued in a position other than the ATC start position.
- 7-> M66 command was issued after a T command.
- 8-> M66 command was issued after a T command.
- 9-> M66 command was issued in a position other than the ATC start position.
- 10-> M66 command was issued when the active tool number was a cover tool.
- 11-> M66 command was issued without any active tool.
- 12-> M67 command was issued without any next tool command.
- 13-> M67 command was issued without any next tool command.
- 15-> There is no pot that can return the tool when an M63 command is issued.
- 16-> M06 command was executed with an M67 command when the active tool was a vertical spindle tool.
- 17-> M06 command was executed without any M67 command when the active tool was a horizontal tool.
- 18-> M166 command was issued after a T command.
- 19-> M63 command was executed when the active tool was a TN tool.
- 20-> M64 command was executed when the next tool was a TN tool.
- 21-> No cover tool is attached when an M66 command is present.
- 22-> No cover tool is attached when an M67 command is present.
- 23-> M177 command was issued when there was no attachment.
- 24-> The U-axis is coupled when an M06 command is issued.
- 25-> The tool change arm is not in the standby position when an M06, M63, or M64 command is issued.
- 26-> M77 command was issued without any vertical spindle tool when a different tool continuous tool change command was present.
- 27-> M77 command was issued when a vertical spindle tool was attached.
- 28-> M06 command was executed with an M67 command when the active tool was a horizontal, large-diameter tool.
- 29-> M06 command was executed in a pallet cleaning sequence.
- 30-> The base plate is level.
- 31-> M06 command was executed when the sub spindle was running.
- 32-> M166 command was issued in a position other than the ATC start position.
- 33-> M166 command was issued without any active tool.
- 34-> M06 command was issued when the X-axis was not located in the tool change position.
- 35-> The chuck (jig) still has not completed clamping.

[Measures to Take]

Check the program and the "pot/tool correspondence table" in tool data setting mode.

★ 2704 **Axis lube motor overload**

The overload relay for the axis lubrication motor is tripped.

[Index] None

[Character-string]

None : X-, Y-, Z- axis

'W' : Cross rail

[Code] None

[Probable Faulty Locations] Detective lubrication motor

[Measures to Take] Reset the tripped overload relay.

★ 2705 **Axis lube pressure ON confirmation**

The pressure switch is not turn on within a predetermined period (motor ON time×2 ) after the lubrication pump motor is turned on.

[Index] None

[Character-string]

None : X-, Y-, Z-axis

'X' : X-axis

'Y,Z': Y-, Z-axis

'W' : Crossrai1

[Probable Faulty Locations]

- 1) Defective lubrication motor
- 2) Defective pressure switch
- 3) Defective lubrication piping

★ 2706 **Axis lube pressure OFF confirmation**

The pressure switch is not off when an axis lubrication motor is turned on.

Or the pressure switch is not turned off within a predetermined period (motor ON time×2) after the lubrication motor is turned off.

[Index] None

[Character-string]

None : X-, Y-, Z-axis

'X' : X-axis

'Y,Z': Y-, Z-axis

'W7' : Cross rail

[Probable Faulty Locations]

- 1) Defective pressure switch
- 2) Clogged lubrication piping

★ 2707 **Coolant motor overload**

The overload relay for the coolant pump motor is tripped.

[Index] None

[Character-string] None

[Code] None

[Probable Faulty Locations]

- 1) Defective coolant pump motor
- 2) Clogged lubrication pump

★ 2708 **Thru - the - tool coolant motor overload**

The overload relay for the through-the-tool coolant pump motor is tripped.

[Index] None

[Character-string] None

[Code] None

[Probable Faulty Locations]

- 1) Defective through-the-tool coolant pump motor
- 2) Clogged lubrication pump
- 3) The through-the-tool coolant command is specified although the through-the-tool coolant specification is not supported.

★ 2709 **Spindle orient position OFF**

The spindle is offset by 15° or more from the orientation position.

[Index] None

[Character-string] None

[Code] None

[Probable Faulty Locations]

- 1) Defective spindle drive unit
- 2) Defective spindle pulse generator

★ 2710 **Clamp command ON**

G01 is specified while an axis is clamped.

For the axes which are clamped and unclamped by M code commands, cutting mode(G01,G02and G03)is specified while the axis is clamped.

[Index] AXIS

[Character-string] None

[Code] None

[Measures to Take] Correct the program.

★ 2711 **Clamp confirmation**

The clamp confirmation signal and the seated condition confirmation signal are not issued.

[Index] Axis

[Character-string] None

When a clamp command was issued to the feed axis indexed, the clamp confirmation limit switch was not turned ON after more than five seconds, or the unclamp confirmation signal limit switch was not turned OFF.

APC: The seated condition confirmation signal was not turned ON although work seating was retried because the pallet seated confirmation signal was not turned ON.

[Code] None

[Probable Faulty Locations]

Mechanical clamping is impossible.

The clamp confirmation limit switch or unclamp confirmation limit switch is faulty.

The clamp solenoid or unclamp solenoid is faulty.

★ 2712 **Unclamp confirmation**

Unclamp confirmation signal is not output.

The unclamp confirmation LS is not turned on or the clamp confirmation LS is not turned off within five seconds after the axis is unclamped(M\*\*).

[Index] AXIS

[Character-string] None

[Code] None

[Probable Faulty Locations]

- 1) The axis is not unclamped mechanically.
- 2) Defective clamp or unclamp confirmation LS
- 3) Defective clamp or unclamp SOL

**★ 2713 Axis interlock releasing**

This alarm shows that the machine is under adjustment.

[Index] None

[Character-string] None

[Code] Kind of adjustment

**★ 2714 APC M command**

M commands relating to the APC are not used properly.

[Index] None

[Character-string] None

[Codes]

- 1-> M60 command was issued in a position other than the APC start position.
- 2-> The number of the pallet placed on the table was specified.
- 3-> A larger value than the maximum pallet value was specified.
- 4-> An unregistered carrier number was specified.
- 5-> M60 command was issued when the round table was coupled.
- 7-> M372 or M373 command was executed when the APC door was not closed.
- 8-> M372 command was executed in a position other than home position 1.
- 9-> M372 command was executed in a position other than the position where a table call command was executable, or an M373 command was executed in a position other than the position where a table housing command was executable.
- 11-> Jig clamping (chucking) is not completed on the machine.
- 12-> M60 command was executed while the sub spindle was running.
- 13-> M60 command was issued when the active tool number is a long tool.

[Measures to Take] Check the program.

**★ 2715 Wrong T command**

T commands are not used properly.

[Index] None

[Character-string] None

[Codes]

- 1-> The same T command as the active tool number was executed.
- 2-> A T command was executed twice.
- 3-> A T command was executed in a position other than the ATC start position.
- 4-> A T00 command was issued during an ATC cycle.
- 5-> A T00 command was issued in a position other than the ATC start position.
- 10-> With a memory random function: A pot command was issued with the next tool.
- 11-> With a memory random function: A larger pot number than the maximum number of pots was specified.
- 12-> With a memory random function: A pot that cannot return the large-diameter tool is specified with a pot command.
- 13-> The tool number specified with a T command is duplicated in the pot/tool correspondence table.



- 14-> The tool number specified with a T command is not registered in the pot/tool correspondence table.
- 15-> With a memory random function: The pot cannot return the large-diameter tool.
- 16-> With a memory random function: The active tool is already in the magazine.
- 17-> With a memory random function: There is a tool in the indexing pot.
- 21-> The same T command as the current attachment was executed.
- 22-> A T command for the AAC was executed twice.
- 23-> A T command for the AAC was executed in a position other than the AAC start position.
- 24-> The next attachment in the same station as the current attachment was specified.
- 25-> The next attachment incapable of performing simultaneous tool change was specified.
- 50-> In a machine equipped with a matrix magazine, there is a pot in the tool rack to which the active tool will be returned.
- 51-> In a machine equipped with a matrix magazine, there is no pot in the tool rack for the next tool.
- 52-> In a machine equipped with a matrix magazine, the next tool is called to the "manual tool change position."
- 61-> The tool number specified with a T command differs from the current attachment in specifications.
- 90-> T command was executed in a pallet cleaning sequence.
- 91-> T command was executed while the sub spindle was running.

[Measures to Take]

Check the program and the "pot/tool correspondence table" in tool data setting mode.

★ 2716 **No S command**

- 1) An S command is not specified when a spindle rotation command(M03,M04)is executed.
- 2) An S command is not specified when a spindle speed range change command (M40, M41, M42, M43) is executed.

[Index] None

[Character-string] None

[Code] None

[Measures to Take] Check the program.

★ 2717 **Unusable: S code**

An S command which cannot be executed with the specification selected is specified.

[Index] None

[Character-string]None

[Code]S command value(in hexadecimal)

[Measures to Take] Check the S command in a program.

★ 2718 **Axis drive motor overload**

The thermostat incorporated in the PLC axis motor is tripped.

[Index] AXIS

[Character-string] Axis name

[Code] None

[Probable Faulty Locations]

- 1) Excessive motor load due to mechanical problem
- 2) Defective axis motor
- 3) Defective axis drive unit

[Probable Faulty Locations] Turn off power supply and cool the motor.

★ 2719 **Sequence restart**

Wrong sequence restart command

[Index] None

[Character-string] None

[Code] None

★ 2720 **Machine axis travel limit over**

A machine axis (PLC axis) has exceeded its travel limit.

[Index] AXIS

[Character-string] None

[Code] None

★ 2721 **Axis change control unusual**

Change of axis control was not normally performed.

[Index] None

[Character-string] None

[Code] 3

[Probable Faulty Locations] The shift gear shaft pin is not aligned with the pin hole.

★ 2722 **Coolant level low**

The coolant level is low.

The float switch within the coolant tank turned OFF the coolant level normal signal when a coolant or oil hole command was executed, or it turned ON the coolant abnormal signal.

[Index] None

[Character-string] None

[Codes]

None->The coolant, oil hole, or shower coolant level has fallen.

1-> The separation tank 2 oil level lower limit signal remained OFF for more than three seconds.

2-> The separation tank 2 water level lower limit signal remained OFF for more than three seconds.

10-> The oil shot level has fallen.

11-> The oil level drop notice signal remained ON for more than three seconds.

[Measures to Take] Supply coolant.

★ 2723 **Thru-the-tool coolant filter clogged**

The filter in the through-the-tool coolant tank is clogged.

[Index] None

[Character-string] None

[Code] None

[Probable Faulty Locations]

1) The filter is clogged.

2) Malfunction of the pressure switch for detecting the clogged filter.

[Measures to Take] Clean the filter.

★ 2724 **Shower coolant motor overload**

Overload shower coolant motor

[Index] None

[Character-string] None

[Code] None

[Probable Faulty Locations]

- 1) Defective shower coolant motor
- 2) Clogged lubrication pump

**★ 2725 Next tool No.**

The next tool number is larger than the maximum T command value.

[Index] None

[Character-string] None

[Code] T command value (hexadecimal)

[Measures to Take] Check the program.

**★ 2726 Spindlehead cooling unit**

The overload relay for the spindlehead lubricant cooling motor became activated.

[Index] None

[Character-string] None

[Codes]

- 10-> The combination unit lubrication pump operation signal remained OFF for more than three seconds while the hydraulic unit signal was ON and the spindle was running (MCR-A).
- 11-> The combination unit lubricant level normal signal remained OFF for more than three seconds while the hydraulic unit signal was ON (MCR-A).

[Probable Faulty locations]

The lubricant cooling unit within the combined hydraulic unit is faulty.

**★ 2727 Improper M command**

M commands are not used properly.

[Index] None

[Character-string] None

[Codes]

- 3-> An angle different from the previous one was specified during C-axis (attachment) indexing.
- 7-> A spindle through air blowing command was issued while the spindle was running.
- 8-> A through spindle coolant was specified although the spindle tool was not a through tool.
- 9-> The B-axis was not within the touch sensor operable range when an M144 command (touch sensor advance) was executed.  
A through spindle coolant was specified with the vertical spindle tool clamping normal signal OFF (MCR-B2).
- 10-> An angle different from the previous one was specified when the current attachment was built-in and the C-axis (attachment) was being indexed.
- 11-> M333 command was executed when the next tool was not a TN tool or there was a active tool.
- 12-> An adapter type air blowing command was issued while the spindle was running.
- 13-> M32 command was executed with system link mode is OFF.
- 20-> A first travel limit valid command was executed when the ATC door was not open.
- 21-> A first travel limit valid command was executed when the ATC or AAC was in operation and the operation number was not "1."
- 22-> A first travel limit invalid command was executed when the Y-axis was not in the position where the ATC door can open or close.

★ 2728 **Machine system data code**

- 1) There is a logical error in the data (such as Auto test data, Manual test data, Auto branch data, Manual branch data, and A/B mode test data) used in the input logic (SPCiF10.0 to .12).
- 2) There is a logical error in the axis data (such as Out data, Solenoid off data, and A/B mode out data) used in the output logic (PSCOF10.0 to .12).
- 3) There is a logical error in the interlock data (related with the magazine, individual axis, and spindle rotation).
- 4) The EC alarm messages are not registered in the NC control software.

[Index] None

[Character-string] None

[Code] Absolute address of the data that contains a logical error

[Measures to Take] Change the memory. (However, there is a little possibility that memory is faulty.)

★ 2729 **Improper TN code**

A TN command value out of the TN = \*\* (\*\*: 0 to the number of tool correction sets) command range was specified in tool management on a machine without an ATC.

[Index] None

[Character-string] None

[Codes]

- 1-> The same TN command as the active tool number was executed.
- 2-> A TN command was executed after the next tool command.
- 3-> A TN command was executed in a position other than the ATC start position.
- 4-> The tool number of the TN command is already registered in the pot/tool correspondence table.
- 5-> The tool number of the TN command is larger than the number of tool correction sets.

★ 2730 **Pallet discrimination NG**

When the pallet is checked according to the "M289 RP=\*" command, the pallet being checked is not the designed one.

[Index] None

[Character - string] None

[Code] None

[Measures to Take]

Press the RESET button, and execute the command again. At this time, check the VPLTN system variable to determine the pallet type.

★ 2731 **Data word: RP**

RP command value is improper.

[Index] None

[Character - string] None

[Code] Hexadecimal of RP command value caused an alarm

[Measures to Take]

Press the RESET button and designate again. Designate 1 or 2 for an RP command value.

★ 2732 **Data word: RH**

Command value of attachment angle command RH is outside 0° to 359°, or an angle not supported by the specification is specified (usually, attachment is indexed in units of 5°, 15° or 45°).

[Index] None

[Character - string] None

[Code] RP command value in hexadecimal

[Probable Faulty Locations] Program error

[Program Example] N000 RH=360 M94

★ 2733 **Data word: RS**

The RS command value is not proper.

[Index] None

[ICharacter-string] None

[Code] Hexadecimal data on the improper command value.

[Measures to Take] Press the reset button to reset the command.

★ 2734 **Crossrail positioning magnetic sensor confirmation**

The automatic positioning of the crossrail was not completed properly.

[Index] None

[ICharacter-string] None

[Codes]

1-> The crossrail was more than 2 mm away from the positioning position after positioning.

2-> No magnetic sensor signal was input although the crossrail was located more than 10 mm beyond the position set at the parameter during positioning.

3-> The crossrail reached the positive limit during positioning.

4-> The difference between the actual position and the position set at the parameter was beyond the "cross-rail position error tolerance" (offset: 14).

[Probable Faulty Locations]

The magnetic sensor or field net is faulty. The dog was out of position. The value set at the parameter is improper.

★ 2735 **Cycle time over**

The operation time exceeded the set parameter value.

[Index] None

[ICharacter-string] None

[Codes]

None->A cycle (the time from the startup to M02 or M30) exceeded the set parameter value.

10 -> The operation time of clamping, unclamping, chuck open, or chuck close exceeded the set parameter value.

[Index] None

★ 2736 **Work clamp miss**

In a machine equipped with the chucking error detecting function, the seated confirmation signal input remained OFF for more than 0.5 seconds during constant monitoring of seated condition.

The jig fitting confirmation signal input remained OFF for more than 0.5 seconds during constant jig fitting confirmation monitoring with a jig fitting confirmation function.

[ICharacter-string]

L = Work left side

R = Work right side

JIG1 = Jig 1 or chuck 1

JIG2 = Jig 2 or chuck 2

JIG3 = Jig 3 or chuck 3

[Codes]

- 1-> The signal went OFF within the time set at the "work sitting confirmation timer" when the monitoring function was ON.
- 2-> The signal remained OFF for more than 0.5 seconds when the spindle was at rest with the monitoring function ON.
- 20-> The signal went OFF within the time set at the "jig fitting confirmation timer" when the monitoring function was ON.
- 21-> The signal remained OFF for more than 0.5 seconds when the spindle was at rest with the monitoring function ON.

★ 2737 **Hydraulic oil cooling unit**

The hydraulic oil cooling unit turned OFF the operation normal signal, or it turned ON the operation error signal.

[Index] None

[ICharacter-string] None

[Code] None

[Probable Faulty Locations]

- 1) The hydraulic oil cooling unit is faulty.

★ 2738 **NP command unsuitable**

NP commands are not used properly.

[Index] None

[ICharacter-string] None

[Codes]

- 1-> A command was issued in PPC mode.
- 2-> The pallet number placed within the machine was specified.
- 3-> An unregistered pallet number was specified.
- 4-> An invalid pallet number was specified. (Specifiable range: 1 to 9999)

[Measures to Take]

- 1: Turn OFF the PPC mode switch, and reset the command.
- 2-4: Check the program.

★ 2739 **Cross rail vertical drive motor**

The overload relay for the crossrail vertical drive motor became activated.

[Index] None

[ICharacter-string] None

[Code] None

Probable Faulty Locations:

- 1-> The crossrail vertical drive motor is overloaded.
- 2-> The crossrail vertical drive motor is faulty.

★ 2740 **ATC tool data setting**

Improper tool data, such as the specified next tool and the "pot/tool correspondence table," was set when an ATC manual command was issued or the ATC was in operation.

[Index] None

[ICharacter-string] None

[Codes]

- 10-> With a memory random function: A pot command was issued with the next tool.
- 11-> With a memory random function: A larger pot number than the maximum number of pots was specified.

- 12-> With a memory random function: A pot that cannot return the large-diameter tool is specified with a pot command.
- 13-> The next tool number specified with a T command is duplicated in the pot/tool correspondence table.
- 14-> The next tool number specified with a T command is not registered in the pot/tool correspondence table.
- 15-> There is not pot that can return the tool when a no next tool command was issued.
- 50-> In a machine equipped with a matrix magazine, there is a pot in the tool rack to which the active tool will be returned.
- 51-> In a machine equipped with a matrix magazine, there is no pot in the tool rack for the next tool.
- 52-> In a machine equipped with a matrix magazine, the next tool is called to the "manual tool change position."

[Measures to Take]

Check the program and the "pot/tool correspondence table" in tool data setting mode.

**★ 2741 Tailstock advance limit**

The tailstock passed the advance limit after a tailstock advance command was issued except when the spindle was not running.

[Index] None

[ICharacter-string] None

[Code]

**★ 2742 Coolant unit unusual**

An error occurred in the coolant unit.

[Index] None

[ICharacter-string] None

An error occurred in the coolant unit.

OMST: In a machine designed to be equipped with an oil mist unit, the oil level drop and air pressure drop signals from the unit were turned ON.

[Codes]

None->The coolant tank level normal signal went OFF, or the coolant level abnormal signal came ON.

1-> The signal for stopping the centralized coolant cycle came ON.

2-> The coolant flow normal signal remained OFF for a longer period of time than the time set at the parameter during coolant motor output.

[Codes] 5-digit codes

XTZZ:

X = In the case of 1, the overload relay for the motor became activated.

= In the case of 2, the coolant reached the lower limit.

= In the case of 3, the coolant reached the upper limit.

= In the case of 4, the filter was clogged.

Y = In the case of 0, the input signal came ON.

= In the case of 1, the input signal went OFF.

ZZZ = The input signal address. Check it with the drawing.

(Example) 2060C: The signal at address 60C came ON, and the coolant reached the lower limit.

11211: The signal at address 211 went OFF, and the overload relay for the motor became activated.

4122C: The signal at address 22C went OFF, and the filter became clogged.

**★ 2743 Air pressure drop**

The main air pressure lowered.

[Index] None

[ICharacter-string] None

[Codes]

- 10-> The oil shot air pressure normal signal went OFF when an oil shot command was issued.
- 11-> The hoist pressure normal signal remained OFF for more than three seconds during C-axis indexing.

**★ 2744 Carrier system check now**

This alarm indicates that machine adjustment is in process.

[Index] None

[Character string] None

[Code] Adjustment type

**★ 2745 Spindle gear change impossible**

The spindle speed change gear was not shifted to the specified gear.

Gear matching was not confirmed although the spindle gear was shifted to the specified gear when an S command or spindle running command was issued.

Shifting is attempted three times.

[Index] None

[ICharacter-string] None

[Codes]

- 1-> Low-speed gear
- 2-> Medium-speed gear (high-speed gear in the case of a two-speed spindle)
- 3-> High-speed gear (idling in the case of a two-speed spindle)
- 4-> Idling

[Probable Faulty Locations]

- 1) The speed change gear did not mechanically operate, or the dog or limit switch was out of position.
- 2) The speed change solenoid is faulty.
- 3) The output card or any fuse within it is faulty.

**★ 2746 Spindle gear change command**

1. A value out of the permissible speed range of the gear currently selected was specified when an S command or M command (gear range specification) was issued while the spindle was running.
2. The selected speed is not within the permissible speed range when it was selected. Or, a speed that required a gear change when the spindle was running was selected.

[Index] None

[ICharacter-string] None

[Code] S command value

[Measures to Take] Check the S command and M command in the program.

**★ 2747 Cooling unit**

An error occurred in the cooling unit.

[Index] None

[ICharacter-string] None

[Codes]

- 1-> The cooling unit turned OFF the ball screw normal signal for more than one second or turned ON the ball screw abnormal signal when the ball screw cooling unit was in operation.
- 2-> The unit motor OL signal went OFF when a cutting command was not executed.



★ 2748 **Attachment indexing unusual**

The difference between the current value and the previous command value was more than five degrees after spindle indexing was completed at the start of attachment indexing.

[Index] None

[ICharacter-string] None

[Code] None

★ 2749 **Attachment control**

An operation command was issued in the state that the B-axis or C-axis attachment was unable to accept it.

[Index] None

[ICharacter-string] None

[Codes]

1-> B-axis attachment

2-> C-axis attachment

★ 2750 **Data word: 'RI'**

The value of the angle command RI for the AT-B-axis was other than 0, 30, 60, or 90.

[Index] None

[ICharacter-string] None

[Code] RI command value in hexadecimal

★ 2751 **Limit confirmation impossible**

The front-rear or right-left limit switch for the swivel head failed to come ON.

The counter value was larger than the direction commanded by the spindle PG counter at the execution of a swiveling command by 45 or more degrees during swivel head indexing.

[Index] None

[ICharacter-string] None

[Codes]

1-> Front

2-> Left

3-> Rear

4-> Right

★ 2752 **AAC M command**

M commands relating to the AAC are not improperly used.

[Index] None

[ICharacter-string] None

[Code]

9-> A command was input when the active tool for the ATC was present.

★ 2753 **Mist air lube unit**

The mist air lubrication unit turned OFF the normal operation signal or turned ON the unit abnormal signal.

[Index] None

[ICharacter-string] None

[Codes]

1-> The X-/Y-axis oil mist lubrication drop sensor remained ON for more than two seconds.

- 2-> The X-/Y-axis oil mist drop lubrication sensor was not turned ON at all for two consecutive cycles of X-/Y-axis oil mist lubrication pump drive air ON.
- 3-> When the power is supplied, the air ON cycle is performed for driving X-/Y-axis oil mist lubrication pump. This cycle was repeated 100 times before the X-/Y-axis oil mist drop lubrication sensor came ON three consecutive times.
- 4-> The cumulative operation time of X-/Y-axis oil mist lubrication drive air ON output exceeded 24 hours with the X-/Y-axis oil mist coolant level normal signal OFF.
- 5-> The pressure normal signal for driving X-/Y-axis oil mist lubrication unit went OFF when the X-/Y-axis oil mist lubrication operation air ON output was ON.
- 6-> The ball screw discharge sensor was not turned ON at all for two consecutive cycles of ball screw lubricant discharge.
- 7-> The cumulative operation time of ball screw lubrication air ON output exceeded 24 hours with the ball screw lubricant level normal signal OFF.
- 8-> The ball screw lubrication air pressure normal signal remained OFF for more than 30 seconds when the ball screw lubrication air ON output was ON.

★ 2754 **Touch probe battery**

The voltage of the battery for the touch probe dropped.

[Index] None

[ICharacter-string] None

[Code] None

★ 2755 **Outside**

An error occurred in a linked external unit.

[Index] None

[ICharacter-string] None

[Codes]

None->An alarm occurred in a linked external unit.

10-> An alarm occurred in the indexing table.

[Probable Faulty Locations]

- 1) The linked external unit is faulty.
- 2) The indexing table is faulty.

★ 2756 **Sitting abnormal**

In a machine with a sitting monitoring function, the sitting confirmation signal input remained OFF for more than 0.5 seconds during constant sitting confirmation monitoring.

[ICharacter-string]

BP-> Base plate

[Codes]

- 1-> The signal failed to come ON within the time set at the "work sitting confirmation timer" after a sitting monitoring command was issued.
- 2-> The signal went OFF when the spindle was at rest.

★ 2757 **Axis interlock**

[Index] Axis

[ICharacter-string] None

[Code] Hexadecimal machine diagnosis number

★ 2758 **Hydraulic unit error**

An error occurred in the hydraulic unit.

[Index] None

[Character-string] None

[Codes]

- 2-> The hydraulic unit oil level normal signal remained OFF for more than three seconds.
- 3-> The hydraulic unit filter normal signal remained OFF for more than three seconds.

★ 2759 **Warming up**

An error occurred at the start of the warming up program.

[Index] None

[Character-string] None

[Codes]

- 1-> The operation door was open at the start of the warming up program.
- 2-> Setting mode or test mode was selected as the interlock mode. (CE marking)

[Measures to Take]

- 1) Press the NC reset button. However, warming up will be interrupted.
  - 2) Press the NC reset button. However, warming up will be interrupted.
- To restart the warming up program, shift the interlock mode switch to production mode.

## SECTION 6 ALARM C

Alarm No.	Alarm Message
3000	SVP start conditions uncertain
3001	SVP processing trouble
3002	SVP CON APA deviation
3003	SVP error
3004	SVP exception processing
3005	SVP APA pattern data
3006	SVP APA speed
3007	SVP CON speed
3008	SVP DIFF over
3009	SVP servo amp
3010	SVP APA check data
3011	SVP speed command over
3012	SVP servo data setting
3013	SVP belt is broken
3014	SVP F-TYPE encoder error
3015	SVP full closed loop error
3016	SVP F-TYPE encoder with shaft error
3017	SVP F with shaft APA pattern data
3018	SVP cannot plant error offset data
3019	SVP encoder application (MOTOR SHAFT)
3020	SVP encoder application (WITH SHAFT)
3021	SVP collision detection
3022	SVP SA overload
3023	SVP SA communication error
3024	SVP SA version error
3025	SVP SA motor current overload
3026	SVP SA inverter bridge short circuit
3027	SVP SA overheating
3028	SVP SA power circuit overvoltage
3029	SVP SA power circuit low voltage
3030	SVP SA regenerative resistor overheat
3031	SVP control circuit power voltage
3032	SVP SA error
3033	SVP board version error
3034	SVP control error
3035	CRP exception
3036	CRP diagnosis
3051	ACP exception
3052	ACP diagnosis
3150	MCS Undefined alarm number
3151	MCS Exception processing

Alarm No.	Alarm Message
3152	MCS Processing trouble
3153	MCS CON APA deviation
3154	MCS Power-Supply-Unit Error
3155	MCS Converter-link error
3156	MCS DC-bus voltage alarm
3157	MCS Motor over current
3158	MCS Power unit over heat
3159	MCS Power unit over load
3160	MCS Supply voltage flutter
3161	MCS Power unit version error
3162	MCS Winding-change failed
3163	MCS Encoder-link error
3164	MCS Encoder error
3165	MCS Encoder initialize failed
3166	MCS Encoder with shaft error
3167	MCS Encoder with shaft initial
3168	MCS ABSO SCALE error
3169	MCS ABSO SCALE initialize
3170	MCS Magnetic encoder alarm
3171	MCS Resolver alarm
3172	MCS Pulse generator count over
3173	MCS Motor over heat
3174	MCS Servo-link error
3175	MCS Servo-link disconnect
3176	MCS Servo-link protocol error
3177	MCS Servo data error
3178	MCS Illegal command
3179	MCS CON speed over
3180	MCS Speed command over
3181	MCS DIFF over
3182	MCS APA speed over
3183	MCS Full-closed APA error
3184	MCS Over speed
3185	MCS Velocity deviation over
3186	MCS Collision detected
3187	MCS Urgent-stop time over
3188	MCS Belt is broken
3189	MCS Axis change control error
3190	MCS independent encoder init
3191	MCS APA error
3192	MCS Motor over load
3200	Power saving
3201	Spindle blower motor overload

Alarm No.	Alarm Message
3202	CPU temperature rising
3203	Hydraulic oil temperature rising
3204	Hydraulic oil level low
3205	Spindle lube level low
3206	Coolant level low
3207	Axis lube level low
3208	ATC system condition
3209	APC system condition
3210	CPU voltage low
3211	Power source unit overload
3212	Spindle drive motor brush wear
3213	No original command tool
3214	Chip conveyor motor overload
3215	AAC1 system condition
3216	AAC2 system condition
3217	LTC system condition
3218	DNC start condition
3219	Outside
3220	User reserve code
3221	MSB reserved
3222	Read/Write head movement time over
3223	Program select
3224	System check
3225	External manual operation
3226	Coolant-supply-to-cooler motor overload
3227	Warming up
3228	No tool in TDS read/write pot
3229	Air dryer unusual
3230	DNC initial sequence : impossible
3231	FMS coupling mode change
3232	Multi volume end code error
3233	Manual skip function
3234	Interactive gauging : impossible
3235	Panel/CRP receive error
3236	CRP/panel send error
3237	Print data output
3238	Chip cleaner
3239	Running hour over
3240	Work counter over
3241	BTC system condition
3242	MOP CCP error
3243	MOP communication error
3244	DNC receive text is unallowable

Alarm No.	Alarm Message
3245	DNC machine No. is unsame
3246	DNC text format error
3247	DNC receive abort
3248	DNC text send abort
3249	FMS coupling mode change
3250	FMS HOST CPU alarm
3251	FMS operation mode select
3252	Oil/coolant separator motor overload
3253	TMP communication abort
3254	TMP mean count error
3255	Thermal deviation compensation
3256	Pallet No. check NG
3257	In program operation
3258	DNC Illegal data
3259	Compressor Check
3260	ADP START
3261	Chip flush-out motor overload
3262	Oil-air lubricating oil level low
3263	NG2 tool used
3264	Spindle overload
3266	Tool preparation function
3267	Tool data not incomplete
3268	DNC-DT start condition
3269	Chip flush-out motor overload
3270	Magnet separator motor overload
3271	Coolant unit
3272	PLC battery change
3273	Start switch N.G.
3274	Start condition
3275	Fixture shower coolant motor overload
3276	Cycle time over
3277	Tool life management no spare tool
3278	Quality check alarm
3279	Pallet supply NG
3280	Position encoder needs the adjustment
3281	Touch probe battery
3282	Work-counter over
3283	Washing unit
3284	Gauging NG
3285	DNC-DT Path name
3286	DNC-T Program select
3287	Cooling unit
3288	Air pressure low

Alarm No.	Alarm Message
3289	Oil-air lube
3290	Oil-mist unit
3291	Filter clogging
3701	CPU temperature rising
3702	CPU voltage low
3703	Axis lube level low
3704	Coolant level low
3705	ATC system condition
3706	Power source unit overload
3707	Hydraulic oil level low
3708	Spindle lube level low
3709	Auto power shut-off impossible
3710	Power saving
3711	Chip flush-out motor overload
3712	Chip conveyor motor overload
3713	External program select parity check
3714	APC system condition
3715	Air dryer unusual
3716	Cycle time over
3717	Quality counter
3718	Outside
3719	Coolant unit
3720	Thru-the-tool coolant filter
3721	Air pressure drop
3722	Mist air lube unit
3723	Cooling unit
3724	VAC operation command mismatch
3725	ACC system condition
3726	Lube unit
3727	Time over
3728	Oilmist unit
3729	Washing unit
3730	Clamp unit
3731	Sitting abnormal
3732	Dust-collector Error
3733	Gauging NG
3734	Oil-air lube
3735	Mist-collector Error
3736	Hydraulic unit error



★ 3000 SVP start conditions uncertain

SVP hardware or software conditions were not met, which made it impossible to start up the SVP.

[Index] AXIS

[Code] XYYZZZZ

X=1-> Hardware-related conditions are not met.

YY=1->The SVP board is not mounted.

ZZZZ=0000

YY=2->The SVP is in abnormal status.

ZZZZSVP status

YY=3->The system bus related to the SVP hardware is in abnormal status.

ZZZZ:System bus status

X=2->SVP data conditions are not met.

YY=1->Wrong synchronous signal number is selected.

ZZZZ:Selected synchronous signal number

YY=2->Synchronous shift time is wrongly designated.

ZZZZ:Designated synchronous shift time

X=3-> Software-related conditions are not met.

YY=1->The SVP software is not installed.

ZZZZ=0000

YY=2->Servo parameters are not installed.

ZZZZ=0000

[Probable Faulty Locations]

- 1) SVP hardware of the problem axis
- 2) Control software such as that for NC
- 3) NC specifications

★ 3001 SVP processing trouble

The SVP is in the trouble indicated by the following codes.

[Index] AXIS

[Code] XYYZZZZ

X=1-> Internal error

The SVP has caused either parity loop error or protect error.

YY-> Internal error status

ZZZZ:Two high-order bytes of the SVP system address in trouble

X=2-> Time out

The SVP does not send any response within 20[s] at the time of start up. Minute investigation should be made to locate the cause.

Since the SVP cannot detect the start up signal, it cannot execute the start up sequence.

YY=00

ZZZZ=000000

X=3-> Double bus error

During bus error exception processing by SVP, a bus error has occurred again. The SVP hardware will probably be defective.

YY:System bus status

ZZZZ=000000

X=4-> SVP command execution

The SVP has obtained wrong diagnostic results of CPU command execution. The CPU will probably be defective.

YY:Diagnostic results

ZZZZ=000000

X=5-> SVP trouble detected by the control software such as that for NC. Some trouble has occurred in the SVP.

[Probable Faulty Locations]

- 1) SVP hardware of the problem axis
- 2) SVP software of the problem axis
- 3) Control software such as that for NC

**★ 3002 SVP CON APA deviation**

Deviation between CON and APA has exceeded the preset limit.

The deviation can be obtained by the formula: [Calculated value written in SVP] - [Actual position read from SVP].

This value is monitored by the control software such as that for NC.

The SVP usually monitors DIFF. However, when the SVP becomes unable to monitor DIFF due to fatal abnormality, this monitoring function will prevent the system overrun.

[Index] AXIS

[Code] Absolute deviation value in hexadecimal [reference unit]

[Probable Faulty Locations] SVP of the problem axis

**★ 3003 SVP error**

The control software such as that for NC has detected a system alarm signal sent from the SVP hardware. For details, refer to the specification for the mounted SVP version.

[Index] AXIS

[Character-string] None

[Code] \*??##&&

\* -> Axis number of which SVP board's CPU has caused the error  
(If 2, the problem SVP board is that for the 2nd axis.)

?? -> Board status in hexadecimal  
bit7bit6bit5bit4bit3bit2 bit1 bit0  
RUNHALTCPUOFF000 SNMI MSTP

## -> Bus error status in hexadecimal  
bit7bit6bit5bit4bit3bit2 bit1 bit0  
SBERSBPARCYCER0PROTDAILOOPECC

&& -> Always 00

[Probable Faulty Locations]

- 1) Hardware defect of the SVP board indicated with the code \*
- 2) Software defect

**★ 3004 SVP exception processing**

Abnormality has occurred in processing by SVP software.

[Index] AXIS

[Character-string] Detected error factor

- # 1-> Bus error
- # 2-> Address error
- # 3-> Illegal instruction error
- # 4-> Zero divide error
- # 5-> CHK instruction error
- # 6-> TRAPV instruction error
- # 7-> Privilege violation error
- # 8-> Trace error

- # 9-> Line 1010 emulator error
- #10-> Line 1111 emulator error
- #11-> Unused area error
- #12-> Coprocessor illegal protocol error
- #13-> Format error
- #14-> Uninitialized interrupt error
- #15-> Spurious interrupt error
- #16-> Interrupt error
- #17-> INT7 error
- #18-> Debugger interrupt alarm
- #19-> INT2 loop error
- #20-> INT5 loop error
- #21-> Speed command calculation delay alarm
- #22-> TRAP error
- #23-> Floating-point coprocessor error
- #24-> PMMU error
- #25-> User interrupt error
- #26-> Board version error
- #27-> Memory test error

[Code]

The CPU program counter value is displayed except when the following character-strings appear.  
With #26, the SVP hardware ID number is displayed as a code.  
With #27, the memory address at the time of abnormality detection is displayed as a code.

[Probable Faulty Locations]

- 1) SVP board
- 2) SVP software

**★ 3005 SVP APA pattern data**

The SVP has successively detected wrong patterns of positional data sent from the position encoder.

Ex. Displayed code: 8000

Conversion into the octal number 8000 (hexadecimal number)->100000 (octal number) Since the E8 unit reads up to 5 digits and ignores the sixth digit, all the digits become 0, causing the OSP to judge that no data is output from the encoder.

[Index] AXIS

[Code] Pattern of the read positional data (APA high-order digit)

[Probable Faulty Locations]

- 1) Position encoder of the problem axis
- 2) SVP hardware of the problem axis
- 3) Timing signal from the NC unit

**★ 3006 SVP APA speed**

The position encoder value (RAPA) changes according to the motor speed. The NC checks the variation of position encoder values at regular intervals. If the feedrate of each axis is abnormally high compared with the normal rapid traverse rate, or the value changes in abnormal manner due to malfunction of the position encoder, the variation per unit time exceeds a fixed allowable limit, causing this alarm.

[Index] AXIS

[Code]

Variation of the position encoder values in hexadecimal [encoder unit /3.2ms]  
However, the following codes represents special meanings.

FFFFFFFF-> The variation has exceeded the liner axis stroke.

FFFFFFFE-> The variation has exceeded the rotary axis stroke (360°), or the positional data of the infinite axis has changed to a negative value.

FFFFFFFD-> The variation has exceeded the infinite axis stroke.

[Probable Faulty Locations]

- 1) Position encoder of the problem axis or the cables connected with the encoder.
- 2) Motor for driving the problem axis
- 3) Drive unit of the problem axis
- 4) SVP hardware of the problem axis

#### ★ 3007 SVP CON speed

When the axis is in the target position or at a standstill, the target value, operation value, and actual position data are the same. With designation of an axis moving command, the NC starts calculating the path to the target position, thus creating operation values (RCON). The NC then monitors the variation of the operation values at regular intervals. If the value changes in abnormal manner for some reason exceeding the allowable limit, this alarm occurs.

[Index] AXIS

[Code]

Absolute feedrate command value in hexadecimal [encoder unit/feedrate control time]

However, the following codes represents special meanings:

FFFFFFFF-> The NC violates the protocol (time limit).

FFFFFFFE-> The feedrate command values is larger than the over alarm level or the alarm detection level.

FFFFFFFC-> The SVP internal command position exceeds the encoder division stroke.

[Probable Faulty Locations]

- 1) Servo parameter of the problem axis
- 2) Control software such as that for NC
- 3) SVP hardware of the problem axis
- 4) Excessively high feedrate (except G00)

#### ★ 3008 SVP DIFF over

When the axis is in the target position or at a standstill, the target value, operation value, and actual position data are the same. With designation of an axis moving command, the NC starts calculating the path to the target position, thus creating operation values (RCON). This time, the actual position data follows the operation values with a certain delay. This delay amount obtained by subtracting [actual position] from [operation value] is termed following error. If the following error exceeds the allowable limit, this alarm occurs.

[Index] AXIS

[Code] Absolute DIFF value in hexadecimal [encoder unit]

[Probable Faulty Locations]

- 1) Mechanical trouble of ball screw, bearing or any other parts, which makes the axis movement heavy
- 2) Encoder, motor or drive unit of the problem axis
- 3) Servo parameters of the problem axis
- 4) SVP hardware of the problem axis

#### ★ 3009 SVP servo amp

Fatal abnormality has occurred in the servo amplifier.

[Index] AXIS

[Code] YYZZ

YY=Internal error status

ZZ=Servo amplifier IF status

[Probable Faulty Locations] Drive unit of the of the problem axis.

★ 3010 **SVP APA check data**

The high-order digits read from the position encoder do not match the high-order digits obtained by incremental operation.

Ex. Displayed code: 14E914A9

When this code is converted into the octal number (by carrying high-order digit for F or E type encoder or carrying octal number for E8 unit), the following result can be obtained.

12351                      12251

Encoder digit data    Operation data    Judging from the difference by 1 in the third place's number, the third digit or the second digit which generates the carry signal must be showing the cause of this alarm, i.e. phase difference in gear connection.

[Index] AXIS

[Code] YYYYZZZZ

YYYY=Hexadecimal number of the high-order digit read from the encoder

ZZZZ=Hexadecimal number of the high-order digit obtained by calculation from the lower-order digit

[Probable Faulty Locations]

- 1) Position encoder of the problem axis
- 2) SVP board of the problem axis
- 3) Synchronous signals of the system

[Measures to Take]

Convert the code to octal number.

If all the digits are shifted as in 1234523456

-> SVP board is defective.

If the first digit is discrepant as in 1234512344

-> MPR or bearing is defective in most cases.

If this alarm occurs in several axes

-> Synchronous signals of TFP or SVP board are defective.

★ 3011 **SVP speed command over**

The speed command calculated by SVP has successively exceeded the allowable limit. Here, the allowable limit means the speed command over alarm level.

[Index] AXIS

[Code]

Hexadecimal number of the absolute feedrate command value at the time of abnormality detection [encoder unit/feedrate control time]

[Probable Faulty Locations]

The causes are the same with those of SVP DIFF over alarm, for example, the mechanical load is large.

★ 3012 **SVP servo data setting**

The SVP has received non-applicable servo data. This alarm occurs when an abnormal value is set in the NC as servo data or when the servo processor cannot receive the set data.

Occurrence of this alarm during maintenance service implies that there may be an incompatibility between the servo parameter file and SVP software.

[Index] AXIS

[Code] Servo data number

- 21-> Kv value
- 22-> Hardware servo coefficient
- 23-> Slow up/down coefficient
- 26-> HB control slow up/down coefficient
- 2B-> Inductosyn special pitch

- 39-> Backlash compensation
- 3A-> CON speed limit
- 3B-> Mantissa of speed change ratio (straight line)
- 3C-> Exponent part of speed change ratio (straight line)
- 3D-> Speed change ratio (rotary)
- 41-> V-AMP output filter constant group
- 4F-> New speed detection G1
- 50-> New speed detection G2
- 51-> New speed detection HPF constant
- 52-> New speed detection LPF constant
- 53-> 1st speed acceleration/deceleration constant
- 54-> HB control constant
- 57-> 2nd speed acceleration/deceleration constant
- 58-> Notch filter constant group
- 62-> Encoder accuracy designation
- 71-> Amplifier communication speed
- 86-> DIFF. MIN (DIFF-G variable)
- 87-> DIFF. MAX (DIFF-G variable)
- 88-> ATTF calculation constant
- 89-> Integration limit value
- 100-> FLSUD change timing abnormal
- 101-> 1st speed change timing abnormal
- 102-> 2nd speed change timing abnormal
- 103-> Exp change timing abnormal
- 104-> QITGMD change timing abnormal
- 105-> Wrong interpolation mode
- FFFF-> No authorization
- FFFE-> Infinite/rotary axis
- FFFD-> Infinite axis
- FFFC-> Speed change ratio
- FFFB-> Speed control cycle

[Probable Faulty Locations]

- 1) Servo parameter file of the problem axis
- 2) Control software such as that for NC
- 3) SVP software of the problem axis

**★ 3013 SVP belt is broken**

The SVP has detected breakage of the belt for the belt-driven axis.

[Index] AXIS

[Code] Hexadecimal number of the torque applied at the time of breakage

**★ 3014 SVP F-TYPE encoder error**

Error compensation data for one turn cannot be set in the position encoder.

[Index] AXIS

[Code] The number indicating the setting impossible reason

- 1-> Data read disabled
- 2-> Data check sum error
- 4-> Data overflow
- 5-> Error compensation data does not return to 0.

[Probable Faulty Locations] Position encoder of the problem axis

**★ 3015 SVP full closed loop error**

Deviation between the full-closed loop and semi-closed loop is abnormally large.

[Index] AXIS

[Code] The number of abnormality detection times

[Probable Faulty Locations]

- 1) Separately mounted position encoder or inductosyn of the problem axis.
- 2) Excessive lost motion of the problem axis.
- 3) Slippage, breakage, or wear of the belt on the problem axis.
- 4) Coupling compensation is not set or wrong data is set in the problem axis.
- 5) The positional loop gain of the problem axis is not proper (too high).
- 6) Phase shift by collision of the problem axis.

**★ 3016 SVP F-TYPE encoder with shaft error**

It is impossible to set the rotation error compensation data of F type position encoder with shaft.

[Index] AXIS

[Code] The number indicating the setting disable reason.

- 1-> Data read disabled
- 2-> Data check sum error
- 4-> Data overflow
- 5-> Error compensation data does not return to 0.

[Probable Faulty Locations] Position encoder of the problem axis

**★ 3017 SVP F with shaft APA pattern data**

The position encoder with shaft has successively read positional data of wrong patterns.

[Index] AXIS

[Code] Pattern of the read positional data(APA high-order digit)

[Probable Faulty Locations]

- 1) Position encoder of the problem axis
- 2) SVP hardware of the problem axis
- 3) Timing signal from the NC unit

**★ 3018 SVP cannot plant error offset data**

When the extended pitch error compensation function is provided, the SVP memory does not have enough capacity for storing the data.

[Index] AXIS

[Probable Faulty Locations]

- 1) SVP board controlling the problem axis
- 2) Extended pitch error compensation file containing extended pitch error compensation data of the problem axis

**★ 3019 SVP encoder application (MOTOR SHAFT)**

The encoder type mounted on the motor does not conform to the encoder accuracy data.

[Index] AXIS

**★ 3020 SVP encoder application (WITH SHAFT)**

The encoder type mounted on the shaft does not conform to the encoder accuracy data.

[Index] AXIS

★ 3021 **SVP collision detection**

The SVP has detected collision of the driving unit with something.

[Index] AXIS

[Code] YYYYZZZZ

YYYY: Average motor output torque

ZZZZ: Average motor acceleration

★ 3022 **SVP SA overload**

The servo amplifier has overheated exceeding the protection curve set in the SVP control software.

[Index] AXIS

[Code] YYYYZZZZ

YYYY: Set value of the protection curve used for overload detection

ZZZZ: Detected value [n] at overload detection

[Probable Faulty Locations] Servo amplifier of the problem axis

★ 3023 **SVP SA communication error**

Abnormality has occurred in communication between SVP and servo amplifier.

[Index] AXIS

[Code] Cause indication number

1-> Parity error in SVP

2-> The sent data does not match the received data.

3-> Servo amplifier ID is not properly received.

4-> No signal is sent from the servo amplifier

5-> Parity error has occurred in servo amplifier.

[Probable Faulty Locations] Servo amplifier of the problem axis

★ 3024 **SVP SA version error**

Version check by the amplifier version control function proved that the mounted servo amplifier version is newer than the versions applicable to the SVP software.

[Index] AXIS

[Code] Version data

10000000->BLII-D is mounted though BL-D is required.

XXYYZZ:

XX: SVP version

YY: Servo amplifier version applicable to SVP

ZZ: Servo amplifier version

[Probable Faulty Locations]

1) Servo amplifier of the problem axis.

2) A wrong version of servo amplifier was mounted.

★ 3025 **SVP SA motor current overload**

The servo amplifier has detected an excessive current flow in the motor cables. A warning lamp IOCM on the servo amplifier is lit.

[Index] AXIS

[Probable Faulty Locations] Servo amplifier of the problem axis



★ 3026 **SVP SA inverter bridge short circuit**

The servo amplifier has detected short-circuit of the inverter bridge in the amplifier. A warning lamp IOCS on the servo amplifier is lit.

[Index] AXIS

[Probable Faulty Locations] Servo amplifier of the problem axis

★ 3027 **SVP SA overheating**

The servo amplifier has detected overheating of the amplifier.  
A warning lamp SVTH on the servo amplifier is lit.

[Index] AXIS

[Probable Faulty Locations] Servo amplifier of the problem axis

★ 3028 **SVP SA power circuit overvoltage**

The servo amplifier has detected overvoltage applied to the power circuit of the amplifier. A warning lamp HV on the servo amplifier is lit.

[Index] AXIS

[Probable Faulty Locations] Servo amplifier of the problem axis

★ 3029 **SVP SA power circuit low voltage**

The servo amplifier has detected voltage drop in the amplifier power circuit. A warning lamp LV on the servo amplifier is lit.

[Index] AXIS

[Probable Faulty Locations] Servo amplifier of the problem axis

★ 3030 **SVP SA regenerative resistor overheat**

The servo amplifier has detected excessive power consumption in the regenerative resistance of the amplifier. A warning lamp DROH on the servo amplifier is lit.

[Index] AXIS

[Probable Faulty Locations] Servo amplifier of the problem axis

★ 3031 **SVP control circuit power voltage**

The servo amplifier has detected the abnormal voltage applied to the amplifier control circuit. A warning lamp VR on the servo amplifier is lit.

[Index] AXIS

[Probable Faulty Locations] Servo amplifier of the problem axis

★ 3032 **SVP SA error**

The servo amplifier is in some trouble.

[Index] AXIS

[Probable Faulty Locations] Servo amplifier of the problem axis

★ 3033 **SVP board version error**

The SVP hardware version is wrong.

[Index] AXIS

[Code]

1-> SVP hardware ID is not 1.

[Probable Faulty Locations]

1-> SVP board controlling the problem axis.

2-> A wrong version of SVP was mounted.

★ 3034 **SVP control error**

The SVP board is in a trouble related to the axis control.

[Index] AXIS

[Code] Alarm data

[Probable Faulty Locations] SVP software controlling the problem axis

★ 3035 **CRP exception**

An exception error occurred on the CRP board.

[Code] XYYY

XX:

bit7-> RAM check error exception

bit6-> Always 0

bit5-> Bus error exception

bit4-> Address error exception

bit3-> Illegal instruction exception

bit2-> Zero divide exception

bit1-> CHK instruction exception

bit0-> TRAPV instruction exception

YY:

bit7-> Privilege violation exception

bit6-> Trace exception

bit5-> Unexecuted instruction exception

bit4-> Undesignated exception

bit3-> Uninitialized, spurious interrupt exception

bit2-> Unused interrupt exception

bit1-> TRAP instruction exception

bit0-> User interrupt exception

[Probable Faulty Locations] Defective CRP board

★ 3036 **CRP diagnosis**

The CRP board self-diagnosis proved the board to be in abnormal state.

[Code] Self-diagnostic data

[Probable Faulty Locations] Defective CRP board

★ 3051 **ACP exception**

An ACP exception error occurred.

[Code] XXXX

bit0-> User break

bit1-> TRAP instruction error

bit2-> Unused interruption

bit3-> 0 (fixed)

bit4-> 0 (fixed)

bit5-> 0 (fixed)

bit6-> 0 (fixed)

bit7-> 0 (fixed)

bit8-> 0 (fixed)

bit9-> Exceptional processing of general illegal instruction in ACPB

bit10-> Exceptional processing of slot illegal instruction in ACPB

bit11-> CPU address error in ACPB  
bit12->DMA address error in ACPB  
bit13->NMI generated in ACPB. Shared memory parity  
bit14->0 (fixed)  
bit15->RAM check error caused with the power ON

[Probable Faulty Locations]

- 1) Defective ACP board
- 2) Defective operation panel

[Measures to Take]

- 1) Replace the ACP board.
- 2) Replace the operation panel.

**★ 3052 ACP diagnosis**

The ACP board self-diagnosis proved the board to be in abnormal state.

[Code] Self-diagnostic data

[Probable Faulty Locations] Defective ACP board

[Measures to Take] Replace the ACP board.

**★ 3150 MCS Undefined alarm number**

The MCS caused an error related with axis control.

[Index] Axis name or none (spindle)

[Character-string] Alarm number in decimal

[Code] Alarm code

[Probable Faulty Locations]

- Depends on the number indicated in the character-string.  
Inform us of the code and the character string.

**★ 3151 MCS Exception processing**

A fatal alarm occurred while the MCS inverter unit and MCS software are executing their processing.

[Index] Axis name or none (spindle)

[Character-string] Cause of alarm detected

"#1"-> Control board error  
"#2"-> Voltage drop of +-12 V battery for control board  
"#3"-> OPF error  
"#11"->Voltage drop of 5 V battery for control board  
"#12"->Inverter bridge shorted  
"#13"->IPM protective function activated  
"#14"->Motor overcurrent  
"#20"->INT loop error  
"#21"->INT5 loop error  
"#22"->INT4 loop error  
"#23"->INT3 loop error  
"#24"->INT2 loop error  
"#25"->INT1 loop error  
"#26"->Access denied  
"#27"->Ram check error in initialization  
"#28"->Party error  
"#29"->Watchdog error

"#30"->IRQ7 interruption  
"#31"->NMI interruption  
"#32"->General illegal command  
"#33"->Slot illegal command  
"#34"->CPU address error  
"#35"->DMA address error  
"#36"->Undefined trap error  
"#37"->Undefined interruption  
"#38"->DMAC  
"#39"->ITU  
"#40"->SCI  
"#41"->REF  
"#42"->A/D  
"#43"->System reserved  
"#44"->User break

[Code]

In the case of #1, the code shows the error content of the control board.

In the case of #3, the code shows the error content of the optional program file.

- 1-> Identification code "OPF1" error
- 2-> End code "ED" error
- 3-> Sum check error
- 4-> Board name error

In the case of #11-14, #20-21, #25-26 and #30-31, the code shows the data in the error status register.

[Probable Faulty Locations]

In the case of #1,

- Inverter unit

In the case of #3,

- Optional program file
- Optional program file incompatible with inverter unit

In the case of #2 or #11,

- Power unit (when this alarm occurred in several inverter units)

In the case of #12, #13, or #14,

- Inverter unit

In other cases,

- Inverter unit

★ 3152 MCS Processing trouble

MCS

[Index] Axis name or none (spindle)

[Character-string] None

[Code] XXZZAAAA

XX:

- 04-> The self-diagnostic data has an error. (ZZ: Received data)
- 06-> Software sync bit or format code of buffer A is wrong.
- 07-> Software sync bit or format code of buffer B is wrong.
- 08-> An error occurred in data communication.

ZZ shows the data kind. AAAA is always 0.

ZZ:

- 1-> Speed command (8408)
- 2-> Laser linear scale value (4413)
- 3-> Backlash (4406)
- 4-> Actual position without positioning error compensation (440A)
- 5-> Positioning error compensation amount
- 6-> Full-closed loop encoder value (4410)
- 7-> Semi-closed loop encoder value (4411)
- 8-> ODIFF (4415)
- 10-> APA in divided stroke (4404)
- 11-> Acceleration/deceleration time for positioning (4422)
- 12-> Zero offset amount
- 13-> In-position width (4420)
- 14-> Maximum of divided stroke (4405)
- 15-> Point data change

[Probable Faulty Locations]

- Faulty MCS controller
- Faulty software

**★ 3153 MCS CON APA deviation**

Difference between CON and APA values has exceeded the allowable limit. The CON-APC deviation is the absolute value of difference between [calculated value written in MCS] and [actual position read from MCS]. The NC control software monitors this deviation. The MCS normally monitors DIFF value.

This alarm appears if the MCS causes a fatal error and cannot monitor the DIFF value.

[Index] Axis name

[Character-string] None

[Code] Absolute value of deviation in hexadecimal (reference unit)

[Probable Faulty Locations]

- Faulty MCS controller
- Mismatch between MCS data and NC data

**★ 3154 MCS Power-Supply-Unit Error**

The power unit caused an error.

[Index] Axis name or none (spindle)

[Character-string] None

[Code] AAAAAAXX

AAAAAA is always 0.

X Alarm number

- 0-> DC voltage alarm
- 1-> Abnormal input voltage
- 2-> Abnormal control power
- 3-> Abnormal control status
- 4-> Overload in regenerative circuit
- 5-> Heat sink overheat
- 6-> CPU error
- 7-> Spare

Y: Power unit status

bit3 1->An alarm occurred in the power unit. (Warning signal status: 0)

bit2 1->DC power is being supplied

bit1 1->OPRON input is closed

bit0 1->PWON input is closed.

ZZ: Data

X (alarm No.):0 ... Detected DC voltage in hexadecimal [3.9V]

X (alarm No.):1 ... Detected AC voltage in hexadecimal [3.1V]

X (alarm No.):2

1-> +5V abnormal voltage

2-> +12V abnormal voltage

3-> -12V abnormal voltage

X (alarm No.):3

1-> Converter over current

2-> Abnormal power element

3-> Converter short circuit

4-> Abnormal regenerative circuit(type in power regenerative circuit)

5-> Abnormal regenerative circuit(type in resistor discharge)

X (alarm No.):4 Uncertain

X (alarm No.):5 Uncertain

X (alarm No.):6 Uncertain

[Probable Faulty Locations]

In the case of abnormal control power,

- Power unit

In the case of low voltage,

- Input voltage drop, power failure, blown fuse in input power circuit, or instantaneous power interruption

In the case of high voltage

- Power unit

#### ★ 3155 MCS Converter-link error

The convertor link (used for communication between power unit and inverter unit) caused an error, disabling the NC from monitoring the power unit condition.

[Index] Axis name or none (spindle)

[Character-string] None

[Code] XAAAAAYY

AAAAA is always 0.

X=0:communication error

X=1:Time-out error (communication interrupted)

YY=communication status

When X is ONE(1),always 0

[Probable Faulty Locations]

- Converter link cables or connectors
- Power unit
- Inverter unit control board

#### ★ 3156 MCS DC-bus voltage alarm

The DC-bus voltage in the inverter unit has abnormally risen or fallen, disabling the inverter from supplying the current.

[Index] Axis name or none (spindle)

[Character-string] None

[Code] XXXXYYYY

XXXX=Detected overvoltage in hexadecimal [15.3 mV]

YYYY=Detected undervoltage in hexadecimal [15.3 mV]

[Probable Faulty Locations]

In the case of voltage rise,

- Power unit

In the case of voltage drop,

- Power unit
- Invertor unit
- Instantaneous power interruption

**★ 3157 MCS Motor over current**

The invertor unit has detected excessive current flowing in the motor cable.

[Index] Axis name or none (spindle)

[Character-string] None

[Code] XXXXYYYY

XXXX=U-phase current detected when this alarm occurs,expressed in signed hexadecimal [Tolerance: 3FFF]

YYYY=V-phase current detected when this alarm occurs,expressed in signed hexadecimal [Tolerance: 3FFF]

[Probable Faulty Locations]

- Invertor unit
- Faulty motor insulation

**★ 3158 MCS Power unit over heat**

The invertor unit has detected excessive current flowing in the motor cable.

The invertor unit temperature has risen abnormally.

[Index] Axis name or none (spindle)

[Character-string] None

[Code] 1 (fixed)

[Probable Faulty Locations]

- Invertor unit
- Overload operation

**★ 3159 MCS Power unit over load**

The invertor load has exceeded the specified value, activating the overload protection function.

[Index] Axis name or none (spindle)

[Character-string] None

[Code] YYYYZZZZ

YYYY-> Gamma of the protection curve used to detect overload

ZZZZ-> Internally calculated overload data

[Probable Faulty Locations]

- Invertor unit
- Overload operation

**★ 3160 MCS Supply voltage flutter**

The power unit input voltage is abnormally high or low.

[Index] Axis name or none (spindle)

[Character-string] None

[Code] Detected abnormal voltage in hexadecimal [Volt]

[Probable Faulty Locations]

- Power unit
- Power cables or connectors
- Instantaneous power interruption

**★ 3161 MCS Power unit version error**

The inverter unit allowable current is smaller than the current limit specified in the servo data file.

[Index] Axis name or none (spindle)

[Character-string] None

[Code] 1 (fixed)

[Probable Faulty Locations]

- Inverter unit
- Servo data file

**★ 3162 MCS Winding-change failed**

The winding-change magnet switch does not come on.

[Index] Axis name or none (spindle)

[Character-string] None

[Code] YYYYZZZZ

If YYYY = 0000

ZZZZ = 0001: Magnet conductor for low-speed winding is ON.

ZZZZ = 0002: Magnet conductor for high-speed winding is ON.

ZZZZ = 0003: Magnet conductors for both windings are ON.

ZZZZ = 0004: Winding change time-out

If YYYY = 1010

ZZZZ = 0001: Faulty servo data file

[Probable Faulty Locations]

- Winding-change magnet switch

**★ 3163 MCS Encoder-link error**

An error occurred in the encoder communication link, disabling the encoder from detecting positioning speed.

[Index] Axis name or none (spindle)

[Character-string] None

[Code] XXYYZZZZ

XX = FF (fixed)

YY = 00: Error is detected at the motor encoder.

01: Error is detected at the position encoder with shaft.

02: Error is detected at the independent position encoder.

03: Error is detected at ABSO SCALE.

ZZZZ=Encoder link error status at the time of error detection.

Each bit represents the kind of communication error.

bit 15 1: Error in communication with a stand-alone encoder

bit 14 1: Error in communication with ABSO SCALE 2

bit 13 1: Error in communication with ABSO SCALE or encoder with shaft

bit 12 1: Error in communication with motor encoder

bit 11 1: Undefined

bit 10 1: Transmission loop error in AT (auto) mode



- bit 9 1: Data over error in data receiving part of interface
- bit 8 1: Undefined
- bit 7 1: Undefined
- bit 6 1: Modulation code error
- bit 5 1: CRC error
- bit 4 1: Format error
- bit 3 1: Double transmission error
- bit 2 1: Double reception error
- bit 1 1: Parity error
- bit 0 1: Time-out error

[Probable Faulty Locations]

- Motor encoder, ABSO SCALE, encoder with shaft, or stand-alone encoder of the problem axis
- Encoder link cables or connectors
- Invertor unit control board

**★ 3164 MCS Encoder error**

The motor encoder has become unable to detect positional data.

[Index] Axis name or none (spindle)

[Character-string] None

[Code] XXYYZZZZ

XX= Encoder error code depending on the encoder type

YY= Detailed encoder status. The status varies with the encoder type.

ZZZZ= Multi-turn position data. This data appears when the multi-turn position data has exceeded the rotating range.

XX= 0 (fixed)

YY= 1 (fixed)

ZZZZ= Multi-turn position data

[Probable Faulty Locations]

- Motor encoder

**★ 3165 MCS Encoder initialize failed**

An error occurred in initialization of the motor encoder.

[Index] Axis name or none (spindle)

[Character-string] None

[Code] XXYYZZZZ

XX= Encoder link sequence number at the time of error detection

0-> Reset

1-> Network address setting

2-> Request of basic information on communication

3-> Change of communication version

4-> Acquisition of device information

5-> Parameter change

6-> AT (auto) mode start

YY= Error content

0-> Communication error

1-> Transmission start time over

2-> Transmission finish time over

3-> Reception finish time over

- 4-> Abnormal response address
- 5-> Abnormal response code
- 6-> Parameter error

ZZZZ= Additional data

If YY=0, the encoder link error status C2ERR at the time of error detection appears.

If YY=1, 2, or 3, the transferred frame information QC2MTINF appears.

If YY=4, the network address of the responding device appears.

If YY=5, the received frame information QC2RXINF appears.

If YY=6, the number of parameter that caused the alarm appears.

1= Not all the necessary parameters are received.

2= Basic information on communication is incompatible.

3= Multi-rotation detection range does not match.

[Probable Faulty Locations]

- Motor encoder
- Encoder link cables or connectors
- Invertor unit control board

**★ 3166 MCS Encoder with shaft error**

The encoder with shaft has become unable to detect positional data.

[Index] Axis name or none (spindle)

[Character-string] None

[Code] Same with <MCS Encoder error>

[Probable Faulty Locations]

- Encoder with shaft

**★ 3167 MCS Encoder with shaft initial**

An error occurred in initialization of the encoder with shaft.

[Index] Axis name or none (spindle)

[Character-string] None

[Code] Same with <MCS Encoder initialize failed>

[Probable Faulty Locations]

- Encoder with shaft
- Encoder link cables or connectors
- Invertor unit control board

**★ 3168 MCS ABSO SCALE error**

An error occurred in initialization of ABSO SCALE.

[Index] Axis name or none (spindle)

[Character-string] None

[Code] None

[Probable Faulty Locations]

- ABSO SCALE

**★ 3169 MCS ABSO SCALE initialize**

An error occurred in initialization of ABSO SCALE.

[Index] Axis name or none (spindle)

[Character-string] None

[Code] Same with <MCS Encoder initialize failed>

[Probable Faulty Locations]

- ABSO SCALE
- Encoder link cables or connectors
- Invertor unit control board

★ 3170 **MCS Magnetic encoder alarm**

The magnetic pulse generator has become unable to detect the motor speed. Or, the number of magnetic encoder gear teeth does not match the data in the MCS data file.

[Index] Axis name or none (spindle)

[Character-string] None

[Code] XXXXYYYY

XXXX= Error content

A-> A-phase voltage is abnormal.

B-> B-phase voltage is abnormal.

C-> Magnetic encoder data error

Others-> Servo data file set value detected when the count over error occurred in the magnetic encoder  
(No. of PG gear teeth \* 4 - 1)

YYYY= Additional error data (Varies with XXXX.)

If XXXX is A, A-phase voltage appears.

If XXXX is B, B-phase voltage appears.

If XXXX is C, 0 (fixed) appears.

Others-> Detected count value of magnetic encoder (No. of PG gear teeth \* 4 - 1)

[Probable Faulty Locations]

- Magnetic encoder or its wiring, or large gap between magnetic encoder and gear
- Mismatch between the number of gear teeth of magnetic encoder and the servo data file data

★ 3171 **MCS Resolver alarm**

The resolver does not send any signal.

[Index] Axis name or none (spindle)

[Character-string] None

[Code] 1 (fixed)

[Probable Faulty Locations]

- Resolver trouble, or disconnection or contact failure of the resolver cable

★ 3172 **MCS Pulse generator count over**

The PG (pulse generator) count value per one turn differs from the corresponding data specified in servo data file.

[Index] Axis name or none (spindle)

[Character-string] None

[Code] XXXXYYYY

XXXX=PBU set value (Count number for one PG turn)

YYYY=Actual count number

[Probable Faulty Locations]

- Faulty PG
- Mismatch between the number of PG gear teeth and the servo data file data

★ 3173 **MCS Motor over heat**

The motor temperature is abnormally high.

[Index] Axis name or none (spindle)

[Character-string] None

[Code] YYYYZZZZ

YYYY =0 (fixed)

ZZZZ =0010: Motor overheat

ZZZZ =0011: Motor overheat is detected at the motor.

ZZZZ =0012: Motor overheat is detected at the position encoder.

ZZZZ =0013: Motor overheat is detected at the motor and the encoder.

[Probable Faulty Locations]

- Malfunction of VAC motor fan, dirty heat sink, CW/CCW turns and stops at high frequency
- BL motor
- Motor encoder (BL motor detects overheat by its encoder.)

**★ 3174 MCS Servo-link error**

A communication error occurred in the servo link, disabling the servo unit from receiving commands from the NC.

[Index] Axis name or none (spindle)

[Character-string] None

[Code] XXXXYYYY

XXXX=0 (fixed)

YYYY=Bit number indicating the kind of communication error (Servo link error status at the time of error detection)

bit 15 1: 2nd B-buffer error

bit 14 1: 2nd A-buffer error

bit 13 1: 1st B-buffer error

bit 12 1: 1st A-buffer error

bit 11 1: MT buffer error

bit 10 1: Relay processing error

bit 9 1: Data over error in data receiving part of interface

bit 8 1: Disconnection

bit 7 1: Address pointer error

bit 6 1: Modulation code error

bit 5 1: CRC error

bit 4 1: Format error

bit 3 1: Double transmission error

bit 2 1: Double reception error

bit 1 1: Parity error

bit 0 1: Time-out error

[Probable Faulty Locations]

- Invertor unit control board
- Servo link cables or connectors
- FCP board

**★ 3175 MCS Servo-link disconnect**

The servo link is disconnected, disabling the servo unit from receiving commands from the NC.

[Index] Axis name or none (spindle)

[Character-string] None

[Code] XXXXYYYY

XXXX=Disconnected position

0-> Disconnected right in front of the problem unit

8000->Disconnected before the problem unit

YYYY=Servo link error status at the time of error detection

[Probable Faulty Locations]

- Servo cables or connectors
- Inverter unit control board
- FCP board

**★ 3176 MCS Servo-link protocol error**

The NC and the inverter unit exchange commands and responses at constant intervals according to the specified protocol through the servo link. In this communication, a wrong protocol or abnormal timing was used to transfer the data from NC to the inverter unit.

[Index] Axis name or none (spindle)

[Character-string] None

[Code] Number indicating the error content

- 1-> A-buffer Software synchronization error
- 2-> A-buffer Format code error
- 3-> B-buffer Software synchronization error
- 4-> B-buffer Format code error
- 5-> B-buffer Block number error

[Probable Faulty Locations]

- Inverter unit control board
- NC software
- Inverter unit control board not compatible with NC software
- FCP board

**★ 3177 MCS Servo data error**

The servo data sent from the NC for initialization or operation is not applicable to the inverter unit.

If this alarm occurs after change of inverter unit, the servo data file is not applicable to the inverter unit.

If this alarm occurs after adjustment or change of the servo data, the servo data is wrongly changed.

[Index] Axis name or none (spindle)

[Character-string] None

[Code] XXXXYYYY

XXXX=Data ID number of the data that caused the error

YY= Data set number of the data that caused the error

ZZ= Error content

- 1-> Out of setting range
- 2-> Wrongly set timing
- 3-> No transmission
- 4-> Calculation error
- 5-> Others

[Probable Faulty Locations]

- Servo data file not compatible with inverter unit
- Inverter unit not compatible with NC software
- Inverter unit control board
- NC software

★ 3178 **MCS Illegal command**

The NC and the inverter unit exchange commands and responses through the servo link. In this communication, the NC sent an abnormal or inexecutable command to the inverter unit.

[Index] Axis name or none (spindle)

[Character-string] None

[Code] XXXXYYYY

XXXX=

- 10-> Positioning mode Command point number over
- 11-> Positioning mode Negative command value
- 12-> Positioning mode Larger command value (specified position > 360 deg for rotary axis)
- 13-> Positioning mode RPositioning point table not transmitted
- 14-> Positioning mode Non-rotating axis
- 15-> Positioning mode Command format other than points
- 16-> Positioning mode Positioning sub-mode error
- 21-> Parameter change Parameter number out of specifiable range
- 22-> Mode Undefined mode
- 23-> Mode Positioning/tool path mode condition
- 24-> Coordinate system Coordinate system designation error
- 30-> Unused bit is ON in the bit commands for controlling the S-link A buffer.
- 31-> Unused bit is ON among the bit data in the S-link B buffer.
- 40-> AT mode is selected without reception of time synchronization command.

YYYY= Error data

X in the range from 10 to 16 shows the positioning sub-mode.

0-> Program mode 1:Search mode 2:PH mode 3:Teach mode

[Probable Faulty Locations]

- Inverter unit not compatible with NC software
- Inverter unit control board
- NC software

★ 3179 **MCS CON speed over**

Increments for positioning command (SRCOND) issued from the NC to the inverter unit exceed the allowable limit.

If this alarm occurs in the axis to be positioned, the servo data file has wrong data. (This is because the inverter unit calculates the increments for the axis to be positioned.)

[Index] Axis name or none (spindle)

[Character-string] None

[Code]

Absolute value of increments processed for acceleration/deceleration  $[(pr/65536)/Tp]$

Where, pr= One turn of position encoder; Tp= Position control frequency

The following codes, however, have specific meanings:

- 1-> The increments were so large that they were judged erroneous in preliminary check.
- 2-> The position command (SRCON) exceeds the absolute value of the encoder measuring range (linear axis only).

[Probable Faulty Locations]

- Servo data file
- NC software

★ 3180 **MCS Speed command over**

Speed command value issued from the NC to the inverter unit exceeds the allowable limit.

[Index] Axis name or none (spindle)

[Character-string] None

[Code] Speed command [(rev/4294967269)/Tv]

rev= One motor turn; Tv= Speed control frequency

[Probable Faulty Locations]

- Servo data file
- NC software

★ 3181 **MCS DIFF over**

Axis movement caused a large positioning error.

While the axis is in a target position or stopped, the target value and the calculated value are the same. With an axis movement command, the NC starts creating calculation values (RCON) until the target point is reached. At this time, the actual position follows the calculated value with a certain delay. This delay is called "following error" and calculated by ([calculation value] - [actual value]). If the "following error" exceeds the allowable limit, the above alarm occurs.

[Index] Axis name or none (spindle)

[Character-string] None

[Code] Absolute value of following error [pr/65536]

pr = One turn of position encoder

[Probable Faulty Locations]

- Overload due to faulty ball screw or bearing
- Motor
- Inverter unit
- Servo data file

★ 3182 **MCS APA speed over**

The position encoder value (RAPA) changes as the motor rotates.

The NC checks this change with preset frequency.

This alarm occurs if the change per unit time exceeds the allowable range consecutively. For example, an axis feedrate is abnormally high compared with the normal rapid feedrate, or the encoder value changes irregularly due to malfunction of the position encoder.

[Index] Axis name or none (spindle)

[Character-string] None

[Code]

Absolute value of the change in encoder value per position control frequency [encoder's 1/65536 turn/position control frequency]

The following codes, however, have specific meanings:

- 1= Linear axis has exceeded its travel range.
- 2= Rotary axis has exceeded its travel range (360 deg) or limited axis has negative positional data.
- 3= Limited axis has exceeded its travel range.

[Probable Faulty Locations]

- Motor encoder (BL motor)
- Encoder link cables or connectors (BL motor)
- PG or magnetic encoder (VAC motor)
- PG or magnetic encoder cables or connectors (VAC motor)
- Inverter unit control board

★ 3183 **MCS Full-closed APA error**

Difference between the full-closed loop encoder value and the motor encoder value exceeds the allowable range.

[Index] Axis name or none (spindle)

[Character-string] None

[Code] Number of times the error has been detected

[Probable Faulty Locations]

- Synthetic offset data is not set at the full-closed loop encoder or wrong data is set.
- ABSO SCALE or position encoder with shaft
- Excessive lost motion in axis drive system (The motor is not rigidly connected with the movable part.)
- Slippage or breakage of shaft belt
- Loose coupling between motor and ball screw
- Improper positional loop gain (too high)

★ 3184 **MCS Over speed**

Actual motor speed is too high.

[Index] Axis name or none (spindle)

[Character-string] None

[Code]

Motor speed detected when this alarm occurred [(rev/4294967296)/Tv]

Where, rev= One motor turn; Tv= Speed control frequency

[Probable Faulty Locations]

- Motor encoder (BL motor)
- Encoder link cables or connectors (VAC motor)
- Resolver or magnetic encoder (VAC motor)
- Resolver or magnetic encoder cables or connectors (VAC motor)
- Invertor unit control board

★ 3185 **MCS Velocity deviation over**

Actual motor speed excessively deviates from the speed command.

[Index] Axis name or none (spindle)

[Character-string] None

[Code] XXXXYYYY

XXXX: Detected torque (sum of the torque data collected for 3.2 ms)

$\pm 2^{-12}[\text{MAXTRQ}]$

If Tv = 0.4 ms, the momentary maximum torque is H'7FFF.

If Tv = 0.8 ms, the momentary maximum torque is H'3FFF.

YYYY: Detected acceleration (average value measured for 3.2 ms)

$\pm 2^{-16}[\text{vr}/3.2 \text{ ms}/3.2 \text{ ms}]$

= about 0.1 [rpm/ms]

The code number 00000001 means that the error data is replaced by zero because of exponent underflow.

[Probable Faulty Locations]

- The motor does not turn because of (mechanical lock or) application of large load.



★ 3186 **MCS Collision detected**

The NC torque limiter has detected collision of axis by monitoring the relation between motor output torque and motor acceleration.

[Index] Axis name or none (spindle)

[Character-string] None

[Code] XXXXYYYY

XXXX: Detected torque (sum of torque data collected for 3.2 ms)

+2<sup>-12</sup>[MAXTRQ]

If Tv = 0.4 ms, the momentary maximum torque is H'7FFF.

If Tv = 0.8 ms, the momentary maximum torque is H'3FFF.

YYYY: Detected acceleration (average torque measured for 3.2 ms)

+2<sup>-16</sup>[vr/3.2 ms/3.2 ms]

= about 0.1 [rpm/ms]

[Probable Faulty Locations]

- Collision
- Motor encoder
- NC torque limiter set value

★ 3187 **MCS Urgent-stop time over**

The axis cannot stop within a preset time after reception of emergency stop command.

[Index] Axis name or none (spindle)

[Character-string] None

[Code] XXXXXXXX

1-> Emergency stop time over

2-> Deceleration time over at emergency stop

3-> Deceleration time over at alarm stop

YYYY = Speed command value executed on detection of the error  
(hexadecimal number in unit of rev/Tv)

[Probable Faulty Locations]

- Invertor unit control board
- NC software

★ 3188 **MCS Belt is broken**

Breakage of belt was detected in the belt-driven axis.

[Index] Axis name or none (spindle)

[Character-string] None

[Code] Load torque (hexadecimal) at the time of alarm detection

[Probable Faulty Locations]

- Broken belt

★ 3189 **MCS Axis change control error**

Axis change was not performed normally. (This is not an alarm caused in MCS.)

[Index]Axis to be selected by axis change

[Character-string]None

[Code]

1-> MCS was not reset within 10[s].

2-> Parameter set numbers matching signal or the control ready signal failed to come ON within 10[s].

- 3-> MCS failed to receive maximum APA value from the split encoder within 10[s].
- 6-> MCS controller failed to change in-position amount or zero offset amount within 10[s].
- A-> MCS controller failed to change in-position amount or zero offset amount within 10[s] after alarm occurrence.

[Probable Faulty Locations]

- Faulty MCS controller for PLC axis
- Faulty software

**★ 3190 MCS independent encoder init**

An error occurred during initialization of the MCS independent encoder.

[Index] Axis name or none (spindle)

[Character-string] None

[Code] XXYYZZZZ

XX-> Encoder link sequence number

- 0: Reset
- 1: Net address setting
- 2: Request to send the basic information for communication
- 3: Change of communication software version
- 4: Acquisition of device information
- 5: Parameter change
- 6: AT mode start

YY-> Alarm content

- 0: Communication error
- 1: Transmission start time over
- 2: Transmission end time over
- 3: Reception end time over
- 4: Wrong response address
- 5: Wrong response code
- 6: Parameter error

ZZZZ-> Data

YY = 0: Encoder link error status C2ERR established on detection of the error

YY = 1, 2, or 3: Transmitted frame information QC2MTINF

YY = 4: Net address of the corresponding device

YY = 5: Received frame information QC2RXINF

YY = 6: Parameter number at which the error is detected

- 1 = Reception of insufficient number of parameters
- 2 = Basic information for communication being incompatible
- 3 = Multi-turn detection range over

[Probable Faulty Locations]

- Independent position encoder
- Encoder link cables and connectors
- Inverter unit control board

**★ 3191 MCS APA error**

An error occurred during calculation of APA value.

[Index] Axis name or none (spindle)

[Character-string] None

[Code] XXXXXXXX

- 1-> Linear axis divided travel over
- 2-> Overflow during conversion of semi-position from [pr] to pf].
- 3-> Underflow in synthesizing the axis data
- 4-> Overflow in synthesizing the axis data
- 5-> Overflow of input values used for hybrid control
- 6-> Overflow during initialization for hybrid control

[Probable Faulty Locations]

- Motor encoder, encoder with shaft, or ABSO SCALE
- Invertor unit control board
- Servo data file

If the alarm code is "1" or "3", the position encoder may not be properly offset

If the alarm code is "4", the servo data file may be defective.

If the alarm code is "5" or "6", the motor coupling, encoder with shaft, or ABSO SCALE may be loosely mounted.

**★ 3192 MCS Motor over load**

The motor load has exceeded the preset value, activating the overload protection function.

[Index] Axis name or none (spindle)

[Character-string] None

[Code] YYYYZZZZ

YYYY-> Gamma of the protection curve used to detect overload

ZZZZ-> Internally calculated overload data

[Probable Faulty Locations]

- Motor
- Overload caused by machine operation
- Servo data file

**★ 3200 Power saving**

Power saving mode entered after the elapse of time set by parameter.

[Code]

Time set by parameter (in hexadecimal) (in units of [min])

Machine user parameter (word) No. 6

**★ 3201 Spindle blower motor overload**

With the DC spindle drive motor specification, the overload relay for the spindle motor cooling fan motor is tripped.

[Probable Faulty Locations] Defective blower motor

**★ 3202 CPU temperature rising**

Temperature inside the control enclosure is higher than 60(Centigrade).

[Probable Faulty Locations]

- 1) Cooling fan motor for the control enclosure is not operating.
- 2) Cooling duct filter is clogged.

**★ 3203 Hydraulic oil temperature rising**

Abnormally high hydraulic oil temperature

This alarm occurs when the normal oil temperature signal, output from the hydraulic unit (combination unit) at the back of the column, is turned off.

The temperature switch is turned off at 60(Centigrade) or higher.

[Probable Faulty Locations]

- 1) Hydraulic power unit filter is clogged.

2) Hydraulic power unit cooling fan motor is not operating.

★ 3204 **Hydraulic oil level low**

Low hydraulic power unit tank oil level

This alarm occurs when the normal oil level signal, output from the hydraulic unit (combination unit) at the back of the column, is turned off.

[Measures to Take] Supply hydraulic oil.

★ 3205 **Spindle lube level low**

Low spindle lubricating oil level

This alarm occurs when the normal cooling oil level signal, output from the hydraulic unit (combination unit) at the back of the column, is turned off.

[Measures to Take] Supply spindlehead lubricating oil.

★ 3206 **Coolant level low**

Low coolant level

This alarm occurs when the normal coolant level signal, output from the float switch in the coolant tank, is turned off when a coolant or through-the-tool coolant command is designated.

S-20-> The coolant tank (clean tank) level is low. The coolant tank level normal signal (CLP/) is OFF.

[Measures to Take] Supply coolant.

★ 3207 **Axis lube level low**

Low axis lubricating oil level

This alarm occurs when the normal centralized lubricating oil level signal, output from the X/Y/Z slideway lubricating oil tank float switch, is turned off.

The low lubrication oil level signal, when turned on, also causes this alarm.

(1) MC-30VA

An alarm occurs when the oil level normal signal is turned off.

(2) MC-40VA/50VA/60VA

An alarm occurs when the oil level normal signal is turned off.

(3) MC-400H

An alarm occurs when lubricating oil level normal signal is turned off.

(4) MC-500H/600H/800H

An alarm occurs when the oil level normal signal is turned off.

(5) MDB-A/B, MCV-A/B, MCR, MCM

a) X-, Y-, and Z-axis lubrication

An alarm occurs when the lubricating oil level drops below the lower limit.

b) APC lubrication

An alarm occurs when the lubricating oil level drops below the lower limit.

(6) S-20

An alarm occurs when the lubricating oil tank level low signal (LBLV) is turned on.

[Character-string] None X-, Y-, and Z-axis lubrication

APC APC lubrication

[Measures to Take] Supply lubricating oil.

★ 3208 **ATC system condition**

During execution of the ATC (AT-ATC) cycle, ATC input information does not match the ATC sequence advance conditions (indicated in the ATC input logic chart) in three[min].

S-30-> During execution of the ATC (AT-ATC) cycle, ATC input information does not match the ATC

sequence advance conditions (indicated in the ATC input logic chart) in parameter setting time.

[Code] XYZZ:

X:

None->Input conditions are not turned on.

1-> Input conditions are not turned off.

Y: Hexadecimal number of the byte number in input logic chart

ZZ: Bit position in input logic chart

**★ 3209 APC system condition**

During execution of the APC cycle, APC input information does not match the APC sequence advance conditions (indicated in the APC input logic chart) in two[s].

[Code] XYZZ:

X:

None->Input conditions are not turned on.

1-> Input conditions are not turned off.

Y: Hexadecimal number of the byte number in input logic chart

ZZ: Bit position in input logic chart

**★ 3210 CPU voltage low**

Input voltage for the CPU power supply drops below 170 VAC.

[Probable Faulty Locations]

- 1) Insufficient 200 VAC power supply capacity
- 2) Voltage drop due to start up of other equipment
- 3) Defective CPU power supply

[Measures to Take]

- 1) Check variation in main power supply.
- 2) Replace power supply.

**★ 3211 Power source unit overload**

The circuit breaker (CB4) for lighting inside the EC power unit is actuated.

[Probable Faulty Locations]

Lighting cable is either shorted or connected to the ground.

**★ 3212 Spindle drive motor brush wear**

With the DC spindle drive motor specification model, the brushb in the spindle drive motor is worn.

[Measures to Take] Replace the brush.

**★ 3213 No original command tool**

The original tool for the active tool management number is not found.

[Probable Faulty Locations]

Original tool with the tool group number identical to the commanded active tool management number is not registered.

[Measures to Take]

- 1) Register the original tool.
- 2) Clear the tool group number to zero (0).
- 3) Change the active tool management number to the original tool.

[Related Specifications] Tool management function

★ 3214 **Chip conveyor motor overload**

The overload relay for the chip conveyor motor is tripped.

★ 3215 **AAC1 system condition**

During execution of the AAC (floor-type) cycle, AAC input information does not match the AAC sequence advance conditions (indicated in the AAC input logic chart) in four[min].

[Code] XYZZ

X:

None->Input conditions are not turned on.

1-> Input conditions are not turned off.

Y: Hexadecimal number of the byte number in input logic chart

ZZ: Bit position in input logic chart

★ 3216 **AAC2 system condition**

During execution of the AAC (table-type) cycle, AAC input information does not match the AAC sequence advance conditions (indicated in the AAC2 input logic chart) in four[min].

[Code] XYZZ:

X:

None->Input conditions are not turned on.

1-> Input conditions are not turned off.

Y: Hexadecimal number of the byte number in input logic chart

ZZ: Bit position in input logic chart

★ 3217 **LTC system condition**

During execution of the LTC cycle, LTC input information does not match the LTC sequence advance conditions (indicated in the LTC input logic chart) in four[min].

[Code] XYZZ:

X:

None->Input conditions are not turned on.

1-> Input conditions are not turned off.

Y: Hexadecimal of the byte number in input logic chart

ZZ: Bit position in input logic chart

★ 3218 **DNC start condition**

In the DNC-B mode operation, communications cannot be done normally.

[Code]

1-> In the DNC-B buffer operation mode, the system is not in the ready state or the communication alarm state.

2-> In the DNC-B buffer operation mode, the schedule program is being executed.

5-> The main program buffer size is not greater than 12 m when the program runs using the buffer memory.

[Measures to Take] Turn the DNC mode ON after pressing the RESET button.

[Related Specifications] DNC-B

★ 3219 **Outside**

An alarm occurred with an external coupled device such as robot and loader.

An alarm with the loader controller for the machine provided with the robot or the loader.

[Probable Faulty Locations]

1) Problem with the robot or the loader

2) Defective input card

★ 3220 **User reserve code**

With the user task specification, VDOUT[991]=\*\*\*\* is specified in a program.

[Code]

Decimal numbers from 0 to 9999 is allowed for "\*\*\*\*", and display is given with leading zeros suppressed. For a number other than those indicated above, "FFFFFFF" is displayed.

Program Example:

VUACM[1]='ABC' WRITE

VDOUT[991]=1234 WRITE

->3220 Alarm C User reserve code 1234 ABC

[Measures to Take] Clear the alarm by resetting the control.

[Related Specifications] User task

★ 3221 **MSB reserved**

This alarm outputs the check results of the manufacturer's Sub-Program.

[Code]

Refer to the Operation Manual for the relevant manufacturer's Sub-Program.

[Measures to Take]

Check the following items.

- 1) Transfer parameter
- 2) NC status
- 3) Setting data

★ 3222 **Read/Write head movement time over**

The read/write head of TOOL-ID cannot complete advance or retract movement within a preset time.

[Probable Faulty Locations]

- 1) Malfunction of the limit switches for confirming read/write head advance and retract ends
- 2) Incorrect dog position

Too small value is set at the machine system parameter word No. 51 "Read/write head advance timer" or No. 52 "Read/write head retract timer".

★ 3223 **Program select**

In the external program selection operation, an error occurred during the selection of a file name which is input from the ECP or EC board.

[Code]

X:

1-> Automatic mode is not selected.

2-> The command buffer is not empty.

3-> An error when reading a main program in the PDO task.

XYZZAABB:

1) X=1 Automatic select alarm

BB:

Bit0-> No specified schedule program file

Bit1-> No specified main program

Bit2-> No specified subprogram file

Bit3-> No specified main subprogram

Bit4-> No specified subprogram

Bit5-> No M02 or M03 up to the end of main program

Bit6-> No RTS up to the end of subprogram

Bit7-> Program buffer cannot register the entire program.

AA:

- Bit0-> The main program has more than 31 sequence names.
- Bit1-> A sequence name consists of more than five characters including N.
- Bit2-> No subprogram name is specified following CALL statement.
- Bit3-> A subprogram name consists of more than five characters including O.
- Bit4-> G and M code macro program names have not been defined.
- Bit5-> More than 63 subprograms are called.
- Bit6-> A block contains more than 156 characters.
- Bit7-> Main file name and extension have more than 20 characters in total.

ZZ:

- Bit0-> Main file name and extension begin with a numeric character.
- Bit1-> A device name consists of more than three characters or no colon ( : ) is designated following a device name.
- Bit2-> A program name does not begin with "O".
- Bit3-> A program name contains characters other than alphanumeric characters.
- Bit4-> A program name has more than five characters including "O".
- Bit5-> Option designation is made with more than 16 characters.
- Bit6-> Multi-volume file ID is not found within eight characters.
- Bit7-> Request for program selection is found during execution of a schedule program.

Y:

- Bit0-> Request for program selection is found during execution of a main program.
- Bit1-> An attempt to select a program in a mode which is not supported.
- Bit2-> The order number of multi-volume file exceeds 99.
- Bit3-> A floppy disk drive is designated as a device name.

2) X=2 Defective bubble memory

Symbols "\*" and "?" are specified in a file name.

[Measures to Take]

Display the "RUN GUIDE" screen in the EDIT. AUX mode to check the file name for which external program selection was impossible. Then, select the program manually to check the error again.

#### ★ 3224 System check

A check number is set at machine user parameter (word) No. 40 to check the user's special specification function.

[Character-string] The number set at parameter

[Probable Faulty Locations]

The data at machine user parameter (word) No. 40 is not zero (0).

#### ★ 3225 External manual operation

This indicates that operations other than external manual operation are impossible.

Operation Example This alarm message is displayed when the external manual mode is selected.

[Measures to Take]

The alarm state is automatically canceled when the external manual mode is canceled.

[Related Specifications] External manual operation

#### ★ 3226 Coolant-supply-to-cooler motor overload

With the chip flush-out specification:

Coolant is sent to the cooler unit from the coolant tank to cool the coolant. This alarm occurs when the pump normal operation signal of this pump is turned off.

[Probable Faulty Locations]

The overload relay of the pump to feed coolant to the cooler unit is tripped.



[Related Specifications] Chip flush-out specifications

★ 3227 **Warming up**

Program selection for the warmup program cannot be carried out normally.

[Code]

- 1-> The warmup program (W.WAF) is not registered in the bubble memory (BB1:).
- 2-> Although the warmup program is registered in the bubble memory, selection of it is impossible.
- XX=20-> The operation door is open.
- XX=21-> The loader is not at its retract end.

[Probable Faulty Locations]

Contents of the warmup program

Program Example:

OXXX

:

RTS WRITE (must be M02 or M30.)

[Measures to Take] Check the warmup program.

★ 3228 **No tool in TDS read/write pot**

★ 3229 **Air dryer unusual**

The air dryer normal signal has been off for more than one [s].

★ 3230 **DNC initial sequence : impossible**

The initialize disabled [N, INI] text is received in response to the initialize request [C, INI] from the CNC.

★ 3231 **FMS coupling mode change**

The mode has been changed from the independent mode to the coupled mode in other than the automatic operation mode.

[Measures to Take] Designate the AUTO mode.

★ 3232 **Multi volume end code error**

During multi-volume operation, a file other than the end file contains the end of program code M02 or M30.

[Code] 1

[Probable Faulty Locations]

M02 or M30 is specified in a file (\*\*\*-C.MIN) other than the end file.

[Measures to Take]

Correct the file.

Specify M02 or M30 only in the \*\*\*-L.MIN file.

★ 3233 **Manual skip function**

★ 3234 **Interactive gauging : impossible**

The conditions to start the semiautomatic gauging cycle (interactive gauging) are not satisfied.

[Code]

- 1-> Manual axis selection is not correct.
- 2-> The current axis position is other than the zero point of H53 when the probe radius compensation/gauging cycle has been started.

[Probable Faulty Locations] Unsatisfied cycle start conditions

[Measures to Take] Reset the cycle and restart it after all conditions have been set.

★ 3235 **Panel/CRP receive error**

Error with the data received by the CRP transmitted from the operation panel.

[Code]

- Bit0-> ACIA reception error
- Bit1-> Error with check sum of the received data or protocol
- Bit2-> Operation panel serial interface error
- Bit3-> Operation panel switch error
- Bit4-> Operation panel self-diagnosis error

[Probable Faulty Locations]

- 1) Defective operation panel
- 2) Defective CRP

[Measures to Take]

- 1) Replace the operation panel.
- 2) Replace the CRP.

★ 3236 **CRP/panel send error**

Error with the data transmitted from the CRP to the operation panel.

[Code]

- Bit0-> ACIA transmission error
- Bit1-> Error with check sum of the transmitted data or protocol
- Bit2-> Operation panel serial interface error

[Probable Faulty Locations]

- 1) Defective operation panel
- 2) Defective CRP

[Measures to Take]

- 1) Replace the operation panel.
- 2) Replace the CRP.

★ 3237 **Print data output**

An error has occurred during print out of measurement data.

[Character-string] None (output to external device)

[Code]

- 1-> Printer being used
- 2-> Error with external device

[Character-string] Created file name (output to MD1:A.MDF)

[Code]

- 1-> The file is being accessed in program operation mode (in program edit mode).
- 2-> The output device (MD1:) is full.
- 3-> The output file (MD1:A.MDF) is not a sequential file.
- 4-> The output file (MD1:A.MDF) is write-protected.
- 5-> The output file (MD1:A.MDF) has been selected as a file automatically renewed by the schedule program.
- 6-> The output file (MD1:A.MDF) has been selected by program selection of method B.
- 7-> The other error occurred.

[Probable Faulty Locations]

Printer or the other external device

Operation Example:

A print command was issued to a printer in use (or a printer whose RS232C channel is busy) for program list output.

★ 3238 **Chip cleaner**

With the tap-hole chip cleaning specification, the chip cleaner is not functioning normally. This alarm occurs if the unit normal signal from the chip cleaner is turned off.

[Code]

- 1-> The dust collector operation confirmation signal remains off for more than one[s] while the dust collector is operating.
- 2-> The wind volume detection normal signal remains off for more than three[s] while the dust collector is operating.

★ 3239 **Running hour over**

The running hour meter data has exceeded the full count value.

[Code]

- 1-> Alarm with power on time timer
- 2-> Alarm with NC on time timer
- 3-> Alarm with spindle on time timer
- 4-> Alarm with cutting time timer
- 5-> Alarm with external input time timer

[Measures to Take]

- 1) Designate a count value which is smaller than the setting value.
- 2) Designate a setting value which is larger than the count value.
- 3) Designate a setting of "0".

★ 3240 **Work counter over**

The active work counter data has exceeded the full count value.

[Code]

- 1-> Alarm with work counter A
- 2-> Alarm with work counter B
- 3-> Alarm with work counter C
- 4-> Alarm with work counter D

[Measures to Take]

- 1) Designate a count value which is smaller than the setting value.
- 2) Designate a setting value which is larger than the count value.
- 3) Designate a setting of "0".

★ 3241 **BTC system condition**

During execution of the ATC (AT-ATC) cycle for the large diameter tool specification, ATC input information does not match the ATC sequence advance conditions (indicated in the ATC input logic chart) in three[min].

[Code] XYZZ:

X:

None->Input conditions are not turned on.

1-> Input conditions are not turned off.

Y: Hexadecimal number of the byte number in input logic chart

ZZ: Bit position in input logic chart

★ 3242 **MOP CCP error**

An alarm occurred with the CCP board.

[Code]

- 1-> Memory parity error, or write error is found in the memory test.
- 2-> CCP control program loading error

- 3-> CCP control program startup error
- 4-> CCP communication channel cannot be opened.
- 5-> CCP self-diagnosis error
- 6-> CCP CPU exception error
- 7-> CCP task start control error
- 8-> CCP real time task loop error
- 9-> CCP time sharing task change error

[Measures to Take]

- 1) Replace the CCP board.
- 2) Check the CCP control program.

**★ 3243 MOP communication error**

Communication error in communications with the MOP

[Code]

- 1-> Check sum error occurred two times consecutively.
- 2-> Parity error occurred two times consecutively.
- 3-> None
- 4-> No response from the MOP-TOOL
- 5-> DSR signal is turned on.
- 6-9 -> None
- 10-> Overrun error
- 11-> Framing error

[Measures to Take]

- 1) Reset the NC to release the error.
- 2) Check the protocol used in communication with MOP.

**★ 3244 DNC receive text is unallowable**

The received text is not allowed in this system.

[Character-string]

Five characters of transfer command or transfer subcommand at the beginning of the received text

[Probable Faulty Locations] Unacceptable text

[Measures to Take] Check the software of the host computer.

[Related Specifications] DNC-C

**★ 3245 DNC machine No. is unsame**

The received machine number and the machine number registered in the CNC unit do not match.

[Character-string]

Five characters of transfer command or transfer subcommand at the beginning of the received text

[Probable Faulty Locations]

- 1) Unacceptable text
- 2) Setting error of machine number  
(NC optional parameter (word) No. 15) at CNC side

[Related Specifications] DNC-C

**★ 3246 DNC text format error**

Format error in the received text.

[Character-string]

Five characters of transfer command and transfer subcommand at the beginning of the received text

[Probable Faulty Locations] Unacceptable text

[Related Specifications] DNC-C

★ 3247 **DNC receive abort**

An error is detected in the text during reception or analysis of the text.

[Character-string]

Five characters of transfer command and transfer subcommand at the beginning of the received text

[Code]

Content differs depending on the text. For details, refer to the following.

- For D,MST:

1-> Text is received during the interrupt mode, or reception is made without transmitting C,MST.

2-> In the request for automatic mode, response for single mode setting completion is received.

3-> In the request for single mode, response for automatic mode setting completion is received.

- For D,INT:

1-> Text is received during the automatic mode, or reception is made without transmitting C,INT.

2-> In the request for interrupt mode ON, request for interrupt mode OFF is received.

3-> In the request for interrupt mode OFF, request for interrupt mode ON is received.

- For C,OPC:

1-> Reception is made in a mode other than the automatic mode.

2-> Reception is made before responding to all D,OPC for the previous C,OPC.

- For C,EXE:

1-> Automatic mode is not selected.

2-> During alarm occurrence (Alarms higher than level C alarms)

3-> During machine lock mode

4-> During dry run mode

5-> Main program is not selected.

6-> Schedule drive mode is selected.

7-> During operation

9-> Axis cancel

10-> STM lock

- For C,SEL:

1-> Automatic mode is not selected.

2-> Reception is made before responding to the C,SEL command received previously.

3-> During automatic program selection after turning on power

4-> During warming up sequence

5-> During operation

6-> Designated file is not found in the bubble memory.

7-> Error while executing selection (Refer to the error message at the console line for details.)

8-> Illegal file name

- For C,ALM:

1-> Automatic mode is not selected.

- For C,DEL:

1-> Automatic mode is not selected.

2-> Reception is made before responding to the C,DEL command received previously.

3-> Designated file is not found in the bubble memory.

4-> Designated file is protected.

5-> Error while executing deletion (Refer to the error message at the console line for details.)

6-> Illegal file name

- For D,NCP:
  - 1-> Automatic mode is selected, or although the control is in the interrupt mode, reception of NC program is made in C,NCP.
  - 2-> Finish code "%" exists within the NC program.
  - 3-> Finish code "%" does not exist at the end of NC program.
  - 4-> In the automatic mode, at reception, the same file name already exists in the bubble memory and the attempt to delete the name is made but the file is protected.
  - 5-> Error during the reception of NC program (Refer to the error message at the console line.)
  - 6-> Illegal file name
- For N,NCP:
  - 1-> Interrupt mode is not selected, or even in the interrupt mode, reception is made although the request for the NC program with C,NCP is not made.
- For D,MSG:
  - 1-> Automatic mode is not selected.
  - 2-> Display page is other than 0 through 3.
  - 3-> Display starting position in the horizontal direction is other than 0 through 63.
  - 4-> Display starting position in the vertical direction is other than 0 through 13.
- For C,TOF:
  - 1-> Automatic mode is not selected.
  - 2-> Reception is made before responding to the C,TOF received previously.
  - 3->  $1 \leq \text{Transfer starting tool offset number} \leq \text{Transfer completion tool offset number} \leq \text{QTLMX}$  is not satisfied.
- For D,TOF:
  - 1-> Automatic mode is not selected.
  - 2-> Upper and lower limit error in data
  - 3-> Data other than numerical data exists.
- For C,TLM:
  - 1-> Automatic mode is not selected.
  - 2-> Reception is made before responding to the C,TLM command previously received.
  - 3->  $1 \leq \text{Transfer start tool number} \leq \text{Transfer completion tool number} \leq \text{QTLMX}$  is not satisfied.
- For D,TLM:
  - 1-> Automatic mode is not selected.
  - 2-> Upper and lower limit error in data
  - 3-> Data other than numerical data exists.
- For C,COM:
  - 1-> Automatic mode is not selected.
  - 2-> Reception is made before responding to the C,COM command received previously.
  - 3->  $1 \leq \text{Transfer start common variable number} \leq \text{Transmission completion common variable number} \leq \text{QTLMX}$  is not satisfied.
- For D,COM:
  - 1-> Automatic mode is not selected.
  - 2-> Upper and lower limit error in data
  - 3-> Data other than numerical data exists.

[Probable Faulty Locations]

- 1) Error in text data received
- 2) Faulty reception timing

[Related Specifications] DNC-C

★ 3248 **DNC text send abort**

During text transmission, an error which does not allow transmission has occurred.

[Character-string]

Five characters of transfer command or transfer subcommand of the transmitted text

[Code]

Content differs depending on the text. Refer to the following for details.

- For D,NCP:

- 1-> File reading impossible during transmission in the single mode (Refer to the error message at the console line for details.)
- 2-> In the single mode, program to be transferred is not in the bubble memory. (In this case, D,NCP is not transmitted.)
- 3-> In the single mode, main program to be transferred is not selected. (In this case, D,NCP is not transmitted.)

[Probable Faulty Locations]

- 1) Operation error at the CNC side
- 2) Timing error in operation

[Related Specifications] DNC-C

★ 3249 **FMS coupling mode change**

Conditions are not satisfied to change to the automatic mode.

[Code]

- 1-> Automatic operation mode is not selected.

[Measures to Take]

Select the automatic mode.

Then, place the FMS mode switch to AUTO.

[Related Specifications] DNC-C

★ 3250 **FMS HOST CPU alarm**

Alarm is reported from the host computer.

[Character-string] Received alarm number, 4 digits

[Measures to Take]

Take measures according to the contents of the alarm from the host computer.

[Related Specifications] DNC-C

★ 3251 **FMS operation mode select**

When the TRIAL MAC END button is pressed, none of the AUTO/MDI/MANUAL operation modes are selected.

[Measures to Take]

Press the first product machining button after selecting one of the AUTO, MDI and MANUAL modes.

[Related Specifications] DNC-C

★ 3252 **Oil/coolant separator motor overload**

On the machine with chip flusher, the oil/coolant separator used to separate oil from coolant does not send the separator normal signal when used coolant is returned to the coolant tank, resulting in this alarm.

[Probable Faulty Locations] Actuation of the separator motor overload switch

[Related Specifications] Chip flusher specification

★ 3253 **TMP communication abort**

In compensation of thermal deviation, an error has occurred in communication with the temperature sensor (TMP).

[Code]

- 1-> Transmission of temperature data from TMP has not been completed within a interval of request-to-send signal from the NC.
- 2-> No answer is sent from TMP in response to the request to send temperature data.
- 3-> TMP has stopped responding during communication between NC and TMP.
- 4-> The NC received temperature data in wrong format from TMP.
- 5-> Communication procedure is abnormal. (The NC has received a null command twice successively.)
- 6-> TMP is not in ready status (with the TMP power OFF).
- 7-> The reception buffer is full (16 bytes or over).
- 8-> An error has occurred during initialization of the communication channels by the NC.
- 9-> The NC detected a received data error (such as parity, overrun, framing error).
- A-> The NC detected a received data error other than code 9 during data reception.
- B-> Data transmission error
- C-> The data to be transmitted is too large to be written in the memory.
- D-> An error occurred in confirming completion of transmission.

[Probable Faulty Locations]

- 1) Defect in communication cables, or incomplete connection of them
- 2) The temperature sensor is in trouble or turned OFF.
- 3) Defective communication board

[Measures to Take]

Reset the NC. If the same alarm still occurs, inspect the communication board, communication cables, and the temperature sensor, and change them, if necessary.

If the NC is reset after invalidation of the thermal deviation compensation function, this alarm will never occur.

[Related Specifications]

Thermal deviation compensation function (used only by the user)

★ 3254 **TMP mean count error**

During communication with the temperature sensor (TMP), an error occurred in transmission of the mean count of temperature data.

[Code]

- 1-> Though the NC transmitted the mean count, TMP failed to normally terminate the data reception.
- 2-> No signal was sent from TMP in response to the mean count sent from the NC.
- 3-> Communication procedure is wrong.

[Probable Faulty Locations]

- 1) Defect in communication cables or incomplete connection of them
- 2) The temperature sensor is in trouble or turned OFF.
- 3) Defective communication board

[Measures to Take]

Reset the NC. If the same alarm still occurs, inspect the communication board, communication cables, and the temperature sensor, and change them, if necessary.

If the NC is reset after invalidation of the thermal deviation compensation function, this alarm will never occur.

[Related Specifications]

Thermal deviation compensation function (used only by the user)



★ 3255 **Thermal deviation compensation**

The data sent from the temperature sensor (TMP) is abnormal, and cannot be used for compensation.

[Code]

1-> Measurement of temperature is disabled for the following reasons:

The sensor has detected a temperature lower than -20(Centigrade) or a sensor cable is disconnected.

The sensor has detected a temperature higher than +70(Centigrade) or sensor cables are shorted.

2-> Because of non-uniformity in temperature distribution on the machine, the NC read the back up data before starting thermal deviation compensation. However, the read data was empty.

3-> Calculation of the compensation data cannot catch up with the data receiving speed.

4-> The temperature change between the sensor sampling data has exceeded the reference value (3-Centigrade) five times successively. At this time, the problem channel is indicated.

5-> The compensation amount for one heat generating element has exceeded the allowable limit.

6-> The compensation value has exceeded the preset limit.

7-> Because of non-uniformity in temperature distribution on the machine, the NC tried reading the back up data before starting the compensation. However, the data reading was inhibited because of the previously caused thermal deviation compensation alarm indicated by any of the codes 1, 2, 4, 5, and 6.

[Probable Faulty Locations] Refer to the measures to take described below.

[Measures to Take]

If code 1 is displayed:

The alarm continues until the sensor-detected temperature enters the range from -20 to +70(Centigrade).

Check the sensor cables for disconnection or short-circuit. If the sensor function is invalidated by parameter setting, this alarm will never occur.

Code2:This alarm continues until the machine temperature is judged to be uniform.

Code3:The thermal deviation compensation logic includes an error, or the screw pitch compensation interval is too short.

Code4:If this alarm occurs frequently, check the installed condition and set values of the sensor.

Code5:This alarm continues until the machine temperature distribution becomes uniform or the compensation amount falls under the limit.

Code6:This alarm continues until the machine temperature distribution becomes uniform or the compensation amount falls under the limit.

Code7:This alarm continues until the machine temperature distribution is judged to be uniform.

In any case, this alarm can be released by setting the thermal deviation compensation to ineffective (OFF) before NC reset.

[Related Specifications] Thermal deviation compensation function (used only by the user)

★ 3256 **Pallet No. check NG**

On FMS's, comparison between the next pallet number sent from the machine and the loading pallet number sent from the stacker crane proved that they does not match. (user-selectable specification)

★ 3257 **In program operation**

While a file is accessed in program operation mode, "program select by schedule program", "PPC program select", or "external program select" was specified by background processing.

This alarm is displayed when "1" is set at the optional parameter (bit) No. 16 bit 3.

★ 3258 **DNC Illegal data**

The NC received a text not allowed in this system.

[Code] End status

[Probable Faulty Locations] Defective text data received

[Measure to Take] Investigate the host computer software.

[Related Specifications] DNC-C

★ 3259 **Compressor Check**

The air compressor maintenance request signal came ON. (user-selectable specification)

★ 3260 **ADP START**

An error occurred while the AD conversion processor board was formatted immediately after power supply. The MOP-TOOL function does not operate (aborting feedrate override control).

[Code] X

- 1- The synchronous counter value remains "1".
- 2-> A system alarm occurred when the synchronous counter value was 1.
- 3-> The synchronous counter value remains "3".
- 4-> A system alarm occurred when the synchronous counter value was 3.

[Probable Faulty Locations]

- 1) ADP (AD conversion processor board)
- 2) Built-in type MOP-TOOL software

[Measures to Take]

Replace the ADP (AD conversion processor board).

It is possible to disable the built-in type MOP-TOOL function by selecting the parameter setting mode and setting "1" at the NC optional parameter (bit) No. 34 bit 1.

[Related Specifications] OSP7000M built-in type MOP-TOOL specification

★ 3261 **Chip flush-out motor overload**

The chip flush-out motor normal signal went OFF for 1[s] or over while the chip flush-out pump is in operation.

[Probable Faulty Locations] Defective chip flush-out motor

★ 3262 **Oil-air lubricating oil level low**

On S-20, the oil-air unit for spindle lubrication has low oil level.

The oil-air lubricating oil level low signal (OALL) is turned off.

[Measures to Take] Supply oil to the oil-air unit.

★ 3263 **NG2 tool used**

This alarm occurs when the tool management function detects that a life-expired tool is designated by T command but no replaceable spare tool is mounted.

[Code] AABB

- AA-> Classification of problem tool ... bit7: NG3, bit6: NG2, bit5: NG1, bit3: SP, bit2: ORG, bit1: commanded tool
- BB-> Alarm cause hold signal ... bit7: user NG, bit5: tool breakage detection (touch probe), bit4: tool breakage detection (AE sensor), bit3: tool overload (abnormal torque detection), bit2: tool overload (MOP), bit1: tool wear (MOP), bit0: tool life

[Measures to Take]

Change the tool with a new one. On the tool management function screen, enter the tool's use time and remaining time, and set OK/NG to OK.

[Related Specifications] Tool management function

[Referential Instruction Manual] Tool management function

★ 3264 **Spindle overload**

The load applied to the spindle has exceeded the value set as an overload monitor limit.

[Code] XXXXYYYY

XXXX: Parameter number for monitoring overload

YYYY: Overload rate (%) detected on occurrence of the alarm

★ 3266 **Tool preparation function**

In program selection by schedule program, external device, or PPC, the tool list file in the memory (MD1:) was not normally selected.

[Index] None

[Character-string]

- 80000001-> Tool list file extension code (.MIN) is not suitable for program selection of method A.
- 80000002-> There is no tool list file having the extension code (.UTT).
- 80000003-> An excessive number of tools are registered in the unnecessary tool list.
- 80000004-> The tool list file extension code (.MIN) does not include UTTS command.
- 80000005-> The tool list file has a command other than T command
- 80000006-> The tool list file has no T command.
- 80000007-> The tool list file has more than 300 T commands.
- 80000008-> The tool list file has the T command for a lack tool.
- 80000008-> The tool list file has the T command for a non-existing tool.

[Measures to Take]

Check and correct the tool list file data.

Check if the tool list file selection parameter (NC optional parameter bit No. 57 bit 0) is correctly set.

In program selection, specify an option code T to inhibit selection of tool list file.

★ 3267 **Tool data not incomplete**

Power was shut off during the time between change of the tool data and backup of the changed data.

[Index] None

[Character-string] None

[Code] XYYYY

- X=1-> Error occurred in data writing or extracting cycle.
- X=2-> Error occurred in reading (entering, updating) cycle.
- YYYY->Relevant pot number (in decimal)

[Measures to Take]

The tool data at the relevant pot number will not be guaranteed. Check the data and correct the data as necessary.

After correction, display the TOOL ID DATA screen indicating the pot with uncertain tool data and press the function key [F5] (DATA RESTORE).

Then, press the NC reset key to release the alarm.

★ 3268 **DNC-DT start condition**

An error occurred in initial program loading by resetting DNC-DT.

[Index] None

[Character-string] None

[Code]

YY: Application error No.

FFFFFFF: Excessive number of characters in a line

100: Failure of hardware (such as a hard disk)

YY=02: No program file is found.

YY=13: Illegal channel No.

YY=16: Improper initialization parameters; Can't close unopened line; Invalid program name

YY=11: Can't open a line twice

YY=06: TCP/IP board initialization time-out (TCP/IP board inoperable); Can't change the device name; Can't release the protection of the device, Can't obtain file system information on the device; Unknown (unsupported) command

YY=0D: Communication board not mounted

YY=02: Program not present

YY=08: Execution failed

[Probable Faulty Locations]

NC program error

Hard disk failure, application interface software failure

[Measures to Take]

Review the NC program.

Initialize or replace the hard disk.

★ **3269 Chip flush-out motor overload**

An overload for an operational door flush-out motor worked.

[Index] None

[Character-String] None

[Code] None

[Probable Faulty Locations]

- Inferiority of operational door flush-out motor.
- pump does eye rebuking.

★ **3270 Magnet separator motor overload**

The overload sensor is activated in the magnet separator.

[Index] None

[Character-string] None

[Code] None

[Probable Faulty Locations]

The magnet separator is faulty.  
The pump is clogged.

★ **3271 Coolant unit**

A cutting liquid equipment normal signal turned more than 1[s] it off.

[Index] None

[Character-String] None

[Code] None

[Probable Faulty Locations] Inferiority of cutting liquid equipment.

★ **3272 PLC battery change**

It turned into PLC electric battery fall.

[Index] None

[Character-string] None

[Code] None

[Probable Faulty Locations]

- An electric battery of-PLC.

★ **3273 Start switch N.G.**

It became as it is which lever ceremonial remote starting switch input turned on more than 5[s].

[Index] None

[Character-String] None

[Code] None

[Probable Faulty Locations]

- A lever ceremonial remote starting switch

★ 3274 **Start condition**

Start condition did not form.

[Index] None

[Character-String] None

[code] None

★ 3275 **Fixture shower coolant motor overload**

An overload for a peace possession shower motor worked.

[Index] None

[Character-String] None

[Code] None

[Probable Faulty Locations]

- Inferiority of a peace possession shower motor.
- A pump does eye rebuking.

★ 3276 **Cycle time over**

The time required to execute one cycle (from cycle start to reception of M02 or M30) has exceeded the time set at the param

[Index] None

[Character-string] None

[Code] None

★ 3277 **Tool life management no spare tool**

The active tool becomes an NG tool, but its tool group has no registered spare tool (OK tool).

[Index] None

[Character-string] None

[Code] Tool group number of the active tool that has done its life

[Measures to Take]

- Change the tools in the tool group with new ones. Display the tool life management screen and set the number of parts to be cut during tool life and the remaining number of parts. Then, set the tool status OK/NG to OK.

★ 3278 **Quality check alarm**

Any of the NC work counters has reached the preset value.

[Index] None

[Character-string] None

[Code]

- 1-> The work counter A has exceeded the set value.
- 1-> The work counter B has exceeded the set value.
- 1-> The work counter C has exceeded the set value.
- 1-> The work counter D has exceeded the set value.

[Measures to Take]

Check the NC work counter screen and

- Make the counter value smaller than the set value.

- Make the set value smaller than the counter value.
- Set 0 at the counter.

★ 3279 **Pallet supply NG**

On the machine with SC-interface, the signal of "Pallet exists on the set-up ST" is not ON when the signal "Pallet supply completed" comes ON.

[Index] None

[Character-string] None

[Code] None

[Measures to Take] Put the pallet on the set-up ST properly.

★ 3280 **Position encoder needs the adjustment**

Inductosyn of an axis is not adjusted.

[Index] None

[Character-string] None

[Code] Problem axis No.

Example) 46: The rotary axes No. 4 and No. 6 need adjustment.

[Probable Faulty Locations]

[Measures to Take]

The Inductosyn of the indicated axis needs adjustment.

Perform automatic adjustment according to the related procedures for adjusting the position encoder.

★ 3281 **Touch probe battery**

The touch probe battery voltage has dropped.

[Index] None

[Character-string] None

[Code] None

★ 3282 **Work-counter over**

The work-counter threshold has been exceeded.

[Index] None

[Character-string] None

[Code] None

[Measures to Take] Reset the work-counter.

★ 3283 **Washing unit**

Abnormality occurred in the washing unit.

[Index] None

[Character-string] None

[Code]

1-> The motor overload is activated.

★ 3284 **Gauging NG**

The "Gauging NG" signal was sent from the robot/loader interface.

[Index] None

[Character-string] None

★ 3285 **DNC-DT Path name**

Improper file name was specified in external program selection through DNC-DT. The combination of device name, path name and file name exceeded 120 characters.

[Index] None

[Character-string] None

[Code]

- 1-> Improper file name
- 2-> Improper filename extension
- 3-> The combination of device name, path name and file name is longer than 120 characters.

[Probable Faulty Locations] Program register file

[Measures to Take] Check the program register file.

★ 3286 **DNC-T Program select**

Alarm occurred in external program selection through DNC-DT.

[Index] None

[Character-string] None

[Code]

YY: application error No.

800000XX: XX is the communication error number.

FFFFFFF: Too many characters in a line

FFFFFFFD: Program buffer overflow

XX=6F: Short of buffer inside TCP/IP driver

XX=72: Erroneous descriptor passed to TCP/IP driver

XX=73: Erroneous parameter passed to TCP/IP driver

XX=74: No free port in the common memory

XX=75: Not connected

XX=7B: The abort command was ignored.

XX=7D: Abnormal end of ftp\_ms\_open

XX=7E: Abnormal end of ftp\_ms\_close

XX=7F: Abnormal end of ftp\_ms\_type

XX=80: Abnormal end of ftp\_ms\_user

XX=81: Abnormal end of ftp\_ms\_pass

XX=82: Abnormal end of ftp\_ms\_acct

XX=83: Abnormal end of ftp\_ms\_delete

XX=84: Abnormal end of ftp\_ms\_fopen

XX=85: Abnormal end of ftp\_ms\_fopen\_uni

XX=86: Abnormal end of ftp\_ms\_net\_drecv\_f

XX=87: Abnormal end of ftp\_ms\_net\_dsend\_f

XX=88: Abnormal end ftp\_ms\_fclose

XX=89: Abnormal end ftp\_ms\_abort

XX=8A: Abnormal end ftp\_ms\_chdir

XX=8B: Abnormal end ftp\_ms\_mkdir

XX=8C: Abnormal end ftp\_ms\_rmdir

XX=8D: Abnormal end ftp\_ms\_pwd

XX=8E: Abnormal end of ftp\_ms\_cdup

XX=8F: Abnormal end of ftp\_ms\_dopen

XX=90: Abnormal end of ftp\_ms\_dread

XX=91: Abnormal end of ftp\_ms\_dclose

- XX=97: IP Address error
- XX=98: IP Address none
- XX=99: Break due to time-out
- XX=9A: Disconnection from remote host
- XX=9B: Abnormal end in initialization of OS (MORE) on the TCP/IP board
- XX=9C: Abnormal end in initialization of the packet driver or TCP/IP module on the TCP/IP board
- XX=9D: Abnormal end in initialization of the TELNET client module on the TCP/IP board
- XX=9E: Abnormal end in initialization of the TELNET server module on the TCP/IP board
- XX=9F: Abnormal end in initialization of the FTP module on the TCP/IP board
- XX=A0: Abnormal end in initialization of the socket interface module on the TCP/IP board
- XX=A1: Abnormal end in initialization of the TCP/IP board
- YY=13: Invalid channel No.
- YY=16: Invalid initialization parameter, attempt to close the line even though it is not open, Invalid program name
- YY=11: Attempt to open the line even though it is already open
- YY=06: Time-out occurred in initialization of TCP/IP board (TCP/IP board not operable) because the device does not permit name change, change of protect/unprotect status, or acquisition of file system information. Or, unknown (unsupported) command was specified.
- YY=0D: Omission of communication board
- YY=02: No program
- YY=08: Execution failed
- YY=17: Option L was specified, but a file with the same name existed in MD1: and the file is protected. For this reason, file deletion failed.
- YY=18: Opening a file failed when creating a file in MD1: by specifying option L.
- YY=19: Closing a file failed when creating a file in MD1: by specifying option L.
- YY=20: Putting the file data failed when creating a file in MD1: by specifying option L.
- YY=21: Deleting a file failed when creating a file in MD1: by specifying option L.

[Probable Faulty Locations]

Faulty TCP/IP board, communication error, or NC program error

[Measures to Take]

Set correct data in OSP environment setting file.

Establish the communication environment.

Select an existing file.

**★ 3287 Cooling unit**

[Index] None

[Character-string] None

[Code]

**★ 3288 Air pressure low**

The pressure of the air supplied to the machine has dropped.

[Index] None

[Character-string] None

[Code]

None->The Air pressure has dropped.

Malfunction occurred in Daido's oil-air unit used in MX-45, -55, or -65VA/B.

20-> The air dryer clogging signal kept OFF for 30 seconds.



★ 3289 **Oil-air lube**

Malfunction occurred in Daido's oil-air unit used in MX-45, -55, or -65VA/B.

[Index] None

[Character-string]None

[Code]

25-> The oil level low signal from the oil-air unit went OFF for 3 seconds or over.

★ 3290 **Oil-mist unit**

The oil level normal signal from the tank went OFF for 3 seconds or over.

A trouble occurred in the oil-mist unit.

[Index] None

[Character-string] None

[Code]

1-> The oil-mist unit sent the oil level low signal when an oil-mist command was issued.

2-> The oil level normal signal from the oil-mist unit went OFF for 3 seconds or over when an oil-mist command was issued.

3-> The air pressure normal signal from the oil-mist unit went OFF for 3 seconds.

★ 3291 **Filter clogging**

The filter clogging signal (OHFL) came ON.

[Index] None

[Character-string] None

[Code] None

[Probable Faulty Locations] The filter is clogged.

[Measures to Take] Clean the filter.

★ 3701 **CPU temperature rising**

Temperature inside the control enclosure is higher than 60°C.

[Index] None

[Character-string] None

[Code] None

[Probable Faulty Locations]

1) Cooling fan motor for the control enclosure is not operating.

2) Cooling duct filter is clogged.

★ 3702 **CPU voltage low**

Input voltage for the CPU power supply drops below 170VAC.

[Index] None

[Character-string] None

[Code] None

[Probable Faulty Locations]

1) Insufficient 200VAC power supply capacity

2) Voltage drop due to start up of other equipment

3) Defective CPU power supply

[Measures to Take]

1) Check variation in main power supply.

2) Replace power supply.

★ 3703 **Axis lube level low**

Low axis lubricating oil level

This alarm occurs when the normal centralized lubricating oil level signal, output from the X/Y/Z slideway lubricating oil tank float switch, is turned off.

The low lubrication oil signal, when turned on, also causes this alarm.

[Index] None

[Character-string]

None : X-,Y-,and Z-axis lubrication

'APC': APC lubrication

[Code] None

[Measures to Take] Supply lubricating oil.

★ 3704 **Coolant level low**

The coolant level is low.

The float switch within the coolant tank turned OFF the coolant normal signal or turned ON the coolant error signal when a coolant or oil hole command was issued.

[Index] None

[Character-string] None

[Code]

10-> The low coolant level notice signal remained ON for more than three seconds.

[Measures to Take] Supply coolant.

★ 3705 **ATC system condition**

During execution of the ATC(AT-ATC) cycle, ATC input information does not match the ATC sequence advance conditions. (indicated in the ATC input logic chart) in three minutes.

[Index] None

[Character-string] None

[Code] XYZZ

X = None, Input conditions are not turn on.

= 1, Input conditions are not turn off.

Y = Hexadecimal number of the byte number in the input logic chart

ZZ = Bit position in input logic chart

★ 3706 **Power source unit overload**

The circuit braker (CB4) for lighting inside the EC power unit is tripped.

[Index] None

[Character-string] None

[Code] None

[Probable Faulty Locations] Lighting cable is either shorted or connected to the ground.

★ 3707 **Hydraulic oil level low**

The hydraulic unit oil level is low.

This alarm occurs when the normal oil level signal, output from the hydraulic unit (combination unit) at the back of the column, is turned off.

[Index] None

[Character-string] None

[Code] None

[Measures to Take] Supply hydraulic oil.

★ 3708 **Spindle lube level low**

The spindlehead lubricating oil level is low.

This alarm occurs when the normal cooling oil level signal, output from the hydraulic unit (combination unit) at the back of the column, is turned off.

[Index] None

[Character-string] None

[Code] None

[Measures to Take] Supply the spindlehead lubricating oil.

★ 3709 **Auto power shut-off impossible**

Auto power shut-off is attempted though the memory disk (MD) battery has done its service life.

[Index] None

[Character-string] None

[Code]

1-> Auto power shut-off is attempted after expiration of the memory disk (MD) battery life.

[Measures to Take]

Change the memory disk battery before performing auto power shut-off.

★ 3710 **Power saving**

Power saving mode entered after the elapse of the time set at the parameter.

[Index] None

[Character-string] None

[Code] None

★ 3711 **Chip flush-out motor overload**

The chip flush-out motor normal signal went OFF for 1 second or over while the chip flush-out pump is in operation.

[Index] None

[Character-string] None

[Code] None

★ 3712 **Chip conveyor motor overload**

The overload relay for the chip conveyor motor is tripped.

[Index] None

[Character-string] None

[Code] None

★ 3713 **External program select parity check**

When selecting a program according to the external device command, the NC conducted a parity check as specified by the parameter (machine user parameter "external program select"). The result is detection of a parity error.

[Index] None

★ 3714 **APC system condition**

During execution of the APC cycle, APC input information does not match the APC sequence advance conditions. (indicated in the APC input logic chart) in two minutes.

[Index] None

[Character-string] None

[Code] XYZZ

X = None, Input conditions are not turn on.

X = 1, Input conditions are not turn off.

Y = Hexadecimal number of the byte number in input logic chart

ZZ = Bit position in the input logic chart.

**★ 3715 Air dryer unusual**

The dry air filter normal signal remained OFF for more than two seconds.

[Index] None

[Character-string] None

[Code] None

**★ 3716 Cycle time over**

A cycle (the time from the startup to M02 or M30) exceeded the set parameter value.

[Index] None

[Character-string] None

[Code] None

**★ 3717 Quality counter**

In a machine equipped with a multi-counter, a prediction/warning alarm occurred when the counter reached the set value.

[Index] None

[Character-string] None

[Codes]

1-> The work counter turned ON the machine stop signal.

10-> The work counter turned ON the error signal.

**★ 3718 Outside**

An error occurred in a linked external unit, such as a robot and a loader.

In a machine equipped with a robot or loader, an alarm occurred in the robot or loader control unit.

[Index] None

[Character-string] None

[Code] None

[Probable Faulty Locations]

1) The robot or loader control unit is faulty.

**★ 3719 Coolant unit**

Probable Faulty Locations:

The coolant unit is faulty.

[Codes]

1-> The suction pump motor signal failed to come ON within three seconds when the motor was turned ON.

2-> The return motor ON signal failed to come ON within three seconds when the return motor was turned ON.

5-> The eco-saver oil level low signal came ON.

6-> The oil skimmer motor ON signal failed to come ON within three seconds when the motor was turned ON.

- 7-> The chuck washing motor ON signal failed to come ON within three seconds when the motor was turned ON.
- 8-> The coolant flow normal signal remained OFF for a longer period of time than the time set at the parameter during coolant motor output.

[Codes] 5-digit codes

XYZZZ: X = In the case of 1, the overload relay for the motor became activated.

= In the case of 2, the coolant level reached the lower limit.

= In the case of 3, the coolant level reached the upper limit.

= In the case of 4, the filter was clogged.

Y = In the case of 0, the input signal came ON.

= In the case of 1, the input signal went OFF.

ZZZ = The input signal address. Check it with the drawing.

(Example) 2060C: The signal at address 60C came ON, and the coolant level reached the lower limit.

11211: The signal at address 211 went OFF, and the overload relay for the motor became activated.

4122C: The signal at address 22C went OFF, and the filter became clogged.

★ 3720 **Thru-the-tool coolant filter**

The filter within the oil hole coolant tank is clogged.

[Index] None

[Character-string] None

[Code] None

Probable Faulty Locations:

- 1) The filter is clogged.
- 2) The clogging detection pressure switch is faulty.

[Measures to Take] Wash the filter.

★ 3721 **Air pressure drop**

The main air pressure normal signal remained OFF for more than three seconds. Or, the main air pressure abnormal signal remained ON for more than three seconds.

[Index] None

[Character-string] None

[Codes]

None->The main air pressure normal signal remained OFF for more than three seconds. Or, the main air pressure abnormal signal remained ON for more than three seconds.

- 1-> The air dryer clogging signal remained OFF for more than three seconds.

★ 3722 **Mist air lube unit**

The oil mist lubricant level normal signal remained OFF for more than three seconds. Or, the oil mist lubricant level abnormal signal remained ON for more than three seconds.

[Index] None

[Character-string] None

[Codes]

4-> The oil mist lubricant level normal signal remained OFF for more than three seconds.

5-> The X-/Y-axis oil mist lubricant level normal signal remained OFF for more than three seconds.

6-> The spindle oil mist lubricant level normal signal remained OFF for more than three seconds.

7-> The ball screw lubricant level normal signal remained OFF for more than three seconds.

8-> The air pressure normal signal for the ball screw lubrication unit failed to come ON within three seconds when the ball screw lubrication air ON output was turned ON.

★ 3723 **Cooling unit**

The ball screw cooling unit turned OFF the oil level normal signal or turned ON the oil level abnormal signal for more than three seconds.

[Index] None

[Character-string] None

[Codes]

- 2-> The Y-axis cooling unit oil level normal signal remained OFF for more than three seconds.
- 3-> The column cooling unit normal signal remained OFF for more than three seconds.
- 4-> The column cooling unit oil level normal signal remained OFF for more than three seconds.

★ 3724 **VAC operation command mismatch**

The operation command output to the VAC and the operation command status output from the VAC remained unmatched for more than two seconds.

[Index] None

[Character-string] None

[Code] None

★ 3725 **ACC system condition**

In an AAC cycle, the AAC input information did not match the ATC sequence progress condition (see the AAC logic table) within three minutes.

[Index] None

[Character-string] None

[Codes] XYZZ

- X = When the code is none, the input condition is not turned ON.
- When the code is 1, the input condition is not turned OFF.
- Y = Hexadecimal byte position in the input logic table
- ZZ = Bit position in the input logic table

★ 3726 **Lube unit**

An error occurred in the lubrication unit.

[Index] None

[Character-string] None

[Code]

- 1-> The lubrication ON confirmation signal failed to come ON within three seconds when the lubrication pump was turned ON.

[Probable Faulty Locations] The lubrication unit is faulty.

★ 3727 **Time over**

The operation of a jig was not completed within the time set at the parameter.

[Index] None

[Character-string] None

[Codes]

- 1-> The pallet A is not on the setup side.
- 2-> The APC is in operation (the APC is not in the start position during an APC cycle).
- 3-> The machine is locked.
- 4-> The machine is saving power.
- 5-> The jig is not in the position where it can operate.
- 6-> The spindle is not at rest.

7-> Low-pressure clamping is not completed (when a high-pressure clamping M command is issued).

8-> The timer is counting.

XYYY: X = When the code is none, the input signal is not turned ON.

When the code is 1, the input signal is not turned OFF.

YYY = The input signal address.

[Measures to Take] Check each operation completion condition or input signal.

**★ 3728 Oilmist unit**

An error occurred in the oil mist unit.

[Index] None

[Character-string] None

[Codes]

1-> The oil mist level low signal came ON when an oil mist command was issued.

2-> The oil mist level normal signal remained OFF for more than three seconds when an oil mist command was issued.

3-> The air oil mist unit air pressure normal signal remained OFF for more than three seconds.

**★ 3729 Washing unit**

An error occurred in the washing unit.

[Index] None

[Character-string] None

[Code]

1-> The washing pump ON confirmation signal failed to come ON within three seconds when the pump was turned ON.

[Probable Faulty Locations] The washing unit is faulty.

**★ 3730 Clamp unit**

An error occurred in the lubrication unit.

[Index] None

[Character-string] None

[Code]

1-> The clamp confirmation signal remained OFF for more than one second when clamping was completed.

[Probable Faulty Locations] The clamp unit is faulty.

**★ 3731 Sitting abnormal**

The robot or loader sent the work seated error signal in the system link mode.

[Index] None

[Character-string] None

[Code] 1

**★ 3732 Dust-collector Error**

An error occurred in the dust collector.

[Index] None

[Character-string] None

[Codes]

1-> The operation ON confirmation signal failed to come ON within one second when the dust collector operation ON signal came ON.

2 -> The air flow rate normal signal remained OFF for more than three seconds when the dust collector operation ON signal came ON.

[Probable Faulty Locations] The dust collector is faulty.

★ 3733 **Gauging NG**

The work gauging result was not good.

[Index] None

[Character-string] None

[Code]

1-> The gauging result NG signal was turned ON.

★ 3734 **Oil-air lube**

An error occurred in the oil air lubrication unit.

[Index] None

[Character-string] None

[Code]

25-> The oil air lubricant level drop signal remained OFF for more than three seconds.

★ 3735 **Mist-collector Error**

An error occurred in the mist collector.

[Index] None

[Character-string] None

[Code]

1-> The mist collector ON confirmation signal remained OFF for more than three seconds during mist collector output.

★ 3736 **Hydraulic unit error**

An error occurred in the hydraulic unit.

[Index] None

[Character-string] None

[Codes]

1-> The hydraulic unit oil temperature increased.

The hydraulic unit oil temperature normal signal went OFF.

2-> The hydraulic unit oil level normal signal remained OFF for more than three seconds.

3-> The hydraulic unit filter normal signal remained OFF for more than three seconds.

10-> The filter normal signal of the hydraulic unit for jigs remained OFF for more than three seconds



## SECTION 7 ALARM D

Alarm No.	Alarm Message
4000	SVP start conditions uncertain
4001	SVP processing trouble
4002	SVP CON APA deviation
4003	SVP error
4004	SVP exception processing
4005	SVP APA pattern data
4006	SVP APA speed
4007	SVP CON speed
4008	SVP DIFF over
4009	SVP servo amp
4010	SVP APA check data
4011	SVP speed command over
4012	SVP servo data setting
4013	SVP belt is broken
4014	SVP F-TYPE encoder error
4015	SVP full closed loop error
4016	SVP F-TYPE encoder with shaft error
4017	SVP F with shaft APA pattern data
4018	SVP cannot plant error offset data
4019	SVP encoder application error (MOTOR SHAFT)
4020	SVP encoder application error (WITH SHAFT)
4021	SVP collision detection
4022	SVP SA overload
4023	SVP SA communication error
4024	SVP SA version error
4025	SVP SA motor current overload
4026	SVP SA inverter bridge short circuit
4027	SVP SA overheating
4028	SVP SA power circuit overvoltage
4029	SVP SA power circuit low voltage
4030	SVP SA regenerative resistor overheat
4031	SVP control circuit power voltage
4032	SVP SA error
4033	SVP board version error
4034	SVP control error
4035	Memory board / battery change
4036	Key-cord data receive error
4037	CCP-CPU error
4052	PLC backup data file write
4053	VAC power supply voltage flutter over
4054	ACP Key-code data receive error

Alarm No.	Alarm Message
4055	Safety Speed Clamping
4056	DNC-T error
4150	MCS Undefined alarm number
4151	MCS Exception processing
4152	MCS Processing trouble
4153	MCS CON APA deviation
4154	MCS Power-Supply-Unit Error
4155	MCS Converter-link error
4156	MCS DC-bus voltage alarm
4157	MCS Motor over current
4158	MCS Power unit over heat
4159	MCS Power unit over load
4160	MCS Supply voltage flutter
4161	MCS Power unit version error
4162	MCS Winding-change failed
4163	MCS Encoder-link error
4164	MCS Encoder error
4165	MCS Encoder initialize failed
4166	MCS Encoder with shaft error
4167	MCS Encoder with shaft initial
4168	MCS ABSO SCALE error
4169	MCS ABSO SCALE initialize
4170	MCS Magnetic encoder alarm
4171	MCS Resolver alarm
4172	MCS Pulse generator count over
4173	MCS Motor over heat
4174	MCS Servo-link error
4175	MCS Servo-link disconnect
4176	MCS Servo-link protocol error
4177	MCS Servo data error
4178	MCS Illegal command
4179	MCS CON speed over
4180	MCS Speed command over
4181	MCS DIFF over
4182	MCS APA speed over
4183	MCS Full-closed APA error
4184	MCS Over speed
4185	MCS Velocity deviation over
4186	MCS Collision detected
4187	MCS Urgent-stop time over
4188	MCS Belt is broken
4190	MCS independent encoder init
4191	MCS APA error

Alarm No.	Alarm Message
4192	MCS Motor over load
4200	Axis drive unit
4201	Axis lube oil level
4202	Battery voltage low
4203	Spindle override range over
4204	Feedrate command limit over (replacing)
4205	Hydraulic oil temperature high
4206	Sequencer not ready
4207	Lube oil drain tank overflow
4208	MSB reserved
4209	User reserve code
4210	Graphic panel operating
4211	SAC air pressure low
4212	Axis lube pressure unusual
4213	System check
4214	Spindle head lube oil temp. unusual
4215	Spindle speed change gear shift motor overload
4216	Safety interlock
4217	Parameter setting
4218	DNC-B communication error
4219	DNC-B message format error
4220	DNC-B communication system abort
4221	ATC interlock releasing
4222	Oil/coolant separator tank overflow
4223	Touch prove battery
4224	Index table unclamp
4225	Conveyor motor overload
4226	Coolant unit
4227	Axis clamp confirmation
4228	MOP overload
4229	Spindle overload
4230	DNC Unjust notice
4231	DNC Illegal parameter
4232	DNC Illegal data
4233	DNC Communication abort
4234	DNC Unjust request
4235	DNC Receive message is unsame
4236	DNC Send message is unsame
4237	DNC Illegal sequence number
4238	DNC Communication not ready
4239	Rotary axis parameter backup data
4240	Spindle neutral gear select condition
4241	Tool clamp/unclamp operation condition

Alarm No.	Alarm Message
4242	G task stop
4243	Cross rail position auto set mode
4244	ther axis not indicated has been moved
4245	Waiting program selection during program operation
4246	File deleted
4248	Error File
4249	Door Interlock All Axis Stop
4250	Door Interlock ATC & ATC magazine Stop
4251	Door Interlock APC Stop
4252	Please open door
4253	Please open ATC magazine door
4254	Please open APC door
4255	MOP-TOOL AUTO ENTRY
4256	MOP-TOOL TOOL WEAR
4257	MOP-TOOL OVERLOAD
4258	MOP-TOOL ABNORMAL LOAD SIG.
4259	MOP-TOOL MIN. OVERRIDE
4260	MOP-TOOL AE SENSOR ERROR
4261	ADP ERROR
4262	Print data output
4263	Stroke end limit reset
4264	Axis interlock
4265	Work washing gun
4266	Air dryer unusual
4267	Profile generation FPU error
4268	Waiting schedule start
4269	ACP Version Error
4270	No magazine tool to be selected
4271	Active tool is adjust tool
4272	Conflict preventive speed over
4273	Pulse handle feed limit
4274	Encoder operation check mode
4275	Thermal deviation compensation
4276	Axis overload
4277	B-axis swivel limit
4278	Axis swivel interlock
4279	PPC communication error
4280	Override range over
4281	Processing trouble
4282	PPC cycle can't start
4283	Door condition abnormal
4284	Thermistor error
4285	Interrupt program

Alarm No.	Alarm Message
4286	Tool life previous notice
4287	Quality check warning
4288	SPM Parameter unsuitable
4289	Magazine door open
4290	External program select error
4291	Position encoder is adjusting
4292	Sub program is selecting
4293	Super Hi-NC control cannot execute
4294	HI-CUT Pro Control cannot execute
4295	G131/130 command: unusable address characters
4296	Super Hi-NC parameter out of range (replacing)
4297	HI-CUT Pro parameter out of range (replacing)
4298	TOOL-ID TP communication error
4299	ATC communication error
4300	Gauging mode communication error
4301	Turning cut speed limit (replacing)
4302	Dual palm cycle start
4303	Dual palm operation
4304	Axis moving time over
4702	Hydraulic oil temperature high
4703	System check
4704	ATC interlock releasing
4705	Work washing gun
4706	Auto power shut-off impossible
4707	Power ON/OFF sequence error
4708	Safety interlock
4709	Managing operating power shutdown
4710	Door interlock all axis stop
4711	Door interlock ATC & ATC magazine door
4712	Door interlock APC stop
4713	Please open door
4714	Please open ATC magazine door
4715	Please open APC door
4716	Touch probe battery
4717	Door condition unusual
4718	Stroke end limit reset
4719	Coolant unit unusual
4720	NC START ineffective
4721	Crossrail positioning auto set mode
4722	Chip conveyor unusual
4723	Index table unclamp
4724	Quality counter
4725	PPC cycle start impossible

Alarm No.	Alarm Message
4726	Override switch position
4727	Dual palm cycle start
4728	Dual palm operation
4729	Cycle start
4730	Feed rate limitation
4731	Please close door
4732	Lube unit
4733	external coupled device alarm
4734	Axis lube motor overload
4735	Lube oil drain tank overflow
4736	Manual interupption
4737	Time over
4738	Fixture condition unusual
4739	Hydraulic oil level low

★ 4000 SVP start conditions uncertain

SVP hardware or software conditions were not met, which made it impossible to start up the SVP.

[Index] AXIS

[Code] XYYZZZZ

X=1-> Hardware-related conditions are not met.

YY=1->The SVP board is not mounted.

ZZZZ=0000

YY=2->The SVP is in abnormal status.

ZZZZSVP status

YY=3->The system bus related to the SVP hardware is in abnormal status.

ZZZZ: System bus status

X=2-> SVP data conditions are not met.

YY=1->Wrong synchronous signal number is selected.

ZZZZ: Selected synchronous signal number

YY=2->Synchronous shift time is wrongly designated.

ZZZZ: Designated synchronous shift time

X=3-> Software-related conditions are not met.

YY=1->The SVP software is not installed.

ZZZZ=0000

YY=2->Servo parameters are not installed.

ZZZZ=0000

[Probable Faulty Locations]

- 1) SVP hardware of the problem axis
- 2) Control software such as that for NC
- 3) NC specifications

★ 4001 SVP processing trouble

The SVP is in the trouble indicated by the following codes.

[Index] AXIS

[Code] XYYZZZZ

X=1-> Internal error

The SVP has caused either parity loop error or protect error.

YY-> Internal error status

ZZZZ: Two high-order bytes of the SVP system address in trouble

X=2-> Time out

The SVP does not send any response within 20[s] at the time of start up. Minute investigation should be made to locate the cause.

Since the SVP cannot detect the start up signal, it cannot execute the start up sequence.

YY=00

ZZZZ=000000

X=3-> Double bus error

During bus error exception processing by SVP, a bus error has occurred again. The SVP hardware will probably be defective.

YY: System bus status

ZZZZ=000000

X=4-> SVP command execution

The SVP has obtained wrong diagnostic results of CPU command execution. The CPU will probably be defective.

YY: Diagnostic results

ZZZZ=000000

X=5-> SVP trouble detected by the control software such as that for NC. Some trouble has occurred in the SVP.

[Probable Faulty Locations]

- 1) SVP hardware of the problem axis
- 2) SVP software of the problem axis
- 3) Control software such as that for NC

**★ 4002 SVP CON APA deviation**

Deviation between CON and APA has exceeded the preset limit.

The deviation can be obtained by the formula: [Calculated value written in SVP] - [Actual position read from SVP].

This value is monitored by the control software such as that for NC.

The SVP usually monitors DIFF. However, when the SVP becomes unable to monitor DIFF due to fatal abnormality, this monitoring function will prevent the system overrun.

[Index] AXIS

[Code] Absolute deviation value in hexadecimal [reference unit]

[Probable Faulty Locations] SVP of the problem axis

**★ 4003 SVP error**

The control software such as that for NC has detected a system alarm signal sent from the SVP hardware. For details, refer to the specification for the mounted SVP version.

[Index] AXIS

[Character-string] None

[Code] \*??##&&

\* -> Axis number of which SVP board's CPU has caused the error  
(If 2, the problem SVP board is that for the 2nd axis.)

?? -> Board status in hexadecimal

bit7bit6bit5bit4bit3bit2 bit1 bit0  
RUNHALTCPUOFF000 SNMI MSTP

## -> Bus error status in hexadecimal

bit7bit6bit5bit4bit3bit2 bit1 bit0  
SBERSBPARCYCER0PROTDAILOOPECC

&& -> Always 00

[Probable Faulty Locations]

- 1) Hardware defect of the SVP board indicated with the code \*
- 2) Software defect

**★ 4004 SVP exception processing**

Abnormality has occurred in processing by SVP software.

[Index] AXIS

[Character-string] Detected error factor

- # 1-> Bus error
- # 2-> Address error
- # 3-> Illegal instruction error
- # 4-> Zero divide error
- # 5-> CHK instruction error
- # 6-> TRAPV instruction error
- # 7-> Privilege violation error
- # 8-> Trace error



- # 9-> Line 1010 emulator error
- #10-> Line 1111 emulator error
- #11-> Unused area error
- #12-> Coprocessor illegal protocol error
- #13-> Format error
- #14-> Uninitialized interrupt error
- #15-> Spurious interrupt error
- #16-> Interrupt error
- #17-> INT7 error
- #18-> Debugger interrupt alarm
- #19-> INT2 loop error
- #20-> INT5 loop error
- #21-> Speed command calculation delay alarm
- #22-> TRAP error
- #23-> Floating-point coprocessor error
- #24-> PMMU error
- #25-> User interrupt error
- #26-> Board version error
- #27-> Memory test error

[Code]

The CPU program counter value is displayed except when the following character-strings appear.  
With #26, the SVP hardware ID number is displayed as a code.  
With #27, the memory address at the time of abnormality detection is displayed as a code.

[Probable Faulty Locations]

- 1) SVP board
- 2) SVP software

**★ 4005 SVP APA pattern data**

The SVP has successively detected wrong patterns of positional data sent from the position encoder.

Ex. Displayed code: 8000

Conversion into the octal number

8000(hexadecimal number)->100000 (octal number) Since the E8 unit reads up to 5 digits and ignores the sixth digit, all the digits become 0, causing the OSP to judge that no data is output from the encoder.

[Index] AXIS

[Code] Pattern of the read positional data(APA high-order digit)

[Probable Faulty Locations]

- 1) Position encoder of the problem axis
- 2) SVP hardware of the problem axis
- 3) Timing signal from the NC unit

**★ 4006 SVP APA speed**

The position encoder value (RAPA) changes according to the motor speed. The NC checks the variation of position encoder values at regular intervals. If the feedrate of each axis is abnormally high compared with the normal rapid traverse rate, or the value changes in abnormal manner due to malfunction of the position encoder, the variation per unit time exceeds a fixed allowable limit, causing this alarm.

[Index] AXIS

[Code]

Variation of the position encoder values in hexadecimal [encoder unit /3.2ms]

However, the following codes represents special meanings.

FFFFFFFF-> The variation has exceeded the liner axis stroke.

FFFFFFFE-> The variation has exceeded the rotary axis stroke (360°), or the positional data of the infinite axis has changed to a negative value.

FFFFFFFD-> The variation has exceeded the infinite axis stroke.

[Probable Faulty Locations]

- 1) Position encoder of the problem axis or the cables connected with the encoder.
- 2) Motor for driving the problem axis
- 3) Drive unit of the problem axis
- 4) SVP hardware of the problem axis

#### ★ 4007 SVP CON speed

When the axis is in the target position or at a standstill, the target value, operation value, and actual position data are the same. With designation of an axis moving command, the NC starts calculating the path to the target position, thus creating operation values (RCON). The NC then monitors the variation of the operation values at regular intervals. If the value changes in abnormal manner for some reason exceeding the allowable limit, this alarm occurs.

[Index] AXIS

[Code]

Absolute feedrate command value in hexadecimal [encoder unit/feedrate control time]

However, the following codes represents special meanings:

FFFFFFFF-> The NC violates the protocol (time limit).

FFFFFFFE-> The feedrate command values is larger than the over alarm level or the alarm detection level.

FFFFFFFC-> The SVP internal command position exceeds the encoder division stroke.

[Probable Faulty Locations]

- 1) Servo parameter of the problem axis
- 2) Control software such as that for NC
- 3) SVP hardware of the problem axis
- 4) Excessively high feedrate (except G00)

#### ★ 4008 SVP DIFF over

When the axis is in the target position or at a standstill, the target value, operation value, and actual position data are the same. With designation of an axis moving command, the NC starts calculating the path to the target position, thus creating operation values (RCON). This time, the actual position data follows the operation values with a certain delay. This delay amount obtained by subtracting [actual position] from [operation value] is termed following error. If the following error exceeds the allowable limit, this alarm occurs.

[Index] AXIS

[Code] Absolute DIFF value in hexadecimal [encoder unit]

[Probable Faulty Locations]

- 1) Mechanical trouble of ball screw, bearing or any other parts, which makes the axis movement heavy
- 2) Encoder, motor or drive unit of the problem axis
- 3) Servo parameters of the problem axis
- 4) SVP hardware of the problem axis

★ 4009 SVP servo amp

Fatal abnormality has occurred in the servo amplifier.

[Index] AXIS

[Code] YYZZ

YY= Internal error status

ZZ= Servo amplifier IF status

[Probable Faulty Locations] Drive unit of the of the problem axis.

★ 4010 SVP APA check data

The high-order digits read from the position encoder do not match the high-order digits obtained by incremental operation.

Ex. Displayed code: 14E914A9

When this code is converted into the octal number (by carrying high-order digit for F or E type encoder or carrying octal number for E8 unit), the following result can be obtained.

12351	12251
Encoder digit data	Operation data

Judging from the difference by 1 in the third place's number, the third digit or the second digit which generates the carry signal must be showing the cause of this alarm, i.e. phase difference in gear connection.

[Index] AXIS

[Code] YYYYZZZZ

YYYY=Hexadecimal number of the high-order digit read from the encoder

ZZZZ=Hexadecimal number of the high-order digit obtained by calculation from the lower-order digit

[Probable Faulty Locations]

- 1) Position encoder of the problem axis
- 2) SVP board of the problem axis
- 3) Synchronous signals of the system

[Measures to Take]

Convert the code to octal number.

If all the digits are shifted as in 1234523456

-> SVP board is defective.

If the first digit is discrepant as in 1234512344

-> MPR or bearing is defective in most cases.

If this alarm occurs in several axes

-> Synchronous signals of TFP or SVP board are defective.

★ 4011 SVP speed command over

The speed command calculated by SVP has successively exceeded the allowable limit. Here, the allowable limit means the speed command over alarm level.

[Index] AXIS

[Code]

Hexadecimal number of the absolute feedrate command value at the time of abnormality detection [encoder unit/feedrate control time]

[Probable Faulty Locations]

The causes are the same with those of SVP DIFF over alarm; for example, the mechanical load is large.

★ 4012 SVP servo data setting

The SVP has received non-applicable servo data. This alarm occurs when an abnormal value is set in the NC as servo data or when the servo processor cannot receive the set data.

Occurrence of this alarm during maintenance service implies that there may be an incompatibility between the servo parameter file and SVP software.

[Index] AXIS

[Code] Servo data number

- 21-> Kv value
- 22-> Hardware servo coefficient
- 23-> Slow up/down coefficient
- 26-> HB control slow up/down coefficient
- 2B-> Inductosyn special pitch
- 39-> Backlash compensation
- 3A-> CON speed limit
- 3B-> Mantissa of speed change ratio (straight line)
- 3C-> Exponent part of speed change ratio (straight line)
- 3D-> Speed change ratio (rotary)
- 41-> V-AMP output filter constant group
- 4F-> New speed detection G1
- 50-> New speed detection G2
- 51-> New speed detection HPF constant
- 52-> New speed detection LPF constant
- 53-> 1st speed acceleration/deceleration constant
- 54-> HB control constant
- 57-> 2nd speed acceleration/deceleration constant
- 58-> Notch filter constant group
- 62-> Encoder accuracy designation
- 71-> Amplifier communication speed
- 86-> DIFF. MIN (DIFF-G variable)
- 87-> DIFF. MAX (DIFF-G variable)
- 88-> ATTF calculation constant
- 89-> Integration limit value
- 100-> FLSUD change timing abnormal
- 101-> 1st speed change timing abnormal
- 102-> 2nd speed change timing abnormal
- 103-> Exp change timing abnormal
- 104-> QITGMD change timing abnormal
- 105-> Wrong interpolation mode
- FFFF-> No authorization
- FFFE-> Infinite/rotary axis
- FFFD-> Infinite axis
- FFFC-> Speed change ratio
- FFFB-> Speed control cycle

[Probable Faulty Locations]

- 1) Servo parameter file of the problem axis
- 2) Control software such as that for NC
- 3) SVP software of the problem axis

★ 4013 **SVP belt is broken**

The SVP has detected breakage of the belt for the belt-driven axis.

[Index] AXIS

[Code] Hexadecimal number of the torque applied at the time of breakage

★ 4014 **SVP F-TYPE encoder error**

Error compensation data for one turn cannot be set in the position encoder.

[Index] AXIS

[Code] The number indicating the setting impossible reason

- 1-> Data read disabled
- 2-> Data check sum error
- 4-> Data overflow
- 5-> Error compensation data does not return to 0.

[Probable Faulty Locations] Position encoder of the problem axis

★ 4015 **SVP full closed loop error**

Deviation between the full-closed loop and semi-closed loop is abnormally large.

[Index] AXIS

[Code] The number of abnormality detection times

[Probable Faulty Locations]

- 1) Separately mounted position encoder or inductosyn of the problem axis
- 2) Excessive lost motion of the problem axis
- 3) Slippage, breakage, or wear of the belt on the problem axis
- 4) Coupling compensation is not set or wrong data is set in the problem axis.
- 5) The positional loop gain of the problem axis is not proper (too high).
- 6) Phase shift by collision of the problem axis

★ 4016 **SVP F-TYPE encoder with shaft error**

It is impossible to set the rotation error compensation data of F type position encoder with shaft.

[Index] AXIS

[Code] The number indicating the setting disable reason.

- 1-> Data read disabled
- 2-> Data check sum error
- 4-> Data overflow
- 5-> Error compensation data does not return to 0.

[Probable Faulty Locations] Position encoder of the problem axis

★ 4017 **SVP F with shaft APA pattern data**

The position encoder with shaft has successively read positional data of wrong patterns.

[Index] AXIS

[Code] Pattern of the read positional data(APA high-order digit)

[Probable Faulty Locations]

- 1) Position encoder of the problem axis
- 2) SVP hardware of the problem axis
- 3) Timing signal from the NC unit

★ 4018 **SVP cannot plant error offset data**

When the extended pitch error compensation function is provided, the SVP memory does not have enough capacity for storing the data.

[Index] AXIS

[Probable Faulty Locations]

- 1) SVP board controlling the problem axis
- 2) Extended pitch error compensation file containing extended pitch error compensation data of the problem axis

★ 4019 **SVP encoder application error (MOTOR SHAFT)**

The encoder type mounted on the motor does not conform to the encoder accuracy data.

[Index] AXIS

★ 4020 **SVP encoder application error (WITH SHAFT)**

The encoder type mounted on the shaft does not conform to the encoder accuracy data.

[Index] AXIS

★ 4021 **SVP collision detection**

The SVP has detected collision of the driving unit with something.

[Index] AXIS

[Code] YYYYZZZZ

YYYY: Average motor output torque

ZZZZ: Average motor acceleration

★ 4022 **SVP SA overload**

The servo amplifier has overheated exceeding the protection curve set in the SVP control software.

[Index] AXIS

[Code] YYYYZZZZ

YYYY: Set value of the protection curve used for overload detection

ZZZZ: Detected value [n] at overload detection

[Probable Faulty Locations] Servo amplifier of the problem axis

★ 4023 **SVP SA communication error**

Abnormality has occurred in communication between SVP and servo amplifier.

[Index] AXIS

[Code] Cause indication number

- 1-> Parity error in SVP
- 2-> The sent data does not match the received data.
- 3-> Servo amplifier ID is not properly received.
- 4-> No signal is sent from the servo amplifier.
- 5-> Parity error has occurred in servo amplifier.

[Probable Faulty Locations] Servo amplifier of the problem axis

★ 4024 **SVP SA version error**

Version check by the amplifier version control function proved that the mounted servo amplifier version is newer than the versions applicable to the SVP software.

[Index] AXIS

[Code] Version data

10000000-> BLII-D is mounted though BL-D is required.

XXYYZZ:

XX: SVP version

YY: Servo amplifier version applicable to SVP

ZZ: Servo amplifier version

[Probable Faulty Locations]

- 1) Servo amplifier of the problem axis.
- 2) A wrong version of servo amplifier was mounted.

**★ 4025 SVP SA motor current overload**

The servo amplifier has detected an excessive current flow in the motor cables. A warning lamp IOCM on the servo amplifier is lit.

[Index] AXIS

[Probable Faulty Locations] Servo amplifier of the problem axis

**★ 4026 SVP SA inverter bridge short circuit**

The servo amplifier has detected short-circuit of the inverter bridge in the amplifier. A warning lamp IOCS on the servo amplifier is lit.

[Index] AXIS

[Probable Faulty Locations] Servo amplifier of the problem axis

**★ 4027 SVP SA overheating**

The servo amplifier has detected overheating of the amplifier.  
A warning lamp SVTH on the servo amplifier is lit.

[Index] AXIS

[Probable Faulty Locations] Servo amplifier of the problem axis

**★ 4028 SVP SA power circuit overvoltage**

The servo amplifier has detected overvoltage applied to the power circuit of the amplifier. A warning lamp HV on the servo amplifier is lit.

[Index] AXIS

[Probable Faulty Locations] Servo amplifier of the problem axis

**★ 4029 SVP SA power circuit low voltage**

The servo amplifier has detected voltage drop in the amplifier power circuit. A warning lamp LV on the servo amplifier is lit.

[Index] AXIS

[Probable Faulty Locations] Servo amplifier of the problem axis

**★ 4030 SVP SA regenerative resistor overheat**

The servo amplifier has detected excessive power consumption in the regenerative resistance of the amplifier. A warning lamp DROH on the servo amplifier is lit.

[Index] AXIS

[Probable Faulty Locations] Servo amplifier of the problem axis

**★ 4031 SVP control circuit power voltage**

The servo amplifier has detected the abnormal voltage applied to the amplifier control circuit. A warning lamp VR on the servo amplifier is lit.

[Index] AXIS

[Probable Faulty Locations] Servo amplifier of the problem axis

★ 4032 **SVP SA error**

The servo amplifier is in some trouble.

[Index] AXIS

[Probable Faulty Locations] Servo amplifier of the problem axis

★ 4033 **SVP board version error**

The SVP hardware version is wrong.

[Index] AXIS

[Code]

1-> SVP hardware ID is not 1.

[Probable Faulty Locations]

- 1) SVP board controlling the problem axis.
- 2) A wrong version of SVP was mounted.

★ 4034 **SVP control error**

The SVP board is in a trouble related to the axis control.

[Index] AXIS

[Code] Alarm data

[Probable Faulty Locations] SVP software controlling the problem axis

★ 4035 **Memory board / battery change**

Memory board battery must be changed. Do not turn off the power.

The battery of memory board has finished its service life.

Call Okuma without turning off the power.

[Probable Faulty Locations] Battery in the memory board

[Code]

- 1-> Battery voltage has dropped lower than the battery change request voltage.
- 2->A specified period of time has elapsed since initial software installation.
- 3-> Power-off time has continued for a specified period of time.

[Probable Faulty Locations] Life-expired memory board battery

[Measures to Take]

Life-expired memory board battery

Change the battery in the memory board and reinstall the software and user data.

★ 4036 **Key-cord data receive error**

An error was detected in the operation panel key code data received by CRP board

[Code]

- Bit 0 to 3->Normally 0
- Bit 4-> Received data parity error
- Bit 5-> Overrun error
- Bit 6-> Received data framing error
- Bit 7-> Normally

[Probable Faulty Locations]

- 1) Faulty CRP board
- 2) Faulty operation panel
- 3) Disconnection or defective connection of the cable between CRP board and operation panel



★ 4037 **CCP-CPU error**

An error occurred with the CCP-CPU of the DNC-B specification.  
This alarm is not cleared unless the power is turned off and then on again.

[Code]

- 1-> A memory parity error or write error occurred in the CCP memory test.
- 2-> The CCP control program cannot be loaded correctly.
- 3-> The CCP control program cannot be started correctly.
- 4-> The CCP communication channel cannot be opened correctly.  
Or, the program data is written in ASCII codes though the protocol B is used (NC optional parameter bit No.11 bit1=1).  
Or, data input/output or verification is impossible by setting the NC optional parameter bit No.1 bit0=0/ No.11 bit1=0 (EIA). This is because two or more same settings exist at the NC optional parameter (bit No. 27, 28, 29, 30, 31, 49 (EIA code settings that represent '=', '\*', '[', ']', '\$', '#') or a code in the EIA code table is set.
- 5-> A CCP self-diagnostics error occurred.
- 6-> An exception error occurred with the CCP CPU.
- 7-> An error in the operation of the CCP control program occurred (task start control error).
- 8-> An error in the operation of the CCP control program occurred (real time task error).
- 9-> An error in the operation of the CCP control program occurred (time sharing task switching control error).

[Measures to Take]

- 1) Defective setting of NC optional parameters
- 2) Defective CCP Board
- 3) CCP control software has not been stored in Bubble Memory.
- 4) Defective Bubble Memory.
- 5) Defective CCP control software.
- 6) Incorrect CCP Board switch setting.

★ 4052 **PLC backup data file write**

Backup copy of data onto the backup file for PLC was attempted in vain.

[Code] Backup data type

★ 4053 **VAC power supply voltage flutter over**

Since the impedance of user's power source exceeds the allowable limit, normal VAC operation cannot be guaranteed.

[Probable Faulty Locations] User's power source

[Measures to Take] Improve the power source to reduce impedance.

★ 4054 **ACP Key-code data receive error**

The ACP board detected an error in the key code data sent from the operation panel.

[Code]

- XX
- bit0-> 0 (Fixed)
- bit1-> 0 (Fixed)
- bit2-> 0 (Fixed)
- bit3-> 0 (Fixed)
- bit4-> 0 (Fixed)
- bit5-> Operation panel CPU error
- bit6-> Initialize error
- bit7-> Communication error

[Probable Faulty Locations]

- 1) Defective ACP board
- 2) Defective operation panel
- 3) Disconnection or contact failure of the cable between ACP board and operation panel

[Measures to Take]

- 1) Replace the ACP board.
- 2) Replace the operation panel.
- 3) Replace or check for connection of the cable between the ACP board and the operation panel.

★ 4055 **Safety Speed Clamping**

This alarm occurs on the machine with the safety speed monitor function on the following condition:  
The axis exceeds the safety speed while the guard of the specified axis is open.

[Index] Axis or none (spindle)

[Character-string] None

[Code]

- 1-> The sequence restart button is pressed.
- 2-> Start, external start or PPC start button is pressed.
- 3-> Pulse handle overlap is activated.
- 4-> The program issued a cutting feed command.
- 5-> The programmed rapid traverse has exceeded the safety limit. Or, the program issued a rapid traverse command.
- 6-> The manual cutting feed button (+/-) is pressed.
- 7-> The pulse handle feed is selected and the pulse handle is rotated.
- 8-> Rapid traverse button (+/-) is pressed.
- 9-> The cutting feedrate, synthesized in the program, exceeded the safety speed.
- A-> JOG feedrate exceeded the safety speed.
- B-> The pulse handle feedrate exceeded the safety speed.
- C-> The manual rapid feedrate exceeded the safety speed.
- E-> A guard was opened during angle circular feeding.
- F-> The infinite circular interpolation speed exceeded the safety speed during the turning cut cycle.
- 101-> PLC-axis exceeded the safety speed by programmed axis feed.
- 102-> PLC-axis exceeded the safety speed by manual axis feed.
- 103-> PLC-axis exceeded the safety speed by pulse handle or step feed.

The alarm is displayed for two seconds even after the speed becomes lower than the safety speed limit.

[Related Specifications] Safety speed monitor function

[Measures to Take]

Close the operation door. Or, satisfy the operating conditions before issuing the required operation command.

★ 4056 **DNC-T error**

An error occurred as a result of acquirement of machining management data by DNC-T3.

[Index] None

[Character-string] None

[Code] XXYYZZZZ

- XX-> Module number where the error occurred
- YY-> Error cause number
- XX=
  - 1-> Communication device start-up
  - 2-> Communication device shut-down

- 3-> Opening of file
  - 4-> Closing of file
  - 5-> Reading from stream
  - 6-> Writing in stream
  - 7-> Relocation of file pointer
  - 8-> File termination check
  - 9-> File error check
  - A-> File error reset
  - B-> Opening of directory
  - C-> Closing of directory
  - D-> Reading of directory information
  - E-> Relocation of directory pointer
  - F-> Acquirement of current position of directory pointer
  - 10-> Deletion of file
  - 11-> Change of file name
  - 12-> Acquirement of empty space in device
  - 13-> Execution of command
  - 14-> Acquirement of communication parameters by item
  - 15-> Acquirement of device sector size
  - 16-> Acquirement of file information
  - 17-> Acquirement of OSP file attributes
  - 18-> Change of protection status
  - 19-> Setting of DNC-T file attributes
  - 1A-> Communication device start-up in server mode
  - 1B-> Communication device shut-down in server mode
  - 1C-> Acceptance of process request from the host
  - 1D-> Response to machining control command
  - 1E-> Uploading of machining control data
  - 1F-> Generation of COM task
- Error cause (ZZZZ = 0 if not YY = FF)
- YY=
- 02-> Communication parameter file open error
  - 09-> Communication parameter file read error
  - 0D-> Communication parameter file write error
  - 0E-> Board not mounted
  - 11-> Already started
  - 13-> Wrong device name
  - 16-> Wrong communication parameter value
  - FF-> Communication error
- ZZZZ=
- 006F->Small buffer size in TCP/IP driver
  - 0072->Faulty descriptor transferred to TCP/IP driver
  - 0073->Faulty parameter transferred to TCP/IP driver
  - 0074->No empty port in the shared memory
  - 0075->Unconnected
  - 007B->Abort command ignored
  - 007D->`ftp ms open' abnormal termination
  - 007E->`ftp ms close' abnormal termination
  - 007F->`ftp ms type' abnormal termination

0080->`ftp ms user' abnormal termination  
0081->`ftp ms pass' abnormal termination  
0082->`ftp ms acct' abnormal termination  
0083->`ftp ms delete' abnormal termination  
0084->`ftp ms fopen' abnormal termination  
0085->`ftp ms fopen uni' abnormal termination  
0086->`ftp ms net drecv f' abnormal termination  
0087->`ftp ms net dsend f' abnormal termination  
0088->`ftp ms fclose' abnormal termination  
0089->`ftp ms abort' abnormal termination  
008A->`ftp ms chdir' abnormal termination  
008D->`ftp ms pwd' abnormal termination  
008F->`ftp ms dopen' abnormal termination  
0090->`ftp ms dread' abnormal termination  
0091->`ftp ms dclose' abnormal termination  
0097->IP address error  
0098->No IP address  
0099->Interruption due to time-out  
009A->Disconnection command from the remote host  
009B->Abnormally terminated initialization of OS (MORE) on TCP/IP board  
009C->Abnormally terminated initialization of packet driver or TCP/IP module on TCP/IP board  
009F->Abnormally terminated initialization of FTP module on TCP/IP board  
00A0->Abnormally terminated initialization of socket interface module on TCP/IP board  
00A1->Abnormally terminated initialization of TCP/IP board  
A spec code error if XYZZZZ = FFFFFFFF  
This error code appears if any of the following conditions exists in the personal computer.  
The machining control data collection has been forcedly terminated.  
The system attempted to overwrite machining control data in a protected file.  
The directory specified by environment setting parameter does not exist.  
Writing in the disk has been disabled.  
Writing process was failed (due to insufficient empty space, for example).

★ 4150 **MCS Undefined alarm number**

The MCS caused an error related with axis control.

[Index] Axis name or none (spindle)

[Character-string] Alarm number in decimal

[Code] Alarm code

[Probable Faulty Locations]

- Depends on the number indicated in the character-string.  
Inform us of the code and the character string.

★ 4151 **MCS Exception processing**

A fatal alarm occurred while the MCS inverter unit and MCS software are executing their processing.

[Index] Axis name or none (spindle)

[Character-string] Cause of alarm detected

"#1"-> Control board error

"#2"-> Voltage drop of +-12 V battery for control board

"#3"-> OPF error

"#11"->Voltage drop of 5 V battery for control board  
"#12"->Invertor bridge shorted  
"#13"->IPM protective function activated  
"#14"->Motor overcurrent  
"#20"->INT loop error  
"#21"->INT5 loop error  
"#22"->INT4 loop error  
"#23"->INT3 loop error  
"#24"->INT2 loop error  
"#25"->INT1 loop error  
"#26"->Access denied  
"#27"->Ram check error in initialization  
"#28"->Party error  
"#29"->Watchdog error  
"#30"->IRQ7 interruption  
"#31"->NMI interruption  
"#32"->General illegal command  
"#33"->Slot illegal command  
"#34"->CPU address error  
"#35"->DMA address error  
"#36"->Undefined trap error  
"#37"->Undefined interruption  
"#38"->DMAC  
"#39"->ITU  
"#40"->SCI  
"#41"->REF  
"#42"->A/D  
"#43"->System reserved  
"#44"->User break

[Code]

In the case of #1, the code shows the error content of the control board.

In the case of #3, the code shows the error content of the optional program file.

- 1-> Identification code "OPF1" error
- 2-> End code "ED" error
- 3-> Sum check error
- 4-> Board name error

In the case of #11-14, #20-21, #25-26 and #30-31, the code shows the data in the error status register.

[Probable Faulty Locations]

In the case of #1,

- Invertor unit

In the case of #3,

- Optional program file
- Optional program file incompatible with invertor unit

In the case of #2 or #11,

- Power unit (when this alarm occurred in several invertor units)

In the case of #12, #13, or #14,

- Invertor unit

In other cases,

- Invertor unit

★ 4152 **MCS Processing trouble**

MCS

[Index] Axis name or none (spindle)

[Character-string] None

[Code] XXZZAAAA

XX:

04-> The self-diagnostic data has an error. (ZZ: Received data)

06-> Software sync bit or format code of buffer A is wrong.

07-> Software sync bit or format code of buffer B is wrong.

08-> An error occurred in data communication.

ZZ shows the data kind. AAAA is always 0.

ZZ:

1-> Speed command (8408)

2-> Laser linear scale value (4413)

3-> Backlash (4406)

4-> Actual position without positioning error compensation (440A)

5-> Positioning error compensation amount

6-> Full-closed loop encoder value (4410)

7-> Semi-closed loop encoder value (4411)

8-> ODIFF (4415)

10-> APA in divided stroke (4404)

11-> Acceleration/deceleration time for positioning (4422)

12-> Zero offset amount

13-> In-position width (4420)

14-> Maximum of divided stroke (4405)

15-> Point data change

[Probable Faulty Locations]

- Faulty MCS controller
- Faulty software

★ 4153 **MCS CON APA deviation**

Difference between CON and APA values has exceeded the allowable limit. The CON-APA deviation is the absolute value of difference between [calculated value written in MCS] and [actual position read from MCS]. The NC control software monitors this deviation. The MCS normally monitors DIFF value.

This alarm appears if the MCS causes a fatal error and cannot monitor the DIFF value.

[Index] Axis name

[Character-string] None

[Code] Absolute value of deviation in hexadecimal (reference unit)

[Probable Faulty Locations]

- Faulty MCS controller
- Mismatch between MCS data and NC data

★ 4154 **MCS Power-Supply-Unit Error**

The power unit caused an error.

[Index] Axis name or none (spindle)

[Character-string] None

[Code] AAAAAAXX

AAAAAA is always 0.

X Alarm number

- 0-> DC voltage alarm
- 1-> Abnormal input voltage
- 2-> Abnormal control power
- 3-> Abnormal control status
- 4-> Overload in regenerative circuit
- 5-> Heat sink overheat
- 6-> CPU error
- 7-> Spare

Y: Power unit status

bit3 1->An alarm occurred in the power unit. (Warning signal status: 0)

bit2 1->DC power is being supplied

bit1 1->OPRON input is closed

bit0 1->PWON input is closed.

ZZ: Data

X (alarm No.):0 ... Detected DC voltage in hexadecimal [3.9V]

X (alarm No.):1 ... Detected AC voltage in hexadecimal [3.1V]

X (alarm No.):2

- 1-> +5V abnormal voltage
- 2-> +12V abnormal voltage
- 3-> -12V abnormal voltage

X (alarm No.):3

- 1-> Converter over current
- 2-> Abnormal power element
- 3-> Converter short circuit
- 4-> Abnormal regenerative circuit(type in power regenerative circuit)
- 5-> Abnormal regenerative circuit(type in resistor discharge)

X (alarm No.):4 Uncertain

X (alarm No.):5 Uncertain

X (alarm No.):6 Uncertain

[Probable Faulty Locations]

In the case of abnormal control power,

- Power unit

In the case of low voltage,

- Input voltage drop, power failure, blown fuse in input power circuit, or instantaneous power interruption

In the case of high voltage

- Power unit

★ 4155 **MCS Converter-link error**

The convertor link (used for communication between power unit and inverter unit) caused an error, disabling the NC from monitoring the power unit condition.

[Index] Axis name or none (spindle)

[Character-string] None

[Code] XAAAAAYY

AAAAA is always 0.

X=0: communication error

X=1: Time-out error (communication interrupted)

YY=communication status  
When X is ONE(1),always 0

[Probable Faulty Locations]

- Converter link cables or connectors
- Power unit
- Inverter unit control board

★ 4156 **MCS DC-bus voltage alarm**

The DC-bus voltage in the inverter unit has abnormally risen or fallen, disabling the inverter from supplying the current.

[Index] Axis name or none (spindle)

[Character-string] None

[Code] XXXXYYYY

XXXX=Detected overvoltage in hexadecimal [15.3 mV]

YYYY=Detected undervoltage in hexadecimal [15.3 mV]

[Probable Faulty Locations]

In the case of voltage rise,

- Power unit

In the case of voltage drop,

- Power unit
- Inverter unit
- Instantaneous power interruption

★ 4157 **MCS Motor over current**

The inverter unit has detected excessive current flowing in the motor cable.

[Index] Axis name or none (spindle)

[Character-string] None

[Code] XXXXYYYY

XXXX=U-phase current detected when this alarm occurs,expressed in signed hexadecimal [Tolerance: 3FFF]

YYYY=V-phase current detected when this alarm occurs,expressed in signed hexadecimal [Tolerance: 3FFF]

[Probable Faulty Locations]

- Inverter unit
- Faulty motor insulation

★ 4158 **MCS Power unit over heat**

The inverter unit has detected excessive current flowing in the motor cable.

The inverter unit temperature has risen abnormally.

[Index] Axis name or none (spindle)

[Character-string] None

[Code] 1 (fixed)

[Probable Faulty Locations]

- Inverter unit
- Overload operation

★ 4159 **MCS Power unit over load**

The inverter load has exceeded the specified value, activating the overload protection function.

[Index] Axis name or none (spindle)

[Character-string] None



[Code] YYYYZZZZ

YYYY-> Gamma of the protection curve used to detect overload

ZZZZ-> Internally calculated overload data

[Probable Faulty Locations]

- Invertor unit
- Overload operation

**★ 4160 MCS Supply voltage flutter**

The power unit input voltage is abnormally high or low.

[Index] Axis name or none (spindle)

[Character-string] None

[Code] Detected abnormal voltage in hexadecimal [Volt]

[Probable Faulty Locations]

- Power unit
- Power cables or connectors
- Instantaneous power interruption

**★ 4161 MCS Power unit version error**

The invertor unit allowable current is smaller than the current limit specified in the servo data file.

[Index] Axis name or none (spindle)

[Character-string] None

[Code] 1 (fixed)

[Probable Faulty Locations]

- Invertor unit
- Servo data file

**★ 4162 MCS Winding-change failed**

The winding-change magnet switch does not come on.

[Index] Axis name or none (spindle)

[Character-string] None

[Code] YYYYZZZZ

If YYYY = 0000

ZZZZ =0001: Magnet conductor for low-speed winding is ON.

ZZZZ =0002: Magnet conductor for high-speed winding is ON.

ZZZZ =0003: Magnet conductors for both windings are ON.

ZZZZ =0004: Winding change time-out

If YYYY = 1010

ZZZZ =0001: Faulty servo data file

[Probable Faulty Locations]

- Winding-change magnet switch

**★ 4163 MCS Encoder-link error**

An error occurred in the encoder communication link, disabling the encoder from detecting positioning speed.

[Index] Axis name or none (spindle)

[Character-string] None

[Code] XXYYZZZZ

XX = FF (fixed)

YY = 00: YY = 00: Error is detected at the motor encoder.  
01: Error is detected at the position encoder with shaft.  
02: Error is detected at the independent position encoder.  
03: Error is detected at ABSO SCALE.

ZZZZ= Encoder link error status at the time of error detection.

Each bit represents the kind of communication error.

bit 15 1: Error in communication with a stand-alone encoder  
bit 14 1: Error in communication with ABSO SCALE 2  
bit 13 1: Error in communication with ABSO SCALE or encoder with shaft  
bit 12 1: Error in communication with motor encoder  
bit 11 1: Undefined  
bit 10 1: Transmission loop error in AT (auto) mode  
bit 9 1: Data over error in data receiving part of interface  
bit 8 1: Undefined  
bit 7 1: Undefined  
bit 6 1: Modulation code error  
bit 5 1: CRC error  
bit 4 1: Format error  
bit 3 1: Double transmission error  
bit 2 1: Double reception error  
bit 1 1: Parity error  
bit 0 1: Time-out error

[Probable Faulty Locations]

- Motor encoder, ABSO SCALE, encoder with shaft, or stand-alone encoder of the problem axis
- Encoder link cables or connectors
- Invertor unit control board

**★ 4164 MCS Encoder error**

The motor encoder has become unable to detect positional data.

[Index] Axis name or none (spindle)

[Character-string] None

[Code] XXYYZZZZ

XX= Encoder error code depending on the encoder type

YY = Detailed encoder status. The status varies with the encoder type.

ZZZZ =Multi-turn position data. This data appears when the multi-turn position data has exceeded the rotating range.

XX = 0 (fixed)

YY = 1 (fixed)

ZZZZ =Multi-turn position data

[Probable Faulty Locations]

- Motor encoder

**★ 4165 MCS Encoder initialize failed**

An error occurred in initialization of the motor encoder.

[Index] Axis name or none (spindle)

[Character-string] None

[Code] XXYYZZZZ

XX= Encoder link sequence number at the time of error detection

- 0-> Reset
- 1-> Network address setting
- 2-> Request of basic information on communication
- 3-> Change of communication version
- 4-> Acquisition of device information
- 5-> Parameter change
- 6-> AT (auto) mode start
- YY= Error content
- 0-> Communication error
- 1-> Transmission start time over
- 2-> Transmission finish time over
- 3-> Reception finish time over
- 4-> Abnormal response address
- 5-> Abnormal response code
- 6-> Parameter error

ZZZZ=Additional data

If YY=0, the encoder link error status C2ERR at the time of error detection appears.

If YY=1, 2, or 3, the transferred frame information QC2MTINF appears.

If YY=4, the network address of the responding device appears.

If YY=5, the received frame information QC2RXINF appears.

If YY=6, the number of parameter that caused the alarm appears.

1= Not all the necessary parameters are received.

2= Basic information on communication is incompatible.

3= Multi-rotation detection range does not match.

[Probable Faulty Locations]

- Motor encoder
- Encoder link cables or connectors
- Invertor unit control board

**★ 4166 MCS Encoder with shaft error**

The encoder with shaft has become unable to detect positional data.

[Index] Axis name or none (spindle)

[Character-string] None

[Code] Same with <MCS Encoder error>

[Probable Faulty Locations]

- Encoder with shaft

**★ 4167 MCS Encoder with shaft initial**

An error occurred in initialization of the encoder with shaft.

[Index] Axis name or none (spindle)

[Character-string] None

[Code] Same with <MCS Encoder initialize failed>

[Probable Faulty Locations]

- Encoder with shaft
- Encoder link cables or connectors
- Invertor unit control board

★ 4168 **MCS ABSO SCALE error**

An error occurred in initialization of ABSO SCALE.

[Index] Axis name or none (spindle)

[Character-string] None

[Code] None

[Probable Faulty Locations]

- ABSO SCALE

★ 4169 **MCS ABSO SCALE initialize**

An error occurred in initialization of ABSO SCALE.

[Index] Axis name or none (spindle)

[Character-string] None

[Code] Same with <MCS Encoder initialize failed>

[Probable Faulty Locations]

- ABSO SCALE
- Encoder link cables or connectors
- Invertor unit control board

★ 4170 **MCS Magnetic encoder alarm**

The magnetic pulse generator has become unable to detect the motor speed. Or, the number of magnetic encoder gear teeth does not match the data in the MCS data file.

[Index] Axis name or none (spindle)

[Character-string] None

[Code] XXXXYYYY

XXXX=Error content

A-> A-phase voltage is abnormal.

B-> B-phase voltage is abnormal.

C-> Magnetic encoder data error

Others-> Servo data file set value detected when the count over error occurred in the magnetic encoder  
(No. of PG gear teeth \* 4 - 1)

YYYY=Additional error data (Varies with XXXX.)

If XXXX is A, A-phase voltage appears.

If XXXX is B, B-phase voltage appears.

If XXXX is C, 0 (fixed) appears.

Others-> Detected count value of magnetic encoder (No. of PG gear teeth \* 4 - 1)

[Probable Faulty Locations]

- Magnetic encoder or its wiring, or large gap between magnetic encoder and gear
- Mismatch between the number of gear teeth of magnetic encoder and the servo data file data

★ 4171 **MCS Resolver alarm**

The resolver does not send any signal.

[Index] Axis name or none (spindle)

[Character-string] None

[Code] 1 (fixed)

[Probable Faulty Locations]

- Resolver trouble, or disconnection or contact failure of the resolver cable

★ 4172 **MCS Pulse generator count over**

The PG (pulse generator) count value per one turn differs from the corresponding data specified in servo data file.

[Index] Axis name or none (spindle)

[Character-string] None

[Code] XXXXYYYY

XXXX=PBU set value (Count number for one PG turn)

YYYY=Actual count number

[Probable Faulty Locations]

- Faulty PG
- Mismatch between the number of PG gear teeth and the servo data file data

★ 4173 **MCS Motor over heat**

The motor temperature is abnormally high.

[Index] Axis name or none (spindle)

[Character-string] None

[Code] YYYYZZZZ

YYYY = 0 (fixed)

ZZZZ = 0010: Motor overheat

ZZZZ = 0011: Motor overheat is detected at the motor.

ZZZZ = 0012: Motor overheat is detected at the position encoder.

ZZZZ = 0013: Motor overhead is detected at the motor and the encoder.

[Probable Faulty Locations]

- Malfunction of VAC motor fan, dirty heat sink, CW/CCW turns and stops at high frequency
- BL motor
- Motor encoder (BL motor detects overheat by its encoder.)

★ 4174 **MCS Servo-link error**

A communication error occurred in the servo link, disabling the servo unit from receiving commands from the NC.

[Index] Axis name or none (spindle)

[Character-string] None

[Code] XXXXYYYY

XXXX=0 (fixed)

YYYY=Bit number indicating the kind of communication error  
(Servo link error status at the time of error detection)

bit 15 1: 2nd B-buffer error

bit 14 1: 2nd A-buffer error

bit 13 1: 1st B-buffer error

bit 12 1: 1st A-buffer error

bit 11 1: MT buffer error

bit 10 1: Relay processing error

bit 9 1: Data over error in data receiving part of interface

bit 8 1: Disconnection

bit 7 1: Address pointer error

bit 6 1: Modulation code error

bit 5 1: CRC error

bit 4 1: Format error

- bit 3 1: Double transmission error
- bit 2 1: Double reception error
- bit 1 1: Parity error
- bit 0 1: Time-out error

[Probable Faulty Locations]

- Inverter unit control board
- Servo link cables or connectors
- FCP board

**★ 4175 MCS Servo-link disconnect**

The servo link is disconnected, disabling the servo unit from receiving commands from the NC.

[Index] Axis name or none (spindle)

[Character-string] None

[Code] XXXXYYYY

XXXX=Disconnected position

0-> Disconnected right in front of the problem unit

8000->Disconnected before the problem unit

YYYY=Servo link error status at the time of error detection

[Probable Faulty Locations]

- Servo cables or connectors
- Inverter unit control board
- FCP board

**★ 4176 MCS Servo-link protocol error**

The NC and the inverter unit exchange commands and responses at constant intervals according to the specified protocol through the servo link. In this communication, a wrong protocol or abnormal timing was used to transfer the data from NC to the inverter unit.

[Index] Axis name or none (spindle)

[Character-string] None

[Code] Number indicating the error content

1-> A-buffer Software synchronization error

2-> A-buffer Format code error

3-> B-buffer Software synchronization error

4-> B-buffer Format code error

5-> B-buffer Block number error

[Probable Faulty Locations]

- Inverter unit control board
- NC software
- Inverter unit control board not compatible with NC software
- FCP board

**★ 4177 MCS Servo data error**

The servo data sent from the NC for initialization or operation is not applicable to the inverter unit.

If this alarm occurs after change of inverter unit, the servo data file is not applicable to the inverter unit.

If this alarm occurs after adjustment or change of the servo data, the servo data is wrongly changed.

[Index] Axis name or none (spindle)

[Character-string] None

[Code] XXXXYYYY

XXXX=Data ID number of the data that caused the error

YY= Data set number of the data that caused the error

ZZ= Error content

1-> Out of setting range

2-> Wrongly set timing

3-> No transmission

4-> Calculation error

5-> Others

[Probable Faulty Locations]

- Servo data file not compatible with inverter unit
- Inverter unit not compatible with NC software
- Inverter unit control board
- NC software

**★ 4178 MCS Illegal command**

The NC and the inverter unit exchange commands and responses through the servo link. In this communication, the NC sent an abnormal or inexecutable command to the inverter unit.

[Index] Axis name or none (spindle)

[Character-string] None

[Code] XXXXYYYY

XXXX=

10-> Positioning mode Command point number over

11-> Positioning mode Negative command value

12-> Positioning mode Larger command value (specified position > 360 deg for rotary axis)

13-> Positioning mode RPositioning point table not transmitted

14-> Positioning mode Non-rotating axis

15-> Positioning mode Command format other than points

16-> Positioning mode Positioning sub-mode error

21-> Parameter change Parameter number out of specifiable range

22-> Mode Undefined mode

23-> Mode Positioning/tool path mode condition

24-> Coordinate system Coordinate system designation error

30-> Unused bit is ON in the bit commands for controlling the S-link A buffer.

31-> Unused bit is ON among the bit data in the S-link B buffer.

40-> AT mode is selected without reception of time synchronization command.

YYYY=Error data

X in the range from 10 to 16 shows the positioning sub-mode.

0-> Program mode 1:Search mode 2:PH mode 3:Teach mode

[Probable Faulty Locations]

- Inverter unit not compatible with NC software
- Inverter unit control board
- NC software

★ 4179 **MCS CON speed over**

Increments for positioning command (SRCOND) issued from the NC to the inverter unit exceed the allowable limit.

If this alarm occurs in the axis to be positioned, the servo data file has wrong data. (This is because the inverter unit calculates the increments for the axis to be positioned.)

[Index] Axis name or none (spindle)

[Character-string] None

[Code]

Absolute value of increments processed for acceleration/deceleration [(pr/65536)/Tp]

Where, pr= One turn of position encoder; Tp= Position control frequency

The following codes, however, have specific meanings:

1-> The increments were so large that they were judged erroneous in preliminary check.

2-> The position command (SRCON) exceeds the absolute value of the encoder measuring range (linear axis only).

[Probable Faulty Locations]

- Servo data file
- NC software

★ 4180 **MCS Speed command over**

Speed command value issued from the NC to the inverter unit exceeds the allowable limit.

[Index] Axis name or none (spindle)

[Character-string] None

[Code] Speed command [(rev/4294967269)/Tv]

rev= One motor turn; Tv= Speed control frequency

[Probable Faulty Locations]

- Servo data file
- NC software

★ 4181 **MCS DIFF over**

Axis movement caused a large positioning error.

While the axis is in a target position or stopped, the target value and the calculated value are the same. With an axis movement command, the NC starts creating calculation values (RCON) until the target point is reached. At this time, the actual position follows the calculated value with a certain delay. This delay is called "following error" and calculated by ([calculation value] - [actual value]). If the "following error" exceeds the allowable limit, the above alarm occurs.

[Index] Axis name or none (spindle)

[Character-string] None

[Code] Absolute value of following error [pr/65536]

pr = One turn of position encoder

[Probable Faulty Locations]

- Overload due to faulty ball screw or bearing
- Motor
- Inverter unit
- Servo data file



★ 4182 **MCS APA speed over**

The position encoder value (RAPA) changes as the motor rotates.

The NC checks this change with preset frequency.

This alarm occurs if the change per unit time exceeds the allowable range consecutively. For example, an axis feedrate is abnormally high compared with the normal rapid feedrate, or the encoder value changes irregularly due to malfunction of the position encoder.

[Index] Axis name or none (spindle)

[Character-string] None

[Code]

Absolute value of the change in encoder value per position control frequency [encoder's 1/65536 turn/position control frequency]

The following codes, however, have specific meanings:

1= Linear axis has exceeded its travel range.

2= Rotary axis has exceeded its travel range (360 deg) or limited axis has negative positional data.

3= Limited axis has exceeded its travel range.

[Probable Faulty Locations]

- Motor encoder (BL motor)
- Encoder link cables or connectors (BL motor)
- PG or magnetic encoder (VAC motor)
- PG or magnetic encoder cables or connectors (VAC motor)
- Invertor unit control board

★ 4183 **MCS Full-closed APA error**

Difference between the full-closed loop encoder value and the motor encoder value exceeds the allowable range.

[Index] Axis name or none (spindle)

[Character-string] None

[Code] Number of times the error has been detected

[Probable Faulty Locations]

- Synthetic offset data is not set at the full-closed loop encoder or wrong data is set.
- ABSO SCALE or position encoder with shaft
- Excessive lost motion in axis drive system (The motor is not rigidly connected with the movable part.)
- Slippage or breakage of shaft belt
- Loose coupling between motor and ball screw
- Improper positional loop gain (too high)

★ 4184 **MCS Over speed**

Actual motor speed is too high.

[Index] Axis name or none (spindle)

[Character-string] None

[Code] Motor speed detected when this alarm occurred [(rev/4294967296)/Tv]

Where, rev= One motor turn; Tv= Speed control frequency

[Probable Faulty Locations]

- Motor encoder (BL motor)
- Encoder link cables or connectors (VAC motor)
- Resolver or magnetic encoder (VAC motor)
- Resolver or magnetic encoder cables or connectors (VAC motor)
- Invertor unit control board

★ 4185 **MCS Velocity deviation over**

Actual motor speed excessively deviates from the speed command.

[Index] Axis name or none (spindle)

[Character-string] None

[Code] XXXXYYYY

XXXX: Detected torque (sum of the torque data collected for 3.2 ms)

+2<sup>-12</sup>[MAXTRQ]

If Tv = 0.4 ms, the momentary maximum torque is H'7FFF.

If Tv = 0.8 ms, the momentary maximum torque is H'3FFF.

YYYY: Detected acceleration (average value measured for 3.2 ms)

+2<sup>-16</sup>[vr/3.2 ms/3.2 ms]

= about 0.1 [rpm/ms]

The code number 00000001 means that the error data is replaced by zero because of exponent underflow.

[Probable Faulty Locations]

- The motor does not turn because of (mechanical lock or) application of large load.

★ 4186 **MCS Collision detected**

The NC torque limiter has detected collision of axis by monitoring the relation between motor output torque and motor acceleration.

[Index] Axis name or none (spindle)

[Character-string] None

[Code] XXXXYYYY

XXXX: Detected torque (sum of torque data collected for 3.2 ms)

+2<sup>-12</sup>[MAXTRQ]

If Tv = 0.4 ms, the momentary maximum torque is H'7FFF.

If Tv = 0.8 ms, the momentary maximum torque is H'3FFF.

YYYY: Detected acceleration (average torque measured for 3.2 ms)

+2<sup>-16</sup>[vr/3.2 ms/3.2 ms]

= about 0.1 [rpm/ms]

[Probable Faulty Locations]

- Collision
- Motor encoder
- NC torque limiter set value

★ 4187 **MCS Urgent-stop time over**

The axis cannot stop within a preset time after reception of emergency stop command.

[Index] Axis name or none (spindle)

[Character-string] None

[Code] XXXXXXXX

1-> Emergency stop time over

2-> Deceleration time over at emergency stop

3-> Deceleration time over at alarm stop

[Probable Faulty Locations]

- Invertor unit control board
- NC software

★ 4188    **MCS Belt is broken**

Breakage of belt was detected in the belt-driven axis.

[Index] Axis name or none (spindle)

[Character-string] None

[Code] Load torque (hexadecimal) at the time of alarm detection

[Probable Faulty Locations]

- Broken belt

★ 4190    **MCS independent encoder init**

An error occurred during initialization of the MCS independent encoder.

[Index] Axis name or none (spindle)

[Character-string] None

[Code] XXYYZZZZ

XX-> Encoder link sequence number

- 0: Reset
- 1: Net address setting
- 2: Request to send the basic information for communication
- 3: Change of communication software version
- 4: Acquisition of device information
- 5: Parameter change
- 6: AT mode start

YY-> Alarm content

- 0: Communication error
- 1: Transmission start time over
- 2: Transmission end time over
- 3: Reception end time over
- 4: Wrong response address
- 5: Wrong response code
- 6: Parameter error

ZZZZ->Data

YY = 0: Encoder link error status C2ERR established on detection of the error

YY = 1: 2, or 3: Transmitted frame information QC2MT INF

YY = 4: Net address of the corresponding device

YY = 5: Received frame information QC2RXINF

YY = 6: Parameter number at which the error is detected

- 1 = Reception of insufficient number of parameters
- 2 = Basic information for communication being incompatible
- 3 = Multi-turn detection range over

[Probable Faulty Locations]

- Independent position encoder
- Encoder link cables and connectors
- Inverter unit control board

★ 4191 **MCS APA error**

An error occurred during calculation of APA value.

[Index] Axis name or none (spindle)

[Character-string] None

[Code] XXXXXXXX

- 1-> Linear axis divided travel over
- 2-> Overflow during conversion of semi-position from [pr] to pf].
- 3-> Underflow in synthesizing the axis data
- 4-> Overflow in synthesizing the axis data
- 5-> Overflow of input values used for hybrid control
- 6-> Overflow during initialization for hybrid control

[Probable Faulty Locations]

- Motor encoder, encoder with shaft, or ABSO SCALE
- Invertor unit control board
- Servo data file

If the alarm code is "1" or "3", the position encoder may not

If the alarm code is "4", the servo data file may be defective.

If the alarm code is "5" or "6", the motor coupling, encoder with shaft, or ABSO SCALE may be loosely mounted.

★ 4192 **MCS Motor over load**

The motor load has exceeded the preset value, activating the overload protection function.

[Index] Axis name or none (spindle)

[Character-string] None

[Code] YYYYZZZZ

YYYY-> Gamma of the protection curve used to detect overload

ZZZZ-> Internally calculated overload data

[Probable Faulty Locations]

- Motor
- Overload caused by machine operation
- Servo data file

★ 4200 **Axis drive unit**

★ 4201 **Axis lube oil level**

★ 4202 **Battery voltage low**

Battery voltage for the ECP board is lower than the specified voltage.

A lithium battery of 3.4 V capacity is used, and the threshold level of the low battery voltage alarm is 2.4 V.

[Probable Faulty Locations] Low battery voltage

[Measures to Take] Change the battery within a week after the alarm lamp comes on.

★ 4203 **Spindle override range over**

★ 4204 **Feedrate command limit over (replacing)**

The F command value (the feedrate after being overridden) has exceeded the allowable feedrate and operation is continued with the F command value being changed.

The allowable feedrate refers to the smallest value of the following.

- Maximum feedrate set at optional parameter (long word) No. 10
- Machine-specific maximum cutting feedrate set by Okuma

- Upper limit feedrate in tolerance control (effective only in the tolerance control mode)

[Code] The F value of the changing operation is displayed as a hexadecimal.

[Probable Faulty Locations]

- 1) Feedrate command value is too large (perhaps due to a mistake in the unit setting system).
- 2) The maximum feedrate setting value is too small.
- 3) Override setting is too large.

Program Example:

G01 X1000 F14000

If the setting at NC optional parameter (long word) No. 10 is 13000, an alarm occurs with the commands above.

[Measures to Take]

- 1) Change the commanded feedrate.
- 2) Change the setting of the maximum feedrate.
- 3) Set the feedrate override value to a smaller value.

#### ★ 4205 Hydraulic oil temperature high

The oil temperature of the hydraulic unit has risen.

This alarm is caused by turning OFF of the oil temperature normal signal sent from the combination unit or the hydraulic unit installed at the rear of the table.

- 1) Combination unit
- 2) W-axis balancer hydraulic unit  
MDB-A, MCV-A
- 3) APC hydraulic unit  
MDB-A, MCV-A, MDB-B, MCV-B, MCR, MCM

[Character-string]

None->Combination unit

W-> W-axis balancer hydraulic unit

APC-> APC hydraulic unit

[Probable Faulty Locations]

- 1) Oil cooling fan motor is not operating.
- 2) Cooling filter is clogged.

#### ★ 4206 Sequencer not ready

The oil temperature of the hydraulic unit has risen.

This alarm is caused by turning OFF of the oil temperature normal signal sent from the combination unit or the hydraulic unit installed at the rear of the table.

- 1) Combination unit
- 2) W-axis balancer hydraulic unit  
MDB-A, MCV-A
- 3) APC hydraulic unit  
MDB-A, MCV-A, MDB-B, MCV-B, MCR, MCM

[Character-string]

None->Combination unit

W-> W-axis balancer hydraulic unit

APC-> APC hydraulic unit

[Probable Faulty Locations]

- 1) Oil cooling fan is not operating.
- 2) Cooling filter is clogged.

★ 4207 **Lube oil drain tank overflow**

The drain oil overflow signal detected by the float switch in the lubricating drain tank is turned on.

[Measures to Take] Remove the lubricating oil in the drain tank.

★ 4208 **MSB reserved**

This alarm outputs the check results of the Maker subprogram.

[Code] Refer to the Operation Manual for the relevant Maker subprogram.

[Measures to Take]

Check the following items.

- 1) Transfer parameter
- 2) NC status
- 3) Setting data

★ 4209 **User reserve code**

With the user task 2 specification, VDOUT[990]=\*\*\*\* is specified in a program.

[Code]

The value designated at the right part of the command and the user alarm comment designated in the command format of VUACM[\*]=\*\*\*\*\* are displayed.

Decimal numbers from 0 to 9999 is allowed for "\*\*\*\*\*", and display is given with leading zeros suppressed. For a number other than those indicated above, "FFFFFFF" is displayed.

★ 4210 **Graphic panel operating**

A graphic command (GRER: graphic erase, GRST: graphic data set) is specified while the operation is being carried out on the graphic screen (graphic trace erase key is pressed, for example).

Operation Example:

The GRER command is input while the graphic drawing data is being created, display screen is being changed, or graphic trace is being erased.

[Measures to Take] The alarm is cleared at the completion of graphic data setting.

[Related Specifications] Color graphic specification

★ 4211 **SAC air pressure low**

Air pressure of the tool tip wear compensation SAC II unit is lowered.

★ 4212 **Axis lube pressure unusual**

★ 4213 **System check**

A check number is set at machine user parameter (word) No. 40 to check the user's special specification functions.

[Character-string] The number set at parameter

[Probable Faulty Locations] The data at machine user parameter(word) No.40 is not zero (0).

★ 4214 **Spindle head lube oil temp. unusual**

With the simplified spindlehead lubricating oil cooling specification, this alarm occurs when the oil temperature normal signal is turned off.

- 1) MDB-A, MCV-A

[Probable Faulty Locations] Lubricating oil is not cooled normally.

★ 4215 **Spindle speed change gear shift motor overload**

★ 4216 **Safety interlock**

On the machine provided with specifications for the safety standard, the operation door interlock function was activated (disabling machine operation).

When this interlock function is activated (by opening the operation door during machine operation), this alarm occurs to display DOOR as a character string. This alarm also occurs when the APC safety mat interlock is activated (the APC mat is stepped on during APC operation). In this case, "MAT" appears as a character string.

[Character-string] DOOR, MAT or None (See Code 1 to F)

[Code]

- 1-> The sequence restart button is pressed.
- 2-> The start, external start, or PPC start button is pressed.
- 3-> Pulse handle overlap was attempted.
- 4-> The program includes cutting feed.
- 5-> Programmed rapid traverse has exceeded the set feedrate or the program includes rapid traverse.
- 6-> The manual cutting feed button (+/-) is pressed.
- 7-> The pulse handle is selected and rotated.
- 8-> The rapid traverse button (+/-) is pressed.
- 9-> In the programmed cutting feed, the synthesized feedrate has exceeded the set value.
- A-> The JOG feedrate has exceeded the set value.
- B-> The pulse handle feedrate has exceeded the set value.
- C-> The manual rapid feedrate has exceeded the set value.
- D-> The C-axis is fed in jog mode or C-axis jog feedrate has exceeded the set value.

[Measure to Take]

Close the operation door.

Or, specify a required command after fulfilling the operation possible conditions.

★ 4217 **Parameter setting**

Parameter which becomes effective by turning off the power supply once and then turning it back on.

★ 4218 **DNC-B communication error**

Communication error occurred during communication with the host computer using the protocol A/B.

[Index] None

[Character-string] None

[Code] YZZ (hexadecimal)

Y: OSP state where the error occurred

- 0-> Operation uncompleted state (DNC switch is OFF or CCP system is in abnormal state)
- 1-> OSP normal state
- 2-> Buffer operation state
- 3-> Alarm state or communication error state

ZZ: Cause

- 01-> Check sum error occurred successively the number of times (Ne) set at the parameter. (Protocol A)
- 02-> Parity error occurred successively the number of times (Ne) set at the parameter. (Protocol A)
- 04-> No response \*1
  - CTS signal OFF (Protocol A/B)
  - Response timer T1 time over (Protocol B)
- 05-> DSR signal OFF (Protocol A/B)
- 06-> Invalid response or TV check error
  - NC program data codes specified at the NC optional parameter (bit) No.1 bit0/No.11 bit1 do not match the settings on the host.

- The NC received a non-existing command. (Protocol A)
- Transfer error was detected the number of times (Ne) set at the parameter. (Protocol A)
- When TV check is executed, each record length is not composed of even number of characters.
- Code conversion error
- The NC received DC1, DC3, SYN, or NAK code while receiving the NC program. (Protocol B)

08-> Reception buffer overflow

09-> The NC received a signal from the host computer while not waiting for any response.

0A-> Overrun error (Protocol A/B)

0B-> Framing error (Protocol A/B)

[Probable Faulty Locations]

01-> Communication parameters or NC optional parameters are wrongly set.

02-> Communication cable or, in rare case, RS232C I/F is faulty.

03-> Hardware, software, or their parameters of the host computer are faulty.

[Measures to Take]

01-> Check the communication parameters related with the cable specifications (such as RS232C I/F channels used, parity, the number of stop bits, transfer code, end code, and baud rate) and the NC optional parameters. Correct improper parameters.

02-> Check the hardware, software, and their parameters of the host computer. 03-> Check if the NC is connected with the channel for DNC-B and the communication cable is in normal state.

[Related Specifications] DNC-B

**★ 4219 DNC-B message format error**

Error has occurred in the reception message in the protocol A.

As for the cause of the alarm, "6. Reception of unexpected message" is reported to the host computer.

[Code]

None-> Message exceeds 72 bytes (4,000 bytes for NC program).

XXXXYY-> Mistake in the data designated by the [SET] command

XXXX: Hexadecimal number of the wrong data (numerical data)

YY: Byte position inside the data

[Probable Faulty Locations]

1) Defective software used at the host computer

2) Text format mismatch due to mismatch of the version of DNC-B specification at the CNC

[Measures to Take]

Check the set data against the upper and lower limits of the text format specified in the DNC-B specification.

[Related Specifications] DNC-B

**★ 4220 DNC-B communication system abort**

Unrestorable error has occurred in the protocol A. (This alarm is not cleared unless the power is turned on again.)

[Code]

10-> Overrun error has occurred.

11-> Framing error has occurred.

[Probable Faulty Locations]

1) Defective RS232C interface

2) Defective hardware or software of the host computer

3) Mismatch between the actual communication line specification (baud rate, code configuration, etc.) and the communication set by the communication parameters.

[Measures to Take]

1) Check the hardware and software of the host computer.



- 2) Change the channel being used to another channel by setting the proper data at the communication parameter. (Change the connection of the connector to the proper position, accordingly.)
- 3) Check the following communication specifications between the actual communication line specification and the communication parameters:
  - RS232C interface channel being used
  - Parity
  - Number of stop bits
  - Transmission code
  - End code
  - Baud rate

[Related Specifications] DNC-B

★ 4221 **ATC interlock releasing**

The alarm occurs when "52" is set at machine user parameter(word) No. 40 while the ATC is operated in the one step operation mode.

In this condition, interlock conditions for one step operation are all ignored. This means that inching operations of the ATC tool change arm are always possible.

★ 4222 **Oil/coolant separator tank overflow**

With the flush-out coolant specification:

The oil/coolant separator is used to separate coolant from oil.

The separated oil is returned to the drain tank.

The alarm occurs when the tank becomes full of drain oil.

[Measures to Take] Remove the drain oil.

[Related Specifications] Flush-out coolant specification

★ 4223 **Touch prove battery**

Battery voltage of the touch probe is low.

★ 4224 **Index table unclamp**

An attempt is made to start operation while the index table is not clamped.

[Index] the table correctly by giving the index command again.

★ 4225 **Conveyor motor overload**

The overload relay of the pallet loading/unloading motor of the pallet pool setup station is actuated.

★ 4226 **Coolant unit**

With the oil skimmer specification, the oil skimmer correct signal remains off for more than one[s].

★ 4227 **Axis clamp confirmation**

With the PME type pallet pool specification, the stop pin IN confirmation limit switch is not turned on within ten[s] after the completion of pallet magazine positioning.

[Character-string] APC

★ 4228 **MOP overload**

★ 4229 **Spindle overload**

The spindle overload has exceeded the setting for overload monitoring.

[Code] XXXXYYYY:

XXXX: Overload monitoring parameter number

YYYY: Load factor at occurrence of the alarm

★ 4230 **DNC Unjust notice**

A status information which is not possible was input from the communications processor (CCP).

Character string Message type indication consisting of 5 characters (transfer command or sub command)

[Code] XXYYZZAA:

XX: Communications status

00-> Request for communications

01-> Idle status

02-> Data is being sent.

03-> Final data has been transmitted.

07-> Data is being received.

08-> An interrupt request has been sent.

09-> Abort code has been sent in response to the interrupt request.

FE-> Forced interrupt is being requested.

FF-> Forced interrupt has been performed.

YY: Status (type)

01-> Connect

02-> Disconnect

03-> Send

04-> Receive

05-> Abort

06-> Interrupt

08-> Connection confirmation

09-> Forced interrupt

0A-> Link complete

ZZ: Status (termination status)

00-> Normal termination

01-> Abort termination

02-> Interrupt termination

03-> Abnormal termination

AA: Status

01-> Host computer connection

02-> Host computer disconnection

03-> CNC abort

04-> Host computer abort

05-> CNC interrupt

06-> Host computer interrupt

07-> Abnormal parameter

08-> Abnormal data

09-> Abnormal communications

0A-> Service reception disabled

[Probable Faulty Locations] CCP application software

★ 4231 **DNC Illegal parameter**

Online enable data or communications parameter is abnormal.

Character string Message type indication consisting of 5 characters (transfer command or sub command)

[Code] XYYYY

X: Status

1-> Message effective identification table

2-> Message type table (TYPE-A)

- 3-> Message type table (TYPE-B)
  - 4-> Structure definition table for transfer data
  - 5-> Station address information table
  - 6-> Code information table
  - 7-> NC program information table
  - 8-> Unit system information table
  - 9-> Communications protocol matrix
  - A-> Communications protocol control table
  - B-> Time information table
  - C-> Line information table
  - D-> Header information table
  - E-> Text information table
  - F-> Communications line information table
- YYYY: Status not used

[Probable Faulty Locations]

- 1) Online enable data file [MHU\*.PBU] or communications parameter data file [MIU\*.PBU]
- 2) Software

**★ 4232 DNC Illegal data**

Format error in the received text.

Or format error in the text to be sent.

Character string Message type indication consisting of 5 characters (transfer command or sub command)

[Code] XYYYY:

X: Status

- 1-> Message type (when sending the text)
- 2-> Service classification (when sending the text)
- 3-> Transfer data sequence number (when sending the text)
- 4-> Data size is faulty.
- 5-> Format of actual data is faulty.
- 6-> Delimiter (when receiving data)
- 7-> Mismatch of machine number (when receiving data)

YYYY: Status not used

[Probable Faulty Locations]

- 1) Received text
- 2) Software

**★ 4233 DNC Communication abort**

The host computer is not ready for RS232C transmit/receive.

Or data transmission from the host computer is interrupted.

[Character-string]

Message type indication consisting of 5 characters (transfer command or sub command)

[Code] XXYYYY:

XX: Status

- C1-> Collision of ENQ
- C2-> Interrupt of host computer
- C3-> Selecting wait time over
- CA-> Data transmission from the host computer has been terminated.
- CB-> Text has been terminated abnormally.
- D1-> No-response monitoring time over

D2-> Transmission interrupt time over

D8-> RC1 retry over

D9-> RC1 retry over

DA-> RC3 retry over

DB-> RC4 retry over

DC-> RC5 retry over

DD-> RC6 retry over

DE-> RC7 retry over

DF-> RC8 retry over

E0-> RC9 retry over

E1-> RC10 retry over

E2-> RC11 retry over

E3-> RC12 retry over

E4-> RC13 retry over

E5-> RC14 retry over

E6-> RC15 retry over

E7-> RC16 retry over

E8-> RC17 retry over

E9-> RC18 retry over

EA-> RC19 retry over

EB-> RC20 retry over

RC1-> Number of ENQ request-for-reply retransmissions for a no-response state.(7)(Sending)

RC2-> Number of ENQ request-for-reply retransmissions for a WACK response.(35)(Sending)

RC3-> Number of NAK retransmissions for a TTD response (7)(Receiving)

RC4-> Number of 'selecting' retransmissions when 'selecting' contention occurs.(7)(Sending,Receiving)

RC5-> Number of NAK retransmissions when abnormal text is received.(7)(Receiving)

RC6-> Number of ENQ or 'text' retransmissions when NAK is received.(7)(Receiving)

RC7-> Number of times a request-for-reply can be received consecutively.(Receiving)

RC8-> Number of ENQ retransmissions for ENQ, NACK, WACK responses, following a TTD transmission.(7)(Sending)

(): These values represent the number of retry times, or the number or consecutive receptions, which are possible.

YYYY:Status

0002->RS232C parity error

0004->RS232C framing error

0008->RS232C receive overrun error

0010->RS232C BBC/CRC error

0020->Receive buffer overflow

0040->Response wait time over

0080->Time out between characters

#### [Probable Faulty Locations]

- 1) When CA0000 is indicated as the code: Faulty transparent code
- 2) When D80040 is indicated as the code:
  - RS232C board
  - Hardware or software of the host computer
  - Communicating device is not correct.
  - Bit length of the data is not correct.
  - The synchronous communications mode is selected.
  - Data transmission speed is not correct.

- Parity error
- Stop bit error
- "EXT" is selected as the synchronizing clock.

3) When DC0020 is indicated as the code: The block size of the received text is not correct.

**★ 4234 DNC Unjust request**

An attempt is made to send a new command though transmission of the previous command has not been completed. Or an attempt is made to send an abort request while data is not being transmitted.

[Character string]

Message type indication consisting of 5 characters (transfer command or sub command)

[Code] XXYYZZ:

X: Communications status

00-> Request for communications

01-> Idle status

02-> Data is being sent.

03-> Final data has been transmitted.

07-> Data is being received.

08-> An interrupt request has been sent.

09-> Abort code has been sent in response to the interrupt request.

FE-> Forced interrupt is being requested.

FF-> Forced interrupt has been performed.

YYYY: Status information

0001->Send 0002 Abort

0002->Abort

0003->Interrupt 0004 Forced disconnection

0005->Connection

[Probable Faulty Locations] Software

**★ 4235 DNC Receive message is unsame**

Another command is received while sending or receiving data.

Character string Message type indication consisting of 5 characters (transfer command or sub command)

[Code] XXXXYYZZ:

XXXX Message type (type)

0000->Message other than specified 0001 'INI'

0002->'ALM' 0003 'MER'

0004->'TER' 0005 'CAR'

0006->'SRT' 0007 'FIN'

0008->'STA' 0009 'PST'

000A->'OPC'

000B->'OPE'

000C->'NCP'

000D->'RST'

000E->'SEL'

000F->'EXE'

0010->'DEL' 0011 'DIR'

0012->'TME' 0013 'DTA'

0014->'MSG' 0015 'TOF'

0016->'TLM' 0017 'COM'

0018->'ATC' 0019 'STR'

001A->'END'  
001B->'SST'  
001C->'INT'  
001D->'MST'  
FFFF->Message type not identified  
YY: Message type (classification 1)  
00-> Message other than specified  
01-> Request(transfer command when sending data = C)  
02-> Response(transfer command when sending data = D, N)  
03-> Instruction(transfer command when receiving data = C)  
04-> Confirmation(transfer command when receiving data = D, N)  
FF-> Message type not identified  
ZZ: Message type (classification 2)  
00-> Message other than specified  
01-> Normal data (transfer command = D)  
02-> Error data (transfer command = N)  
FF-> Message type not identified

[Probable Faulty Locations]

- 1) CCP application software
- 2) Software

★ 4236 **DNC Send message is unsame**

An attempt is made to send a command though transmission of another command has not been completed.

[Character string]

Type of mismatch message (transfer command or sub command)

[Code] XXXXYZZ

XXXX: Message type (type)  
0000->Message other than specified 0001 'INI'  
0002->'ALM'  
0003->'MER'  
0004->'TER'  
0005->'CAR'  
0006->'SRT'  
0007->'FIN'  
0008->'STA'  
0009->'PST'  
000A->'OPC'  
000B->'OPE'  
000C->'NCP'  
000D->'RST'  
000E->'SEL'  
000F->'EXE'  
0010->'DEL'  
0011->'DIR'  
0012->'TME'  
0013->'DTA'  
0014->'MSG'  
0015->'TOF'

0016->'TLM'  
0017->'COM'  
0018->'ATC'  
0019->'STR'  
001A->'END'  
001B->'SST'  
001C->'INT'  
001D->'MST'

YY: Message type (classification 1)

00-> Message other than specified  
01-> Request(transfer command when sending data = C)  
02-> Response(transfer command when sending data = D, N)  
03-> Instruction(transfer command when receiving data = C)  
04-> Confirmation(transfer command when receiving data = D, N)  
FF-> Message type not identified

ZZ: Message type (classification 2)

00-> Message other than specified  
01-> Normal data (transfer command = D)  
02-> Error data (transfer command = N)  
FF-> Message type not identified

[Probable Faulty Locations] Software

★ 4237 **DNC Illegal sequence number**

An incorrect transfer data sequence number is input while receiving data.

[Character string]

Message type indication consisting of 5 characters (transfer command or sub command)

[Code] Hexadecimal number of the transfer data sequence number

[Probable Faulty Locations] Software

★ 4238 **DNC Communication not ready**

The host computer is not ready for RS232C transmit/receive.

Character string Message type indication consisting of 5 characters (transfer command or sub command)

[Code] XYYYY

X: Status (details 2 of termination status)

0-> DSR signal and CTS signal are OFF.  
1-> DRS signal is ON and CRS signal is OFF.  
2-> DRS signal is OFF and CRS signal is ON.  
3-> DRS signal is ON and CRS signal is ON.

YYYY: Status(details 3 of termination status)

Not used

[Probable Faulty Locations]

- 1) The power to the host computer is not turned on.
- 2) Communications cable
- 3) RS232C board

★ 4239 **Rotary axis parameter backup data**

An error exists in the rotary axis parameter backup data.

[Code]

- 1-> The MAC-H Model's 4th axis was designated as other than B-axis by the backup data.
- 2-> Duplicate axis names exist in the backup data.

[Probable Faulty Locations]

- 1) Backup file.
- 2) Specification code.
- 3) Rotary axis parameter setting.

[Measures to Take]

- 1) Check the specifications code.
- 2) Check the rotary axis parameter setting.

★ 4240 **Spindle neutral gear select condition**

★ 4241 **Tool clamp/unclamp operation condition**

★ 4242 **G task stop**

It is no more possible to store the machining control data in the machining control data back up file.

[Probable Faulty Locations]

- 1) Defective memory board
- 2) Defective software (The machining control data back up file is damaged.)

★ 4243 **Cross rail position auto set mode**

For the machine with automatic crossrail positioning function, this alarm occurs as a warning to indicate that the automatic positioning mode is established.

[Code]

- 1-> Mode ON (The machine user parameter (bit) No. 40, bit 0 is set at ON.)
- 2-> High-speed positioning is being executed.
- 3-> Precision-positioning is being executed.

★ 4244 **ther axis not indicated has been moved**

While the ID/OD center was gauged by manual work gauging, an axis not used for gaging was moved.

[Index] AXIS

[Measures to Take]

This alarm can be released by moving the moved axis to the previous position, executing the clear command, or changing modes or screens (except when the screen is changed from ID/OD CENTER to CHECK).

★ 4245 **Waiting program selection during program operation**

While a file is accessed in program operation mode, "program select by schedule program", "PPC program select", or "external program select" was specified by background processing.

This alarm is displayed when "0" is set at the optional parameter (bit) No. 16 bit 3.

★ 4246 **File deleted**

Power is shut off during file edit (I-MAP edit, ME edit).

[Character-string] Deleted file name

For details, refer to the notice file "ERROR.BAK" in the memory (MD0:), where the deleted edit file name and code are recorded.

[Code]

- 1-> Edit
- 2-> I-MAP edit



3-> ME edit

★ 4248 **Error File**

Power is shut off during file edit.

[Character-string] Deleted file name

For details, refer to the notice file "ERROR.BAK" in the memory (MD0:), where the deleted edit file name and code are recorded.

In the ERROR. BAK

[Code]

1-> Edit

2-> I-MAP edit

3-> ME edit

★ 4249 **Door Interlock All Axis Stop**

When the operation door or front door is open, the door interlock function with D/U shutoff function displays this message, stopping all the axes.

★ 4250 **Door Interlock ATC & ATC magazine Stop**

When the ATC magazine door is open, the door interlock function with D/U shutoff function displays this message, stopping all the axes.

★ 4251 **Door Interlock APC Stop**

When the APC door is open, the door interlock function with D/U shutoff function displays this message, stopping all the axes.

★ 4252 **Please open door**

When the operation door or front door open/close confirmation limit switches are at close end with the power ON, the door interlock S function displays this message, requesting the operator to open the door to check if the limit switches normally function.

★ 4253 **Please open ATC magazine door**

When the magazine door close confirmation limit switch is at close end with the power ON, the door interlock S function displays this message, requesting the operator to open the door to check if the limit switch normally functions.

★ 4254 **Please open APC door**

When the APC door close confirmation limit switch is at close end with the power ON, the door interlock S function displays this message, requesting the operator to open the door to check if the limit switch normally functions.

★ 4255 **MOP-TOOL AUTO ENTRY**

A tool with unregistered tool number is used in automatic tool data setting mode, though tool data is full. When this alarm is displayed, the tool number is ignored; thus disabling MOP-TOOL function (aborting feedrate override control).

[Code] Tool number

[Measures to Take]

Delete unnecessary tool data and newly register required tool data, or change the active tool number. This alarm disappears by starting automatic tool data setting or resetting the NC.

[Related Specifications] Built-in type MOP-TOOL specification

★ 4256 **MOP-TOOL TOOL WEAR**

The MOP-TOOL detected a worn tool. The worn tool is registered as an abnormal tool without stopping the machine.

[Code] Tool number and tool classification number

[Measures to Take]

After tool change, reset the NC if the program may be interrupted. If not, select the tool data setting mode and edit the worn tool data file by displaying the page showing "Tool wear alarm" in its abnormal tool presence/absence column and pressing [F3] (CLEAR).

[Related Specifications] Built-in type MOP-TOOL specification

★ 4257 **MOP-TOOL OVERLOAD**

The MOP-TOOL detected an overload alarm. The machine stops immediately. If "alarm stop" has been specified at the function select parameter by parameter setting, the alarm-caused tool is registered as an abnormal tool.

[Code] Tool number and tool classification number

[Measures to Take]

If "temporary stop" or "temporary stop + spindle stop" has been specified at the function select parameter by parameter setting, register the alarm-stop-specified tool as an abnormal tool by pressing the abnormal tool registration switch on the addition panel before resetting NC.

After tool change, reset the NC if the program may be interrupted. To continue machining, if "temporary stop + spindle stop" has been specified, press the spindle stop release button on the additional panel to rotate the spindle. Then, edit the overloaded tool data file by displaying the page showing "Overload alarm" in its abnormal tool presence/absence column and pressing [F3] (CLEAR).

[Related Specifications] Built-in type MOP-TOOL specification

★ 4258 **MOP-TOOL ABNORMAL LOAD SIG.**

The MOP-TOOL detected an abnormal signal. The machine stops immediately. If "alarm stop" has been specified at the function select parameter by parameter setting, the alarm-caused tool is registered as an abnormal tool.

[Code] Tool number and tool classification number

[Measures to Take]

Take the same measures as taken on occurrence of MOP-TOOL OVERLOAD.

[Related Specifications] Built-in type MOP-TOOL specification

★ 4259 **MOP-TOOL MIN. OVERRIDE**

The MOP-TOOL detected the minimum override alarm. The machine stops immediately. If "alarm stop" has been specified at the function select parameter by parameter setting, the alarm-caused tool is registered as an abnormal tool.

[Code] Tool number and tool classification number

[Measures to Take]

Take the same measures as taken on occurrence of MOP-TOOL OVERLOAD.

[Related Specifications] Built-in type MOP-TOOL specification

★ 4260 **MOP-TOOL AE SENSOR ERROR**

The AE sensor generated an error. Or, the AE sensor is not normally connected to the ADP (AD conversion processor board).

The MOP-TOOL function does not operate (aborting feedrate override control).

[Probable Faulty Locations]

- 1) ADP board
- 2) AE board
- 3) Cable

[Measures to Take]

Replace the ADP (AD conversion processor board), AE board, or cable.

The built-in type MOP-TOOL function can be disabled by setting "1" at the NC optional parameter (bit) No. 34 bit 1 in the parameter setting mode.

[Related Specifications] Built-in type MOP-TOOL specification

★ 4261 **ADP ERROR**

An abnormality occurred in the AD conversion processor board and operation check counter does not increase its value.

The MOP-TOOL function does not operate (aborting feedrate override control).

[Probable Faulty Locations]

ADP board (AD conversion processor board) TMP board (thermal deviation AD conversion processor board)  
Built-in MOP-TOOL software

[Measures to Take]

Replace the ADP (AD conversion processor board).

For the thermal deviation compensation specification, replace the TMP board (thermal deviation AD conversion processor board).

The built-in type MOP-TOOL function can be disabled by setting "1" at the NC optional parameter (bit) No. 34 bit 1 in the parameter setting mode.

[Related Specifications]

Built-in type MOP-TOOL specification

Thermal deviation compensation

★ 4262 **Print data output**

An error occurred during printing of gauging data.

This alarm is displayed when "0" is set at the optional parameter (bit) No. 16 bit 3.

[Character-string] Created file name

[Code]

1-> A print command was specified while a file is accessed in program operation mode.

2-> Creating the file 'A.MDF' was attempted without enough free SAT.

[Related Specifications] Print function

★ 4263 **Stroke end limit reset**

A travel limit release button was pressed in manual operation mode.

★ 4264 **Axis interlock**

Manual rapid traverse, cutting feed, or pulse handle feed of X, Y, or Z-axis was attempted while the B-axis was not in any of 0°, 90°, and 180° positions.

[Index] AXIS

[Code] 5

★ 4265 **Work washing gun**

An abnormal condition occurred in the workpiece washing gun.

[Code]

1-> The work washing gun normal signal has turned OFF for 1 [s] or over during operation of the gun pump.

2-> When the gun pump operation command was issued, the coolant tank level normal FS was OFF.

[Probable Faulty Locations]

1-> Malfunction of work washing gun motor

2-> Low coolant tank level

★ 4266 **Air dryer unusual**

An abnormal condition occurred in the air dryer.

[Code]

1-> The dry air filter normal signal went OFF.

[Probable Faulty Locations]

- 1) Clogging of dry air filter

[Related Specifications] Air curtain, oil-air lubrication, linear encoder

★ **4267 Profile generation FPU error**

The machine with profile generation function is not provided with the calculation processor (FPU).

[Code]

- 2-> No FPU is mounted on the main board No. 2.

[Related Specifications] Profile generation specification

★ **4268 Waiting schedule start**

This alarm indicates that the machine is in the state of waiting schedule start after switching from independent operation mode to linked operation mode.

[Related Specifications] One-touch FMS (DNC-S)

★ **4269 ACP Version Error**

The ACP board is equipped with a ROM not applicable to 3-D graphic function.

[Character-string]

The first character of the ROM version mounted on the ACP board

[Probable Faulty Locations]

The ACP board is equipped with an old version of ROM not usable for the 3-D graphic function of the machine.

[Measures to Take]

Change the ROM on the ACP board with a one designed for 3-D graphic function.

★ **4270 No magazine tool to be selected**

All the tools in the tool group specified by T, TF, TG, or TD command are faulty.

[Index] None

[Character-string]

Tool group number for TG command

Tool group number and tool serial number for TF command

[Code] Faulty tool number in hexadecimal

[Probable Faulty Locations]

All the tools in the specified tool group are faulty.

The magazine does not have the specified tool.

[Measures to Take]

Set nondefective tools with the specified group number in the magazine.

★ **4271 Active tool is adjust tool**

The selected active tool is the tool of which adjustment is set to "Y" on the TOOL ID DATA screen for tool data setting.

[Index] None

[Character-string] None

[Code] Tool number in hexadecimal

[Related Specifications] Tool ID function

★ **4272 Conflict preventive speed over**

Feed rate component of each axis of the cutting feed which had instructed surpassed a maximum feed rate at the time of conflict prevention effectiveness of each axis.

A maximum feed rate used to grasp maximum rapid traverse rate of each axis on conflict prevention restrictive parameter set data (%) ratio at the time of conflict prevention effectiveness.

[Index] 3 axes of X, Y, Z

[Measures to take]

Cutting feed override is lowered, Or they make F instruction value small.

[Relation specification] Conflict prevention function

**★ 4273 Pulse handle feed limit**

When the parameters <<Independent pulse handle magnification effective>> and <<Pulse handle travel limit check>> are set at "1", any of the following operations causes the axis selected by <<n-th pulse handle>> to stop.

- The axis selected by <<n-th pulse handle>> is outside its travel range and is moved in the distant direction from the travel end limit.
- The moving axis selected by <<n-th pulse handle>> exceeds its travel end limit.
- In manual skip feed, the moving axis selected by <<n-th pulse handle>> is fed at a feedrate exceeding the maximum value.

[Index] None

[Character-string] None

[Code] XY

X: Pulse handle number that caused this alarm

1 to 7 (pulse handle No. 1 to No. 7)

Y: Pulse handle axis that caused this alarm

1 to 8 (pulse handle No. 1 axis to No. 8 axis)

[Measures to Take]

- Slowly rotate or stop the pulse handle.
- Decrease the pulse handle magnification.
- This alarm disappears two[s] after the cause of the alarm is removed by the above measures.

**★ 4274 Encoder operation check mode**

The encoder operation check mode is activated. (Direct position feedback encoder is checked for operation, or the position encoder is in the advanced transmission format.)

[Index] None

[Character-string] None

[Code]

None->The encoder of direct position feedback type is checked for operation.

1-> The position encoder is in the advanced transmission format mode.

[Measures to Take] The encoder checking mode is selected.

[Code]

None->Set "0" at the optional parameter (bit) No. 59 bit 1, and press the function key (BACKUP) on the parameter setting screen. On completing backup operation, turn off the power and turn it back on.

1-> Turn off the power and turn it back on.

**★ 4275 Thermal deviation compensation**

This is the alarm related to the thermal deviation compensation function.

[Index] None

[Character-string] None

[Code] XY

X= 1 Abnormal temperature data was sent from ADP.

Y= Sensor CH

- 
- 2 Temperature rise has exceeded the limit value.
- 3 The estimated temperature has exceeded the conversion table covering range.  
Y= 1X-axis thermal deviation 1  
2X-axis thermal deviation 2  
3X-axis thermal deviation 3  
4Y-axis thermal deviation 1  
5Y-axis thermal deviation 2  
6Y-axis thermal deviation 3  
7Z-axis thermal deviation 1  
8Z-axis thermal deviation 2  
9Z-axis thermal deviation 3
- 4 The total compensation amount exceeded the maximum compensation amount of the problem axis.  
Y= 1X-axis  
2Y-axis  
3Z-axis

[Probable Faulty Locations]

- X= 1 TMP is faulty or the machine is generating abnormal heat.
- 2 Too small value is set at the thermal deviation compensation parameter for the problem channel.  
Or, the machine is generating abnormal heat.
- 3 The estimated temperature for the deviation is out of the range for setting the thermal deviation compensation data. (Or, the machine is generating abnormal heat.)
- 4 The total compensation amount of the problem axis is out of the preset maximum compensation amount for each axis. (Or, the machine is generating abnormal heat.)

[Measures to Take]

Set a large limit value at the thermal deviation compensation parameter. Or, remove the cause of abnormal heat in the machine.

[Related Specifications] Thermal deviation compensation

★ 4276 **Axis overload**

Axis load has exceeded the value set for monitoring overload.

[Index] None

[Character-string] None

[Code] XYYYY

X: Overload monitor parameter No.

YYYY: Load rate detected when the alarm occurred[%]

★ 4277 **B-axis swivel limit**

[Index] None

[Character-String] None

[Code]1:

When it is sent that B axis is revolving B axis revolution scope(system parameter) concerning sending in a manually operatedoperational mode toward B axis revolution excess in additionand a button is pushed, it occurs.

When moreover the cutting sending button which a sending button has separated is turned into a limit, it does not occur.

[Measures to Take]

Establishment value of stroke end limited value of B axis revolution scope (systematic parameter) is changed.

Or, since B axis is revolving to revolution scope, B axis is made to move to the revolution limits.

★ 4278 **Axis swivel interlock**

[Character-string] None

[Code] None

In a manually operated operational mode, a sending button of axis table (A, C) that there is an opportunity outside was pushed and they moved.

Or, it was sent in a pulse handle.

When moreover sending of a limit, a pulse handle is stopped, the cutting sending button which a sending button has separated is not produced.

At the time of a pulse handle, after sending is stopped, it disappears after about 2[s].

★ 4279 **PPC communication error**

An error occurred in communication between new PPC and touch panel via RS232C.

[Index] None

[Character-string] None

[Code]

1-> Error in RSOPEN (initialization of RS-232C)

2-> Error in RSREAD (reading data received from RS-232C)

3-> Retry over in waiting response of screen number (no response for 3 times)

4-> Retry over in waiting response of screen number (different screen number received 3 times)

[Probable Faulty Locations]

- PPC touch panel is faulty.
- Cable is not perfectly connected or in the state of contact failure.
- RPP board is faulty.

[Measures to Take] Contact your nearest service center.

★ 4280 **Override range over**

[Index] None

[Character-string] None

[Code] =1

The rotary switch for controlling manual cutting feed rate has rotated over the stopper block.

[Measures to Take] Retighten the stopper block in position.

★ 4281 **Processing trouble**

An error occurred in the CNC.

[Index] None

[Character-string] 'TOOK-ID'

[Code] =XXXXX

X: User area No.

YYYY: Destroyed data content

[Measures to Take]

If the character string is 'TOOL-ID', the error will be automatically corrected.

Record how the trouble occurred; for example, part program and its approximate machining position, operation by the operator, and TOOL-ID communications data.

[Related specifications] TOOL-ID function

★ 4282 **PPC cycle can't start**

[Index] None

[Character-String] None

[Code] None

[Probable Faulty Locations]

- In order at times to perform PPC cyclic start PPC ON (continuation/1 cycle), NC starting button by a machine type panel was pushed.

[Measures to Take]

- When at times PPC cyclic start is performed PPC ON (continuation/1 cycle), at PPC cyclic starting button by PPC panel push.

★ 4283 **Door condition abnormal**

When there was by a door interlock function of D/U interception function, though there was an operational door close state, a relay of a safe module did not turn more than 5[s] it on.

- An operational door does not tightly close.
- An abnormal of a safe module, a relay.
- An operational door tightly closes.
- Exchange of a safe module, a relay.

★ 4284 **Thermistor error**

An alarm due to faulty thermistor

[Index] None

[Character-string] None

[Code] XYY

X = None:Thermistor detected -20°C.

A: Temperature difference from the previous temperature exceeded the value set for the check temperature parameter.

Note:This alarm does not occur if "0" is set at the check temperature parameter.

YY = Sensor channel number

[Probable Faulty Locations]

- 1) The relevant thermistor is faulty or disconnected.
- 2) TMP error
- 3) Setting error of the check temperature parameter

[Measures to Take]

- 1) Check the problem thermistor for mounted condition.
- 2) Replace the thermistor.
- 3) Replace the TMP board.
- 4) Check and correct the setting of the check temperature parameter.

Others: This alarm is not caused by the sensors at the channels 7 and 8 used for attachments.

[Related Specifications]

Thermal deviation compensation

★ 4285 **Interrupt program**

An interrupt trigger is generated, but the NC failed to normally run the interrupt program.

[Character-string] None

[Code]

- 1-> An interrupt trigger is generated during MDI operation mode.
- 2-> An interrupt trigger is generated during temporary stop.



3-> An interrupt trigger is generated during manual interruption mode.

[Measures to Take]

- 1) Select the automatic operation mode and press the cycle start button to execute the interrupt program.
- 2) Press the cycle start button to execute the interrupt program.
- 3) Exit the manual interruption mode and press the cycle start button to execute the interrupt program.

**★ 4286 Tool life previous notice**

The total number of parts that the active tool group can cut (the preset number minus the number of cut parts) becomes smaller than the number set for issuing the previous notice.

[Character-string] None

[Code]

Tool group number of which cutting capacity is smaller than the previous notice number

[Measures to Take]

- Check the remaining number of parts of the warned tool group.

**★ 4287 Quality check warning**

Quality check counter has reached the preset value.

[Character-string] None

[Code]

1-> The quality check counter is full.

[Measures to Take]

- Check the quality check counter and reset the counter after quality check.

**★ 4288 SPM Parameter unsuitable**

The data parameter value of the control program of SUPER MAIN CARD (SPMC) was unsuitable.

[Code]

- 2003411-> B Buffer NURBS:Unsuitableness of Start Control Point Position
- 4000001-> E Process Can't interpolate NURBS Data (0-differential).
- 4000011-> E Process Can't interpolate NURBS Data (1-differential).
- 4000021-> E Process Can't interpolate NURBS Data (1or2-differential).
- 5000001-> F Process Can't interpolate NURBS Data (0-differential).
- 5000011-> F Process Can't interpolate NURBS Data (1-differential).
- F000001-> T Process Unsuitableness of Control Parameter

[Probable Faulty Locations] NC program or system parameter is faulty.

[Measures to Take] Correct the NC program or system parameter.

**★ 4289 Magazine door open**

The magazine door is open.

**★ 4290 External program select error**

The NC received an abnormal signal in external program selection.

[Character-string] None

[Code]

1-> The program selection button and the pallet condition do not match.

[Measures to Take] Check the error signal "YSPH" for external program selection.

**★ 4291 Position encoder is adjusting**

The inductosyn is automatically adjusted.

[Index] None

[Character-string] None

[Code]

Axis number of which encoder has not been adjusted

Example: 46 ... The rotary axes No. 4 and No. 6 are being adjusted.

[Probable Faulty Locations]

[Measures to Take]

The inductosyn of the axis indicated by the code is being adjusted automatically. Move the axis at the speed for automatic adjustment until the alarm D goes off to complete adjustment.

★ **4292 Sub program is selecting**

This warning alarm indicates that the NC is searching or selecting the sub program to be called.

[Index] None

[Character-string] None

[Code] None

[Description]

This alarm is displayed until the called sub program is selected from the memory MD1:.

★ **4293 Super Hi-NC control cannot execute**

When the turning cut or teaching mode is selected during super Hi-NC control mode, the super Hi-NC mode is internally turned off and this alarm appears.

[Index] None

[Character-string] None

[Code]

100-> Turning cut mode is selected.

200-> Teaching mode is selected.

[Measures to Take]

Turn off the turning cut mode or teaching mode before operating the machine under Super Hi-NC control.

★ **4294 HI-CUT Pro Control cannot execute**

Hi-CUT Pro control is internally turned OFF.

[Index] None

[Character-string] None

[Code]

200-> The teaching mode is activated.

[Description]

This alarm is displayed while Hi-CUT Pro control is internally turned OFF in the teaching mode.

★ **4295 G131/130 command: unusable address characters**

G131/130 block contains the address character command that cannot be specified in that block. This alarm appears while the G131/130 block is effective.

[Probable Faulty Locations] Faulty NC program

[Measures to Take]

Rewrite the NC program in the correct format by referring to the programming manual.

★ **4296 Super Hi-NC parameter out of range (replacing)**

The super Hi-NC control parameters are out of the setting range and, therefore, they are replaced with the permissible values internally. This alarm appears while the replaced parameters are effective.

[Probable Faulty Locations]

- 1) The parameter values specified in G131 block exceed the effective range.
- 2) The specified parameter contains the following contradiction: minimum block length (for shape reconstruction) > maximum block length (for shape reconstruction).

[Measures to Take]

- 1) Specify the appropriate parameter in G131 block by referring to the instruction manual.
- 2) Specify a value that satisfies the condition: minimum block length (for shape reconstruction) ≤ maximum block length (for shape reconstruction)

**★ 4297 HI-CUT Pro parameter out of range (replacing)**

The specified HI-CUT Pro control parameters are out of the permissible range. The parameters are therefore replaced with the values within the range.

[Index] None

[Character-string] None

[Code] None

[Description]

This alarm is displayed while the parameters are being replaced.

**★ 4298 TOOL-ID TP communication error**

RS232C communication error occurred between the touch panel and TOOL-ID.

[Code]

**★ 4299 ATC communication error**

RS232C communication error occurred between ATC sub operation panel and the touch panel.

[Code]

**★ 4300 Gauging mode communication error**

Error occurred in communication of the gauging mode.

[Index] None

[Character-string] None

[Code] Error status

Bit 21: Data can not be written into work buffer for transmission.

Bit 19: RS232C device is not open.

Bit 16: Attempt was made to open the device already opened.

Bit 8 : Ready error (DSR is not ON)

[Probable Faulty Locations]

Bit 16: Faulty control software

Bit 19: Faulty control software

Bit 21: CTS signal is not ON.

Faulty cable or failure of the destination computer

Data transfer cycle is faster than the communication speed.

Bit 8: DSR signal does not come ON.

Faulty cable or failure of the destination computer

**★ 4301 Turning cut speed limit (replacing)**

Angular velocity is limited because, in the turning cut cycle, the radius for infinite circular interpolation has exceeded the permissible radius determined by the machine-dependent rapid traverse and the angular velocity at that time.

[Index] None

[Character-string] None

[Code]

- 1-> Angular velocity for circular movement is limited for the following reason:  
The radius for infinite circular interpolation has exceeded the allowable radius determined by the machine-dependent rapid traverse and the angular velocity at that time.
- 2-> Angular velocity is limited for the following reason:  
The current acceleration has exceeded the threshold value calculated from servo parameter used only for turning cut function.

[Probable Faulty Locations] The radius for continuous circular movements is too large.

**★ 4302 Dual palm cycle start**

[Index] None

[Character-string] None

[Code]

- 1-> The rise time of two start buttons is over one second.
- 2-> The fall time of two start buttons is over one second.

**★ 4303 Dual palm operation**

[Index] None

[Character-string] None

[Code]

- 1-> The rise time of two start buttons is over one second.
- 2-> The fall time of two start buttons is over one second.

**★ 4304 Axis moving time over**

[Index] None

[Character-string] None

[Code] None

**★ 4702 Hydraulic oil temperature high**

The oil temperature of the hydraulic unit has risen.

This alarm is caused by turning off of the oil temperature normal signal sent from the combination unit or the hydraulic unit installed at the rear of the table.

[Index] None

[Character-string]

None: Combination unit

'W': W-axis balancer hydraulic unit

'APC': APC hydraulic unit

[Code] None

[Probable Faulty Locations]

- 1) Oil cooling fan motor is not operating.
- 2) Cooling filter is clogged.

**★ 4703 System check**

This alarm shows that the system is under adjustment.

[Index] None

[Character-string] None

[Code] Kind of adjustment

★ 4704 **ATC interlock releasing**

This alarm occurs if all the interlocks are released during 1-step operation of the ATC.

[Index] None

[Character-string] None

[Code] None

★ 4705 **Work washing gun**

An abnormal condition occurs in the workpiece gun.

[Index] None

[Character-string] None

[Code] 1

★ 4706 **Auto power shut-off impossible**

Auto power shut-off is attempted during part program file operation.

[Index] None

[Character-string] None

[Code]

2-> Auto power shut-off is attempted during part program file operation.

[Measures to Take]

The power shut-off function is automatically activated when the part program file operation is over.

★ 4707 **Power ON/OFF sequence error**

[Index] None

[Character-string] None

[Codes]

1-> The emergency stop off delay timer relay, linked with the NC axis operation ON signal, became faulty. Check it when turning OFF the power.

2-> The NC axis operation ON signal relay became faulty. Check it when turning ON the power.

11-> The emergency stop off delay timer relay, which interlocked with the machine axis operation ON signal, became faulty.

12-> The machine axis operation ON relay became faulty.

[Probable Faulty Locations] The MCS power unit (MPS, MPR) or MCS drive unit (MIV) is faulty.

★ 4708 **Safety interlock**

This alarm occurs when the operation door interlock becomes activated (when the operation door is open during machine operation) under the door interlock condition, and "DOOR" will be displayed as the character-string.

This alarm occurs when the ATC magazine door interlock becomes activated (when the ATC magazine door is open during ATC operation), and "ATC" will be displayed as the character-string.

This alarm occurs when the APC safety mat interlock becomes activated (when the APC safety mat is stamped on during APC operation), and "MAT" will be displayed as the character-string.

This alarm occurs when the APC safety plug interlock becomes activated (when the APC safety plug is removed during APC operation), and "APC" will be displayed as the character-string (an exclusive function for double housing models).

This alarm occurs when the APC barrier interlock becomes activated (when the APC safety barrier photoelectric switch is shaded), and "BARR" will be displayed as the character-string (an exclusive function for double housing models).

[Index] None

[Character-strings]

"DOOR": Operation door  
"ATC": Magazine door  
"MAT": Safety mat  
"APC": APC setup door  
"BARR": Photoelectric switch

[Code] None

**★ 4709 Managing operating power shutdown**

After the CONTROL OFF button was pushed, it that shutdown condition satisfied passed the setting time (set at the "2. Operating power Shutdown Delay timer" [7. Power Sequence] machine system parameter) or more. (However, this is not abnormal.)

[Index] None

[Character-string] None

[Code] None

**★ 4710 Door interlock all axis stop**

When the operator door or the front door is open, the door interlock function with D/U shutoff function displays this alarm message, stopping all the axes.

[Index] None

[Character-string] None

[Code] None

**★ 4711 Door interlock ATC & ATC magazine door**

When the ATC magazine door is open, the door interlock function with D/U shutoff function displays this alarm message, stopping all the axes.

[Index] None

[Character-string] None

[Code] None

**★ 4712 Door interlock APC stop**

This message will be displayed and the all axes will come to a stop when the door interlock function has a DU cutoff function and the APC door is open.

[Index] None

[Character-strings]

None: APC door

"L": APC left cover

"R": APC right cover

[Code] None

**★ 4713 Please open door**

When the operation door or front door open/close confirmation limit switch is at the close end on a door interlock S model with the power ON, this message will be displayed to enable you to confirm that the switch is operating properly.

[Index] None

[Codes]

1-> Operation door

2-> Front right door or machine front door

3-> Front left door or machine rear door

4-> Bottom ladder step

- 5-> Pendant arm
- 6-> Magazine front door

**★ 4714 Please open ATC magazine door**

When the magazine door close confirmation limit switch is at the close end on a door interlock S model with the power ON, this message will be displayed to have the door opened by the operator and to confirm that the switch is operating properly.

[Index] None

[Character-string] None

[Codes]

- 1-> Magazine rear door or magazine 1 door
- 2-> Magazine front door or magazine 2 door
- 3-> Magazine 3 door
- 4-> Magazine 4 door

**★ 4715 Please open APC door**

When the APC door close confirmation limit switch is at close end with the power ON, the door interlock type S function displays this message, requesting the operator to open the door to check if the limit switches normally function.

[Index] None

[Character-string] None

[Code] None

**★ 4716 Touch probe battery**

Battery voltage of the touch probe is low.

[Index] None

[Character-string] None

[Code] None

**★ 4717 Door condition unusual**

The door lock confirmation function did not properly operate.

[Index] None

[Character-string] None

[Codes]

- 1-> The door lock pin ON confirmation function was not turned OFF within five seconds after the door lock output had been switched from ON to OFF.
- 11-> The MG door lock pin ON confirmation function was not turned ON within two seconds after the MG door lock output had been switched to ON.
- 12-> The MG door lock pin ON confirmation function was not turned OFF within five seconds after the MG door lock output had been switched from ON to OFF.
- 21-> The APC door lock pin ON confirmation function was not turned ON within two seconds after the APC door (or setup ST door) lock output had been turned ON.
- 22-> The APC door lock pin ON confirmation signal was not turned OFF within five seconds after the APC 8 (or setup ST door) lock output had been switched from ON to OFF.
- 100-> The operation door close confirmation SQ is turned OFF.
- 101-> The APC door open confirmation SQ is turned OFF.

**★ 4718 Stroke end limit reset**

The stroke end limit reset button was pressed in manual operation mode.

[Index] None

[Character-string] None

[Code] None

**★ 4719 Coolant unit unusual**

The coolant unit normal signal went OFF or the coolant unit abnormal signal came ON.

[Index] None

[Character-string] None

[Codes]

- 1-> The coolant unit normal signal went OFF or the coolant unit error signal came ON.
- 2-> The oil skimmer unit normal signal went OFF.
- 3-> The auxiliary tank oil level lower limit signal remained OFF for more than one second.
- 4-> The coolant flow normal signal remained OFF for a longer period of time than the time set at the parameter during coolant motor output.
- 10-> The centrifugal separator normal signal went OFF.
- 11-> The antifoaming unit error signal was turned ON.
- 12-> A cleaning cycle was executed when the centrifugal separator cleaning OK signal went OFF.

**★ 4720 NC START ineffective**

This alarm will be displayed when the NC start pushbutton was pressed during prohibition of an NC start by interlocking.

This alarm will disappear when the start pushbutton is released.

This alarm will remain displayed when warming up begins during prohibition of an NC start.

[Index] None

[Character-string] None

[Codes]

- None->Door interlock
- 11-> The program operation signal is turned OFF.
- 12-> The NC start pushbutton was pressed or the cycle start signal was turned ON when the robot/loader retract position signal was not turned ON with system interlocking "ON."

**★ 4721 Crossrail positioning auto set mode**

The machine equipped with a crossrail automatic positioning function is in automatic positioning setting mode.

[Index] None

[Character-string] None

[Codes] Mode On state

- 2-> During high-speed setting
- 3-> During precision setting

**★ 4722 Chip conveyor unusual**

The torque limiter for the lift-up conveyor became activated.

[Index] None

[Character-string] None

[Code] None

[Probable Faulty Locations] Cutting chips accumulate.

**★ 4723 Index table unclamp**

An attempt was made to start the machine with the indexing table unclamped.

[Index] None



[Character-string] None

[Code] None

[Measures to Take]

Reissue an indexing command to make the table properly perform indexing.

**★ 4724 Quality counter**

In a machine equipped with a multi-counter, a prediction/warning alarm occurred when the counter reached the set value.

[Index] None

[Character-string] None

[Codes]

1-> Work counter prediction A was turned ON.

2-> Work counter prediction B was turned ON.

**★ 4725 PPC cycle start impossible**

The PPC cycle start or NC start procedure of a machine equipped with a PPC is improper.

[Index] None

[Character-string] None

[Codes]

1-> The NC start pushbutton was pressed with PPC mode ON (continuous/1 cycle).

2-> The PPC cycle start pushbutton was pressed with PPC mode OFF.

[Measures to Take]

1) Turn OFF PPC mode S, and press the NC start pushbutton.

2) Turn ON PPC mode (continuous/1 cycle), and press the PPC cycle start pushbutton.

**★ 4726 Override switch position**

[Index] None

[Character-string] None

[Code] None

**★ 4727 Dual palm cycle start**

[Index] None

[Character-string] None

[Codes]

1-> The two start pushbuttons do not become activated within one second.

2-> The two start pushbuttons do not become inactivated within one second.

**★ 4728 Dual palm operation**

[Index] None

[Character-string] None

[Codes]

1-> The two start pushbuttons do not become activated within one second.

2->The two start pushbuttons do not become inactivated within one second.

**★ 4729 Cycle start**

[Index] None

[Character-string] None

[Code] None

★ 4730 **Feed rate limitation**

In a machine equipped with a CE marking function, the upper limit on rapid feed override is set at 50% in setting mode or test mode. In this case, this alarm will be displayed when the NC axis is in operation.

[Index] None

[Character-string] None

[Codes]

- 1-> The NC axis is in operation in setting mode.
- 2-> The NC axis is in operation in test mode.
- 3-> The NC axis is in operation in test mode and with the door open.

[Measures to Take] Perform program operation in production mode.

★ 4731 **Please close door**

In a machine equipped with a CE marking function, this alarm will be displayed when an ATC or APC command was issued and the operation door close confirmation signal went OFF in automatic operation mode of test mode and with the single block "ON" or in MDI operation mode.

[Index] None

[Character-string] None

[Code] None

[Measures to Take]

Close and lock the operation door, and press the restart pushbutton on the machine model panel.

★ 4732 **Lube unit**

The lubrication tank turned OFF the lubricant level normal signal for more than three seconds, or it turned ON the lubricant level low signal for more than three seconds.

[Index] None

[Character-string] None

[Code]

- 1-> An error occurred in the lubrication unit.

[Probable Faulty Locations] The lubrication unit is faulty.

★ 4733 **external coupled device alarm**

An error occurred in an external interlocking unit, such as a robot or loader.

In a machine equipped with a robot or loader, an alarm occurred in the robot or loader control unit.

[Index] None

[Character-string] None

[Codes]

None->Robot or loader control unit alarm

- 1-> Robot or loader control unit battery error

[Probable Faulty Locations]

- 1) The robot or loader control unit is faulty.

★ 4734 **Axis lube motor overload**

The overload relay for the axis lubrication motor became activated.

[Index] None

[Character-string] "APC" : APC axis lubrication motor

[Code] None

[Probable Faulty Locations] The axis lubrication motor is faulty.

[Measures to Take] Reset the overload relay for the axis lubrication motor.

★ **4735 Lube oil drain tank overflow**

The drain overflow signal detected by the float switch within the lubricant drain tank was turned ON.

[Index] None

[Character-string] None

[Code] None

★ **4736 Manual interruption**

The manual interrupt pushbutton was pressed in the middle of ATC operation.

[Index] None

[Character-string] None

[Code] None

★ **4737 Time over**

Jig operation was not completed within the time set at the parameter.

[Index] None

[Character-string] None

[Codes]

8: Timer counting

XXXX: When X is none, the input signal is not turned ON.

When X = 1, the input signal is not turned OFF.

YYY = The input signal address.

★ **4738 Fixture condition unusual**

The jig or jig control panel is not in good condition.

[Index] None

[Character-string] None

[Codes]

1-> The jig selector switch is not in good condition.

2->The jig operation selector switch is not in good condition.

★ **4739 Hydraulic oil level low**

The hydraulic oil level is low.

The float switch within the hydraulic oil tank turned OFF the hydraulic oil level normal signal or turned ON the hydraulic oil error signal.

[Index] None

[Character-string] None

[Measures to Take] Supply hydraulic oil.

## SECTION 8 ERRORS

Generally, the following defects can be a cause of all the errors. However, such causes are not referred to in explanation of individual errors. In fact, errors are seldom caused by the following defects.

- (1) Defects in the main board (CPU, DMA controller, D-RAM)
- (2) Defects in the memory board
- (3) Defects in the software

*Note:* 1. *When an error is caused by any of the above reasons, the actual cause is, in most cases, completely different from the causes described in explanation of the error.*

*Note:* 2. *If an error with three-digit number occurs during the time from display of "OPERATING SYSTEM PROGRAM ...." to system reset or power resupply, there is a high possibility that the cause is any of the above defects (1) to (3).*

Error Table

Error No.	Error Message
100	Device name
101	Sector device name
102	Print device name
105	File name
106	Command character
107	Command syntax
108	Option
110	File attribute
111	SAT full
112	Floppy uninitialized
114	Error-map information
118	SVCL error
124	Memory disk access sector over
125	Memory disk ROM access sector over
126	DMA transfer sector over
128	Memory disk format
129	Memory disk ROM setup
130	Floppy disc read/write
131	Floppy disc access sector over
132	Floppy disc write verify
133	Floppy disc seek
134	Floppy disc recalibrate
135	Floppy disc formatting
136	Floppy disc time out
137	Floppy ready
138	Floppy disk write protect
143	DMA transfer
146	CRP/ACP ready
147	Memory write/read test
148	Program load
149	Not found program file
150	Program load address
151	Program attribute
152	Memory disk ROM write
153	ROM-card write prohibit
154	Floppy RS232C block
155	Sector device uninitialized
200	System file data
201	MAB full
202	Record buffer over flow
203	Load object address
204	Load object attribute

Error No.	Error Message
205	Load verify
206	Data block size
250	Selected number
252	Memory disk RAM format
254	Memory disk RAM write/read test
255	FR-part-file size
256	FR-part-file number
257	FR-part-file load address
258	Size over
261	Data write verify
262	Memory disk ROM erase
263	File header
264	Install mode program load
265	Control-software attribute
267	Work area size
268	Memory disk battery voltage low
300	Device name
301	Sector device name
302	Print device name
303	Reader device name
304	Puncher device name
305	File name
306	Command character
307	Command syntax
308	Option
309	RS232C channel in use
310	File attribute
311	SAT full
312	Floppy uninitialized
313	File label area over flow
314	Error-map information
315	Volume-label information
316	File regist
317	Multi volume information
318	SVCL
319	RS232C device read
320	RS232C terminal not ready
321	RS232C ready status time out
322	RS232C ready interrupt time out
323	RS232C device name
324	Memory disk access sector over
325	Memory disk ROM access sector over
326	DMA transfer sector over

Error No.	Error Message
328	Memory disk format
329	Memory disk ROM setup
330	Floppy disc read/write
331	Floppy disc access sector over
332	Floppy disc write verify
333	Floppy disc seek
334	Floppy disc recalibrate
335	Floppy disc formatting
336	Floppy disc time out
337	Floppy ready
338	Floppy disk write protect
339	PTR read
340	PTR erratic operation detect
341	PTR ready status time out
342	PTR ready interrupt time out
343	DMA transfer
344	Printer
345	Puncher
346	CRP/ACP ready
347	Memory write/read test
348	Program load
349	Not found program file
350	Program load address
351	Program attribute
352	Memory disk ROM write
353	ROM-card write prohibit
354	Floppy RS232C block
355	Sector device uninitialized
400	Not found utility command file
401	Load object address
402	Load object attribute
403	Data block size
404	Initialize device name
405	Floppy disc initialize
406	Patch sector area
407	Patch sector address over
408	Console line setting
409	File write protect
410	System program registration
5000	MS-DOS
5001	Undefined IGF data
5003	DNC-T ERROR error-code
5200	Main program executing

Error No.	Error Message
5201	No main program file
5202	No main program name
5203	Tape TV check
5204	No tape data
5205	Tape parity
5206	Tape file name
5207	Tape read verify
5208	Input/output file name not same
5209	Input data overflow
5210	Input file name not same
5211	No subprogram
5212	Subprogram name
5213	File name
5214	Screen buffer overflow
5215	Schedule program search
5216	Schedule program executing
5217	Travel limit over
5218	No file data
5219	Check address
5220	Program end code
5221	Program search
5222	Program stack overflow
5223	Program buffer overflow
5224	Edit buffer move range
5225	File change inhibit
5226	Main program file selecting
5227	No empty SAT
5228	File record read
5229	IGF device name
5230	Sequence restart command
5231	Wrong tape code
5232	Record buffer overflow
5233	Axis spec
5234	EIA code
5235	RS232C channel in use
5236	'P'
5237	'Q'
5238	'R'
5239	Axis command
5240	Buffer over
5241	Program name
5242	RS232C device read
5243	File attribute



Error No.	Error Message
5244	DNC device
5245	DNC verify
5246	RS232C device not ready
5247	RS232C read buffer overflow
5248	RS232C ready interrupt time out
5249	FMS coupling mode
5250	Axis data
5251	R data
5252	Spec code
5253	No P number
5254	Machine parameter
5255	System data
5256	Message data
5257	Page number set
5258	No subprogram file
5259	Sequence label over
5260	Sequence name
5261	Device name
5262	Registered program
5263	Library stack overflow
5264	Library size overflow
5265	No schedule program file
5266	Pot command exist
5267	Registered tool
5268	Nonregistered tool
5269	Next tool command exist
5270	No empty pot
5271	Time out
5272	Pot No. registered
5273	Effective group No. 0-255
5274	Minus value invalid
5275	Max number of registered tools
5276	Max 32767
5277	Min -32768
5278	Operand decode impossible [SPR] ? [ORG] ?
5279	Operand decode impossible [OK] ? [NG] ?
5280	Large dia. tool mount impossible
5281	Tool mount impossible
5282	Tool No. clear impossible
5283	Input data
5284	Multi volume file information
5285	Set impossible
5286	Set condition

Error No.	Error Message
5287	Input data overflow (Sync. axis data)
5288	Tape convert file load
5289	DNC NC program not found
5290	DNC can not transmit
5291	DNC answer time over
5292	DC code
5293	DNC backup file name nothing
5294	FMS coupling mode
5295	DNC transmitting
5296	Remote operation mode
5297	High speed draw mode
5298	No blank data
5299	DNC data kind
5300	DNC data range
5301	Check point setting
5302	No blank data
5303	Set,add impossible
5304	Transfer blank data
5305	Coordinate system number undefined
5306	Geometory definition
5307	Blank shift
5308	DNC device name
5309	Blank display area
5310	No registered tool
5311	DNC directory format
5312	Amend device specify
5313	Not found pitch comp. data file
5314	LASER measurement execute
5315	Solid shape command
5315	Solid shape command
5316	Coordinate Change operation
5317	Relative actual position set axis name
5318	Program select impossible
5319	Output file specify impossible
5320	Wrong character
5321	Character size overflow
5322	Pattern selection
5323	Input data format
5324	No calculation result
5325	No last result
5326	No last element
5327	Data range over
5328	Radius size minus

Error No.	Error Message
5329	Chamfer size minus
5330	2 lines parallel
5331	2 circles piled
5332	Point inside circle
5333	Unknown circle direction
5334	Unknown circle radius size
5335	Circle inside another circle
5336	No intersection point between line and circle
5337	No intersection point between 2 circles
5338	Line definition impossible
5339	Calculation impossible
5340	Convert code
5341	Result data overflow
5342	Decimal point
5343	Numerical data
5344	No. of digits
5345	Area command
5346	Hole position command
5347	No block data
5348	CAL command
5349	Select number
5350	Data shortage
5351	Data range over
5352	No convert pattern
5353	Select plane tool length offset unmatching
5354	Select plane maximum return unmatching
5355	Initial program load
5356	Schedule program update mode
5357	Schedule program update entry
5358	MSB stack overflow
5359	MSB buffer overflow
5360	Cutter R. comp input NO.
5361	Zero set input NO.
5362	Tool length offset input NO.
5363	Set data limit over
5364	Data set not ready
5365	Change data
5366	Data update is inhibited
5367	Animation data file read
5368	MS-DOS
5369	MSB program load automatically when power on
5370	Can't block insert in DIALOGUE DATA (T-code)
5371	Can't block insert in DIALOGUE DATA (address)

Error No.	Error Message
5372	Can't block insert in DIALOGUE DATA (circle data)
5373	Upper 0-0 Lower 0-6
5374	Tool list file read
5375	Data verify
5376	Data file not found
5378	Data verify option
5379	Data read punch device name
5380	Thermal deviation compensation executing
5382	Not teaching mode
5383	F,S command memory buffer overflow
5384	Teaching impossible program operation method
5385	WRONG DATA FORMAT
5386	BEYOND DATA
5387	WRONG TOOL NO.
5388	USING TOOL
5389	LOAD PARAMETER
5390	TOOL NO. FULL
5391	B SADDLE
5392	BOUNDARY ADD
5393	WRONG ADDRESS
5394	NO-PROGRAMED REF.
5395	NO-PROGRAMED COEF.
5396	PROGRAMED ODD NO.
5397	NO FUNCTION DATA
5398	AP file:invalid mode
5399	AP file:invalid axis
5400	AP file not found
5401	AP file stack overflow
5402	AP data size
5403	AP data illegal code
5404	AP data out of range
5405	File operation execute
5406	AP file parameter
5407	AP file:mismatch tool position
5408	Invalid AP file apoint
5409	AP file:creation failure
5410	AP file:number of digits
5411	Load information file not found
5412	Adaptive control or Remote buffer operation
5413	Remote buffer operation
5414	Max 9999
5415	Min -9999
5416	Interlock error

Error No.	Error Message
5417	Nonregistered tool NO.
5418	User area data
5419	Tool input NO.
5420	Initial write
5421	Tool preparation function
5422	No such tool
5423	Operand decode impossible [Y] ? [N] ?
5424	Tool group input NO.
5425	Return pot NO. error
5426	DNC-DT Path name
5427	DNC-DT Program select
5428	Hard Disk initial
5429	TCP/IP initial
5430	command data out of range
5431	excessive the number of a tool
5432	A number of a tool list file
5433	Interrupt program buffer overflow
5434	Tool system data direct
5435	Tool name direct
5436	Tool No. direct
5437	Data range over
5438	Tool kind wrong character
5439	Tool data clear selection
5440	Tool data copy selection
5441	Tool data swap selection
5442	Work no blank data
5443	Teaching impossible
5445	Super Hi-NC Controls cannot execute
5446	Executing of external program select
5447	DNC-DT preload error
8201	Input data
8202	Registered tool
8203	Non open pot
8204	Nonregistered tool
8205	Pot command exist
8206	Next tool command exist
8207	Registered tool none
8208	Can not clear tool No.
8209	Tool set
8210	Parameter interlock
8211	Can not set Next tool No.
8212	Can not set Active tool No.
8213	Can not set return tool No.

Error No.	Error Message
8214	Max tool Number
8215	Tool mount impossible

★ 100     **Device name**

Wrong device name is designated, or when a device name is designated after renaming it in a renaming operation, it differs from the source device name.

[Character-string] Designated device name or None

[Code]

1-> Mismatch of device name in renaming operation

None->Cases other than "code 1"

[Probable Faulty Locations]

- 1) Error in spelling of the input device name
- 2) Designation of device name whose use is not allowed
- 3) Designation of device name differing from the source device name (RENAME command)

[Measures to Take]

- 1) Refer to the operation manual.
- 2) In the RENAME operation, designation of device name for the changed name is not required.

★ 101     **Sector device name**

As the sector device name, one of the parameters to be transferred to the sector device driver routine, any device name other than MD1, MD0, FR1, FR0, BB1, FD0, FD1, FD2 and FD3 is designated.

[Character-string] Designated device name

[Code]

FFFFFFFF-> No area is allocated to the specified device (size: 0).

None->An invalid sector device name is specified.

[Probable Faulty Locations]

- 1) Data on the sector device name has been destroyed.
- 2) The partition map for memory disk has been destroyed.
- 3) An invalid sector device name is specified.

[Measures to Take] Check the user memory data in the VID of memory disk.

★ 102     **Print device name**

A device name not allowed as a print device name is designated in one of parameters to be transferred to printer driver routine.

[Character-string] Designated device name

[Code] None

[Probable Faulty Locations] Contents of print device name variable PPRDV4 have been destroyed.

★ 105     **File name**

Characters "\*" and "?" are used for a command not used as a file name.

Either or both the file name and the extension are omitted in the setting of default file name for the USE command.

[Character-string] Designated file name

[Code] None

[Probable Faulty Locations]

- 1) In the file name designation step (except default), characters "\*" and "?" have been used.
- 2) File name and/or extension has been omitted in setting the default file name for the USE command.

[Measures to Take] Refer to the instructions for individual commands.

★ 106 **Command character**

A command that is not in the command table has been designated.

[Character-string] Command characters which have been input

[Code] None

[Probable Faulty Locations]

- 1) Spelling error of a command
- 2) Input of a command not allowed in the mode currently selected

[Measures to Take] Input the command using function keys.

★ 107 **Command syntax**

Syntax error of commands

[Character-string] Designated command

[Code]

- 1-> Delimiter is not ",".
- 2-> A command contains more than 8 characters.
- 3-> A device name contains more than 3 characters.
- 4-> A device name does not end with a colon ":".
- 5-> A file name contains more than 19 characters.
- 6-> A file name contains characters other than alphabetic characters, and symbols "\*\*\*", "?" and "-".
- 7-> The first character of a file name or extension is other than an alphabetic character, and symbols "\*\*\*" and "?".
- 8-> The option specification contains more than 16 characters (";" not counted).
- \$21-> Hexadecimal data contains more than 8-digit figures.
- \$22-> Decimal data contains more than 10-digit figures.
- \$23-> Hexadecimal data contains more than 4-digit figures.
- \$24-> Delimiter is not "-".
- \$25-> Numerical value of hexadecimal data is wrong.
- \$26-> The first alphabetic character is wrong.
- \$27-> Delimiter is not "=".
- \$28-> Hexadecimal data contains more than 2-digit or 3-digit figures.
- \$29-> Register name is wrong.
- \$2A-> Surplus data is still used.
- \$2B-> Delimiter is not ",".
- \$2C-> Trace register too large
- \$2D-> Trace memory too large
- \$2E-> Hexadecimal data is not an even number.
- \$2F-> Hexadecimal data contains more than 2-digit figures.

[Probable Faulty Locations]

- 1) A decimal number has been input although a hexadecimal number should be used.
- 2) In the word size designation, an odd number address has been designated.
- 3) Wrong data has been entered.

[Measures to Take] Refer to explanation and format of the wrongly specified command.

★ 108 **Option**

Wrong option characters have been designated.

[Character-string] None

[Probable Faulty Locations] An option not usable with the command designated has been designated.

[Measures to Take] Refer to the instructions for individual commands.



★ 110 **File attribute**

An attempt is made to read a file other than a sequential file and contiguous file, or an attempt is made to read a contiguous file in the sequential file reading processing, or to read a sequential file in the contiguous file reading processing.

[Character-string] None

[Code] File attribute code

1-> Contiguous file

2-> Sequential file

Others-> Unknown file

[Probable Faulty Locations]

- 1) Contiguous file has been designated in the list display, editing and other processing.
- 2) File directory of the bubble memory, floppy disk, etc. has been destroyed.
- 3) During multi-task execution, the directory of another file has been read by another task.
- 4) Part program file has been designated in reading the control program file.

★ 111 **SAT full**

Available storage area of the device designated is smaller than the required number of sectors.

[Character-string] None

[Code] Necessary number of remaining sectors

[Probable Faulty Locations]

- 1) Available area is not sufficient.
- 2) SAT sector information of the device has been destroyed.

[Measures to Take]

- 1) Delete unnecessary files.
- 2) Check the available area size with the FREE command.
- 3) Subtract the sizes of files registered from the device memory capacity and compare it with the data displayed for FREE command.

★ 112 **Floppy uninitialized**

The floppy disk is not initialized in the OSP format.

[Character-string] None

[Code] None

[Probable Faulty Locations]

- 1) Floppy disk or memory formatted to another format (EXORMACS, IBM, etc.)
- 2) Contents of VID of floppy disk or memory have been destroyed.

[Measures to Take]

- 1) To use an IBM format floppy disk, change the setting.
- 2) Check the contents at sector 0 (VID).
- 3) Usually, new floppy disks are formatted to IBM format. Therefore, initialize the disk to the OSP format using the INIT command.

[References] OSP File Structure

★ 114 **Error-map information**

Wrong sector identification name for error map information (containing faulty track information) of the IBM-formatted floppy disk

[Code]

0-> Wrong sector identification name

1-> Wrong information on faulty track

[Probable Faulty Locations] The error map information sector is destroyed.

[Measures to Take] Check the content of the error map sector.

★ 118 **SVCL error**

The NC control software issued an undefined system call (SVCL).

[Character-string] None

[Code] Address near the wrongly called address

[Probable Faulty Locations] Wrong control software is used.

[Measures to Take] Check and change the control software.

★ 124 **Memory disk access sector over**

Reading from or writing to the memory disk (MD) is attempted exceeding the capacity of the largest sector.

[Character-string] None

[Code]

XXXX->Sector number

[Probable Faulty Locations]

The file control data in the memory disk is destroyed.

The data file of the control floppy is not suitable for the actual memory disk capacity.

[Measures to Take]

Check the file control data for defects.

Reinstall the suitable control data file.

★ 125 **Memory disk ROM access sector over**

Reading from or writing to the memory disk (FR) is attempted exceeding the capacity of the largest sector.

[Character-string] None

[Code]

XXXX->Sector number

[Probable Faulty Locations]

The file control data in the memory disk is destroyed.

The data file of the control floppy is not suitable for the actual memory disk capacity.

[Measures to Take]

Check the file control data for defects.

Reinstall the suitable control data file.

★ 126 **DMA transfer sector over**

A numerical value 0 or 9 or larger is designated as the number of sectors for a single access operation at one of parameters to be transferred to the bubble memory or floppy disk drive driver routine.

[Character-string] None

[Code] The number of sectors designated

[Probable Faulty Locations] The number of sectors has not been set at the parameter.

★ 128 **Memory disk format**

The memory disk (MD) management data cannot be correctly recognized.

[Character-string] None

[Code] None

[Probable Faulty Locations] The memory disk management data is destroyed.

[Measures to Take]

- 1) Connect the battery to the memory board.
- 2) Change the SRAM card in the UCMB.
- 3) Change the UCMB.

**★ 129 Memory disk ROM setup**

An error has occurred in the circuit for diagnosing the combination of the memory board and ROM card.

[Character-string] None

[Code] None

[Probable Faulty Locations] The memory board and ROM card are used in wrong combination.

[Measures to Take] Prepare a correct combination.

**★ 130 Floppy disc read/write**

Read/write operation using floppy disk has not been completed correctly.

[Character-string] None

[Code]

XXXXXXXXYY

XXXXXX: Contents of result status 0, 1, 2, of floppy disk drive.

YY:

- |            |                  |
|------------|------------------|
| 05 or 45-> | Error in writing |
| 05:        | Side 0           |
| 45:        | Side 1           |
| 06 or 46-> | Error in reading |
| 06:        | Side 0           |
| 46:        | Side 1           |

[Probable Faulty Locations]

- 1) Defective floppy disk
- 2) Defective floppy disk drive

[Measures to Take]

- 1) Read and check all the sectors.
- 2) Try again using other floppy disk.
- 3) Try again using the floppy disk causing the error at another floppy disk drive.
- 4) In case the data on the floppy disk may be deleted, initialize the floppy disk then try read/write operation again.

**★ 131 Floppy disc access sector over**

A value greater than the actual floppy disk capacity is designated for the access sector using the parameter to be transferred to the floppy disk drive routine.

[Character-string] None

[Code] Accessed sector number

[Probable Faulty Locations]

- 1) Type of floppy disk
- 2) VID and SDB contents of the floppy disk have been destroyed.
- 3) File directory contents have been destroyed.
- 4) Pointer data which indicates the connection of the sequential file data block has been destroyed.

[Measures to Take]

- 1) Display the sequential file list.
- 2) Check the contents of VID, SDB and directory .

★ 132 **Floppy disc write verify**

Data mismatch is discovered when the data written into bubble memory is verified against source data.

[Character-string] None

[Code] Physical sector number at which error has occurred

[Probable Faulty Locations]

- 1) Defective floppy disk or floppy disk drive
- 2) Defective main board or DMA
- 3) During execution of multi-task, contents of the main memory being accessed by another task have been changed.

[Measures to Take]

- 1) Try again using another floppy disk.
- 2) Try again using the floppy disk causing the error at another floppy disk drive.
- 3) Replace the main board.

★ 133 **Floppy disc seek**

Error during seek operation for the floppy disk  
("Seek" means the operation to move the FDD head to the designated track position.)

[Character-string] None

[Code]

XXYY

XX-> Contents of result status 0 of floppy disk drive

YY-> Cylinder number

[Probable Faulty Locations]

- 1) Defective floppy disk
- 2) Defective floppy disk drive

[Measures to Take]

- 1) Try again using another floppy disk.
- 2) Try again using the floppy disk causing the error at another floppy disk drive.

★ 134 **Floppy disc recalibrate**

Error during floppy disk recalibration  
("Recalibration" means the operation to move the FDD head to the track number 0 position.)

[Character-string] None

[Code]

XXXX->Contents of result status 0, 1 of floppy disk drive.

[Probable Faulty Locations]

- 1) Defective floppy disk
- 2) Defective floppy disk drive

[Measures to Take]

- 1) Try again using another floppy disk.
- 2) Try again using the floppy disk causing the error at another floppy disk drive.

★ 135 **Floppy disc formatting**

Error during floppy disk formatting

[Character-string] None

[Code]

XXXXXXXX->Contents of result status 0, 1, 2, 3 of floppy disk drive

[Probable Faulty Locations]

- 1) Defective floppy disk
- 2) Defective floppy disk drive
- 3) Wrong designation of floppy disk type

[Measures to Take] Avoid reformatting of floppy disks.

**★ 136 Floppy disc time out**

The floppy disk operation completion status (service request: SRQ) has not been changed to the completed status within 10 seconds.

[Character-string] None

[Code]

- 1-> During read/write processing
- 2-> During formatting

[Probable Faulty Locations] Defective floppy disk drive

**★ 137 Floppy ready**

The floppy disk drive is not ready.

[Character-string] None

[Code] None

[Probable Faulty Locations]

- 1) Floppy disk is not set in the floppy disk drive.
- 2) Floppy disk is not set correctly in the floppy disk drive.
- 3) Floppy disk drive door is open.

[Measures to Take] Check the illumination of the ready lamp at the front of the floppy disk drive.

**★ 138 Floppy disk write protect**

Writing onto the floppy disk is impossible.

[Character-string] None

[Code] None

[Probable Faulty Locations] The floppy disk is write-protected.

[Measures to Take] Change the disk to write-enabled (by handling the protect notch on the disk.)

**★ 143 DMA transfer**

An error has occurred during DMA transfer, or DMA operation has not been completed.

[Character-string]

- Floppy An error occurred in the DMA on the FRP board.  
Memory disk An error occurred in the DMA on the memory board.

[Code]

XXXX->Indicates the error status of DMA.

[Probable Faulty Locations]

- 1) DMA transfer destination board
- 2) Defective DMA on FRP or memory board.

[Measures to Take]

- 1) Change the DMA transfer destination board.
- 2) Change the FRP board.
- 3) Change the memory board. (Change the RAM card or ROM card.)

[Related Specifications] DMA Error Status (at the end of this book)

★ 146 **CRP/ACP ready**

An error occurred during initialization of CRP or ACP board.

[Character-string] None

[Code]

1-> CRP or ACP board ready flag does not come ON.

[Probable Faulty Locations] Defective CRP or ACP board

[Measures to Take] Change the CRP or APC board.

★ 147 **Memory write/read test**

In the read/write test of the main memory, read data and written data do not match each other.

[Character-string] None

[Code] Address which caused the error in main memory test

[Probable Faulty Locations]

1) Faulty main memory (main board)

The code shows the address in the main board.

2) Memory-related switches are wrongly set on the main board.

[Measures to Take]

1) Check the switch settings at the main board.

2) Replace the main board, or main card 1 or 5.

★ 148 **Program load**

The loading file failed to properly load a program file.

[Character-string] None

[Code]

1-> The program file has ended before even one character is loaded.

3-> The program file has ended during loading operation.

9-> A wrong device name is designated.

10-> A wrong file name is designated.

[Probable Faulty Locations] The program file is destroyed, or a wrong loading file is used.

[Measures to Take] Reinstall the program file.

★ 149 **Not found program file**

The loading file was not able to find the program file to be loaded.

[Character-string] Program file name

[Code] 11

[Probable Faulty Locations] The file to be loaded does not exist or a wrong loading file is used.

[Measures to Take] Reinstall the program file.

★ 150 **Program load address**

There are wrong loading addresses in the program file to be loaded by the loading file.

[Character-string] Program file name

[Code]

1-> The file to be loaded is destroyed.

2-> The file to be loaded or the loading file is destroyed.

[Probable Faulty Locations] The file to be loaded or loading file is destroyed.

[Measures to Take]

- 1) Check the content of the file to be loaded.
- 2) Check the content of the loading file.
- 3) Change the control floppy disk.

**★ 151 Program attribute**

The program file to be loaded by the loading file has wrong attributes.

[Character-string] Program file name

[Code] 1

[Probable Faulty Locations] The file to be loaded is destroyed.

[Measures to Take] Check the contents of the file to be loaded.

**★ 152 Memory disk ROM write**

An error occurred in data writing onto the memory disk (FR).

[Character-string]

Start of writing The transition from read-only mode to program mode does not take place.

End of writing The transition from program mode to read-only mode does not take place.

Verify Verification proved that the data written onto the memory disk (FR) did not match the original data.

Element delete Element in the memory disk cannot be deleted.

Running task During task running, writing was attempted onto the memory disk (FR).

[Code]

1-> An error occurred in the memory board No. 1.

2-> An error occurred in the memory board No. 2.

XXXXXXXX->Address near the error location

[Probable Faulty Locations]

- 1) Defective memory disk (FR)
- 2) Defective control software (in the case of task running)

[Measures to Take]

Change the memory board or flash memory card causing the error. \* Correct the control software (in the case of task running).

**★ 153 ROM-card write prohibit**

Writing was attempted onto the ROM card (PROM card) area mounted in the memory disk.

[Character-string] None

[Code] None

[Probable Faulty Locations]

Because the FR-part-file stored in the FR control floppy disk No. 1 (file with the extension code of FRI) is defective, partitions are not properly generated.

[Measures to Take] Change the control floppy disk for FR.

**★ 154 Floppy RS232C block**

An error occurred in the UCMB's FR block that controls the floppy disk drive and RS232C.

[Code]

1: The firmware in the FR block does not respond.

2: The main processor has illegally accessed the buffer memory in the FR block.

1XX->The FR block firmware has detected an error when being initialized.

XX=

bit 7 to bit 3: 0(fixed)

bit 2: Buffer memory error  
bit 1: General-purpose register error  
bit 0: RAM error

When the error occurs, the relevant bit comes ON.  
There are cases where several bits come ON.

[Probable Faulty Locations]

1: Faulty UCMB

[Measures to Take] Change the UCMB.

★ 155 **Sector device uninitialized**

The sector device is not initialized to the OSP format.

[Character-string] Specified device name

[Probable Faulty Locations] The VID data in the memory has been destroyed.

[Measures to Take] Check the data in the sector 0(VID).

[Referential Instruction Manual] OSP File Structure

★ 200 **System file data**

Although an attempt is made to load the system software (with extension SYS) files, basic data in the file is wrong.

[Character-string] None

[Code]

- 1-> Mismatch of start address of system file
- 2-> Wrong load address of system file
- 3-> File data block 0, offset 0 is not "LOB1".

[Probable Faulty Locations]

- 1) The file management information of the device in which the system software is stored has been destroyed.
- 2) The system software has not been introduced through the correct procedure.

[Measures to Take] After examining the cause carefully, load the control software from floppy disk or tape.

★ 201 **MAB full**

It is impossible to secure the memory block.

[Character-string] None

[Code] XXXXYYYY

XXXX->Start address of the memory block

YYYY->End address of the memory block

[Probable Faulty Locations] A non-existent memory block is designated.

★ 202 **Record buffer over flow**

The read data file is larger than the specified data size.

[Character-string] None

[Code] 1

[Probable Faulty Locations] The read data file does not have the end of record.

★ 203 **Load object address**

The allocated address in the main memory for the load object file (program) exists in the system program area, the vector area or the system program variable area, or the allocated start address is greater than the allocated end address.

[Character-string] None



[Code] 1

[Probable Faulty Locations]

- 1) The contents of the first data block (DB 0) of the load object file has been destroyed.
- 2) When developing a program, area overlap has not been taken into consideration.
- 3) An attempt to load the load object file to main memory.

[Measures to Take] Check the contents of the first data block (DB 0) of the program file in question .

[Referencial Document] OSP file structure

**★ 204 Load object attribute**

Error in load object attribute of the load object file (The data block 0 and offset 0 of the file is other than "LOB1".)

[Character-string] None

[Code] 1

[Probable Faulty Locations]

- 1) Designation of contiguous file such as PBU file
- 2) Contents of file data block 0 have been destroyed.

[Measures to Take] Check the contents of the first data block (DB 0) of the program file in question .

[Referencial Document] OSP file structure

**★ 205 Load verify**

In the installation of the load object file, the data set at the main memory address does not match the source data.

[Character-string] None

[Code] Address at which mismatch has occurred

[Probable Faulty Locations]

- 1) Defective main memory
- 2) During the execution of the multi-task, another task has changed the memory contents.

[Measures to Take]

- 1) Check if the result of the main memory test conducted when power is applied is correct. The display on the operation panel must be 00.
- 2) Replace the main board and the memory card.
- 3) Load the load object file individually using the debugger utility.

**★ 206 Data block size**

Contradiction in information related with the file size in the file management information (Size of the file determined by the data block 0 is smaller than the size of the file registered in the PDB.)

[Character-string] None

[Code] 1

[Probable Faulty Locations]

- 1) Wrong manipulation of information related with file size
- 2) File management information has been destroyed.

[Measures to Take] Make the file which has caused the error.

**★ 250 Selected number**

An unspecified number was selected in the install mode.

[Character-string] None

[Code] None

[Measures to Take] Select the required number from the specified numbers.

★ 251 **No memory board**

No memory board is mounted.

[Character-string] None

[Code] None

[Probable Faulty Locations]

- 1) No memory board is mounted.
- 2) Memory board switches are wrongly set.

[Measures to Take]

- 1) Properly mount the memory board in the rack.
- 2) Check the memory board for switch setting.

★ 252 **Memory disk RAM format**

The memory disk (MD) management data cannot be correctly recognized.

[Character-string] None

[Code] None

[Probable Faulty Locations] The memory disk management data is destroyed.

[Measures to Take]

- 1) Properly connect the battery to the board.
- 2) Change the memory board.

★ 254 **Memory disk RAM write/read test**

Read/write test of the memory disk (MD) proved that the written data did not match the read data.

[Character-string] None

[Code] Data address found to be an error in the memory test of the memory disk RAM

[Probable Faulty Locations] Defective memory in the memory disk (on the memory board or RAM card)

[Measures to Take] Change the memory board or RAM card.

★ 255 **FR-part-file size**

An FR-part-file size is wrong.

[Character-string] None

[Code] FR-part-file size

[Probable Faulty Locations] An FR-part-file stored in the control floppy disk for FR is wrong in size.

[Measures to Take] Change the control floppy disk for FR.

★ 256 **FR-part-file number**

An FR-part-file number is wrong.

[Character-string] None

[Code] FR-part-file number

[Probable Faulty Locations]

- 1) An FR-part-file stored in the control floppy disk for FR has a wrong number.
- 2) An FR-part-file stored in the control floppy disk for FR is destroyed.

[Measures to Take] Change the control floppy disk for FR.

★ 257 **FR-part-file load address**

An FR-part-file was located in the memory disk (FR) with an improper address. Or, the address is larger than the last address used in the memory disk (FR).

[Character-string] None

[Code] FR-part-file loading address

[Probable Faulty Locations]

- 1) An FR-part-file stored in the control floppy disk for FR is destroyed.
- 2) An FR-part-file stored in the control floppy disk for FR has a wrong loading address.
- 3) ROM card is not properly mounted.

[Measures to Take]

- 1) Change the control floppy disk for FR.
- 2) Mount the ROM card properly.  
[Adjust the memory disk (FR) capacity.]

**★ 258     Size over**

The partition to be set exceeds the memory disk (MD) capacity in size. Or, the total size of FR-part-files exceeds the memory disk capacity.

[Character-string] Partition setting command exceeding the memory disk capacity

[Code] Memory disk capacity needed to install all the FR-part-files

[Probable Faulty Locations]

- 1) The capacity required by the data file in the control floppy disk is larger than the actual memory disk capacity.
- 2) The memory disk or RAM card capacity is short.
- 3) ROM card or RAM card is not properly mounted.

[Measures to Take]

- 1) Adjust the memory disk (MD) capacity. (Mount the RAM card properly.)
- 2) Adjust the memory disk (FR) capacity. (Mount the ROM card properly.)
- 3) Change the control floppy disk.

**★ 261     Data write verify**

Verification proved that the data written onto the memory disk did not match the original data.

[Character-string] None

[Code] Address where the mismatch occurred

[Probable Faulty Locations] Faulty memory board or ROM card

[Measures to Take] Change the memory board or ROM card.

**★ 262     Memory disk ROM erase**

The memory disk (FR) could not be erased.

[Character-string] None

[Code] Undeleted address

[Probable Faulty Locations] Faulty memory board or ROM card

[Measures to Take] Change the memory board or ROM card.

**★ 263     File header**

The installation data file or format data file has a wrong header.

[Character-string] File header

[Code] None

[Probable Faulty Locations] Wrong header in the installation data file or format data file

[Measures to Take] Change the control floppy disk.

★ 264 **Install mode program load**

The installation data file or format data file cannot be read. Or, a required file cannot be properly installed using the installation data file.

[Character-string]

Installation or format data file name

None

[Code]

1-> End of file was received without loading any character.

3-> End of file was received during loading.

9-> The device name was wrongly specified.

10-> The file name was wrongly specified.

[Probable Faulty Locations] The control floppy disk has a destroyed file.

[Measures to Take] Change the control floppy disk.

★ 265 **Control-software attribute**

The file to be installed has a wrong attribute.

[Character-string] None

[Code] None

[Probable Faulty Locations] The file to be installed is destroyed.

[Measures to Take] Change the control floppy disk.

★ 266 **Memory board configuration**

An error was detected by the circuit for diagnosing combined use of memory board and ROM card.

[Character-string] None

[Code] None

[Probable Faulty Locations] Mismatch of the memory board and the ROM card

[Measures to Take] Select a board and a card which can be used in combination.

★ 267 **Work area size**

This error message is used in the testing environment and does not normally appear.

★ 268 **Memory disk battery voltage low**

The battery voltage of the memory disk (MD) is low.

[Character-string] None

[Code] None

[Probable Faulty Locations] Memory disk (MD) battery life

[Measures to Take] Change the battery with a new one.

★ 300 **Device name**

Wrong device name is designated, or when a device name is designated after renaming it in a renaming operation, it differs from the source device name.

[Character-string] Designated device name or None

[Code]

1-> Mismatch of device name in renaming operation

None->Cases other than "code 1"

[Probable Faulty Locations]

1) Error in spelling of the input device name

- 2) Designation of device name whose use is not allowed
- 3) Designation of device name differing from the source device name (RENAME command)

[Measures to Take]

- 1) Refer to the operation manual.
- 2) In the RENAME operation, designation of device name for the changed name is not required.

**★ 301 Sector device name**

As the sector device name, one of the parameters to be transferred to the sector device driver routine, any device name other than MD1, MD0, FR1, FR0, BB1, FD0, FD1, FD2 and FD3 is designated.

[Character-string] Designated device name

[Code]

FFFFFFFF-> No area is allocated to the specified device (size: 0).  
None->An invalid sector device name is specified.

[Probable Faulty Locations]

- 1) Data on the sector device name has been destroyed.
- 2) The partition map for memory disk has been destroyed.
- 3) An invalid sector device name is specified.

[Measures to Take]

- 1) Check the user memory data in the VID of memory disk.
- 2) Specify a correct sector device name.

**★ 302 Print device name**

A device name not allowed as a print device name is designated in one of parameters to be transferred to printer driver routine.

[Character-string] Designated device name

[Code] None

[Probable Faulty Locations] Contents of print device name variable PPRDV4 have been destroyed.

**★ 303 Reader device name**

A device name not allowed as a tape reader device name is designated in one of parameters to be transferred to tape reader driver routine.

[Character-string] Designated device name

[Code] None

[Probable Faulty Locations] Contents of tape reader device name variable PTRDV4 have been destroyed.

**★ 304 Puncher device name**

A device name not allowed as a punch device name is designated in one of parameters to be transferred to punch driver routine.

[Character-string] Designated device name

[Code] None

[Probable Faulty Locations] Contents of punch device name variable PTRDV4 have been destroyed.

**★ 305 File name**

Characters "\*" and "?" are used for a command not used as a file name.

Either or both the file name and the extension are omitted in the setting of default file name for the USE command.

[Character-string] Designated file name

[Code] None

[Probable Faulty Locations]

- 1) In the file name designation step (except default), characters "\*" and "?" have been used.
- 2) File name and/or extension has been omitted in setting the default file name for the USE command.

[Measures to Take] Refer to the instructions for individual commands.

**★ 306 Command character**

A command that is not in the command table has been designated.

[Character-string] Command characters which have been input

[Code] None

[Probable Faulty Locations]

- 1) Spelling error of a command
- 2) Input of a command not allowed in the mode currently selected

[Measures to Take] Input the command using function keys.

**★ 307 Command syntax**

Grammatical error in the command operand when the SBP monitor is used.

Warning: The SBP monitor should not be used by users.

[Character-string] Programmed Command

[Code]

- 1-> Incorrect data size
- 2-> Memory verify error
- 3-> Wrong delimiter code
- 4-> Address of an odd number designated for other than byte

[Probable Faulty Locations]

- 1) Grammatical error in the command input through the keyboard (code 1, 3)
- 2) An attempt is made to write to a read-only I/O address (code 2).
- 3) An odd number address is designated to access the word size or long word size (code 4).

[Measures to Take] Input the correct command through the keyboard.

**★ 308 Option**

Wrong option characters have been designated.

[Character-string] None

[Probable Faulty Locations] An option not usable with the command designated has been designated.

[Measures to Take] Refer to the instructions for individual commands.

**★ 309 RS232C channel in use**

An attempt to use an RS232C channel that is being used.

[Character-string] None

[Code] 1

[Probable Faulty Locations]

During multi-task execution, an attempt is made to use an RS232C channel which is being used by another task.

**★ 310 File attribute**

An attempt is made to read a file other than a sequential file or contiguous file, or an attempt is made to read contiguous file using the sequential file read processing, or to read sequential file using the contiguous file reading processing.

[Character-string] None

[Code] Attribute code of the file to be read

- 1-> Read out is impossible because the file is a contiguous file.

2-> Read out is impossible because the file is a sequential file.

Others-> Unknown file

[Probable Faulty Locations]

- 1) The file management information of the device used to read has been destroyed.
- 2) Mismatch between the extension and attribute code of the file stored in the floppy disk.

[Measures to Take]

- 1) If the file management information of the device has been destroyed, initialize the device.
- 2) If the alarm occurs during the loading of the control software floppy disk, write the control software to floppy disk again.

**★ 311 SAT full**

Available storage area of the device designated is smaller than the required number of sectors.

[Character-string] None

[Code] Necessary number of remaining sectors

[Probable Faulty Locations]

- 1) Available area is not sufficient.
- 2) SAT sector information of the device has been destroyed.

[Measures to Take]

- 1) Delete unnecessary files.
- 2) Check the available area size with the FREE command.
- 3) Subtract the sizes of files registered from the device memory capacity and compare it with the data displayed for FREE command.

**★ 312 Floppy uninitialized**

The floppy disk is not initialized in the OSP format.

[Character-string] None

[Code] None

[Probable Faulty Locations]

- 1) Floppy disk or memory formatted to another format (EXORMACS, IBM, etc.)
- 2) Contents of VID of floppy disk or memory have been destroyed.

[Measures to Take]

- 1) To use an IBM format floppy disk, change the setting.
- 2) Check the contents at sector 0 (VID).
- 3) Usually, new floppy disks are formatted to IBM format. Therefore, initialize the disk to the OSP format using the INIT command.

**★ 313 File label area over flow**

There is no area for registering the file label on the IBM-formatted floppy disk.

[Character-string] None

[Code] None

[Probable Faulty Locations] File area of the IBM-formatted floppy disk is full.

[Measures to Take]

- 1) Delete unnecessary files using DEL command.
- 2) Check the number of files registered using the DIR command.
  - 45 files for FD2-128
  - 71 files for FD2-256D
  - 19 files for FD1-128

**★ 314 Error-map information**

Wrong sector identification name for error map information (containing faulty track information) of the IBM-formatted floppy disk

[Character-string] None

[Code]

0-> Wrong sector identification name

1-> Wrong data of faulty track

[Probable Faulty Locations] Error map information sector has been destroyed.

[Measures to Take] Check the contents of the error map sector.

**★ 315 Volume-label information**

Wrong volume label information\* on the IBM-formatted floppy disk

\* Equivalent VID of OSP-formatted floppy disk

[Character-string] None

[Code] None

[Probable Faulty Locations] Volume label information sector has been destroyed.

[Measures to Take] Check the contents of the volume label sector.

**★ 316 File regist**

In the file directory information of the IBM-formatted floppy disk, sector address data of the data block indicates "0" cylinder.

[Character-string] None

[Code] None

[Probable Faulty Locations]

1) File directory sector has been destroyed.

2) In file registration process, the data block sector information indicates "0" cylinder.

[Measures to Take] Check the contents of the file directory.

**★ 317 Multi volume information**

In the registration of the file directory information to the IBM-formatted floppy disk, a symbol not allowable as the multi-volume identifier is used or the volume order number is outside 0 - 99.

[Character-string] None

[Code]

1-> Multi-volume identifier is other than "SP", "C" and "L".

2-> Multi-volume order number is outside 0 - 99.

[Probable Faulty Locations] File directory data in the main memory has been destroyed.

**★ 318 SVCL**

The NC control software issued an undefined system call (SVCL).

[Character-string] None

[Code] Address near the wrongly called address

[Probable Faulty Locations] Wrong control software is used.

[Measures to Take] Check and change the control software.

**★ 319 RS232C device read**

The DR signal, which indicates that the device connected is ready, has been turned off during data reading operation through the RS232C interface.

[Character-string] None



[Code] Contents of RS232C interface status

Bit 0-> DR signal ON/OFF status

[Probable Faulty Locations]

- 1) Defective device
- 2) Defective communication cables
- 3) Connection specification is not proper.

[Measures to Take]

- 1) Check the wiring diagram.
- 2) Check the continuity test using a multimeter.
- 3) Check the signal operation specification of the device connected.

**★ 320 RS232C terminal not ready**

The DR signal, which indicates that the device connected is ready, is not turned on.

[Character-string] Error has occurred at

input . . . . . input

output . . . . . output

print . . . . . printer output

[Code] Contents of RS232C interface status

Bit 0-> DR signal ON/OFF status

[Probable Faulty Locations]

- 1) The device is not in the ready state.
- 2) Defective communication cables
- 3) Connection specification is not proper.
- 4) Improper setting at check timer

[Measures to Take]

- 1) Check to be sure that the device is on-line.
- 2) Check the wiring diagram.
- 3) Check the continuity test using a multimeter.
- 4) Check the signal operation specification of the device connected.

**★ 321 RS232C ready status time out**

Signals and status of the device connected through the RS232C interface are not ready.

During input (read operation):

RXRDY of RS232C USART status is not turned on (no data transmitted from the device connected).

During output (punch operation), during print out:

TXEMP and TXRDY of RS232C USART status are not turned on.

CS signal of RS232C interface status is not ON. In case the communication parameter is set at "READY YES", the CI signal is not ON.

[Character-string] Error has occurred at

input . . . . . input

output . . . . . output

print . . . . . printer output

[Code] FFFFFFFF

[Probable Faulty Locations]

- 1) Device connected is not in the ready state or is defective.
- 2) Improper communication parameter setting
- 3) Defective communication cables
- 4) Improper setting at check timer

- 5) Improper wiring specification

[Measures to Take]

- 1) Check the wiring diagram.
- 2) Check the continuity test using a multimeter.
- 3) Check the signal operation specification of the device connected.
- 4) Check the communication parameter settings.

★ 322 **RS232C ready interrupt time out**

The interruption of the RS232C device by transmit/receive processing does not occur within the time specified for individual channels.

[Character-string] Error has occurred at

input . . . . . input  
output . . . . . output

[Code] FFFFFFFF

[Probable Faulty Locations]

- 1) During inputNo data transmission from the device connected
- 2) Defective communication cables
- 3) Improper wiring specification
- 4) Improper setting at check timer
- 5) Improper communication parameter setting

[Measures to Take]

- 1) Check the wiring diagram.
- 2) Check the continuity test using a multimeter.
- 3) Check the signal operation specification of the device connected.
- 4) Check the communication parameter settings.

★ 323 **RS232C device name**

A channel device name other than CN0, CN1, CN2 or CN3, has been designated at one of parameters which are transferred to the RS232C communication control signal driver routine.

[Character-string] None

[Code] None

[Probable Faulty Locations] Designation of a device other than RS232C device

★ 324 **Memory disk access sector over**

Reading from or writing to the memory disk (MD) is attempted exceeding the capacity of the largest sector.

[Character-string] None

[Code]

XXXX->Sector number

[Probable Faulty Locations]

The file control data in the memory disk is destroyed.  
The data file of the control floppy is not suitable for the actual memory disk capacity.

[Measures to Take]

Check the file control data for defects.  
Reinstall the suitable control data file.

★ 325 **Memory disk ROM access sector over**

Reading from or writing to the memory disk (FR) is attempted exceeding the capacity of the largest sector.

[Character-string] None

[Code]

XXXX->Sector number

[Probable Faulty Locations]

The file control data in the memory disk is destroyed.

The data file of the control floppy is not suitable for the actual memory disk capacity.

[Measures to Take]

Check the file control data for defects.

Reinstall the suitable control data file.

★ 326 **DMA transfer sector over**

A numerical value 0 or 9 or larger is designated as the number of sectors for a single access operation at one of parameters to be transferred to the bubble memory or floppy disk drive driver routine.

[Character-string] None

[Code] The number of sectors designated

[Probable Faulty Locations] The number of sectors has not been set at the parameter.

★ 328 **Memory disk format**

The memory disk (MD) management data cannot be correctly recognized.

[Character-string] None

[Code] None

[Probable Faulty Locations] The memory disk management data is destroyed.

[Measures to Take]

1) Properly connect the battery to the board.

2) Change the memory board.

★ 329 **Memory disk ROM setup**

An error has occurred in the circuit for diagnosing the combination of the memory board and ROM card.

[Character-string] None

[Code] None

[Probable Faulty Locations] The memory board and ROM card are used in wrong combination.

[Measures to Take] Prepare a correct combination.

★ 330 **Floppy disc read/write**

Read/write operation using floppy disk has not been completed correctly.

[Character-string] None

[Code] XXXXXYY

XXXXXX-> Contents of result status 0, 1, 2, of floppy disk drive.

YY:

05 or 45 . . . Error in writing

05: Side 0

45: Side 1

06 or 46 . . . Error in reading

06: Side 0

46: Side 1

[Probable Faulty Locations]

- 1) Defective floppy disk
- 2) Defective floppy disk drive
- 3) The write-protect switch (PROTECT) on the floppy disk is set to write-protect.

[Measures to Take]

- 1) Read and check all the sectors.
- 2) Try again using other floppy disk.
- 3) Try again using the floppy disk causing the error at another floppy disk drive.
- 4) In case the data on the floppy disk may be deleted, initialize the floppy disk then try read/write operation again.

[References] FDC Result Status (end of this book)

**★ 331 Floppy disc access sector over**

A value greater than the actual floppy disk capacity is designated for the access sector using the parameter to be transferred to the floppy disk drive routine.

[Character-string] None

[Code] Accessed sector number

[Probable Faulty Locations]

- 1) Type of floppy disk
- 2) VID and SDB contents of the floppy disk have been destroyed.
- 3) File directory contents have been destroyed.
- 4) Pointer data which indicates the connection of the sequential file data block has been destroyed.

[Measures to Take]

- 1) Display the sequential file list.
- 2) Check the contents of VID, SDB and directory.

[References] OSP File Structure

**★ 332 Floppy disc write verify**

Data mismatch is discovered when the data written into bubble memory is verified against source data.

[Character-string] None

[Code] Physical sector number at which error has occurred

[Probable Faulty Locations]

- 1) Defective floppy disk or floppy disk drive
- 2) Defective main board or DMA
- 3) During execution of multi-task, contents of the main memory being accessed by another task have been changed.

[Measures to Take]

- 1) Try again using another floppy disk.
- 2) Try again using the floppy disk causing the error at another floppy disk drive.
- 3) Replace the main board.

**★ 333 Floppy disc seek**

Error during seek operation for the floppy disk  
("Seek" means the operation to move the FDD head to the designated track position.)

[Character-string] None

[Code] XXYY

- XX-> Contents of result status 0 of floppy disk drive  
YY-> Cylinder number

[Probable Faulty Locations]

- 1) Defective floppy disk
- 2) Defective floppy disk drive

[Measures to Take]

- 1) Try again using another floppy disk.
- 2) Try again using the floppy disk causing the error at another floppy disk drive.

[References] FDC Result Status (end of this book)

**★ 334 Floppy disc recalibrate**

Error during floppy disk recalibration  
("Recalibration" means the operation to move the FDD head to the track number 0 position.)

[Character-string] None

[Code]

XXXX->Contents of result status 0, 1 of floppy disk drive.

[Probable Faulty Locations]

- 1) Defective floppy disk
- 2) Defective floppy disk drive

[Measures to Take]

- 1) Try again using another floppy disk.
- 2) Try again using the floppy disk causing the error at another floppy disk drive.

[References] FDC Result Status (end of this book)

**★ 335 Floppy disc formatting**

Error during floppy disk formatting

[Character-string] None

[Code]

XXXXXXXX->Contents of result status 0, 1, 2, 3 of floppy disk drive

[Probable Faulty Locations]

- 1) Defective floppy disk
- 2) Defective floppy disk drive
- 3) Wrong designation of floppy disk type

[Measures to Take] Avoid reformatting of floppy disks.

[References] FDC Result Status (end of this book)

**★ 336 Floppy disc time out**

The floppy disk operation completion status (service request: SRQ) has not been changed to the completed status within 10 seconds.

[Character-string] None

[Code]

- 1-> During read/write processing
- 2-> During formatting

[Probable Faulty Locations] Defective floppy disk drive

**★ 337 Floppy ready**

The floppy disk drive is not ready.

[Character-string] None

[Code] None

[Probable Faulty Locations]

- 1) Floppy disk is not set correctly in the floppy disk drive.
- 2) Floppy disk drive door is open.

[Measures to Take] Check the illumination of the ready lamp at the front of the floppy disk drive.

**★ 338 Floppy disk write protect**

Writing onto the floppy disk is impossible.

[Character-string] None

[Code] None

[Probable Faulty Locations] The floppy disk is write-protected.

[Measures to Take] Change the disk to write-enabled (by handling the protect notch on the disk.)

**★ 339 PTR read**

Error in tape reading through the tape reader

[Character-string] None

[Code] PTR error status

Bit 1 ON-> Asynchronization error

[Probable Faulty Locations]

- 1) Tape roll size is too large causing a problem in tape feed by the PTR.
- 2) Defective PTR

[Measures to Take] Reduce the tape size.

**★ 340 PTR erratic operation detect**

Asynchronization error with the PTR

[Character-string] None

[Code] PTR status

Bit 1 ON-> Asynchronization error

[Probable Faulty Locations]

- 1) Tape roll size is too large causing a problem in tape feed by the PTR.
- 2) Previous error has not been reset.

[Measures to Take]

- 1) Press the PTR error reset button.
- 2) Reduce the tape size.

**★ 341 PTR ready status time out**

The ready status of the PTR is not turned on within one second.

[Character-string] None

[Code] FFFFFFFF

[Probable Faulty Locations]

- 1) The paper tape set lever of PTR is not in position.
- 2) Defective PTR

[Measures to Take] Make sure that the paper tape set lever of PTR is in position.\

★ 342 **PTR ready interrupt time out**

PTR ready interruption does not occur within ten seconds.

[Character-string] None

[Code] FFFFFFFF

[Probable Faulty Locations] Defective PTR

★ 343 **DMA transfer**

An error has occurred during DMA transfer, or DMA operation has not been completed.

[Character-string]

Floppy An error occurred in the DMA on the FRP board.

Memory disk An error occurred in the DMA on the memory board.

[Code]

XXXX->Indicates the error status of DMA.

[Probable Faulty Locations]

- 1) DMA transfer destination board
- 2) Defective DMA on FRP or memory board.

[Measures to Take]

- 1) Change the DMA transfer destination board.
- 2) Change the FRP board.
- 3) Change the memory board. (Change the RAM card or ROM card.)

[Related Specifications] DMA Error Status (at the end of this book)

★ 344 **Printer**

The printer is placed in the error state, or it is not set in the ready state within a preset cycle time.

[Character-string] None

[Code] Printer status

Bit 0 ON-> Printer ready (RDY)

Bit 2 ON-> Printer busy (BUSY)

Bit 3 ON-> Paper out (PE)

Bit 4 ON-> Printer in ON-LINE mode (SEL)

Bit 5 ON-> Video signal OFF (LD)

Bit 6 ON-> Printer in error state (FLT)

Bit 7 ON-> Interruption to main CPU (INT)

FFFFFFF-> The printer is not ready within a preset time.

[Probable Faulty Locations]

- 1) Paper out
- 2) Printer is not in the ON-LINE mode.
- 3) Improper setting at ready check timer
- 4) Printer cable is not connected.

[Measures to Take]

- 1) Correct the ready check timer setting.
- 2) Check the printer status.
- 3) Check the printer cable connection.

★ 345 **Puncher**

The punch is not ready or error with the punch.

[Character-string] None

[Code]

FFFFFFFF-> Punch is not ready after the designated time.

Others-> Punch status

Bit 1 ON-> Remaining tape volume low

Bit 2 ON-> Tape cut off or too tight

[Probable Faulty Locations]

- 1) Remaining tape volume is low.
- 2) Tape is cut off or tape tension is too high and tape punching is impossible.
- 3) Improper setting at ready check timer

[Measures to Take]

- 1) Replace paper tape roll, or reset it.
- 2) Correct timer setting.

★ 346 **CRP/ACP ready**

An error occurred during initialization of CRP or ACP board.

[Character-string] None

[Code]

1-> CRP or ACP board ready flag does not come ON.

[Probable Faulty Locations] Defective CRP or ACP board

[Measures to Take] Change the CRP or APC board.

★ 347 **Memory write/read test**

In the read/write test of the main memory, read data and written data do not match each other.

[Character-string] None

[Code] Address which caused the error in main memory test

[Probable Faulty Locations] Defective main memory (main board, main card 1 or 5)

Code 0 - 7FFFF Main board

Others Main card 1 or 5

[Measures to Take]

- 1) Check the switch settings at the main board.
- 2) Replace the main board, or main card 1 or 5.

★ 348 **Program load**

The loading file failed to properly load a program file.

[Character-string] None

[Code]

1-> The program file has ended before even one character is loaded.

3-> The program file has ended during loading operation.

9-> A wrong device name is designated.

10-> A wrong file name is designated.

[Probable Faulty Locations] The program file is destroyed, or a wrong loading file is used.

[Measures to Take] Reinstall the program file.



★ 349 **Not found program file**

The loading file was not able to find the program file to be loaded.

[Character-string] Program file name

[Code] 11

[Probable Faulty Locations] The file to be loaded does not exist or a wrong loading file is used.

[Measures to Take] Reinstall the program file.

★ 350 **Program load address**

There are wrong loading addresses in the program file to be loaded by the loading file.

[Character-string] Program file name

[Code]

1-> The file to be loaded is destroyed.

2-> The file to be loaded or the loading file is destroyed.

[Probable Faulty Locations] The file to be loaded or loading file is destroyed.

[Measures to Take]

1) Check the content of the file to be loaded.

2) Check the content of the loading file.

3) Change the control floppy disk.

★ 351 **Program attribute**

The program file to be loaded by the loading file has wrong attributes.

[Character-string] Program file name

[Code] 1

[Probable Faulty Locations] The file to be loaded is destroyed.

[Measures to Take] Check the contents of the file to be loaded.

★ 352 **Memory disk ROM write**

An error occurred in data writing onto the memory disk (FR).

[Character-string]

Start of writing The transition from read-only mode to program mode does not take place.

End of writing The transition from program mode to read-only mode does not take place.

Verify Verification proved that the data written onto the memory disk (FR) did not match the original data.

Element delete Element in the memory disk cannot be deleted.

Running task During task running, writing was attempted onto the memory disk (FR).

[Code]

1-> An error occurred in the memory board No. 1.

2-> An error occurred in the memory board No. 2.

XXXXXXXX->Address near the error location

[Probable Faulty Locations]

1) Defective memory disk (FR)

2) Defective control software (in the case of task running)

[Measures to Take]

Change the memory board or flash memory card causing the error. \* Correct the control software (in the case of task running).

★ 353 **ROM-card write prohibit**

Writing was attempted onto the ROM card (PROM card) area mounted in the memory disk.

[Character-string] None

[Code] None

[Probable Faulty Locations]

Because the FR-part-file stored in the FR control floppy disk No. 1 (file with the extension code of FRI) is defective, partitions are not properly generated.

[Measures to Take] Change the control floppy disk for FR.

★ 354 **Floppy RS232C block**

An error occurred in the UCMB's FR block that controls the floppy disk drive and RS232C.

[Code]

1-> The firmware in the FR block dose not respond.

2-> The main processor has illegally accessed the buffer memory in the FR block.

1XX-> The FR block firmware has detected an error

XX=

bit 7 to bit 3: 0(fixed)

bit 2: Buffer memory error

bit 1: General-purpose register error

bit 0: RAM error

When the error occurs,the relevant bit comes ON.

There are cases where several bits come ON.

[Probable Faulty Locations]

1: Faulty UCMB

[Measures to Take] Change the UCMB.

★ 355 **Sector device uninitialized**

The sector device is not initialized to the OSP format.

[Character-string] Specified device name

[Probable Faulty Locations] The VID data in the memory has been destroyed.

[Measures to Take] Check the data in the sector 0(VID)

[Referential Instruction Manual] OSP File Structure

★ 400 **Not found utility command file**

The utility file or program file designated is not found in the designated device.

[Character-string] Designated utility name

[Code] None

[Probable Faulty Locations]

1) Error in designating the device name

2) Spelling error in utility file name

3) The utility is not actually registered.

[Measures to Take] Check the files in the designated device using the DIR command.

★ 401 **Load object address**

The allocate address in the main memory for the load object file (program) exists in the system program area, the vector area or the system program variable area, or the allocated start address is greater than the allocated end address.

[Character-string] None

[Code] 1

[Probable Faulty Locations]

- 1) The contents of the first data block (DB 0) of the load object file has been destroyed.
- 2) When developing a program, area overlap has not been taken into consideration.
- 3) An attempt to load the load object file to main memory.

[Measures to Take] Check the contents of the first data block (DB 0) of the program file in question .

[Referencial Document] OSP file structure

**★ 402 Load object attribute**

Error in load object attribute of the load object file (The data block 0 and offset 0 of the file is other than "LOB1".)

[Character-string] None

[Code] 1

[Probable Faulty Locations]

- 1) Designation of contiguous file such as PBU file
- 2) Contents of file data block 0 have been destroyed.

[Measures to Take] Check the contents of the first data block (DB 0) of the program file in question.

[Referencial Document] OSP file structure

**★ 403 Data block size**

In the load object file, the number of sectors of the data block which is indicated by the file directory is smaller than "the number of sectors+1" of the data block which is to be loaded to the memory which is indicated at data block 0 of the file.

[Character-string] None

[Code] 1

[Probable Faulty Locations]

- 1) File directory information or the contents at data block 0 (DB0) of the load object file have been destroyed.
- 2) During multi-task processing, contents of the file management variable have been changed through file processing by another task.

[Measures to Take] Check the file directory information and the contents at DB0.

[References] OSP File Structure

**★ 404 Initialize device name**

Device name "MD0","FR0" or"FR1" is designated, which must not be designated with the initialize commands, INIT or IN.

[Character-string] "MD0","FR0" or "FR1"

[Code] None

[Probable Faulty Locations]

Designation of device MD0: for which initialization using the initialization command is not allowed FR0: or FR1: which cannot be initialized by the initialization command.

[Measures to Take]

Initialization of MD0:, FR0: and FR1: using the initialization command is not possible.

**★ 405 Floppy disc initialize**

For initialization, the floppy disk type is other than FD2-128, FD2-256, FD2-256D, FD1-128.

[Character-string] None

[Code] None

[Probable Faulty Locations]

- 1) Floppy disk format information is other than OSP and IBM.
- 2) Record length of the floppy disk in question is 512 or 1,024 bytes.
- 3) VID or volume label information has been destroyed.

[Measures to Take]

- 1) Determine forcibly using the F option of the INIT command.
- 2) Do not use floppy disk whose record length is 512 or 1,024 bytes.

**★ 406 Patch sector area**

The sector designated by patch does not exist.

[Character-string] None

[Code] 1

[Probable Faulty Locations]

- 1) In the designation of the correction sector number of the PATCH command, a value greater than the number of data blocks (sectors) has been input.
- 2) A decimal number has been designated for the data to be designated by a hexadecimal number.
- 3) In the designation of a device, a value greater than the capacity of that device has been designated.

[Measures to Take] Check the number of sectors of the file using the DIR command.

**★ 407 Patch sector address over**

The address within the sector specified by patch is outside 0 through \$FF.

[Character-string] Contents of input data for addresses exceeding the allowable range.

[Code]

- 1-> Input of the correction data is too much and the addresses for the correction exceeds "\$FF".
- 2-> When correcting the data to the identical data continuously, designation of the last address is made with a number greater than 100 (hexadecimal).

[Probable Faulty Locations]

- 1) The number of input data sets is too large.
- 2) Error in address designation

[Measures to Take]

In either cases of the error indicated above, memory correction up to address \$FF has been completed. Therefore, if the processing is terminated using the Q command to check the contents, contents of the device or the file are updated accordingly. To quit without updating the contents, do so with ABORT CONTROL C.

**★ 408 Console line setting**

In setting the console line range for the CRT display using the USE command, the beginning and the end of the console line numbers are outside 0 - 23, or the beginning line number is greater than the end line number.

[Character-string] None

[Code] None

[Probable Faulty Locations]

An attempt to change the beginning or the end line without checking the default values.

[Measures to Take]

Default: Beginning line . . . . 18  
End line . . . . . 21

**★ 409 File write protect**

An attempt to release the protect state of the file which is protected by the protect command

[Character-string] None

[Code] Protect level

[Probable Faulty Locations]

- 1) An attempt to release the protect state of the system program file
- 2) An attempt to release the protect state of the control program file
- 3) An attempt to release the protect state of the PBU file
- 4) An attempt to release the protect state of the MSB file

[Measures to Take]

- 1) The protect state of the system program cannot be released.
- 2) For other files in BB0:, select the OS mode to release the protect state.

**★ 410 System program registration**

A wrong file is designated by the system program registration (SG) command.

[Character-string] None

[Code]

- 2-> A sequential file is specified.
- 3-> The specified file contains wrong load object attributes.
- 4-> The program start address of the specified file is 0.
- 5-> The specified sector device is a floppy disk of IBM format.

[Probable Faulty Locations] A wrong file is specified.

[Measures to Take] Designate the correct file.

**★ 5000 MS-DOS**

An error has occurred in data conversion into MS-DOS formatted file.

[Character-string] None

[Code]

- 1-> The designated command character (function) is not supported.
- 2-> Command syntax error
- 3-> The MS-DOS file name is designated in a wrong format.
- 4-> The device is not designated or its format is wrong.
- 5-> The designated path is not found.
- 6-> The OSP file name is wrong.
- 7-> The output file has not been designated or designated using a wild card; \* or ?.
- 8-> The option code is wrongly specified.
- 9-> The MS-DOS formatted file is not used.
- A-> The output file is a system file or a cache file.
- B-> Copying from OSP to OSP or from MS-DOS to MS-DOS was attempted.
- C-> It is impossible to open the file.
- D-> The file is full.
- E-> The file name contains an illegal character.

[Measures to Take] Check the floppy disk and the command format.

★ 5001 **Undefined IGF data**

IGF-M data is not notified when IGF-M function key is pressed.

[Measures to Take]

- Check if the PLC sends the IGF-M data to the NC through the NC parameter window when the power is supplied.

★ 5003 **DNC-T ERROR error-code**

[Code]

- 1-> The specified command character (function) does not exist.
- 2-> Command syntax error
- 3-> The file name specified by the host has a wrong format or the host file name with output file name omitted does not comply with the OSP file name format.
- 4-> No device is specified or the specified device name has a wrong format.
- 5-> The specified bus does not exist.
- 6-> The OSP file name does not comply with the OSP file name format.
- 7-> No output file is specified or the output file name contains `\*` or `?`.
- 8-> Option is specified in a wrong manner.
- B-> The system attempted to copy data from OSP to OSP or from host to host.
- E-> The file name contains a prohibited character or the input file name is not specified after the pass name.
- 101-> The communication parameter file contains a wrong setting (wrong variable name appears).
- 102-> Communication error (\*)
- 103-> Faulty communication device. The specified communication channel not installed. (\*)

[Code] to be added in the cases marked with \*

Format [5003 DNC-T error 102 `XX,YY,ZZZ]

XX: Module number where the error occurred (decimal)

YY, ZZZ: Error cause numbers (decimal)

- 1-> Communication device start-up
- 2-> Communication device shut-down
- 3-> Opening of file
- 4-> Closing of file
- 5-> Reading from stream
- 6-> Writing in stream
- 7-> Relocation of file pointer
- 8-> File termination check
- 9-> File error check
- 10-> File error reset
- 11-> Opening of directory
- 12-> Closing of directory
- 13-> Reading of directory information
- 14-> Relocation of directory pointer
- 15-> Acquirement of current position of directory pointer
- 16-> Deletion of file
- 17-> Change of file name
- 18-> Acquirement of empty space in device
- 19-> Execution of command
- 20-> Acquirement of communication parameters by item
- 21-> Acquirement of device sector size
- 22-> Acquirement of file information
- 23-> Acquirement of OSP file attributes

- 24-> Change of protection status
- 25-> Setting of host file attributes
- 32-> Setting of OSP file attributes
- 33-> Initialization of hardware disk
- 36-> Acquirement of file system format
- Error cause (ZZZ is not fixed if not YY = 255)
- YY=
  - 2-> Device, directory, or file does not exist.
  - 4-> No empty space in disk or disk error
  - 8-> Cannot be executed.
  - 9-> Communication parameter file read error
  - 13-> Communication parameter file write error
  - 14-> Port not mounted
  - 17-> File or directly already exists or file name is wrong.
  - 19-> Wrong device name
  - 22-> Wrong communication parameter value
  - FF-> Communication error
- ZZZZ=
  - 111-> Small buffer size in TCP/IP driver
  - 114-> Faulty descriptor transferred to TCP/IP driver
  - 115-> Faulty parameter transferred to TCP/IP driver
  - 116-> No empty port in the shared memory
  - 117-> Unconnected
  - 123-> Abort command ignored
  - 125-> `ftp open' abnormal termination
  - 126-> `ftp close' abnormal termination
  - 127-> `ftp type' abnormal termination
  - 128-> `ftp user' abnormal termination
  - 129-> `ftp pass' abnormal termination
  - 130-> `ftp acct' abnormal termination
  - 131-> `ftp delete' abnormal termination
  - 132-> `ftp fopen' abnormal termination
  - 133-> `ftp fopen uni' abnormal termination
  - 134-> `ftp net drecv f' abnormal termination
  - 135-> `ftp net dsend f' abnormal termination
  - 136-> `ftp fclose' abnormal termination
  - 137-> `ftp abort' abnormal termination
  - 138-> `ftp chdir' abnormal termination
  - 141-> `ftp pwd' abnormal termination
  - 143-> `ftp dopen' abnormal termination
  - 144-> `ftp dread' abnormal termination
  - 145-> `ftp dclose' abnormal termination
  - 151-> IP address error
  - 152-> No IP address
  - 153-> Interruption due to time-out
  - 154-> Disconnection command from the remote host
  - 155-> Abnormally terminated initialization of OS (MORE) on TCP/IP board
  - 156-> Abnormally terminated initialization of packet driver or TCP/IP module on TCP/IP board
  - 159-> Abnormally terminated initialization of FTP module on TCP/IP board

160-> Abnormally terminated initialization of socket interface module on TCP/IP board  
161-> Abnormally terminated initialization of TCP/IP board  
(Other error than 155 to 160 above)

**★ 5200 Main program executing**

An attempt to select a program during the execution of a main program.

[Index] None

[Character-string] None

[Code]

- 1-> An attempt to select a program
- 2-> An attempt to select a schedule program
- 3-> An attempt to execute sequence number search
- 4-> An attempt to execute restart
- 5-> An attempt to search a schedule program
- 6-> An attempt to select high-speed graphic drawing mode

[Measures to Take] Select the program after resetting the NC.

**★ 5201 No main program file**

Main program file to be designated is not found.

[Character-string] None

[Code]

- 1-> Main program file is not found.

[Measures to Take]

- 1) Designate a main program file correctly.
- 2) Create a file if there is no file.

**★ 5202 No main program name**

Main program name to be loaded is not found.

[Character-string] None

[Code]

- 1-> Main program name is not found.

[Measures to Take]

- 1) Designate a main program name correctly.
- 2) Create a file if there is no file.

**★ 5203 Tape TV check**

The TV check for one block of read tape proved that the number of data in the block was odd.

[Character-string]

32 characters preceding the character which caused the TV check error

[Code]

XX-> Data which has caused tape TV check error

[Measures to Take] Check the tape.

**★ 5204 No tape data**

No data is punched on the tape when reading or verifying is attempted.

The tape end code (NULL or %) has been ready before the first CR or LF is read.

[Character-string] None

[Code] None



[Measures to Take] Read the tape correctly.

**★ 5205 Tape parity**

Tape parity unconformity (ISO ... even parity, EIA ... odd parity)

[Character-string]

32 characters preceding the character which caused the parity error

[Code]

XX-> Data which caused the parity error

[Measures to Take]

Because the data which causes the error is contained in the tape, correct the wrong data.

If this error occurs during tape reading, designate option C which allows the error causing code to be read as an "!" code, and edit the "!" code after reading.

Example: >R\_A.MIN;C <WRITE>

**★ 5206 Tape file name**

Wrong tape file name - illegal characters used, too many characters, etc.

If a character-string appears, it indicates the specified file name.

[Code]

5-> The number of characters in a file name is more than 19.

6-> A delimiter other than a period "." was used between the file name and extension.

7-> The first character of the file name and extension is other than alphabet.

[Measures to Take]

Run the tape with a normal file name so that the NC reads the program.

Or, check if the number of files registered in multi-read or verify mode is not "0".

If no character-string appears, the code and the measures are as follows:

[Code] The number of received mismatch files (in hexadecimal)

[Measures to Take] The input file name is wrong. Specify a normal file name.

**★ 5207 Tape read verify**

Mismatch between taped information and file information

[Character-string] None

[Code] XXYY

XX-> Information of the memory location at which the verify error has occurred.

YY-> Information on the tape block at which the verify error has occurred.

[Measures to Take] Check the tape and read it again.

**★ 5208 Input/output file name not same**

Wrong input/output designation for copying the data. The error occurs in the file designation other than the cases specified below.

(1) With the same device

a) Output file name is designated while the input file name is missing \* and ? symbols, and the output file name and input file name do not match.

(2) With different device

a) Symbols \* and ? are not used in input file name.

b) In A option designation, symbols \* and ? are used in input file name with output file name designated.

c) In A option designation, symbols \* and ? are used in input file name without output file name designated.

[Character-string] None

[Code] None

[Measures to Take] Conduct the copy operation correctly.

★ 5209 **Input data overflow**

Input data size is too large or too small.

[Character-string] None

[Code] Allowable maximum or minimum value for the data

Floating error status

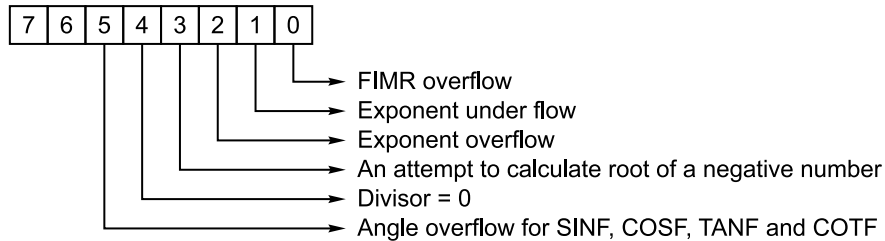

[Measures to Take] Specify the correct data.

★ 5210 **Input file name not same**

Mismatch between the input file name designated with the read or verify command and the file name on the tape.

[Character-string] Tape file name

[Code] None

[Measures to Take] Input the correct file name.

★ 5211 **No subprogram**

(3) A subprogram name is not found in the subprogram file when program selection is executed.

(4) A program name is not found for library program deletion operation.

[Character-string] Subprogram name not found

[Code]

1-> Subprogram name is not found.

[Measures to Take] Make the necessary subprogram.

★ 5212 **Subprogram name**

A subprogram name in the main program is not found or is found to be incorrect when program selection is executed.

[Character-string]

Error code 1 or 2-> Record buffer where subprogram is called

Error code 3-> Word buffer where subprogram is called

[Code]

1-> The subprogram name has not been found in the record buffer called.

2-> Program name exceeded 5 characters including address character "0".

3-> Program name has not been registered for G and M code macros.

[Measures to Take] Designate the subprogram call command correctly.

★ 5213 **File name**

File name or extension name has been designated when memory condense operation was attempted.

[Character-string] None

[Code] None

[Measures to Take] Designate the file name or extension correctly.

★ 5214 **Screen buffer overflow**

The screen buffer for editing has become full.

[Character-string] None

[Code]

None->No screen area record in screen buffer

1-> Data size transferred to the screen buffer is greater than the area designated in the edit buffer.

★ 5215 **Schedule program search**

Schedule program has not be found in the search operation.

[Character-string] None

[Code]

1-> Schedule program has not been selected.

2-> An attempt to search the program not actually present

[Measures to Take] Check the schedule program.

★ 5216 **Schedule program executing**

An attempt to select a program during the execution of a schedule program.

[Character-string] None

[Code]

1-> An attempt to select a program

2-> An attempt to select a schedule program

3-> An attempt to execute sequence number search

4-> An attempt to execute restart

5-> An attempt to search a schedule program

6-> Graphic high-speed drawing mode is selected.

[Measures to Take] Reset the NC.

★ 5217 **Travel limit over**

An attempt to set numerical values for the soft-limit which establishes the soft-limit outside the travel limit.

[Character-string] None

[Code] None

[Measures to Take] Set the data correctly.

★ 5218 **No file data**

An attempt to read a tape not containing file data.

The tape end code (NULL or %) has been read before the first CR or LF is read.

[Character-string] None

[Code] None

[Measures to Take] Read the correct tape.

★ 5219 **Check address**

Improper check address or change data setting

[Character-string] None

[Code]

1-> Address number larger than 10

2-> No delimiter "," between the address number and the address

- 3-> The address has exceeded the maximum address.
- 4-> The address was odd for other than bit data.
- 5-> The designated address number is not set.
- 6-> More than one identical element exists in the command.
- 7-> The numerical command is unsuitable.
- 8-> The value of data number command is out of the setting range.
- 9-> The data type is wrong.
- A-> The input condition of the CD command is incomplete.
- B-> The CD command has a data of which value is out of the setting range.
- C-> The CD command has no data.
- D-> The CD command has a data which contains unsuitable characters.

[Measures to Take] Set the address again correctly.

**★ 5220 Program end code**

No program end code at the end of a file.

[Character-string] None

[Code]

- 1-> No end code or RTS in a main program
- 2-> No end code, or M02 or M30 in a subprogram (library program)

[Measures to Take] Designate a correct end code.

**★ 5221 Program search**

Error in program search operation

[Character-string] None

[Code]

- 1-> Main program is not selected.
- 2-> Designated sequence name is not found.
- 3-> The program selected in the B, S, or M method cannot be read.

[Measures to Take] Designate the correct sequence name.

**★ 5222 Program stack overflow**

The number of subprograms to be used for one subprogram has exceeded 63.

[Character-string] None

[Code]

- 1-> Program stack is full.

[Measures to Take] Check the main program.

**★ 5223 Program buffer overflow**

In the following operations, the program buffer becomes full while the program is being loaded.

- (5) Library program setting
- (6) Program selection
- (7) Schedule program selection

In the program selection in method B:

- (8) The program buffer size excluding the schedule program and library program buffer is smaller than 16K bytes.

[Character-string] None

[Code]

- 1:

2:

[Measures to Take]

- 1) Check the program size.
- 2) Check the tape length (specification code) which can be handled.

Relationship between the specification size (tape length) and program size:

- Method A;  $SDF + MIN + SUB \leq \text{Specification size} - LIB$
  - Method B;  $SDF + SUB + 16K \leq \text{Specification size} - LIB$
- Fixed size for method B  $\leq \text{Specification size} - LIB$

**★ 5224 Edit buffer move range**

Movable range has been exceeded during edit buffer moving operation.

[Character-string] None

[Code] Data end point

**★ 5225 File change inhibit**

An attempt to edit the protected file

[Character-string] File name attempted to edit

[Code] None

[Measures to Take]

Release the protect, or cease the file change operation.

How to release the file protection (for A.MIN): PROT A.MIN;C

**★ 5226 Main program file selecting**

An attempt to edit or delete the file selected in operation method B. And an attempt to initialize the bubble memory when the file selected in operation method B.

[Character-string] File name attempted to edit

[Code] None

[Measures to Take] Select another file.

**★ 5227 No empty SAT**

The alarm occurs if the available sector size (SAT) is less than the data size (sectors) in the edit buffer plus eight sectors during editing operation. (Code 1)

The alarm occurs when the remaining sector size in the bubble memory is zero (0). (Code 2)

This alarm means that there is no available bubble memory area in the edit buffer to output the data.

[Character-string] None

[Code]

1-> This is a warning that the bubble memory still has eight sectors.

However, editing cannot be performed.

[Measures to Take] Delete files not used to secure available area.

**★ 5228 File record read**

Mismatch between the end of file and the end of record

[Character-string] None

[Code]

1-> Mismatch between the end of file and the end of record

**★ 5229 IGF device name**

An input device name is designated for reading IGF programs.

To read an IGF program, the input device name is fixed at IGF.

If FD0: is designated as the input device name, for example, an error occurs.

[Character-string] None

[Code] ASCII code of the designated device name

[Measures to Take]

Attempt the operation again without designating the input device name.

**★ 5230 Sequence restart command**

A sequence restart command which cannot be executed has been commanded.

[Character-string] None

[Code]

- 1-> Block count number exceeding 65535 has been designated.
- 3-> Data exceeding 9999 has been specified for the number of repetitions.
- 4-> No delimiter "," between the sequence name and the number of repetitions.
- 5-> Other than "NULL", "+" and "-" has been specified following the symbol "\*\*".
- 6-> The total number of blocks is outside 0-65536 as the result of specification of the preceding and following block number following the symbol "\*\*".
- 8-> A character has been specified following "E".
- 9-> No "+" sign before the block number.
- 10-> Block number other than 0 - 9999 has been designated.

[Measures to Take] Change the command so that it can be executed.

**★ 5231 Wrong tape code**

For the tape reading operation, a special code punched on tape is read.

Note: Codes other than \$20 - \$5F and HT are handled as special codes. DEL, BS and CR are always ignored when a) C options are not set and b) NC parameter (bit) No. 1 bit 6 is "1".

[Character-string]

32 characters preceding the character which has caused an error

[Code] Special code

[Measures to Take] Check the tape.

**★ 5232 Record buffer overflow**

The record buffer has become full due to too many characters in one block.

One block can contain up to 158 characters.

[Character-string]

63 characters from the beginning of the record which has caused an error

[Code]

- 1-> Error has occurred when one record has been read from the edit buffer.
- 2-> Error has occurred when one record has been read from the screen buffer.

[Measures to Take] Reduce the number of characters in one block.

**★ 5233 Axis spec**

Concerning compensation axis setting of attachment rotation compensation, When it was good for nothing U axis, it set U axis or, when it was good for nothing V axis, it set V axis or, when it was good for nothing W axis, it set W axis.

[Character-string] None

[Code] None

★ 5234 **EIA code**

A character not allowed by the EIA code has been used.

[Character-string]

32 characters preceding the character which has caused an error

[Code] The data which has caused an error

[Measures to Take] Check the tape.

★ 5235 **RS232C channel in use**

The RS232C channel specified has been in use for another job.

[Character-string] None

[Code]

1-> TT (CN0)

2-> CN1

3-> CN2

4-> CN3

5-> CN4

★ 5236 **'P'**

P number not supported by the specification has been specified in parameter data tape punch/read operation.

[Character-string] None

[Code] P data (hexadecimal) which has caused an error

[Measures to Take] Input the P data correctly.

★ 5237 **'Q'**

Q number not supported by the specification has been specified in parameter data tape punch/read operation.

[Character-string] None

[Code] Q data (hexadecimal) which has caused an error

[Measures to Take] Input the Q data correctly.

★ 5238 **'R'**

Character R has been specified before axis data for parameter data tape read operation.

[Character-string] Block which has caused an error

[Code] R number (hexadecimal) which has caused an error

[Measures to Take] Check the tape.

★ 5239 **Axis command**

Axis command has been specified for the data other than axis data for parameter data tape reading operation.

[Character-string] Block which has caused an error

[Code] None

[Measures to Take] Check the tape.

★ 5240 **Buffer over**

The number of data in one block has exceeded 255 in parameter data tape reading.

[Character-string] Block which has caused an error

[Code] None

[Measures to Take] Create the tape correctly.

★ 5241 **Program name**

Wrong program name is set when setting G code macro and M code macro.

Rule:

- a) Alphabet and number characters
- b) To begin with O
- c) When both alphabet and number characters are used, specify alphabet characters first.
- d) Up to four-digit characters following O
- e) OO\*\*\* must not be used (used by system or for automation specification).

[Character-string] None

[Code]

- 1-> Program name does not begin with "O".
- 2-> Program name does not consist of four alphanumeric characters following "O".

[Measures to Take] Designate a correct program name.

★ 5242 **RS232C device read**

Reading through the RS232C device is impossible or an error has occurred with the RS232C device.

[Character-string] None

[Code]

FFFFFFFF-> Reading through the RS232C device is impossible.

[Probable Faulty Locations] Defective RS232C device or problem in wiring.

★ 5243 **File attribute**

The file is other than sequential file although A option is designated in copy operation.

[Character-string] None

[Code]

- 1-> An A option is designated for a file other than sequential files.

[Measures to Take] Only sequential files can be connected.

★ 5244 **DNC device**

A device other than CN0:, CN1:, CN2:, CN3:, and CN4: is designated by parameter (bit) data.

[Index] None

[Code] None

[Measures to Take] Designate the correct data.

★ 5245 **DNC verify**

In reading operation with verify designation, data following "R" and that following "V" do not match.

[Index] None

[Code] The number of records in which the verify error has occurred.

★ 5246 **RS232C device not ready**

The terminals CN0: to CN4: of the DC code-controlled DNC are not ready.

Or, RS232C interface does not send the DSR signal (which indicates that the device is in the ready state).

[Character-string]

- Input-> This error occurred at the time of data input.
- Output-> This error occurred at the time of data output.



[Code] Status of RS232C interface

bit0-> DSR signal status

[Probable Faulty Locations]

The objective device is not ready because of defective communication cable.

★ 5247 **RS232C read buffer overflow**

Overflow with the read buffer for DNC's equipped with DC code.

[Character-string] None

[Code] None

★ 5248 **RS232C ready interrupt time out**

For the DC code-controlled DNC, the interrupt ready state or interruption failed to occur within the preset time.

[Character-string] None

[Code] None

The CNC master station sent a DC1 code for multi-read or verification but failed to receive data within the preset time.

While a CNC slave station was receiving text data for multi-read, data transmission was interrupted over the pre-set time.

The DNC has sent text data for multi-punch at a CNC slave station, but failed to receive a DC3 code.

[Character-string] None

[Code] None

[Probably Faulty Locations]

- 1) Short time is set at the parameter <RS232C ready wait time>.
- 2) The objective device is not normally operating.
- 3) The communication cable is defective.

★ 5249 **FMS coupling mode**

An attempt to interrupt the robot sequence is conducted during the FMS coupling mode.

- Program selection
- Schedule program selection
- Sequence stop
- Program search
- Schedule program search
- Restart
- PPC program selection
- Cursor movement

[Character-string] None

[Code] None

★ 5250 **Axis data**

The data is outside the allowable range when reading the system or user parameter data.

[Character-string] Block which has caused the error

[Code] Data (hexadecimal) which has caused the error

[Measures to Take] Check the tape.

★ 5251 **R data**

The data is outside the allowable range when reading the parameter data.

[Character-string] Data of the block which has caused the error

[Code] Input data

[Measures to Take] Check the tape data to see if it is within the input range.

★ 5252 **Spec code**

In reading the parameter data, parameter interlock from the EC is not received.

- (1) Tool management number data: PECI24, 23\_Bit 4(next tool)
- (2) EC optional parameter: PECI24, 23\_Bit 7(parameter interlock)

[Character-string] Block which has caused the error

[Code] P number (hexadecimal) which has caused the error

[Measures to Take]

- 1) Stop operations(turn off ATC operation indicating lamp, etc.)
- 2) Return the operation sequence number (ATC, AAC, etc.) to "1".

Note: This error has the same meaning as the time out error.

★ 5253 **No P number**

There has been no P number when the system or user parameter data was read.

[Character-string] Block which has caused the error

[Code] None

[Measures to Take] Check the tape.

★ 5254 **Machine parameter**

An attempt to read EC specification data for the control not provided with the ECP specification while reading the parameter data.

[Character-string] P number (hexadecimal) which has caused an error

[Code] P number (hexadecimal) which has caused an error

[Measures to Take] Check the tape.

★ 5255 **System data**

When reading the system parameter data, NC optional parameter (bit) No. 16 bit 7 (system parameter lock bit) is not "1".

[Character-string] Block which has caused an error

[Code] Q number (hexadecimal number) which has caused an error

[Measures to Take] Set "1" at NC optional parameter (bit) No. 16 bit 7.

★ 5256 **Message data**

Error in machine diagnosis message (Problem with software)  
Start code of the message is other than \$FF or not ASCII code.

[Character-string] None

[Code] None

★ 5257 **Page number set**

An attempt to search the wrong page in check page display operation. (Negative page number or "0" is entered.)

A character other than a number is entered as page data.

Note: If a page number consisting of more than four digits is entered, it is treated as invalid data and an error does not occur even if a page number exceeding the maximum page number is entered. In this case, page 1 is searched

[Character-string] None

[Code] None

[Measures to Take] Input the correct page number.

★ 5258 **No subprogram file**

In program selection operation, the subprogram designated is not found in the bubble memory (BB1:).

[Character-string] Subprogram file name designated

[Code] 3

[Measures to Take]

Designate a correct subprogram file name. If there is no subprogram file, create one.

★ 5259 **Sequence label over**

The number of sequence names has exceeded 31 in the program selection in operation method B.

[Character-string] None

[Code] 1

[Measures to Take]

Reduce the number of sequence names used. Sequences to which jump is made using the GOTO or IF statement must be assigned with sequence names. However, other sequences may be assigned with sequence numbers.

★ 5260 **Sequence name**

The number of characters in a sequence name, including N, has exceeded six in the program selection in operation method B.

[Character-string] Sequence name which has caused the error

[Code] 1

[Measures to Take]

Use a correct sequence name. The sequence name should have up to five characters.

★ 5261 **Device name**

FD\* device is specified though no floppy I/O function is provided.

When specifying a library program, you specified a subprogram filename other than MDI.

[Character-string] Specified sector device name

[Code]

- 1-> A channel other than CN0: to CN3: was specified for multi-read, verify, or punch operation.
- 2-> A read, verify, or punch command was specified when the compact main board was used and DC code control mode was not selected.
- 3-> An RS232C channel other than CN0: to CN3: was specified when the compact main board was used.

[Probable Faulty Locations]

- Tape reader (TR:) was specified as a device name.
- Punch (PP:) was specified as a device name.
- The specified device parameter is not set to "Standard DC code control".
- A device name CN0: was specified when the compact main board was used and DC code control mode was not selected.

[Measures to Take]

Enter correct data.

- A wrong input device name was specified for multi-read, multi-verify or multi-punch operation.
- Set the parameter to "Standard DC code control".

★ 5262 **Registered program**

An attempt to register a program name which has already been registered in the library program, or the same program name is present in the library program designated by the file.

[Character-string] None

[Code] None

[Measures to Take]

- 1) Abandon program registration.
- 2) Change the same program name in the LIB file.

★ 5263 **Library stack overflow**

An attempt to register more than 31 library program names.

[Character-string] None

[Code] 1

[Measures to Take]

- 1) Do not register new subprograms.
- 2) Check the registered subprograms if another subprogram is called from the registered subprogram. Reduce the number of subprograms to be within 31.

★ 5264 **Library size overflow**

An attempt to set library program area size larger than operation program buffer size (80 m or 160 m).

Designation of a number greater than the numbers indicated below:

\$8A00 (for 512K RAM) (\$8A00 = 35328)

\$FA00 (for 1M RAM) (\$FA00 = 64000)

[Character-string] None

[Code] None

[Measures to Take]

Library program size designation should be made within the size indicated below:

35328 (for 512K RAM)

64000 (for 1M RAM)

★ 5265 **No schedule program file**

To select a schedule program for automatic mode operation, a schedule program file name not in the bubble memory is designated.

[Character-string] None

[Code] 1

[Measures to Take] Designate the schedule program file in the bubble memory.

★ 5266 **Pot command exist**

With the soft-random ATC specification:

When the next tool is to be set in the ATC tool set/pot page on the CRT screen, the toolpot designated already has tool data.

[Character-string] None

[Code] None

[Measures to Take]

Set NONE for the designated pot and then reset the required data.

★ 5267 **Registered tool**

With the soft-random ATC specification:

When an active tool is to be set in the ATC tool set/pot page on the CRT screen, the same tool has already been registered in the ATC pot number/tool number correspondence table. When a tool number is to be set in the ATC pot number/tool number correspondence table, the same tool number has already been registered as the active tool.

[Character-string] None

[Code] None

[Measures to Take]

- 1) Set NONE for the active tool number and set the required tool number.
- 2) Set the correct tool number.

**★ 5268 Nonregistered tool**

When any of the next tool, active tool, and return tool is to be set on the ATC tool number setting screen, the designated tool number has not been registered in the ATC pot number/tool number correspondence table.

When the next tool is to be set at the ATC tool set/pot page for the soft-random ATC specification, the designated tool number has not been registered in the ATC number/tool number correspondence table.

[Character-string] None

[Code]

Nothing: above-mentioned contents

There is, and:

- 1-> The attachment tool number which is not registered with ATC POT No. & TOOL No. correspondence table concerning " TOOL NO./ ATTACHMENT NAME TABLE " establishment picture of simplicity 5 surface processing specification (MCV-A2) was about to be registered.
- 2-> Though an attachment tool number was not established on "TOOL NO./ ATTACHMENT NAME TABLE " establishment picture of 2-> simplicity 5 surface processing specification (MCV-A2), it was about to be established on ATC tool number establishment picture.

[Measures to Take]

Set the tool number in the ATC pot number/tool number correspondence table.

**★ 5269 Next tool command exist**

With the soft-random ATC specification:

When the designated pot is to be set at the ATC tool set/pot page, the next tool has already been set.

[Character-string] None

[Code] None

[Measures to Take] Set NONE for the next tool then set the required data.

**★ 5270 No empty pot**

With the soft-random ATC specification:

When the designated pot is to be set at the ATC tool set/pot page, the designated pot is not EMPTY, or when a large-diameter tool is to be set at the active tool, no empty pots are secured.

[Character-string] None

[Code]

- 1-> A tool has already been set at the designated pot.
- 2-> No empty pots are secured for setting a large-diameter tool.

[Measures to Take]

Secure empty toolpots in the ATC toolpot number/tool number correspondence table.

**★ 5271 Time out**

The machine is in operation when an attempt is made to set the machine parameter or the tool data, or the operation sequence number of ATC, AAC, etc. is not "1".

[Character-string] None

[Code] None

[Measures to Take]

- 1) Stop the machine by resetting the control.

2) Set the operation sequence number to "1".

★ 5272 **Pot No. registered**

When an attempt to set a tool number in the pot and tool number correspondence table is made, the same tool number has already been set in another toolpot.

[Character-string] None

[Code] None

[Measures to Take]

- 1) Set NONE for the pot for which the tool number has been registered. Then set the tool number at the required toolpot.
- 2) Set another tool number.

★ 5273 **Effective group No. 0-255**

An attempt to set spare tool group numbers outside 0 - 255.

[Character-string] None

[Code] None

[Measures to Take] Designate the correct data.

★ 5274 **Minus value invalid**

An attempt to set a negative number for tool number or tool management data.

[Character-string] None

[Code] None

[Measures to Take] Designate the correct data.

★ 5275 **Max number of registered tools**

An attempt to set a tool number larger than the maximum tool number.

[Character-string] None

[Code] Maximum tool number

[Measures to Take] Designate the correct data.

★ 5276 **Max 32767**

An attempt to set the data larger than 32767 of SET TIME and LEFT TIME for the tool management function.

[Character-string] None

[Code] None

[Measures to Take] Designate the correct data.

★ 5277 **Min -32768**

An attempt to set the data smaller than the lower limit for LEFT TIME of the tool management data.

$-32768 \text{ (min)} < \text{LEFT TIME} < 32767 \text{ (min)}$

[Character-string] None

[Code] None

[Measures to Take] Designate the correct data.

★ 5278 **Operand decode impossible [SPR] ? [ORG] ?**

Characters other than SPR and ORG have been entered when setting the spare tool and original tool numbers for the tool management function.

[Character-string] None

[Code] None

[Measures to Take] Designate the correct data.

★ 5279 **Operand decode impossible [OK] ? [NG] ?**

Characters other than OK and NG have been entered when setting the OK or NG status for the tool management function.

[Character-string] None

[Code] None

[Measures to Take] Designate the correct data.

★ 5280 **Large dia. tool mount impossible**

At the toolpot number/tool number correspondence setting page, setting of a large-diameter tool is wrong.

[Character-string] None

[Code]

1-> Tools are present in toolpots at both sides of the toolpot holding a large-diameter tool.

[Measures to Take]

Designate the correct data. Tool designation for the adjacent toolpots of the toolpot holding a large-diameter tool is impossible.

★ 5281 **Tool mount impossible**

At the toolpot number/tool number correspondence setting page, a large-diameter tool is designated in the toolpot adjacent to the one to which tool number is to be set.

[Character-string] None

[Code]

nothing: ATC pot No. & tool No. establishment picture, when a tool was about to be established, there was a great diameter tool back and forth of an appointed pot.

There is, and:

- 1-> A tool of attachment tool number (tool number on A/AM of stick thing) exception was about to be registered concerning "TOOL NO./ ATTACHMENT NAME TABLE" establishment picture in simplicity 5 surface processing specification (MCV-A2).
- 2-> It was crossed in 2 places and a thing of the same tool number was about to be registered concerning "TOOL NO./ ATTACHMENT NAME TABLE" establishment picture in simplicity 5 surface processing specification (MCV-A2).
- 3-> Though an attachment name was not established on "TOOL NO./ ATTACHMENT NAME TABLE" establishment picture in simplicity 5 surface processing specification (MCV-A2), it was established.
- 4-> Though an attachment name was not established on "attachment parameter " establishment picture in simplicity 5 surface processing specification (MCV-A2), it was established.

[Measures to Take] Designate the correct data.

★ 5282 **Tool No. clear impossible**

An attempt to set "" at the pots adjacent to the toolpot which is holding a large-diameter tool. These toolpots should have a dummy tool.

[Character-string] None

[Code] None

[Measures to Take] Abandon setting of ""

★ 5283 **Input data**

Concerning compensation axis setting of attachment rotation ,or it set an axis given name except for X/U on parameter of X/U changing ,or it set an axis given name except for Y/V on parameter of Y/V changing, It set an axis given name except for Z/W on parameter of Z/W changing.

[Character string] None

[Code] A value of a setting axis given name (hexadecimal)

★ 5284 **Multi volume file information**

Designation such as input file name and output file name is wrong when copying or program selecting the multi-volume operation files.

[Character-string] None

[Code]

- 0-> File name
- 1-> Extension
- 2-> ID character
- 3-> Sequence number
- 4-> Output file name designation
- 5-> OSP -> OSP

[Measures to Take]

Check the following points according to the error code displayed:

- 0-> When input format is IBM, the symbol "-" is used in the main file name.  
When input format is OSP, the symbol "-" is not used in the main file name, or it appears after the seventh character.  
When both input and output format is IBM, the symbol "-" is used in the output file name.
- 1-> Designation of extension is wrong.  
For IBM format, only "\_\_" is allowed.  
For OSP format, only "MIN" is allowed.
- 2-> Multi-volume identification character (C, L) is wrong.  
When input format is IBM, character other than "C" or "L" is used in the file directory.  
When input format is OSP, character other than "C" or "L" is used following the symbol "-" in the input file name.
- 3-> The multi-volume sequence number is other than 1 - 99.
- 4-> Output file name is designated for copy operation from IBM format to OSP format, or from OSP format to IBM format.
- 5-> Copying a program from OSP format to OSP format is impossible.

★ 5285 **Set impossible**

[Character-String] None

[Code] None

- On the cutting condition change screen, the designated S command value exceeds the selected gear range.
- On the cutting condition change screen, change of F or S command was attempted without running the machining program.
- On the cutting condition change screen, change of F or S command was attempted in the sequences for synchronized tapping cycle which inhibits panel override.
- On the cutting condition change screen, change of F command was attempted while F 1-place shift command is in effect.
- On the cutting condition change screen, change of F command was attempted during dry run.
- On the cutting condition change screen, change of F command was attempted while F override invalidating command (M136) is in effect.
- On the cutting condition change screen, change of S command was attempted while S override invalidating command (M134) is in effect.
- On the cutting condition change screen, storage of F or S command was attempted without running the machining program.

There is a code, In this case, provide a simple 5-face AT(=simplicity 5 surface attachment) specifications.

[Character-string] None



[Code]

- 1-> 1-10 exception was input.
- 2-> selection of the attachment type which is not registered with " registration at tachment menu " was performed.

**★ 5286 Set condition**

**★ 5287 Input data overflow (Sync. axis data)**

Overflow of the slave axis data due to the calculation of the master axis zero point (machine zero).  
Overflow of the offset data in terms of the master axis due to the calculation of the slave axis zero point (machine zero)

[Character-string] None

[Code]

- 1-> Overflow of the slave axis data
- 2-> Overflow of the offset data

**★ 5288 Tape convert file load**

With the FS-9 level 2 or OSP3000M level 3 tape conversion specification:  
The tape conversion software is not loaded when tape conversion is to be executed.

[Character-string] None

[Code] None

**★ 5289 DNC NC program not found**

The NC program requested in the DNC operation mode is not registered in the host computer.

[Character-string] None

[Code] None

**★ 5290 DNC can not transmit**

An attempt is made to transfer an NC program in batch while DNC communication is impossible.

[Character-string] None

[Code]

- 1-> Attempt during communication alarm
- 2-> DNC communication off
- 3-> Not in interruption mode (DNC-C2, C3)
- 4-> Not ready

**★ 5291 DNC answer time over**

During the execution of the INPUT and VERIFY commands in the DNC mode operation, response ([D,NCP] , [N,NCP] ) from the host computer is not returned within a period set at NPC2.

[Character-string] None

[Code] None

**★ 5292 DC code**

It receiving DC1 in multi reading-verification phi in CNC satellite office.

[Character string] None

[code] =11

It receiving DC1 in multi reading-verification phi in CNC satellite office.

[Measures to take] Setting of master station/satellite office makes a mistake.

★ 5293 **DNC backup file name nothing**

During the OUTPUT or VERIFY operation in the DNC mode operation, backup file name is not registered when only the backup file name is designated with the request file name and extension omitted.

[Character-string] None

[Code] None

★ 5294 **FMS coupling mode**

In FMS-1 and FMS-2 specifications, the following operations are attempted:

- Program selection
- Schedule program selection
- Number search
- Number search using the cursor
- Restart
- Schedule program search

[Character-string] None

[Code] None

★ 5295 **DNC transmitting**

For data transfer by DNC-B, Communication error occurred during batch transfer of DNC data, resulting in abnormal end.

[Character-string] Communication alarm number such as 4218, 4219, 4220, or 4037

[Code] For the cause of the alarm, refer to the codes of the alarm indicated by the character-string.

[Character-string] None

[Code] None

Data input/output or verification is impossible by setting the NC optional parameter bit No.1 bit0=0/No.11 bit1=0 (EIA).

This is because two or more same settings exist at the NC optional parameter (bit) No. 27, 28, 29, 30, 31, 49 (EIA code settings that represent '=', '\*', '[', ']', '\$', '#') or a code in the EIA code table is set.

Or, the parameter values from Nb to Tw set with the SET command from the host are abnormal.

For example, this error occurs if Tp=0 is set. For detail of each parameter, OSP-U100/U10M Special Functions Manual (No. 2) DNC-B high speed RM buffer system (SECTION 5 PARAMETER) and OSP-U100/U10M Operation Manual.

For data transfer by DNC-C Attempt was made to execute a command that cannot be executed during communication with the host computer.

[Code]

1-> An attempt to execute the following commands while an NC program is being sent in the INDEPENDENT mode

- Program selection
- Schedule program selection
- Number search
- Restart
- Number search using the cursor
- Schedule program search
- Sequence stop
- Library

[Measures to Take]

DNC-B

If a character-string appears indicating the alarm number, refer to the corresponding alarm.

If no character-string or code appears, check the communication parameter values.

DNC-C

Wait until the NC program transfer is completed.

★ 5296 **Remote operation mode**

In the DNC-B mode operation, following operations are attempted while buffer operation is in progress with the buffer operation mode ON. This error occurs both with the protocol A and B.

[Character-string] None

[Code]

1-> Batch transfer of NC program (impossible only during buffer operation)

3-> Main program name or subprogram file name is designated when selecting a program in the NC program transfer method (2) during buffer operation mode.

★ 5297 **High speed draw mode**

It was about to change it to high speed drawing mode except for a machine lock state of automatic operation mode, MDI running mode.

[Character-string] None

[Code] None

★ 5298 **No blank data**

Elaboration conditions turned a blank display into a specification at the time of unregistration in terms of the same blank.

[Character-string] None

[Code] None

★ 5299 **DNC data kind**

In the DATA INPUT, DATA OUTPUT and DATA VERIFY operations during DNC-C mode operation, a data number which cannot be designated is designated.

[Character-string] None

[Code] None

★ 5300 **DNC data range**

An error in the data number for data request or transmitted data in the DATA INPUT, DATA OUTPUT, and DATA VERIFY operations during DNC mode operation.

[Character-string] None

[Code]

1-> Error in designation format

2-> Two or more ranges designated for a single data(same turret)

3-> The following requirement is not satisfied:

$\leq$  start number  $\leq$  end number  $\leq$  maximum number

4-> Data for the B saddle is designated on a single turret turret model.

★ 5301 **Check point setting**

Illegal setting of check point

[Character-string] None

[Code]

1-> Input other than pointer value (hexadecimal) and option

★ 5302 **No blank data**

It was about to turn a blank display that a blank is undefined.

[Character-string] None

[Code] None

★ 5303 **Set,add impossible**

Concerning attachment parameter setting, It was about to set ceiling loading of the area an attachment does not have set, loading timer.

★ 5304 **Transfer blank data**

An instruction of copy of blank data is wrong.

[character string] None

[code]

1-> It instructed 0 to 50 exception on a value on a coordinate system number.

2-> Grammar of operand has mistake.

3-> An input coordinate system number does not exist.

4-> There is not the vacancy area which registers blank data.

[Character-string] None

[Code] None

★ 5305 **Coordinate system number undefined**

Though a coordinate system number was undefined, it was about to carry out symbol registration.

[Character-string] None

[Code] None

★ 5306 **Geometory definition**

It was about to define the symbol dimensional standard which is not remitted.

[Character-string] None

[Code] None

★ 5307 **Blank shift**

It did the instruction that a blank place seems to exceed a limit value.

[Character-string] None

[Code] None

★ 5308 **DNC device name**

★ 5309 **Blank display area**

It did not instruct blank display range numeric and was about to carry out change of blank range.

[Character-string] None

[Code] None

★ 5310 **No registered tool**

It designated a number except for the tool guide figure which is displayed in a screen at the time of a tool great selection.

[Character-string] None

[Code] None

★ 5311 **DNC directory format**

★ 5312 **Amend device specify**

[Character-string] None

[Code] None

★ 5313 **Not found pitch comp. data file**

The pitch error compensation data file is not found in the bubble memory (BB0:) when back up of this file is attempted.

[Character-string] None

[Code]

- 1-> No file
- 2-> Sector length of the file differs from the compensation data.

★ 5314 **LASER measurement execute**

An attempt is made to back up the pitch error compensation data while laser measurement is being carried out (LMW,LMV command).

[Character-string] None

[Code]

- 1-> Measurement in progress

★ 5315 **Solid shape command**

★ 5316 **Coordinate Change operation**

An operation error has occurred during arithmetic operation of oblique plane data.

[Character-string] None

[Code] XYY

- X-> Place where the operation error has occurred.
- 2-> An error occurred in operation for determining the parallel translation amount of oblique coordinates.
- 5-> An error occurred in operation for determining the matrix of oblique coordinates.
- YY-> Operation error status

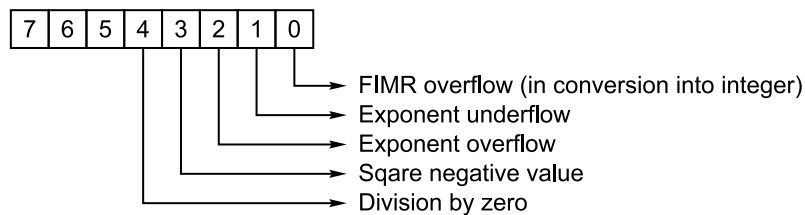

[Probable Faulty Locations]

- 1) Data input error
- 2) Defective software

[Measures to Take]

Check the input patterns and input data consisting of the oblique coordinates.

★ 5317 **Relative actual position set axis name**

An alphabet other than the axis names is used as an axis name for zero setting or presetting of the relative actual position display, or for setting the index axis.

[Character-string] None

[Code] Hexadecimal ASCII code of the erroneous axis name

[Measures to Take] Designate the correct axis name.

★ 5318 **Program select impossible**

This alarm occurs in preparatory operation if OPERATION READY is selected with a file other than MIN used as an edited or created file.

[Character-string] None

[Code] None

[Measures to Take]

The operation ready command is effective only in the files edited or created under the name of MIN.

★ 5319 **Output file specify impossible**

This alarm occurs when an output file name is designated in the program creation mode.

[Character-string] None

[Code] None

[Measures to Take] No output file can be designated in the program creation mode.

★ 5320 **Wrong character**

Due to an error in the software, a code which cannot be analyzed is found in the buffer where the operation result is registered.

[Character-string] None

[Code] None

[Measures to Take]

Problem with the program for the processing to write the result of operation into the buffer

★ 5321 **Character size overflow**

In the interactive programming operation, overflow (more than 158 characters) of a record has occurred due to the entry of the operation result. Writing is intervened and an error message is displayed.

[Character-string] None

[Code] None

[Measures to Take] Do not enter the operation result, which causes record overflow.

★ 5322 **Pattern selection**

A shape pattern which is not allowed (undefinable) is designated.

[Character-string] None

[Code] None

[Measures to Take]

On the shape designation screen, input the shape elements (point, line, right circle, left circle) again.

★ 5323 **Input data format**

An attempt to designate data other than those within designated range.

[Character-string] None

[Code] None

★ 5324 **No calculation result**

No calculation result is provided.

[Character-string] None

[Code] None

★ 5325 **No last result**

When power supply is turned on, operation result is not provided. That is, no calculation result (solution buffer data being zero) is provided.

[Character-string] None

[Code] None

[Measures to Take]

Check whether operation has ever been done after power has been turned on.

★ 5326 **No last element**

When the last element key is pressed, no previous data is present.

[Character-string] None

[Code] None

★ 5327 **Data range over**

An attempt to set data outside the allowable range.

[Character-string] None

[Code] None

[Measures to Take]

Before setting the data, be sure to check whether it is within the allowable range.

★ 5328 **Radius size minus**

A negative value has been entered as the known radius data.

[Character-string] None

[Code] None

[Measures to Take] Radius data must be positive.

★ 5329 **Chamfer size minus**

As the chamfer size data, a negative value has been entered.

[Character-string] None

[Code] None

[Measures to Take] Chamfer size data must be positive.

★ 5330 **2 lines parallel**

The designated two lines are parallel to each other.

This error occurs during the calculation of coordinates.

[Character-string] None

[Code] None

[Measures to Take] Check the input pattern and input data.

★ 5331 **2 circles piled**

The designated two circles overlap each other.

This error occurs during the calculation of coordinates.

[Character-string] None

[Measures to Take] Check the input pattern and input data.

★ 5332 **Point inside circle**

When a point and a circle are compared, the point lies inside the circle.

This error occurs during the calculation of coordinates.

[Character-string] None

[Code] None

[Measures to Take] Check the input pattern and input data.

★ 5333 **Unknown circle direction**

The rotation direction of an unknown circle is wrong.

This error occurs during the calculation of coordinates.

[Character-string] None

[Code] None

[Measures to Take] Check the input pattern and input data.

★ 5334 **Unknown circle radius size**

The unknown circle radius is wrong.

This error occurs during the calculation of coordinates.

[Character-string] None

[Code] None

[Measures to Take] Check the input pattern and input data.

★ 5335 **Circle inside another circle**

When the two designated circles are compared, one circle is inside the other circle.

This error occurs during the calculation of coordinates.

[Character-string] None

[Code] None

[Measures to Take] Check the input pattern and input data.

★ 5336 **No intersection point between line and circle**

When a line and a circle are compared, there is no cross point between them.

This error occurs during the calculation of coordinates.

[Character-string] None

[Code] None

[Measures to Take] Check the input pattern and input data.

★ 5337 **No intersection point between 2 circles**

When two designated circles are compared, there is no cross point between them.

This error occurs during the calculation of coordinates.

[Character-string] None

[Code] None

[Measures to Take] Check the input pattern and input data.

★ 5338 **Line definition impossible**

Creation of a line is impossible.

This error occurs during the calculation of coordinates.

[Character-string] None

[Code] None

[Measures to Take] Check the input pattern and input data.

★ 5339 **Calculation impossible**

Data with which calculation is impossible is found (division by 0, for example).

This error occurs during the calculation of coordinates.

[Character-string] None

[Code] None

[Measures to Take] Check the input pattern and input data.



★ 5340 **Convert code**

In the reverse conversion of pattern cycle, an incorrect code is found within block data.

[Character-string] None

[Code] None

[Measures to Take]

- 1) X, Y, Z and F may be specified only once in a block.
- 2) I and K pairs for LAA and Q and K pairs for ARC should be within nine.
- 3) Sequence names should be written in up to four digits; alphabet letters must not be placed following a number in a sequence name.
- 4) Codes must be followed by a number.
- 5) No ")" corresponding to "(".

★ 5341 **Result data overflow**

An attempt to use the result of overflow (value greater than 99999.999).

[Character-string] None

[Code] None

[Measures to Take] Calculation result causing overflow cannot be used.

★ 5342 **Decimal point**

Input data has more than one decimal point. Decimal point is used for data which cannot contain it.

[Character-string] None

[Code] None

[Measures to Take]

- 1) Check the input data and correct it as needed.
- 2) Change the setting of parameter (3 or 9).

★ 5343 **Numerical data**

Numerical data input is not regarded as numerical data.

[Character-string] None

[Code] None

[Measures to Take] Input data has an error. Input correct data again.

★ 5344 **No. of digits**

The numerical data input has more than the allowable number of digits.

	Length	Feedrate	Time	Angle
mm	8(8)	8(3)	6(3)	6(3)
inch	8(4)	8(4)	6(3)	6(3)

\* Values in parenthesis are the number of digits to the right of a decimal point.

The values above indicate the allowable maximum number of digits.

[Character-string] None

[Code] None

[Measures to Take] Input the data again correctly.

★ 5345 **Area command**

Wrong data is found when confirmation drawing for the milling cycle is to be output.

[Character-string] None

[Code] None

[Measures to Take] Check the input data.

★ 5346 **Hole position command**

Wrong data is found when confirmation drawing for the hole pattern is to be output.

[Character-string] None

[Code] None

[Measures to Take] Check the input data.

★ 5347 **No block data**

The write function is selected when the block data to be written in the playback mode has not been created.

[Character-string] None

[Code] None

[Measures to Take] Check whether setting and calculation have been done correctly.

★ 5348 **CAL command**

This error occurs when a calculation command is wrongly specified or the CAL function is vainly used in the playback mode.

[Character-string] None

[Code]

- 1-> Variable is changed (by parameter setting) while the main program is running.
- 2-> The specified axis is not the controlled one.
- 3-> Axis name is not followed by P or N.
- 4-> Zero offset data or tool length offset data cannot be set at the horizontal spindle. Or, the swivel head index position is not determined. (AAC counter: 0 is set at machine system parameter word No. 30)
- 5-> Zero offset data or tool length offset data cannot be set at the horizontal spindle with attachment. Or, the attachment is indexed at an angle other than 0, 90, 180, 270 deg.
- 6-> P or N cannot be specified together with an option code after the axis name.

[Measures to Take]

Check if the CAL function is used under the proper condition.

If the code No. 5 appears, set the attachment index angle to 0, 90, 180, or 270 deg.

If No. 6 appears, do not specify any option code with P or N after the axis name.

★ 5349 **Select number**

Wrong pattern number is input for the drilling cycle, hole position pattern, milling cycle, and circle cutting cycle.

[Character-string] None

[Code] None

[Measures to Take]

Check the pattern number and input a pattern number within a specified range.

★ 5350 **Data shortage**

Necessary data is not found in the block write and confirmation of the drilling cycle, hole position pattern, milling cycle, and circle cutting cycle, and in the block rewriting for reverse conversion.

[Character-string] None

[Code] None

[Measures to Take]

If necessary data is not found in the data setting for pattern cycle and for patterns in reverse conversion, the cursor is located at such a data location after outputting the error message.

★ 5351 **Data range over**

Wrong data is input in the data setting process for drilling cycle, hole position pattern, milling cycle, circle cutting cycle, and reverse conversion.

[Character-string] None

[Code] None

[Measures to Take]

The data input is compared with the allowable maximum and minimum values. An error occurs if the data is not within the allowable range.

★ 5352 **No convert pattern**

The REVERSE CONVERSION function key for the pattern cycle is pressed.

[Character-string] None

[Code] None

[Measures to Take]

The pattern required is not found when the REVERSE CONVERSION function key is pressed.

★ 5353 **Select plane tool length offset unmatched**

In the reverse conversion operation, the plane currently selected and the plane for the one block data to be reverse converted do not match each other.

[Character-string] None

[Code] None

[Measures to Take]

Use the same plane for the reverse conversion block data.

Example: XY plane -> G56 -

ZX plane -> G55 -

YZ plane -> G54 -

★ 5354 **Select plane maximum return unmatched**

Upper limit level return operation (M52) is effective only on the XY plane.

The error occurs if the upper limit level return is effective on a plane other than the XY plane or if M52 is contained in the block data, to be reverse converted, on a plane other than the XY plane.

[Character-string] None

[Code] None

[Measures to Take]

Upper limit level return must not be made effective on a plane other than the XY plane. If the plane selected is other than the XY plane for the reverse conversion, delete M52.

★ 5355 **Initial program load**

An error occurred while the first 16 sectors of the program which has been selected for the B, S, or M method operation were being read.

[Character-string] None

[Code] XXXXYYYY

XXXX->Physical sector number involved with the error

YYYY->Error number (the number in the error table)

[Measures to Take] Follow the steps indicated in the error table.

★ 5356 **Schedule program update mode**

[Character-string] None

[Code]

- 1-> Registration of automatic update is made for the schedule program which has been selected without the "automatic update" designation.
- 2-> SP number search, using the function key or cursor key, was made for the program which has been selected with the "automatic update" designation.
- 3-> The program selected with the "automatic update" designation contains the GOTO or IF block.

★ 5357 **Schedule program update entry**

[Character-string] None

[Code]

- 1-> The designated schedule program is not found.
- 2-> A schedule program has already been registered.
- 3-> The GOTO or IF block is used.
- 4-> The program (machining processes) is not identical in the range from the head of the program to the registration point.

★ 5358 **MSB stack overflow**

At the time of power supply, the number of most significant bits (MSB) is 256 or over.

[Character-string] None

[Code] None

[Measures to Take]

Check the number of MSBs.

Since the MSBs are prepared by the maker, this alarm actually does not happen.

★ 5359 **MSB buffer overflow**

At the time of power supply, the program buffer for MSBs is full.

[Character-string] None

[Code] None

[Measures to Take]

Check the number of MSBs.

Since the program buffer capacity is factory-set according to the MSB size stored in MD0, this alarm actually does not happen.

★ 5360 **Cutter R. comp input NO.**

When a cutter diameter offset number is designated, the corresponding data is "0" or smaller, or greater than the value indicated below.

- (1) Tool data 300 type specification->301
- (2) Tool data 200 type specification->201
- (3) Tool data 100 type specification->101
- (4) Tool data 50 type specification->51

[Character-string] None

[Code] None

[Probable Faulty Locations]

This error occurs if a cutter diameter compensation number is not designated when a cutter diameter compensation value is designated.

[Measures to Take]

Designate the cutter diameter compensation number after confirming the number of allowed cutter diameter compensation data sets and the data being specified.

★ 5361 **Zero set input NO.**

When the zero offset number is designated, the corresponding data is "0" or smaller, or greater than the value indicated below.

- (5) Work coordinate system 50 set specification->51
- (6) Work coordinate system 20 set specification->21
- (7) Work coordinate system 1 set specification->2

[Character-string] None

[Code] None

[Probable Faulty Locations]

This error occurs if a zero offset number is not designated when a zero offset value is designated.

[Measures to Take]

Designate the zero offset number after confirming the number of work coordinate systems supported and the data being specified.

★ 5362 **Tool length offset input NO.**

When a tool length offset number is designated, the corresponding "0" or smaller, or greater than the value indicated below.

- (8) Tool data 300 type specification->301
- (9) Tool data 200 type specification->201
- (10) Tool data 100 type specification->101
- (11) Tool data 50 type specification->51

[Character-string] None

[Code] None

[Probable Faulty Locations]

This error occurs if a tool length offset number is designated when a tool length offset value is designated.

[Measures to Take]

Designate the tool length offset number after confirming the number of allowed tool length offset data sets and the data being specified.

★ 5363 **Set data limit over**

The data having been input is outside the allowable range.

- (12) When designating the datum ring, the input data is outside the range of 0 to 1000000.
- (13) When designating the datum tool diameter, the input data is outside the range of 0 to 1000000.
- (14) When designating the Z-axis retraction amount for an OD gauging cycle, the input data is outside the range of 0 to 2000000.
- (15) When designating the maximum skip feed stroke for detection of contact, the input data is outside the range of 0 to 1000000.

[Character-string] None

[Code] None

[Measures to Take] Confirm that the data being set is within the allowable range.

★ 5364 **Data set not ready**

- For a work gauging cycle (slant or corner), the corner position or angle has not been obtained when designating the zero offset value.
- For a work gauging cycle (X, Y, Z end face), the end position has not been obtained when designating the zero offset value.
- For a work gauging cycle (ID/OD center), the center position and diameter have not been obtained when designating the zero offset value.
- For a work gauging cycle (inside wall/outside wall center), the center position has not been obtained when designating the zero offset value.

[Character-string] None

[Code] None

★ 5365 **Change data**

When changing the VAC data, illegal data has been set.

[Character-string] None

[Code]

- 1-> The address is greater than 9.
- 2-> A delimiter between the number and the change data is other than a comma ( , ).
- 3-> The input value does not match the number of digits of the display format.
- 4-> No input data
- 5-> The designated address number has not been set.

[Measures to Take] Input the correct data.

★ 5366 **Data update is inhibited**

An attempt is made to change the VAC data while the VAC data change is inhibited.

[Character-string] None

[Code]

- 1-> The schedule program is being executed.
- 2-> The main program is being executed.
- 3-> An NC alarm has occurred.
- 4-> The VAC active parameter is being changed.

★ 5367 **Animation data file read**

In reading the animated data file for program selection, an error was detected in the file.

[Character-string]

- 632-> Program end code
- 633-> ELETE statement
- 634-> DEF statement
- 636-> Improper value
- 367-> Illegal character
- 638-> User variable
- 639-> System variable
- 640-> Illegal command
- 641-> Program element over
- 642-> Coordinate data
- 643-> END statement
- 644-> Command over
- 645-> Command format
- 646-> Additional parameter

647-> Expression

648-> Shape registration area over

[Code]

Line number where the error was detected (in decimal)

Depending on the error content, the actual error line may not correspond to the line indicated by the code.

[Measures to Take]

Correct the line indicated by the code by removing the error indicated by the character-string.

**★ 5368 MS-DOS**

An error has occurred in data conversion into MS-DOS formatted file.

[Character-string] None

[Code]

1-> The designated command character (function) is not supported.

2-> Command syntax error

3-> The MS-DOS file name is designated in a wrong format.

4-> The device is not designated or its format is wrong.

5-> The designated path is not found.

6-> The OSP file name is wrong.

7-> The output file has not been designated or designated using a wild card; \* or ?.

8-> The option code is wrongly specified.

9-> The MS-DOS formatted file is not used.

A-> The output file is a system file or a cache file.

B-> Copying from OSP to OSP or from MS-DOS to MS-DOS was attempted.

C-> It is impossible to open the file.

D-> The file is full.

E-> The file name contains an illegal character.

[Measures to Take] Check the floppy disk and the command format.

**★ 5369 MSB program load automatically when power on**

Attempt is made to register the program that has been automatically registered in the library when the power is supplied to the MSB. Or, the program name is the same with a program already registered in the MSB.

[Character-string] None

[Code] Rejected (already registered) program name

[Measures to Take]

The MSB program is automatically registered with the power ON, and there is no need to register it in the library again. Or, change the program name.

**★ 5370 Can't block insert in DIALOGUE DATA (T-code)**

It instructed a tool switching instruction and an instruction except for a deflection on simultaneous in a basis operation instruction.

[character string] None

[code] None

[Measures to Take]

Please delete the tool switching instruction which it turns into only a tool switching instruction.

[It fitted on I-MAP and there was not on the side of NC]

★ 5371 **Can't block insert in DIALOGUE DATA (address)**

It instructed a tool head compensation number and work coordinates on simultaneous in a basis operation instruction.

[character string] None

[code] None

[Measures to Take]

Please delete a tool head compensation number or work coordinates one side.

[It fitted on I-MAP and there was not on the side of NC]

★ 5372 **Can't block insert in DIALOGUE DATA (circle data)**

It instructed arc centrum and an arc radius on simultaneous in a basis operation instruction.

[character string] None

[code] None

[Measures to Take]

Please delete of arc centrum or arc radius one side.

[It fitted on I-MAP and there was not on the side of NC]

★ 5373 **Upper 0-0 Lower 0-6**

On the tool data setting screen of the tool management function, management mode was selected with a wrong 2-digit value; the upper digit is not 0 or the lower digit is not any of 0 to 6.

[Character-string] None

[Code] None

[Measures to Take]

Re-enter 0 in the upper digit and any of 0 to 6 in the lower digit.

★ 5374 **Tool list file read**

In reading the tool list file for program selection, an error was detected in the file.

[Character-string] None

[Code] XYZZZZZZ

X-> Cause

1-> The required field (data) is not found.

2-> The tool list data has a wrong attribute. (The integer, for example, has a decimal point.)

3-> The data is set exceeding its setting range.

4-> More than 128 tool are registered in the tool list.

5-> The same tool number is assigned to plural tools.

Y -> Field number

0-> Tool number

1-> Tool type

2-> Material code

3-> Tool diameter

4-> The number of cutting edges

5-> Pitch

6-> Nose angle

7-> Tool nose diameter

8-> Tool length offset number

9-> Cutter radius compensation number

ZZZZZZ-> Line number where the error was detected (in decimal).

The message lines are also counted.



[Measures to Take]

Correct the field number data in the line indicated by the code.

★ 5375 **Data verify**

In data verify by the parameter input/output function, a verification error was detected.

[Character-string] Verified character-string

[Code] Generated PNO

[Measures to Take] None

★ 5376 **Data file not found**

In parameter read by the parameter input/output function, no file is found in the designated sector device.

[Character-string] None

[Code] None

[Measures to Take] Designate the correct input file name.

★ 5377 **Message length**

In data input by the parameter input/output function, too many characters are entered in the message.

[Character-string] None

[Code] None

[Measures to Take] Reduce the number of characters.

★ 5378 **Data verify option**

In data verify by the parameter input/output function, an optional tolerance is wrongly set.

[Character-string] None

[Code] None

[Measures to Take]

Enter the correct tolerance.

Set the tolerance within 8 digits.

★ 5379 **Data read punch device name**

In the parameter input/output function, the device name is wrongly designated.

[Character-string] None

[Code] None

[Measures to Take] Designate the correct device name.

★ 5380 **Thermal deviation compensation executing**

Thermal deviation compensation executing

A parameter set value for thermal deviation compensation was changed during execution of compensation.

[Character-string] None

[Code] None

[Measures to Take]

Deactivate (turn OFF) the thermal deviation compensation function before setting new data.

★ 5381 **Main program not select**

F, S command playback setting

Program rewriting was attempted without selection of the main program.

[Character-string] None

[Code] None

[Measures to Take]

★ 5382 **Not teaching mode**

F, S command playback setting

With the teaching mode off, program rewriting was attempted.

With the teaching mode off, change of F, S command was attempted on the cutting condition change screen.

With the teaching mode off, the F, S command cancel mode was selected.

With the teaching mode off, storing F, S commands in the memory was attempted on the cutting condition change screen.

[Character-string] None

[Code] None

[Measures to Take]

★ 5383 **F,S command memory buffer overflow**

F, S command playback setting

On the cutting condition change screen, the F, S command memory area is full.

[Character-string] None

[Code] None

[Measures to Take]

★ 5384 **Teaching impossible program operation method**

F, S command playback setting

Without selection of the operation method A, the teaching mode was selected on the cutting condition change screen.

★ 5385 **WRONG DATA FORMAT**

During activation of NC-equipped MOP-TOOL, invalid data was entered.

[Character-string] None

[Code] None

[Measures to Take] Re-enter the relevant data within the setting range.

[Related Specifications] MOP-TOOL built in

★ 5386 **BEYOND DATA**

During activation of NC-equipped MOP-TOOL, the entered data exceeds the setting range.

[Character-string] None

[Code] None

[Measures to Take] Re-enter the relevant data within the setting range.

[Related Specifications] MOP-TOOL built in

★ 5387 **WRONG TOOL NO.**

During activation of NC-equipped MOP-TOOL, an attempt to edit, copy, clear, or delete the set tool data was made with the cursor located at a position where no tool number is registered.

[Character-string] None

[Code] None

[Measures to Take]

Use the above functions after moving the cursor to a tool number registered position. For editing, a tool number can be directly specified.

[Related Specifications] MOP-TOOL built in

★ 5388 **USING TOOL**

During activation of NC-equipped MOP-TOOL, deletion of the currently used tool data was attempted by the function for deleting the set tool data.

[Character-string] None

[Code] None

[Measures to Take]

Before deleting the data, change the spindle tool number or turn off the MOP mode selection switch.

[Related Specifications] MOP-TOOL built in

★ 5389 **LOAD PARAMETER**

During activation of NC-equipped MOP-TOOL, the same analog port was specified as inputs of load data and load parameters when load parameter or load data was set.

"Load parameter None" and "Load parameter\*/ were specified at the same time by setting of load parameter and by designation of zero-level flag, respectively.

[Character-string] None

[Code] None

[Measures to Take]

The same analog port cannot be used as input ports of different parameters. Select another analog port.

When setting "load parameter" at the zero-level flag, select the "load parameter" by designating the load parameter.

[Related Specifications] MOP-TOOL built in

★ 5390 **TOOL NO. FULL**

In tool data setting on NC-equipped MOP-TOOL, the number of registered tools exceeds 300 tools.

[Character-string] None

[Code] None

[Measures to Take] Delete unnecessary data from the registered tool data.

[Related Specifications] MOP-TOOL built in

★ 5391 **B SADDLE**

This alarm occurs only on the MOP-TOOL for CNC lathes; this alarm never occurs on any machining centers.

[Character-string] None

[Code] None

[Measures to Take]

This alarm will not normally occur. Should it occur, change the software or parameter file.

[Related Specifications] MOP-TOOL built in

★ 5392 **BOUNDARY ADD**

During activation of NC-equipped MOP-TOOL, "1-10" was designated as the I/O check data display format when an odd number address was specified.

[Character-string] None

[Code] None

[Measures to Take]

Change the display format to a number between 11 and 15.

Change the address to an even number.

[Related Specifications] Built-in type MOP-TOOL

★ 5393 **WRONG ADDRESS**

On the I/O check data display by the built-in type MOP-TOOL, the set address is larger than the maximum address of the mounted memory.

[Character-string] None

[Code] None

[Measures to Take] Set a memory address smaller than the mounted memory address.

[Related Specifications] Built-in type MOP-TOOL

★ 5394 **NO-PROGRAMED REF.**

On the built-in type MOP-TOOL, allowable value limit value adaptive control upper limit adaptive control lower limit was set before setting reference values (same in the case of playback setting).

[Character-string] None

[Code] None

[Measures to Take] Set these values after setting the reference values.

[Related Specifications] Built-in type MOP-TOOL

★ 5395 **NO-PROGRAMED COEF.**

On the built-in type MOP-TOOL, the load data coefficient is set at 0. It is, therefore, impossible to calculate the vertical axis range, vertical axis initial value, and load monitor parameter air cut judgement value when the scale is changed (including the scale change in tool data playback setting). Or, since the load parameter coefficient is set at 0, load parameters on the no-load signal table cannot be calculated.

[Character-string] None

[Code] None

[Measures to Take]

Set a value other than 0 as a coefficient for load parameter.

Set a value other than 0 as a coefficient for data parameter.

[Related Specifications] Built-in type MOP-TOOL

★ 5396 **PROGRAMED ODD NO.**

On the built-in type MOP-TOOL, odd number data was set in the time range for scale change (including scale change by playback tool data setting).

[Character-string] None

[Code] None

[Measures to Take] Set an even number.

[Related Specifications] Built-in type MOP-TOOL

★ 5397 **NO FUNCTION DATA**

Though the built-in type MOP-TOOL has no specification for controlling NC functions by flag communication, NC function selection or ON/OFF using parameters are specified in the NC program.

[Character-string] None

[Code] None

[Measures to Take]

Because the built-in type MOP-TOOL is standard-equipped with a flag communication function, this alarm will not normally occur.

Should it occur, re-create a PBU file for storing built-in type MOP-TOOL parameters.

[Related Specifications] Built-in type MOP-TOOL

★ 5398 **AP file:invalid mode**

This alarm is caused by any of the following errors:

- (1) While neither "0.1 MUm servo control" nor "1/10000deg rotary axis control" is valid, the program includes a block with TPRF.
- (2) When the scroll parameter bit No. 4 "TPRF control axis: C" is set ON, two or more additional axes are present. Or, one additional axis is provided but the rotary axis name for the parameter is not "C".

[Character-string] None

[Code]

- 1-> "0.1 MUm servo control" is not valid.
- 2-> "1/10000deg rotary axis control" is not valid.
- 3-> Two or more additional axes exist.
- 4-> Axis name set at rotary axis parameter is not "C".

[Measures to Take] Specify "C" as the axis name at the rotary axis parameter.

[Related Specifications] Scroll machining function

★ 5399 **AP file:invalid axis**

The <axis designation record> data does not agree with the NC scroll parameter data "X, Z, Y, C axis non-interpolation control".

[Character-string] None

[Code]

- 1-> The <axis designation record> data differs from the data set at the scroll parameter bit No. 1 to 4 <TPRF objective axis designation>.

[Probable Faulty Locations] Faulty AP file or wrong scroll parameter data

[Measures to Take]

Correct the AP file, use an errorless AP file, or change the scroll parameter data.

[Related Specifications] Scroll machining function

★ 5400 **AP file not found**

The specified AP file is not present.

[Character-string] None

[Code]

- 1-> The specified AP file is not found in the memory disk.

Program Example:

Though a program TPRF FN[A. CAP] is specified, the file A. CAP is not stored in the memory disk.

[Measures to Take]

Check if the specified program is stored in the memory disk using the DIR command in program operation mode.

[Related Specifications] Scroll machining function

★ 5401 **AP file stack overflow**

One program contains more than 16 input AP files.

[Character-string] None

[Code]

- 1-> The number of AP files in the program has exceeded the stack capacity of 16.

[Measures to Take] Correct the program.

[Related Specifications] Scroll machining function

**★ 5402 AP data size**

- (3) The <record of positional data size per axis> in the AP data file does not agree with the actual positional data size for each axis.
- (4) The AP data file does not have enough number of parameters.
- (5) The total positional data size has exceeded the maximum value.

[Character-string] None

[Code] YYYYY

X-> Problem axis

1: X-axis

2: Z-axis

4: Y-axis

8: C-axis

YYYY-> Data count number

Positive value:Smaller data size

Negative value:Larger data size

0: Shortage of data for one axis

80000000-> Smaller number of parameters

80000001-> total data points over

[Probable Faulty Locations] The AP data file contains defective data.

[Measures to Take] Re-create an AP file.

[Related Specifications] Scroll machining function

**★ 5403 AP data illegal code**

The AP file contains an illegal code.

[Character-string] None

[Code] None

[Measures to Take] Correct the AP file or specify an errorless AP file.

[Related Specifications] Scroll machining function

**★ 5404 AP data out of range**

During data conversion of AP data file into binary data, a value has exceeded the data setting range.

[Character-string] None

[Code] Out-of-range data (in hexadecimal)

[Measures to Take] Re-set the problem data within its setting range.

[Related Specifications] Scroll machining function

**★ 5405 File operation execute**

[Character-string] None

[Code] None

[Measures to Take]

[Related Specifications] Scroll machining function

**★ 5406 AP file parameter**

The AP data file contains any of the following errors in its main or sub parameter block.

(6) A decimal was specified in the main or sub parameter block.

(7) There is a line only for line feed.

(8) There is an error in designation of OSP type, axis name, or tool position data.

[Character-string] None

[Code]

1-> There is an error in the main or sub parameter block of AP data file.

[Probable Faulty Locations] Main or sub parameter block of the AP data file

[Measures to Take]

Correct the program. Correct the AP file. Or, designate an errorless AP file.

[Related Specifications] Scroll machining function

**★ 5407 AP file:mismatch tool position**

Tool position data in the AP data file does not match the zero offset direction (or tool position) in the work coordinate or local coordinate system.

[Character-string] None

[Code] None

[Measures to Take]

Correct the program. Correct the AP file. Or, designate an errorless AP file.

[Related Specifications] Scroll machining function

**★ 5408 Invalid AP file apoint**

Any of the following errors occurred.

(9) The AP file designation parameter is wrongly described.

(10) The AP file has no extension name.

(11) A TPRF was entered through MDI input without designation (of AP file (FN) (or such designation is omitted).

(12) A TPRF was entered through MDI input though the designated AP file was not loaded in the execution buffer.

(13) The number of AP data points is smaller than the "acceleration deceleration time constant" set at the scroll parameter (word) No. 7.

(14) The number of AP data points for all the axes file after acceleration/deceleration exceeds the maximum number of data points (differs depending on specifications).

[Character-string] None

[Code]

1-> Format error

2-> A TPRF was entered through MDI input though the designated AP file was not loaded in the execution buffer.

Other than the above->Number of AP data points (for all the axes) (in hexadecimal)

[Probable Faulty Locations]

Faulty program or AP file

Program Example:

1. TPRF FN[A.CAP (The symbol "]" is omitted.)

1. TPRF FN[A.MIN] (Defective extension code)

[Measures to Take]

Code 1-> Correct the program according to the description method for designating the file name.

Codes other than Code 1-> Correct the AP file or designate an errorless AP file. Or, change the data set at the scroll parameter No. 7.

[Related Specifications] Scroll machining function

**★ 5409 AP file:creation failure**

A trace data file having the same name exists in the memory disk.

[Character-string] None

[Code] None

[Measures to Take]

Change the AP data file name. Rename or delete the trace data file already stored in the memory disk under the same name.

[Related Specifications] Scroll machining function

★ 5410 **AP file:number of digits**

The number of digits in the <position data> has any of the following errors.

(15) The allowable number of digits (8) is exceeded.

(16) The number of digits lower than the control unit is larger than the number of digits specified by the parameter.

(17) The number of digits lower than the control unit exceeds the allowable number of digits (5).

[Character-string] Erroneous data (in decimal)

[Code] Erroneous line number (in hexadecimal)

[Measures to Take] Correct the data in the line indicated by the code.

[Related Specifications] Scroll machining function

★ 5411 **Load information file not found**

Though loading the parameter setting tool is attempted, the load information file was not found. Or, there was no file that matches the description in the load information file.

[Index] None

[Character-string] Relevant file name

[Code] None

[Probable Faulty Locations] Installation error, production error, specification code error

[Measures to Take]

Reinstall.

Reissue the installation floppy disk.

★ 5412 **Adaptive control or Remote buffer operation**

The operations <sequence search> or <restart> was attempted in adaptive control mode, or <sequence search> was attempted during remote buffer operation. Or, without designation of the running file name, <schedule program select> or <schedule program search> was attempted.

[Character-string] None

[Code] None

★ 5413 **Remote buffer operation**

The FTP function was called during buffer operation.

[Character-string] None

[Code] None

★ 5414 **Max 9999**

[Related Specifications] Tool ID

★ 5415 **Min -9999**

[Related Specifications] Tool ID

★ 5416 **Interlock error**

[Related Specifications] Tool ID



★ 5417 **Nonregistered tool NO.**

[Related Specifications] Tool ID

★ 5418 **User area data**

[Related Specifications] Tool ID

★ 5419 **Tool input NO.**

[Related Specifications] Tool ID

★ 5420 **Initial write**

[Related Specifications] Tool ID

★ 5421 **Tool preparation function**

[Related Specifications] Tool ID

★ 5422 **No such tool**

[Related Specifications] Tool ID

★ 5423 **Operand decode impossible [Y] ? [N] ?**

[Related Specifications] Tool ID

★ 5424 **Tool group input NO.**

[Related Specifications] Tool ID

★ 5425 **Return pot NO. error**

[Related Specifications] Tool ID

★ 5426 **DNC-DT Path name**

Program selection by DNC-DT failed because of faulty file name.

The total characters of device name, path name, and file name exceeds 120.

[Index] None

[Character-string] None

[Code]

1-> Improper file name

2-> Improper filename extension

3-> Over 120 characters

[Probable Faulty Locations] Command line

[Measures to Take] Review the command line.

★ 5427 **DNC-DT Program select**

An alarm occurred during program selection by DNC-DT.

[Index] None

[Character-string] None

[Code]

8000000XX: communication error number

YY: Application error No.

100: Failure of hardware (such as a hard disk)

XX=6F: Small buffer size in TCP/IP driver

XX=72: Faulty descriptor transferred to TCP/IP driver

XX=73: Faulty parameter transferred to TCP/IP driver

- XX=74: No empty port in the shared memory
- XX=75: Unconnected
- XX=7B: Abort command ignored
- XX=7D: "ftp\_ms\_open" abnormal termination
- XX=7E: "ftp\_ms\_close" abnormal termination
- XX=7F: "ftp\_ms\_type" abnormal termination
- XX=80: "ftp\_ms\_user" abnormal termination
- XX=81: "ftp\_ms\_pass" abnormal termination
- XX=82: "ftp\_ms\_acct" abnormal termination
- XX=83: "ftp\_ms\_delete" abnormal termination
- XX=84: "ftp\_ms\_fopen" abnormal termination
- XX=85: "ftp\_ms\_fopen\_uni" abnormal termination
- XX=86: "ftp\_ms\_net\_drecv\_f" abnormal termination
- XX=87: "ftp\_ms\_net\_dsend\_f" abnormal termination
- XX=88: "ftp\_ms\_fclose" abnormal termination
- XX=89: "ftp\_ms\_abort" abnormal termination
- XX=8A: "ftp\_ms\_chdir" abnormal termination
- XX=8D: "ftp\_ms\_pwd" abnormal termination
- XX=8F: "ftp\_ms\_dopen" abnormal termination
- XX=90: "ftp\_ms\_dread" abnormal termination
- XX=91: "ftp\_ms\_dclose" abnormal termination
- XX=97: IP address error
- XX=98: No IP address
- XX=99: Interruption by time out
- XX=9A: Disconnection command from the remote host
- XX=9B: Abnormally terminated initialization of OS (MORE) on TCP/IP board
- XX=9C: Abnormally terminated initialization of packet driver or TCP/IP module on TCP/IP board
- XX=9F: Abnormally terminated initialization of FTP module on TCP/IP board
- XX=A0: Abnormally terminated initialization of socket interface module on TCP/IP board
- XX=A1: Abnormally terminated initialization of TCP/IP board
- YY=13: Incorrect channel number
- YY=16: Wrong parameters for initialization; program not started up; improper program name
- YY=11: Program already started up
- YY=06: Time-out in initialization of TCP/IP board (TCP/IP board inoperable); Device which cannot be renamed; Device of which protect cannot be canceled; Device from which file system information cannot be taken; Unknown (unsupported) command
- YY=0D: Communication board not mounted
- YY=02: Program not found
- YY=08: Execution failed

[Probable Faulty Locations] Application error, faulty file name

[Measures to Take]

Correct the communication hardware, software or program selection method.

**★ 5428 Hard Disk initial**

Initialization of the hard disk was attempted though a program being selected by DNC-DT.

[Index] None

[Character-string] None

[Code]

FF: Program being selected by DNC-DT

100: Failure of hardware (such as a hard disk)

[Probable Faulty Locations]

Defective hardware (hard disk, SCCI board, SCSI cable, power unit)

[Measures to Take]

Check the hardware for cable connection, or replace the defective unit. Select the program without using DNC-DT.

★ 5429 **TCP/IP initial**

An error occurred in initialization after power supply to TCP/IP.

[Index] None

[Character-string] None

[Code] XX

XX=6F: Small buffer size in TCP/IP driver

XX=72: Faulty descriptor transferred to TCP/IP driver

XX=73: Faulty parameter transferred to TCP/IP driver

XX=74: No empty port in the shared memory

XX=9B: Abnormally terminated initialization of OS (MORE) on TCP/IP board

XX=9C: Abnormally terminated initialization of packet driver or TCP/IP module on TCP/IP board

XX=9F: Abnormally terminated initialization of FTP module on TCP/IP board

XX=A0: Abnormally terminated initialization of socket interface module on TCP/IP board

XX=A1: Abnormally terminated initialization of TCP/IP board

[Probable Faulty Locations] Faulty hardware or API software

[Measures to Take]

Replace the ether board (TCP-IP board).

★ 5430 **command data out of range**

The specified data is out of the setting range.

[Character-string] None

[Code]

1-> Zero offset or tool length offset value cannot be set at the horizontal spindle with attachment because the H value is other than H1 to H8.

2-> Zero offset or tool length offset value cannot be set at the horizontal spindle with attachment because the option command is not H or such setting is not permitted by the specification.

[Measures to Take] Enter the offset data in the proper method.

★ 5431 **excessive the number of a tool**

An error caused it by tool list input of a new tool management function and simulation.

[Index] None

[Character-String] None

[Code]

1-> number of a registered tool met the (teapot of number) by tool list input.

2-> A tool could not be arranged in layout arrangement simulation of tool arrangement simulation.

3-> Input of tool list file which could not arrange a tool concerning tool arrangement simulation is reviewed.

[Probable Faulty Locations]

[Measures to Take]

★ 5432 **A number of a tool list file**

The number of a tool list file exceeded 4 pieces by tool list input of a new tool management function and had appointed.

[Index] None

[Character-String] None

[Code] None

[Probable Faulty Locations]

[Measures to Take] They make the number of a tool list file few.

★ 5433 **Interrupt program buffer overflow**

When the power was supplied, the interrupt program file "A.INT" was not loaded into the memory area dedicatedly used for interrupt programs.

[Character-string] None

[Code]

1-> The interrupt program file "A.INT" is larger than 1024 bytes.

[Measures to Take]

- Check the size of the interrupt program file.

★ 5434 **Tool system data direct**

[Character-string] None

[Code]

1-> The specified too kind or number of characters is wrong or invalid.

4-> An attempt was made to change a special tool among the tool numbers already registered in the POT-TOOL NO. TABLE.

[Measures to Take] Enter a correct value.

★ 5435 **Tool name direct**

[Character-string] None

[Code]

1-> Invalid character was used to specify the tool name.

3-> Time-out (10 s) error occurred when the machine did not accept any tool data change command (because it was executing tool change).

4-> "None" is set at the tool number in the setting position.

5-> Tool cannot be registered because a large-diameter tool is set at an adjacent pot.

7-> The specified tool name has been already registered at the other toolpot.

[Measures to Take]

Enter a correct tool name.

Registered a tool number before entering the tool name.

★ 5436 **Tool No. direct**

[Character-string] None

[Code]

1-> The specified tool number has been already registered at the other pot.

3-> Time-out (10 s) error occurred when the machine did not accept any tool data change command (because it was executing tool change).

4-> A wrong tool kind is set.

5-> Tool cannot be registered because a large-diameter tool is set at an adjacent pot.

8-> The specified tool number is larger than the number of tool sets.

9-> The tool name at the set position is not set at "None".

[Measures to Take]

Check the other toolpot number before entering a proper tool number.

Check the entered tool kind.

**★ 5437 Data range over**

In the tool kind list display in tool management data, the specified value exceeds the range of the kind.

[Character-string] None

[Code] Entered value

[Measures to Take] Enter a proper value.

[Related Specifications] Interactive Programming Function C

**★ 5438 Tool kind wrong character**

In the tool management data, the specified character cannot be in the tap name or the blank registration name.

[Character-string] None

[Code] Entered value

[Measures to Take] Enter a proper value.

[Related Specifications] Interactive Programming Function C

**★ 5439 Tool data clear selection**

The deletion range was wrongly specified on the screen for displaying the tool management data list.

[Character-string] None

[Code] None

[Measures to Take] Enter a proper value.

[Related Specifications] Interactive Programming Function C

**★ 5440 Tool data copy selection**

The copying range was wrongly specified on the screen for displaying the tool management data list.

[Character-string] None

[Code] None

[Measures to Take] Enter a proper value.

[Related Specifications] Interactive Programming Function C

**★ 5441 Tool data swap selection**

The swap range was wrongly specified on the screen for displaying the tool management data list.

[Character-string] None

[Code] None

[Measures to Take] Enter a proper value.

[Related Specifications] Interactive Programming Function C

**★ 5442 Work no blank data**

In the tool management data, when the blank material number was selected, the unregistered blank number was selected.

[Character-string] None

[Code] None

[Measures to Take]

Select the blank material set by of parameter set "Processing method data". Or, newly register a blank material.

[Related Specifications] Interactive Programming Function C

★ 5443 **Teaching impossible**

On the command screen for changing cutting conditions, the teaching mode was selected in a mode where such selection is not allowed.

[Code]

1-> During the Super-Hi-NC or Hi cut Pro mode, the teaching mode was selected on the command screen for changing cutting conditions.

[Measures to Take]

Cancel the Super-Hi-NC or Hi cut Pro mode before selecting the teaching mode.

★ 5444 **Super Hi-NC control cannot execute**

The super Hi-NC control mode was selected while the condition is not met.

[Index] None

[Character-string] None

[Code]

200-> Super Hi-NC control mode is selected in the teaching mode.

[Measures to Take]

Turn off the teaching mode before selecting the super Hi-NC control mode.

★ 5445 **Super Hi-NC Controls cannot execute**

When the Hi cutting two controls cannot be done, the execution mode is specified.

[Character-string] None

[Code]

200-> Super Hi cut control was executed in the teaching mode.

[Measures to Take]

Quit the teaching mode before executing the Super Hi cut control.

★ 5446 **Executing of external program select**

Any of the following operation, which disturbs the robot sequence, was attempted during the link mode:

- Program selection
- Schedule program selection
- Sequence stop
- Program search
- Schedule program search
- Restart
- PPC program selection
- Cursor movement

[Character-string] None

[Code] None

★ 5447 **DNC-DT preload error**

DNC-DT preload process was not normally performed.

[Index] None

[Character-string] File name

[Code] XXYYZZ

YYZZ

XX=

- 6F-> Small buffer size in TCP/IP driver
- 72-> Faulty descriptor transferred to TCP/IP driver
- 73-> Faulty parameter transferred to TCP/IP driver
- 74-> No empty port in the shared memory
- 75-> Unconnected
- 7B-> Abort command ignored
- 7D-> `ftp ms open' abnormal termination
- 7E-> `ftp ms close' abnormal termination
- 7F-> `ftp ms type' abnormal termination
- 80-> `ftp ms user' abnormal termination
- 81-> `ftp ms pass' abnormal termination
- 82-> `ftp ms acct' abnormal termination
- 83-> `ftp ms delete' abnormal termination
- 84-> `ftp ms fopen' abnormal termination
- 85-> `ftp ms fopen uni' abnormal termination
- 86-> `ftp ms net drecv f' abnormal termination
- 87-> `ftp ms net dsend f' abnormal termination
- 88-> `ftp ms fclose' abnormal termination
- 89-> `ftp ms abort' abnormal termination
- 8A-> `ftp ms chdir' abnormal termination
- 8D-> `ftp ms pwd' abnormal termination
- 8F-> `ftp ms dopen' abnormal termination
- 90-> `ftp ms dread' abnormal termination
- 91-> `ftp ms dclose' abnormal termination
- 97-> IP address error
- 98-> No IP address
- 99-> Interruption due to time-out
- 9A-> Disconnection command from the remote host
- 9B-> Abnormally terminated initialization of OS (MORE) on TCP/IP board
- 9C-> Abnormally terminated initialization of packet driver or TCP/IP module on TCP/IP board
- 9F-> Abnormally terminated initialization of FTP module on TCP/IP board
- A0-> Abnormally terminated initialization of socket interface module on TCP/IP board
- A1-> Abnormally terminated initialization of TCP/IP board

YY=

- 10-> Preload task started
- 20-> Preload process initialized
- 30-> Preload requested
- 40-> Number of completed preload processes acquired
- 50-> Preload file taken out
- 60-> Number of remaining preload file tables acquired
- 70-> Preload aborted
- 80-> Preload file unlocked
- 90-> Preload requested
- A0-> Preload file unlocked
- B0-> File transfer error

ZZ=

- FF-> Communication error

- 02-> File does not exist.
- 03-> Preload task not started
- 05-> No transferred file
- 08-> Preload process not initialized  
Previous preload process not completed
- 0D-> File protected
- 0E-> Wrong preload task start parameter
- 11-> File present. Preload task already started.
- 13-> Wrong file device name
- 16-> Wrong initialization parameter. Not started up. Wrong program name.

**★ 8201 Input data**

The entered numerical value or character is not within the allowable input data range.

[Measures to Take]

Set a correct value. The tool number can be set within the range from one to the maximum number of tool offset data sets (standard: 50 sets, optional: 100,200,300 sets).

**★ 8202 Registered tool**

(Memory random ATC)

The NC with the memory random ATC regards the spindle (active tool) as one of the magazine pots, and therefore you cannot register two same tools at the pots including the spindle.

The tool you try to register at a magazine pot or as the active tool has been already registered in the POT NO./TOOL NO. TABLE or as an active tool.

(Fixed address ATC)

The NC with the fixed address ATC allows you to register the tool number in the POT NO./TOOL NO. TABLE and register the already registered tool as an active tool or the next tool.

This alarm occurs if you try to register the tool that has been already registered in the POT NO./TOOL NO. TABLE at the other pot.

[Measures to Take]

(Memory random ATC)

Change the tool number to be set. Or, clear the tool number already registered in the POT NO./TOOL NO. TABLE or as an active tool to "None" before setting the tool number again.

(Fixed address ATC)

Change the tool number to be set. Or, clear the tool number already registered in the POT NO./TOOL NO. TABLE to "None" before setting the tool number again.

**★ 8203 Non open pot**

(Memory random ATC)

Another tool is set at the pot you specified. Or, the active tool is a large diameter tool (L) and the pots adjacent to the specified pot should be left empty or equipped with plug tools.

- A large diameter tool (L) cannot be set as an active tool, because the POT NO./TOOL NO. TABLE does not have a pot of which sides are left empty or equipped with a plug tool.
- A large diameter tool (L) cannot be set in the POT NO./TOOL NO. TABLE because the adjacent pots are not set at "None".

(Fixed address ATC)

- A large diameter tool (L) cannot be set in the POT NO./TOOL NO. TABLE because the adjacent pots are not set at "None".
- \* The matrix magazine can accept a large diameter tool as far as one adjacent rack is left empty only when the tool is stored in any of the endmost racks.

[Code]

- 1-> A tool number had already been registered in the specified pot.
- 2-> An empty pot for accepting a large diameter tool (L) is not found.



[Measures to Take]

[Memory random ATC]

Set "None" at the pot number for the specified pot. Or, if the active tool is a large diameter tool (L), set "None" or "Plug tools" at the pots adjacent to the specified pot.

- \* Before setting a large diameter tool (L) as an active tool, set "None" or "Plug tool" at the pots adjacent to the large diameter tool in the POT NO./TOOL NO. TABLE.
- \* When setting a large diameter tool (L) in the POT NO./TOOL NO. TABLE, set "None" at the pots adjacent to the large diameter tool.

[Fixed address ATC]

When setting a large diameter tool (L) in the POT NO./TOOL NO. TABLE, set "None" at the pots adjacent to the pot that stores the large diameter tool.

**★ 8204 Nonregistered tool**

(Memory random ATC)

When setting the next tool, you tried to set a tool number not registered in the POT NO./TOOL NO. TABLE.

[Fixed address ATC]

When setting an active tool or the next tool, you tried to set a tool number not registered in the POT NO./TOOL NO. TABLE.

[Measures to Take]

(Memory random ATC)

Set the next tool with a tool number registered in the POT NO./TOOL NO. TABLE.

(Fixed address ATC)

Set an active tool or the next tool with a tool number registered in the POT NO./TOOL NO. TABLE.

**★ 8205 Pot command exist**

(Memory random ATC)

A value has been already set at the pot you selected for the next tool.

[Measures to Take]

(Memory random ATC)

Clear the specified pot to "None" before setting the next tool.

**★ 8206 Next tool command exist**

(Memory random ATC)

The next tool had been already set at the pot you tried to set the tool number.

[Measures to Take]

(Memory random ATC)

Clear the next tool to "None" before setting the tool number.

**★ 8207 Registered tool none**

The tool specified using the tool number search function is not found in the POT NO./TOOL NO. TABLE.

[Measures to Take] Check if the specified tool number is correct.

**★ 8208 Can not clear tool No.**

When the tool is set in the POT NO./TOOL NO. TABLE, either of the pots adjacent to the pot to be set is a large diameter tool (L).

[Measures to Take]

Find a usable new pot, or delete the setting of the large diameter tool (L) if such setting is not necessary before setting the pot again.

★ 8209 **Tool set**

When tool setting (F2) is executed, more than one tool is set in POT NO./TOOL NO. TABLE.

[Measures to Take]

Clear the registered tool to "None" in the POT NO./TOOL NO. TABLE. Or, clear all the tool pots to "None" by tool cancellation (F1) before retrying tool setting.

★ 8210 **Parameter interlock**

You cannot set the tool data while ATC, APC or AAC is in cycle operation or the magazine, the carrier or the sifter is operating. If set, the machine may cause malfunction.

[Measures to Take] Set the tool data while none of the above equipment is operating.

★ 8211 **Can not set Next tool No.**

The next tool can be set only when the ATC is in the position of sequence number "1" without performing ATC cycle.

[Measures to Take] Set the next tool after satisfying the above conditions.

★ 8212 **Can not set Active tool No.**

The active tool can be set only when the ATC is in the position of sequence number "1" or waiting for machine cycle completion without performing ATC cycle.

[Measures to Take] Set the active tool after satisfying the above conditions.

★ 8213 **Can not set return tool No.**

The return tool can be set only when the ATC is in the position of waiting for machine cycle completion without performing ATC cycle.

[Measures to Take] Set the return tool after satisfying the above conditions.

★ 8214 **Max tool Number**

The entered number of tool is over the maximum number of tool.

★ 8215 **Tool mount impossible**

(Matrix magazine)

You tried to set a tool at the pot located in the manual tool change position of the matrix magazine.

[Measures to Take]

(Matrix magazine)

You can clear the tool set at the pot in the manual tool change position but cannot set a tool in that pot.

Table 1 Factor Classification Code/Factor Parameter

Factor Classification Code (XX)	Factor Parameter (YY)
03 ..... ]	00
04 ..... EOR	00
06 ..... OR	00
08 ..... AND	00
0A ..... NOT	00
0C ..... Relative operation	01 ..... LT    02 ..... LE    03 ..... EQ 04 ..... NE    05 ..... GT    06 ..... GE
0E .....	00
10 ..... Adding/subtracting operator	01 ..... +    02 ..... -
11 ..... Multiplying/dividing operator	01 ..... *    02 ..... /
18 ..... Function operator	01 ..... SIN    02 ..... COS    03 ..... TAN    04 ..... ATAN 05 ..... ATAN2    06 ..... SQRT    07 ..... ABS 08 ..... BIN    09 ..... BCD    0A ..... ROUND 0B ..... FIX    0C ..... FUP    0D ..... DROUND 0E ..... DFIX    0F ..... DFUP    10 ..... MOD
1A ..... [	00
1C ..... =	00
22 ..... Numerical value	00 - 07    Position of decimal point

Table 2 FDC Result Status

Result Status 0 (ST0)

Bit No.	Status Name	Abbreviation	Contents																		
D7	Interrupt Code	IC	Indicates the cause of generating INT request: <table border="1" style="margin-left: 20px;"> <thead> <tr> <th>D7</th> <th>D8</th> <th>Causes</th> </tr> </thead> <tbody> <tr> <td>0</td> <td>0</td> <td>Normal termination of command (NT)</td> </tr> <tr> <td>0</td> <td>1</td> <td>Abnormal termination of command (AT)</td> </tr> <tr> <td>1</td> <td>0</td> <td>The command read is invalid.</td> </tr> <tr> <td></td> <td></td> <td>Command not executed (IC)</td> </tr> <tr> <td>1</td> <td>1</td> <td>Device status changed (AI)</td> </tr> </tbody> </table>	D7	D8	Causes	0	0	Normal termination of command (NT)	0	1	Abnormal termination of command (AT)	1	0	The command read is invalid.			Command not executed (IC)	1	1	Device status changed (AI)
D7				D8	Causes																
0	0	Normal termination of command (NT)																			
0	1	Abnormal termination of command (AT)																			
1	0	The command read is invalid.																			
		Command not executed (IC)																			
1	1	Device status changed (AI)																			
D6																					
D5	Seek End	SE	The bit data is set when the seek processing invoked by SEEK or RECALIBRATE command has terminated (normally or abnormally).																		
D4	Equipment Check	EC	The bit data is set when the fault signal is received from the device, or the track 0 signal has not been detected within a preset cycle time in response to the RECALIBRATE command.																		
D3	Not Ready	NR	The bit data is set when the device designated is not in the ready state.																		
D2	Head Address	HD	This indicates the head status when the INT is requested. The bit data is always "0" when the SENSE INTERRUPT STATUS command is executed.																		
D1	Unit Select 1	US1	This indicates the device number when the INT request is made.																		
D0	Unit Select 0	US0																			

Abbreviation:

NT: Normal Terminate

IC: Invalid Command

AT: Abnormal Terminate

AI: Attention Interrupt

Result Status 1 (ST1)

Bit No.	Status Name	Abbreviation	Contents
D7	End of Cylinder	EN	The bit data is set when an attempt is made to continue access exceeding the designated final sector.
D5	Data Error	DE	The bit data is set if the CRC error is detected when the ID or data on a floppy disk is read. Distinction between ID and data is made with the DD bit at ST2.
D4	Over Run	OR	The bit data is set when the main system service does not complete with a preset cycle time during the processing of data in a sector.
D2	No Data	ND	<ol style="list-style-type: none"> <li>The bit data is set when the sector designated by the IDR is not detected on the track during the execution of the following four commands:  <p style="text-align: center;">READ DATA, WRITE DATA, WRITE DELETED DATA, SCAN</p> </li> <li>The bit data is set when the ID free of error is not detected on the track during the execution of READ ID command.</li> <li>The bit data is set when the contents of sector ID and IDR do not agree each other during execution of the READ DIAGNOSTIC command.</li> </ol>
D1	Not Writable	NW	The bit data is set when the write-disable condition is detected during execution of the WRITE DATA, WRITE DELETED DATA and WRITE ID commands.
D0	Missing Address Mark	MA	<ol style="list-style-type: none"> <li>The bit data is set when the AM (Address Mark) is not detected before the IM (Index Mark) is detected twice by the command to access the disk ID.</li> <li>The bit data is set when the DAM or DDAM is not detected when reading the disk data. The MD bit of ST2 is also set.</li> </ol>

Remark: D3 and D6 are not used and are always set to "0".

Result Status 2 (ST2)

Bit No.	Status Name	Abbreviation	Contents
D6	Control Mark	CM	The bit data is set when the data of the sector containing DDAM is processed during execution of a READ DATA or SCAN command.
D5	Data Error in Data Field	DD	The bit data is set when the CRC error is detected during reading of the disk data.
D4	No Cylinder	NC	This is the status attributing to the ND bit of ST1. The bit data is set when the C bytes of the ID do not match.
D3	Scan Equal Hit	SH	The bit data is set when the equal conditions in the SCAN command are satisfied.
D2	Scan Not Satisfied	SN	The bit details set when the data meeting the condition are not detected after the completion of scanning, by the SCAN command, up to the final sector.
D1	Bad Cylinder	BC	This is the status attributing to the ND bit of ST1. The bit data is set when the C bytes of the ID do not match with the C bytes being FF (16).
D0	Missing Address Mark in Data Field	MD	The bit data is set if the DAM or DDAM is not detected when reading the disk data.

Remark: D7 is not used and is always set to "0".

Result Status 3 (ST3)

Bit No.	Status Name	Abbreviation	Contents
D7	Fault	FT	Status of Fault signal from the device
D6	Write Protected	WP	Status of Write Protect signal from the device
D5	Ready	RY	Status of Ready signal from the device
D4	Track 0	T0	Status of Track 0 signal from the device
D3	Two Side	TS	Status of Two Side signal from the device
D2	Head Address	HD	Status of Side Select signal from the device
D1	Unit Select 1	US1	Status of Unit Select 1 signal from the device
D0	Unit Select 0	US0	Status of Unit Select 0 signal from the device

Table 4 DMA Error Status

DMA Error Status (Memory Disk)

Bit No.	Status Name	Contents
15	S/D	1: When the DMA accessed the source address, an error occurred. 0: When the DMA accessed the destination address, an error occurred.
14	0	Fixed to 0.
13	COE	1: Count error When TC [Transfer Counter] was "0", "1" was written in STR [bit 7 of CR (Control Register)]. 0: No error
12	ADE	1: Address error The DMA accessed the I/O address space of the memory board. 0: No error
11	TME (a)	1: Operation timing error (a) When data was set at COC or ERR bit, "1" was written in STR bit. 0: No error
10	TME (b)	1: Operation timing error (b) When data was set at STR or ACT bit, the master wrote data in the DMA register. 0: No error
9	0	Fixed to 0.
8	AOF	1: Address overflow error Transfer is not completed although the address has changed from \$FFFFFFFC to \$00000000. 0: No error
7	ENF STOP	1: Forced termination (error) Since READY flag (BOARD STR bit7) was changed to "0" during data transfer, the DMA forcibly terminated its operation. * SAVE-N has dropped to L. * The power monitor circuit has detected an abnormal voltage. 0: No error
6	DPRT ERR	1: Protect error The DMA accessed an area having no memory in the board. The DMA wrote data in the flash memory. The DMA accessed the flash memory in programming mode. 0: No error
5	DECC2 ERR	1: ECC double-bit error When the DMA accessed the memory in the board, double- or multiple-bit error occurred. 0: No error

Table 4 DMA Error Status

DMA Error Status (Memory Disk)

Bit No.	Status Name	Contents
4	DECC1 ERR	1: ECC single-bit error The DMA accessed the memory in the board, single-bit error occurred. 0: No error cf. Even with occurrence of single-bit error, the DMA continues data transmission without stopping its operation. This bit is merely turned ON.
3	PORT ERR	1: Port size error When the DMA became a bus master and accessed the system bus, the slave's port size was 16 bits/8 bits. 0: No error
2	CYO ERR	1: Cycle over error When the DMA became a bus master and accessed the system bus, a cycle over error occurred. (Detection time: approx. 16 $\mu$ s) 0: No error
1	SLV ERR	1: System bus error When the DMA became a bus master and accessed the system bus, the slave returned SEBR-N, resulting in a bus error. 0: No error
0	SB PAR	1: System data parity error When the DMA became a bus master and read data from the system bus, a parity error was detected on the data received from the bus slave. 0: No error



DMA Error Status (Floppy Disk)

Bit No.	Status Name	Contents
15	COE	1: Count error Although "0" was set at MTC (DMA control bit 14 to 0), "1" was written at STR. 0: No error
14	ADE	1: Address error The DMA became a bus master and accessed the address space on the FRP board. 0: No error
13	TME (a)	1: Operation timing error (a) When data is set at COC, ACT or ERR bit, "1" was written at STR bit. 0: No error
12	TME (b)	1: Operation timing error (b) When data is set at STR or ACT, the master wrote data in a register in the DMA; i.e., DMA control, DMAUMA or DMALMA. 0: No error
11	TME (c)	1: Operation timing error (c) When ATC and STR bits are both "0", request-to-send was input from the FDC. 0: No error
10	AOF	1: Address overflow error Transfer is not completed although the address has changed from FFFFFFFFE to 00000000. 0: No error
9~3	Not used	Not used. During data reading, these bits are fixed to "0".
2	CYO	1: When the DMA became a bus master and accessed the system bus, a cycle over error occurred. (Detection time: approx. 8 MUs) 0: No error
1	SLV ERR	1: When the DMA became a bus master and accessed the system bus, the (read/write) slave returned SEBR-N, resulting in a bus error. 0: No error
0	SB PAR	1: When the DMA became a bus master and read the system bus, a parity error was detected in the data received from the slave, resulting in a bus error. 0: No error

## LIST OF PUBLICATIONS

Publication No.	Date	Edition
4187-E	May 1998	1st
4187-E-R1	November 2000	2nd
4187-E-R2	October 2002	3rd

This manual may be at variance with the actual product due to specification or design changes.

Please also note that specifications are subject to change without notice.

If you require clarification or further explanation of any point in this manual, please contact your OKUMA representative.