



GE Fanuc Automation

Computer Numerical Control Products

AC Servo Amplifier

Maintenance Manual

GFZ-65005E/07

August 1992

Warnings, Cautions, and Notes as Used in this Publication

Warning

Warning notices are used in this publication to emphasize that hazardous voltages, currents, temperatures, or other conditions that could cause personal injury exist in this equipment or may be associated with its use.

In situations where inattention could cause either personal injury or damage to equipment, a Warning notice is used.

Caution

Caution notices are used where equipment might be damaged if care is not taken.

Note

Notes merely call attention to information that is especially significant to understanding and operating the equipment.

This document is based on information available at the time of its publication. While efforts have been made to be accurate, the information contained herein does not purport to cover all details or variations in hardware or software, nor to provide for every possible contingency in connection with installation, operation, or maintenance. Features may be described herein which are not present in all hardware and software systems. GE Fanuc Automation assumes no obligation of notice to holders of this document with respect to changes subsequently made.

GE Fanuc Automation makes no representation or warranty, expressed, implied, or statutory with respect to, and assumes no responsibility for the accuracy, completeness, sufficiency, or usefulness of the information contained herein. No warranties of merchantability or fitness for purpose shall apply.

PREFACE

This manual describes the troubleshooting, adjustment and setting method related to the servo amplifier and servo controller in NC equipment employing a digital AC servo system.

The models covered by this manual, and their abbreviations are:

AC SERVO AMPLIFIER

Names	TYPE OF AMPLIFIER
FANUC AC SERVO AMPLIFIER C series (200V input type)	1-axis and 2-axis amplifiers
FANUC AC SERVO AMPLIFIER S series (200V input type)	1-axis, 2-axis, and 3-axis amplifiers
	Large amplifier
FANUC AC SERVO AMPLIFIER L series	1-axis amplifier
FANUC AC SERVO AMPLIFIER S series (185V input type)	1-axis, 2-axis, and 3-axis amplifiers

DIGITAL SERVO ROM

Series	Latest edition	Use	Name
9000 9001	S N	General	Series 10, 11, 12, 0-A
9002	I	High-speed positioning	Series 0-PA
9010	G	General	Series 10, 11, 12, 0-B
9020	L	General	Series 10, 11, 12, 0-B, 0-C (16 bit)
9022	D	High-speed positioning	Series 0-PB, 0-PC (16 bit)
9030	N	General	Series 15, 0-C (32 bit)
9032	C	High-speed positioning	Series 0-PC (32 bit)
9039	A	Automatic adjustment	Series 15, 0-C (32 bit)
9040	C	Serial pulse coder	Series 15, 0-C (32 bit)

The 9050 series digital servo ROM chips for Series 16 are described in Part III of this manual.

CONTENTS

I. AC SERVO AMPLIFIER

1. GENERAL	1 - 1
2. CONFIGURATION	1 - 2
3. STARTING UP DIGITAL SERVO	1 - 3
3.1 Initializing Digital Servo Motor Parameters	1 - 3
3.1.1 Setting procedure on servo menu	1 - 4
3.2 Setting Series 0 Digital Servo Parameters	1 - 6
3.2.1 Initialization flowchart when standard pulse coder is used	1 - 7
3.2.2 Initialization flowchart when high-resolution pulse coder is used	1 - 8
3.2.3 Initialization flowchart when 1- μ m control is applied with a 10000-pulse pulse coder	1 - 10
3.2.4 Initialization flowchart when serial pulse coder A or B is used	1 - 11
3.2.5 Initialization flowchart when serial pulse coder C is used	1 - 13
3.3 Setting Series 15 Digital Servo Parameters	1 - 14
3.3.1 Initialization flowchart when standard pulse coder is used	1 - 15
3.3.2 Initialization flowchart when high-resolution pulse coder is used	1 - 16
3.3.3 Initialization flowchart when 1- μ m control is applied with a 10000-pulse pulse coder	1 - 18
3.3.4 Initialization flowchart when serial pulse coder A or B is used	1 - 19
3.3.5 Initialization flowchart when serial pulse coder C is used	1 - 21
3.4 Information Required to Set Digital Servo Parameter	1 - 22
3.4.1 AMR parameter setting	1 - 22
3.4.2 CMR, DMR, and reference counter setting	1 - 24
3.4.3 Setting the flexible feed gear function	1 - 29
3.4.4 Servo software (series 9040) for serial pulse coder	1 - 34
3.4.5 Motor type numbers	1 - 36
4. AC SERVO AMPLIFIER MAINTENANCE	1 - 45
4.1 Types and Configurations of Servo Amplifiers	1 - 45
4.2 Maintenance Parts Location on PCBs	1 - 52
4.3 Servo Amplifier State Indication	1 - 70
4.3.1 S series servo amplifiers	1 - 70
4.3.2 C series servo amplifiers	1 - 71
4.4 Check Terminals	1 - 74
4.4.1 S series servo amplifiers	1 - 74
4.4.2 C series servo amplifiers	1 - 75
4.4.3 Motor current	1 - 76
4.5 Setting Terminals for Printed Circuit Boards	1 - 78
4.5.1 Setting terminals for S series servo amplifiers	1 - 78
4.5.2 Setting terminals for C series servo amplifiers	1 - 78
4.6 Amplifier Interchangeability	1 - 79
4.6.1 S series 2-axis amplifier interchangeability	1 - 79
4.6.2 S series 3-axis amplifier interchangeability	1 - 80

4.7	Connection of the Discharge Unit	1 - 81
4.8	Kinds of Separate Type Electric Discharge Unit	1 - 84
4.9	When One or More Axes are not Used in a Two-Axis or Three-Axis Amplifier ..	1 - 85
4.10	Leakage Current	1 - 86
4.10.1	Leakage current and selection of the ground fault interrupter	1 - 86
4.10.2	Measuring the leakage current when the AC servo motor series S is operating	1 - 88
5.	AC SERVO MOTOR MAINTENANCE	1 - 91
5.1	AC Servo Motor Maintenance	1 - 91
5.1.1	Acceptance and storage of AC servo motor	1 - 91
5.1.2	Mounting AC servo motor	1 - 91
5.1.3	Replacement of pulse coder	1 - 93
5.2	Connecting the Phase C Signal for a Separately Installed Pulse Coder (Only for Series 0)	1 - 95
6.	CHECK BOARDS	1 - 96
6.1	Configuration	1 - 96
6.2	Types of Unit and Designated Specifications	1 - 97
6.3	Checkboard Connections	1 - 98
6.4	Output Signal	1 - 99
6.5	Digital Servo Block Diagram	1 - 100
6.6	VCMD Signal	1 - 100
6.7	TCMD Signal	1 - 105
6.8	TSA Signal	1 - 106
6.9	Reference Data for the Check Board	1 - 109
6.9.1	Old checkboard (A16B-1600-0210) output signal	1 - 109
6.9.2	Old ROM version number output signal	1 - 111
6.9.3	Socket exchange periods	1 - 112
7.	TROUBLESHOOTING DIGITAL SERVO DEVICES	1 - 113
7.1	Digital Servo Alarms	1 - 113
7.2	Classification of Error Messages	1 - 116
7.2.1	Error messages of Series 0	1 - 116
7.2.2	Error messages of Series 15 (including Series 10, 11 and 12)	1 - 117
7.3	Alarms Detected by Servo Software	1 - 120
7.3.1	Troubleshooting for the OFAL (overflow) alarm	1 - 120
7.3.2	Troubleshooting for the FBAL (disconnection) alarm	1 - 120
7.3.3	Troubleshooting for the OVC (overload) alarm	1 - 125
7.3.4	Reference data on alarms	1 - 128
7.4	Alarms Detected in the Servo Amplifier	1 - 135
7.4.1	Troubleshooting for the DCAI alarm	1 - 136
7.4.2	Troubleshooting for the HVAL alarm	1 - 138
7.4.3	Troubleshooting for the HVAL alarm	1 - 139
7.4.4	Troubleshooting for the LV alarm	1 - 141
7.4.5	Troubleshooting for the OVL alarm	1 - 142
7.4.6	Troubleshooting for the MCC alarm	1 - 144
7.5	Servo-Related Alarms Detected by the NC	1 - 145
7.5.1	Alarm for incorrect servo parameter setting	1 - 145

7.5.2	Function for enlarging the position gain setting range	1 - 149
7.5.3	Excessive positional deviation	1 - 150
7.5.4	APC alarm	1 - 153
7.6	Alarms of the Serial Pulse Coder	1 - 154
8.	DIGITAL SERVO ADJUSTMENT PROCEDURE	1 - 156
8.1	Configuration of Digital Servo Parameters	1 - 156
8.1.1	Symbols, parameter Nos., and rank of digital servo parameters	1 - 156
8.1.2	Block diagram of digital servo parameters	1 - 160
8.1.3	Digital servo adjustment using the servo adjustment screen	1 - 161
8.2	Parameter Adjustment for Each Fault	1 - 166
8.2.1	Vibration during motor stop	1 - 166
8.2.2	Hunting during movement	1 - 166
8.2.3	Non-coincident positioning error	1 - 167
8.2.4	Overshoot during stop	1 - 167
8.2.5	Erratic movement	1 - 167
8.2.6	Slow response	1 - 167
8.2.7	Disconnection alarm malfunctions due to large backlash in a fully closed loop system	1 - 168
8.2.8	Quadrant protrusion	1 - 168
8.2.9	Bad cut surface	1 - 168
8.2.10	Dispersed positioning	1 - 168
8.2.11	Unusual should in rapid traverse	1 - 169
8.2.12	Vibration cause by low gain due to long ball screw	1 - 169
8.2.13	Vibration when stop due to large backlash	1 - 169
8.2.14	Gain is low because load inertia is much larger than torque of motor	1 - 170
8.2.15	Bad cutting shape due to high cutting resistance	1 - 170
8.3	Adjustment Procedure for Vibration	1 - 171
8.3.1	Vibration during stop	1 - 171
8.3.2	Vibration in low-speed feed	1 - 173
8.3.3	Vibration in rapid traverse	1 - 175
8.3.4	Vibration at specified frequency	1 - 179
8.3.5	Vibration only during deceleration	1 - 181
8.3.6	Vibration occurs after move command entry, but not after energization only	1 - 182
8.4	Adjustment Procedure for Drift (Erratic Movement)	1 - 184
8.4.1	Drift during stop state	1 - 184
8.4.2	Drift low speed feed	1 - 186
8.4.3	Drift in rapid traverse acceleration/deceleration	1 - 187
8.5	Adjustment Procedure for Overshoot	1 - 188
8.5.1	Overshoot in 1-pulse feed and 10-pulse feed	1 - 188
8.5.2	Overshoot at rapid traverse or cutting positioning	1 - 191
8.5.3	Overshoot in positioning with manual pulses when the backlash acceleration function is used	1 - 192
8.5.4	Overshoot when feedforward is applied	1 - 193
8.6	Adjustment Procedure for Erratic Movement	1 - 195

8.6.1	Erratic movement in 1-pulse feed	1 - 195
8.7	Adjustment Procedure for Cut Surface	1 - 197
8.7.1	Cut surface occurring only with two-axis linear feed	1 - 197
8.7.2	Cut surface occurring even with single-axis feed	1 - 201
8.8	Procedure for Adjusting the Position	1 - 208
8.8.1	When the positioning error is not 0 when stopping	1 - 208
8.8.2	When there is a difference in backlash between rapid traverse and cutting feed	1 - 209
8.8.3	Poor repetition precision	1 - 211
8.9	Servo Positioning Error, Movement Distance, and Error in Shape	1 - 212
8.9.1	When the servo positioning error differs from the calculated value	1 - 212
8.9.2	Incorrect movement distance	1 - 214
8.9.3	When the circular shape is distorted	1 - 215
8.9.4	When quadrant protrusions are produced	1 - 217
8.9.5	When one motor starts later than the other during straight 2-axis cutting	1 - 218
8.9.6	Incorrect corner shapes	1 - 220
8.9.7	Feed forward	1 - 221
8.10	Adjustment Procedure for Eliminating Current Loop Problems	1 - 222
8.10.1	Current vibration	1 - 222
8.10.2	Insufficient torque in the high-speed area	1 - 223
8.10.3	Current distortion observed when the load increases	1 - 225
8.10.4	Excessive current value, or heated motor	1 - 226
8.10.5	Large difference observed in the high-speed area between the value in the torque command and the actual current	1 - 227
8.10.6	Current distorted only at deceleration	1 - 228
8.11	Return to Reference Position	1 - 230
8.11.1	When the origin is shifted or varies at return to reference position	1 - 230
8.11.2	When the absolute value pulse coder is used and the origin varies	1 - 232
8.11.3	When the origin varies in the fully-closed system	1 - 233
8.11.4	When the origin has shifted by one grid point	1 - 234
8.11.5	When the origin varies by several pulses	1 - 235

II. DIGITAL SERVO SOFTWARE

1.	SERVO PARAMETERS	2 - 1
1.1	Details of Parameters	2 - 1
1.1.1	Symbols, addresses, and setting ranks of the digital servo parameters	2 - 1
1.1.2	Parameter description	2 - 4
1.2	Setting Method and Characters of the Velocity Loop Control Cycle 1 msec	2 - 38
1.3	Parameters Changed in Series 0-C	2 - 41
1.4	Parameters to be Changed in Series 15	2 - 46
2.	SERVO FUNCTIONS	2 - 49
2.1	Servo Functions According to Software Versions	2 - 49
2.1.1	Servo functions according to software versions	2 - 49

2.1.2	Digital servo ROM for Power Mate	2 - 52
2.2	Functions for Suppressing Vibration at Machine Stop	2 - 54
2.2.1	Compensation torque command function	2 - 54
2.2.2	One-pulse suppression function	2 - 55
2.2.3	One-pulse suppression function for serial pulse coder A or B	2 - 56
2.3	Machine-resonance Suppression Function	2 - 57
2.3.1	Acceleration feedback function	2 - 57
2.3.2	Machine speed feedback function	2 - 60
2.3.3	Observer and torque command filter	2 - 61
2.3.4	Disturbance-estimation observer	2 - 65
2.3.5	Dual position feedback function	2 - 66
2.4	Overshoot Prevent Function	2 - 69
2.4.1	Overshoot compensation	2 - 69
2.4.2	PK3V value, the time constant of the integrator reduction, and the saturated value of the torque command	2 - 74
2.5	Shape-error Suppression Function	2 - 77
2.5.1	Feed-forward setting	2 - 77
2.5.2	Backlash compensation, acceleration function	2 - 82
2.5.3	New backlash acceleration function	2 - 86
2.6	Erratic-movement-prevention Function (VCMD Offset Function)	2 - 88
2.7	Automatic Digital Servo Velocity Loop Gain Adjustment Function	2 - 90
2.8	Current Loop Function	2 - 97
2.8.1	Current loop gain	2 - 97
2.8.2	Torque limit (current limit)	2 - 98
2.8.3	Current loop function for high motor output at high-speed rotation	2 - 99
2.8.4	Parameters for dead zone correction of current	2 - 103
2.8.5	Variable phase advancement compensation function for deceleration	2 - 105
2.9	Position Loop and Velocity Loop Functions	2 - 106
2.9.1	Characteristics of the Position Loop and Velocity Loop	2 - 106
2.9.2	Setting the Load Inertia Ratio (LDINT)	2 - 115
2.10	Return to Reference Position	2 - 116
2.11	Servo Software for High-speed Positioning Machine (Punch Press, PC Board Drilling Machine, etc.)	2 - 120
2.11.1	Special function	2 - 126
2.11.2	High-speed positioning function	2 - 128
2.11.3	Method of adjustment	2 - 129
2.11.4	Servo parameter setting for combined punch press and laser machine tools	2 - 131
2.12	Types of Scales	2 - 132
2.13	Difference due to the Sliding Surface and the Guide Types	2 - 134
2.14	Machine Elements Used in Machine Tool	2 - 138
2.15	Resonant Frequency of Ball Screws	2 - 144

III. SERIES 9050 DIGITAL SERVO SOFTWARE FOR Series 16

1. SPECIFICATIONS	3 - 1
-------------------	-------

2. SETTING PARAMETER	3 - 3
3. ADJUSTING PARAMETERS	3 - 8
4. ANALYZING ALARM CAUSES	3 - 10
5. CHECK BOARD	3 - 14
6. PARAMETERS	3 - 17
7. FUNCTIONS FOR Series 16	3 - 42
7.1 250- μ s Acceleration Feedback Function	3 - 42
7.2 Simplifying the Parameter Setting Method	3 - 43
7.3 High-Speed Positioning Functions	3 - 44
7.4 Advanced Feed-Forward Function	3 - 45
7.5 Nonlinear Control Function	3 - 47
8. TABLES OF STANDARD DIGITAL SERVO PARAMETERS	3 - 49

I. AC SERVO AMPLIFIER

1. GENERAL

This manual describes the troubleshooting, adjustment and setting method related to the servo amplifier and servo controller in NC equipment employing a digital AC servo system.

2. CONFIGURATION

The digital AC servo consists of the following.

The position command data from the NC machining program, for example, is processed by the NC controller, which turns it into position command data for each axis. The position command data of each axis is transmitted to a high-performance microprocessor mounted within the NC controller. In this microprocessor, the position, velocity and current are all controlled on the basis of this data, and it outputs a PWM control signal.

The PWM control signal is fed to a separate servo amplifier, which amplifies this PWM control signal to the required power level for the AC servo motor.

The motor driving current from the servo amplifier, and the motor position data and velocity data passes from the pulse coder, are both fed back to the NC controller.

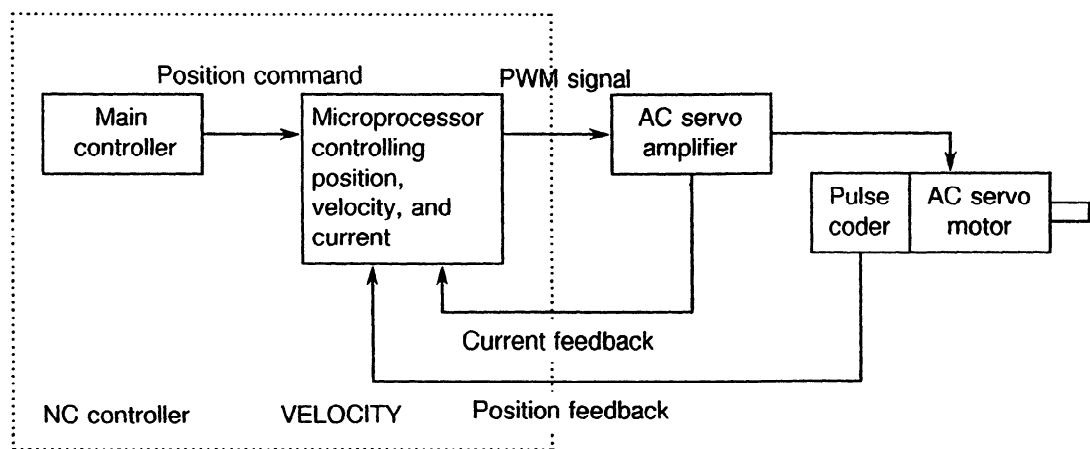

Fig. 2 Configuration of Digital AC servo

(Note) In this manual, X appearing in a Series 0 servo parameter number represents the axis number as follows:

First axis	X = 1
}	
Fourth axis	X = 4

3. STARTING UP DIGITAL SERVO

This chapter explains how to set the digital servo parameters used to start up the digital servo. Be sure to set 0 in the parameters whose setting procedures are not specified here.

During parameter setting, an alarm may request that the power be turned off, however, continue setting without turning off power until all parameters are set.

When setting the parameters, keep the system in the emergency stop state. In the excitation state, setting values on the menu can be updated, but the internal data cannot be updated; the parameters are not actually updated.

Before setting a closed loop system (using a separate position detector), the user should check the operation of the machine in a semi-closed loop system (using the pulse coder on the motor).

3.1 Initializing Digital Servo Motor Parameters

Set the servo parameters after connecting the NC system, motor, and servo unit. The method of servo parameter setting depends on the series of NC system and the type of pulse coder. Follow the flowchart shown below.

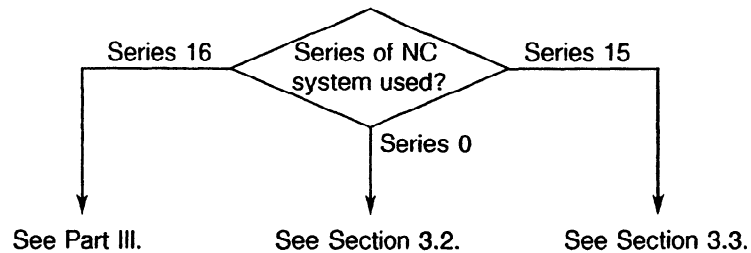

Among the setting flowcharts covered by Section 3.2 and Section 3.3, the setting procedures listed below are detailed separately in Section 3.4. See Section 3.4 as required.

- (1) AMR setting
- (2) CMR, DMR, and reference counter setting
- (3) Setting of the flexible feed gear function
- (4) Servo software for serial pulse coders (See Sections 3.2 and 3.3 for the setting flowcharts.)
- (5) Motor type numbers

When a servo menu is provided on the service menu or parameter menu of the NC, setting can be facilitated by using the servo menu. When using the servo menu, see Section 3.1.1.

3.1.1 Setting procedure on servo menu

The servo menu facilitates digital servo parameter setting. This menu also provides diagnostic information.

The servo menu is provided on the parameter menu or service menu. It consists of a servo setting menu and servo adjustment menu. (A servo menu may not be provided, depending on the NC system, and NC software series and edition.)

(1) Servo setting menu

The servo setting menu is used for servo parameter setting. According to the setting flowchart for each parameter, desired values are to be set in sequence on this menu.

Servo set	01000	N0000
	X axis	Z axis
INITIAL SET BITS	00000011	00000010
Motor ID No.	47	47
AMR	00001001	00011111
CMR	2	2
Feed gear N	1	0
(N/M) M	5	0
Direction Set	111	111
Velocity Pulse No	4000	8000
Position Pulse No	4000	8000
Ref. counter	8000	8000
(Value SETTING)		

Fig. 3.1.1 (a) Example of setting on servo setting menu

INITIAL SET BITS	[Series 0]	[Series 15]
Bit initially set	: No.8X00	No.1804
Motor ID No.	: No.8X20	No.1874
AMR	: No.8X01	No.1806
CMR	: No.100 to 103	No.1820
Feed gear N	: No.8X84	No.1977
(N/M) M	: No.8X85	No.1978
Direction SET	: No.8X22	No.1879
Velocity pulse No.	: No.8X23	No.1876
Position pulse No.	: No.8X24	No.1891
Ref. counter	: No.570 to 573	No.1896

3. STARTING UP DIGITAL SERVO

(2) Servo adjustment menu

The servo adjustment menu is used for servo parameter adjustment and alarm cause analysis. This menu is also used for the automatic digital servo adjustment function (using a dedicated 9039 series ROM). See Section 8.1.3 for detailed information about the servo adjustment menu.

Servo adjustment		01000 N0000	
X axis			
Func bit	00000000	Alarm 1	00000000
Loop gain	3000	Alarm 2	00000000
TUNING ST.	0	Alarm 3	00000000
Set period	0	Alarm 4	00000000
Int gain	113	Loop gain	3000
Prop gain	-1015	Pos error deviation	4444
Filter	0	Current (%)	5
Veloc gain	100	Speed (rpm)	1000
(Value SETTING)			

Fig. 3.1.1 (b) Example of setting on servo adjustment menu

	[Series 0]	[Series 15]
Func. bit	: No.8X03	No.1808
Loop gain	: No.517	No.1825
TUNING ST.	: No.8X09 bit1	No.1953 bit 1
Set period	: No.8X79	No.1972
Int. gain	: No.8X43	No.1855
Prop. gain	: No.8X44	No.1856
Filter	: No.8X67	No.1895
Veloc gain	: Load inertia ratio is indicated by percentage. For motor unit, 100% is indicated.	
	No.8X21	No.1875
Alarm 1	DGN : No.720 to 723	No.3014 + 20 × (X-1)
Alarm 2	DGN : No.730 to 733	No.3015 + 20 × (X-1)
Alarm 3	DGN : No.760 to 763	No.3016 + 20 × (X-1)
Alarm 4	DGN : No.770 to 773	No.3017 + 20 × (X-1)
		(X: Ordinal axis number)
Loop gain	: Actual servo loop gain is displayed.	
Pos ERROR	: Error of each axis is indicated.	
	DGN : No.800 to 803	No.3000
Current (%)	: Current value of each axis is displayed as percentage of rated current.	
	No.8X86	No.1979
Speed (rpm)	: Actual motor speed is displayed.	

3.2 Setting Series 0 Digital Servo Parameters

This section explains how to set Series 0 digital servo parameters.

The setting procedure depends on the series of the NC system (Series 0-A, 0-B, 0-C (16 bit), 0-C (32 bit)) and the type of pulse coder (standard, high resolution, serial pulse coder A or B). Follow the setting flowchart described below after checking the series of the NC system and the type of pulse coder.

If the servo menu is provided on the parameter menu or service menu of the NC, setting can be facilitated by using the servo setting menu. When using the servo setting menu, see Section 3.1.1.

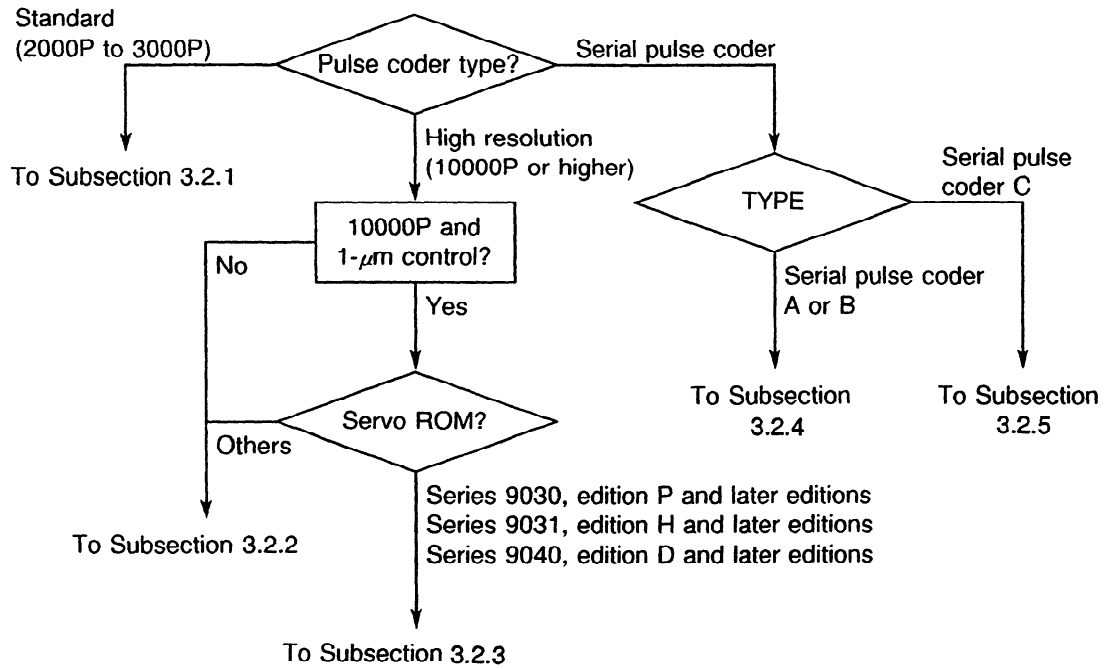

3. STARTING UP DIGITAL SERVO

3.2.1 Initialization flowchart when standard pulse coder is used

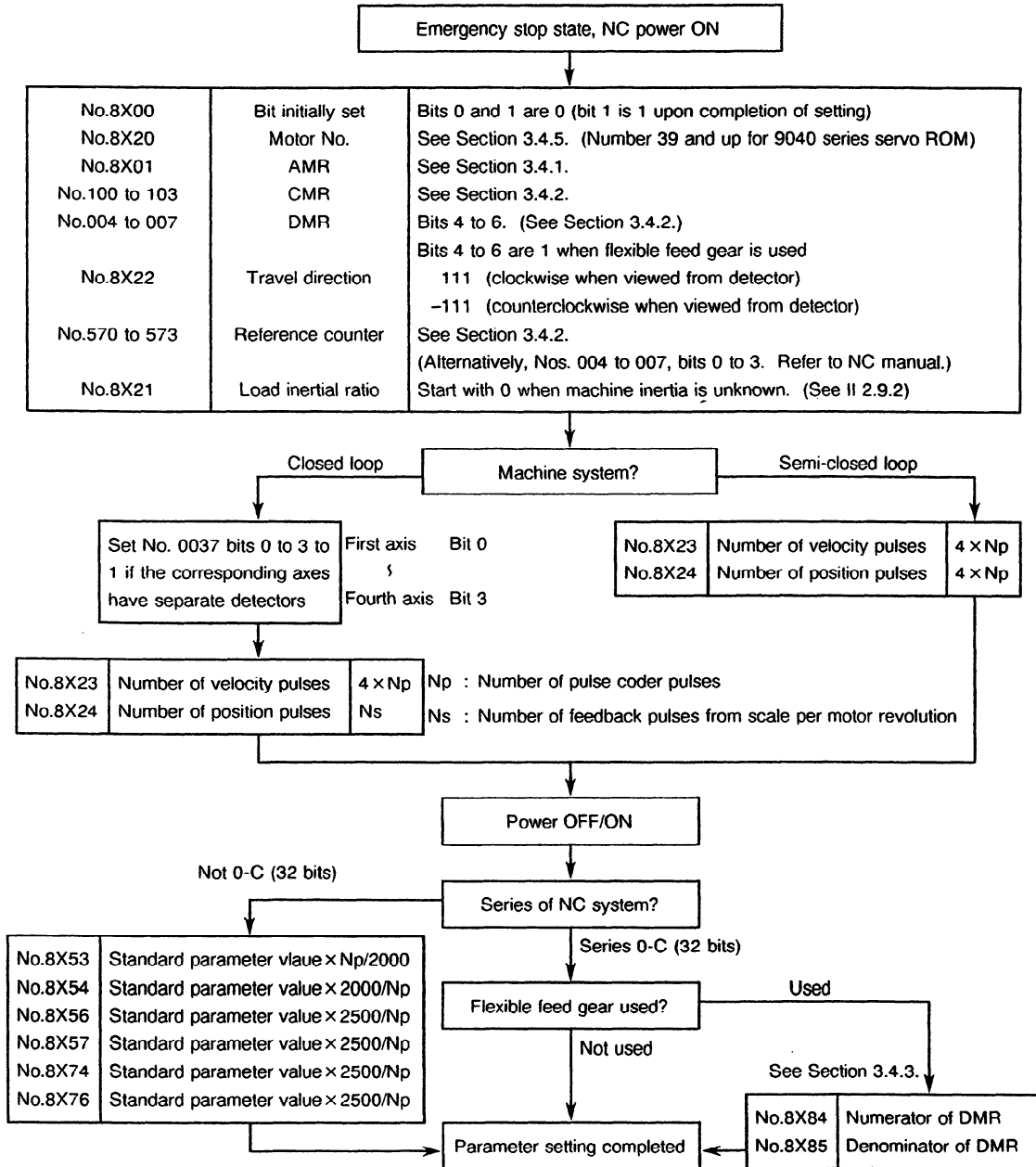

3.2.2 Initialization flowchart when high-resolution pulse coder is used

A high-resolution pulse coder may be used in the cases listed below.

- (1) Control resolution of 0.1 μm is required. (The optional parameter for 0.1- μm control is required. This control cannot be set for each axis separately.)
- (2) A high-resolution pulse coder is used but control resolution is 1 μm .
- (3) The larger servo motors (50S, 60S, and 70S) are used.

The parameter setting varies from case to case. Follow the setting flowchart described below.

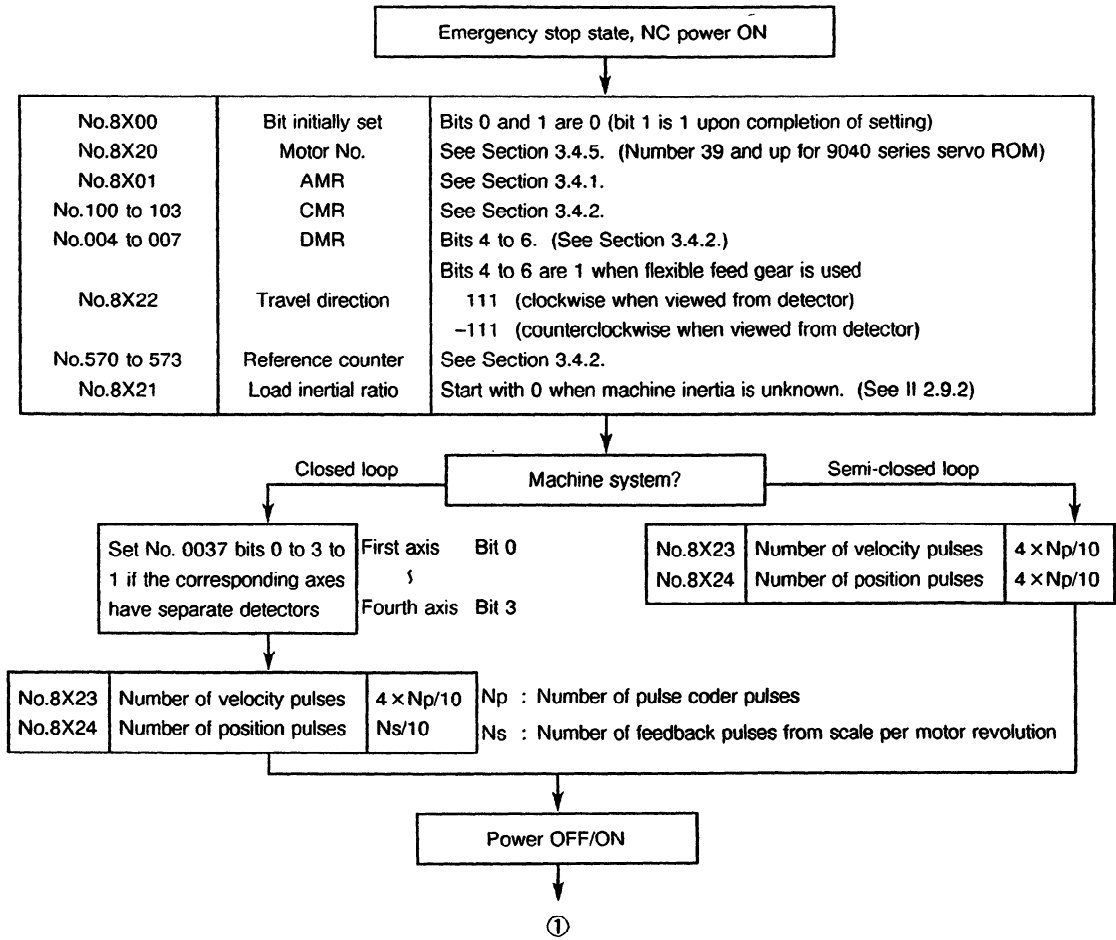

3. STARTING UP DIGITAL SERVO

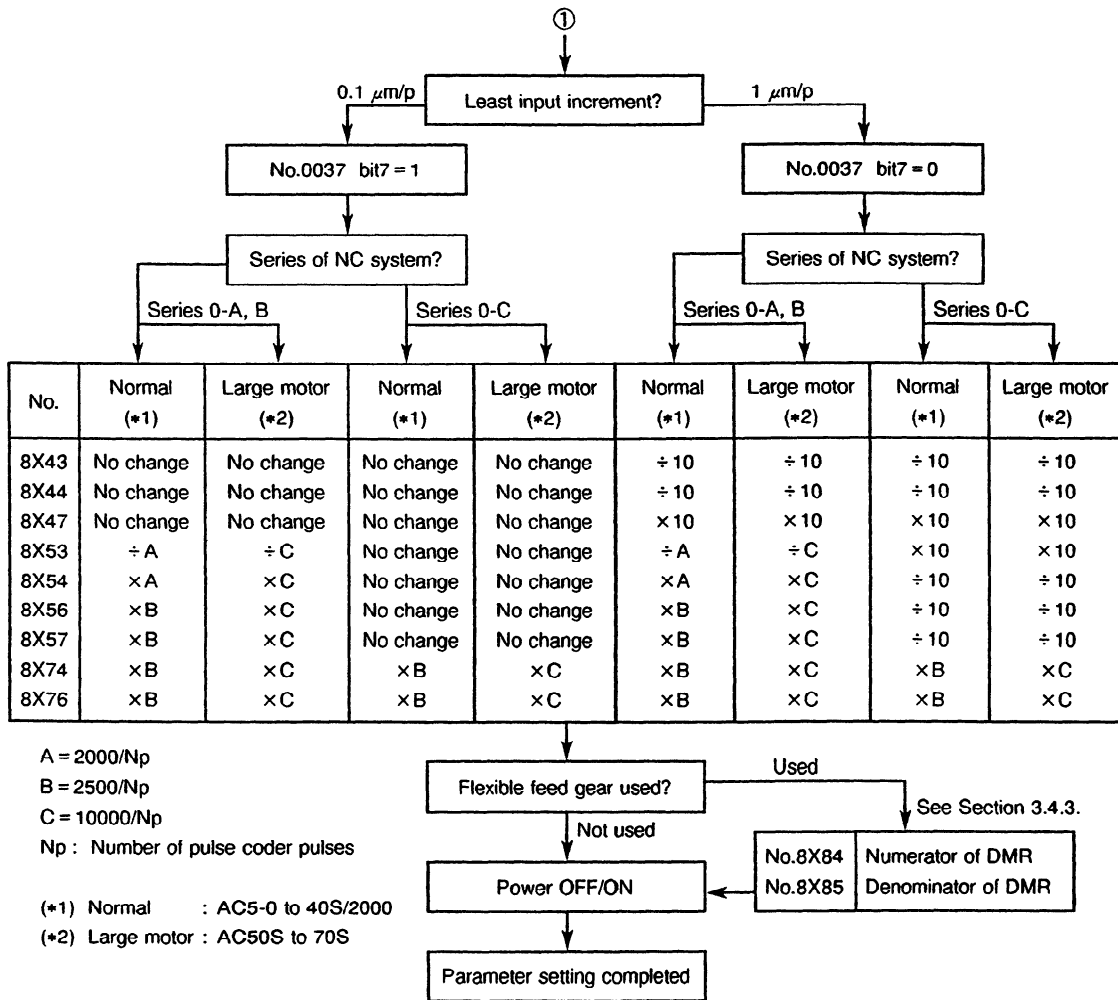

(Note) If the following trouble occurs, change the setting value of No.8X47 to 0. In this case, note that the observer function cannot be used.

- ① When 0.1- μ m control using a high-resolution pulse coder is set, the following alarm is raised: 4X7 SERVO ALARM X AXIS DGTL PARAM (X = names of first to fourth axes)
- ② The value of No.8X47 after modification exceeded 32767.

3.2.3 Initialization flowchart when 1- μ m control is applied with a 10000-pulse pulse coder

When 1- μ m control is applied with a 10000-pulse pulse coder, servo parameters can be easily set with the servo ROM of the following series and editions:

- Series 9030, edition P and later editions
- Series 9031, edition H and later editions
- Series 9040, edition D and later editions

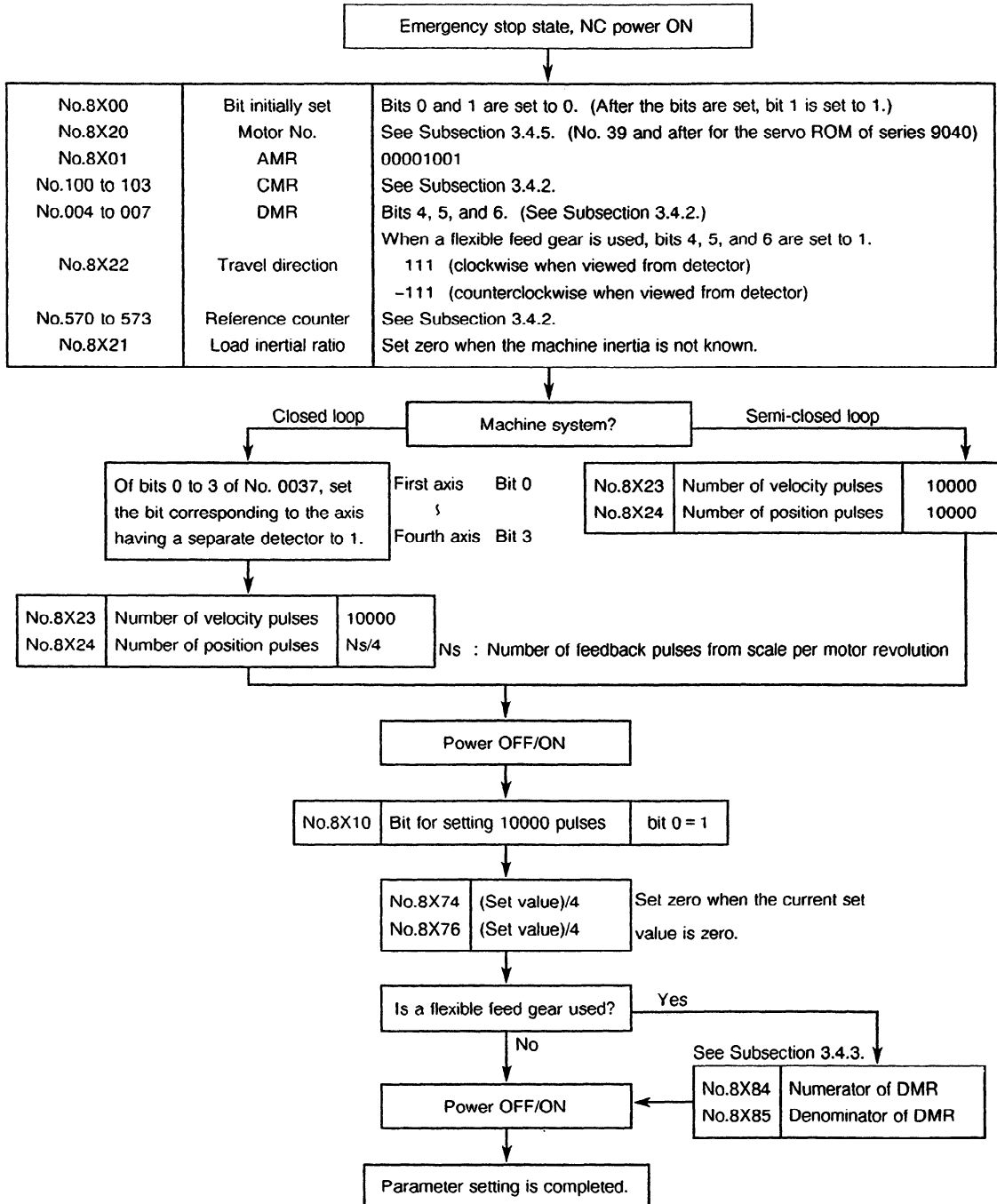

3. STARTING UP DIGITAL SERVO

3.2.4 Initialization flowchart when serial pulse coder A or B is used

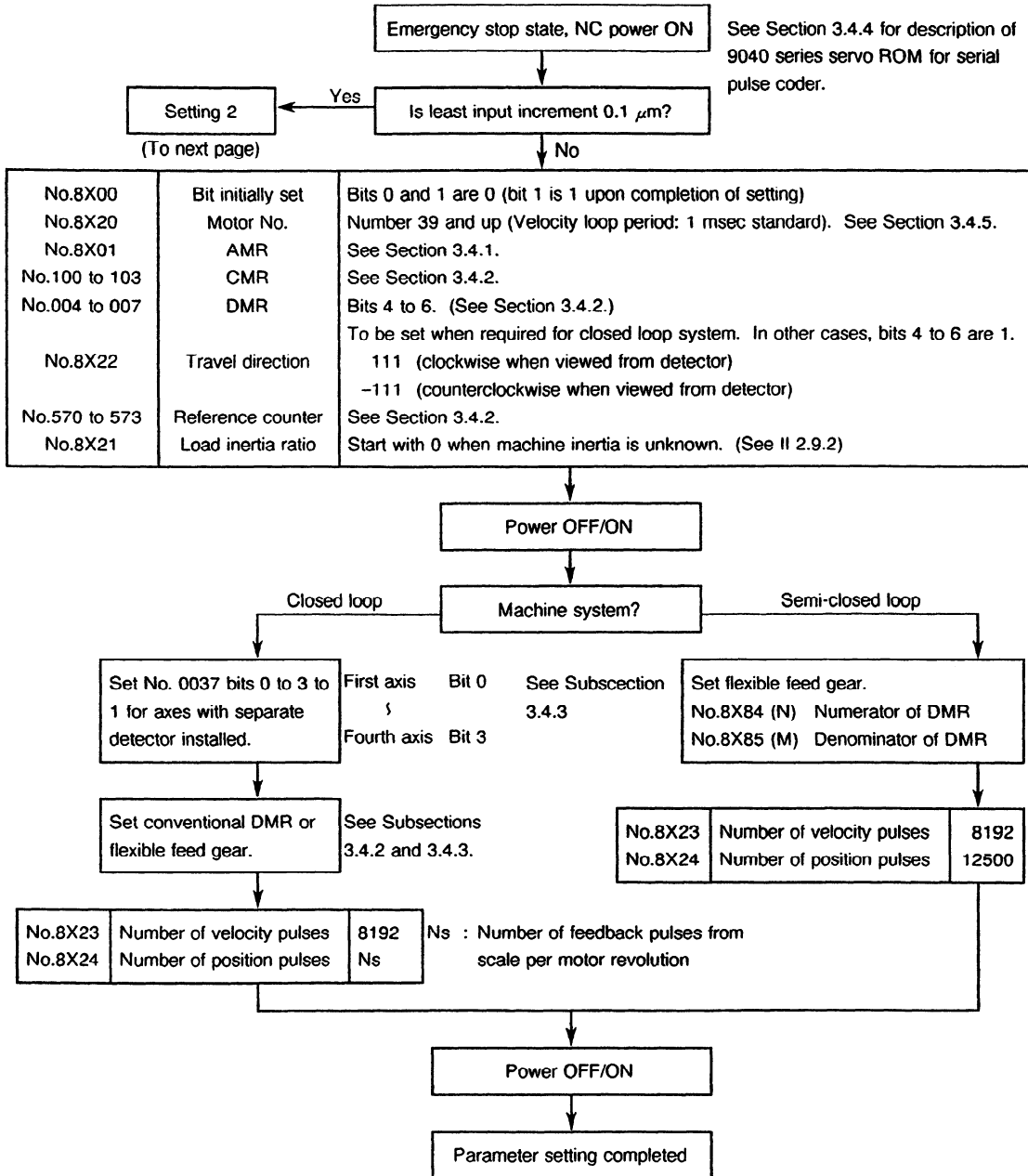

3. STARTING UP DIGITAL SERVO

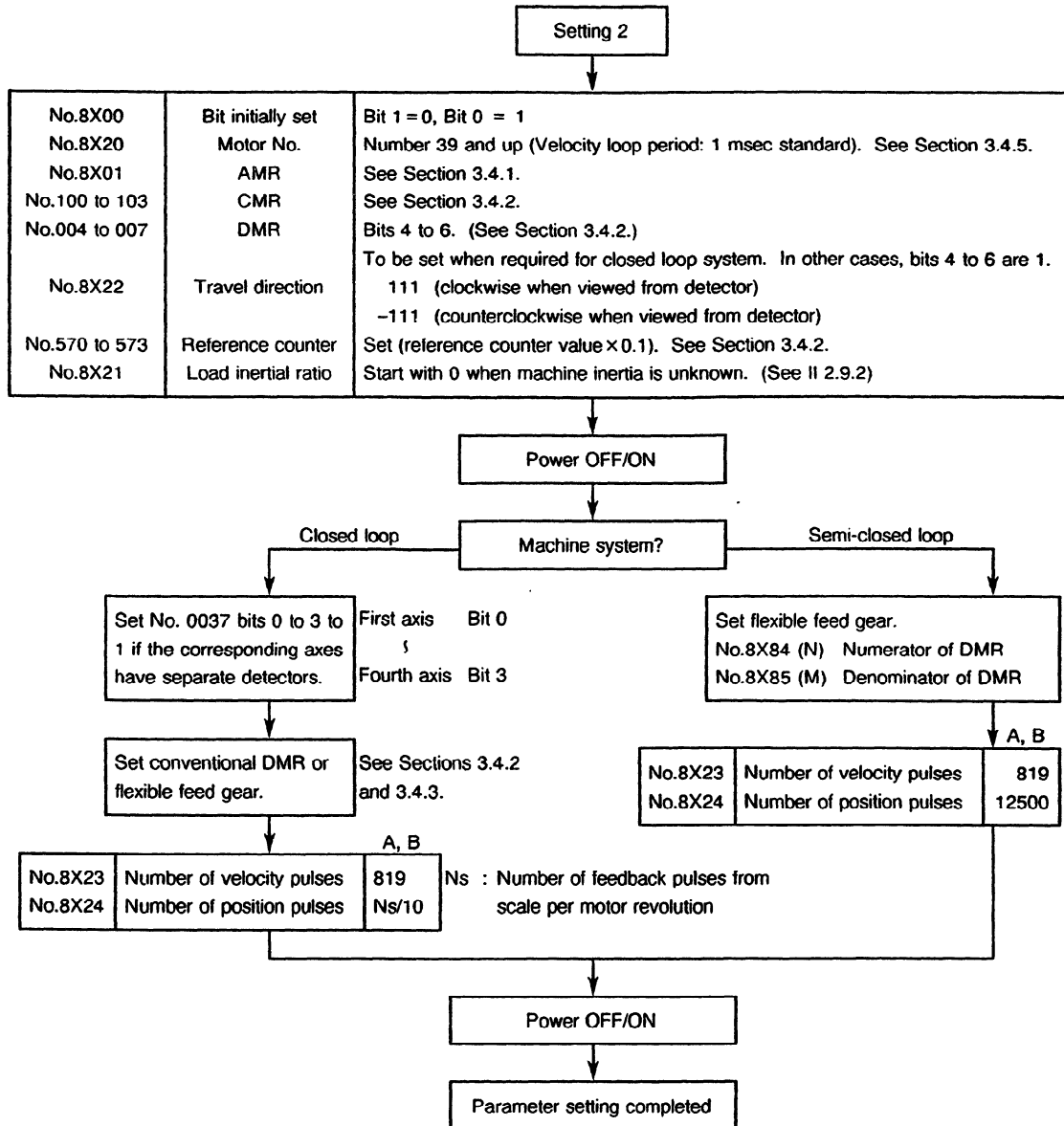

(Note) The optional parameter for 0.1- μ m control is required. This control cannot be exercised for each axis separately.

3. STARTING UP DIGITAL SERVO

3.2.5 Initialization flowchart when serial pulse coder C is used

A motor with serial pulse coder C can be driven with the servo ROM of series 9040, edition D or later. With this servo ROM, servo parameters are set in a different manner from that with the servo ROM of series 9050 for Series 16, 18, and Power Mate-C.

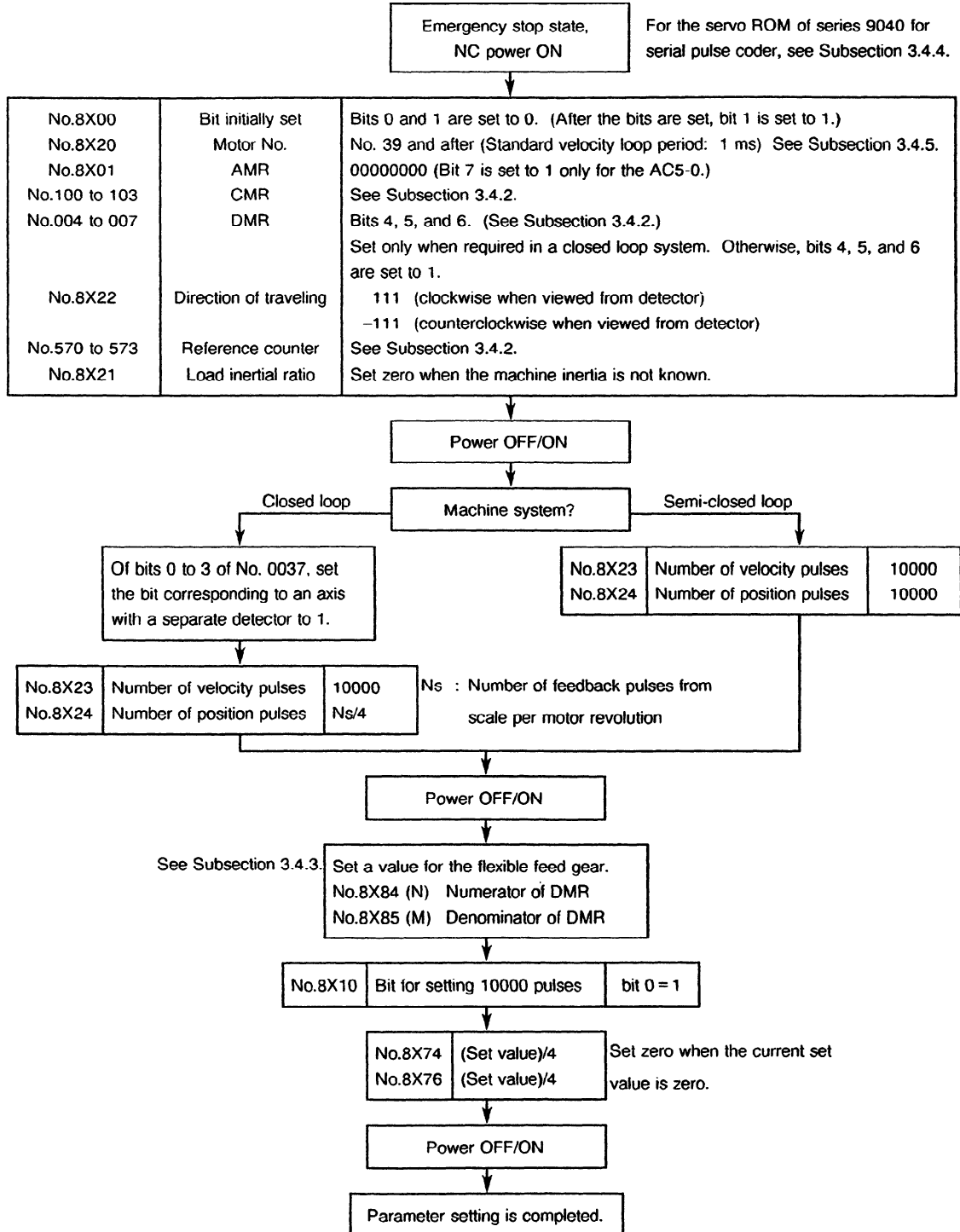

3. STARTING UP DIGITAL SERVO

3.3 Setting Series 15 Digital Servo Parameters

This section explains how to set Series 15 digital servo parameters.

The setting procedure depends on the type of pulse coder (standard, high resolution, serial pulse coder A or B). Follow the setting flowchart described below after checking the type of pulse coder.

If the servo menu is provided on the parameter menu or service menu of the NC, setting can be facilitated by using the servo setting menu. When using the servo setting menu, see Section 3.1.1.

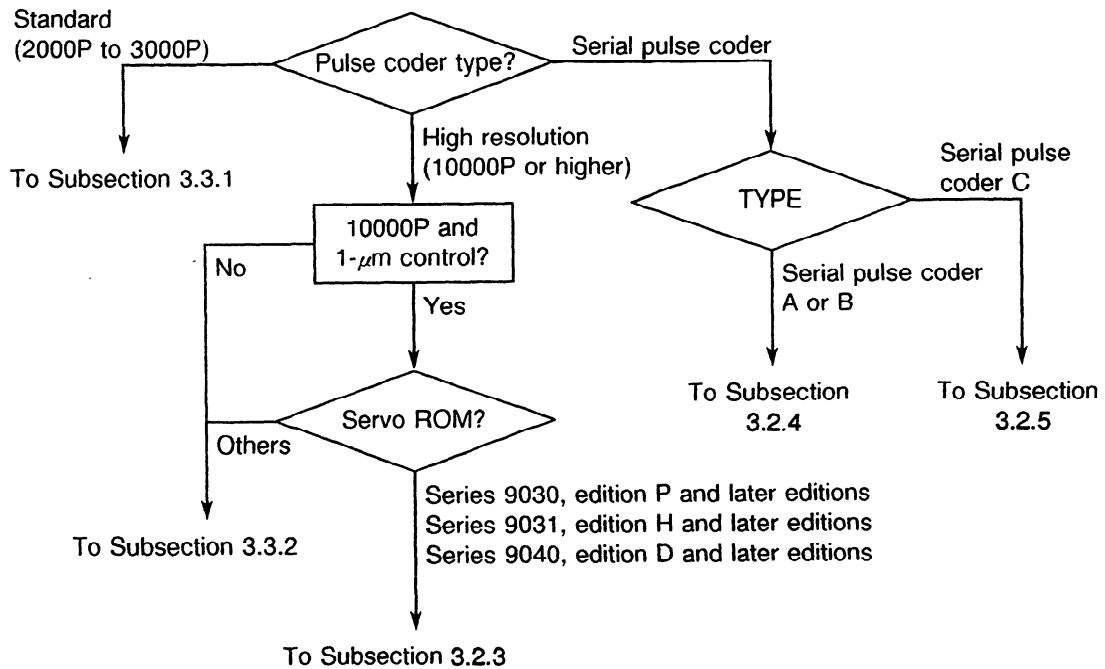

3.3.1 Initialization flowchart when standard pulse coder is used

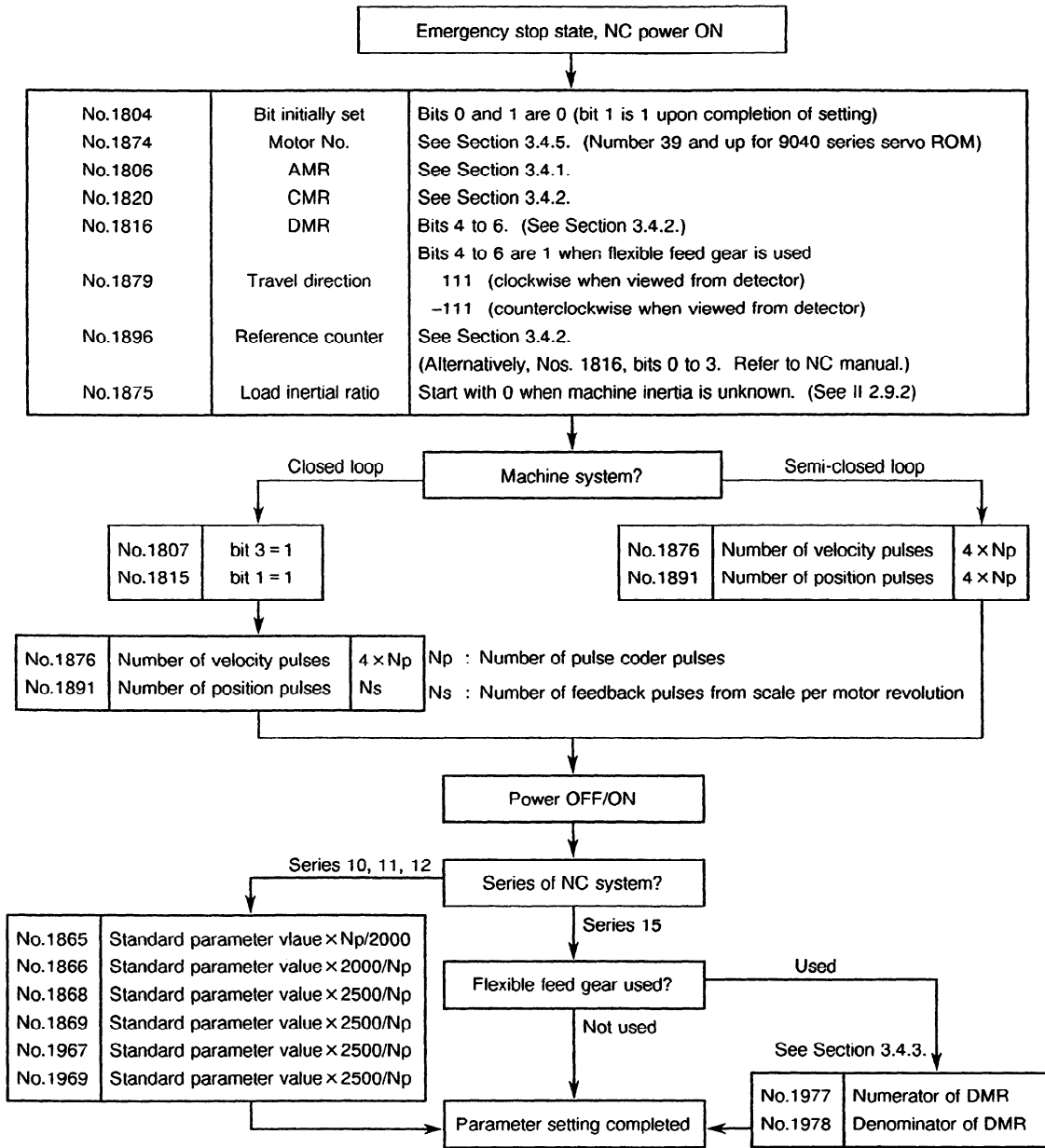

3. STARTING UP DIGITAL SERVO

3.3.2 Initialization flowchart when high-resolution pulse coder is used

A high-resolution pulse coder may be used in the cases listed below.

- (1) Control resolution of $0.1 \mu\text{m}$ is required. (The optional parameter for $0.1\text{-}\mu\text{m}$ control is required.)
- (2) High-resolution pulse coder is used but control resolution is $1\mu\text{m}$.
- (3) The larger servo motors (50S, 60S, and 70S) are used.

The parameter setting varies from case to case. Follow the setting flowchart described below.

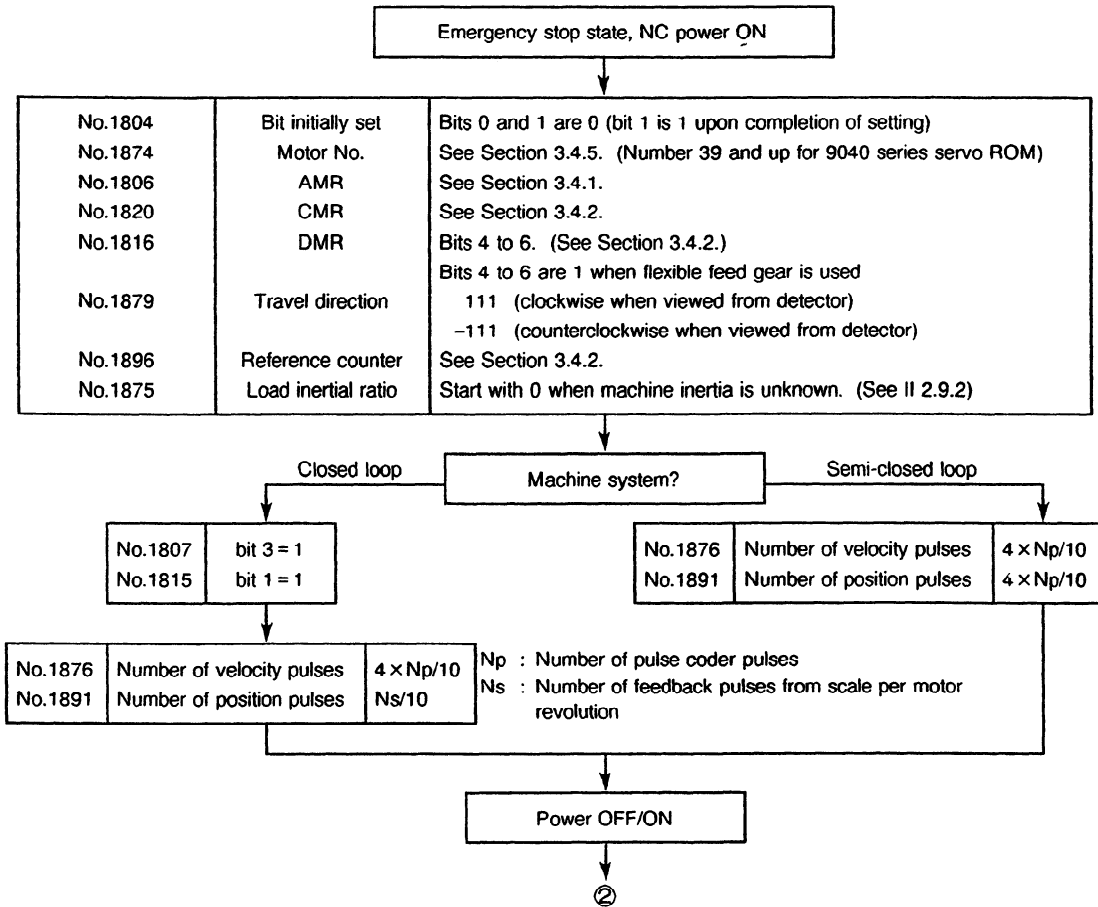

3. STARTING UP DIGITAL SERVO

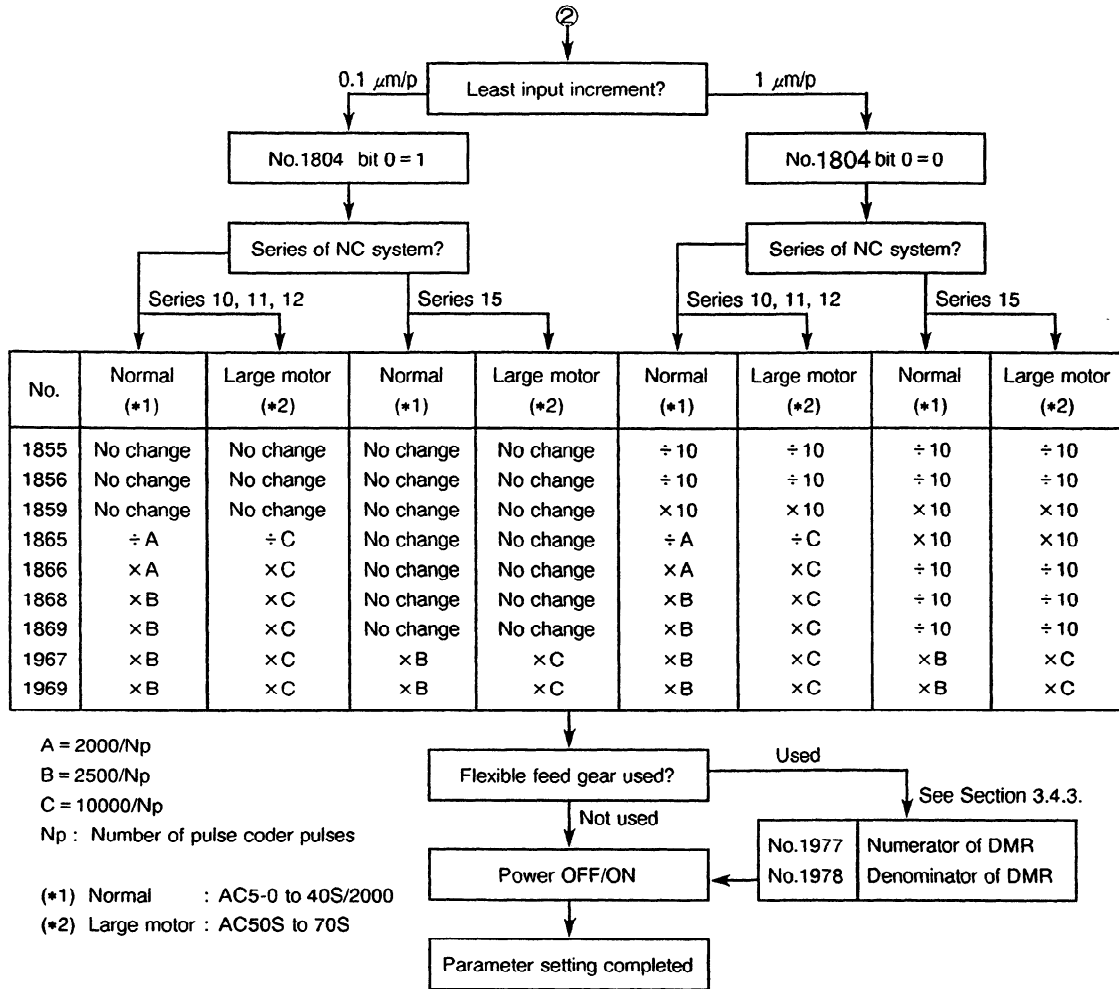

(Note) If the following trouble occurs, change the setting value of No.1859 to 0. In this case, note that the observer function cannot be used.

- ① When 0.1- μm control using a high-resolution pulse coder is set, the following alarm is raised: SV27 X ILL DGTL SERVO PARAMETER (X = names of first to fourth axes)
- ② The value of No.1859 after modification exceeded 32767.

3.3.3 Initialization flowchart when 1- μ m control is applied with a 10000-pulse pulse coder

When 1- μ m control is exercised with a 10000-pulse pulse coder, servo parameters can be easily set with the servo ROM of the following series and editions:

- Series 9030, edition P and later editions
- Series 9031, edition H and later editions
- Series 9040, edition D and later editions

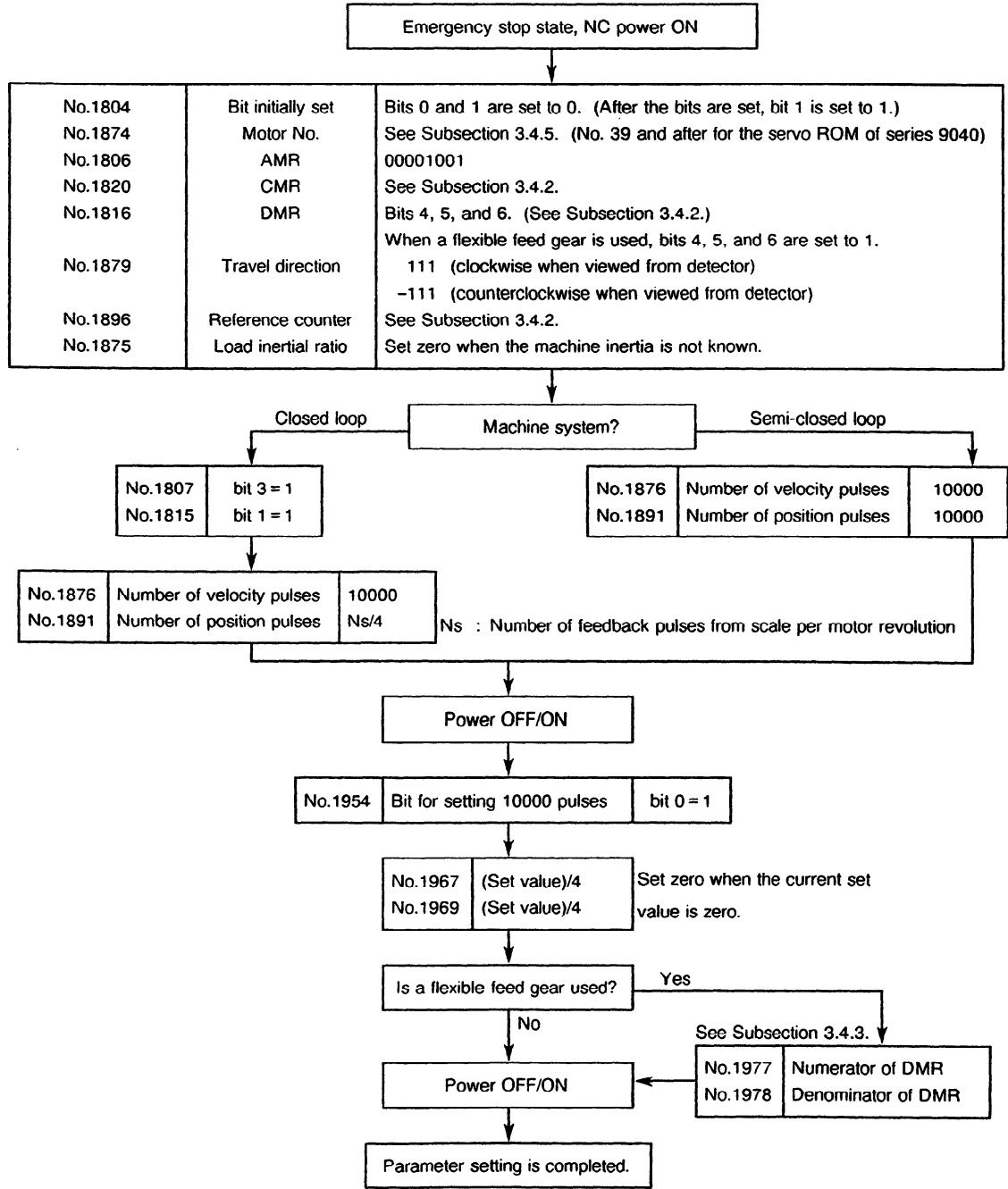

3. STARTING UP DIGITAL SERVO

3.3.4 Initialization flowchart when serial pulse coder A or B is used

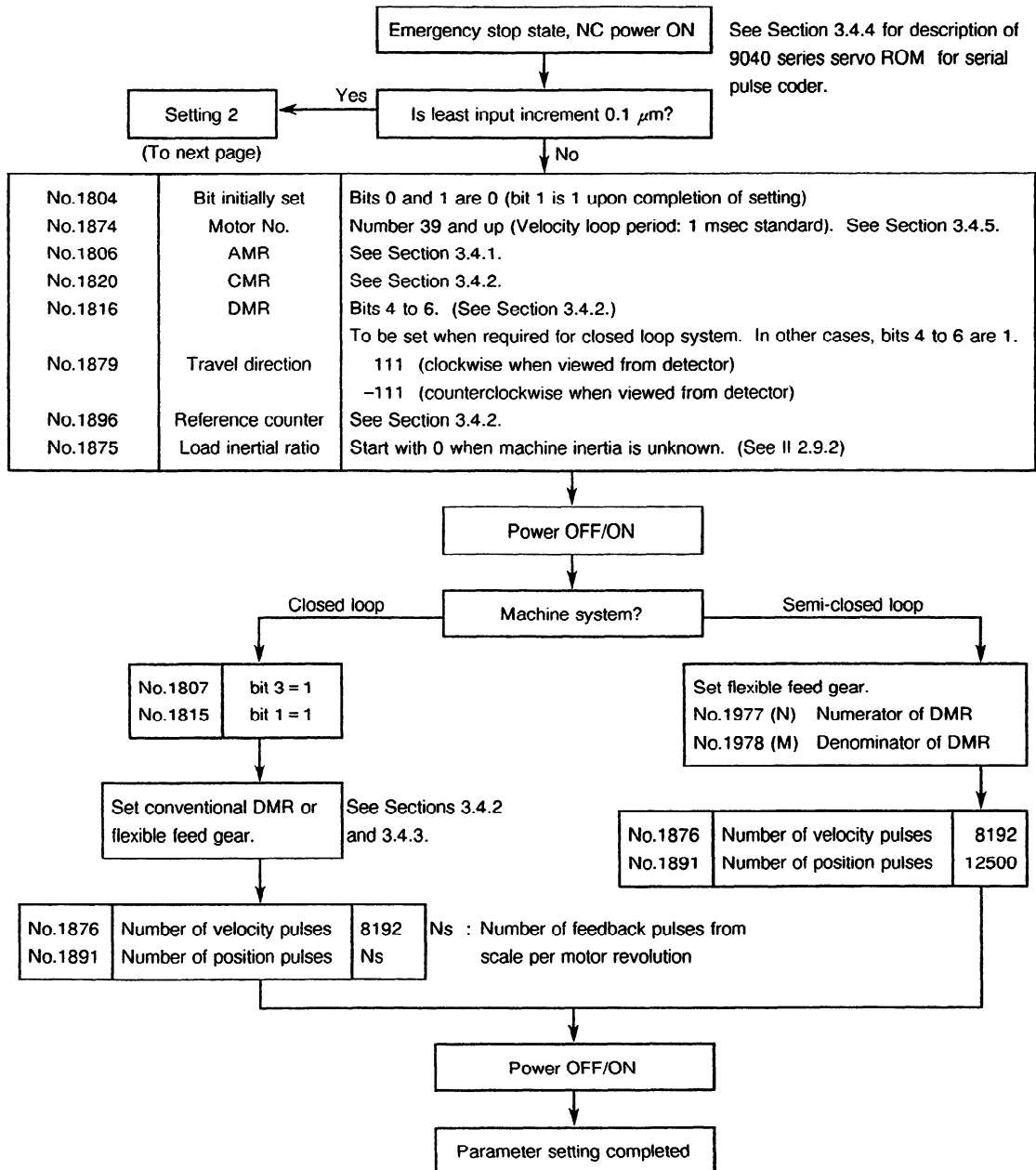

3. STARTING UP DIGITAL SERVO

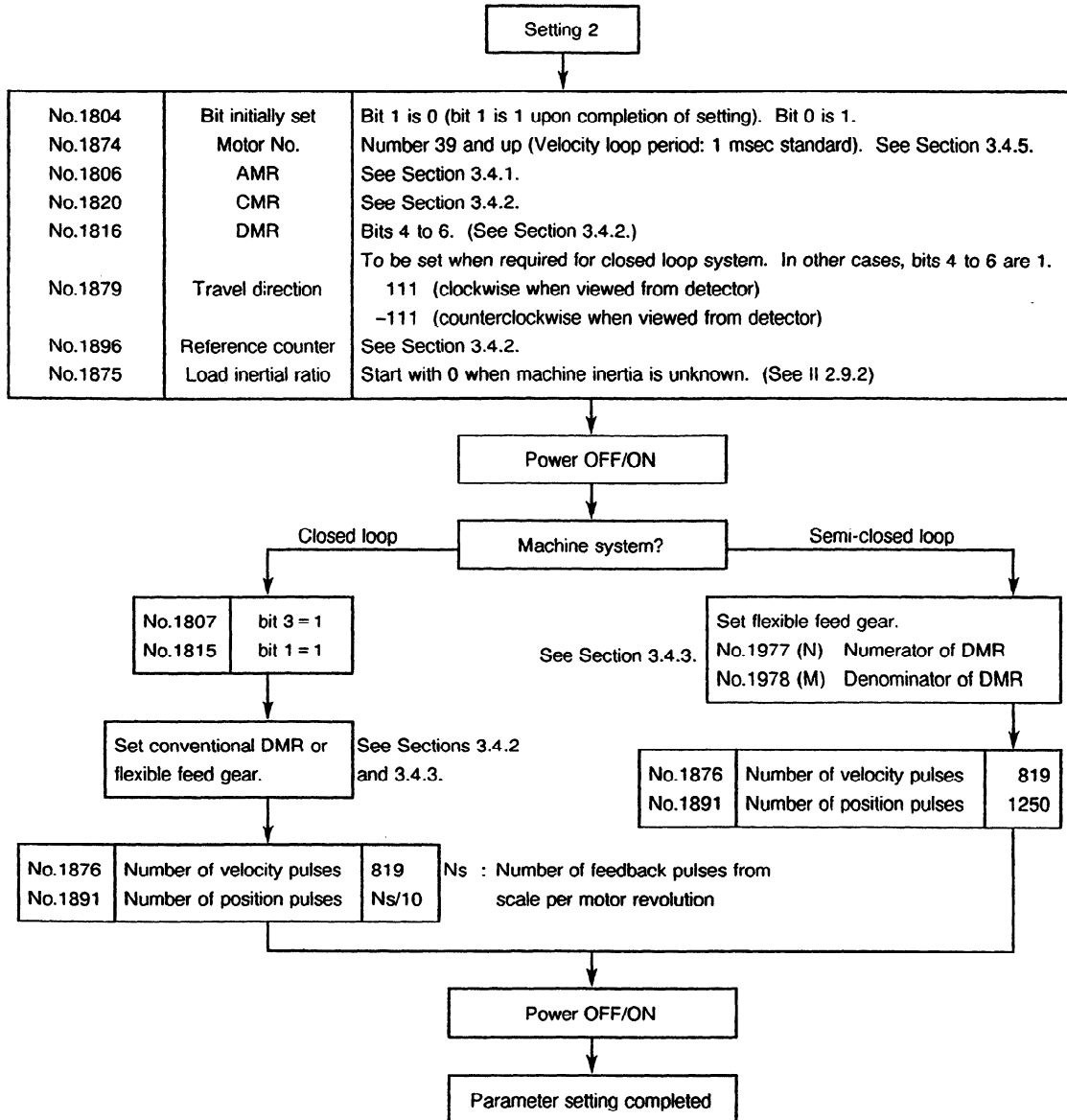

(Note) The optional parameter for 0.1- μ m control is required.

3. STARTING UP DIGITAL SERVO

3.3.5 Initialization flowchart when serial pulse coder C is used

A motor with serial pulse coder C can be driven with the servo ROM of series 9040, edition D or later. With this servo ROM, servo parameters are set in a different manner from that with the servo ROM of series 9050 for Series 16, 18, and Power Mate-C.

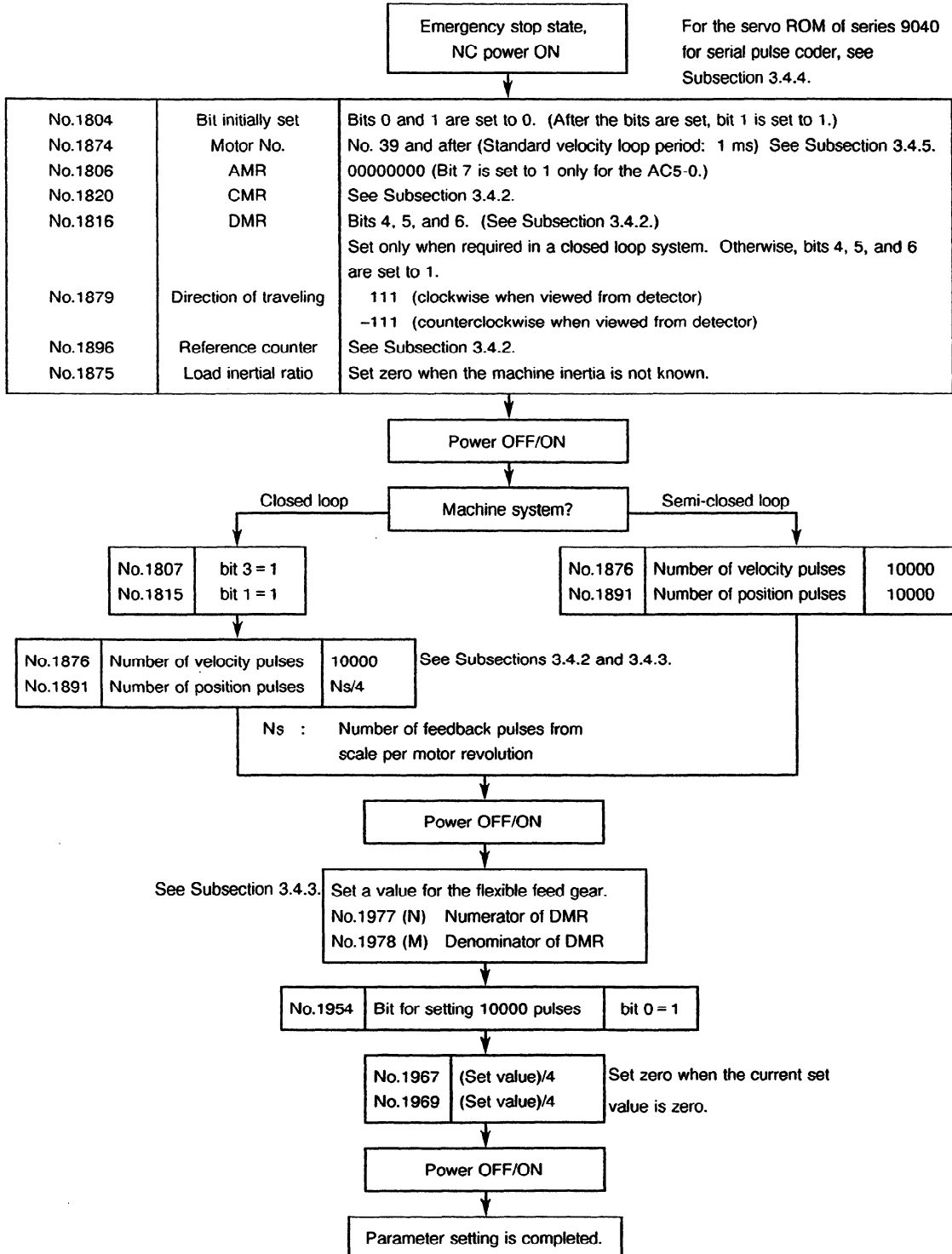

3.4 Information Required to Set Digital Servo Parameter

This section explains the following information required to set the digital servo parameters:

- (1) AMR setting (Section 3.4.1)
- (2) CMR, DMR, and reference counter setting (Section 3.4.2)
- (3) Setting of the flexible feed gear function (Section 3.4.3)
- (4) Servo software for serial pulse coders (Section 3.4.4)
- (5) Motor type numbers (Section 3.4.5)

3.4.1 AMR parameter setting

- (1) Setting parameters for conventional pulse coders (including the high-resolution type) are used

Set the AMR parameter according to the number of pulses of the pulse coder built in the motor as follows:

8X01	AMR7	AMR6	AMR5	AMR4	AMR3	AMR2	AMR1	AMR0
1806	AMR7	AMR6	AMR5	AMR4	AMR3	AMR2	AMR1	AMR0
	B7	B6	B5	B4	B3	B2	B1	B0

AMR								Number of pulses of pulse coder built into motor (before multiplied by 4)
7	6	5	4	3	2	1	0	
0	0	0	1	1	1	1	1	2000P
0	0	0	1	1	0	1	0	2500P
0	0	0	1	0	0	0	1	3000P
0	0	0	0	1	0	0	1	10000P
0	0	0	0	0	0	0	1	12500P, 15000P
0	0	1	1	1	1	1	1	20000P
0	0	1	1	1	0	1	0	25000P
0	0	1	1	0	0	0	1	30000P
1	0	0	1	0	0	0	0	(1000P 5-0)
0	0	0	1	0	1	0	1	(2000P 3-0S, 4-PS)

(Note) Serial pulse coder setting differs from the setting described above. For serial pulse coder values, see the items (2) and (3).

3. STARTING UP DIGITAL SERVO

(2) Setting the AMR parameter for serial pulse coder A or B

With the 9040 series, when a motor including serial pulse coder A or B is driven, AMR parameter setting depends on the motor.

The 9040 series D or later allows a servo motor including serial pulse coder C to be driven.

With 9040 series/edition A, motors (AC3-0S, 4-0S, 5-0, and so forth) incorporating serial pulse coder cannot be driven.

The 9040 series/edition B allows servo motors other than AC5-0 to be driven.

The 9040 series/edition C and later allow all FANUC servo motors (AC70S to 5-0) to be driven as before.

A servo motor with serial pulse coder C can be driven with the servo ROM of series 9040, edition D or later.

(3) Method of setting for serial pulse coder A or B

Set the AMR parameter (bits 0 to 7) according to the type of the motor as follows:

AMR (bit 0 to 7)								Name of motor
7	6	5	4	3	2	1	0	
1	0	0	0	0	0	1	0	AC 5-0
0	0	0	0	0	0	1	1	AC 4-0S, 3-0S
0	0	0	0	0	0	0	0	AC 70S to 2-0S

This motor can be driven with 9040 series/edition C or later.

 These motors can be driven with 9040 series B or later.

 Only this setting is allowed with 9040 series/edition A.

Set the AMR parameter (bits 0 to 7) according to the type of motor with serial pulse coder C as follows:

No. 8X01 (Series 0), No. 1806 (Series 15)

AMR (bit 0 to 7)								Name of motor
7	6	5	4	3	2	1	0	
1	0	0	0	0	0	0	0	AC 5-0
0	0	0	0	0	0	0	0	AC 70S to 4-0S

(Note) If a motor containing a conventional pulse coder is replaced with a motor containing a serial pulse coder, the 9040 series must be used and the axis control board must be type for serial pulse coder and AMR setting should be changed according to the table above. If the AMR values for a conventional pulse coder are not changed, an alarm (such as an excessive position deviation) will occur.

3.4.2 CMR, DMR, and reference counter setting

(1) Setting of CMR, DMR, and flexible feed gear

CMR means command multiply, and DMR means detection multiply. By setting CMR and DMR, the actual travel distance or angle are matched with the weight of detection pulses. If a flexible feed gear is available, it can be used for DMR. Fig. 3.4.2 shows the relationships between CMR, DMR, and a flexible feed gear.

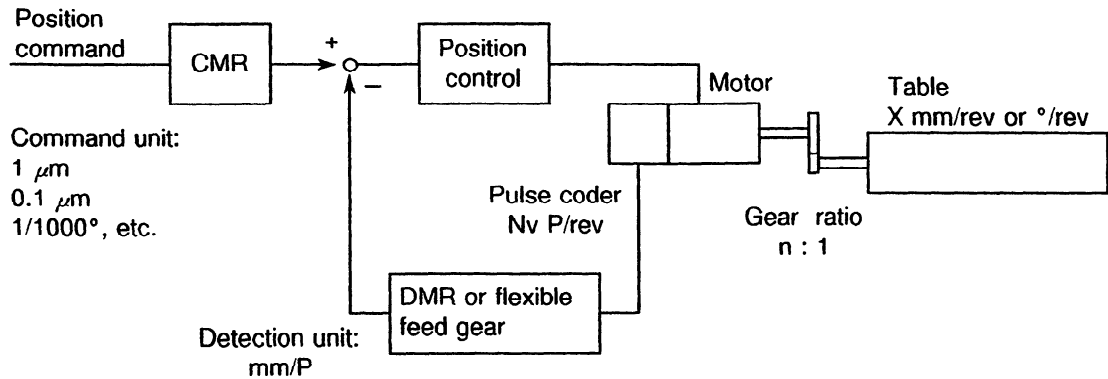

Fig. 3.4.2

Here, the detection unit can be calculated as follows (Nv: Number of pulse coder pulses per motor revolution):

$$\text{Detection unit (mm/P or °/P)} = \frac{X \text{ (mm/rev or °/rev)}}{Nv(P/rev) \times n \times \text{DMR (flexible feed gear)}}$$

To operate the system as specified, the command unit must be related with the detection unit as follows:

$$\frac{\text{Command unit (mm or °)}}{\text{CMR}} = \text{Detection unit (mm/P or °/P)}$$

CMR and DMR (flexible feed gear) must be set so as to satisfy this expression. Several combinations of CMR and DMR (flexible feed gear) are possible. In general, however, DMR (flexible feed gear) is set so that a simple value (such as 1 μm, 0.1 μm, and 1/1000°) can be specified for the detection unit.

See Section 3.4.3 for detailed information about the flexible feed gear function.

3. STARTING UP DIGITAL SERVO

(2) Setting the CMR and DMR parameters

(a) Method of CMR parameter setting

Servo setting menu CMR

No.1820 (Series 15), 100 to 103 (Series 0)

(A CMR parameter setting value is 2 times greater than a calculated value.)

(b) Method of DMR parameter setting

No.1816 (Series 15), 004 to 007 (Series 0) bit 4 to 6

bit 6	bit 5	bit 4	DMR
0	0	0	1/2
0	0	1	1
0	1	0	3/2
0	1	1	2
1	0	0	5/2
1	0	1	3
1	1	0	7/2
1	1	1	4

When a flexible feed gear is used, set DMR to 4 (bits 4 to 6 are 1).

Example 1: To exercise 1- μm control with a linear axis, ball screw of 10 mm/rev, direct connection (gear reduction ratio of 1 : 1), and pulse coder of 2500 P ($N_v = 2500 \text{ P/rev}$)

For a detection unit of 1 μm ,

$$\text{DMR} = \frac{10}{10000 \times 1 \times 0.001} \times 4 = 4$$

$$\text{CMR} = \frac{0.001}{0.001} = 1$$

So CMR and DMR must be set to 2 and 4 (or flexible feed gear = 1/1) respectively.

3. STARTING UP DIGITAL SERVO

Example 2: To exercise 1- μ m control with a linear axis, ball screw of 4 mm/rev, gear reduction ratio of 2 : 1, and pulse coder of 2000 P (Nv = 8000 P/rev)

For a detection unit of 1 μ m,

$$\text{Flexible feed gear} = \frac{4}{8000 \times 2 \times 0.001} \times 4 = 1$$

$$\text{CMR} = \frac{0.001}{0.001} = 1$$

So CMR and DMR must be set to 2 and 4 (or flexible feed gear = 1/1) respectively.

Example 3: To exercise 1/1000° control with a rotational axis, gear reduction ratio of 100 : 1, and pulse coder of 3000P (Nv = 12000 P/rev)

For a detection unit of 1/1000°,

$$\text{Flexible feed gear} = \frac{360}{12000 \times 100 \times 1/1000} = \frac{3}{10}$$

$$\text{CMR} = \frac{1/1000}{1/1000} = 1$$

So CMR and flexible feed gear must be set to 2 and 3/10 respectively.

3. STARTING UP DIGITAL SERVO

(3) Setting the reference counter

The reference counter is used for grid-method reference operation. In grid-method reference, when axis feed is started, a motor or scale Z phase signal is detected. With this point used as the reference, grid points are created at intervals of a set reference counter capacity. Then, each time a deceleration dog is pressed, deceleration occurs. After such a deceleration dog is passed, operation stops at the next grid point; this point is used as the zero point.

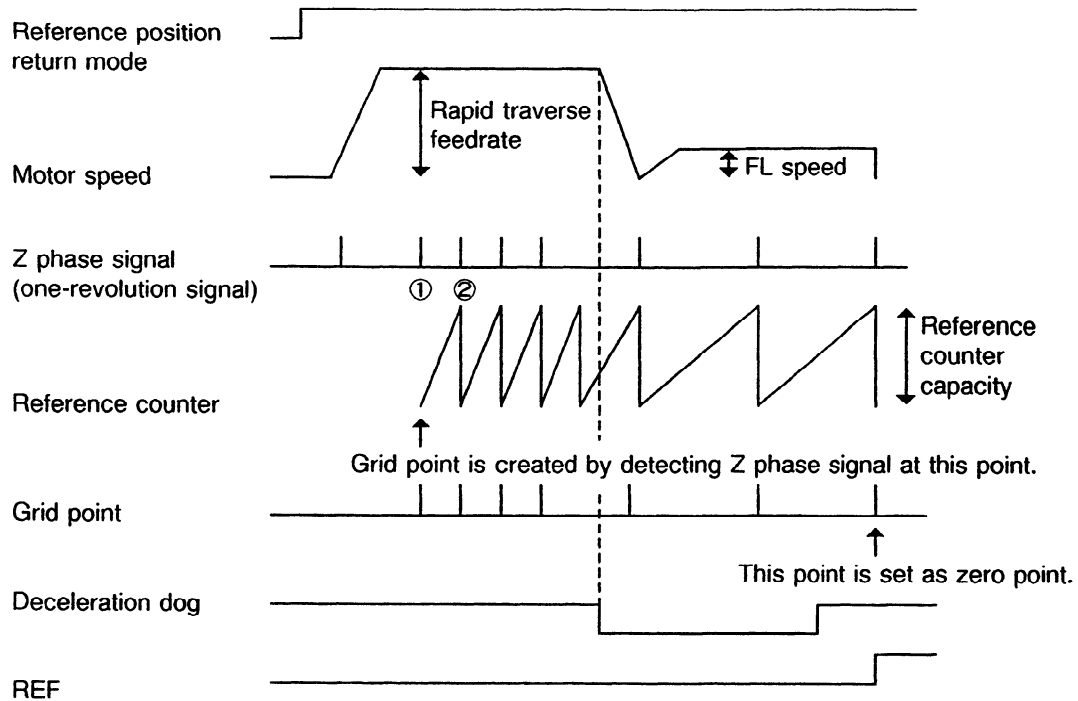

So if the motor one-revolution signal is used as the Z phase signal, the Z phase signal is generated each time the motor makes one revolution. This means that the point of Z phase signal detection depends on the location where reference operation is started. In the example above, the Z phase signal of point ① is detected to create a grid. However, the Z phase signal at point ② may be detected next.

To create the same grid and produce a fixed zero point even if the Z phase signal is detected at different points, the reference counter must be set to the same number as the number of position pulses per one revolution of the motor, or such a number divided by an integer.

When all strokes include just one Z phase signal as in the case of a linear scale, for example, the reference counter can be set to an arbitrary number. (However, it may be desirable to consider the number of semi-closed loop pulses so that normal reference operation can be performed even if trouble occurs with the scale, for example, and the loop is changed to a semi-closed loop.)

3. STARTING UP DIGITAL SERVO

(4) Setting parameters for reference counter capacity

(a) Setting the reference counter capacity (bit type)

No.1816 (Series 15), 004 to 007 (Series 0), Bits 0 to 3

bit 3	bit 2	bit 1	bit 0	Reference counter capacity	
				Least input increment 1 μ	Least input increment 0.1 μ
0	0	0	0	1000	10000
0	0	0	1	2000	20000
0	0	1	0	3000	30000
0	0	1	1	4000	40000
0	1	0	0	5000	50000
0	1	0	1	6000	60000
0	1	1	0	7000	70000
0	1	1	1	8000	80000
1	0	0	0	9000	90000
1	0	0	1	10000	100000
1	0	1	0	11000	110000
1	0	1	1	12000	120000
1	1	0	0	13000	130000
1	1	0	1	14000	140000
1	1	1	0	15000	150000
1	1	1	1	16000	160000

(b) Arbitrary reference counter capacity (word type)

If an arbitrary reference counter capacity is used, a reference counter value other than those listed in the table above can be set. In this case, however, values greater than 32767 cannot be set. If the least input increment is 0.1 μ m, set a reference counter value multiplied by 0.1.

An arbitrary reference counter value is to be set in No.1896 (Series 15) or 570 to 573 (Series 0), or in the reference counter field on the servo setting menu.

Example 1: Reference counter capacity setting with motor pulse coder of 2500P, lead of 10 mm/rev, and DMR=4 (flexible feed gear 1/1)

The number of position pulses per motor revolution is 10000 P/rev because DMR is 4. So a reference counter capacity of 10000 is to be set. Since the detection unit is 0.001 mm/p, the grid interval is 10 mm.

A reference counter capacity of 5000 can be set instead. In this case, the grid interval is 5 mm. (Two grid points are generated per revolution.)

3. STARTING UP DIGITAL SERVO

Example 2: Reference counter capacity setting with motor pulse coder of 20000P, lead of 4 mm/rev, and DMR = 2 (flexible feed gear 1/2)

The number of position pulses per motor revolution is 40000 P/rev because DMR is 2. So a reference counter capacity of 40000 is to be set. (In this case, a least detection unit of 0.1 μm is used. When an arbitrary reference counter capacity is used, 4000 is to be set.) Since the detection unit is 0.0001 mm/p, the grid interval is 4 mm.

A reference counter capacity of 20000 can be set instead. In this case, the grid interval is 2 mm. (Two grid points are generated per revolution.)

Example 3: Reference counter capacity setting with motor pulse coder of 2500P, gear reduction ratio of 108 : 1, and 0.001° specified for rotational table

In this example, when a flexible feed gear of 1/3 is used, the detection unit is 0.001°. In this case, however, the number of pulses per motor revolution is not an integer but 3333.3333 (= 10000 \times 1/3). So, the reference counter cannot be set correctly, thus producing no fixed zero point.

So, in this case, a flexible feed gear of 1/1 (or DMR=4) and CMR=6 (calculated value: 3) need to be set. With this setting, the number of pulses per motor revolution is 10000. Accordingly, when a reference counter capacity of 10000 is set, normal reference position return operation can be performed.

3.4.3 Setting the flexible feed gear function

So far, pulse coders with various resolutions have been prepared by the user to match a least command increment of 1 μm according to ball screw pitches or gear reduction ratios.

This function extends the conventional DMR to make the resolution of the pulse coder variable. With this function, a pulse coder with a single resolution can be set very easily to match various ball screw pitches or gear reduction ratios to the least command increment.

Fig. 3.4.3 shows the configuration of the flexible feed gear.

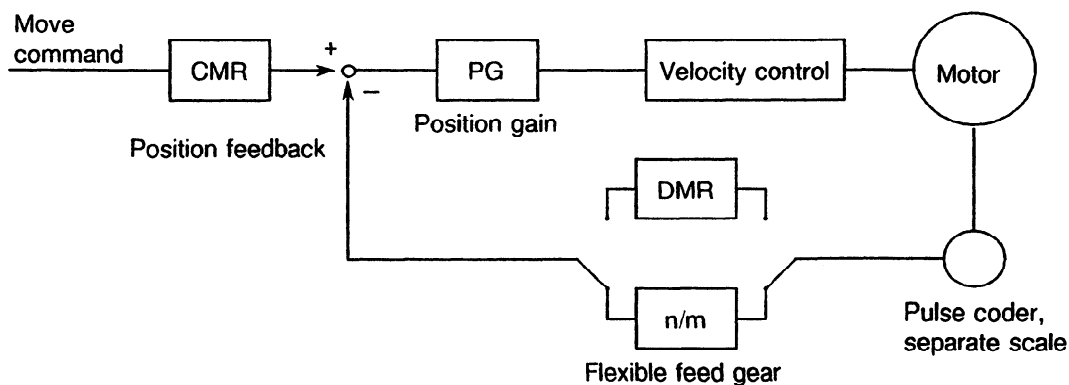

Fig. 3.4.3 Configuration of flexible feed gear

3. STARTING UP DIGITAL SERVO

As seen from Fig. 3.4.3, this function is an extension of the conventional DMR; a feedback pulse signal from the pulse coder or scale can be decreased by a factor of n/m.

Additionally, when a motor with serial pulse coder is driven in a semi-closed loop system (with the 9040 series used), a flexible feed gear must always be used. However, the method of setting differs from cases where the conventional pulse coders are used. For detailed information, see Section 3.4.3(2).

(1) Setting the flexible feed gear parameter for conventional pulse coders (including the high-resolution type)

(a) Applicable servo ROM series/editions

Edition 9030/001J and later

Edition 9031/001H and later

Edition 9032/001C and later

(b) Parameter setting

The parameters for n and m are as follows:

n 8X84 (Series 0-C), 1977 (Series 15)

m 8X85 (Series 0-C), 1978 (Series 15)

In n and m, an arbitrary integer up to 32767 can be set. So the setting values of n/m can be:

$$\frac{n}{m} = \frac{\text{Desired number of pulses per motor revolution}}{\text{Number of feedback pulses per motor revolution}} \quad \text{or reduced value}$$

(2) Setting the flexible feed gear parameter for a serial pulse coder

(a) Applicable servo ROM series/editions

Edition 9040/001A and later

(b) Parameter setting

When a serial pulse coder is used, a flexible feed gear must always be specified in DMR setting in a semi-closed loop system. Otherwise, an alarm is raised.

For serial pulse coder A and B, the parameters and setting ranges for n and m are:

$$\frac{n \text{ (No.8X84, 1977)}}{m \text{ (No.8X85, 1978)}} = \frac{\text{Desired number of position feedback pulses per motor revolution}}{1,000,000} \leq 1$$

3. STARTING UP DIGITAL SERVO

For serial pulse coder C (9040/001D and later editions), the parameters for n and m are:

$$\frac{n \text{ (No.8X84, 1977)}}{m \text{ (No.8X85, 1978)}} = \frac{\text{Number of position feedback pulses per motor revolution}}{40,000}$$

(Note 1) The maximum set value is 32767 for both the numerator and denominator. So, reduce the fractional expression and use the smaller values.

(Note 2) When serial pulse coder B (with the T series motor used) is used, obtain the reduction on the assumption that the setting range of n (No.8X84, 1977) does not exceed 250,000 and m (No.8X85, 1978) is 1,000,000.

(Note 3) For DMR setting in a closed loop system, use the conventional DMR or a flexible feed gear. When a flexible feed gear is used, use the value of the following expression or its reduced value.

$$\frac{n \text{ (No.8X84, 1977)}}{m \text{ (No.8X85, 1978)}} = \frac{\text{Desired number of pulses per motor revolution}}{\text{Number of position feedback pulses per motor revolution}}$$

(3) Examples of setting the flexible feed gear function

Example 1: Setting for 1- μ m detection using a pulse coder of 2000P (DMR can also be used for setting.)

Ball screw lead (mm/rev)	Desired number of pulses/ feedback pulses	Setting value	Reference counter
1	1000/8000	1/8 (DMR = 1/2)	1000
2	2000/8000	1/4 (DMR = 1)	2000
3	3000/8000	3/8 (DMR = 2/3)	3000
4	4000/8000	1/2 (DMR = 2)	4000
5	5000/8000	5/8 (DMR = 5/2)	5000
7	7000/8000	7/8 (DMR = 7/2)	7000
8	8000/8000	1/1 (DMR = 4)	8000

3. STARTING UP DIGITAL SERVO

Example 2: Setting for 1- μ m detection using a pulse coder of 10000P

Ball screw lead (mm/rev)	Desired number of pulses/ feedback pulses	Setting value	Reference counter
2	2000/40000	1/20	2000
3	3000/40000	3/40	3000
4	4000/40000	1/10	4000
5	5000/40000	1/8 (DMR = 1/2)	5000
6	6000/40000	3/20	6000
8	8000/40000	1/5	8000
10	10000/40000	1/4 (DMR = 1)	10000
12	12000/40000	3/10	12000

Example 3: Setting for 1 μ m detection using serial pulse coder A in a semi-closed loop system

Ball screw lead (mm/rev)	Number of feedback pulses/ 1000000	Setting value	Reference counter
6	6000/1000000	3/500	6000
8	8000/1000000	1/125	8000
10	10000/1000000	1/100	10000
12	12000/1000000	3/250	12000

Example 4: Setting for 0.001° detection using a pulse coder of 3000P and rotation axis with a gear reduction ratio of 1/160

Desired number of pulses per motor revolution : $360 \times 1000 \times (1/160) = 2250P$

Number of pulse coder pulses per motor revolution : $3000 \times 4 = 12000P$

So the flexible feed gear setting value is 2250/12000 (= 36/192).

The reference counter value is 2250.

(4) Notes on setting the flexible feed gear function

- (a) If either flex feed gear parameter is set to 0, the conventional DMR is applicable.
- (b) When using a flexible feed gear, set DMR to 4.
- (c) After the parameters for this function are set, be sure to turn the power off, then on again.
- (d) When using a high-resolution pulse coder, set this function after completion of servo parameter setting.
- (e) For the number of position feedback pulses (1891 (Series 15), 8X24 (Series 0-C), 1024 (PMA)), set the number of position feedback pulses (after multiplied by 4) per motor revolution as before.

3. STARTING UP DIGITAL SERVO

(f) The flexible feed gear setting limits are indicated below.

① $1 \leq n \leq 32767, 1 \leq m \leq 32767$

② For a system using a conventional pulse coder or a closed-loop system using a serial pulse coder, the following expression is satisfied:

$$n/m \geq 655 \times \frac{PG}{2000} \times \frac{\text{No.1876, 8X23}}{\text{No.1891, 8X24}} \times \frac{4}{DMR} \times \frac{1}{32767}$$

For a semi-closed loop system using a serial pulse coder, the following expression must be satisfied:

$$n/m \geq 655 \times \frac{PG}{2000} \times \frac{\text{No.1876, 8X23}}{\text{No.1891, 8X24}} \times \frac{1}{10} \times \frac{1}{32767}$$

PG: Position gain parameter value (No.1825, 517)

When a conventional pulse coder is used, the following expression must be satisfied:

$$n/m \leq \frac{32767 \times 60000 \text{ (or 30000 when velocity loop period is 2 msec)}}{\text{Number of pulse coder pulses} \times 4 \times \text{maximum speed (rpm)}}$$

Example: When the number of pulse coder pulses is 10000P, the maximum speed is 3000 rpm, the velocity loop period is 1 msec, and the position gain is 30 (parameter value: 3000), the allowable setting range of n/m is as follows:

$$0.03 \leq n/m \leq 16.38$$

If the expressions above are not satisfied, the alarm for incorrect parameter setting occurs. When the alarm is issued, the following action must be taken:

- ① Change the setting of CMR and flexible feed gear.
- ② Use the function for enlarging the position gain setting range. (See Subsection 7.5.1 (b).)

(g) When a semi-closed loop system is controlled, a flexible feed gear ratio must be selected so that the number of position feedback pulses per motor revolution becomes an integer. This helps to keep the reference position consistent when the machine is returned to the reference position.

Example: Motor pulse coder of 2500P, gear reduction ratio of 108:1, rotation table, and 0.001° command

When a flexible feed gear is used and the gear ratio is set to 1/3, the unit of detection becomes 0.001°. However, the number of pulses per motor

3. STARTING UP DIGITAL SERVO

revolution becomes a non-integer ($10000 \times 1/3 = 3333.3333$). The reference counter cannot be set correctly and the reference position becomes inconsistent.

To prevent this, set the gear ratio of the flexible feed gear to 1/1. (Alternatively, set DMR to 4.) Then, set the value of CMR to 6 (although the calculated value is 3).

With these values, the number of pulses per motor revolution becomes 10000. When the value of the reference counter is set to 10000, the machine can be returned to the reference position correctly.

- (h) If the gear ratio of the flexible feed gear is set so that the number of position feedback pulses per motor revolution is 640 or less, the software disconnection alarm may occur. When this occurs, change the level for detecting the software disconnection alarm. (See Subsection 7.3.2.)

3.4.4 Servo software (series 9040) for serial pulse coder

The servo ROM of series 9040 is used to drive a servo motor with a serial pulse coder.

It can be used for the following serial pulse coders:

Pulse coder type	Maximum number of pulses that can be detected	Absolute value communication	Applicable motor
Serial pulse coder A	1,000,000P/rev	Possible	S-series motor
Serial pulse coder B	250,000P/rev	Possible	T-series motor
Serial pulse coder C	40,000P/rev	Impossible	S-series motor

Motors with these serial pulse coders are driven with the servo ROM of different editions:

Serial pulse coders A and B : Series 9040, edition A and later
Serial pulse coder C : Series 9040, edition D and later

(1) Precautions in setting

- (a) In a semi-closed loop system, a flexible feed gear must be used.

When a serial pulse coder is used in a semi-closed loop system, DMR must be set according to the flexible feed gear. If a flexible feed gear is not used, an alarm will occur.

For the setting of the flexible feed gear, see Subsection 3.4.3 (3).

- (b) The servo ROM of 9040/001D and later editions can be used to drive a servo motor with serial pulse coder C.

3. STARTING UP DIGITAL SERVO

(c) A conventional dummy connector (A02B-0083-D011) can be used as a dummy connector for an axis to which a motor with the serial pulse coder is connected. If activation is attempted before changing the parameter, the alarm for incorrect parameter setting may occur. When this alarm is issued, change the gear ratio of the flexible feed gear of the axis to which the dummy connector is connected to 0/0.

(d) Use motor number 39 and up.

Use a motor number with a velocity loop period of 1 msec (regardless of the type of pulse coder used). When a motor with a velocity loop period other than 1 msec is used, an alarm occurs. So the motors (Nos. 1 to 38) with 2 msec set in the velocity loop period parameter must be changed to those with a velocity loop period of 1 msec. The method of converting the velocity loop period from 2 msec to 1 msec is described below.

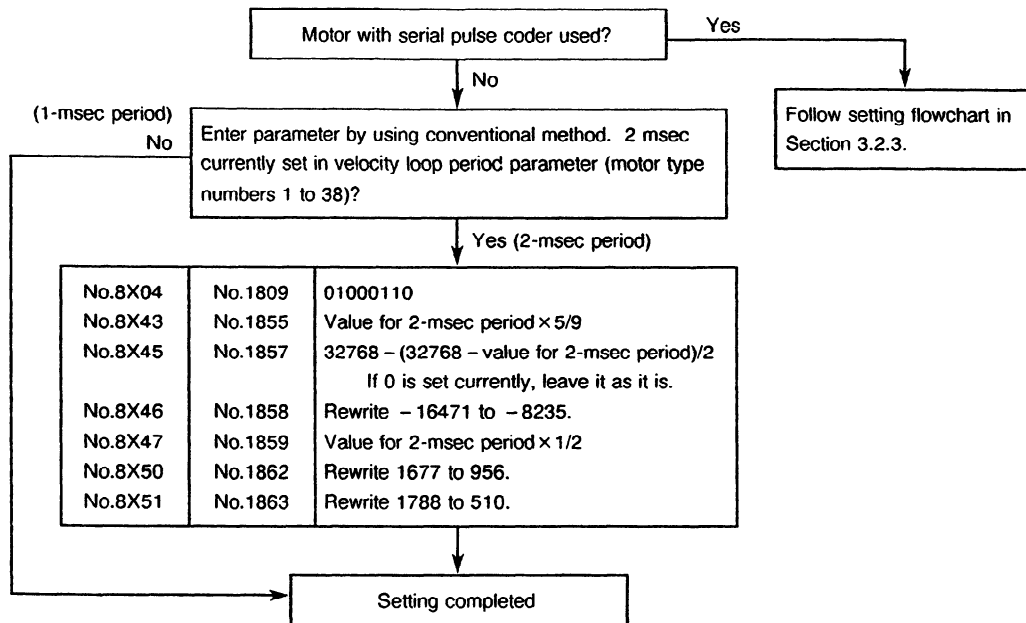

Instead, motors (from Nos. 1 to 38) with the standard parameters set can be initialized again using motor numbers 39 and up (standard velocity loop period: 1 msec).

3. STARTING UP DIGITAL SERVO

3.4.5 Motor type numbers

The digital servo ROM holds the standard parameters for each motor model. By setting a motor number in the motor type parameter (No.8X20 (Series 0), 1874 (Series 15)) and setting the initialization bit (bit 1 of No.8X00, 1804) to 0, the standard parameters are set when power is turned on. For detailed information about standard parameter setting for each motor model, see the parameter table provided in Section 2.16 in Part II.

(1) Notes on setting

- (a) The range of motor numbers stored in a servo ROM depends on the servo ROM series and edition.

9000E,9001B	and later editions: 3 to 14
9000H,9001E	and later editions: 3 to 25
9000L,9001H, 9010A	and later editions: 3 to 26
9000N,9001K,9002J,9010B,9020A	and later editions: 3 to 36
9000P,9001L,9002K,9010C,9020B,9022A	and later editions: 3 to 38
9010F,9020E,9022B,9030A	and later editions: 3 to 41
9010G,9020F,9022C,9030B	and later editions: 3 to 67
9020K, 9030G 9031A,	and later editions: 3 to 72
9030J 9031D,	and later editions: 3 to 73
9030K,9031E	and later editions: 3 to 78
9031F,9040A	and later editions: 3 to 83
9030O,9031H,9040D	and later editions: 3 to 84

If a value out of the stored range of motor numbers is set, a servo alarm occurs.

- (b) A motor type number is determined by a combination of a motor and servo amplifier, and also depends on velocity loop control period setting. See the flowchart below.

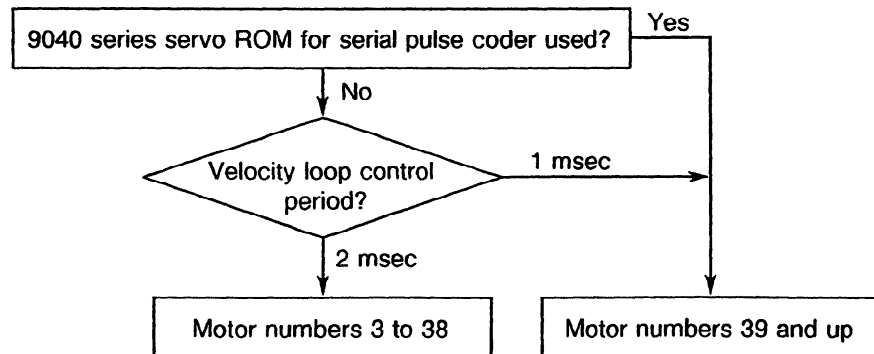

A velocity loop control period is determined by the parameter of an odd-numbered axis; two axes are paired in such a way that the first and second axes are paired, the third and fourth axes are paired, and so on. So, if the first axis is selected from the standard parameters

3. STARTING UP DIGITAL SERVO

(39 or later) with 1-msec velocity control, the second axis must also be selected from the standard parameters (39 or later) with 1-msec velocity control.

(c) The motor type numbers of SP motors are the same as for ordinary motors. (For example, the same motor type number as for 1-0S is used for 1-0SP, and the same motor type number as for 2-0S is used for 2-0SP.) If a high-resolution pulse coder (10000P) is used, standard parameter modification is required.

(d) Motor type numbers 74 to 77 are special for piston lathes.

(2) Motor type numbers based on combinations of a motor and amplifier

The table below lists the motor type numbers determined by combinations of a motor and servo amplifier.

(a) Motor type numbers with a velocity loop control period of 2 msec (3 to 38)

- ① 185 V input type and 220 V input types
- ② 230 V input type
- ③ Combination of 220 V input unit and 230 V PCB

(b) Motor type numbers with a velocity loop control period of 1 msec (39 to 84)

- ① 230 V input type
- ② 185 V input type
- ③ 230 V input type (T series motor)

[C series Servo Amp]

(c) Motor type numbers with a velocity loop control period of 2 msec (3 to 38)

(d) Motor type numbers with a velocity loop control period of 1 msec (39 to 84)

3. STARTING UP DIGITAL SERVO

(3) Motor type numbers with a velocity loop control period of 2 msec

① 185V input type and 220V input type

Motor model	5 0	4 0 S	3 0 S	2 0	1 0	0	5	10	20 S /	20 S	30	30 /	0 L	5 L	6 L	7 L	10 L	40	2 0 S * 2	1 0 S	1 0 S P	0 S	5 S	10 S	6 L		
Motor number	0	0	0	0	0	0	0	0	0	0	0	0	0	0	0	0	0	0	0	0	0	0	0	0	0	0	
A06B-XXXX-	3	3	3	2	2	1	1	0	0	0	0	0	6	6	6	7	7	8	8	1	1	7	1	1	1	6	
	1	2	3	1	2	3	2	1	5	2	3	6	1	2	3	1	2	1	1	2	2	3	4	5	4		
185V input type																											
A06B-6057-	PCB																										
H001	0430/0410	3																									
H002	0500/0600		4	5																							
H003	0670				6	7																					
H004	0670						8	9																			
H005	0670								10																		
H015	0670									11																	
H006	0670												12	13													
H007	0670													14													
H008	0670																										
H201	0680				6	7																					
H202	0680				6	7	8	9																			
H203	0680						8	9																			
H204	0680		4	5	6	7																					
H205	0680		4	5			8	9																			
H301	0280						8	9																			
H302	0280						8	9	10																		
H303	0280						8	9	10																		
H304	0280								10																		
H401	0670												15														
H402	0670													16	17												38
H403	0670															18	19										
220V input																											
A06B-6058-	PCB																										
H201	0720/0661																			21	22	22					
H202	0720/0662																			21	22	22	23	24			
H203	0720/0663																						23	24			
H204	0720/0664																						23	24	25		
H301	0220																						23	24			
H302	0220																						23	24	25		
H303	0220																						23	24	25		
H304	0220																								25		
H301/J005	0220																				21	22	22				
H301/J004	0220																				21	22	22	23	24		
H301/J003	0220																				21	22	22	23	24		

3. STARTING UP DIGITAL SERVO

② 230V input type

Motor model	4 0 S	3 0 S	20 S / 1 5 0 0	20 S	2 0 S * 2	2 0 S P	2 0 S * 2	1 0 S	1 0 S P	0 S	5 S	10 S	30 S
Motor number	0 5 3 2	0 5 3 3	0 5 0 5	0 5 0 2	0 3 1 0	0 3 7 1	0 3 1 1	0 3 1 2	0 3 1 2	0 3 1 3	0 3 1 4	0 3 1 5	0 5 9 0
A 0 6 B - X X X X													
2 3 0 V input type													
A06B-6058	P C B												
H 0 0 2	0730/0740	27	28										
H 0 0 3	0 0 3 0				37	37	29	30	30				
H 0 0 4	0090/0140										31	32	
H 0 0 5	0090/0081		34										33
H 0 0 6	0090/0080			35									36
H 0 0 7	0 3 0 0												
H 0 2 3	0090/0141												
H 0 2 5	0090/0084												
H 1 0 1	0 3 0 0												
H 1 0 2	0 3 0 0												
H 2 2 1	0800/0271				37	37	29	30	30				
H 2 2 2	0800/0272				37	37	29	30	30	31	32		
H 2 2 3	0800/0273									31	32		
H 2 2 4	0800/0274									31	32	33	
H 2 2 9	0800/0830												33
H 2 3 0	0800/0960												
H 2 3 1	0800/0961									31	32	33	
H 3 2 1	0 2 8 0									31	32		
H 3 2 2	0 2 8 0									31	32	33	
H 3 2 3	0 2 8 0									31	32	33	
H 3 2 4	0 2 8 0												33
H 3 2 5	0 2 8 0				37	37	29	30	30				
H 3 2 6	0 2 8 0				37	37	29	30	30	31	32		
H 3 2 7	0 2 8 0				37	37	29	30	30	31	32		
H 3 2 8	0 2 8 0				37	37	29	30	30				33
H 3 2 9	0 2 8 0				37	37	29	30	30				33
H 3 3 1	0330/0861				37	37	29	30	30				
H 3 3 2	0330/0862				37	37	29	30	30	31	32	33	
H 3 3 3	0330/0863				37	37	29	30	30	31	32	33	
H 3 3 4	0330/0864									31	32	33	

③ Combination of 220V input unit and 230V PCB

Motor model	2 0 S * 2	2 0 S P	2 0 S * 2	1 0 S	1 0 S P	0 S	5 S	10 S
Motor number	0 3 1 0	0 3 7 1	0 3 1 1	0 3 3 2	0 3 7 2	0 3 3 3	0 3 1 4	0 3 1 5
A 0 6 B - X X X X								
*220V input unit +230V PCB Combination								
A06B-6058	P C B							
H 2 0 1	0 8 0 0	37	37	29	30	30		
H 2 0 2	0 8 0 0	37	37	29	30	30	31	32
H 2 0 3	0 8 0 0						31	32
H 2 0 4	0 8 0 0						31	32
H 3 0 1	0 2 8 0						31	32
H 3 0 2	0 2 8 0						31	32
H 3 0 3	0 2 8 0						31	32
H 3 0 4	0 2 8 0							33
H301/J005	0 2 8 0			29	30	30		
H301/J004	0 2 8 0			29	30	30	31	32
H301/J003	0 2 8 0			29	30	30	31	32

3. STARTING UP DIGITAL SERVO

(4) Combination of 220V input unit and 230V PCB

① 230V input type

Motor model	4 S	3 S	2 S	2 S	1 S	1 S	0 S	5 S	6 S	10 S	20 S	20 S	30 S	50 S	60 S	70 S	2 S	2 S	1 S	1 S	0 S	5 S	6 S	10 S	20 S	30 S	40 S	
	0	0	0	0	0	0	0	0	0	0	0	0	0	0	0	0	0	0	0	0	0	0	0	0	0	0	0	0
Motor number	5	5	3	3	3	3	3	3	3	3	5	5	5	3	3	3	0	0	0	0	0	0	0	0	0	0	0	0
A06B-XXXX	3	3	1	7	1	7	1	1	1	1	0	0	9	3	3	3	1	1	7	9	3	3	5	3	3	3	3	5
230V input type	2	3	0	1	2	2	3	4	6	5	5	2	0	1	2	3	0	1	9	3	3	4	0	0	7	8	9	3
A06B-6058																												
H002	43	44																										
H003			45	45	46	46																						
H004							63	48																				
H005									49	50	51											63						
H006												52	53															
H007																										66	67	78
H023																		61	61	62	62							
H025																						64	65					
H101														39														
H102															40	41												
H221			45	45	46	46												61	61	62	62							
H222			45	45	46	46	63	48										61	61	62	62							
H223							63	48																				
H224							63	48		50												63						
H229										50												63						
H230																										64		
H231							63	48		50												63	64	73				
H251												52	53									64	65					
H252										50	51	52	53															
H253										50	51																	
H321							63	48																				
H322							63	48		50																		
H323							63	48		50																		
H324										50																		
H325			45	45	46	46																						
H326			45	45	46	46	63	48																				
H327			45	45	46	46	63	48																				
H328			45	45	46	46				50																		
H329			45	45	46	46				50																		
H331			45	45	46	46																62	62	63				
H332			45	45	46	46	63	48		50												62	62	63				
H333			45	45	46	46	63	48		50												62	62	63				
H334							63	48		50												63						

3. STARTING UP DIGITAL SERVO

② 185V input type

Motor model	5 1 0	30 / 2 0 0 0	40	0 L	5 L	6 L	7 L	10 L	0 L / 3 0 0 0	5 L / 3 0 0 0	6 L / 3 0 0 0	7 L / 3 0 0 0
Motor number A 0 6 B - X X X X -	0 5 3 1	0 5 5 6	0 5 8 1	0 5 6 1	0 5 6 2	0 5 6 4	0 5 7 1	0 5 7 2	0 5 6 1	0 5 6 2	0 5 6 4	0 5 7 1
1 8 5 V input type												
A06B-6057-	P C B											
H 0 0 1	0430/0410	42										
H 0 0 7	0 6 7 0		54									
H 0 0 8	0 6 7 0		55									
H 4 0 1	0 6 7 0			68					68			
H 4 0 2	0 6 7 0				69	70				69	70	
H 4 0 3	0 6 7 0						71	72				71

③ 230V input type

Motor model	0 / 3 0 0 0 0	5 T / 2 0 0 0 0	5 T / 3 0 0 0 0	10 T / 2 0 0 0 0	10 T / 3 0 0 0 0
Motor number A 0 6 B - X X X X	0 3 8 1	0 3 8 2	0 3 8 3	0 3 8 4	0 3 8 5
2 3 0 V input type					
A06B-6058	P C B				
H 0 0 4	0090/0140	79	80		
H 0 0 5	0090/0081			82	
H 0 2 5	0090/0084		81		83
H 2 2 2	0800/0272		80		
H 2 2 3	0800/0273		80		
H 2 2 4	0800/0274	79	80		82
H 2 2 9	0800/0830	79			82
H 2 3 0	0800/0960			81	
H 2 3 1	0800/0961	79	80	81	82
H 3 3 2	0330/0862	79	80		82
H 3 3 3	0330/0863	79	80		82
H 3 3 4	0330/0864	79	80		82

3. STARTING UP DIGITAL SERVO

(5) Motor type numbers with a velocity loop control period of 2 msec

Standard parameter setting for the C series servo amplifiers

Motor model	4	3	2	2	1	1	0	0	5	6	10	20	20	30	5	10	20	30	40
	0	0	0	0	0	0	0	0	0	0	0	0	0	0	0	0	0	0	0
	S	S	S	S	S	S	S	S	S	S	S	S	S	S	S	S	S	S	S
			*																
			2																
Motor number	0	0	0	0	0	0	0	0	0	0	0	0	0	0	0	0	0	0	0
A 0 6 B - X X X X -	5	5	3	3	3	3	3	3	3	3	3	5	5	5	5	3	3	3	5
	3	3	1	7	1	7	7	1	1	1	1	0	0	9	1	1	1	1	8
	2	3	0	1	2	2	4	3	4	6	5	5	2	0	4	7	8	9	3
2 3 0 V input type																			
A06B-6066-	P C B																		
H 0 0 2	-1200-0911	43	44																
H 0 0 3	-1200-0910			45	45	46	46												
H 0 0 4	-1004-0851							84	63	48	49	50	51						
H 0 0 6	-1004-0850													52	53	64	65		
H 0 0 8	-1005-0210 -1005-0220																	66	67 78
H 2 2 2	-1004-0866	43	44																
H 2 2 3	-1004-0865	43	44	45	45	46	46												
H 2 2 4	-1004-0864	43	44					84	63	48		50							
H 2 3 3	-1004-0863			45	45	46	46												
H 2 3 4	-1004-0862			45	45	46	46	84	63	48		50							
H 2 4 4	-1004-0860							84	63	48		50							
H 2 3 6	-1005-0872			45	45	46	46								64				
H 2 4 6	-1005-0871							84	63	48	49	50			64				
H 2 6 6	-1005-0870														64				

(6) Motor type numbers with a velocity loop control period of 1 msec

Standard parameter setting for the C series servo amplifiers

Motor model	4	3	2	2	1	1	0	5	6	10	20	20	30	5	10
	0	0	0	0	0	0	0	0	0	0	0	0	0	0	0
	S	S	S	S	S	S	S	S	S	S	S	S	S	S	S
			*												
			2												
Motor number	0	0	0	0	0	0	0	0	0	0	0	0	0	0	0
A 0 6 B - 6 0 6 6	5	5	3	3	3	3	3	3	3	3	5	5	5	5	3
	3	3	1	7	1	7	1	1	1	1	0	0	9	1	1
	2	3	0	1	2	2	3	4	6	5	5	2	0	4	7
2 3 0 V input type															
A06B-6066-	P C B														
H 0 0 2	-1200-0911	43	44												
H 0 0 3	-1200-0910			45	45	46	46								
H 0 0 4	-1004-0851							63	48	49	50	51			
H 0 0 6	-1004-0850												52	53	64 65
H 2 2 2	-1004-0866	43	44												
H 2 2 3	-1004-0865	43	44	45	45	46	46								
H 2 2 4	-1004-0864	43	44					63	48		50				
H 2 3 3	-1004-0863			45	45	46	46								
H 2 3 4	-1004-0862			45	45	46	46	63	48		50				
H 2 4 4	-1004-0860							63	48		50				

3. STARTING UP DIGITAL SERVO

(Note 1) The numbers in the tables indicate motor type numbers to be set in No. 1874 (Series 15) or 8X20 (Series 0).

(Note 2) When using or replacing a 2-0S motor, carefully check the motor specification (0310, 0311).

(Note 3) When the model 2-0S (0310) is used with a 220 V amplifier, change the setting of the current dead zone compensation parameters (PPMAX, PDDP) as follows:

Motor type number	No.1874, 8X20 = 37
PPMAX	No.1865, 8X53 →30
PDDP	No.1866, 8X54 →12500

(Note 4) Compatibility between 220 V and 230 V types

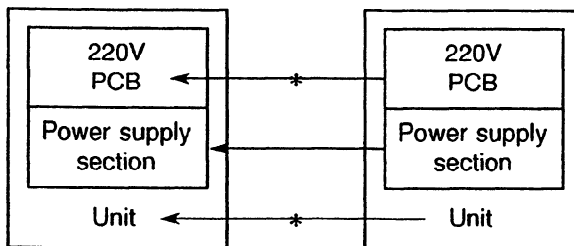

There is an upward compatibility between the two types.

However, when a PCB marked with * is changed, the current dead zone compensation parameters (PPMAX, PDDP) need to be altered.

PPMAX	No.1865, 8X53
PDDP	No.1866, 8X54

(Note 5) When a 2-0S or 0S motor is used for 2000 rpm and 3000 rpm, the same motor is used but the parameter and amplifier are changed.

(7) List of printed circuit boards

AC-185V	Number of axes	Applicable motor
A20B-1001-0430	1	5-0
A20B-1002-0500	1	4-0S, 3-0S
A16B-1200-0670	1	2-0 to 40
A16B-1200-0680	2	4-0S to 5
A20B-1002-0280	3	0 to 5
AC-220V		
A16B-1200-0720	2	2-0S to 10S
A16B-1100-0220	3	2-0S to 10S
AC-230V		
A20B-1002-0730	1	4-0S, 3-0S
A20B-1003-0030	1	2-0S, 1-0S
A20B-1003-0090	1	0S to 30S, 2-S (3000), 5S/3000, 10S/30
A16B-1100-0300	1	50S to 70S, 20S/3000, 30S/3000
A16B-1200-0800	2	2-0S to 10S
A16B-2201-0020	2	5S/3000 to 30S
A16B-1100-0280	3	2-0S to 10S
A16B-1100-0330	3	2-0S to 10S, 2-S (3000), 0S (3000)

3. STARTING UP DIGITAL SERVO

(Note) The printed circuit boards for the 220V and 230V types differ from each other in the specification and standard parameters. With the modified editions (A06R-6058-0003 to 0005) of the 220V type (2-0S to 5S), the resistance of RM1 in the unit is changed.

4. AC SERVO AMPLIFIER MAINTENANCE

4.1 Types and Configurations of Servo Amplifiers

(Note) Make correct connections between a servo amplifier and motor used. If a wrong combination of an amplifier and motor is used, a malfunction such as motor vibration can occur, thus causing a failure.

Table 4.1 (a) 185V input type

	Motor to be applied			Drawing number of PCB	Drawing number of PCB	
	L-axis	M-axis	N-axis		PWM controller	Power controller
1-axis amp.	5-0		—	A06B-6057-H001	A20B-1001-0430 See Fig. 4.2 (a)	A20B-1001-0410
	4-0S, 3-0S		—	A06B-6057-H002	A20B-1002-0500 See Fig. 4.2 (b)	A20b-1000-0600
	2-0, 1-0		—	A06B-6057-H003	A16B-1200-0670 See Fig. 4.2 (c)	—
	0, 5		—	A06B-6057-H004		
	10		—	A06B-6057-H005		
	20S/1500		—	A06B-6057-H015		
	20S, 30		—	A06B-6057-H006		
	30/2000		—	A06B-6057-H007		
	40		—	A06B-6057-H008		
	0L		—	A06B-6057-H401		
	5L, 6L		—	A06B-6057-H402		
	7L, 10L		—	A06B-6057-H403		
2-axis amp.	2-0, 1-0	2-0, 1-0	—	A06B-6057-H201	A16B-1200-0680 See Fig. 4.2 (d)	—
	2-0, 1-0	0, 5	—	A06B-6057-H202		
	0, 5	0, 5	—	A06B-6057-H203		
3-axis amp.	0, 5	0, 5	0, 5	A06B-6057-H301	A20B-1002-0280 See Fig. 4.2 (e)	—
	0, 5	0, 5	10	A06B-6057-H302		
	0, 5	10	10	A06B-6057-H303		
	10	10	10	A06B-6057-H304		

4. AC SERVO UNIT MAINTENANCE

Table 4.1 (b) 200V input type (200V/220V)

	Motor to be applied			Drawing number of PCB	Drawing number of PCB	
	L-axis	M-axis	N-axis		PWM controller	Power controller
2-axis amp.	2-0S 1-0S	2-0S 1-0S	—	A06B-6058-H201	A16B-1200-0720 See Fig. 4.2 (f)	A20B-1002-0661
	2-0S 1-0S	0S 5S	—	A06B-6058-H202		A20B-1002-0662
	0S 5S	0S 5S	—	A06B-6058-H203		A20B-1002-0663
	0S 5S	10S	—	A06B-6058-H204		A20B-1002-0664
3-axis amp.	0S 5S	0S 5S	0S 5S	A06B-6058-H301	A16B-1100-0220 See Fig. 4.2 (g)	—
	0S 5S	0S 5S	10S	A06B-6058-H302		
	0S 5S	10S	10S	A06B-6058-H303		
	10S	10S	10S	A06B-6058-H304		

4. AC SERVO UNIT MAINTENANCE

Table 4.1 (c) 200V input type (200V/230V) (1/2)

	Motor to be applied		Drawing number of PCB	Drawing number of PCB	
	L-axis	M-axis		PWM controller	Power controller
1-axis amp.	4-0S, 3-0S		A06B-6058-H002	A20B-1002-0730 See Fig. 4.2 (h)	A20B-1002-0740
	2-0S, 1-0S		A06B-6058-H003	A20B-1003-0030 See Fig. 4.2 (i)	—
	0S, 5S, 5T/2000		A06B-6058-H004	S20B-1003-0090 See Fig. (j)	A20B-1003-0140
	0S☆, 10S, 20S/1500 10T/2000, 0T/3000		A06B-6058-H005		A20B-1003-0081
	20S, 30S		A06B-6058-H006		A20B-1003-0080
	20S/3000 30S/3000, 40S/2000		A06B-6058-H007	A16B-1100-0300 See Fig 4.2 (n)	—
	2-0S☆ 1-0S/3000		A06B-6058-H023	A20B-1003-0090 See Fig. 4.2 (j)	A20B-1003-0141
	5S/3000, 10S/3000 5T/3000, 10T/3000		A06B-6058-H025		A20B-1003-0084
	50S		A06B-6058-H101	A16B-1100-0300 See Fig. 4.2 (n)	—
	60S, 70S		A06B-6058-H102		
2-axis amp.	2-0S, 1-0S 1-0/3000 2-0S☆	2-0S, 1-0S 1-0/3000 2-0S☆	A06B-6058-H221	A16B-1200-0800 See Fig. 4.2 (k1) and (k2)	A20B-1003-0271 or A20B-1004-0881
	2-0S, 1-0S 1-0/3000 2-0S☆	0S, 5S 5T/2000	A06B-6058-H222		A20B-1003-0272 or A20B-1004-0882
	0S, 5S 5T/2000	0S, 5S 5T/2000	A06B-6058-H223		A20B-1003-0273 or A20B-1004-0883
	0S, 5S 5T/2000	10S, 0S☆ 0T/3000 10T/2000	A06B-6058-H224		A20B-1003-0274 or A20B-1004-0884
	10S, 0S☆ 0T/3000 10T/2000	10S, 0S☆ 0T/3000 10T/2000	A06B-6058-H229		A20B-1003-0830
	5S/3000 5T/3000	5S/3000 5T/3000	A06B-6058-H230		A20B-1003-0960
	0S☆, 5S 0S, 10S 0T/3000 5T/2000 10T/2000	5S/3000 6S/3000 5T/3000	A06B-6058-H231		A20B-1003-0961

0S☆ and 2-0S☆ mean when using 0S and 20S respectively at 3000 rpm.

4. AC SERVO UNIT MAINTENANCE

Table 4.1 (c) 200V input type (200V/230V) (2/2)

	Motor to be applied		Drawing number of PCB	Drawing number of PCB	
	L-axis	M-axis		PWM controller	Power controller
2-axis amp.	5S/3000 10S/3000 20S, 30S	10S/3000 20S, 30S	A06B-6058-H251	A16B-2201-0020 See Fig. 4.2 (k3)	A20B-1004-0671
	10S 20S/1500	10S/3000 20S, 30S	A06B-6058-H252		A20B-1004-0672
	10S 20S/1500	20S/1500	A06B-6058-H253		A20B-1004-0673

Table 4.1 (d) 200V input type (200V/230V) (1/2)

	Motor to be applied			Drawing number of PCB	Drawing number of PCB	
	L-axis	M-axis	N-axis		PWM controller	Power controller
3-axis amp.	0S, 5S	0S, 5S	0S, 5S	A06B-6058-H321	A16B-1100-0280 See Fig. 4.2 (l)	—
	0S, 5S	0S, 5S	10S	A06B-6058-H322		
	0S, 5S	10S	10S	A06B-6058-H323		
	10S	10S	10S	A06B-6058-H324		
	2-0S 1-0S	2-0S 1-0S	2-0S 1-0S	A06B-6058-H325		
	2-0S 1-0S	2-0S 1-0S	0S 5S	A06B-6058-H326		
	2-0S 1-0S	0S 5S	0S 5S	A06B-6058-H327		
	2-0S 1-0S	2-0S 1-0S	10S	A06B-6058-H328		
	2-0S 1-0S	10S	10S	A06B-6058-H329		

4. AC SERVO UNIT MAINTENANCE

Table 4.1 (d) 200V input type (200V/230V) (2/2)

	Motor to be applied			Drawing number of PCB	Drawing number of PCB	
	L-axis	M-axis	N-axis		PWM controller	Power controller
3-axis amp. (Note)	2-0S	2-0S	2-0S	A06B-6058-H331	A16B-1100-0330 See Fig. 4.2 (m)	A20B-1003-0861
	1-0S	1-0S	1-0S			
	1-0S/ 3000	1-0S/ 3000	1-0S/ 3000			
	2-0S	2-0S	0S, 5S, 10S	A06B-6058-H332		A20B-1003-0862
1-0S	1-0S	0T/3000				
1-0S/ 3000	1-0S/ 3000	5T/2000 10T/ 2000				
2-0S	0S	0S	A06B-6058-H333	A20B-1003-0863		
1-0S	5S	5S				
1-0S/ 3000	10S	10S				
	0T/3000	0T/3000				
	5T/2000	5T/2000	A06B-6058-H334	A20B-1003-0864		
	10T/ 2000	10T/ 2000				
0S	0S	0S				
5S	5S	5S				
10S	10S	10S				
0T/3000	0T/3000	0T/3000				
5T/2000	5T/2000	5T/2000				
10T/ 2000	10T/ 2000	10T/ 2000				

(Note) The 2-0S and the 0S can be used up to 3000 rpm.

4. AC SERVO UNIT MAINTENANCE

Table 4.1 (e) 200V input type (200V/230V) (C series servo amplifier)

	Motor to be applied		Drawing number of PCB	Drawing number of PCB	
	L-axis	M-axis		PWM controller	Power controller
1-axis amp.	4-0S, 3-0S		A06B-6066-H002	A20B-2900-0610 (X1)	A16B-1200-0911
	2-0S, 1-0S, 1-0SP/3000		A06B-6066-H003	A20B-2900-0620 (X1)	A16B-1200-0910
	0-0SP, 0S, 5S, 10S, 20S/1500, 0T/3000, 5T/2000, 10T/2000, 0L		A06B-6066-H004	A20B-2900-0630 (X1) See Fig 4.2(r)	A20B-1004-0851
	5S/3000, 10S/3000 20S, 30S, 5L, 6L, 5T/3000, 10T/2000		A06B-6066-H006		A20B-1004-0850
	20S/3000, 30S/3000 40S/2000, 7L, 10L		A06B-6066-H008	A20B-2901-0200 A20B-2901-0240 A20B-2900-0630	A20B-1005-0210 A20B-1005-0220
2-axis amp.	4-0S, 3-0S	4-0S, 3-0S	A06B-6066-H222	A20B-2900-0610 (X1)	A20B-1004-0866
	4-0S, 3-0S	2-0SP 1-0SP 1-0SP/3000	A06B-6066-H223	A20B-2900-0620 (X2) A20B-2900-0630 (X1) See Fig 4.2(r)	A20B-1004-0865
	4-0S, 3-0S	0-0SP, 0S, 5S, 0T/3000, 10S, 5T/2000, 10T/2000	A06B-6066-H224		A20B-1004-0864
	2-0SP 1-0SP 1-0SP/3000	2-0SP 1-0SP 1-0SP/3000	A06B-6066-H233		A20B-1004-0863
	2-0SP 1-0SP 1-0SP/3000	0-0SP, 0S, 5S, 0T/3000, 10S, 5T/2000, 10T/2000	A06B-6066-H234		A20B-1004-0862
	0-0SP, 0S, 5S, 0T/3000, 10S, 5T/2000, 10T/2000	0-0SP, 0S, 5S, 0T/3000, 10S, 5T/2000, 10T/2000	A06B-6066-H244		A20B-1004-0860

4. AC SERVO UNIT MAINTENANCE

Table 4.1 (f) 200-V Input Type (200/230 V) (C Series Servo Amplifier)

	Applicable motor		Drawing number of servo amplifier	Drawing number of PC board	
	L-axis	M-axis		Control unit	Power circuit unit
2-axis amp.	2-0S/3000 1-0S 1-0S/3000	5S/3000	A06B-6066-H236	A20B-2900-0610 (X1) A20B-2900-0620 (X2)	A20B-1004-0872
	0-0SP, 10F 0S, 5S, 5F 0S/3000	5S/3000	A06B-6066-H246	A20B-2900-0630 (X1)	A20B-1004-0871
	5S/3000	5S/3000	A06B-6066-H266		A20B-1004-0870

4. AC SERVO UNIT MAINTENANCE

4.2 Maintenance Parts Location on PCBs

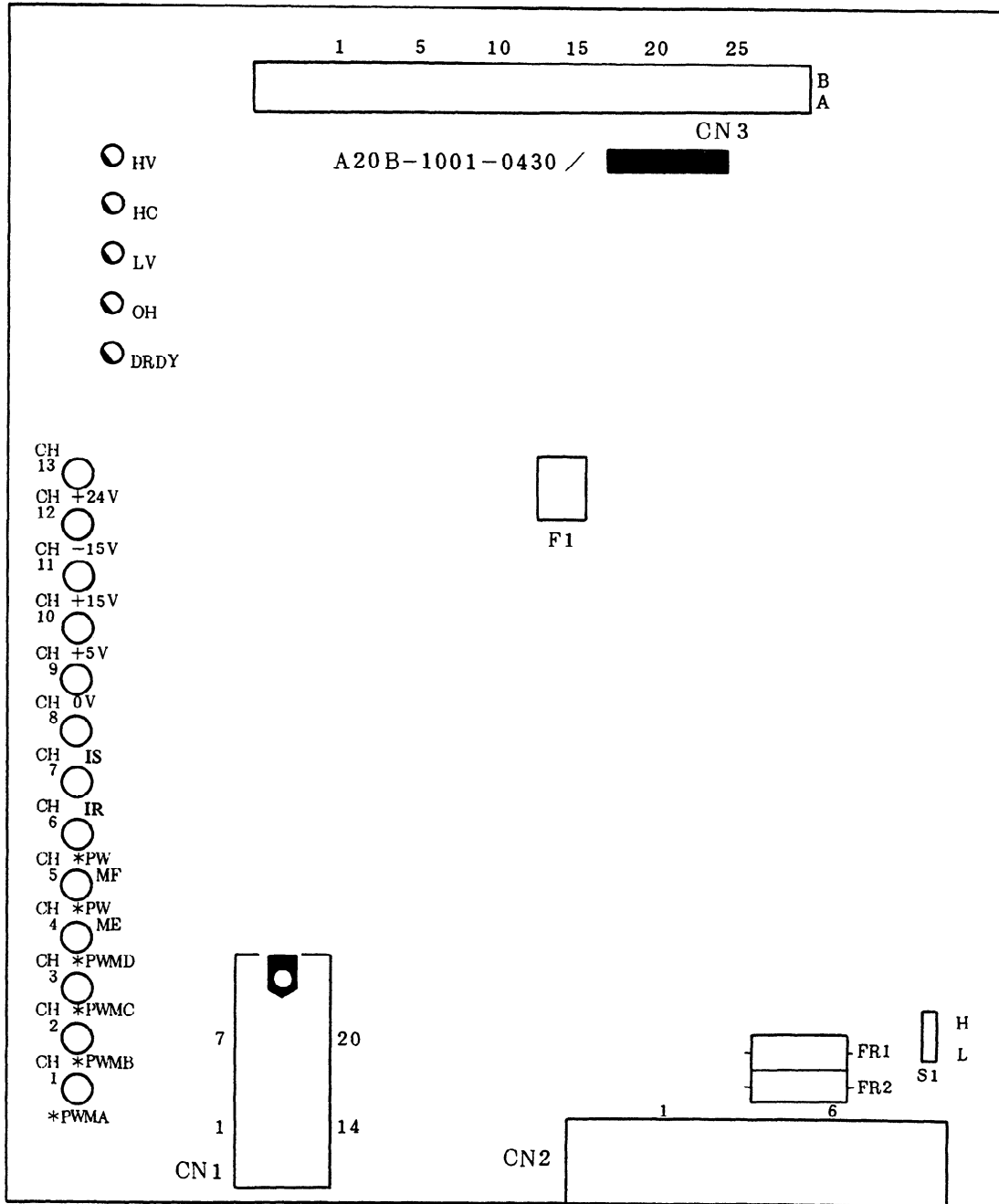

Fig. 4.2 (a) 1-axis amplifier for model 5-0 (A20B-1001-0430)

4. AC SERVO UNIT MAINTENANCE

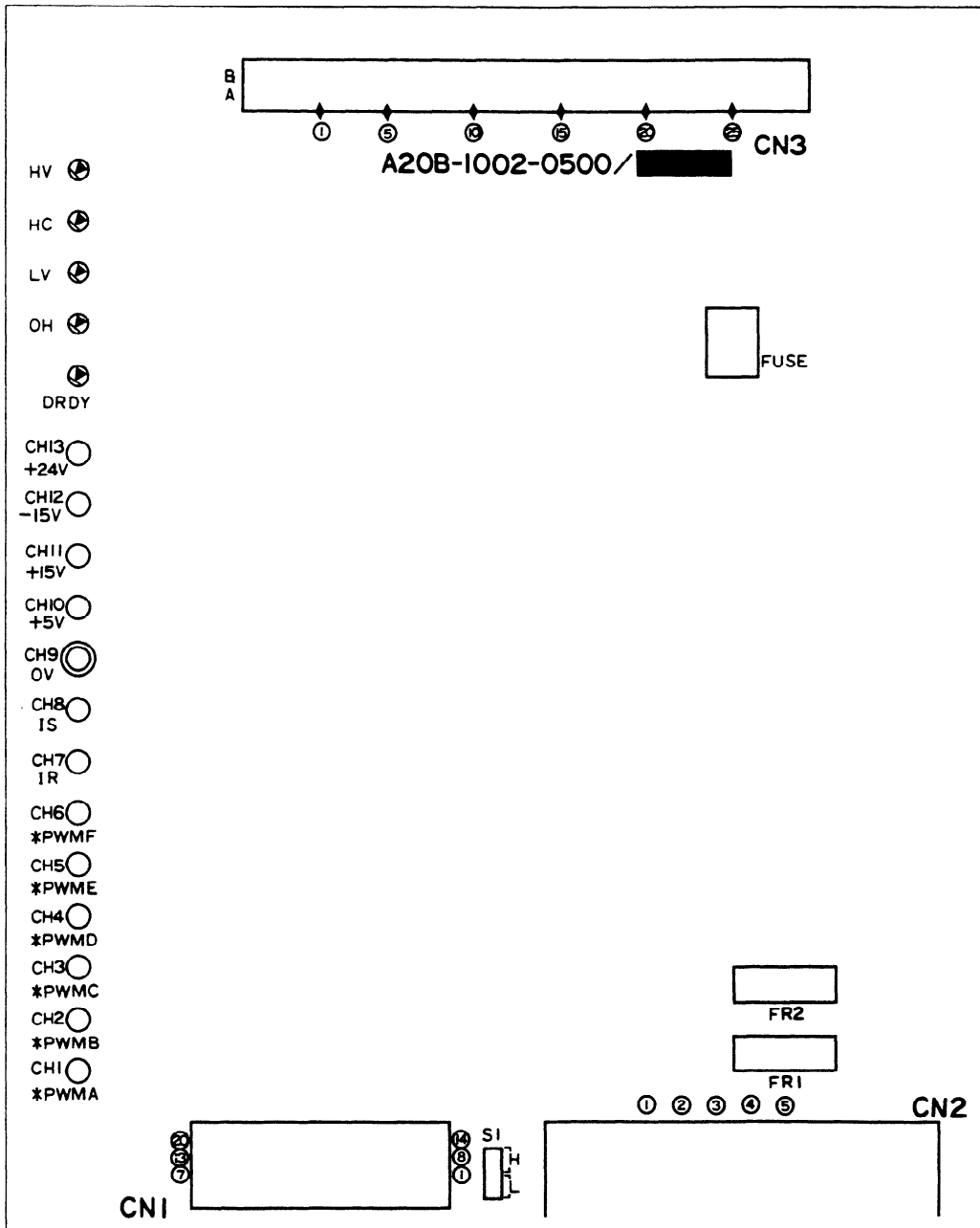

Fig. 4.2 (b) 1-axis amplifier for model 4-0S/3-0S (A20B-1002-0500)

4. AC SERVO UNIT MAINTENANCE

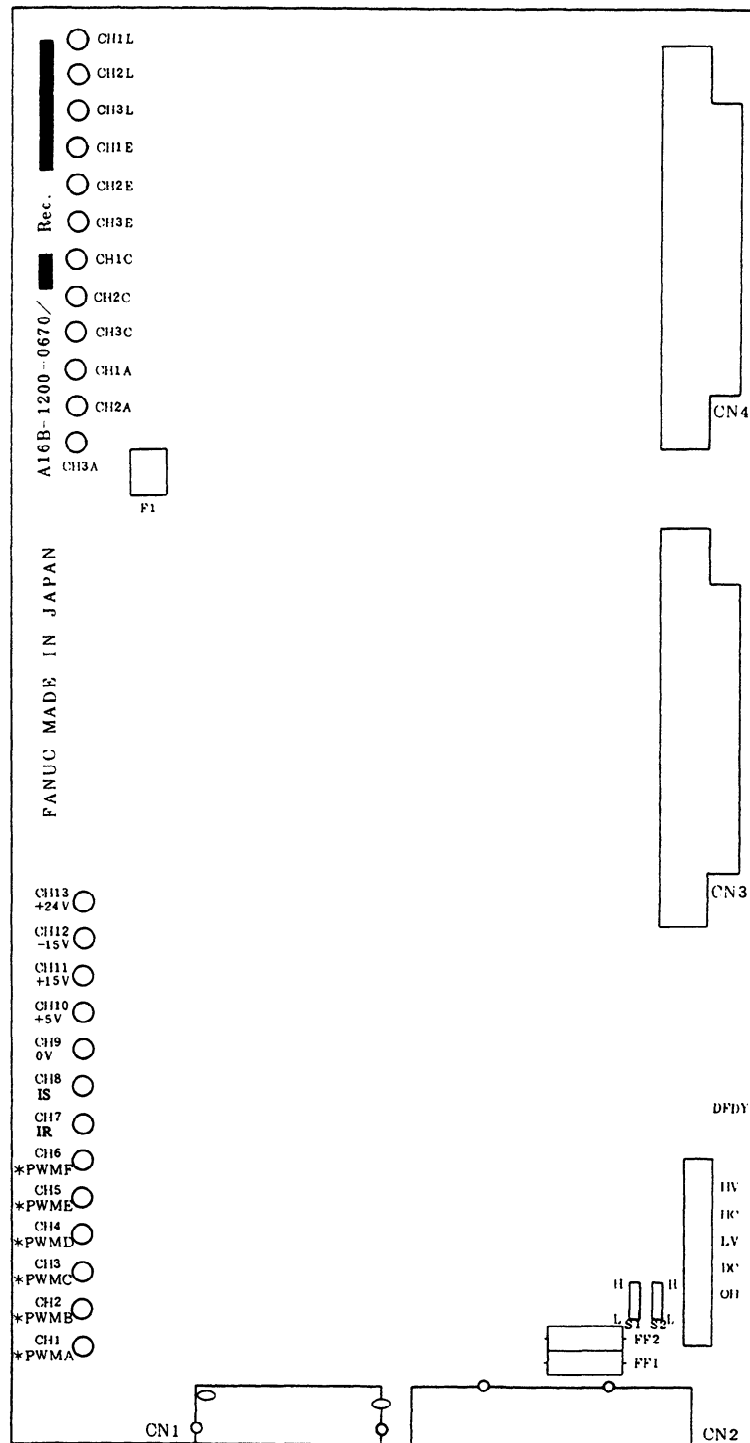

Fig. 4.2 (c) 1-axis amplifier for model 2-0-40 (A16B-1200-670)
 1-axis amplifier for model 0L-10L

4. AC SERVO UNIT MAINTENANCE

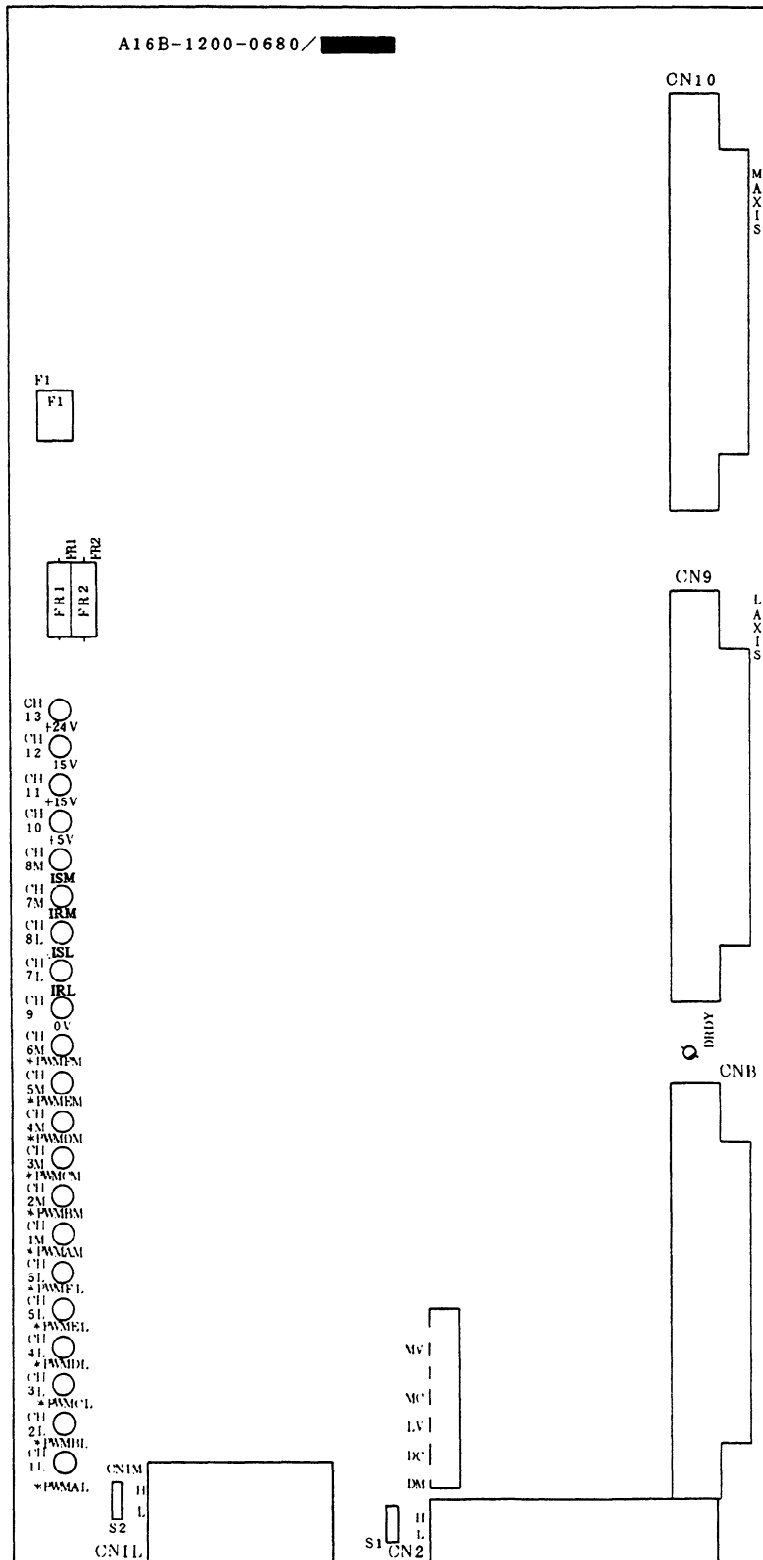

Fig. 4.2 (d) 2-axis amplifier for model 2-0-5 (A16B-1200-0680)

4. AC SERVO UNIT MAINTENANCE

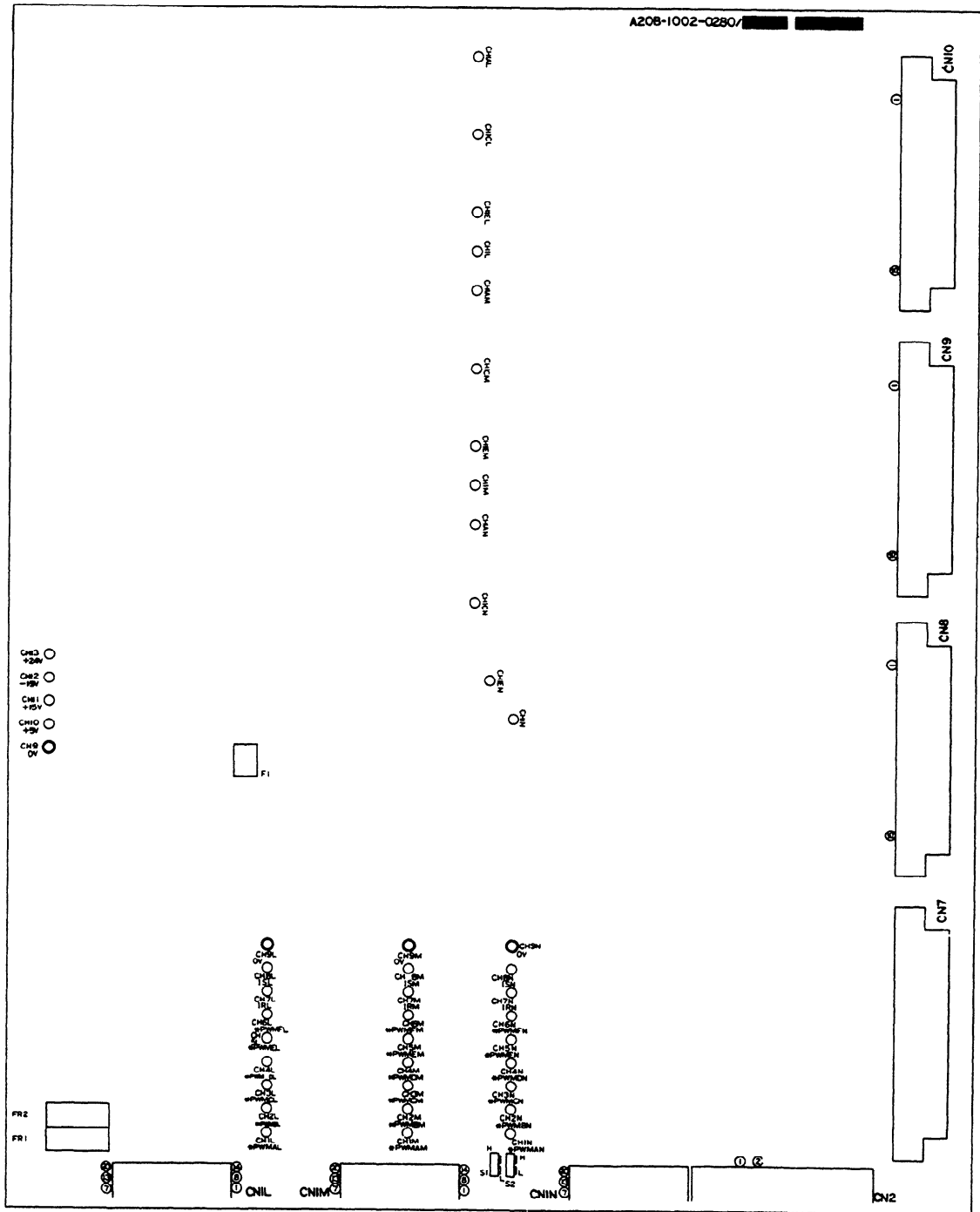

Fig. 4.2 (e) 3-axis amplifier for model 0-10 (A20B-1002-0280)

4. AC SERVO UNIT MAINTENANCE

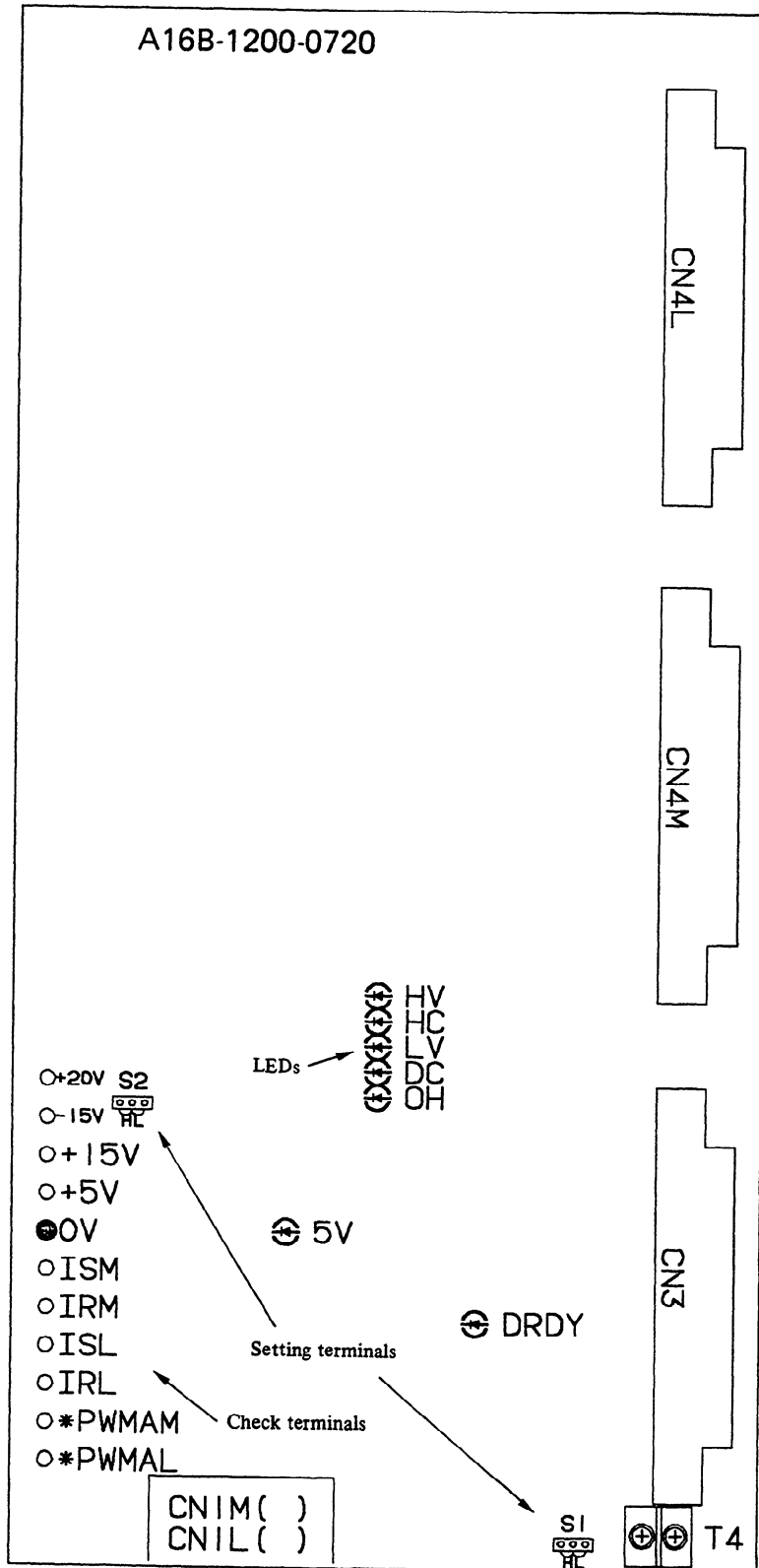

Fig. 4.2 (f) 2-axis amplifier for model 2-0S-10S (A16B-1200-0720)

4. AC SERVO UNIT MAINTENANCE

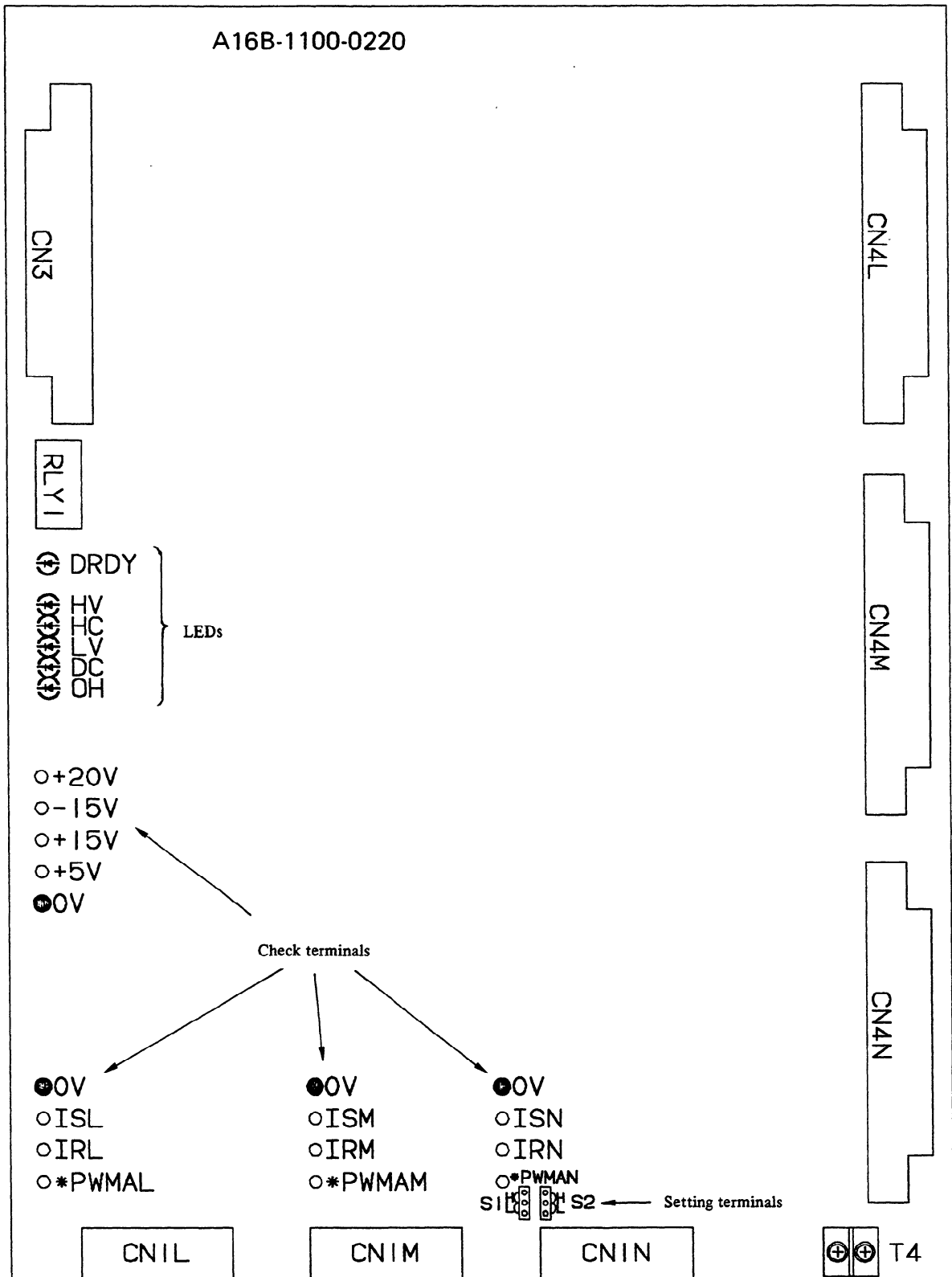

Fig. 4.2 (g) 3-axis amplifier for model OS-10S (A16B-1100-0220)

4. AC SERVO UNIT MAINTENANCE

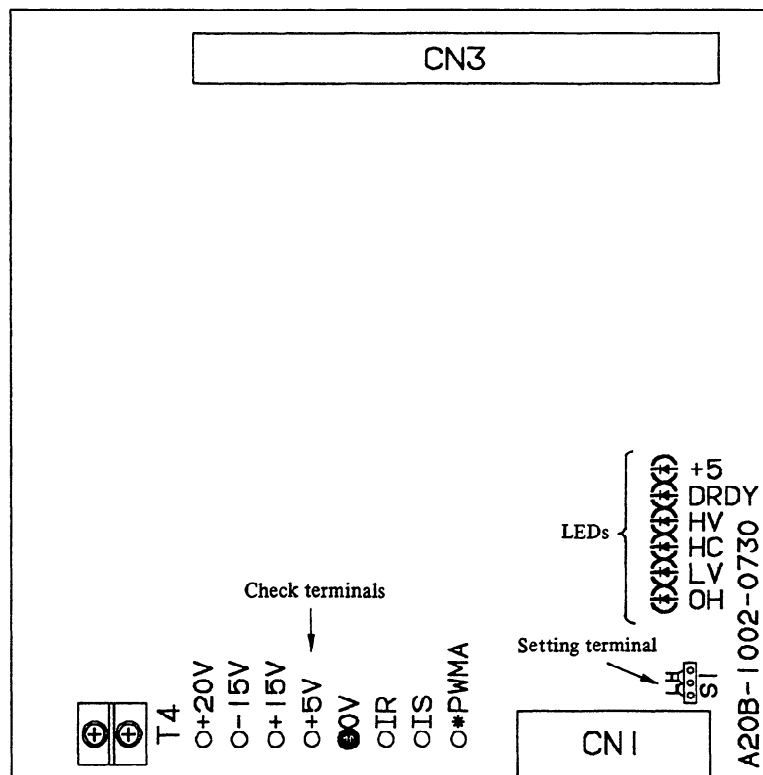

Fig. 4.2 (h) 1-axis amplifier for model 4-0S/3-0S (A20B-1002-0730)

4. AC SERVO UNIT MAINTENANCE

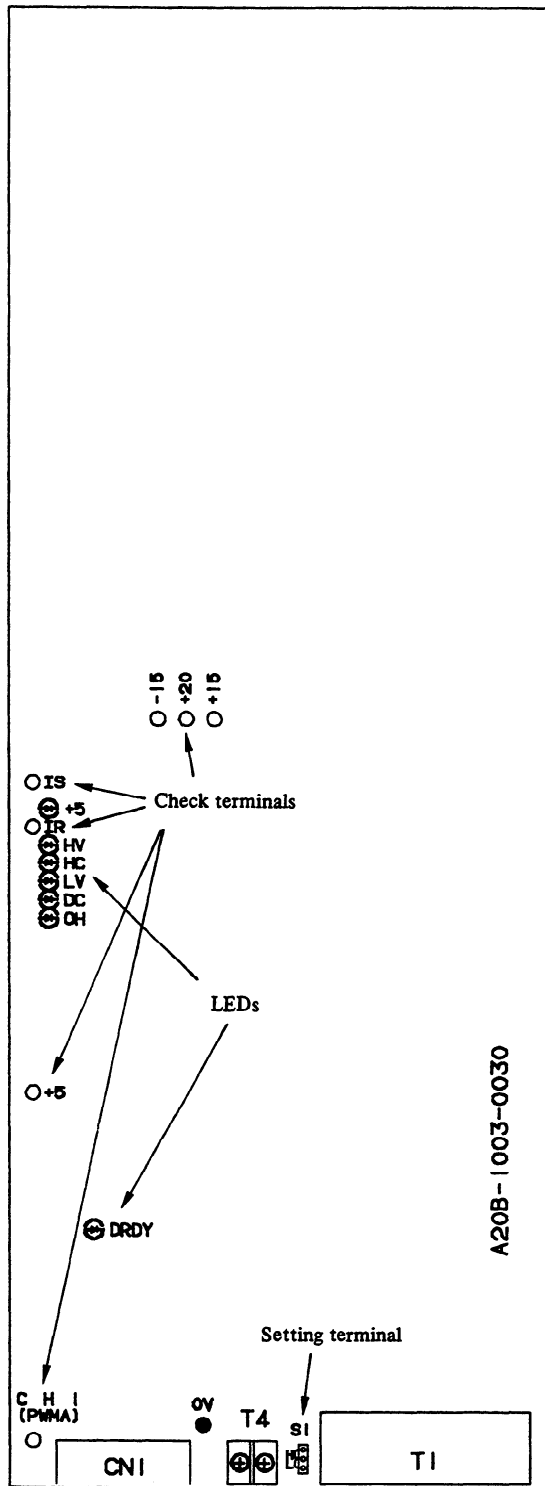

Fig. 4.2 (i) 1-axis amplifier for model (2-0S/1-0S) (A20B-1003-0030)

4. AC SERVO UNIT MAINTENANCE

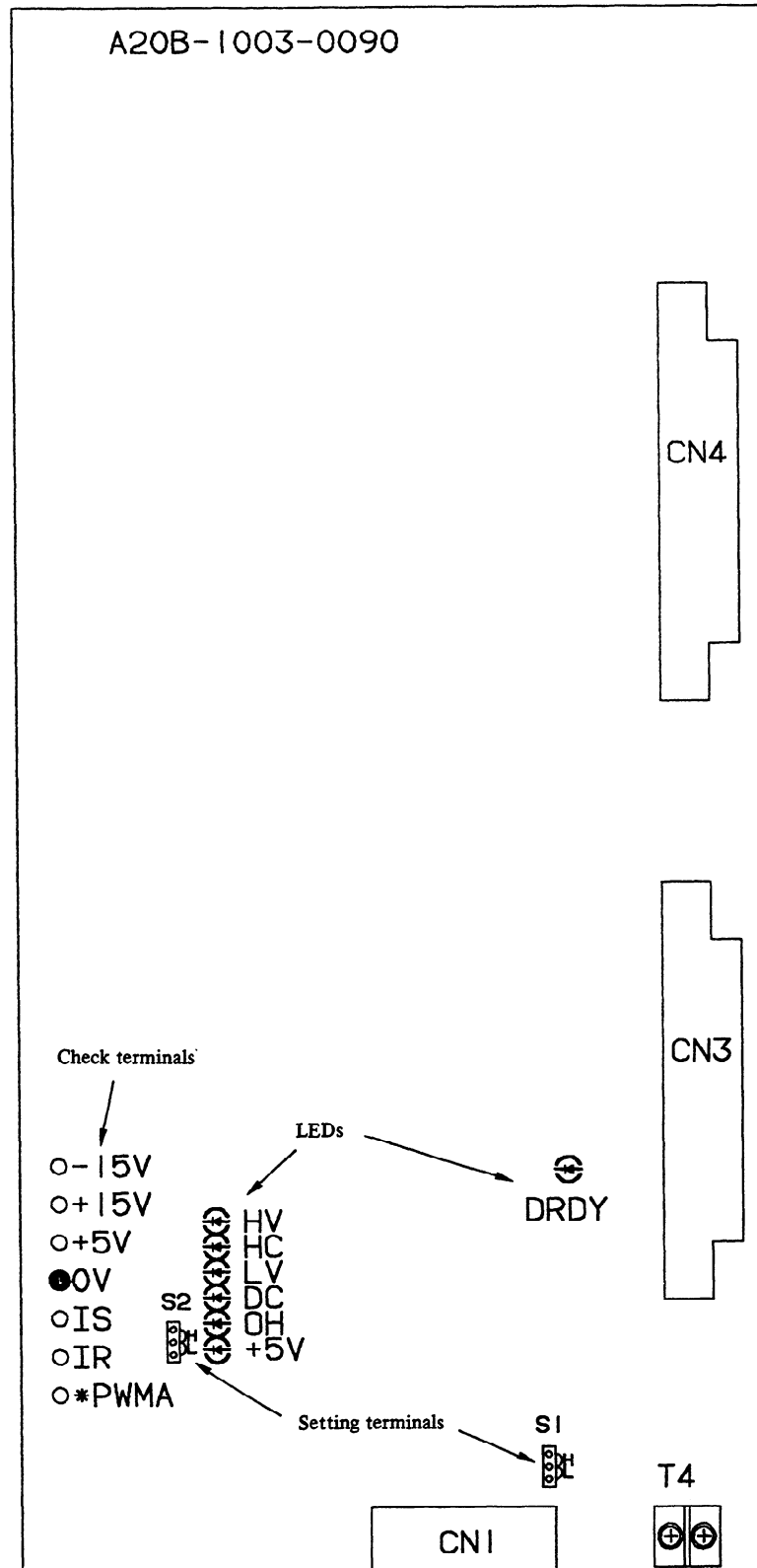

Fig. 4.2 (j) 1-axis amplifier for model OS-30S, 2-0S (3000 rpm)-10S/3000 (A20B-1003-0090)

4. AC SERVO UNIT MAINTENANCE

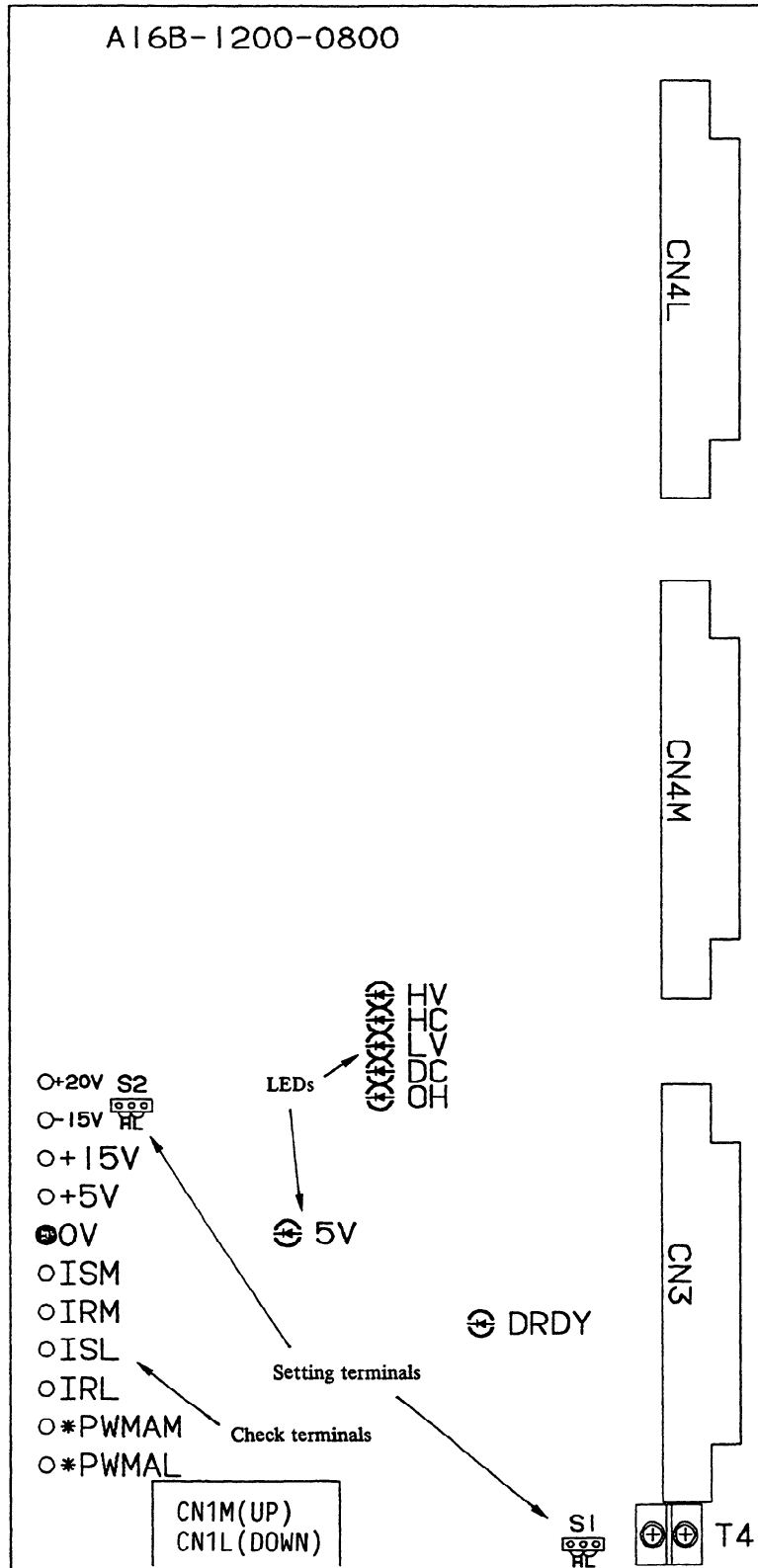

Fig. 4.2 (k1) 2-axis amplifier for models 2-0S-10S (A16B-1200-0800)

4. AC SERVO UNIT MAINTENANCE

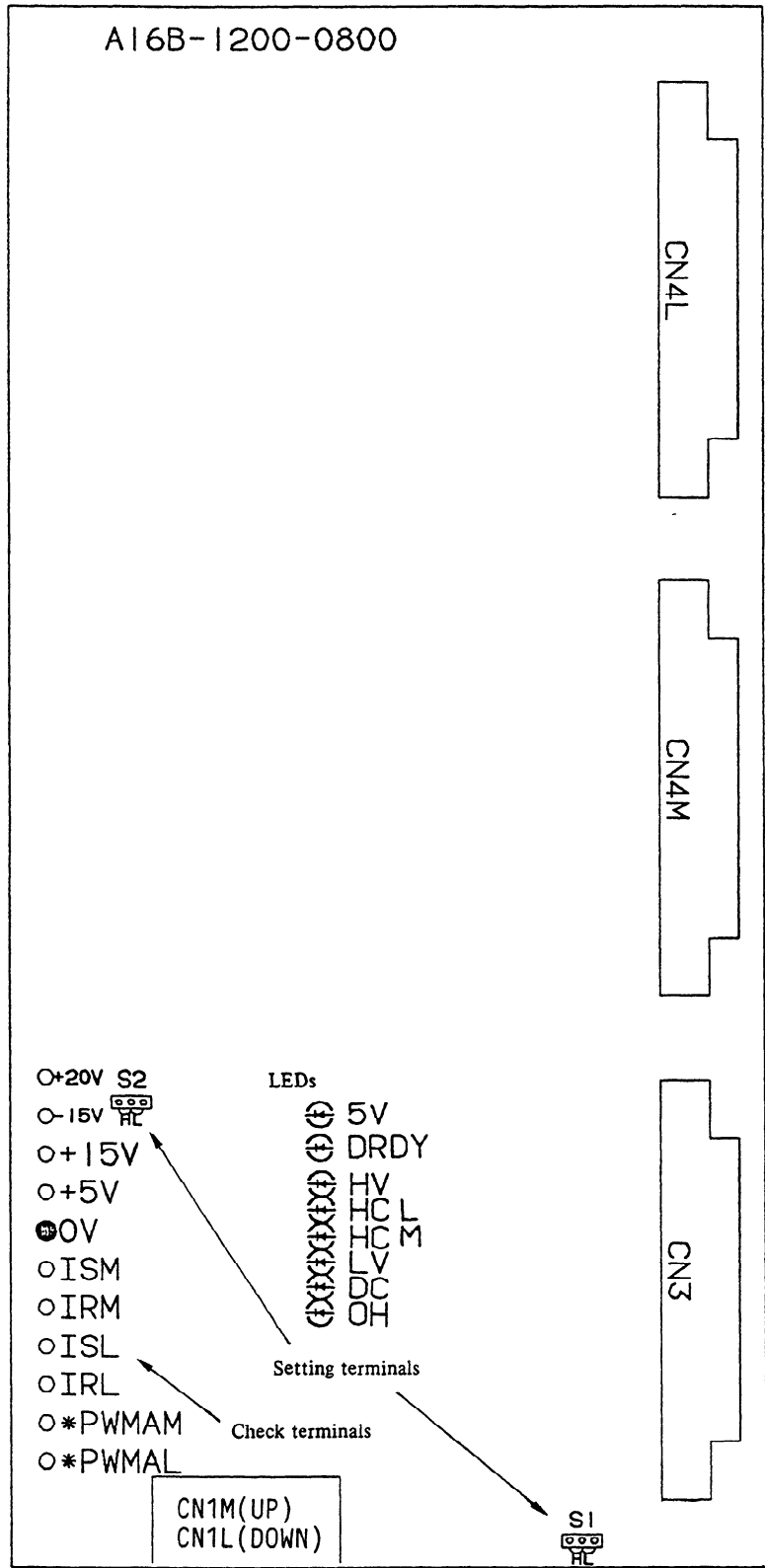

Fig. 4.2 (k2) 2-axis amplifier for models 2-0S-10S (A16B-1200-0800/02)

4. AC SERVO UNIT MAINTENANCE

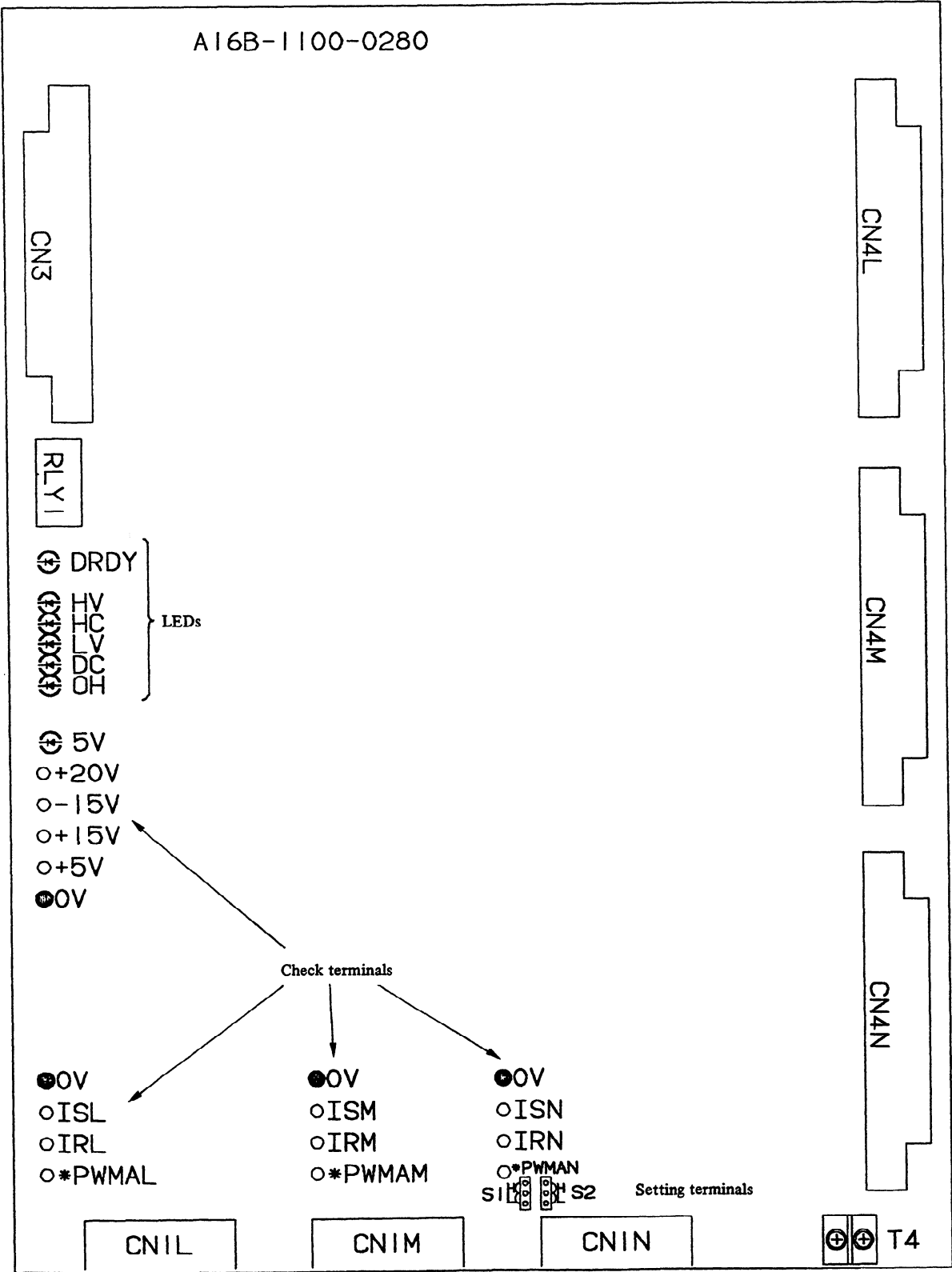

Fig. 4.2 (I) 3-axis amplifier for model 2-0S-10S (A16B-1100-0280)

4. AC SERVO UNIT MAINTENANCE

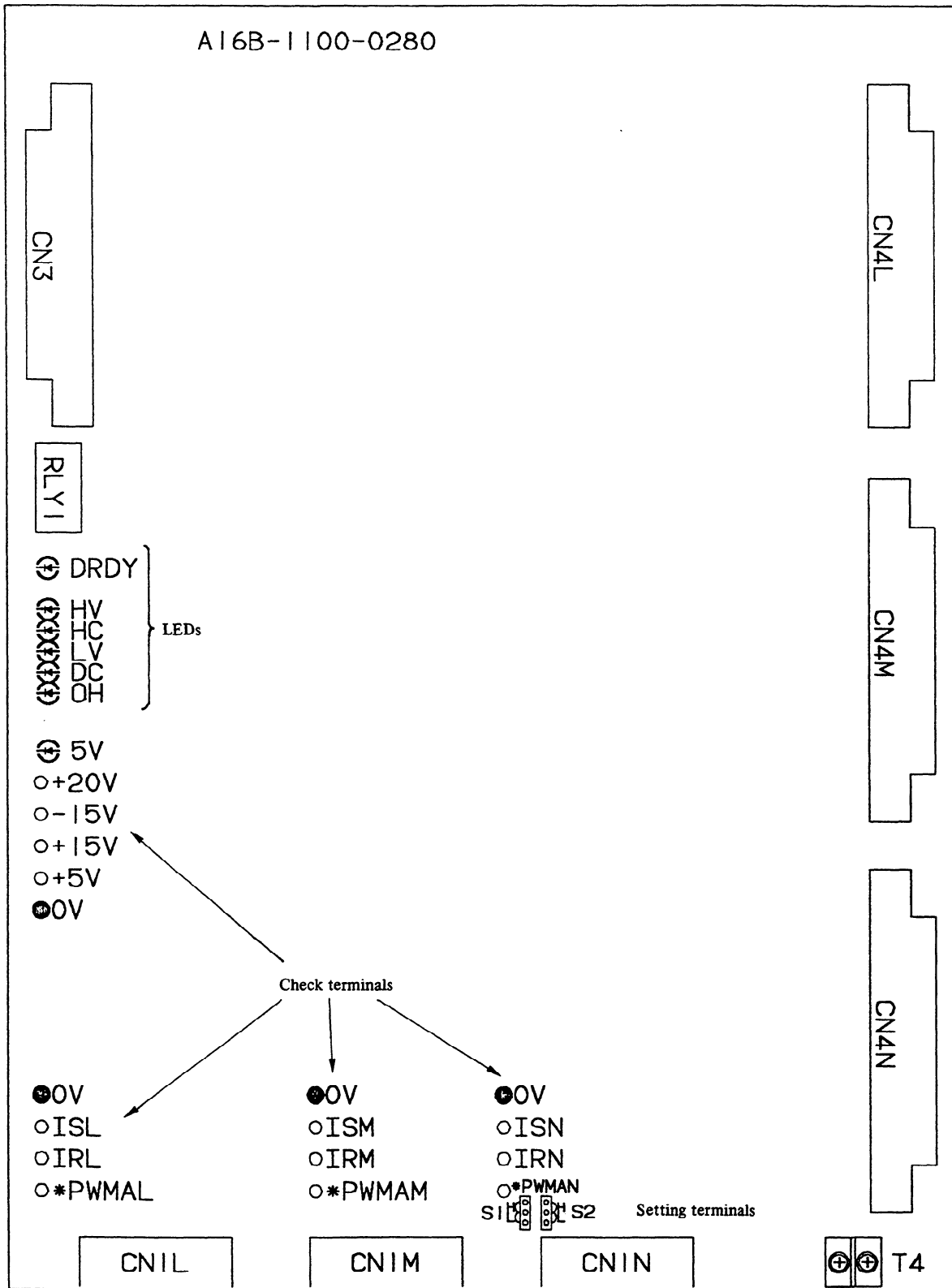

Fig. 4.2 (m) 3-axis amplifier for model 2-0S-10S (A16B-1100-0330)

4. AC SERVO UNIT MAINTENANCE

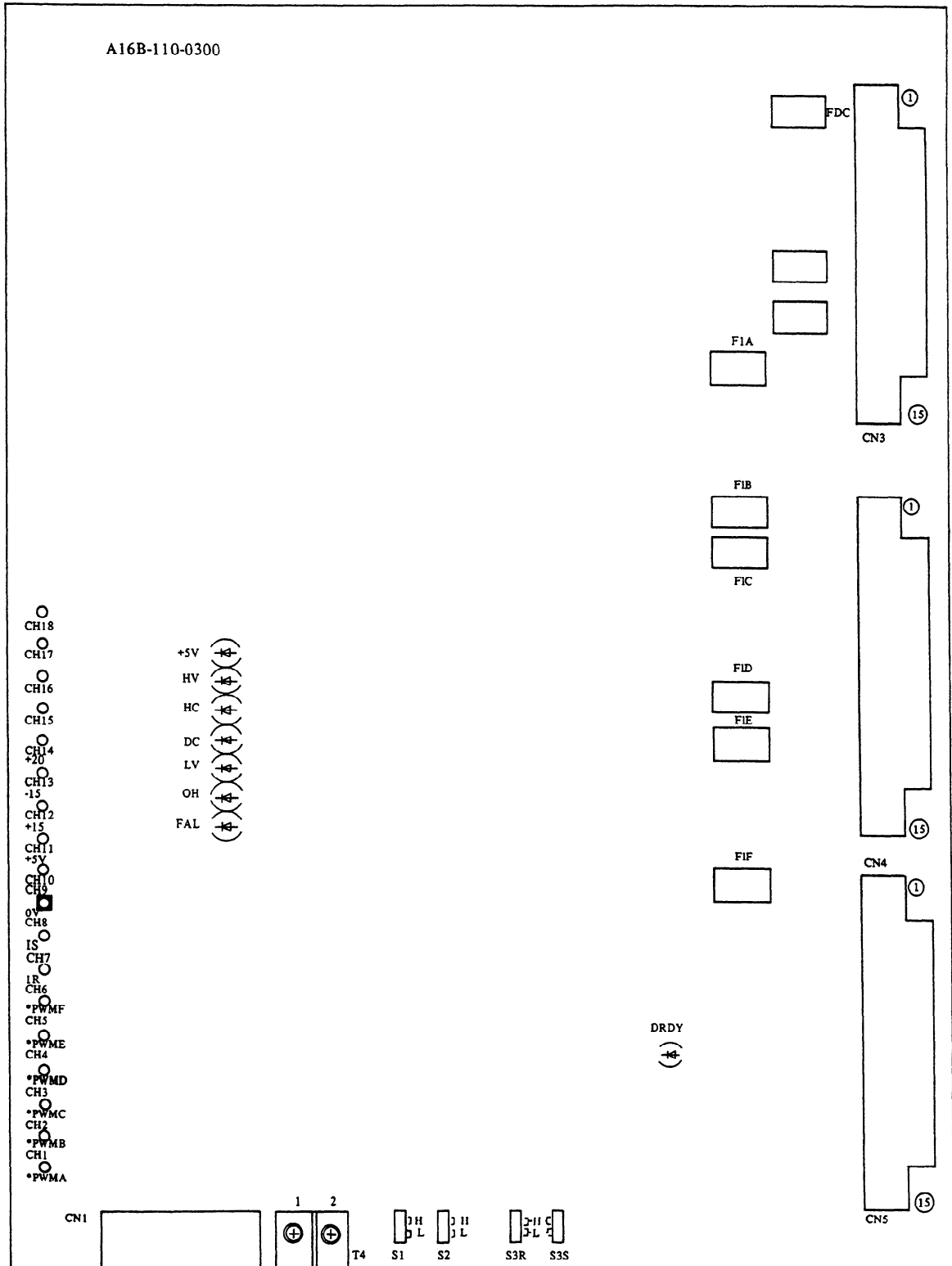

Fig. 4.2 (n) 1-axis amplifier for model 50S, 60S, 70S, 20S/3000, 30S/3000, 40S/2000 (A16B-1100-0300)

4. AC SERVO UNIT MAINTENANCE

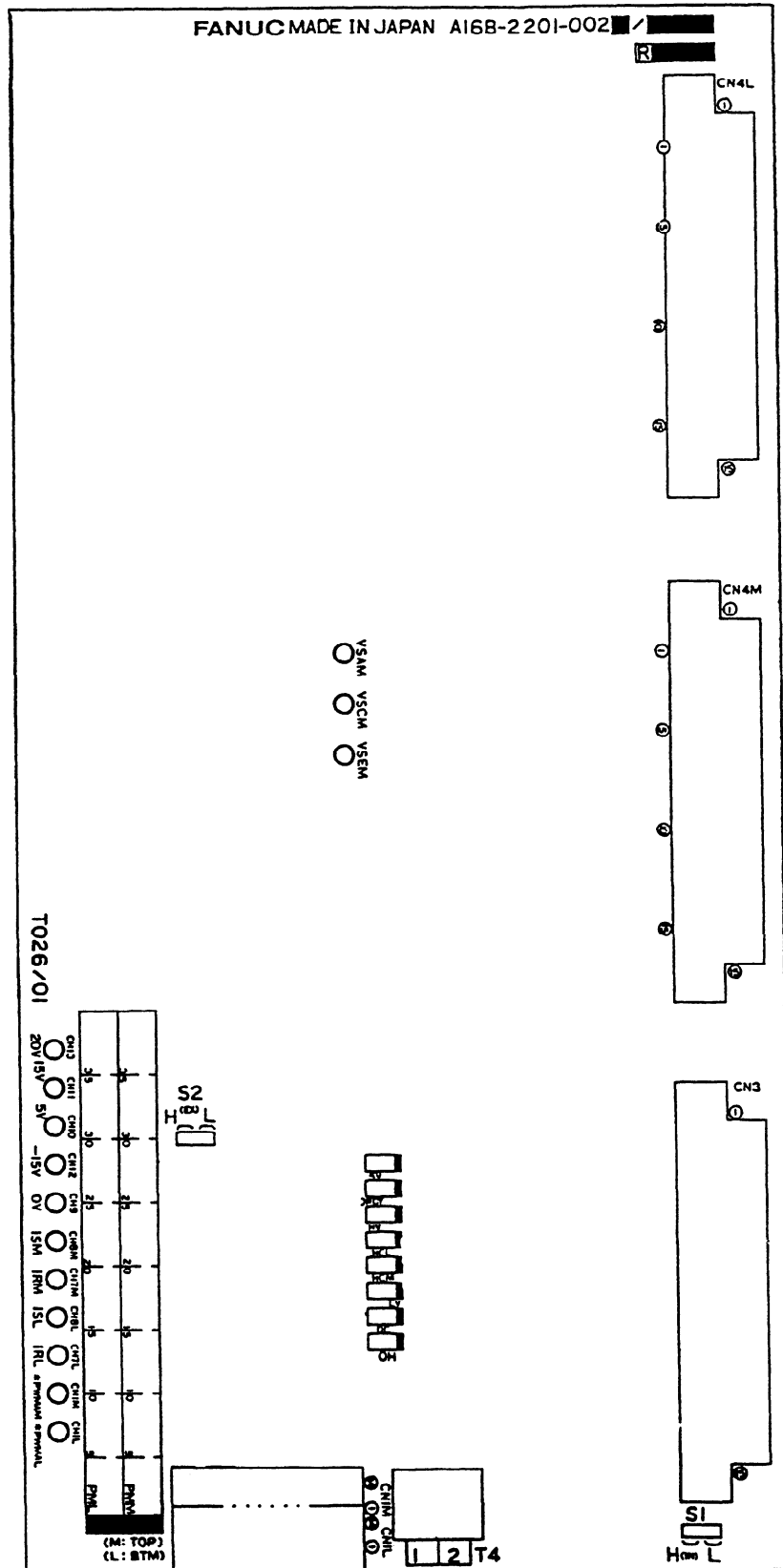

Fig. 4.2 (p) 2-axis amplifier (A20B-2201-0020) for models 5S/3000, 10S/3000, 20S/1500, 20S, and 30S

4. AC SERVO UNIT MAINTENANCE

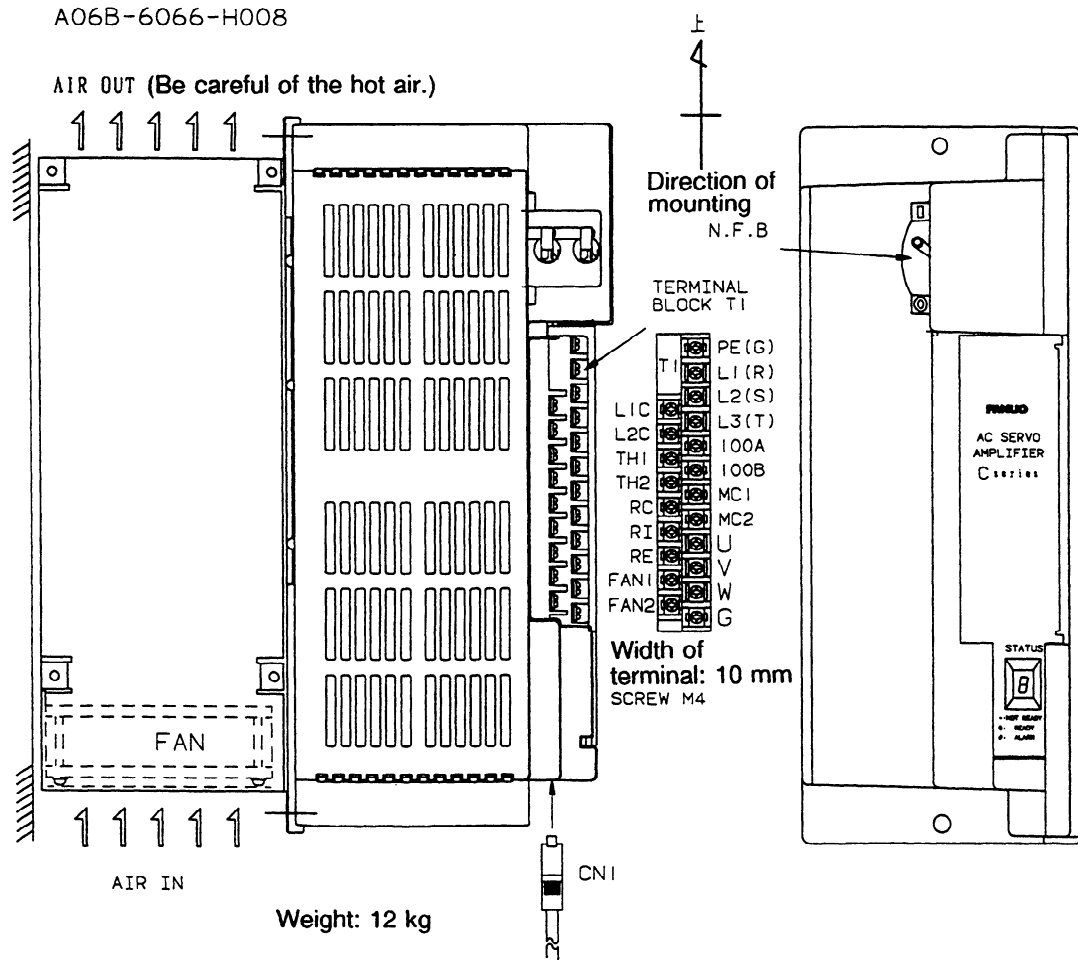

Fig. 4.2 (q) Components on C Series Servo Amplifier (One-Axis: A06B-6066-H008)

4. AC SERVO UNIT MAINTENANCE

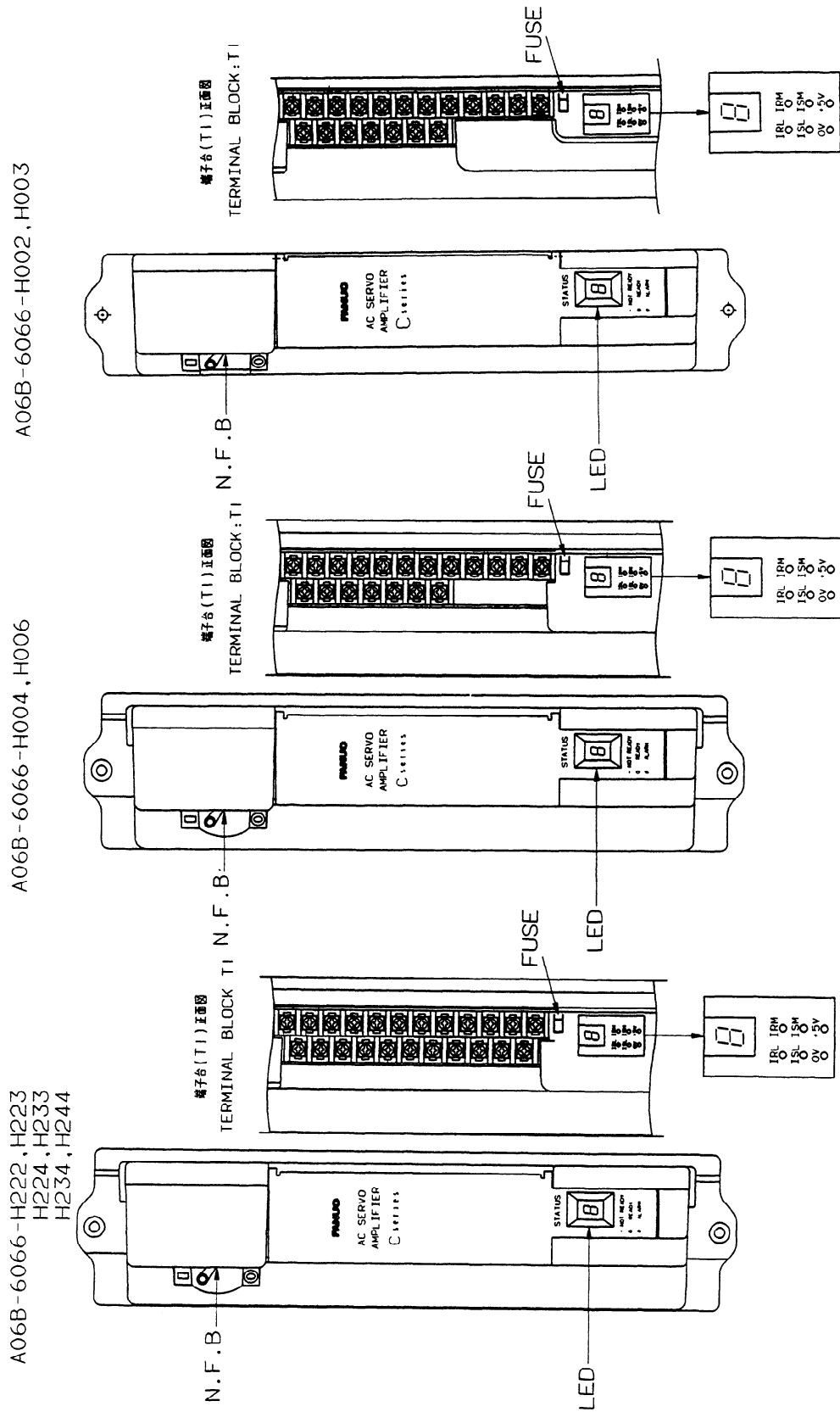

Fig. 4.2 (r) C series servo amplifier parts locations

(1-axis: A06B-6066-H002, H003, H004, H006)

(2-axis: A06B-6066-H222, H223, H224, H233, H234, H235, H236, H244, H246, H266)

4. AC SERVO UNIT MAINTENANCE

4.3 Servo Amplifier State Indication

The LED indicators on the printed circuit boards of a servo amplifier indicate states of the servo amplifier. With these LED indicators, servo amplifier trouble can be easily detected.

4.3.1 S series servo amplifiers

(1) PCB of controller

Symbol	Color	Contents
5V	Green	SIGN FOR CONTROL POWER ON "5V" indicates the state of power source applied on the board.
DRDY	Green	SIGN FOR PWM SIGNAL AVAILABLE "DRDY" indicates the ready state of servo amplifier. The condition of DRDY is no alarm and *MCON from NC being low.
HV	Red	HIGH VOLTAGE ALARM "HV" occurs when the DC link voltage has exceeded the limited level.
HC	Red	HIGH CURRENT ALARM "HC" occurs when excessive current has crossed the DC link.
LV	Red	LOW VOLTAGE ALARM "LV" occurs when the DC link voltage is excessively low or regulator circuit has a malfunction.
DC	Red	DISCHARGE ALARM "DC" occurs when the capacity of discharge circuit has been exceeded.
OH	Red	OVERHEAT ALARM "OH" occurs when a normally closed thermostat contact which is mounted either in servo amplifier, on separate discharge unit, or in power transformer has opened.
FAL	Red	In case of fuse alarm NFB1-3 and trip of F4/F5 (or blow-out)

(Note 1) Dynamic brake acts to stop the motor immediately when any alarm occurs.

(Note 2) LED "5V" is on S Series 200 to 230V type amplifier except for early version of A16B-1200-0800.

(Note 3) LED "DC" and DC ALARM are not on the following PCBs. (A20B-1001-0430, A20B-1002-0500 and A20B-1002-0730)

4. AC SERVO UNIT MAINTENANCE

(Note 4) The LED "FAL" is on the PCB A16B-1100-0300.

The PCB A16B-1100-0300 is used for the servo amplifiers A06B-6058-H007 and A06B-6058-H101 and -H102.

With A06B-6058-H007, when circuit breaker NFB trips, the LED "FAL" is turned on. With A06B-6058-H101 and -H102, when NFB1, NFB2, or NFB3 trips, or fuse F4 or F5 blows, the LED "FAL" is turned on.

This PCB has fuses F1, F2, FDC, and F1A to F1F. F1 and F2 are placed on the primary side of the control power supply on the PCB.

If an overvoltage is applied, varistor ZNR1 can be conductive and burn. FDC is the fuse that is connected to the discharge circuit to prevent the PCB from burning.

If the regenerative transistor is faulty, check this fuse as well. F1A to F1F are the fuses that are connected to the transistor driver circuit to prevent the PCB from burning.

If the main transistor is faulty, check these fuses as well.

(2) Power circuit PCB

Symbol	Color	Contents
LED	Red	Indicates that the electrolytic condenser of the DC link circuit is charged.

This LED is displayed on the A06B-6058-H□□□ series servo amp.

(Note however, that it is not displayed on A06B-6058-H002, H003.)

(Note 1) When this LED indicator is on, a high voltage is being applied to the components of the servo amplifier. Never touch any internal part.

(Note 2) With the servo amplifiers A06B-6058-H007, -H101 and -H102, the LED indicator for DC link charging indication is provided on the amplifier plate.

4.3.2 C series servo amplifiers









(1) Seven-segment LED indication

With the C series servo, amplifier states are indicated using a 7-segment LED indicator. An alarm occurs if the module PCB (38 × 112) is not securely inserted into the connector.

See Fig. 4.2(r) for the locations of the 7-segment LED indicator, circuit breakers, and fuses.

4. AC SERVO UNIT MAINTENANCE

Table 4.3.2 (a) Alarm state indications and meanings (1/2)

Type	LED indication	Description
Overvoltage alarm (HV)		If DC voltage of main circuit power supply is abnormally high, overvoltage alarm occurs (HV level: 430V DC). Alarm occurs when regenerative discharge resistor is disconnected. For 200V AC input, main circuit voltage is 283V DC (200×1.414). Discharge operation is started at voltage of main circuit voltage plus 60V.
Control power supply undervoltage alarm (LV5V)		Alarm occurs if control circuit power supply voltage (+5 V) is abnormally low (LV5V level: 4.6 VDC).
DC link undervoltage alarm (LVDC)		Alarm occurs if DC voltage of main circuit power supply is abnormally low (LVDC level: 120V). Causes may include power supply voltage (+15V) being 10V or lower and driver module PCB not inserted normally.
Regenerative control circuit abnormality alarm (DCSW)		Alarm occurs when short-time regenerative discharge energy is too high. Cause may be disconnection of regenerative discharge resistor. If IGBT for discharge is continuously on for 1 second or longer, cause may be short circuit between C and E for IGBT for discharge.
Excessive regenerative discharge alarm (DCOH)		Alarm occurs when average regenerative discharge energy is too high. Causes may include operation of thermostat for regenerative discharge resistor or thermostat between (15) and (16) on terminal block T1; this operation results from too frequent acceleration/deceleration operations.
Servo amplifier overheat (OH)		Alarm occurs when thermostat in amplifier operates (when thermostat contact on PCB opens). Check if motor load exceeds rated current.
Magnetic contactor welding alarm (MCC)		Alarm occurs when magnetic contactor contact welds. Check for contact welding immediately after use of magnetic contactor is specified. Causes may include short circuit of 3-phase diode bridge. Usually, replace amplifier.
Overcurrent alarm (HCL)		Alarm occurs when abnormally high current flows in main circuit of 1-axis amplifier or in main circuit of L axis of 2-axis amplifier. Causes may include faulty IC, abnormal PWM signal, faulty motor, and grounded wiring.

4. AC SERVO UNIT MAINTENANCE

Table 4.3.2 (a) Alarm state indications and meanings (2/2)

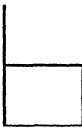
Type	LED indication	Description
Overcurrent alarm (HCM)		Alarm occurs when abnormally high current flows in main circuit of M axis of 2-axis amplifier. Causes may include faulty IC, abnormal PWM signal, faulty motor, and grounded wiring.
Overcurrent alarm (HCLM)		Alarm occurs when abnormally high current flows in main circuits of L and M axes of 2-axis amplifier. Causes may include faulty IC, abnormal PWM signal, faulty motor, and grounded wiring.

(Note) If an alarm is raised, the motor is stopped by the dynamic brake.

Table 4.3.2 (b) Normal state indications and meanings



Type	LED indication	Description
Amplifier not ready		Magnetic contactor in amplifier is dropped out; preparation for driving motor is not completed. (Ready signal from controller (NC) is not available.)
Amplifier ready		Magnetic contactor in amplifier is picked up; preparation for driving motor is completed. (This state represents normal operating state.)

Table 4.3.2 (c) Tripping of circuit breaker

Type	State indication	Description
Circuit breaker	Circuit breaker trips.	Circuit breaker trips if abnormal current exceeding rated current of circuit breaker flows. DC link undervoltage alarm (LVDC) may be turned on as well.

Table 4.3.2 (d) Blown fuses

Type	State indication	Description
Blown fuse on PCB	7-segment LED indicator provides no indication.	Fuse on PCB blows if abnormal current flows. If fuse blows, power is not supplied to servo amplifier control PCB, so all operations of servo amplifier are disabled. (Fuse check location: Near 7-segment LED indicator. Open terminal block cover to check.)

4.4 Check Terminals

4.4.1 S series servo amplifiers

Check pin	Check procedure
+ 20V or + 24V	Check the voltage between check pin 0 V and check pin + 20V by using circuit tester. Measured voltage value should be $+ 20V \pm 2V$ or $+ 24V \pm 2V$. (Note) This check pin is not mounted on A20B-1003-0090.
- 15 V	Check the voltage between check pin 0V and check pin - 15V by using circuit tester. Measured voltage value should be $- 15V \pm 0.75V$.
+ 15V	Check the voltage between check pin 0V and check pin + 15V by using circuit tester. Measured voltage value should be $+ 15V \pm 0.75V$.
+ 5 V	Check the voltage between check pin 0 V and check pin + 5V by using circuit tester. Measured voltage value should be $+ 5V \pm 0.25V$.
IS#	Check the voltage between check pin 0 V and check pin IS# by using oscilloscope. S-phase motor current of # axis can be measured. Refer to table 4.4.3 (a) for the ratio of voltage at check pin and motor current.
IR#	Check the voltage between check pin 0 V and check pin IR# by using oscilloscope. R-phase motor current of # axis can be measured. Refer to table 4.4.3(a) for the ratio of voltage at check pin and motor current.
*PWMA# Display of amplifier H003 for 1 axis is CH1	Check the voltage between check pin 0 V and check pin *PWMA# by using oscilloscope. The PWM waveform (negative logic) of A-phase of # axis can be measured.
0V	Reference voltage

(Note 1) The # means axis name (L, M, N, etc.) of amplifier.

(Note 2) Motor current IT# of T-phase is shown by $IT# = - (IS# + IR#)$

(Note 3) Don't touch the amplifier except at check pins, since a high voltage is supplied.

(Note 4) The motor speed signals and torque signals other than the signals listed above can be observed using a check board. See Section 6 for detailed information.

4. AC SERVO UNIT MAINTENANCE

4.4.2 C series servo amplifiers

Check pin	Check procedure
IRL (IRM)	Check the voltage between check pin 0 V and check pin IS# by using an oscilloscope. S-phase motor current of # axis can be measured. See Table 4.4.3 (a) for the ratio of voltage at check pin and motor current.
ISL (ISM)	Check the voltage between check pin 0 V and check pin IR# by using oscilloscope. R-phase motor current of # axis can be measured. See Table 4.4.3 (a) for the ratio of voltage at check pin and motor current.
+5V	Check the voltage between check pin 0V and check pin +5V by using circuit tester. Voltage measured must be $+5 \pm 0.25V$. This voltage does not appear if fuse on PCB has blown.
0V	Reference voltage

(Note 1) For a 1-axis amplifier, signals are not applied to IRM and ISM.

(Note 2) When checking a signal, be careful not to cause a short circuit.

4. AC SERVO UNIT MAINTENANCE

4.4.3 Motor current

Table 4.4.3 (a) Ratio of motor current to voltage (1/2)

Type	Drawing number		Axis name	Ratio of current to voltage (A/V)	Maximum current amps peak (A)
	S series	C series			
For 1 axis	A06B-6057-H001	—————		0.5	2
	A06B-6057-H002 A06B-6058-H002	A06B-6066-H002		1.0	4
	A06B-6057-H003 A06B-6058-H003, H023	A06B-6066-H003		3.0	12
	A06B-6057-H004, H005 A06B-6057-H015, H401 A06B-6058-H004, H005	A06B-6066-H004		10	40
	A06B-6057-H006, H402 A06B-6058-H006, H025	A06B-6066-H006		20	80
	A06B-6057-H007, H008 A06B-6057-H403	—————		25	100
	A06B-6058-H007	A06B-6066-H008		32.5	130
	A06B-6058-H101	—————		55.6	200
	A06B-6058-H102	—————		83.3	300
	For 2 axis	—————	A06B-6066-H222	L/M	1.0/1.0
—————		A06B-6066-H223	L/M	1.0/3.0	4/12
—————		A06B-6066-H224	L/M	1.0/10	4/40
A06B-6057-H201 A06B-6058-H201, H221		A06B-6066-H233	L/M	3.0/3.0	12/12
A06B-6057-H202 A06B-6058-H202, H222		A06B-6066-H234	L/M	3.0/10	12/40
A06B-6057-H203 A06B-6058-H203, H204 H223, H224, H229, H253		A06B-6066-H244	L/M	10/10	40/40
—————		A06B-6066-H236	L/M	3/20	12/80
—————		A06B-6066-H246	L/M	10/20	40/80
—————		A06B-6066-H266	L/M	20/20	80/80
A06B-6058-H231, H252		—————	L/M	10/20	40/80
A06B-6058-H230, H251		—————	L/M	20/20	80/80
For 3 axis	A06B-6057-H301 to H304 A06B-6058-H301 to H304 A06B-6058-H321 to H324 A06B-6058-H334	—————	L	10	40
			M	10	
			N	10	
	A06B-6058-H325 A06B-6058-H331	—————	L	3.0	12
			M	3.0	
			N	3.0	
	A06B-6058-H326 A06B-6058-H328 A06B-6058-H332	—————	L	3.0	12
			M	3.0	
			N	10	

4. AC SERVO UNIT MAINTENANCE

Table 4.4.3 (a) Ratio of motor current to voltage (2/2)

Type	Drawing number		Axis name	Ratio of current to voltage (A/V)	Maximum current amps peak (A)
	S series	C series			
For 3 axis	A06B-6058-H327	—————	L	3.0	12
	A06B-6058-H329		M	10	40
	A06B-6058-H333		N	10	

(Note) C series servo amplifiers for three axes are not available.

Fig. 4.4.3 (b) Ratio of motor current to voltage

185V input type		200V input type (200V/220V/230V)	
5-0	0.5A/V		
4-0S, 3-0S	1.0A/V	4-0S, 3-0S	1.0A/V
2-0, 1-0	3.0A/V	2-0S, 1-0S 1-0S/3000	3.0A/V
0, 5, 10 20S/1500 0L	10A/V	0S, 5S, 10S, 20S/1500 0T/3000, 5T/2000 10T/2000, 2-0SP, 8L	10A/V
20S, 30 5L, 6L	20A/V	5S/3000, 6S/3000 10S/3000, 20S, 30S 5T/3000, 10T/3000 5L, 6L	20A/V
30/2000 40 7L, 10L	25A/V		
—————	—————	20S/3000, 30S/3000 40/2000, 7L, 10L	32.5A/V
—————	—————	50S	55.6A/V
—————	—————	60S, 70S	83.3A/V

4. AC SERVO UNIT MAINTENANCE

4.5 Setting Terminals for Printed Circuit Boards

4.5.1 Setting terminals for S series servo amplifiers

Terminal	Setting	Content
S1	L	The external thermostat signal is connected to T4 or CN2.
	H	The external thermostat signal is not connected to T4 or CN2.
S2	H	If use a separate discharge unit
	L	If no separate discharge unit
Setting Terminals S3R, S3S (Set at "H" side without fail.) (Only A16B-1100-0300)		
S3R	H	If S series amplifier
S3S	L	Not used

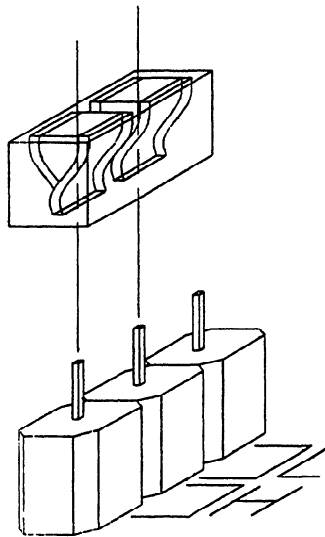

Set at "H" side

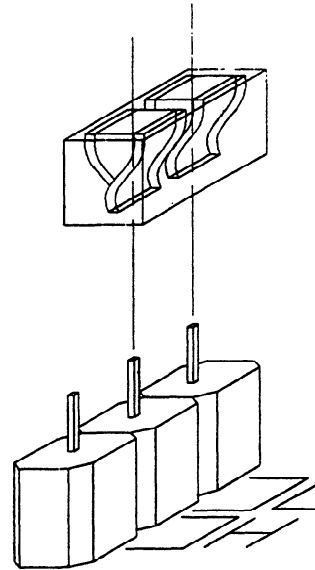

Set at "L" side

4.5.2 Setting terminals for C series servo amplifiers

The C series servo amplifiers have no setting terminals.

4.6 Amplifier Interchangeability

4.6.1 S series 2-axis amplifier interchangeability

(1) Interchangeability between A06B-6058-H20□ and A06B-6058-H22□

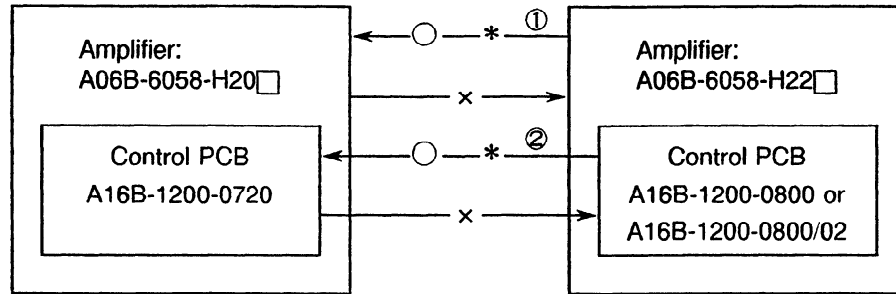

←○— Means there is interchangeability. (It is possible to exchange.)
 —x→ Means there is no interchangeability. (It is impossible to exchange.)
 (* means servo parameter changing is necessary.)

- ① There is high order interchangeability at servo amplifier level. However, it is necessary to change some of the servo parameters. (See to Note 4 in subsection 3.4.5.)
- ② There is high order interchangeability at control printed board level. However, it is necessary to change some of the servo parameters. (See to Note 4 in subsection 3.4.5.)

(2) Interchangeability between A06B-6058-H20□, H22□, H23□ and A06B-6058-H25□ series

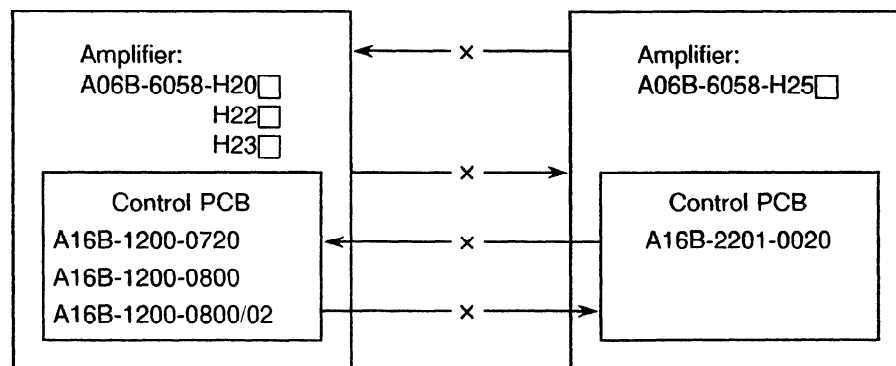

The servo amplifiers and control printed circuit boards are not interchangeable.

If a wrong control printed circuit board is used, a failure can occur.

4.6.2 S series 3-axis amplifier interchangeability

(1) Interchangeability between A06B-6058-H30□, A06B-6058-H32□ and A06B-6058-H33□

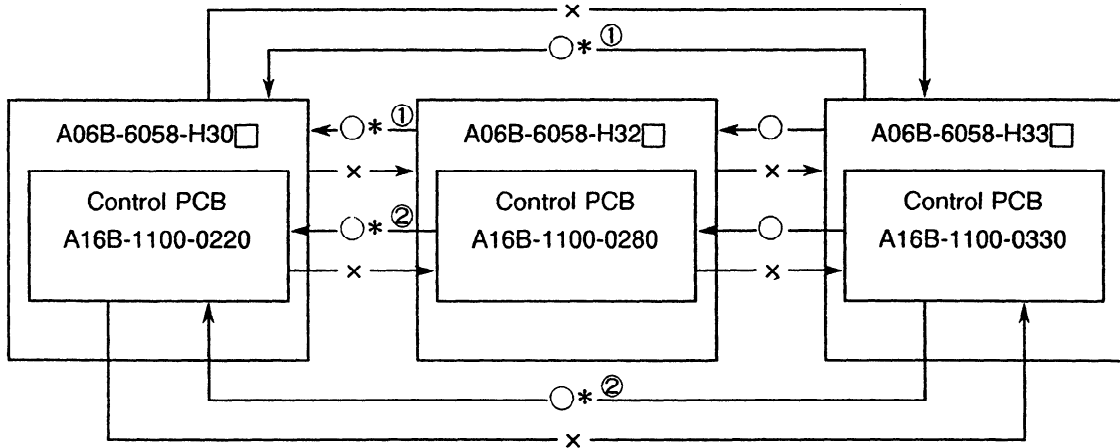

←○ — Means there is interchangeability. (It is possible to exchange.)
 — x → Means there is no interchangeability. (It is impossible to exchange.)
 (* means servo parameter changing is necessary.)

- ① There is high order interchangeability at servo amplifier level. However, it is necessary to change some of the servo parameters. (See to Note 4 in subsection 3.4.5.)
- ② There is high order interchangeability at control printed board level. However, it is necessary to change some of the servo parameters. (See to Note 4 in subsection 3.4.5.)

4.7 Connection of the Discharge Unit

(1) S series servo amplifiers

When using the discharge unit, connect as follows.

- ① Take the short bar which is between T2 (4) and T2 (5) out of T2. (Don't use the shorting bar.)
- ② Connect a cable from the discharge unit between T2 (4) and T2 (6).
- ③ Connect a cable from the thermostat that is mounted on the discharge unit to T4 or CN2.
- ④ Set S1 at "L" side. Set S2 at "H" side.

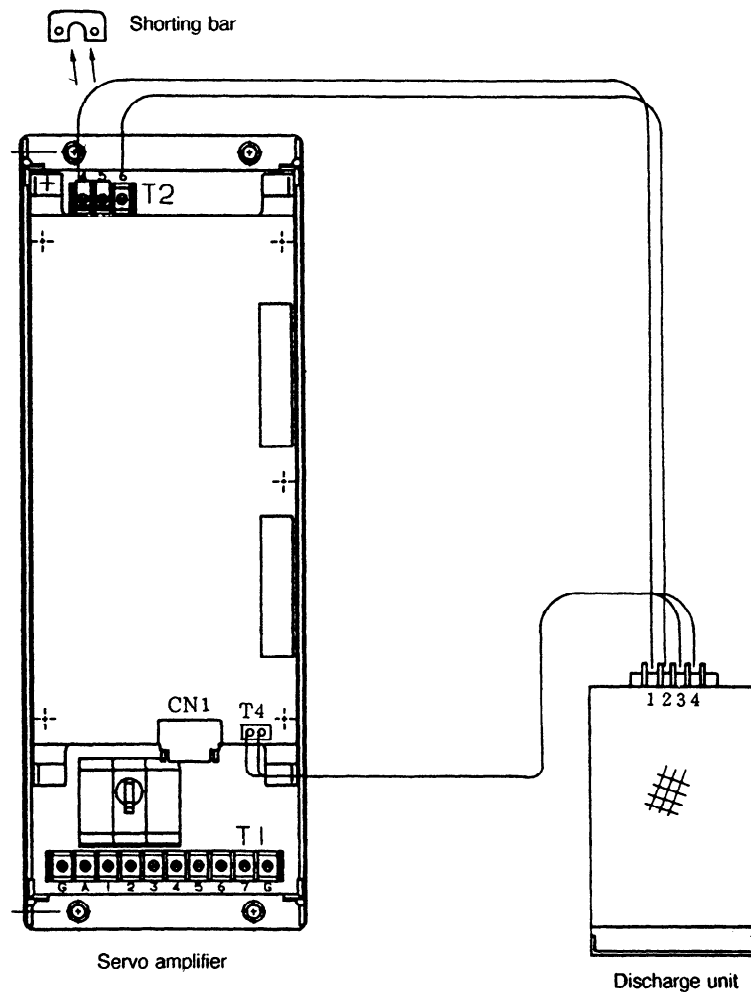

Fig. 4.7 (a) Connecting the separate type discharge unit

4. AC SERVO UNIT MAINTENANCE

(2) C series servo amplifiers - 1

When using the discharge unit, make the following connections:

- ① Remove the shorting bars between (17) and (18) on terminal block T1 and between (15) and (16) on terminal block T1. (The short bars should not be used.)
- ② Connect the cables from (1) and (2) on terminal block T3 for the discharge unit to (17) and (19) on terminal block T1 for the amplifier.
- ③ Connect the thermostat signal cables from (3) and (4) on terminal block T3 for the discharge unit to (15) and (16) on terminal block T1 for the amplifier.

A06B-6066-H500

A06B-6066-H□□□

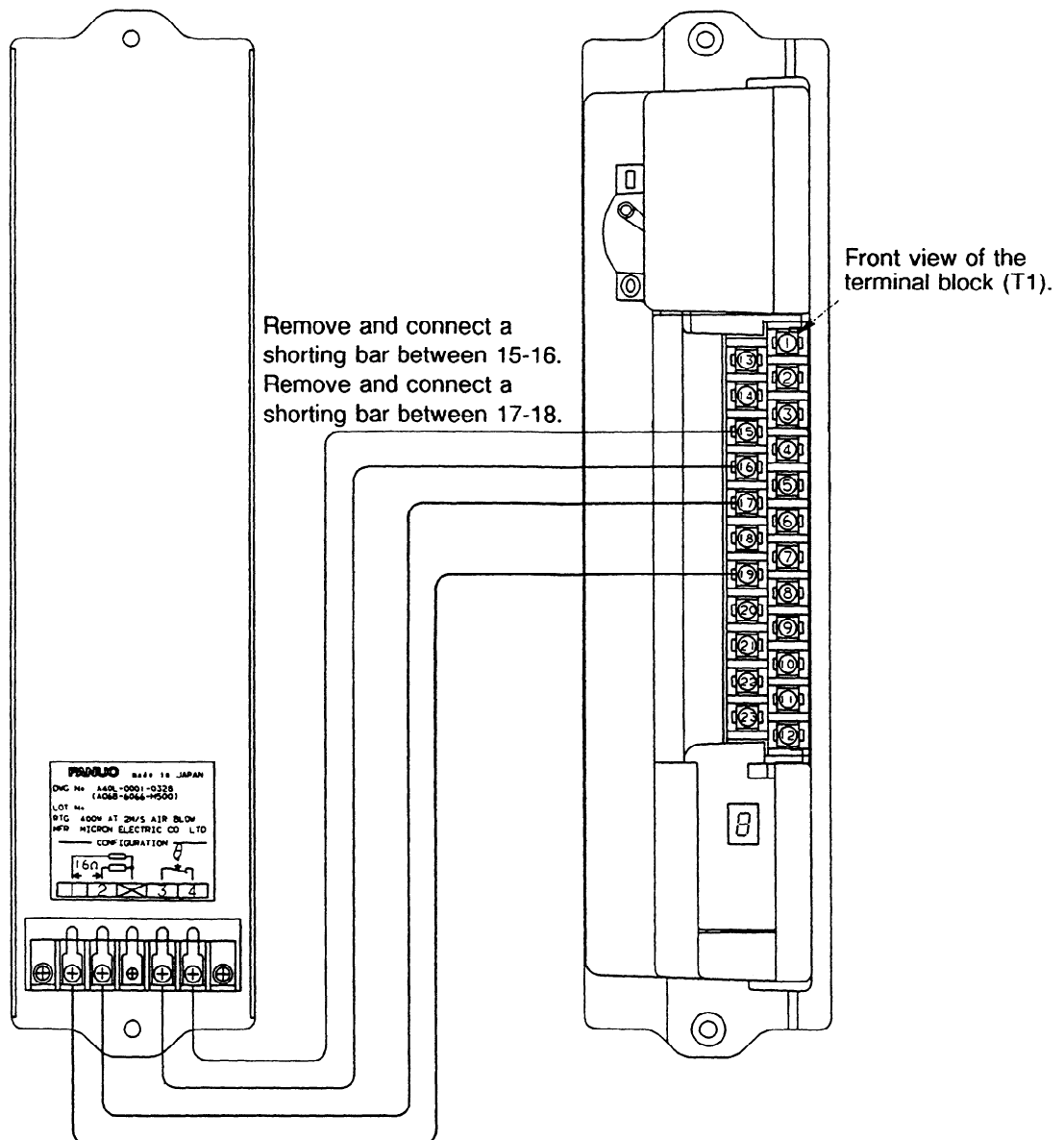

Fig. 4.7 (b) Connecting the separate type discharge unit

4. AC SERVO UNIT MAINTENANCE

(3) C-series servo amplifier - 2

When using the discharge unit, connect it as shown in Fig. 4.7 (c).

- ① Remove the straps between terminals 17 and 18 and between 15 and 16 from terminal block T1. (Straps must not be used.)
- ② Connect the cables of terminals 1 and 2 on terminal block T3 of the discharge unit to terminals 17 and 19 on terminal block T1 of the amplifier.
- ③ Connect the thermostat signal cables of terminals 3 and 4 on terminal block T3 of the discharge unit to terminals 15 and 16 on terminal block T1 of the amplifier.
- ④ Connect the fan motor supply cables of terminals 5 and 6 on terminal block T3 of the discharge unit to terminals 24 and 25 on terminal block T1 of the amplifier.

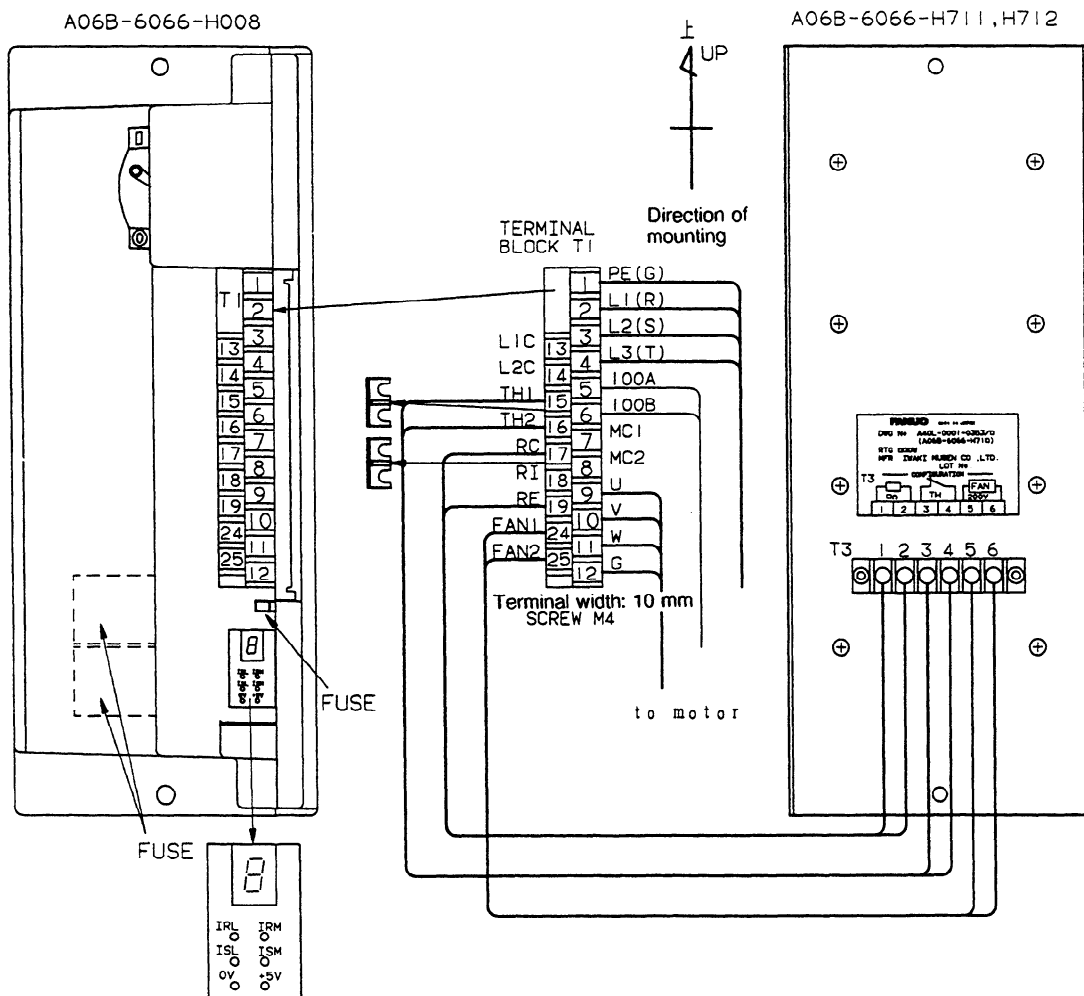

Fig. 4.7 (c) Connecting a Separate Discharge Unit

4. AC SERVO UNIT MAINTENANCE

4.8 Kinds of Separate Type Electric Discharge Unit

Drawing number	Resistor	Resist capacity	Remark
A06B-6042-H053	12Ω + 12Ω	1200W + 1200W	For A06B-6057-H403, 7L, 10L (2-axis integrated type, forced air cooling)
A06B-6042-H055	12Ω + 12Ω	750W + 705W	For A06B-6057-H403, 7L, 10L (2-axis integrated type, natural air cooling)
A06B-6047-H050	24Ω	400W	For A06B-6058-H223, -H224, etc.
A06B-6050-H050	16Ω	400W	For A06B-6058-H005, -H006, -H229 to -H231, etc.
A06B-6050-H052	10Ω	400W	For A06B-6058-H234, H33□, etc.
A06B-6050-H053	16Ω	800W	For A06B-6057-H403 7L
A06B-6050-H054	16Ω	1600W	For A06B-6057-H403 10L
A06B-6058-H191	3.6Ω	2000W	For A06B-6058-H101, -H102 (With forced air cooling fan)
A06B-6058-H192	8Ω	800W	For A06B-6058-H007, -H251, -H252, -H253
A06B-6066-H500	16Ω	☆400W	For A06B-6066-H004 to -H006, -H222 to -H244 ☆: For forced air cooling with air speed of 2m/s
A06B-6066-H711	8Ω	800W	A06B-6066-H008 For forced air cooling
A06B-6066-H712	8Ω	1200W	A06B-6066-H008 For forced air cooling
A06B-6066-H713	16Ω	800W	For forced air cooling
A06B-6066-H714	16Ω	1200W	For forced air cooling

4.9 When One or More Axes are not Used in a Two-Axis or Three-Axis Amplifier

When only one axis of a two-axis amplifier or one or two axes of a three-axis amplifier need to be used, a dummy connector shown in Fig. 4.9 (a) or (b) must be attached to connector CN1* of each axis that is not to be used. FANUC input connectors can be used for this purpose.

(1) S-series servo amplifier

Strap pins 12 and 13 of connector CN1*.

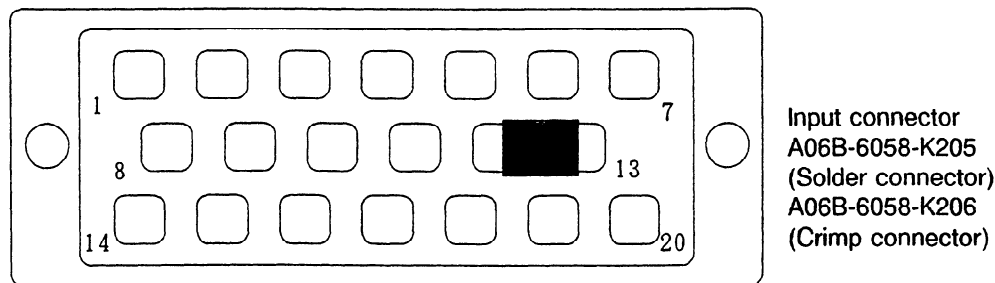

Fig. 4.9 (a)

(2) C-series servo amplifier

Strap pins 08 and 10 of connector CN1*.

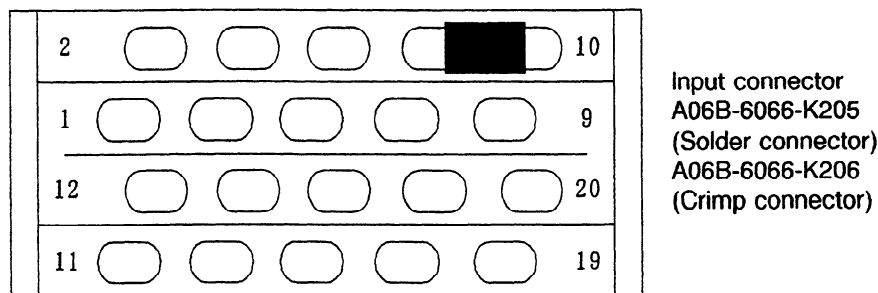

Fig. 4.9 (b)

(Note) An asterisk (*) indicates the axis which is not used.

When a dummy connector is attached, the motor of the corresponding axis is not excited. The dynamic brake of the motor is also released and the motor becomes free.

If the motor of the vertical axis is set free, the axis may drop.

4. AC SERVO UNIT MAINTENANCE

4.10 Leakage Current

This section describes the leakage current of the servo amplifier.

4.10.1 Leakage current and selection of the ground fault interrupter

(1) High-frequency leakage current and the ground fault interrupter

If the power supply voltage at the installation site conforms to the input specifications of the amplifier, such as 200V AC to 230V AC, AC servo motors and AC spindle motors manufactured by FANUC can be directly connected to the power supply without using a transformer.

In this case, a high-frequency leakage current will be drawn by the motor and the power cable. Alternatively there will be a stray capacitance between the amplifier and the ground. This is because the motor is driven by a PWM inverter using the power transistor bridge.

This high-frequency leakage current may unnecessarily activate some types of the ground fault interrupter or leakage protection relay installed in the power supply circuit.

To eliminate this problem, manufactures of ground fault interrupters specially designed for use with inverters have been attempting to reduce the sensitivity to high-frequency currents without impairing the efficiency of the inverter or general safety. With the increasing use of inverters, these improved ground fault interrupters are now used as standard.

The following table lists examples of the ground fault interrupters that are compatible with the inverters.

Table 4.10.1 Examples of the ground fault interrupters

Manufacturer	Model No.	Application status
Fuji Electric Co., Ltd.	Series EG-A and SG-A	Fully compatible with inverters after July, 1983.
Hitachi, Ltd.	Types ES100C and ES225C	Fully compatible with inverters after July, 1984.
Matsushita Electric Works, Ltd.	Leakage current breaker, type C Leakage current breaker, type KC	Fully compatible with inverters after November, 1984.

(2) Installing a ground fault interrupter

Ground fault interrupters and leakage-protection relays protect against electric shock or fire that may result from a leakage current.

4. AC SERVO UNIT MAINTENANCE

As for safety, Section 333 of the “Work Safety Standards and Health Regulations” stipulates either connection to a ground fault interrupter for preventing electric shock or grounding of metal part in the motor. The section also specifies a rated sensitivity current of 30mA for ground fault interrupters.

These regulations apply to relocatable or portable machines, which may have multiple motors, rather than machine tools. However, the regulations are a standard for selecting the sensitivity current.

(3) Selecting a ground fault interrupter

The effects of high-frequency currents can be reduced by using a ground fault interrupter compatible with the inverter in the power supply circuit of a machine. However, some leakage current is inevitable. This is because of the capacitance between the ground and the filter that is provided for suppressing the noise transfer to the circuit in the power supply side, and because of the above-mentioned stray capacitance. Therefore, when multiple motors are used, the leakage current will accumulate and eventually reach the sensitivity level of the ground fault interrupter.

Therefore, when using an AC servo motor or amplifier supplied by FANUC, refer to the following guide when selecting a ground fault interrupter.

(4) Leakage current for AC servo amplifier series S

Commercial frequency component of the leakage current for AC servo motors series S and the amplifier is approx. 1mA if one-wire grounding is used (S phase grounding). Accordingly, a greater value may be observed during measurement, depending on the type of measuring instrument used. See the Section 4.9.2 and subsequent sections for these points.

At present, no particular value is specified for the high-frequency sensing characteristics of the ground fault interrupter. However, in view of the frequency characteristics of a ground fault interrupter compatible with an inverter, listed above in Table 1, sensitivity at 2 kHz is less than 0.05 in commercial frequency range.

By this means, the effects of high-frequency leakage current can be reduced to a satisfactory level. Therefore, when selecting a ground fault interrupter, a maximum leakage current of 2 mA per axis for the AC servo motor of series S can be used as a guideline for calculation. However, the value slightly differs depending on the length of the power cable, the model of the motor, and so on.

Examples:

- When using a high-sensitivity, high-speed ground fault interrupter with a rated sensitivity current of 30mA, the non-activating current is 15mA.
- If two units of AC servo motor model 10S and two units of 0S are used, the total current for the motors, 2mA multiplied by 4 units equals 8mA, which is less than the non-activating current of 15mA.

4. AC SERVO UNIT MAINTENANCE

Therefore, it is judged that the ground fault interrupter compatible with the inverter would not be activated in this case.

(Note 1) When an AC spindle motor is used, it is necessary to add the leakage current for the motor. In addition, it is necessary to take the leakage currents of the auxiliary equipment into consideration.

(Note 2) A ground fault interrupter with an appropriate rated sensitivity current needs to be selected depending on the size of the system. In particular, be sure to ground the type 3 machine. This is to ensure that a dangerous voltage is not generated at the machine or the control panel if the ground fault interrupter fails.

4.10.2 Measuring the leakage current when the AC servo motor series S is operating

AC servo motors of series S are driven by the PWM method using a 2-kHz chopper frequency signal. As a result, a higher harmonic current with a fundamental frequency of 2kHz is drawn through the stray capacitance between the motor and the power cable, and ground as a part of the recirculating grounding wire current (transmission current of machine) to the grounding wire of the input power for the equipment via the grounding cable of the motor and the conductive part of the machine.

For leakage current measuring instruments (hereafter referred to as leakage testers), only the commercial frequency component is specified. Therefore, the frequency characteristics of the testers differ depending on the manufacturer. Some are affected by frequencies above 2kHz while others are not.

Therefore, FANUC has selected leakage testers with representative characteristics and has used them to measure leakage. The results are shown in Tables 4.10.2 (a) and 4.10.2 (b) below.

For models with substantial capacitance or with long cables, the leakage currents for the commercial frequency (measurement by characteristics A) increase slightly above the values in the tables as the stray capacitance increases.

4. AC SERVO UNIT MAINTENANCE

Example 1: AC servo motor model 10S

This example shows when a model 10S motor of series S and a one-axis amplifier are used. The cables specified in JIS 3312C were used to supply power to the motor. The cable were five meters long unless otherwise specified.

Table 4.10.2 (a) Examples of leakage current measurements (1)

(Unit: mA)

Measurement conditions	Motor speed	Characteristics of the leakage tester		
		A	B	C
When an AC line filter (FANUC A81L-0001-0083) is used	0 RPM	0.8	1.7	5.0
	2000 RPM	0.8	1.3	3.4
When a general-purpose AC line filter (FHF-T30 made by Fuji Electric Co., Ltd.) is used.	0 RPM	1.2	1.9	5.1
	2000 RPM	1.3	1.6	3.6
When an isolating transformer (FANUC A80L-0024-0006) is used	0 RPM	0.1	0.2	0.4
	2000 RPM	0.1	0.1	0.3
When no AC line filter is used	0 RPM	0.8	1.6	4.8
	2000 RPM	0.8	1.3	3.4
When no AC line filter is used with a cable 14 m long	0 RPM	0.8	2.2	7.1
	2000 RPM	0.9	1.7	5.0

Instruments used: All the leakage testers are grip-type leakage ammeters.

Characteristics A: Model 2413F (Kyoritsu Denkikeiki), 50/60Hz range

Characteristics B: CLM-40AD (Midori Anzen Corp.)

Measurements were taken at the filter mode ($f_c = 707$ Hz) of the frequency characteristics based on the standard for installing the line filters for computers.

Characteristics C: CLM-40AD Ordinary mode

4. AC SERVO UNIT MAINTENANCE

Example 2: AC servo motor model 30S

The measurements were taken using a model 30S motor of series S and a one-axis amplifier. The cables specified in JIS 3312C were used to supply power to the motor. The cables were 14 meters long.

Table 4.10.2 (b) Examples of leakage current measurements (2)

(Unit: mA)

Measurement conditions	Motor speed	Characteristics of the leakage tester		
		A	B	C
When an AC line filter (FANUC A81L-0001-0083) is used	0 RPM	1.1	4.1	13.0
	1200 RPM	1.0	2.8	9.1
When an AC line filter (FANUC A81L-0001-0101) is used	0 RPM	1.1	4.3	13.4
	1200 RPM	1.1	3.0	9.7
When no AC line filter is used	0 RPM	1.1	3.9	12.9
	1200 RPM	0.9	2.8	8.9

Instruments used: Characteristics A: Model 2413F (Kyoritsu Denkikeiki), 50/60Hz range
 Characteristics B: CLM-40AD (Midori Anzen Corp.) Filter mode
 Characteristics C: CLM-40AD Ordinary mode

In addition to those listed above, BT6001 (Matsushita Electric Co., Ltd.) is available. This tester has characteristics A.

CLM-65DX (Midori Anzen Corp.) is also available and has characteristics C.

Various types of leakage testers are available other than those shown above. When confirming the functions of a given grounding fault interrupter for the inverter, it is recommended to use a leakage tester having characteristics A, which best matches the grounding fault interrupter.

5. AC SERVO MOTOR MAINTENANCE

5.1 AC Servo Motor Maintenance

As a rule, the AC servo motor does not require periodic maintenance because there are no wearing parts. But AC servo motor contains a precision detector, so misoperation or damage in transit might cause failure or trouble. It is recommended to check the motor referring to this manual periodically.

5.1.1 Acceptance and storage of AC servo motor

- (i) Check that servo motor is the specified one (Check the motor and detector specifications.)
- (ii) Check that there is no mechanical damage.
- (iii) Check that the rotating part can be easily and smoothly turned by hand.
- (iv) Check if it is a motor with brake, if so check that the brake is normal.
- (v) Check for any loosened screws or play.

Every servo motor undergoes strict inspection before shipment, therefore a special receiving inspection may not be required as a rule. When a receiving inspection is required, it is recommended that the user refer to the AC servo motor specifications for information about servo motor and detector wiring, currents, and voltages. Don't leave the servo motor outdoors, but store it indoors. Avoid storing it in the place with an extremely high or low humidity, radical changes of temperature, or dust.

5.1.2 Mounting AC servo motor

Note the following points when mounting the servo motor.

- (1) The servo motor is not waterproof. If cutting oil, lubricating oil, etc. penetrate into the inside of the motor, it may break down the insulation and short-circuit the coil. Therefore, due care should be taken so that liquids such as cutting oil will be kept from the motor.
- (2) When mounting the servo motor on a gear box where liquid lubrication is performed, if the lip of the oil seal is always exposed to oil, there is a possibility that the oil may penetrate into the inside of the motor in the course of time. Therefore the height of the oil level must be lower than the oil seal lip. When the servo motor is mounted with the output shaft upward, mount another oil seal at machine side which will divert any oil which has passed through the first oil seal. The oil seal used for each motor model is listed in the following.

5. AC SERVO MOTOR MAINTENANCE

Motor model	Oil seal specification (Standard motor)	Oil seal specification (Motor with brake)
1-0S, 2-0S	AB0598E0 (SB type)	
0S, 5S	A98L-0004-0249/A1188R	AB1314F0 (SB type)
0L, 5L, 6L	AB1314F0 (SB type)	
10S to 40S	A98L-0004-0249/A1189R	AB2057G0 (SB type)
7L, 10L	AV2057G0 (SB type)	
50S to 70S	AB3220E0 (SB type)	

The SB type oil seals are the products NOK Co., Ltd.

The A98L type oil seal is an exclusive oil seal supplied by FANUC.

- (3) When the servo motor is coupled to the load through gears, timing belt, etc; or the force exerted on the motor shaft must not exceed the values shown in the following table. Therefore due care should be taken for the operating condition, mounting method, and mounting precision.

Motor model	Permissible radial load
1-0S, 2-0S, others	25kg
0S, 5S, 0L, 5L, 6L	70kg
10S to 40S, 7L, 10L	450kg
3-0S, 4-0S	8kg
5-0	4kg
50S to 70S	900kg

- (a) The values of permissible radial loads are the ones when the load is imposed at the end of the shaft. The values in this table indicate the maximum permissible loads which are the sum of the constant force always exerted on the shaft owing to the mounting method (e.g., the force given by the tension of the belt when the belt coupling is used) and the force generated by the load torque (e.g., the force transmitted from the gear or pulley outer diameter).
- (b) As a rule, axial load to the shaft should be avoided. Servo motor contains a precision detector, and excess axial shock may damage the detector.

5. AC SERVO MOTOR MAINTENANCE

- (4) Make the wiring between the servo motor and the control circuit without any mistake, just as specified in the FANUC AC Servo Motor Series Descriptions (B-65002). (See the connection diagram of the machine.) A mistake made in the wiring may cause runaway or abnormal oscillation and may damage the motor or the machine. When the wiring is completed, measure the insulation between the power line and the motor frame before turning on the power. The measurement should be made with a 500V megger. Further, check the insulation between the signal lines and the motor frame with a multi-tester. Be sure not to use a megger for measuring the insulation or the signal lines for the pulse coder.

5.1.3 Replacement of pulse coder

This section describes how to replace a pulse coder and how to check the phase-relationship between the AC servo motor and the pulse coder. If possible, re-check the phase-relationship after replacing it.

- (1) The method being described here is applicable to AC servo motors of model types 0S, 5S, 10S to 70S and L series. Regarding replacement of the pulse coder, although it is possible to separate and exchange the pulse coder in model type 2-0S and 1-0S, it is not recommended. The pulse coder in models 3-0S, 4-0S and 5-0 cannot be replaced because it is directly assembled on to the motor.

- (a) Remove defective pulse coder. (see Fig. 5.1.3(a))

- ① remove rubber cap.
- ② remove bolt (m5).
- ③ remove the 3 screws (m4). Be careful not to drop the screws.
- ④ remove pulse coder (+ attachments) from the motor shaft.

- (b) Mount new (good) pulse coder

- ① mount pulse coder (+ attachments) on the motor shaft. Notice that both a tooth of coupling and a groove of pulse coder mesh together. Care should be taken, for fitting length is short.
- ② replace the bolt (m5).
- ③ adjust marking-off line between attachments of pulse coder and motor housing.
- ④ replace the 3 screws (m4). Be careful not to drop the screws.

- (2) The way of checking the phase-relationship

The method written here is applicable to all AC servo motors.

- ① connect V to W. (see Fig. 5.1.3(b))
- ② excite motor at rated DC current from U to V & W. (U: +, V & W: -)
- ③ supply DC 5V to the pulse coder, and check signals of C1 to C8. Correct pattern is as follows.

	C1	C2	C4	C8
	1	1	1	1
or	1	1	1	0

(1: High 0: Low)

Change position of *C8 is accurate.

5. AC SERVO MOTOR MAINTENANCE

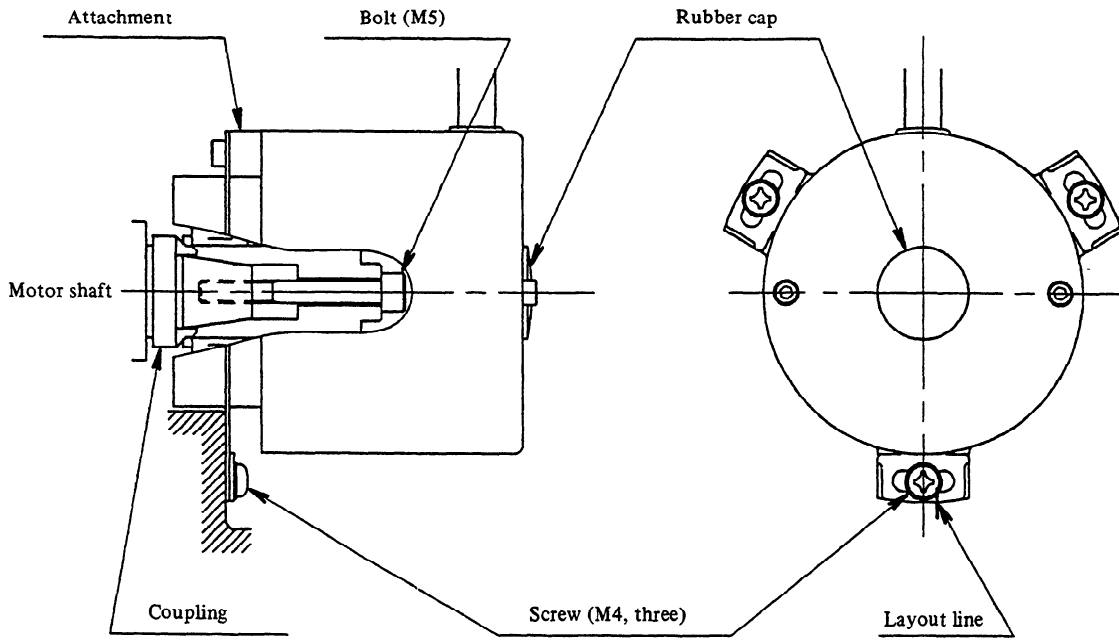
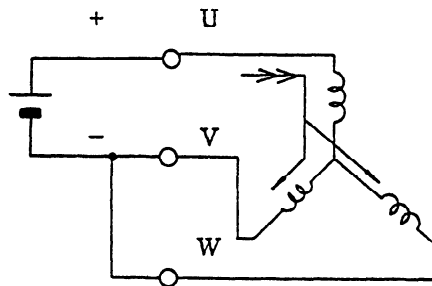

Fig. 5.1.3 (a)

*The DC excitation current when performing the phase-related check is as shown in Fig. 5.1.3 (b).



Motor model	DC electric current
3-0S, 4-0S	1.2A
1-0S, 2-0S	3.0A
0S, 5S	6.0A
10S	10.0A
0L, 5L	15.0A
30/2000, 20S to 70S	20.0A

Fig. 5.1.3 (b)

5.2 Connecting the Phase C Signal for a Separately Installed Pulse Coder (Only for Series 0)

With series 0, a phase C signal for detecting the rotor position is connected between the connectors for detecting feedback from the built-in pulse coder and the separately installed pulse coder. (See Fig. 5.2.)

When constructing a fully closed system using a separately installed pulse coder, the system may shift from its mountings, vibrate, or an alarm resulting from disconnected wiring may be generated if the cable have not been connected satisfactorily.

Therefore, it is necessary to use a cable that does not have the phase C signal of the separately installed pulse coder connected to the 10 to 13 pins of the connector for detecting feedback from the separately installed pulse coder.

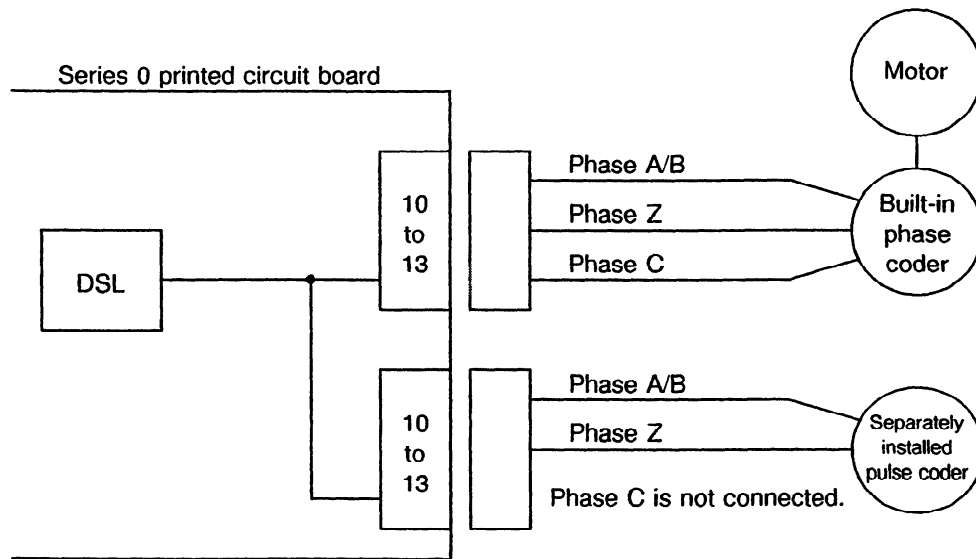

Fig. 5.2 Connecting a separately installed pulse coder with the Series 0 board

6. CHECK BOARDS

6.1 Configuration

The checkboard receives the digital value used for control inside the digital servo as numerical data and converts it to an analog form. This makes it possible to observe the analog voltage using an oscilloscope, brush recorder, etc.

The data sent to the checkboard from the digital servo CPU differs according to the series of the digital servo, the version number, the type of motor and the number of pulses of the pulse coder.

In the checkboard, in addition to the function to transform the data from the CPU to voltage, there is a function to transform (F-V transformation) the pulse array from the motor pulse coder to a DC voltage.

Furthermore, there is a function (multiply function) which decreases the number of pulses from the pulse coder by 1/2, 1/5 and 1/10 making it able to respond to a high-resolution pulse coder.

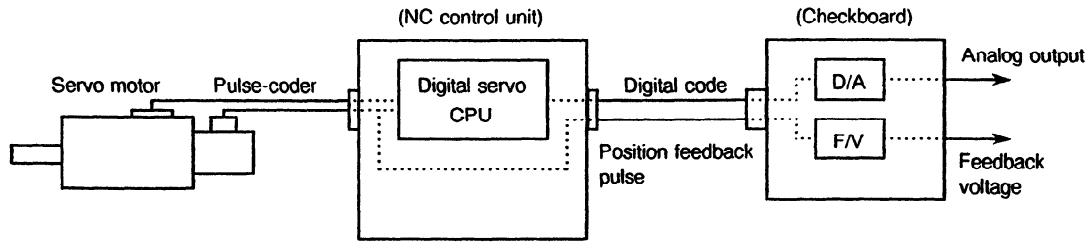

Fig. 6.1 (a) Checkboard configuration diagram

The signals listed in the table below are output to the check board.

Table 6.1 (b) Output signals

GND	0V used as reference for other signals
CH1, CH2, CH3, CH4, CH5, CH6, CH7, CH8	Internal control information output by digital servo software
TSAL, TSAM	Signals produced by converting (F/V) output pulse signal from pulse coder built into motor to voltage. Motor speed is indicated. (These signals are not applicable when serial pulse coders are used.)

With the check board, the speed signal of the first axis (L axis) is output to TSAL, and the speed signal of the second axis (M axis) is output to TSAM. When a serial pulse coder is used, conversion (F/V) to voltage is impossible because of a different scheme used. So TSAL and TSAM cannot be used. For this reason, similar signals are produced by servo software for output to CH5 and CH6.

The meaning and conversion of each of the terminal signals (CH1, CH2, CH3, CH4, CH5, CH6, CH7, and CH8) depend on the digital servo ROM series/edition and rotary switch (RS) setting.

6.2 Types of Unit and Designated Specifications

With Series 16, a check board signal is mixed with an analog signal used for spindle control, and output through the same connector. So, specify an adaptor as well as a check board for Series 16.

Series 0 and 15 do not require such an adaptor. See Section 6.9.4 in this part and Section 5 in Part III for detailed information.

Table 6.2 (a) Designated specification of unit

Designated specifications	Remarks
A06B-6057-H602	Check board (Keyed connector type)
A02B-0120-C211	Adapter (necessary only for Series 16)

There are two kinds of connectors between the checkboard and NC, the keyed type connector and the old IC socket connector. The keyed type is used on most the 32 bit CNCs.

All FS10, FS11 and FS12 machines and old FS0, FS15 use the IC socket connector therefore make sure to specify A06B-6057-H601 (with IC socket connector) when using these machines. A more detailed table is given in Section 6.9.4.

Detailed specifications of the two configurations are shown in the table 6.2 (b).

Table 6.2 (b) Configuration of unit

Designated specifications	Items included in the designated specification
A06B-6057-H601	Printed board A16B-1600-0320 Cable A66L-2040-0007 (The cable uses an IC socket (DIP) type connector at each end.)
A06B-6057-H602	Printed board A16B-1600-0320 Cable A660-2001-T998#16A0400 (The cable has a keyed connector at each end to prevent wrong insertion.)
A02B-0120-C211 (for Series 16)	Adaptor board configuration. For details, see Chapter 5 in Part III. Adaptor board A20B-1004-0940 Adaptor cable A660-2024-T007#L100R0B

6.3 Checkboard Connections

The connection between the checkboard and the master P.C.B., or between it and the additional axis P.C.B., is made using the back-to-back IC socket cable (14 PIN) supplied with the checkboard or with the keyed connector flat cable (16 PIN).

Before connecting the checkboard, turn the NC power off.

For Series 16 adaptor board connection, see Chapter 5 in Part III.

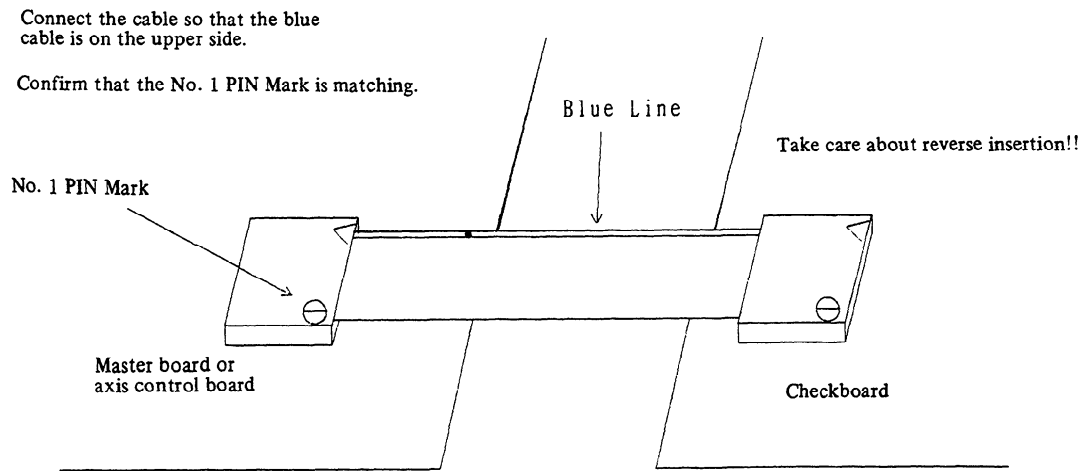

Fig. 6.3 (a) Connection of connector IC socket type

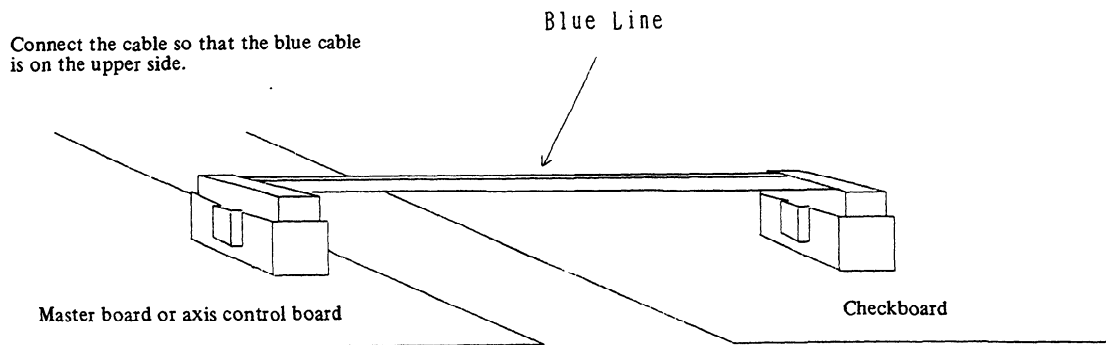

Fig. 6.3 (b) Connection of connector to prevent wrong insertion

6.4 Output Signal

(1) When conventional pulse coders (other than serial pulse coders) are used

Table 6.4 (a) indicates output signal locations.

Table 6.4 (a) Output signals (when serial pulse coders are not used)

RS location	TSAL	TSAM	CH1	CH2	CH3	CH4	CH5	CH6	CH7	CH8
0	TSA/L	TSA/M	VCMD/L	TCMD/L	VCMD/M	TCMD/M	—	—	—	—

L axis M axis L axis L axis M axis M axis

(Note) The earlier editions of the servo ROM have a different signal output format. For detailed information, see Section 6.9.2.

Applicable ROM series/editions: 9000 series/edition L or earlier
 9001 series/edition H or earlier
 9002 series/edition C or earlier

(2) When serial pulse coder A, B, or C is used

As indicated in Table 6.4(b), the TSA signals differ in output location between the conventional pulse coders and serial pulse coders.

Table 6.4 (b) Output signals (when serial pulse coders are used)

RS location	TSAL	TSAM	CH1	CH2	CH3	CH4	CH5	CH6	CH7	CH8
0	—	—	VCMD/L	TCMD/L	VCMD/M	TCMD/M	TSA/L	TSA/M	—	—

L axis L axis M axis M axis L axis M axis

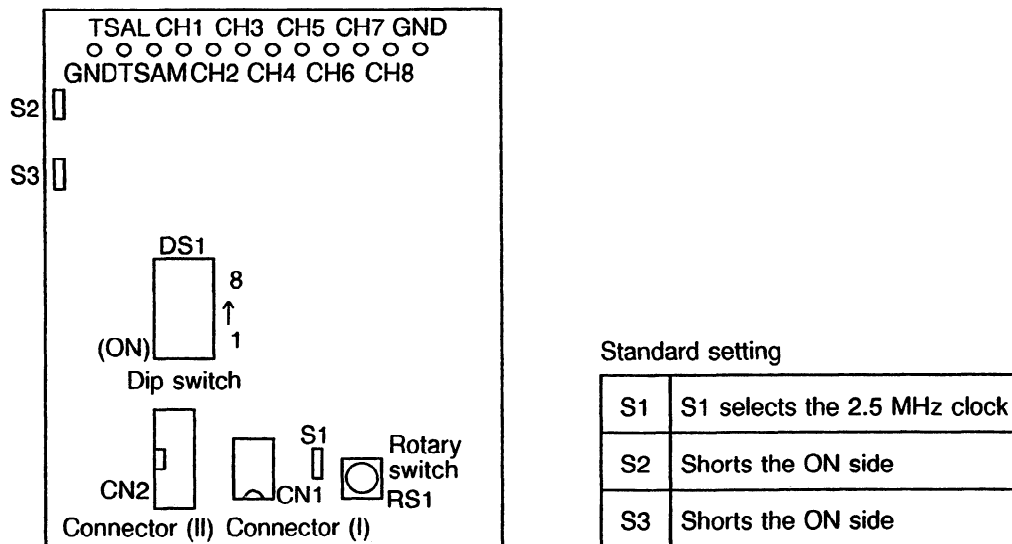

Fig. 6.4 External view of checkboard

6.5 Digital Servo Block Diagram

Fig. 6.5 shows the block diagram of the digital servo, and the relationships between the VCMD, TCMD, and TSA signals.

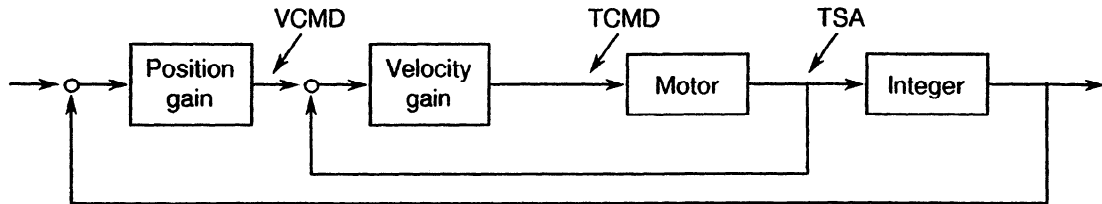

Fig. 6.5 Digital servo block diagram

6.6 VCMD Signal

The VCMD (Velocity Command) signal means the motor velocity command. However, because there is a simultaneous relationship of (position gain) × (position deviation), it is possible to check position deviation during operation.

(Note) When the feed forward function is used, VCMD does not include its signal and so is less for a given motor speed.

The velocity command rotations and VCMD magnification rates corresponding to the numbers of pulse coder pulses are indicated below.

Table 6.6(a) VCMD signal conversion table

Pulse coder pulse count (pulse)	Velocity command rotation (rpm/5V) (VCMD magnification rate: 1)	VCMD magnification rate (No.1956, 8X12)		
		bit 5 = 0 bit 4 = 1	bit 5 = 1 bit 4 = 0	bit 5 = 1 bit 4 = 1
2000	480	1920	7680	30720
2500	384	1536	6144	24576
3000	320	1280	5120	20480
10000 Including serial pulse coder C.	96	384	1536	6144
12500	76.8	307.2	1288.8	4915.2
15000	64	256	1024	4096
20000	48	192	768	3072
25000	38.4	153.6	614.4	2457.6
30000	32	128	512	2048
1048576 Including serial pulse coder A, B	0.9155	14	234	3750

6. CHECK BOARDS

(1) VCMD magnification rate

The weight of VCMD output can be made variable using a parameter. This capability is available with the software indicated below. By changing the weight of VCMD signal, an overall waveform measurement and fine measurement can now be made.

Applicable servo ROM: Edition 9030/001K or later
Edition 9040/001A or later

No.1956 (Series 15) 8X12 (Series 0-C)		Magnification rate for conventional VCMD output	
bit 5	bit 4	Conventional pulse coder	Serial pulse coder A, B
0	0	1 (as before)	1 (as before)
0	1	4	16
1	0	16	256
1	1	64	4096

(The same magnification rates as for the conventional pulse coders apply to serial pulse coder C.)

(2) In a closed loop system with serial pulse coder A or B, the VCMD signal is converted as shown in the table below. (This table does not apply to a system with serial pulse coder C.)

No.1956 (Series 15) 8X12 (Series 0-C)		VCMD signal conversion in a closed loop system with a serial pulse coder (rpm/5 V)
bit 5	bit 4	
0	0	468
0	1	1875
1	0	7500

(3) The actual VCMD waveform is a $\pm 5V$ foldback waveform as shown in Fig. 6.6 (a) and therefore when the calculation value exceeds $\pm 5V$, add or subtract 10V, put back the $\pm 5V$ and compare the waveforms.

At high speeds, the signal is looped back at 5V. So the entire waveform may not be observed easily during rapid traverse acceleration/deceleration or when a high-resolution pulse coder is used. In such a case, modify the VCMD magnification rates described in Item (1) above.

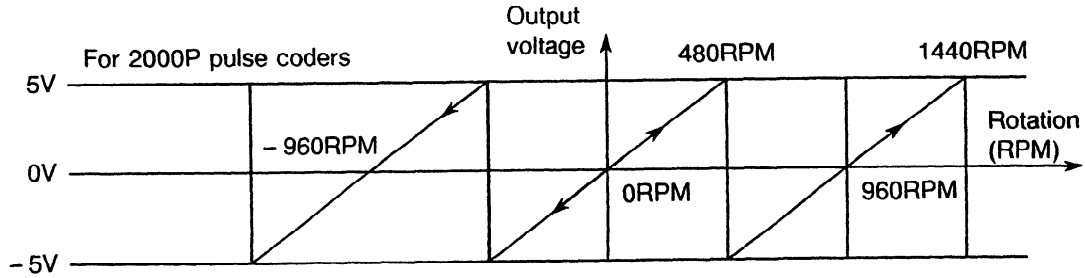

Fig. 6.6 (a) VCMD waveform

- (4) In general, VCMD (motor speed at 5V) conversion is to be performed according to the number of pulses of a pulse coder used as follows:

$$VCMD = 960000/P \times M \text{ [rpm/5V]}$$

P : Number of pulse coder pulses

M : VCMD magnification rate (See Item (1) above.)

- Example 1: If a 2000 P pulse coder is used when bit 5 is 0 and bit 4 is 1 for No. 1956 and 8X12, VCMD signal 5 V corresponds to the following:

$$480 \times 4 = 1920 \text{ (rpm)}$$

- Example 2: If a 30000 P pulse coder is used when bit 5 is 1 and bit 4 is 1 for No. 1956 and 8X12, VCMD signal 5 V corresponds to the following:

$$32 \times 64 = 2048 \text{ (rpm)}$$

- (5) The positioning deviation can be calculated from the VCMD signal as described below.

The relationship between the velocity and positioning deviation is represented by the following expression:

$$V \text{ (pulse/s)} = E \text{ (pulse)} \times PG \text{ (1/s)}$$

(V: Velocity, E: Positioning deviation, PG: Position gain)

If the number of position feedback pulses per motor revolution (after flexible feed gear or DMR) is N_p , the weight of the VCMD signal (rpm/V) is W_v (see the conversion table in Section 6.6), and the position gain (1/s) is PG, the following relationships apply:

$$V = \frac{N_p \cdot W_v}{60} \text{ [(pulse/s)/5v]}$$

$$\epsilon = \frac{V}{PG} = \frac{N_p \cdot W}{60 \cdot PG} \text{ [pulse/5v]}$$

6. CHECK BOARDS

The voltage per pulse of positioning deviation is calculated as follows:

$$1/\varepsilon = \frac{60 \cdot PG}{N_p \cdot W} \times 5 \text{ [V/pulse]}$$

Example 1: 2000 pulses, DMR = 4, $PG = 30S^{-1}$, semi-closed loop system
Weight of the VCMD signal of 2000 pulses: $W_v = 480 \text{ [rpm/5 V]}$
As DMR is 4: $N_p = 2000 \times 4 = 8000 \text{ [pulse/rev]}$
The voltage per pulse of positioning deviation is calculated as follows:

$$\frac{60 \cdot 30 \cdot 5}{8000 \cdot 480} = 0.00234 \text{ [V]} = 2.34 \text{ [mV]}$$

Example 2: 10000 pulses, flexible feed gear of 1/4, $PG = 40S^{-1}$, semi-closed loop system
Weight of the VCMD signal of 10000 pulses: $W_v = 96 \text{ [rpm/5 V]}$
As the gear ratio of the flexible feed gear is 1/4:
 $N_p = 10000 \times 4 \times 1/4 = 10000 \text{ [pulse/rev]}$
The voltage per pulse of positioning deviation is calculated as follows:

$$\frac{60 \cdot 40 \cdot 5}{10000 \cdot 96} = 0.0125 \text{ [V]} = 12.5 \text{ [mV]}$$

Example 3: Serial pulse coder A, flexible feed gear of 1/100, $PG = 30S^{-1}$, semi-closed loop system
Weight of the VCMD signal in a semi-closed loop system with serial pulse coder A: $W_v = 0.9155 \text{ [rpm/5 V]}$
As the gear ratio of the flexible feed gear is 1/100:
 $N_p = 1000000 \times 1/100 = 10000 \text{ [pulse/rev]}$
The voltage per pulse of positioning deviation is calculated as follows:

$$\frac{60 \cdot 30 \cdot 5}{10000 \cdot 0.9155} = 0.983 \text{ [V]} = 983 \text{ [mV]}$$

Example 4: Serial pulse coder A, scale provided, 10000 position pulses per motor revolution, flexible feed gear of 1/1, $PG = 30S^{-1}$
Weight of the VCMD signal in a closed loop system with serial pulse coder A: $W_v = 468 \text{ [rpm/5V]}$
As the gear ratio of the flexible feed gear is 1/1:
 $N_p = 10000 \times 1/1 = 10000 \text{ [pulse/rev]}$
The voltage per pulse of positioning deviation is calculated as follows:

$$\frac{60 \cdot 30 \cdot 5}{10000 \cdot 468} = 0.00192 \text{ [V]} = 1.92 \text{ [mV]}$$

6. CHECK BOARDS

To check minute vibrations, monitor the entire vibration on the DC coupling of the oscilloscope, then enlarge and monitor the desired range on the AC coupling. The irregularity of positioning deviation can be obtained by reversing the calculation.

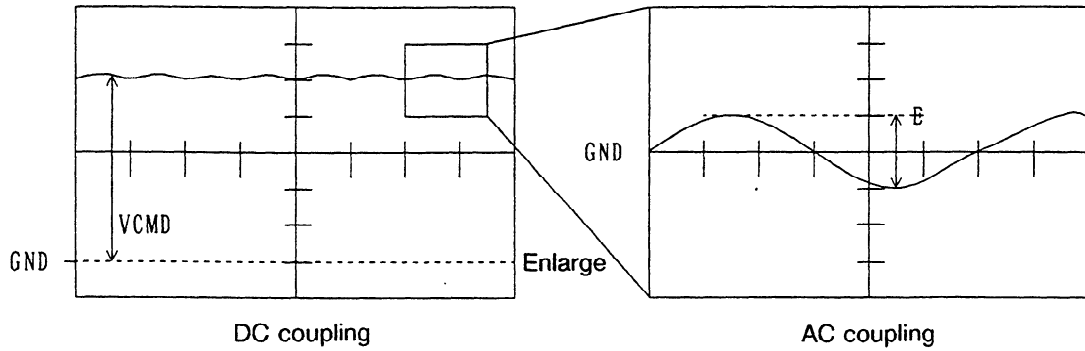

- ① Measurement of the velocity command ② Measurement of the positioning deviation irregularity

Fig. 6.6 (c) Measurement of the Velocity Command and Positioning Deviation Irregularity

Example: When DMR is set to 4, PG is set to 30, 1 pulse is set to $1 \mu\text{m}$, E is set to 10 mv in Fig. 6.6 (c) - ②,

$$10/2.34 = 4.27$$

The vibration of the motor (or table in a closed loop system) is about $4 \mu\text{m}$.

6.7 TCMD Signal

The TCMD (Torque Command) signal commands the motor generated torque.
It is the current command value of each of the R, S, T phases.

Table 6.7 TCMD signal conversion table

Maximum current	Signal output for maximum current	Current /1V	Applicable servo motor
2Ap	4.44V	0.45Ap	5-0
4Ap	4.44V	0.9Ap	3-0, 4-0 (185V INPUT)
4Ap	4.44V	0.9Ap	3-0S, 4-0S (200V INPUT)
12Ap	4.44V	2.7Ap	1-0, 2-0, 1-0S, 2-0S (310), 1-0S/3000
40Ap	4.44V	9Ap	0, 5, 10, 0-0SP, 0S, 5S, 10S, 20S/1500, 0L, 0T/3000, 5T/2000, 10T/2000
76Ap	4.22V	18Ap	30, 20S, 30S, 5L, 6L
80Ap	4.44V	18Ap	5S/3000, 6S/3000, 10S/3000, 5T/3000, 10T/3000
90Ap	4V	22.5Ap	30/2000
100Ap	4.44V	22.5Ap	40, 7L, 10L
130Ap	4.44V	29Ap	20S/3000, 30S/3000, 40S/2000
200Ap	4V	50Ap	50S
300Ap	4V	75Ap	60S, 70S

(Note 1) The signal is the peak value. In order to convert to the RMS value, multiply by 0.71.

(Note 2) Maximum current is the current limit of the servo amplifier. Thus the signal output for maximum current is the torque limit value.

For example, in the case of AC Model 30/2000

Limit current = 90 [Ap]

Torque limiter (TQLIM) = 6554

TQLIM: No.1872, No.8X60

$$\begin{aligned} \text{Output voltage when maximum current} &= 4.44 \times \frac{\text{TQLIM}}{7282} \\ &= 4.44 \times \frac{6554}{7282} = 4.0 \text{ [V]} \end{aligned}$$

$$\begin{aligned} \text{Output voltage when maximum current} &= \text{maximum current} \\ 4 \text{ [V]} &= 90 \text{ [Ap]} \end{aligned}$$

Each 1 [V] will become 22.5 [Ap].

(Note 3) In high-speed rotation, the back electromotive force of the motor has considerable influence and the value of TCMD may be different from the actual current value.

6.8 TSA Signal

When a conventional pulse coder rather than the serial pulse coders is used, a TSA signal is produced by converting (frequency-to-voltage) an output pulse signal from the pulse coder of a motor to voltage. The conversion output indicates the speed (actual speed) of the motor.

When a serial pulse coder is used, conversion from frequency to voltage is impossible because of a different output pulse scheme used. So similar signals are produced by servo software for output to CH5 and CH6.

Usually it is easier to calculate the position deviation backwards from the VCMD signal, but when using full close systems etc., it is possible to check the difference in movement between the motor shaft and table by comparing the position deviation of both signals.

- (1) When a conventional pulse coder rather than the serial pulse coders is used, the TSA signal is output to TSAL and TSAM.

Table 6.8 (a) TSA signal setting and conversion table

L axis (M) Pulse coder	DS1-1 (DS1-3)	DS1-2 (DS1-4)	DS1-5 (DS1-7)	DS1-6 (DS1-8)	Conversion	Multiply setting
2000P	x	x	○	x	2.4V/1000rpm	1/1
2500P	x	x	x	x	2.4V/1000rpm	1/1
3000P	x	x	x	○	2.4V/1000rpm	1/1
10000P	x	○	○	x	2.4V/1000rpm	1/5
12500P	x	○	x	x	2.4V/1000rpm	1/5
15000P	x	○	x	○	2.4V/1000rpm	1/5
20000P	○	○	○	x	2.4V/1000rpm	1/10
25000P	○	○	x	x	2.4V/1000rpm	1/10
30000P	○	○	x	○	2.4V/1000rpm	1/10

6. CHECK BOARDS

(2) When serial pulse coder A, B, or C is used, the TSA signal is output to CH5 and CH6.

Table 6.8 (b) TSA signal setting and conversion table

Conversion	3750 rpm/5V (Serial pulse coder A, B)
	3840 rpm/5V (Serial pulse coder C)

(Note 1) DS1-1 to DS1-8 represent switch positions 1 to 8 of DIP switch DS1. The switch numbers are marked on the surfaces of the DIP switch and PCB.

(Note 2) “○” shows the dip-switch is ON; “×” show it is OFF.

(Note 3) Inside () is the switch name for the M axis case.

(3) Multiply setting

Multiply setting enables the TSA signal to be reduced by a multiply ratio before it is output. In particular, when a high-resolution pulse coder is used, multiply setting prevents the TSA signal from saturating at highest speeds, thus facilitating measurement.

The setting of the DIP switches is shown in Table 6.8 (c).

Table 6.8 (c) Multiply setting table

Multiply setting inside () is M axis case	DS1-5 (DS1-7)	DS1-6 (DS1-8)
1/1	×	×
1/2	○	×
1/5	×	○
1/10	○	○

(Note 1) Motor movements during stop are not shown accurately except at a multiply of 1/1. As a result, when it is necessary to closely observe the small movements during machine stop or conditions at low speeds, the multiply should be set at 1/1 for best results.

(Note 2) In a closed-loop system, the TSA signal is output from the pulse coder built into a motor.

(Note 3) Method of determining motor operation from the TSA signal

In the full close system, it is possible to compare position movement of both the table and motor shaft from the VCMD signal and the TSA signal.

When measuring the TSA signal, it is possible to check the smallest of vibrations by looking at the DC coupling of the oscilloscope as a whole and then the AC coupling and then enlarging the range.

6. CHECK BOARDS

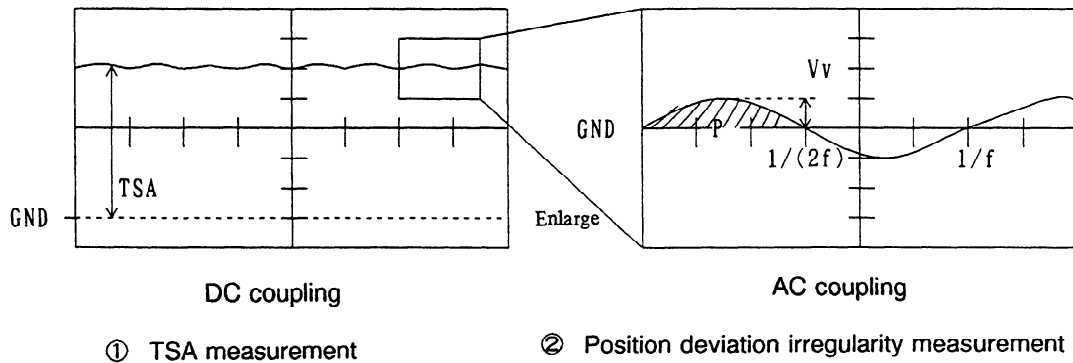

Fig. 6.8 (a) Measuring the TSA and position deviation irregularity

In ② in Fig. 6.8 (a) velocity deviation V_v (V) and vibration frequency f (Hz) is measured. If the checkboard has standard settings, it is 1000rpm when $TSA = 2.4V$ and therefore

$$V_r \text{ (rpm)} = \frac{V_v \text{ (V)}}{2.4} \times 1000$$

Changing the unit at $4 \times N_p$ (pulse/rev) $\times (1/60)$ (m/s) gives

$$V_p \text{ (pulse/s)} = \frac{4 \times 1000 \times N_p}{2.4 \times 60} \times V_v \text{ (V)}$$

Here N_p is the pulse coder pulse count (pulse/rev).

If the velocity (V_p (pulse/s)) of the oblique line in ② in fig. 6.8 (a) is integrated it is possible to calculate the position (P (pulse)) deviation in between. Assuming the vibration waveform to be a sine wave, the calculation formula is

$$P \text{ (pulse)} = \int_0^{1/(2f)} \frac{4 \times 1000 \times N_p}{2.4 \times 60} \times V_v \text{ (V)} \times \sin 2\pi f t \cdot dt$$

$$= 8.842 \times \frac{N_p \times V_v \text{ (V)}}{f \text{ (Hz)}}$$

(As the sine wave is assumed, if the vibration frequency width is measured a more accurate value can be obtained.)

(f is the vibration frequency.)

(Example) If the checkboard at pulse coder pulse count = 20000 pulses, has standard settings and TSA signal vibration frequency width is $V_v = 2mV$ and vibration frequency is $f = 100Hz$, then the position deviation P (pulse) becomes

$$P \text{ (pulse)} = 8.842 \times \frac{20000 \times 2 \times 10^{-3}}{100}$$

$$= 3.54 \text{ (pulse).}$$

If 1 pulse = 1 μm , then deviation is approximately 3.5 μm .

6.9 Reference Data for the Check Board

6.9.1 Old checkboard (A16B-1600-0210) output signal

The output signal from old checkboard are shown in Table Referenced.

Table 6.9.1 (a) Output signal

GND	The common of other signals is OV.
CH1, CH2, CH3, CH4	The internal control information is output according to the digital servo software.
TSA	This is the signal that transforms (F/V) the output pulses of the motor encoder to voltage. (It shows the RPM of the motor.)

In the old checkboard A16B-1600-0210 select either the 1st axis (L axis) or the 2nd axis (M axis) by the toggle switch TSI and output the speed signal to TSA.

(1) TSA signal

Table 6.9.1 (b) Table of TSA signal setting and conversion

Pulse coder	S2	S3	Conversion	Maximum number of rotations possible to output
2000P	H	L	2.4V/1000rpm	3750rpm
2500P	L	L	2.4V/1000rpm	3000rpm
3000P	L	H	2.4V/1000rpm	2500rpm
10000P	H	L	2.4V/200rpm	750rpm
12500P	L	L	2.4V/200rpm	600rpm
15000P	L	H	2.4V/200rpm	500rpm
20000P	H	L	2.4V/100rpm	375rpm
25000P	L	L	2.4V/100rpm	300rpm
30000P	L	H	2.4V/100rpm	250rpm

6. CHECK BOARDS

The meaning and conversion of the signals at each terminal CH1, CH2, CH3 and CH4 differ according to the digital servo ROM version number and the rotary switch RSI setting.

The output signals are as shown in the table 3.

Furthermore, regarding the ROMs in the digital servo

ROM 9000 series L version and earlier

9001 series H version and earlier

9002 series C version and earlier

refer to Section 6.9.2 because the locations of the signal output differ.

Table 6.9.1 (c) Output signal

RS position	CH1	CH2	CH3	CH4
0	VCMD (L)	TCMD (L)	VCMD (M)	TCMD (M)

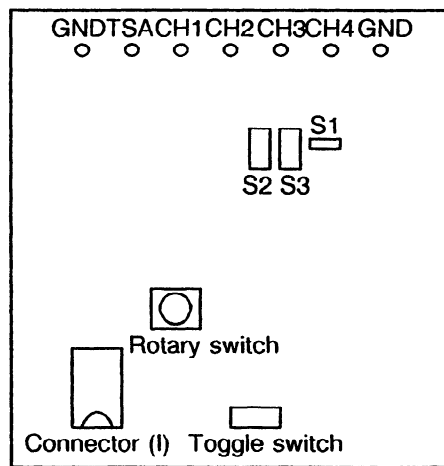

S1 is normally set to short.

Fig. 6.9.1 External view of old checkboard

(2) VCMD signal and TCMD signal

Because the conversion of the VCMD signal and TCMD signal in the old checkboard is the same as the conversion in the new checkboard, please refer to Table 6.6 (a) and Table 6.7.

6.9.2 Old ROM version number output signal

The output signal of the digital servo with the new check board

ROM 9000 series L version and earlier

9001 series H version and earlier

9002 series C version and earlier

is as shown in the table 6.9.2 (a).

Table 6.9.2 (a) Output signal

RS position	CH1	CH2	CH3	CH4	CH5	CH6	CH7	CH8
0	VCMD (L)	TCMD (L)	—	—	VCMD (M)	TCMD (M)	—	—

Furthermore, in the old checkboard it is output as shown in the table 6.9.2 (b).

Table 6.9.2 (b) Output signal

RS position	CH1	CH2	CH3	CH4
0	VCMD (L)	TCMD (L)	—	—
1	VCMD (M)	TCMD (M)	—	—

6.9.3 Socket exchange periods

There are two kinds of connectors between the checkboard and NC, the keyed type connector and the old IC socket connector. The following table lists all NC machine types and compatible connectors.

Series of NC \ Diagnostic board (connector)	Prepare both A06B-6057-H602 A02B-0120-C211	A06B-6057-H602 (keyed type)	A06B-6057-H601 (IC socket type)
Series 16	○ (*1)	×	×
Series 0-A, B Series 0-C (16 bit) Axis control PCBs A16B-2200-0220, 0221, 0330	×	×	○
Series 0-C (32 bit) Axis control PCBs A16B-2200-0360, 0361, 0371, 0380	×	○	×
Series 15 axis control PCBs A16B-2200-0080 to 81 (up to editions 01A to 05B) A16B-2200-0090 to 93 (up to editions 01A to 05A)	×	×	○
Series 15 axis control PCBs A16B-2200-0080 to 81 (edition 06B or later) A16B-2200-0090 to 93 (edition 06A or later)	×	○	×
Power Mate A, B	×	○	×
Series 10	×	×	○
Series 11	×	×	○
Series 12	×	×	○

(*1) See Chapter 5 in Part III for detailed information.

7. TROUBLESHOOTING DIGITAL SERVO DEVICES

Troubleshooting and fault recovery of servo problems (alarms) are described in this chapter. (For problems relating to vibration or precision for which no alarms occur, see Chapter 8. DIGITAL SERVO ADJUSTMENT PROCEDURE.)

7.1 Digital Servo Alarms

Digital servo alarms are detected by the servo amplifier and servo software. Common alarm codes are then sent from the servo software to the NC, where corresponding error messages are displayed. (See Fig. 7.1(a).)

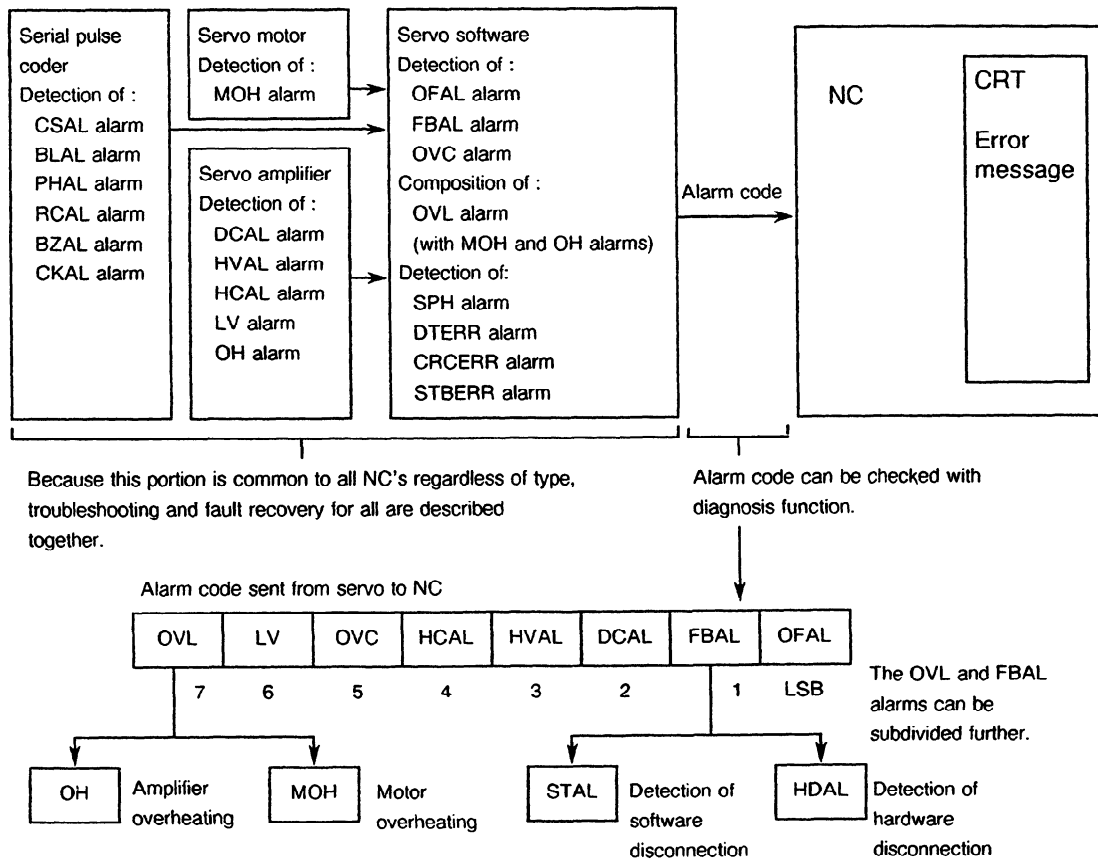

Fig. 7.1(a) Digital servo alarms

7. TROUBLESHOOTING DIGITAL SERVO DEVICES

- (1) Alarm codes are classified into those detected by the servo amplifier and those detected by the servo software. Causes and countermeasures for the two groups are different. In particular, alarms detected by the servo amplifier can be checked directly with the LEDs on the amplifier in addition to checking with error messages.

Alarms detected by the servo amplifier	Alarms detected by the servo software
DCAL alarm	OFAL alarms
HVAL alarm	FBAL alarms
HCAL alarm	OVC alarms
LV alarm	MOH alarms
OH alarm	

- (2) The OVL and FBAL alarms are further classified into detailed alarms. When either of these alarms occurs, detailed alarm data can be checked on the diagnostic screen (DGN/diagnostic information) or Alarm 2 on the servo adjustment screen.

Diagnostic data	ALDF			EXPC				
	7	6	5	4	3	2	1	0

8-bit alarm code data	Detailed alarm data	7 bit ALDF	4 bit EXPC
OVL alarm	Motor overheating	1	0
	Amplifier overheating	0	0
FBAL alarm	Disconnection of pulse coder (detection of hardware disconnection) (In Series 15, 10, 11, and 12, hardware disconnection of built-in pulse coder is detected.)	1	0
	Disconnection of pulse coder (detection of software disconnection)	0	0
	Disconnection of separate type pulse coder (hardware disconnection) (Only in Series 15, 10, 11, and 12)	1	1

(Note 1) Detailed alarm data is available in the following servo ROM Series/Editions

Servo ROM Series/Editions	: 9000/001S or later	9022/001B or later
	9001/001N or later	9030/001A or later
	9010/001E or later	9032/001A or later
	9020/001D or later	9040/001A or later

7. TROUBLESHOOTING DIGITAL SERVO DEVICES

(Note 2) When Series 0-C is used, whether a built-in or separate pulse coder is disconnected (hardware disconnection) can be checked by using the servo ROM of series 9040.

- (3) For the following servo ROM series or later, the data area for alarm codes is expanded and consequently alarm data for serial pulse coder C or C series servo amplifier are added. Refer to Chapter III-4 for details.

Servo ROM: 9050 Series, Edition 001B or later

- (4) Classification of alarms

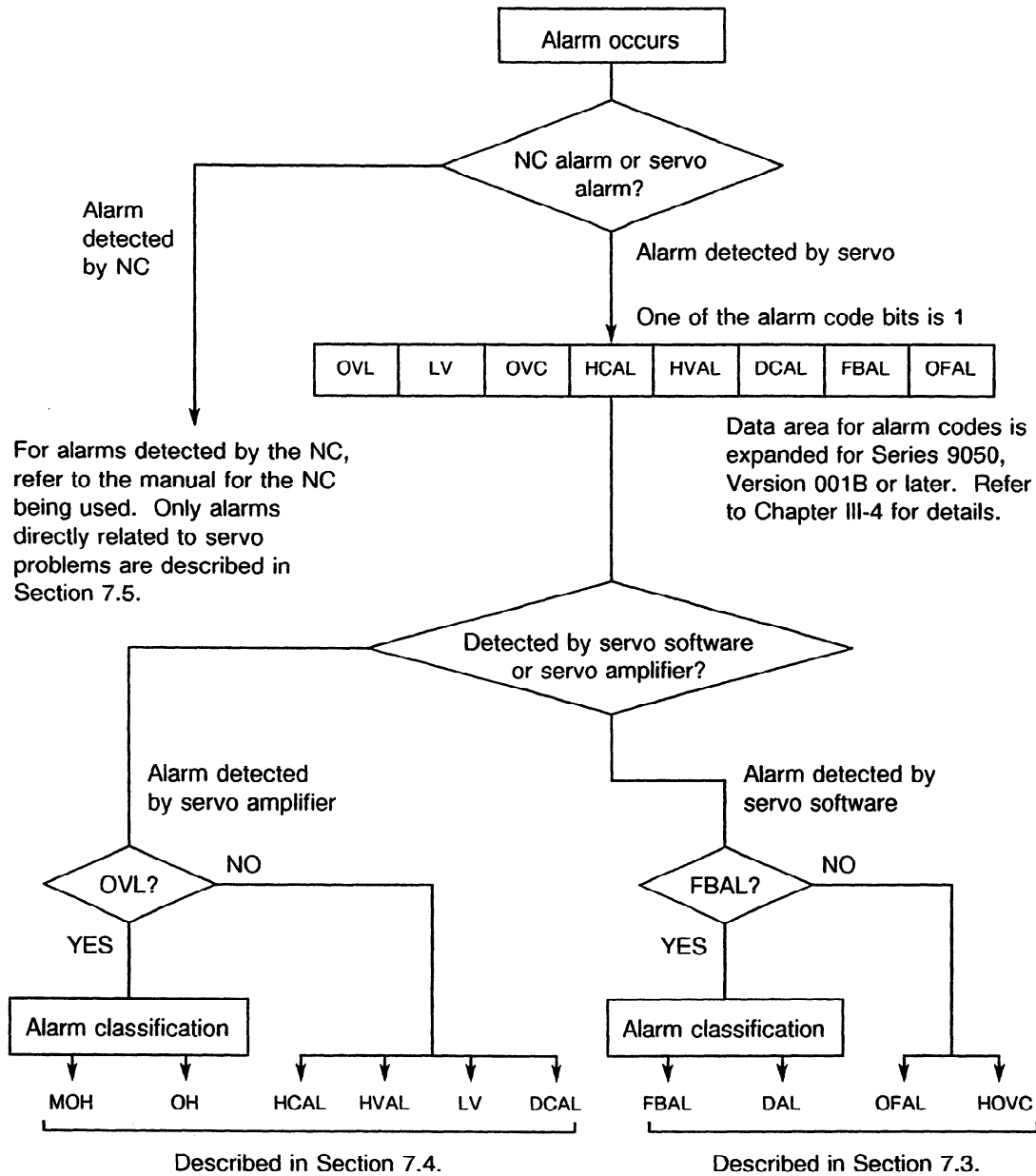

Fig. 7.1(b) Classification of alarms

7. TROUBLESHOOTING DIGITAL SERVO DEVICES

7.2 Classification of Error Messages

7.2.1 Error messages of Series 0

Table 7.2.1 Alarm list of Series 0

No.	Description (Message)	Remarks
400	Overload signal bit is on.	OVL alarm See Item 7.4.5.
4X4	DEFECT IN DIGITAL SERVO SYSTEM (DETCT ERR) Details are output in Nos. 720-723 of DGN and Alarm 1 on the servo adjustment screen.	See item (1) below.
4X6	DEFECTIVE ON-POSITION DETECTOR (DISCONNECTED) This alarm occurs when the signal from the position detector is faulty (in a semi-closed system) or when no feedback pulse is returned from a separate-type position detector such as INDUCTOSYN (fully closed system).	FBAL alarm See Item 7.3.2. See item (2) below.
4X7	INCORRECT SETTING OF SERVO PARAMETERS (DGTL PARAM)	See Item 7.5.1.

(1) Detailed contents of digital servo alarm No. 4X4 are displayed in Nos. 720-723 of DGN. When the servo adjustment screen is available, the same is displayed for Alarm 1. (See Item 8.1.3.)

No. 720 to 723	OVL	LV	OVC	HCAL	HVAL	DCAL	FBAL	OFAL
	7	6	5	4	3	2	1	0

(2) For Series 0-C, detailed alarm data for the OVL and FBAL alarms is displayed as No. 730-737 of DGN. The same is displayed for Alarm 2 on the servo adjustment screen. (See Item 8.1.3.)

No. 730 to 737	ALDF			EXPC				
	7	6	5	4	3	2	1	0

(3) To obtain detailed data on the OVL and FBAL alarms in Series 0-A and 0-B, connect the LOAD pin to GND on the master PCB and check the following addresses in DGN.

- | | |
|--|--|
| ① Servo ROM 9000 and 9001 Series
1st axis : 7818 2nd axis : 7824
3rd axis : 7A18 4th axis : 7A24 | ② Servo ROM 9010, 9020 and 9022 Series
1st axis : 7830 2nd axis : 7848
3rd axis : 7A30 4th axis : 7A48 |
|--|--|

7. TROUBLESHOOTING DIGITAL SERVO DEVICES

7.2.2 Error messages of Series 15 (including Series 10, 11 and 12)

Table 7.2.2 Digital servo alarm list for Series 10, 11, 12 and 15

No.	Description (Message)	Remarks
SV01	EXCESS CURRENT IN SERVO Overcurrent (overload) alarm occurred in the digital servo controller.	OVC alarm See Item 7.3.3.
SV03	ABNORMAL CURRENT IN SERVO High-current alarm occurred in the servo amplifier.	HCAL alarm See Item 7.4.3.
SV04	EXCESS V TO MOTOR High voltage alarm occurred in the servo amplifier.	HVAL alarm See Item 7.4.2.
SV05	EXCESS DISCHARGE I FROM MOTOR Regenerative discharge alarm occurred in the servo amplifier.	DCAL alarm See Item 7.4.1.
SV06	POWER V TOO LOW Low voltage alarm occurred in the servo amplifier.	LV alarm See Item 7.4.4.
SV11	LSI OVERFLOW Overflow alarm occurred in the digital servo controller.	OFAL alarm See Item 7.3.1.
SV15	PULSCODER DISCONNECTION Pulse-coder-disconnection alarm occurred.	FBAL alarm See Item 7.3.2, (1), (2) and (3)
SV23	SV OVERLOAD Overload alarm occurred in either the servo motor or servo amplifier. This alarm in the servo amplifier results from overheating of the servo amplifier, separate discharge unit or power transformer.	OVL alarm See Item 7.4.5, (1), (2) and (3)
SV27	<input type="checkbox"/> ILL DGTL SERVO PARAMETER An invalid value is set in parameters for the digital servo controller.	See Item 7.5.1.

7. TROUBLESHOOTING DIGITAL SERVO DEVICES

(1) To obtain detailed data on OVL and FBAL alarms in Series 15 (Series 10 or 11), check the following addresses in the CONTENT OF MEMORY screen. (For operation of the CONTENT OF MEMORY screen, see item (3) below.) When the servo adjustment screen is available, the same contents are displayed for Alarm 2. (See to subsection 8.1.3.)

① Servo ROM 9000 and 9001 Series

1st axis : F50018 2nd axis : F50024
 3rd axis : F50218 4th axis : F50224 5th axis : F50418

② Servo ROM 9010, 9020 and 9022 Series

1st axis : F50030 2nd axis : F50048
 3rd axis : F50230 4th axis : F50248 5th axis : F50430

③ Servo ROM 9030 Series

1st axis : 10200030 2nd axis : 10200048
 3rd axis : 10200230 4th axis : 10200248
 5th axis : 10220030 6th axis : 10220048

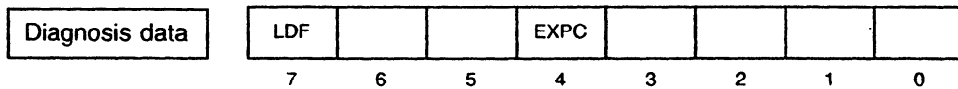

(2) To check alarm codes in the Series 15 multi-axis system, check the following addresses in DGN. When the servo adjustment screen is available, the same contents are displayed for Alarm 1. (See Item 8.1.3.)

1st axis : 3014 2nd axis : 3034
 3rd axis : 3054 4th axis : 3074
 5th axis : 3094 6th axis : 3114
 7th axis : 3134 8th axis : 3154

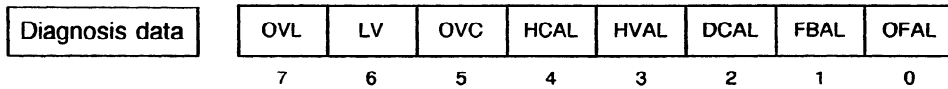

To obtain detailed data on OVL and FBAL alarms, check the following addresses in DGN. The same contents are displayed for Alarm 2 in the servo adjustment screen. (See Item 8.1.3.)

1st axis : 3015 2nd axis : 3035
 3rd axis : 3055 4th axis : 3075
 5th axis : 3095 6th axis : 3115
 7th axis : 3135 8th axis : 3155

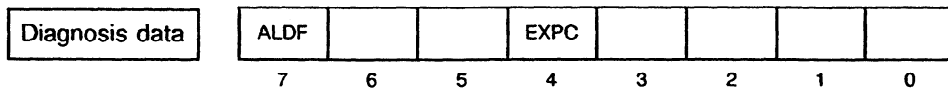

7. TROUBLESHOOTING DIGITAL SERVO DEVICES

(3) How to check alarms in Series 10, 11 and 12 (Operation of the CONTENT OF MEMORY screen)

① Pressing the SERVICE menu key changes the screen in the following sequence.

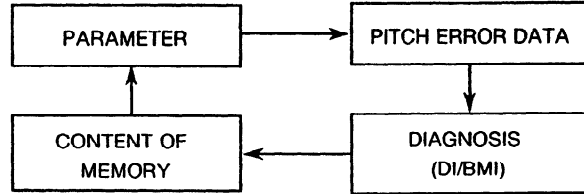

② When the CONTENT OF MEMORY screen is displayed, enter an address. For example, enter data for the 1st axis as follows.

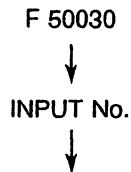

③ After step ② is performed, the following is displayed.

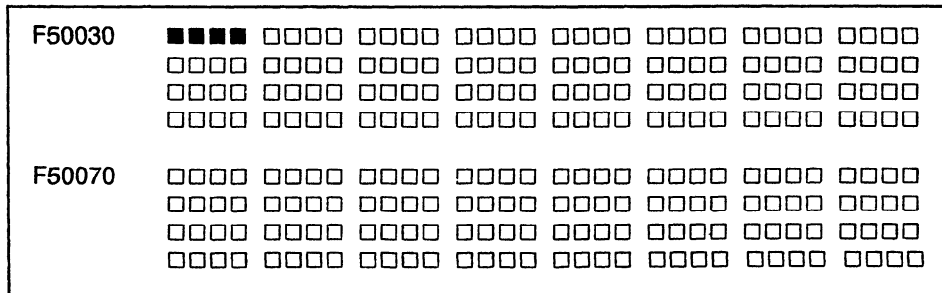

Repeat step ②. Data from the required address is displayed in ■■■■.

④ Check the last 8 bits of the contents of ■■■■ (particularly bits 7 and 4).

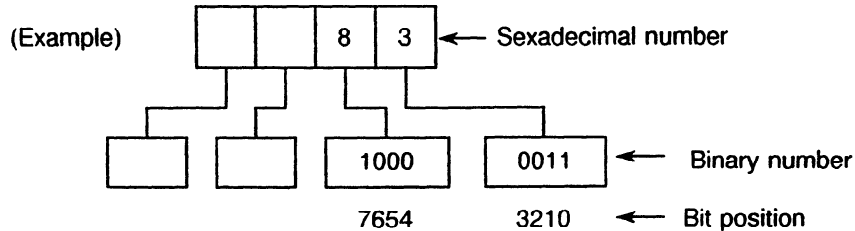

Data in bits 7 and 4 indicate that ALDF = 1 and EXPC = 0. Provided that FBAL = 1 (disconnection alarm), the cause of the alarm is a disconnection in the built-in pulse coder of motor. This alarm is detected by hardware.

7.3 Alarms Detected by Servo Software

Servo software checks the following bits (OVC, FBAL and OFAL) of the alarm code to detect alarms.

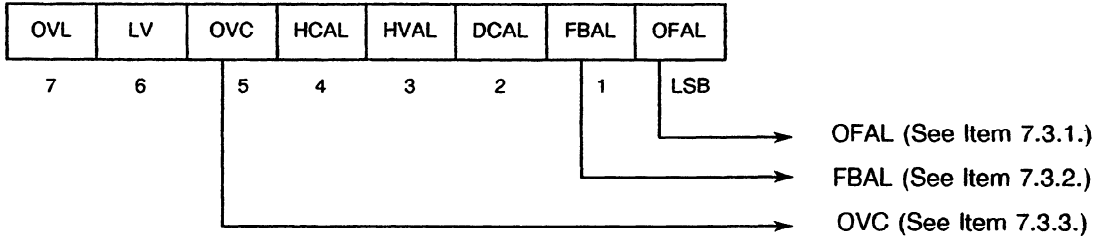

7.3.1 Troubleshooting for the OFAL (overflow) alarm

When servo software causes an overflow during calculation, an OFAL alarm is caused. Incorrect setting of servo parameters may be the cause of the alarm. Check the setting.

7.3.2 Troubleshooting for the FBAL (disconnection) alarm

The digital servo controller detects an error in the position feedback signal using the following two methods, (1) and (2). The FBAL alarm occurs when either the disconnection alarm circuit for hardware detection or software detection is faulty, or when both are faulty.

- (1) Check phase A and phase B of the position feedback signal. (Disconnection alarm detected by hardware)

Signals A and \bar{A} the figure are logically complements. If a cable is disconnected, both signals A and \bar{A} are set to high. This relation between the signals is monitored using XOR (exclusive OR) to detect when disconnection occurs.

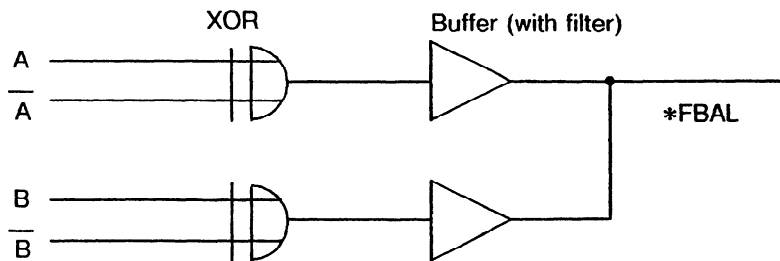

Fig. 7.3.2(a) Phase A and phase B signals of position feedback

7. TROUBLESHOOTING DIGITAL SERVO DEVICES

- (2) Check the phase C signals (C1, C2, C4 and C8) of pulse coder. (Disconnection detected by software)

Pulse coder outputs signals from two independent systems; phases A and B, and phase C. If phase C is not operating, phases A and B should not be operating either. If the phase C is operating, phases A and B should also be operating. Phase operation is monitored by software in the following way to prevent the motor from going out of control.

- Criterion for judging non-operation of the phase C :
Whether the change in the phase C signal is equal to or less than one bit
(Normally, one bit of phase C is equivalent to 1/64 revolution of the motor.)
- Criterion for judging non-operation of phases A and B :
Whether the increment signal has gone below the value P specified below.

When the phase C signal is disconnected, the motor cannot theoretically become out of control, because the phase change in the three-phase current of the motor power line is not synchronous with the rotation angle of the motor. Due to this reason, only disconnection of phases A and B (or disconnection of phases A and B of the scales, in the case of a fully-closed system) are monitored.

Checking the number of position feedback pulses returned when the motor rotates N/32 times, the servo software issues an alarm if the number is less than or equal to P. (For N and P, see the description below.)

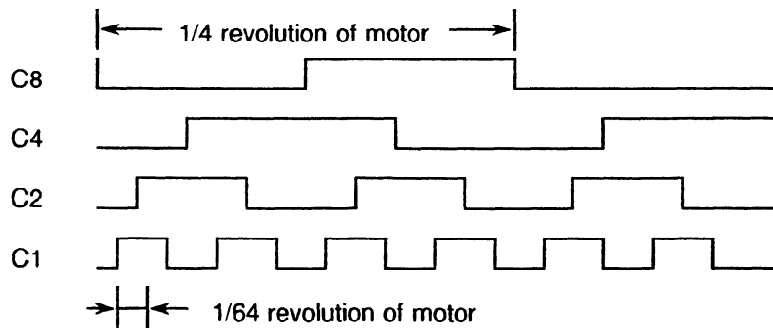

Fig. 7.3.2(b) C phase signal of the pulse coder

This function differs depending on servo ROM Series and Editions as follows. (Alarm sensitivity specified by P and N)

- | | |
|------------------|------------------------|
| (a) 9000/E and F | P = 1 (pulse) |
| 9001/B and D | N = 1 (time) |
| | |
| (b) 9000/G and H | P = 10 |
| 9001/E | For TGALRM = 0 ; N = 1 |
| | For TGALRM = 1 ; N = 4 |

7. TROUBLESHOOTING DIGITAL SERVO DEVICES

(c) 9000/J or later	P = 10
9001/F or later	For TGALRM = 0 ; N = 1
9010/F or later	For TGALRM = 1 ; N is variable as specified by parameter
9020/A or later	No. 1892 or 8X64 (initial setting = 4)
9030/A or later	
9031/A or later	
9032/A or later	

In a fully-closed system for the editions in (a) above, a disconnection alarm may occur, depending on the amount of backlash of the machine, even when the position feedback is normal. Upgrading to the editions in (b) and (c) is done to correct this.

FBAL (disconnection) alarms are classified into hardware disconnection and the software disconnection of the pulse coder (and further classified into hardware disconnection of a built-in pulse coder or of a separate pulse coder in Series 10, 11, 12 and 15). For details, see Sections 7.1 and 7.2.

[Check items]

1. Frequency of the alarm (constant or intermittent)
2. Hardware disconnection or software disconnection (See Sections 7.1 and 7.2.)
3. Semi-closed system or fully-closed system
4. Disconnection of feedback cable
5. Backlash of machine
6. Number of position feedback pulses per motor revolution

[Adjustment procedure]

- A. Check the disconnection alarm in detail. (See Sections 7.1 and 7.2.)
 - For software disconnection, go to A-1.
 - For hardware disconnection, go to B.

- A-1 Check the machine system.
 - For a fully-closed system, go to A-2.
 - For a semi-closed system, go to A-4.

- A-2 Check the NC system.
 - For any Series other than 0, go to A-3.
 - For Series 0, check the interface for the signal of the separate-type detector. (See Section 5.2.)
 - If interface is faulty, go to Cause 3.
 - If interface is correct, go to A-3.

- A-3 If backlash is excessive, lower the detection level (parameter No. 1892 or 8X64).
 - If the disconnection alarm no longer occurs, go to Cause 4.
 - If disconnection alarm still occurs, go to Cause 1.

7. TROUBLESHOOTING DIGITAL SERVO DEVICES

- A-4 Turn the motor using JOG at the lowest speed.
- If a disconnection alarm occurs for a specific location during the motor rotation, go to Cause 2.
 - If the disconnection alarm still occurs, go to A-5.

- A-5 If the number of position feedback pulses per motor revolution is 640 or less, lower the detection level (No. 1892 or 8X64).
- If the disconnection alarm no longer occurs, see Cause 9.
 - If the disconnection alarm still occurs, see Cause 1.

- B. Check the machine system.
- For a fully-closed system, go to B-1.
 - For a semi-closed system, go to B-2.

- B-1 Check for disconnection in the separate-type detector.
- If a disconnection alarm is occurring in the separate-type detector, go to Cause 5.
 - If a disconnection alarm is not occurring in the separate type detector, go to B-2.

- B-2 Exchange the motor with another on an axis that is operating normally, and operate the machine. (See the figure below.)
- If a disconnection alarm still occurs on the same axis, go to Cause 6.
 - If a disconnection alarm occurs on the axis from which the motor was taken, go to B-3.

- B-3 Replace the cable and operate the machine.
- If a disconnection alarm occurs, go to Cause 7.
 - If no disconnection alarms occur, go to Cause 8.

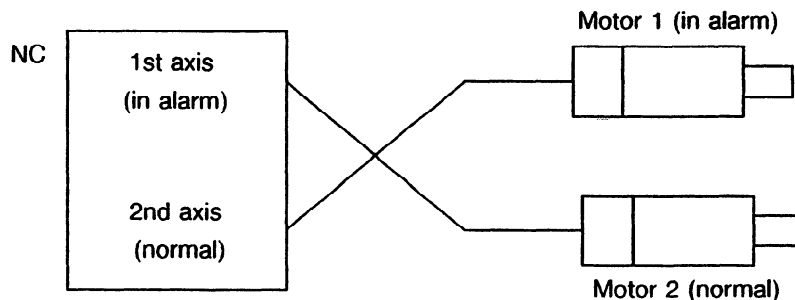

[Causes]

- (1) - Malfunction is caused because the phase C signal of the pulse coder is being affected by noise. Shield the signals from noise.
 - Cables may be incorrectly installed.
 - When the motor model is AC5-0, bit 7 of parameter No. 1806 or 8X01 may be set to 0.
- (2) There may be dust accumulated on the glass of the pulse coder or scale. In this case, disassemble the pulse coder and blow off dust.

7. TROUBLESHOOTING DIGITAL SERVO DEVICES

- (3) When a fully-closed loop is employed in Series 0, the signal from the separate-type detector may collide with the phase C signal, resulting in a disconnection alarm. It is necessary to pay close attention to the signal interface of the separate-type detector.
In practice, the phase C signal should not be connected to pins 10 to 13 on the fully-closed feedback side.
Pins 10 to 13 must be left open. (For details, see Section 5.2.)
- (4) It is possible for the machine not to work even when the motor runs. This occurs when backlash is so excessive that no position pulse is returned. In this case, the backlash of the machine must be reduced.
Or, lower the detection level of the disconnection alarm level (by setting bit 1 of parameter No. 1808 or 8X03 to 1). If backlash is too great, it may be necessary to increase the set value in parameter No. 1892 or 8X64 in addition to lowering the detection level of the disconnection alarm.
- (5) The separate-type pulse coder is not functioning or the cable is disconnected or connected incorrectly.
- (6) The PCB for the axis or master PCB is defective.
- (7) The built-in pulse coder in the motor is defective.
- (8) The cable is disconnected.
- (9) When the flexible feed gear is set so that 640 or fewer position feedback pulses are returned per motor revolution, the software disconnection alarm may be detected even if no disconnection occurs.
To prevent this, the level for detecting the disconnection alarm must be lowered by setting bit 1 of parameter No. 1808 or 8X03 to 1 and increasing the value of parameter No. 1892 or 8X64.

7. TROUBLESHOOTING DIGITAL SERVO DEVICES

7.3.3 Troubleshooting for the OVC (overload) alarm

Below is an example of the case when heat is generated by a motor.

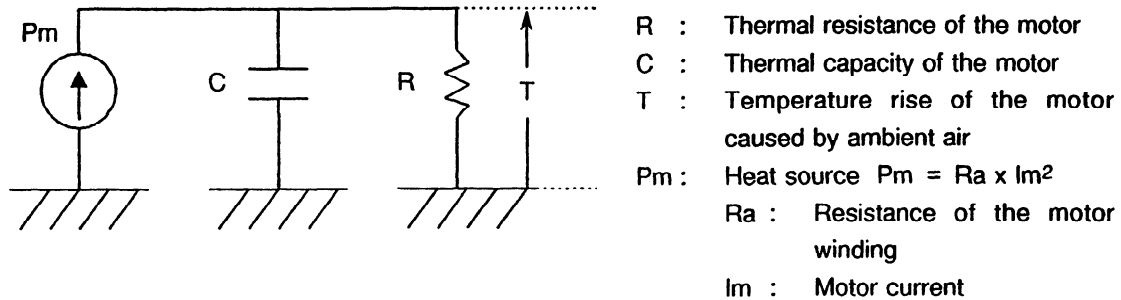

Fig. 7.3.3 (a)

In this Fig. 7.3.3(a), C and R are a constant. Because motor current I_m is always measured in the servo software, it is possible to predict the rise in temperature (T) of the motor by calculating the heat generation (P_m) of the motor.

The OVC alarm occurs due to the following two conditions.

(Condition 1)

An OVC alarm occurs if the maximum current I_p (limitation depending on the capacity of the amplifier) flows into the motor continuously for three seconds.

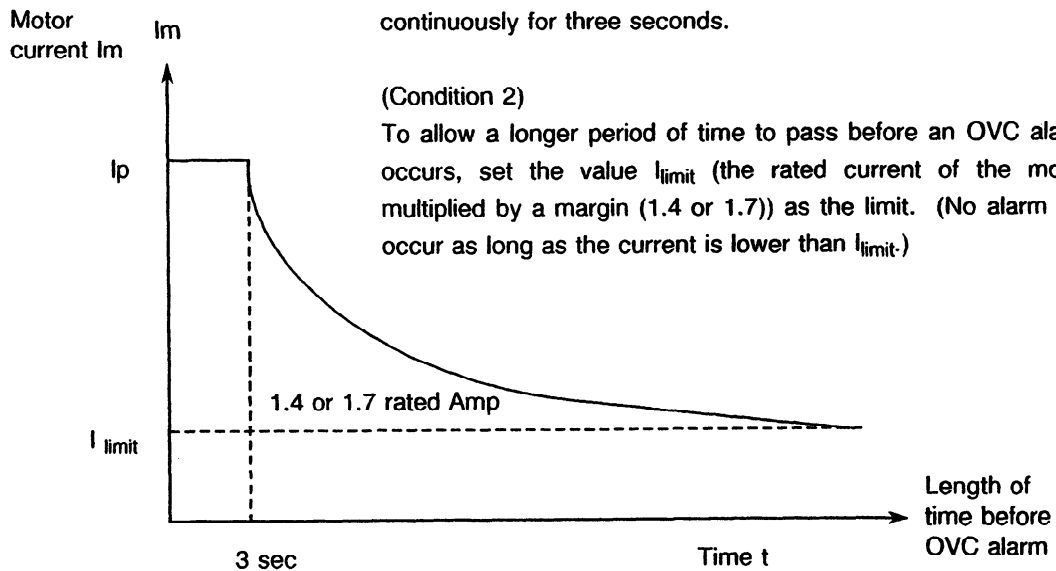

Fig. 7.3.3 (b)

The operation principle of the OVC alarm is described in 7.3.4(1) "Details of the operation principle of the OVC alarm".

7. TROUBLESHOOTING DIGITAL SERVO DEVICES

Because motor current is directly monitored for the OVC alarm, this alarm system is suitable for protecting the motor winding and transistors in the amplifier from rises in temperature within several seconds, within which the thermostat cannot function properly.

However, monitoring the rise in temperature for a long period of time may not be accurate since ambient temperature cannot be detected by the servo software. To make up for this weak point, this alarm is set in a protective harmonization with the signal from the built-in thermostat of the motor.

For details, see 7.3.4(2) "Relationship between OVC, OVL, and HC".

[Check items]

1. Waveform of IR and IS of the servo amplifier
2. Cutting conditions
3. Machine load

[Adjustment procedure]

- A. Observe the waveform of IR and IS of the servo amplifier.
- If the observed current is less than 1.4 times of the rated current of the motor, go to A-1.
 - If the observed current is 1.4 times (1.7 times for motors of 20S or larger models) or higher than the rated current of the motor, go to A-2.

A-1 Check the servo ROM Series/Edition.

- If the servo ROM Series/Version is 9000, 9001, 9002 or 9010/001A, go to Cause 2.
- Otherwise, go to Cause 6.

A-2 Calculate the torque required for acceleration and deceleration of the motor, and check if this torque is equal to the actual current.

- If equal, go to Cause 1.
- If not equal, go to A-3.

A-3 Check the servo parameters.

Check parameters PK1, PK2, EMFCMP and PVPA. For an NC of Series 0-A, 0-B, 10, 11 or 12, be sure to check parameters EMFCMP and PVPA to see if they are calculated in accordance with the number of pulses from the built-in pulse coder of the motor.

For an NC of Series 0-C or 15, check EMFCMP and PVPA to see if they are set at the standard parameter value.

- If parameters are correct, go to A-4.
- If not correct, go to Cause 3.

A-4 Replace the axis PCB or the master PCB.

- If an OVC alarm still occurs after replacement, go to Cause 4.
- If an OVC alarm does not occur after replacement, go to Cause 5.

7. TROUBLESHOOTING DIGITAL SERVO DEVICES

[Causes]

- (1) Since it is possible that load of the machine may exceed the motor capacity, the servo must be upgraded to the next higher model.
However, if an OVC alarm occurs not during the constant speed feed, but only when an acceleration/deceleration cycle is repeated, increase the acceleration/deceleration time constant.
Because the OVC alarm detection level is much higher in the digital servo than in the analog servo, it must be noted that an OVC alarm may occur in the digital servo even though it may not always occur in the analog servo in the same machine for the same operation.
- (2) For the Series/Versions covered in this manual, OVC alarms are detected by current commands. Even within the rated current, there may be a gap between the current specified by the command and the actual current in the motor while the motor is running at high speed. An OVC alarm is caused accordingly. In this case, increase the value of current loop gain parameter PK1 by 1.5 times or compensate the counter-electromotive voltage.
- (3) The servo parameters are set incorrectly.
If the values set in parameters PK1, PK2 and EMFCMP are too small, an OVC alarm may occur. If the value in PVPA is not correct, invalid current increases and an OVC alarm may occur.
- (4) The motor is defective.
- (5) The axis PCB or master PCB is defective.
- (6) Parameter settings for POVC1, POVC2 and POVCLMT for the OVC alarm are incorrect.

7.3.4 Reference data on alarms

(1) Details of the operation principle of the OVC alarm

(a) Heat generation model of the motor

The model shown in Fig. 7.3.4(a) below is used to explain the generation of heat by the motor.

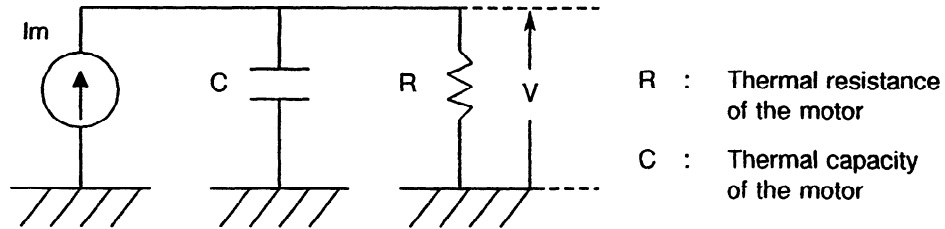

Fig. 7.3.4 (a)

Differential equation ① below applies to Fig. 7.3.4(a).

$$\frac{dV}{dt} = (-1/CR)V + (1/c)Im \dots\dots\dots ①$$

Solving differential equation ① gives the following :

$$V(t) = \exp(-t/CR)V(0) + R(1 - \exp(-t/CR))Im$$

Replacing t_s with the sampling time t_s , and $V(0)$ with $V(n)$, converts the above general equation to a specific solution.

$$V(n+1) = \exp(-t_s/CR)V(n) + R(1 - \exp(-t_s/CR))Im$$

Multiplying the solution by current Im gives the following.

$Q(n+1) = K1 \times Q(n) + K2 \times Im^2 \dots\dots\dots ②$
<p>where,</p>
$K1 = \exp(-t_s/CR) \dots\dots\dots ③$
$K2 = R(1 - \exp(-t_s/CR)) \dots\dots\dots ④$

Therefore, the heat generated by the motor can be estimated by equation ② above.

7. TROUBLESHOOTING DIGITAL SERVO DEVICES

(b) Relationship between the alarm parameters and the heat generation model

The servo software treats K1 and K2, as used in the equations ③ and ④ in (a), and Q_{limit} as fundamental motor parameters as shown in the table below.

Table 7.3.4(a) Relationship between equations and parameters

Parameter No.		Code used in the parameter table	Symbol used in the equation ②
Series 0	Series 10, 11, 12, 15		
No. 8X62	No. 1877	POVC1	K1
8X63	1878	POVC2	K2
8X65	1893	POVCLMT	Q_{limit}

In this way, motor-current I_m is detected, and the value $Q(n)$ calculated each time with equation ② is compared with the alarm level Q_{limit} . If $Q(n) \geq Q_{limit}$ is satisfied by the comparison, an alarm occurs.

In general, the relationship between the time and the current in equation ② will be as shown below.

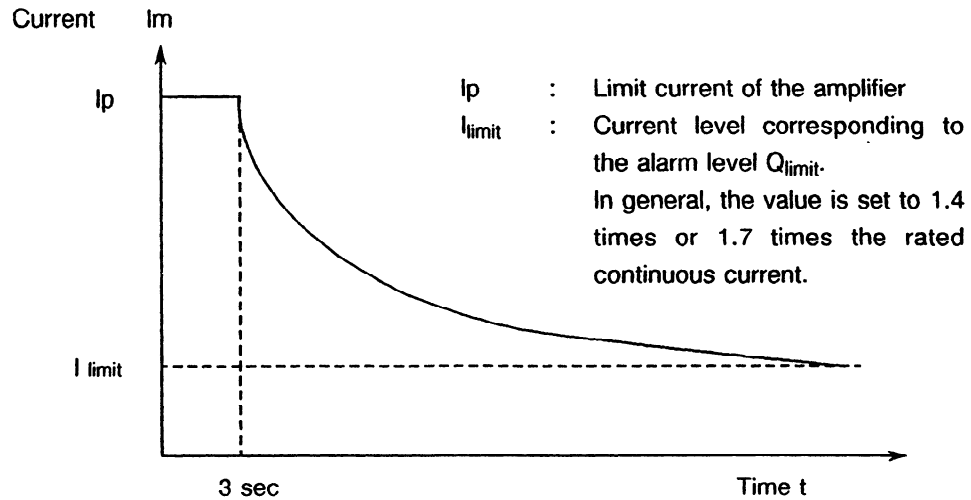

Fig. 7.3.4 (b)

7. TROUBLESHOOTING DIGITAL SERVO DEVICES

(c) The OVC parameter is calculated as follows, where

- I_{max} : Maximum current (A)
- I_r : Rated current of the motor (A)
- OVCr : OVC rated current ratio

$$BB = \left(\frac{I_{max}}{I_r \times OVCr} \right)^2$$

Table 7.3.4(b) Parameters and Formulas for Calculating the Parameters

Parameter No.		Parameter symbol	Formula for calculating the OVC parameter
Series 0	Series 10, 11, 12, 15		
No. 8X62	No. 1877	POVC1	$\exp(-0.1/3BB) \times 32767$
8X63	1878	POVC2	$409600 \times (1 - POVC1/32767)$
8X65	1893	POVCLMT	$40460/BB$

Example: For servo motor 10S, the OVC parameter is calculated as follows:

- I_{max} (Maximum current) = 40 A
- I_r (Rated current of the motor) = 10.795 A
- OVCr (OVC rated current ratio) = 1.7

$$BB = \left(\frac{I_{max}}{I_r \times OVCr} \right)^2 = \left(\frac{40}{10.795 \times 1.7} \right)^2$$

- POVC1 = $\exp(-0.1/3BB) \times 32767$ = 32539
- POVC2 = $409600 \times (1 - POVC1/32767)$ = 2864
- POVCLMT = $40460/BB$ = 8515

7. TROUBLESHOOTING DIGITAL SERVO DEVICES

(d) Motor models and OVC alarm levels

Motor model	5-0	4-0	3-0	2-0	1-0	0	5	10	20/1500
Motor drawing No.	0531	0532	0533	0521	0522	0513	0512	0501	0505
OVC rated current ratio	1.4	1.4	1.4	1.4	1.4	1.4	1.4	1.7	1.4

Motor model	20	30	30/2000
Motor drawing No.	0502	0503	0506
OVC rated current ratio	1.7	1.7	1.7

(S Series)

Motor model	4-0S	3-0S	2-0S	2-0S	1-0S	0S	5S	6S	10S
Motor drawing No.	0532	0533	0311	0310	0312	0313	0314	0316	0315
OVC rated current ratio	1.4	1.4	1.4	1.4	1.4	1.4	1.4	1.7	1.7

Motor model	20S/1500	20S	30S	30/2000	40
Motor drawing No.	0505	0502	0590	0506	0581
OVC rated current ratio	1.4	1.7	1.7	1.7	1.4

Motor model	0-0SP	2-0S/3000	1-0S/3000	0S/3000	5S/3000	6S/3000
Motor drawing No.	0.374	0310	0309	0313	0514	0320
OVC rated current ratio	1.4	1.4	1.4	1.4	1.4	1.4

Motor model	10S/3000	20S/3000	30S/3000	40S/2000	50S	60S	70S
Motor drawing No.	0317	0318	0319	0583	0331	0332	0333
OVC rated current ratio	1.4	1.4	1.4	1.4	1.4	1.4	1.4

7. TROUBLESHOOTING DIGITAL SERVO DEVICES

(L Series)

Motor model	0L	5L	6L	6L	7L	10L	7LM
Motor drawing No.	0561	0562	0563	0564	0571	0572	0573
Motor type	56	57	17	58	59	60	20
OVC rated current ratio	1.4	1.4	1.4	1.4	1.4	1.4	1.4

Motor model	0L(3000)	5L(3000)	6L(3000)	7L(3000)
Motor drawing No.	0561	0562	0564	0571
Motor type	68	69	70	71
OVC rated current ratio	1.4	1.4	1.4	1.4

(T Series)

Motor model	0T/3000	5T/2000	5T/3000	10T/2000	10T/3000
Motor drawing No.	0381	0382	0383	0384	0385
OVC rated current ratio	1.4	1.4	1.4	1.4	1.4

(2) "Relation between OVC/OVL/HC".

This item explains the purpose of the OVC alarm, OVL alarm and HC alarm, and describes the differences between them.

Table 7.3.4 (b) OVC/OVL/HC alarms

Code	Meaning	Meaning	Detector
OVC	Over Current	Overcurrent alarm	Servo software
OVL	Over Load	Overload alarm	The rmal switch built into the motor Thermal switch built into the amplifier Thermal switch of the separate regenerative discharge unit
HC	Abnormal Current	Abnormal current alarm	Servo amplifier

(a) HC alarm (abnormal current alarm)

The power transistor or rectifier diode is likely to fail, or the intensity of the motor magnet field is likely to drop when the power transistor is subjected to a high surge in current due to noise or malfunctioning of the control circuit.

This alarm is used to prevent this from occurring.

7. TROUBLESHOOTING DIGITAL SERVO DEVICES

(b) OVC and OVL alarms (Overcurrent and overload alarms)

These alarms prevent the motor winding from burning out, and the transistors in the amplifier and the separate regenerative discharge resistor from being damaged due to overheating.

The OVL alarm is designed to occur when a specific temperature is detected by the thermal unit built into each unit. This alarm alone, however, cannot completely prevent the motor from burning out or the transistor or the regenerative discharge resistor from being damaged due to overheating.

For example, consider the case when the motor is started and stopped very frequently. The thermal time constants for the motor and the thermal unit differ depending on the differences in their material, structure and dimensions. In general, the thermal time constant of the motor is larger because its weight is greater.

In the case that the motor is started and stopped very frequently as shown in Fig. 7.3.4(c), the temperature rise of the motor will exceed that of the thermal unit. The thermal unit does not detect this change in temperature, resulting in the motor burning out.

To make up for the above weak point, the OVC alarm continuously monitors the motor current, with the aid of the software, to estimate motor temperature. Using this method, the motor temperature can be estimated fairly accurately, eliminating the problem occurring from frequent starting and stopping.

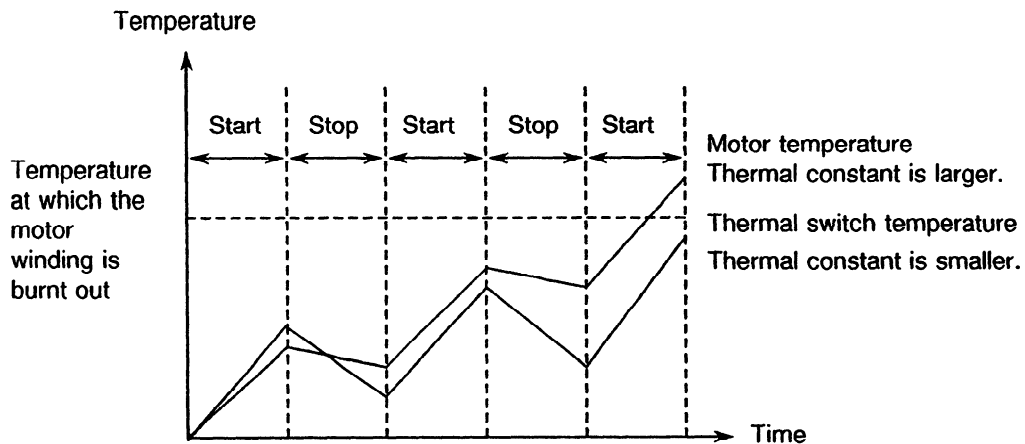

Fig. 7.3.4(c) Relationship between the motor temperature and the thermal unit temperature in repeated start/stop cycles

In summary, double protection against overcurrent is provided; the OVC alarm provides short-term protection and the OVL alarm provides long-term protection. This relationship is shown in Fig. 7.3.4(d).

7. TROUBLESHOOTING DIGITAL SERVO DEVICES

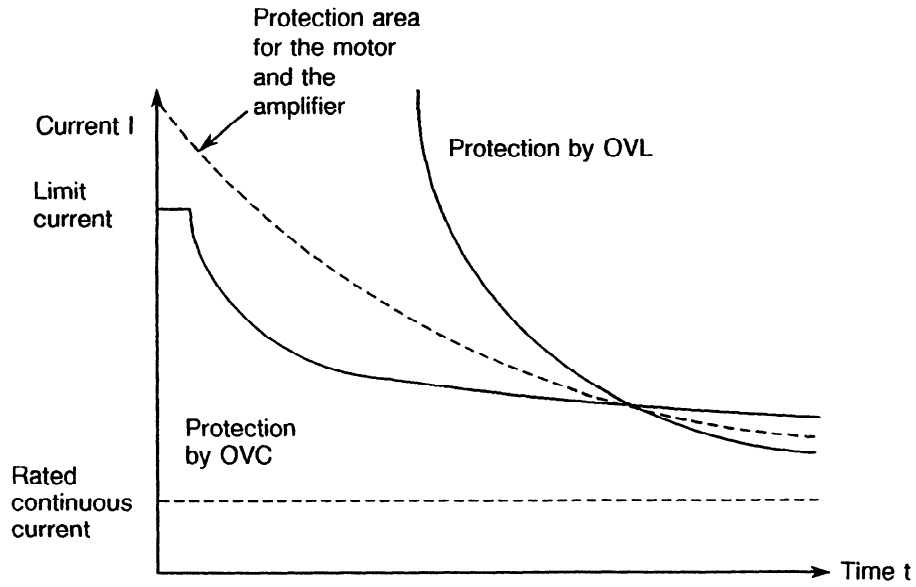

Fig. 7.3.4(d) Relationship between the OVC and OVL alarms

(Note) The OVC alarm has been set based on the relationship shown in Fig. 7.3.4(d) above. Therefore, the level of protection should not be reduced by changing the parameters even if an alarm is caused when the motor is not overheating.

7. TROUBLESHOOTING DIGITAL SERVO DEVICES

7.4 Alarms Detected in the Servo Amplifier

The servo amplifier detects alarms with the alarm codes that correspond to the following bits.

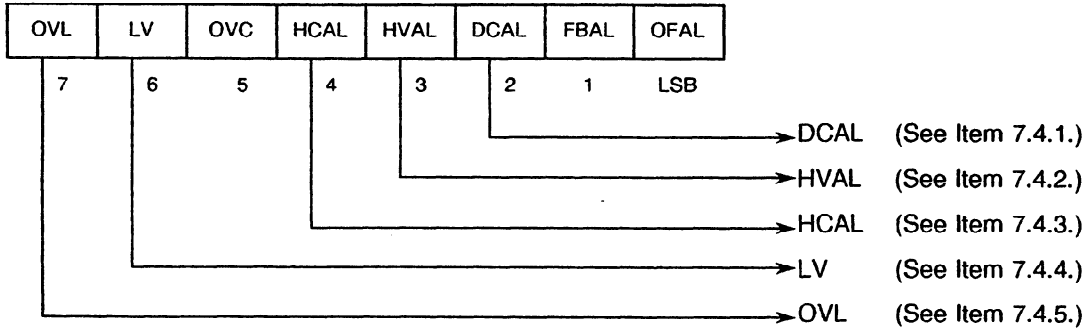

The alarm codes above correspond to the alarm displays of the servo amplifier shown below.

Alarm code	Alarm displays of the servo amplifier	
	S series servo amplifier	C series servo amplifier
DCAL	DC alarm (indicated by LED)	DCSW and DCOH alarms (indicated by LEDs 4 and 5)
HVAL	HV alarm (indicated by LED)	HV alarm (indicated by LED 1)
HCAL	HC, HCL, HCM and HCN alarms (indicated by LEDs)	HCL, HCM and HCLM alarms (indicated by LEDs 8, 9 and b)
LV	LV alarm (indicated by LED)	LV5V and LVDC alarms (indicated by LEDs 2 and 3)
OH	OH alarm (indicated by LED)	OH (indicated by LED 6)
MCCALM (Note 1)	Not applicable to S series	MCC (indicated by LED 7)
None (Note 2)	FAL, and circuit breaker tripped	Circuit breaker tripped

(Note 1) Because the alarm code MCCALM is stored in the expanded alarm code area, it is not applicable to all servo applications. See Chapter III-4 for details.

In the case of a conventional servo application which does not use the MCCALM bit, both the LV bit and DCAL bit are set to 1 simultaneously when an MCC alarm is caused.

In the case of a C series servo amplifier, it must be noted that an MCC alarm may occur when a LV alarm and a DCAL alarm are displayed on the alarm message screen of the NC at the same time.

(Note 2) When the circuit breaker is tripped, no alarm code is issued. (Although an LV alarm may occur incidentally.)

7. TROUBLESHOOTING DIGITAL SERVO DEVICES

7.4.1 Troubleshooting for the DCAI alarm

[Check items]

1. Setting S2 for the S series
2. Machine load
3. Check according to Section 4.7, Connection of Separate Discharge Unit.

[Adjustment procedure]

- A. Check amplifier setting S2.
- If the setting is incorrect, go to Cause 1.
 - If the setting is correct, go to A-0.
- A-0 Check whether a separate discharge unit is being used.
- If it is being used, go to A-1.
 - If not being used, go to A-2.
- A-1 Check the connection of the separate discharge unit.
- If connection is incorrect, go to Cause 2.
 - If connection is correct, go to A-2.
- A-2 Check the acceleration/deceleration frequency.
- If the frequency is too high, go to Cause 3.
 - If the frequency is low enough, go to A-3.
- A-3 Replace the servo amplifier.
- If a DCAL alarm no longer occurs, go to Cause 4.
 - If a DCAL alarm still occurs, go to Cause 3.

[Causes]

- (1) If the setting S2 of the S series servo amplifier is incorrect, a DC alarm is caused.
- (2) If the separate discharge unit is connected incorrectly, a DC alarm occurs.
- (3) Compared to the regenerative power of the amplifier, the regenerative energy of the motor is too large. (The inertia is too large or the acceleration/deceleration frequency is too high.) In this case, try to decrease the acceleration/ deceleration frequency or install a separate discharge unit.
- (4) The discharge transistor (Q1) in the servo amplifier is defective.

[Note]

DCAL alarm in the C series servo amplifier

The DCAL alarm code (code indicating discharge circuit alarm) in the conventional S series servo amplifier represents two alarms in the C series servo amplifier; the DCSW alarm and DCOH alarm.

7. TROUBLESHOOTING DIGITAL SERVO DEVICES

- (1) The DCSW alarm occurs when the discharge transistor is on continuously for one second or longer.

[Causes]

- ⊙ The discharge circuit of the amplifier is defective.
→ Replace the amplifier.

- ⊙ Too much energy is produced in a short period of time (about one second).
→ Increase the time constant, decrease the frequency of motor acceleration/ deceleration, lower the motor maximum speed, or lower the inertia load.

- (2) The DCOH alarm is caused when the regenerative resistor overheats and is sensed by the thermostat.

When the thermostat of the power transformer for the servo system is connected to terminals 15 and 16 of the C-series servo amplifier, the transformer overheating may cause the DCOH alarm.

[Causes]

- ⊙ Average regenerative energy is excessive. This alarm occurs when the acceleration/ deceleration frequency is high or regenerative energy of the vertical axis is large.
→ Relax the operating conditions.

- ⊙ The thermostat is incorrectly wired or is defective.
→ When a separate discharge unit or power transformer for the servo controller is used, check the wiring for the thermostat according to the description manual.

7. TROUBLESHOOTING DIGITAL SERVO DEVICES

7.4.2 Troubleshooting for the HVAL alarm

[Check items]

1. Three-phase input voltage
2. Machine load
3. Connection of a separated regenerative discharge unit

[Adjustment procedure]

- A. Check the three-phase input voltage to the amplifier.
 - If the voltage is higher than 1.1 times the rated voltage, go to Cause 1.
 - If the voltage is equal to or less than 1.1 times the rated voltage, go to A-1.
- A-1 Check the parameter for the acceleration/deceleration time constant.
 - If the parameter value is too small, go to Cause 2.
 - If the parameter value is large enough, go to A-2.
- A-2 Check according to Section 4.7, Connection of Separate Discharge Unit.
 - If connection is incorrect, go to Cause 3.
 - If connection is correct, go to A-3.
- A-3 Check the resistance of the built-in regenerative resistor of the amplifier or that of the separate discharge unit; see Section 4.8, Types of Separate Discharge Units.
 - If resistance is incorrect, go to Cause 4.
 - If resistance is correct, go to A-4.
- A-4 Replace the servo amplifier.
 - If an HVAL alarm no longer occurs, go to Cause 5.
 - If an HVAL alarm still occurs, go to Cause 6.

[Causes]

- (1) When the machine is accelerated or decelerated rapidly when the three-phase input voltage to the amplifier is higher than 1.1 times the rated voltage, an HVAL alarm may occur. In this case, lower the three-phase input voltage within the rated voltage.
- (2) When the acceleration/deceleration time constant is not appropriate for the machine load, an HVAL alarm may occur even if the three-phase input voltage is within the rated voltage. In this case, further increase the acceleration/deceleration time constant.
- (3) When the separate discharge unit is connected incorrectly, an HVAL alarm may occur.
- (4) Because the specification of the motor and amplifier is not appropriate for the machine load, the discharge resistor may be damaged. Or, the resistor may have been defective from the beginning.
- (5) The servo amplifier may not be functioning.

7. TROUBLESHOOTING DIGITAL SERVO DEVICES

- (6) Specifications for the motor and amplifier are not appropriate for the machine load.

7.4.3 Troubleshooting for the HCAL alarm

[Check items]

- 1 Conditions in which an HCAI alarm occurs (before excitation, at the instance of excitation, during excitation or rotation, at acceleration, or at deceleration)
- 2 Whether the module board is correctly inserted in the case of the C series
- 3 Power lines
- 4 Insulation of the motor windings
- 5 Parameter settings (motor model, variations from the standard parameters, and NC parameters)
- 6 Remove the PCB from the servo amplifier and check the transistor module.
7. Waveform of IR and IS of the amplifier

[Adjustment procedure]

- A. Check the parameters.
- If the current loop gain (in the parameters PK1 and PK2) is several times larger than the standard value, go to Cause 1.
 - If Series 15 or 0-C (32 bit) is used and parameter No. 1809 or 8X04 is set to a conventional value, see Cause 9.
 - If the parameter settings are correct, go to A-1.

A-1 The transistor module must be checked even after the cause is determined in the following adjustment. (The adjustment may cause a defect in the transistor module.)

- A-1-1 Remove the power lines from the amplifier terminals and check the continuity between GND and each of U, V, and W.
- If either pair is connected, go to A-1-1-1.
 - If all pairs are disconnected, go to A-1-1-2.

- A-1-1-1 Remove the power lines from the motor terminals and check the continuity between GND and each of U, V, and W.
- If either pair is connected, see Cause 3.
 - If all pairs are disconnected, see Cause 4.

- A-1-1-2 Remove the power lines from the amplifier terminals and check the resistance between U and V, V and W, and W and U using an instrument that can measure minute resistances.
- If the three resistances are equal, the power lines and the motor have no defects.
 - If the three resistances are different, go to A-1-1-2-1.

7. TROUBLESHOOTING DIGITAL SERVO DEVICES

A-1-1-2-1 Remove the power lines from the motor terminals and check the resistance between U and V, V and W, and W and U using an instrument that can measure minute resistances.

- If the three resistances are equal, see Cause 4.
- If the three resistances are different, see Cause 3.

A-2 Check the transistor module of the servo amplifier.

- If the transistor module is not defective, go to A-3.
- If the transistor module is defective, see Cause 5.

A-3 Replace the control PC board of the amplifier and turn the power on.

- If no alarm occurs, see Cause 6.
- If an alarm occurs, go to A-4.

(Note) For a C-series amplifier, replace the amplifier.

A-4 Check the shielded ground.

- If the ground is not provided, see Cause 2.
- If the ground is provided, go to A-5.

A-5 Replace the master PCB.

- If an HCAL alarm no longer occurs, go to Cause 7.
- If an HCAL alarm still occurs, go to Cause 8.

[Causes]

- (1) Because the current loop gain is too high, the current loop oscillates and an alarm occurs. When adjusting, the maximum allowable current loop gain is about double the standard value.
- (2) Check IR and IS of the amplifier. If shield grounding is not provided, the feedback current contains noise which may cause an HCAL alarm.
- (3) The motor is defective.
- (4) The power line to the motor is defective.
- (5) The transistor module of the servo amplifier is defective.
- (6) The control PC board of the servo amplifier is defective.
- (7) The master PCB is defective.
- (8) The pulse coder may be defective.
- (9) The parameter setting in Series 0-C and 15 is different from that in Series 0 (16 bit), 10, 11, and 12. A wrong parameter may result in a wrong current. The values selected in servo parameter initialization must be used. For details, see Subsection 1.3.1.4 in Part II.

7. TROUBLESHOOTING DIGITAL SERVO DEVICES

7.4.4 Troubleshooting for the LV alarm

[Check items]

1. Three-phase input voltage
2. Type of servo amplifier
3. In the C series servo amplifier, an LV alarm may occur if the contact of magnetic contactor is welded (indicated by LED 7).

[Adjustment procedure]

- A. Check the three-phase input voltage to the amplifier.
 - If the voltage is lower than 0.85 times the rated voltage, go to Cause 1.
 - If the voltage is equal to or higher than 0.85 times the rated voltage, go to A-1.
- A-1 Replace the servo amplifier.
 - If an LV alarm no longer occurs, go to Cause 2.

[Causes]

- (1) The three-phase input voltage needs to be adjusted to within FANUC specifications.
- (2) The servo amplifier is not functioning.

[Note]

In the C series servo amplifier, the LV alarm issued as the alarm code is the logical sum of LV5V alarm and LVDC alarm. The LV5V alarm is equivalent to the LV alarm used in the conventional S series servo amplifier. The LVDC alarm is the newly added alarm described below.

(LVDC alarm)

This alarm occurs when the DC voltage in the main power supply is lower than the specified level even though the built-in magnetic contactor in the amplifier is on.

Causes:

- ⊙ Input voltage is insufficient.
 - Check whether three-phase 170 VAC or higher is being input.
- ⊙ The amplifier is not functioning (built-in magnetic contactor is defective).
 - Replace the amplifier.
- ⊙ If a circuit breaker trips, an LVDC alarm will occur incidentally.

7. TROUBLESHOOTING DIGITAL SERVO DEVICES

7.4.5 Troubleshooting for the OVL alarm

[Check items]

1. Overheating of the motor (MOH) or amplifier (OH)
2. Servo amplifier settings
3. Cutting conditions and machine load

[Adjustment procedure]

- A. Check the overload alarm in detail.
 - If the motor is overheating, go to B.
 - If the amplifier is overheating (indicated by the red LED OH on the amplifier, or alarm display 6 for the C series), go to A-1.
- A-1 Check the servo amplifier S1 setting. (No setting is provided in the C series servo amplifier.)
 - If the setting is incorrect, go to Cause 1.
 - If the setting is correct, go to A-2.
- A-2 Check the heat sink. (Be careful, because the heat sink may be hot.)
 - If it has overheated, see Causes 2 and 9.
 - If it has overheated, go to A-3.
- A-3 Check the thermostat of the servo amplifier (after letting it fully cool down).
 - If the continuity is broken, see Cause 4.
 - If it has continuity, go to A-4.
- A-4 Check whether a separate regenerative discharge unit or power transformer is used.
 - If either of them is used, go to A-5.
 - If neither of them is used, see Cause 5.
- A-5 Check the separate regenerative discharge unit or power transformer.
 - If the separate regenerative discharge unit has overheated, see Cause 3.
 - If the power transformer has overheated, see Causes 2, 7, and 9.
 - If neither of them has overheated, go to A-6.
- A-6 Check the continuity of the thermal switch of the separate regenerative discharge unit or power transformer (some time after the alarm has occurred).
 - If the continuity is broken, see Cause 6.
 - If it has continuity, see Cause 5.

7. TROUBLESHOOTING DIGITAL SERVO DEVICES

- B. While the motor is overheating (the surface temperature of the motor may be around 100 C), remove the feedback connector cable from the motor and check the continuity between R-S (for incremental pulse coder) or between R-S (for absolute high-resolution pulse coder) of the Canon connector.

While the motor is overheating (motor is hot) :

- If they have no continuity, the motor has actually overheated.
- If they have continuity, go to Cause 10.

After the motor has completely cooled down :

- If they have no continuity, go to Cause 8.
- If they have continuity, the motor is normal.

[Causes]

- (1) If the S1 setting is incorrect, the amplifier gets overheated by just turning on the power. Check according to Section 4.7, Connecting a Separate Discharge Unit.
- (2) The thermal regenerative capacity is insufficient for the cutting condition and machine load.
- (3) The regenerative discharge transistor (Q1) of the servo amplifier is defective.
- (4) The thermostat of the servo amplifier is defective.
- (5) The alarm detector circuit of the PCB of the servo amplifier is not functioning.
- (6) The thermostat of the separate regenerative discharge unit or power transformer is defective.
- (7) The power capacity of the transformer may be insufficient. A different transformer may need to be selected.
- (8) The thermostat of the motor is defective.
- (9) The cutting condition and machine load exceed the specifications of the amplifier or motor. A different servo needs to be selected.
- (10) The OH signal line of the motor feedback cable is normal. It is likely that the OH signal process circuit on the NC is faulty or that the alarm indication is incorrect.

7. TROUBLESHOOTING DIGITAL SERVO DEVICES

[Note]

The detector for the OH alarm has been changed for the C series servo amplifier.

In the S series, the OH alarm was used to monitor overheating of the servo amplifier, power transformer and separate discharge unit. In the C series servo amplifier, however, the OH alarm is used only to monitor heat generation (heat sink) of the servo amplifier. Monitoring of the power transformer and separate discharge unit is covered by the DCOH alarm.

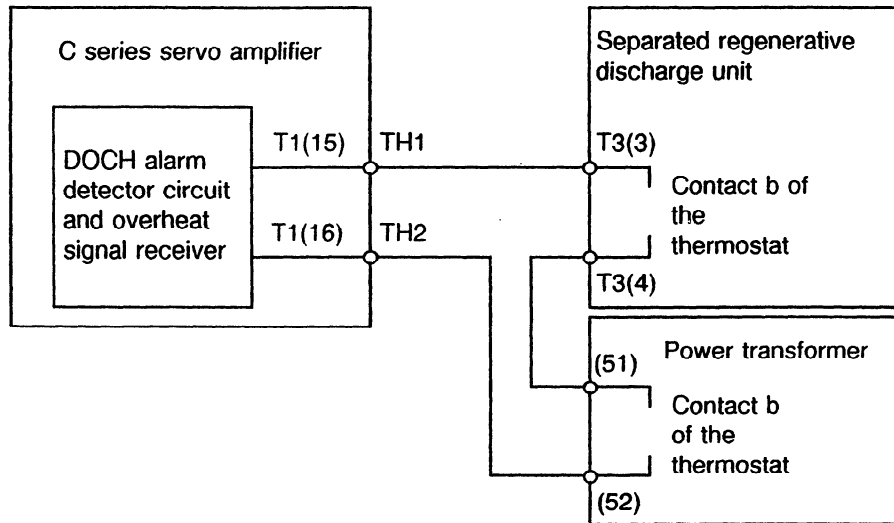

Fig. 7.4.5 Example of connection of the separate discharge unit and the power transformer

7.4.6 Troubleshooting for the MCC alarm

The MCC alarm has been added to the C series servo amplifier and later series. It is used for detecting contact welding of the built-in magnetic contactor of the amplifier.

If the contact of the magnetic contactor is already closed when the contactor is turned on, this alarm circuit regards the contact as welded and an MCC alarm occurs. Actual detection of welded contacts will begin the next time the magnetic contactor is turned on.

For NCs which do not have the MCC alarm function, the LV alarm and DCAL alarm are displayed at the same time. (For detailed indications of the MCC alarm, see Chapter III-4.)

7. TROUBLESHOOTING DIGITAL SERVO DEVICES

7.5 Servo-Related Alarms Detected by the NC

In general, refer to the NC manuals for servo-related alarms detected by the NC.

The following lists the servo-related alarms that are closely related to the digital servo. (These alarms are not included in the servo alarm codes described before.)

Subsection	Description
7.5.1	Alarm for incorrect servo parameter setting
7.5.2	Excessive position deviation
7.5.3	APC alarm
7.5.4	Alarm related to serial pulse coder A and B

7.5.1 Alarm for incorrect servo parameter setting

(4X7 INCORRECT SETTING OF SERVO PARAMETERS: Series 0)

(SV27 ILLEGAL DIGITAL SERVO PARAMETER: Series 15, 10, 11, and 12)

[Check items]

1. Parameter setting
(Motor model, variation from the standard parameters, and NC parameters)
2. Pulse coder type and system (high-resolution or normal, equipped with or without serial pulse coder)
3. NC model

[Adjustment procedure]

A-1 Check whether the motor number set in the motor model parameter is within the setting range (No. 1874 or No. 8X20). (Depending on the servo ROM version and series, the setting range for the motor number is different. For details, see Subsection 3.4.5.)

- If set correctly, go to A-2.
- If not set correctly, go to Cause 1.

A-2 Check whether values set in the parameters for the rotation direction of the motor (No. 1879 or No. 8X22), for the speed feedback pulse count (No. 1876 or No. 8X23), and for the positional feedback pulse count (No. 1891 or No. 8X24) are correct.

- If set correctly, go to A-3.
- If not set correctly, go to Cause 2.

7. TROUBLESHOOTING DIGITAL SERVO DEVICES

- A-3 Check whether the parameter setting for POA1 (No. 1859 or No. 8X47) satisfies the following inequality. (Np is the pulse count of the pulse coder.)

$$32767 \geq \text{POA1} \times \frac{N_p}{2000} \times \frac{1}{(1 + \text{LDINT}/256)}$$

- If the setting satisfies the inequality, go to A-4.
- If the setting does not satisfy the inequality, change the setting to POA1 = 0 and go to Cause 3.

- A-4 Check the model of the NC.

- If it is Series 15, go to A-5.
- If it is Series 0, check axis selection parameters No. 269-274.
 - If set correctly, go to A-5.
 - If not set correctly, go to Cause 2.

- A-5 Check the type of the pulse coder and system.

- If it is a serial pulse coder with a semi-closed system, go to A-7.
- If it is a standard (including high-resolution) pulse coder (of any system) or a serial pulse coder with a closed system, check whether the following inequality is satisfied.

$$32767 \geq 655 \times \frac{\text{PG (No. 1825, 517)}}{2000} \times \frac{\text{No. 1876, 8X23}}{\text{No. 1891, 8X24}} \times \frac{4}{\text{DMR}}$$

- If inequality is satisfied, go to A-6.
- If inequality is not satisfied, go to Cause 4.

- A-6 Check whether a flexible feed gear is used.

- If not used, go to A-9.
- If used, check whether the following inequality is satisfied:

$$\frac{\text{No. 1977, 8X84}}{\text{No. 1978, 8X85}} \geq 655 \times \frac{\text{PG}}{2000} \times \frac{\text{No. 1876, 8X23}}{\text{No. 1891, 8X24}} \times \frac{4}{\text{DMR}} \times \frac{1}{32767}$$

- If inequality is satisfied, go to A-9.
- If inequality is not satisfied, go to Cause 4.

7. TROUBLESHOOTING DIGITAL SERVO DEVICES

A-7 In the case of a serial pulse coder with a semi-closed system, check whether a flexible feed gear is being used.

- If used, go to A-8.
- If not used, go to Cause 5.

A-8 In the case of a serial pulse coder with a semi-closed system, check whether the setting for the flexible feed gear satisfies the following inequality.

$$1 \geq \frac{\text{No. 1977, 8X84}}{\text{No. 1978, 8X85}} \geq 655 \times \frac{\text{PG}}{2000} \times \frac{\text{No. 1876, 8X23}}{\text{No. 1891, 8X24}} \times \frac{1}{10} \times \frac{1}{32767}$$

- If inequality is satisfied, go to A-9.
- If inequality is not satisfied, go to Cause 4.

A-9 If the control employs the minimum detection unit of 0.1 μm , check whether the high resolution bit (bit 7 of No. 1804 or No. 37) and the optional parameter for 0.1- μm control are set.

- If both are set, go to A-10.
- If one is not set, go to Cause 6.

A-10 Set the parameters again.

Set the parameters while the NC is in emergency stop mode. Make sure to turn on the power again carefully.

[Causes]

- (1) If the motor model parameter is set to a motor number out of the setting range, an alarm occurs.
- (2) If incorrect values are set in these parameters, an alarm occurs.
- (3) If this inequality is not satisfied, an alarm occurs. In this case, change the setting to POA1 = 0. (After this change, however, the observer function will no longer be available.)
- (4) If this inequality is not satisfied, calculation of PG overflows and an alarm occurs. This alarm is likely to occur when position detection is controlled with an accuracy of 1 μm and speed detection is controlled with an accuracy of 0.1 μm in a fully-closed system. If this occurs, use the function for enlarging the position gain setting range described in Subsection 7.5.2.
- (5) When a serial pulse coder is used in a semi-closed system, the parameter for the flexible feed gear must be set.
- (6) If these parameters are not set for control with a minimum detection unit of 0.1 μm , an alarm occurs.

7. TROUBLESHOOTING DIGITAL SERVO DEVICES

(Remark)

A specific cause of the alarm for incorrect parameter setting can be determined by checking the following addresses.

[Series 0]

When 4X7 XAXIS DGTL SERVO PARAM is displayed on the NC screen, set bit 4 of parameter No. 64 to 1. Then check parameters No. 88A9 to 88AC on the DGN screen.

	bit 7	bit 6	bit 5	bit 4	bit 3	bit 2	bit 1	bit 0
No. 88A9 to 88AC		AXIS	OVF	8X22	8X24	8X23		8X20

When bit 0 is set to 1: Parameter No. 8X20 is invalid.

Bit 1

When bit 2 is set to 1: Parameter No. 8X23 is invalid.

When bit 3 is set to 1: Parameter No. 8X24 is invalid.

When bit 4 is set to 1: Parameter No. 8X22 is invalid.

When bit 5 is set to 1: An overflow occurred while calculating the parameter.

Check the parameter value and bit 0 of parameter No. 8X00.

When bit 6 is set to 1: The axis selection parameter is invalid.

Bit 7

If all parameters described above are set to 0, check bit 4 of alarm 4 on the servo adjustment screen.

Bit 4 is set to 1 when either of the following occurs:

- Parameter No. 8X84 or 8X85 is set to 0.
- The velocity loop period is 2 ms (bit 1 of parameter No. 8X04 is set to 0). (Only for a serial pulse coder)
- The flexible feed gear is defective (parameter Nos. 8X84 and 8X85). Alternatively, the values of parameter Nos. 8X23 and 8X24 are invalid.

[Series 15]

When SV027 ILL DGTL SERVO PARAMETER is displayed on the NC screen, check bit 4 of alarm 4 on the servo adjustment screen.

Bit 4 is set to 1 when either of the following occurs:

- Parameter No. 1977 or 1978 is 0.
- The velocity loop period of the serial pulse coder is 2 ms (bit 1 of parameter No. 1809 is set to 0).
- The flexible feed gear is defective (parameter Nos. 1977 and 1978). Alternatively, the values of parameter Nos. 1876 and 1891 are invalid.

Bit 4 is set to 0 when either of the following occurs:

- Parameter No. 1874 is invalid.
- Parameter No. 1876 is set to zero.

7. TROUBLESHOOTING DIGITAL SERVO DEVICES

- Parameter No. 1891 is set to zero.
- Parameter No. 1879 is invalid.
- An overflow has occurred during calculation of the parameter. Check the parameter value and bit 0 of parameter No. 1804.

7.5.2 Function for enlarging the position gain setting range

When a great difference is found between the number of velocity feedback pulses and the number of position feedback pulses, the position gain may overflow. If the overflow occurs, the alarm for incorrect servo parameter setting is raised.

PS4X7 SERVO ALARM AXIS DGTL PARAM (Series 0)
 SV27 ILL DGTL SERVO PARAMETER (Series 15)
 4X7 AXIS DGTL PARAM (Series 16, 18, Power Mate-MODEL C)

The function for enlarging the position gain setting range can prevent the overflow in the position gain.

(1) Series and editions of applicable servo ROM

- Series 9030, edition O and later
- Series 9031, edition H and later
- Series 9040, edition D and later
- Series 9050, edition B and later (The parameter setting with series 9050 is different from that with other series.)

(2) Parameter setting

Series 0-C	Series 15	Setting	
No. 8X11	No. 1955	bit 5 = 1	The function for enlarging the position gain setting range is validated. Number of position feedback pulses
No. 8X24	No. 1891	Conventional value × 8	

Series 16, 18	Setting	
No. 2000	bit 4 = 1	The function for enlarging the position gain setting range is validated.

With the servo ROM of series 9050, only the bit above needs to be validated.

(3) Sample setting

1-OSP/10000P, reduction ratio of 1/20, ball screw of 10 mm/rev, 1- μ scale, position gain of 30

The number of velocity feedback pulses per motor revolution, N_v , is: $10000 \times 4 = 40000$

The number of position feedback pulses per motor revolution, N_p , is: $10 \times 1000/20 = 500$

$655 \times 30/20 \times 40000/500 = 78600 > 32767$

The position gain overflows.

7. TROUBLESHOOTING DIGITAL SERVO DEVICES

To prevent the overflow, set the parameters as follows:

Series 0-C	Series 15	
No. 8X10	No. 1954	bit 0 = 1 : Bit for a 10000-pulse pulse coder
No. 8X11	No. 1955	bit 5 = 1 : Bit for enlarging the position gain setting range
No. 8X23	No. 1876	10000 : Number of velocity feedback pulses
No. 8X24	No. 1891	1000 : Number of position feedback pulses (500/4 × 8)

7.5.3 Excessive positional deviation

[Check items]

1. Parameter settings and the nameplate on the amplifier (motor model, variation from the standard parameters, and NC parameters)
2. Type of pulse coder (standard or serial)
3. Connections of the command cable and feedback cable
4. Three-phase input voltage to the servo amplifier
5. DGN positioning error pulses
6. TCMD waveform during acceleration

[Adjustment procedure]

- A. If a serial pulse coder is causing a motor alarm, check the setting of AMR. (Setting is different from that for a standard pulse coder.)
 - If setting is correct, go to A-1.
 - If setting is incorrect, go to Cause 1.
- A-1 Check whether an excessive deviation alarm occurs at the time when the machine is stopped or moving.
 - If alarm occurs during motion, go to A-2.
 - If alarm occurs in stop mode, go to B.
- A-2 Check whether the torque command is saturated during acceleration.
 - If it is not saturated, go to A-6.
 - If it is saturated, go to A-3.
- A-3 Check the setting of the current loop gain in the servo parameter, and also check whether the speed-dependent current loop gain, back electromotive voltage compensation and phase-lead compensation are set in accordance with the pulse count of the built-in pulse coder.
 - If settings are correct, go to A-4.
 - If settings are incorrect, go to Cause 2.
- A-4 Check the torque commands are the same for the two directions of the motor rotation when the machine is fed at a constant speed.
 - If different, go to A-5.
 - If the same, go to Cause 3.

7. TROUBLESHOOTING DIGITAL SERVO DEVICES

- A-5 Check the axis.
- If horizontal, go to Cause 4.
 - If vertical or slanted, go to Cause 3.
- A-6 Check the parameter settings (No. 1828 or No. 504-507), CMR and DMR settings, and position gain setting.
- If settings are correct, go to A-7.
 - If settings are incorrect, go to Cause 5.
- A-7 Check the three-phase input voltage to the servo amplifier.
- If the voltage is equal to or higher than 0.85 times the rated voltage, go to A-8.
 - If the voltage is lower than 0.85 times the rated voltage, go to Cause 6.
- A-8 Replace the servo amplifier.
- If an alarm still occurs, go to A-9.
 - If an alarm no longer occurs, go to Cause 7.
- A-9 Replace the motor.
- If an alarm no longer occurs, go to Cause 8.
 - If an alarm still occurs, go to Cause 11.
- B. Check the parameter settings (No. 1829 or No. 593-596).
- If settings are correct, go to B-1.
 - If settings are incorrect, go to Cause 5.
- B-1 Check the connections of the command cable and feedback cable.
- If connections are correct, go to B-2.
 - If connections are incorrect, go to Cause 9.
- B-2 Check the settings of the speed loop parameters (LDINT, PK1V, and PK2V) and dead zone compensation parameters (No. 1865 and 1866, or No. 8X53 and 8X54) of the servo.
- If any of the settings is too high, go to Cause 10.
 - If settings are correct, go to Cause 8.

[Causes]

- (1) For the serial pulse coder, the AMR setting differs depending on the number of poles of the motor. An excessive deviation error is caused if this setting is incorrect.
- (2) If these settings are set incorrectly, the torque of the motor during high speed rotation becomes insufficient, and a significant delay occurs between execution of a command and actual motor operation. This delay causes excessive deviation during machine motion.
- (3) The acceleration/deceleration time is insufficient for the machine load; set a larger time constant for the acceleration/deceleration.

7. TROUBLESHOOTING DIGITAL SERVO DEVICES

- (4) There may be phase shift of the mounted pulse coder. Remove the motor cover and shift the pulse coder phase by 1mm and see how operation changes.
- (5) If these parameters are set incorrectly, the cumulative positioning error exceeds the set value and an alarm occurs.
- (6) If the three-phase input voltage to the servo amplifier is insufficient, the torque becomes insufficient (as in Cause 2, above), resulting in excessive deviation during machine motion.
- (7) The servo amplifier is defective.
- (8) The motor is defective (due to demagnetization, etc.) or the pulse coder is defective. If the phase C signal for the pulse coder is connected to the wrong phase, the motor operates out of control as soon as it is magnetized, resulting in excessive deviation when the machine stops.
- (9) If the command cable and feedback cable are connected incorrectly, the motor operates out of control as soon as it is magnetized, resulting in excessive deviation when the machine stops.
- (10) If values set to these parameters are too high, the motor vibrates heavily when stopping, resulting in excessive deviation when the machine stops.
- (11) The machine load is too heavy for the motor capacity. A different servo needs to be selected.

7. TROUBLESHOOTING DIGITAL SERVO DEVICES

7.5.4 APC alarm

[Check items]

1. Connection of the feedback cable
2. Content of the alarm and its frequency

[Adjustment procedure]

- A. Check the alarm in detail.
 - If the message "NEED ZERO RETURN" for Series 10, 11, 12, and 15, or any battery-related message for Series 0 is displayed, go to Cause 1.
 - For any APC alarms other than the above, go to A-1.
- A-1 Check how frequently this alarm occurs when the power to the NC is turned on and off several times.
 - If the alarm occurs every time, go to A-2.
 - If the alarm occurs occasionally, go to Cause 2.
- A-2 Check whether the DMR1/5 function is enabled.
 - If enabled, go to Cause 3.
 - If disabled, go to A-3.
- A-3 Check the connection of the feedback cable.
 - If connection is incorrect, go to Cause 4.
 - If connection is correct, go to Cause 5.

[Causes]

- (1) Check the battery voltage. If the battery has run down, replace it while the power to the NC is on.
- (2) Noise may affect the pulse and cause malfunctions. Shield the signals from noise.
- (3) The DMR1/5 function is not supported by the absolute pulse coder. Disable the DMR1/5 function, and set the parameter for the flexible feed gear.
- (4) An alarm occurs if the feedback cable is connected incorrectly or disconnected.
- (5) The pulse coder is probably defective.

7. TROUBLESHOOTING DIGITAL SERVO DEVICES

7.6 Alarms of the Serial Pulse Coder

When any of the following alarm messages is displayed on the NC screen, refer to the items listed.

No.	Alarm message	NC model
3X9 4X7	SPC ALARM NEED ZRN	Series0-C
SV110 OT032	DATA ERROR (SERIAL PCDR) NEED ZRN	Series15

If any of the alarm messages below is displayed on the NC screen, see Alarm 3 and Alarm 4 in the servo adjustment screen.

[Servo adjustment screen] Alarm 3

bit 7	bit 6	bit 5	bit 4	bit 3	bit 2	bit 1	bit 0
SRFLG	CSAL	BLAL	PHAL	RCAL	BZAL	CKAL	SPHAL

- SRFLG** : This is not an alarm bit.
This bit is set to 1 when a serial pulse coder is connected, and to 0 when a conventional pulse coder is connected.
- CSAL** : The serial pulse coder is faulty. Replace the pulse coder.
- BLAL** : Battery voltage is low. Replace the battery.
- PHAL** : The serial pulse coder or feedback cable is faulty. Replace the pulse coder or cable.
- RCAL** : The serial pulse coder is faulty. Replace the pulse coder.
- BZAL** : The power has been turned on to the pulse coder for the first time. After checking that the battery is connected, turn on the power again and return the machine to the zero point.
- CKAL** : The serial pulse coder is faulty. Replace the pulse coder.
- SPHAL** : The serial pulse coder or feedback cable is faulty. Replace the pulse coder or cable.

7. TROUBLESHOOTING DIGITAL SERVO DEVICES

[Servo adjustment screen] Alarm 4

bit 7	bit 6	bit 5	bit 4	bit 3	bit 2	bit 1	bit 0
DTERR	CRCERR	STBERR					

- DTERR** : There is a communication failure of the serial pulse coder.
It is caused by failure of the pulse coder, feedback cable, or feedback receiver circuit.
Replace the pulse coder, feedback cable, or NC axis board.
- CRCERR** : There is a communication failure of the serial pulse coder.
It is caused by failure of the pulse coder, feedback cable, or feedback receiver circuit.
Replace the pulse coder, feedback cable, or NC axis board.
- STBERR** : There is a communication failure of the serial pulse coder.
It is caused by failure of the pulse coder, feedback cable, or feedback receiver circuit.
Replace the pulse coder, feedback cable, or NC axis board.

8. DIGITAL SERVO ADJUSTMENT PROCEDURE

8.1 Configuration of Digital Servo Parameters

Subsection 8.1.1 lists the symbols, parameter numbers, and rank of servo parameters used for the digital servo adjustment procedure. See Subsection 8.1.1 when setting parameters for the digital servo adjustment procedure.

Subsection 8.1.2 has a block diagram (for 9030 Series) showing how servo parameters are used for control. See Subsection 8.1.2 for servo parameter adjustment.

Subsection 8.1.3 explains the servo adjustment screen that displays parameters frequently used for digital servo adjustment, and data for each parameter.

8.1.1 Symbols, parameter Nos., and rank of digital servo parameters

Symbol	Series 0	Series15	Rank	Description
PLC01	No. 0037 bit7	No. 1804 bit0	*A⊙	High-resolution bit
SPTPx(x:X,Y,Z,4)	0037 bity	(y = 0,1,2,3)	*A⊙	Separate detector enabled/disabled
AMR	8X01	1806	*A⊙	AMR setting for pulse coder
PFSEL		1807 bit3	*A⊙	Separate detector enabled/disabled
OPTX		1815 bit1	*A⊙	Separate detector enabled/disabled
MTRID	8X20	1874	*A⊙	Motor Model
LDINT	8X21	1875	*A⊙	Load inertia ratio
DIRCTL	8X22	1879	*A⊙	Motor rotation direction
PULCO	8X23	1876	*A⊙	Number of speed detection feedback pulses
PPLS	8X24	1891	*A⊙	Number of position detection feedback pulses
TGALRM	8X03 bit1	1808 bit1	*B⊙	Alarm detection level for software-caused disconnection
OBENBL	8X03 bit2	1808 bit2	*B⊙	Observer function
PIENBL	8X03 bit3	1808 bit3	*B⊙	Changeover between IP and PI
1SPRS	8X03 bit4	1808 bit4	*B⊙	One-pulse suppression function
BLENBL	8X03 bit5	1808 bit5	*B⊙	Backlash acceleration function
OVSCMP	8X03 bit6	1808 bit6	*B⊙	Overshoot prevention function
VOFST	8X03 bit7	1808 bit7	*B⊙	VCMD offset function
TIB0	8X04 bit1	1809 bit1	*B⊙	Velocity loop control cycle
FEEDFD	8X05 bit1	1883 bit1	*B○	Feed forward function
BRKCTL	8X05 bit6	1883 bit6	*B○	Vertical-axis brake control function
FCBLCM	8X06 bit0	1884 bit0	*B	Closed loop backlash bit
PKVER	8X06 bit2	1884 bit2	*B	Velocity-dependent current loop gain variable function
MODEL ACCFB	8X06 bit4	1884 bit4	*B	1-ms acceleration feedback function

8. DIGITAL SERVO ADJUSTMENT PROCEDURE

Symbol	Series 0	Series15	Rank	Description
DCBEMF	No. 8X06 bit6	No. 1884 bit6	*B	Bit for back electromotive force compensation during deceleration
ADBLSH	8X09 bit2	1953 bit2	*B	New backlash acceleration function bit
BLCUT	8X09 bit6	1953 bit6	*B	Bit for backlash acceleration during cutting
BLSTP	8X09 bit7	1953 bit7	*B	Backlash acceleration stop function
SPBIT	8X10 bit0	1954 bit0	*B	Bit for a 10000-pulse pulse coder
BLTEN	8X10 bit3	1954 bit3	*B	Tenfold backlash acceleration function
PGEXPD	8X11 bit5	1955 bit5	*B	Function for enlarging the position gain setting range
DPFBCT	8X11 bit7	1955 bit7	*B	Dual position feedback function
MSFEN	8X12 bit1	1956 bit1	*B	Machine velocity feedback function
VCMD1	8X12 bit4	1956 bit4	*B	VCMD output variable bit
VCMD2	8X12 bit5	1956 bit5	*B	VCMD output variable bit
PK1V	8X43	1855	*B	Velocity loop (integration) gain
PK2V	8X44	1856	*B	Velocity loop (proportion) gain
PK3V	8X45	1857	*B	Imperfect integration coefficient
BLCMP	8X48	1860	*B	Backlash compensation acceleration parameter
DPFMAX	8X49	1961	*B	Maximum amplitude of dual position feedback
TGALMLV	8X64	1892	*B	TG alarm level
PK2VAUX	8X66	1894	*B	Compensation torque command
FILTER	8X67	1895	*B	Torque command filter
FALPH	8X68	1961	*B	Feed forward coefficient
VFFLT	8X69	1962	*B	Velocity loop feed forward coefficient
ERBLM	8X70	1963	*B	Backlash compensation acceleration parameter
PBLCT	8X71	1964	*B	Backlash compensation acceleration parameter
AALPH	8X74	1967	*B	Velocity-dependent current loop gain variable
MODEL	8X75	1968	*B	
WKAC	8X76	1969	*B	1-ms acceleration feedback gain
OSCTPL	8X77	1970	*B	Overshoot prevention counter
DPFCH1	8X78	1971	*B	Conversion coefficient for dual position feedback (numerator)
DPFCH2	8X79	1972	*B	Conversion coefficient for dual position feedback (denominator)
DPFTC	8X80	1973	*B	Time constant for dual position feedback
DPFZW	8X81	1974	*B	Zero width for dual position feedback
BLENDL	8X82	1975	*B	Backlash acceleration stop amount
MOFCTL	8X83	1976	*B	Vertical-axis brake control timer
SDMR1	8X84	1977	*B⊙	Flexible feed gear numerator
SDMR2	8X85	1978	*B⊙	Flexible feed gear denominator

8. DIGITAL SERVO ADJUSTMENT PROCEDURE

Symbol	Series 0	Series15	Rank	Description
TCPRLD	8X87	1980	*B	Backlash acceleration torque offset
MCNFB	8X88	1981	*B	Machine velocity feedback gain
BLBSL	8X89	1982	*B	Base pulse for backlash acceleration
ONEPSL		1992	*B	One-pulse suppression level for serial pulse coder A
TIA0	8X04 bit0	1809 bit0	*C⊙	
TRW0	8X04 bit2	1809 bit2	*C⊙	
TRW1	8X04 bit3	1809 bit3	*C⊙	
DLY0	8X04 bit6	1809 bit6	*C⊙	
DLY1	8X04 bit7	1809 bit7	*C⊙	
PK1	8X40	1852	*C⊙	Current loop gain
PK2	8X41	1853	*C⊙	Current loop gain
PK3	8X42	1854	*C⊙	Current loop gain
PK4V	8X46	1858	*C	Velocity loop gain
POA1	8X47	1859	*C	Velocity control observer parameter
POK1	8X50	1862	*C	Velocity control observer parameter
POK2	8X51	1863	*C	Velocity control observer parameter
PPMAX	8X53	1865	*C	Current dead-zone compensation
PDDP	8X54	1866	*C	Current dead-zone compensation
PHYST	8X55	1867	*C	Current dead-zone compensation
EMFCMP	8X56	1868	*C	Back electromotive force compensation
PVPA	8X57	1869	*C	Current phase control
PALPH	8X58	1870	*C	Current phase control
EMFBAS	8X59	1871	*C	Back electromotive force compensation
TQLIM	8X60	1872	*C⊙	Torque limit
EMFLMT	8X61	1873	*C	Back electromotive force compensation
POVC1	8X62	1877	*C	Overload protection coefficient
POVC2	8X63	1878	*C	Overload protection coefficient
POVCLMT	8X65	1893	*C	Overload protection coefficient
PTCURR	8X86	1979	*C⊙	Rated current parameter
DEPVPL	8X98	1991	*C	Phase shift compensation during deceleration

Rank *A : Parameters set or changed by machine tool builders

Rank *B : Parameters whose standard values are set by the system and changed as required

Rank *C : Parameters which must not be changed

⊙ : If the value set for the parameter is changed, the power must be turned on again. (Common to Series 0-C (32-bit) and Series 15)

8. DIGITAL SERVO ADJUSTMENT PROCEDURE

○ : If the value set for the parameter is changed, the power must be turned on again. (Only for Series 0-C (32-bit))

(Note 1) bity (y = 0-7) indicates the bit position.

(Note 2) Consider PPMAX, PDDP, EMFCMP, and PVPA as rank *A for other than Series 0-C (32-bit) and Series 15.

(Note 3) The description and symbol name of parameters No.8X04 (Series 0) and No.1809 (Series 10, 11, 12, 15) for Series 0-C (32-bit) and Series 15 are different from other Series. See Sections II-1.3 and II-1.4.

(Note 4) For ROM 9040 Series corresponding to the serial pulse coder, consider the rank of the flexible feed gear parameters (SDMR1 and SDMR2) as *A.

8. DIGITAL SERVO ADJUSTMENT PROCEDURE

8.1.2 Block diagram of digital servo parameters

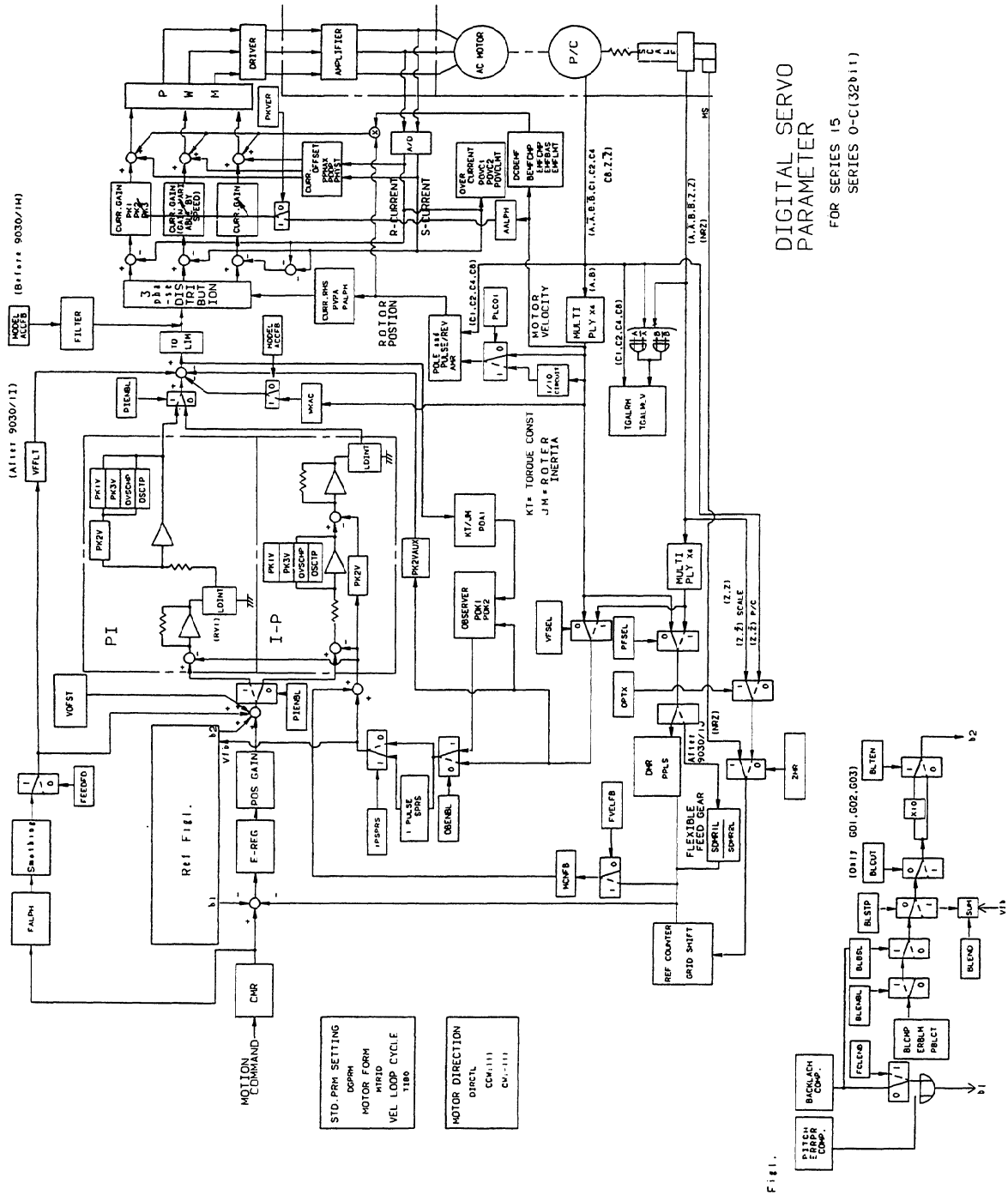

8. DIGITAL SERVO ADJUSTMENT PROCEDURE

8.1.3 Digital servo adjustment using the servo adjustment screen

The servo adjustment screen is accessible from the PARAMETER screen and SERVICE screen.

The servo adjustment screen is a screen that displays parameters frequently used for digital servo adjustment and data for each parameter. Use this screen for digital servo adjustment and alarm analysis. This screen can also be used for the digital servo automatic adjustment function (using dedicated ROM 9039 Series).

Servo adjustment		01000 N0000	
X axis			
Func bit	00000000	Alarm 1	00000000
Loop gain	3000	Alarm 2	00000000
Tuning st	0	Alarm 3	00000000
Set period	0	Alarm 4	00000000
Int gain	113	Loop gain	3000
Prop gain	-1015	Pos error	4444
Filter	0	Current (%)	5
Veloc gain	100	Speed (rpm)	1000
(Value Setting)			

Fig. 8.1.3 Example of setting on servo adjustment menu

This section explains each parameter on the servo adjustment screen.

(1) Function bit No. 8X03 (Series 0) No. 1808 (Series 15)

VOFST	OVSCMP	BLENBL	1PSPRS	PIENBL	OBENBL	TGALRM	
-------	--------	--------	--------	--------	--------	--------	--

	b7	b6	b5	b4	b3	b2	b1	b0
Standard setting :	0	0	0	0	0	0	0	0

TGALRM : The detection level of the position detector disconnection alarm is:

- 0 : Set to standard
 - 1 : Reduced to a sensitivity specified separately
- (See Subsection I-7.3.2 for details of the function.)

OBENBL : Velocity control observer is:

- 0 : Not used (Standard setting)
 - 1 : Used
- (See Subsection II-2.3.3 for details of the function.)

PIENBL : Velocity control is:

- 0 : Set to IP (Standard setting)
 - 1 : Set to PI
- (See Subsection II-2.9.1 for details of the function.)

8. DIGITAL SERVO ADJUSTMENT PROCEDURE

1PSPRS : One-pulse suppression function is:
0 : Not used (Standard setting)
1 : Used
(See Subsection II-2.2.2 for details of the function.)

BLENBL : Backlash acceleration function is:
0 : Not used (Standard setting)
1 : Used
(See Subsection II-2.5.2 for details of the function.)

OVSCMP : Overshoot compensation function is:
0 : Disabled (Standard setting)
1 : Enabled
(See Subsection II-2.4.1 for details of the function.)

VOFST : VCMD offset function is:
0 : Not used (Standard setting)
1 : Used
(See Subsection II-2.6.1 for details of the function.)

(2) Loop gain No. 517 (Series 0) No. 1825 (Series 15)

Displays the position gain of the digital servo.

(3) Adjustment start bit No. 8X09 bit 1 (Series 0) No. 1953 bit 1 (Series 15)

(4) Setting period No. 8X79 (Series 0) No. 1972 (Series 15)

Items (3) and (4) are used by the digital servo automatic adjustment function (using dedicated ROM 9039 Series). For details, see Section II-2.7, "Automatic Adjustment Function."

(5) Integration gain No. 8X43 (Series 0) No. 1855 (Series 15)

(6) Proportion gain No. 8X44 (Series 0) No. 1856 (Series 15)

Items (5) and (6) are velocity loop gains, PK1V (integration gain) and PK2V (proportion gain). Although determined specific to the motor, they can be adjusted if necessary.

(7) Filter No. 8X67 (Series 0) No. 1895 (Series 15)

This is a torque command filter (FILTER) for eliminating high-frequency noise from the torque command. See Subsection II-2.3.3 for details of the function.

8. DIGITAL SERVO ADJUSTMENT PROCEDURE

(8) Velocity gain

The velocity gain displays the conventional load inertia ratio LDINT (No. 8X21, No. 1875) as a percentage to make setting easier. 100% is displayed for the motor alone.

Input the following:

$$\frac{(\text{Inertia of machine} + \text{rotor inertia of motor})}{\text{Rotor inertia of motor}} \times 100 (\%)$$

or the following is displayed:

$$\frac{\text{Load inertia ratio LDINT(No. 8X21, No. 1875) + 256}}{256} \times 100 (\%)$$

Multiplying the velocity gain by velocity loop gains PK1V and PK2V makes the characteristic of the velocity loop in loaded state the same as for the motor alone.

(9) Alarm 1

OVL	LVAL	OVC	HCAL	HVAL	DCAL	FBAL	OFAL
b7	b6	b5	b4	b3	b2	b1	b0

OFAL : An overflow alarm occurred in the digital servo.

FBAL : A pulse coder disconnection alarm occurred(*1).

DCAL : A regenerative discharge circuit alarm occurred in the servo amplifier.

HVAL : An overvoltage alarm occurred in the servo amplifier.

HCAL : An abnormal current alarm occurred in the servo amplifier.

OVC : An overcurrent (overload) alarm occurred in the digital servo.

LVAL : An insufficient voltage alarm occurred in the servo amplifier.

OVL : An overload alarm occurred in the servo motor or servo amplifier (*1).

(* 1) Alarm 2 indicates the details of FBAL and OVL.

Alarms related to the servo amplifier can be checked with the LEDs on the amplifier PC board.

8. DIGITAL SERVO ADJUSTMENT PROCEDURE

(10) Alarm 2

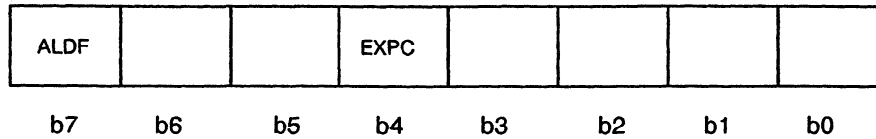

Alarm 2 indicates the details of OVL and FBAL in alarm 1.

	Alarm details	bit7 ALDF	bit4 EXPC
OVL	Motor overheating	1	0
	Amplifier overheating	0	0
FBAL	Pulse coder disconnection by hardware	1	0
	Pulse coder disconnection by software	0	0
	Separate pulse coder disconnection by software	1	1

Bits other than bits 4 and 7 are not alarm bits.

(11) Alarm 3

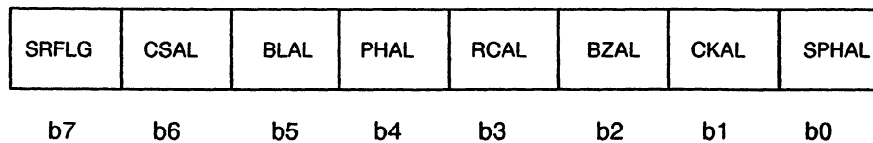

SPHAL : The serial pulse coder or feedback cable is abnormal.

CKAL : The serial pulse coder is abnormal.

BZAL : Power was supplied to the serial pulse coder for the first time. Confirm that the battery is connected and then turn on the power again to return to the zero point.

RCAL : The serial pulse coder is abnormal.

PHAL : The serial pulse coder or feedback cable is abnormal.

BLAL : The voltage of the battery is low.

CSAL : The serial pulse coder is abnormal.

SRFLG : This is not an alarm bit. This bit is 1 when the serial pulse coder is connected.

8. DIGITAL SERVO ADJUSTMENT PROCEDURE

8.2 Parameter Adjustment for Each Fault

Digital servo faults and measures to be taken are described below. The measures are explained in the order of most effective ones and ones not influencing others. Take the measures in the order and use them jointly unless otherwise specified.

To increase (decrease) a parameter value according to instructions, set the parameter to 120%, 150%, 200%, then 300% (80%, 60%, 40%, then 30%).

Set a proper parameter in consideration of a change in status fault such as improvement or bad influences such as vibration. Then change the feedrate and confirm that no other harmful influences occur.

Some parameters and functions may be invalid depending on the ROM edition. Check the ROM edition and its function before use. For more information on the adjusting procedure, see Item 1 or later.

8.2.1 Vibration during motor stop

If the motor shaft vibrates during motor stop or the servo error rate is not stabilized to 0, the following causes are assumed:

- (1) Too high a value is set for LDINT due to incorrect load inertia calculation.
- (2) A low-rigidity portion or resonance system exists in the coupling between the motor and machine.

If the load inertia is calculated correctly, take the following measures:

- ① Set one-pulse suppression function 1SPPRS to 1.
- ② Decrease velocity loop gain PK2V (absolute value).
- ③ Set compensation torque command function PK2VAUX to about $500000/N_p$.
(N_p = Pulse count of motor built-in pulse coder)
- ④ Set acceleration feedback function MODELACCFB to 1 and torque command filter FILTER to about 100 Hz.
- ⑤ Set observer function OBENBL to 1.
- ⑥ Change the velocity loop control period to 1 ms.

8.2.2 Hunting during movement

- ① Increase velocity loop gain PK1V for I-P control.
- ② Set PI control validity PIENBL to 1.
- ③ Change the velocity loop control period to 1 ms and increase velocity loop gain PK2V.
- ④ Set 1-ms acceleration feedback function MODELACCFB to 1 and set acceleration feedback gain WKAC to 50 through 70 (normal pulse coder), 10 through 15 (high-resolution pulse coder), or 200 through 300 (serial pulse coder). Set torque command filter FILTER to about 1100 Hz. Then, increase velocity loop gain PK1V and PK2V.
- ⑤ If the hunting is not corrected, lower the position gain or increase the time constant.

8. DIGITAL SERVO ADJUSTMENT PROCEDURE

8.2.3 Non-coincident positioning error

If the servo error does not coincide with a calculation value (the position gain cannot be set correctly), the following cause is assumed:

- ① CMR, DMR, velocity feedback pulse count PULCO, position feedback pulse count PPLS, or the flexible feed gear ratio, SDMR1 and SDMR2, is set incorrectly.

In the digital servo system, a value corresponding to the loop gain multiplier in an analog servo system is calculated from the parameters above.

8.2.4 Overshoot during stop

- ① Set PI control validity PIENBL to 1.
- ② Increase velocity loop gain PK2V.
- ③ Change the velocity loop control period to 1 ms and increase velocity loop gain PK2V.
- ④ Set overshoot prevention function validity OVSCMP to 1 and adjust incomplete integral PK3V in the range of 32,000 to 20,000.
- ⑤ If there is a drift during stop after the adjustment of step 4, set overshoot correction clamp OSCTPL to about 50.
- ⑥ Stop the overshoot prevention function and adjust incomplete integral PK3V in the range of 32,767 to 32,000.
- ⑦ Increase velocity loop gain PK1V.

8.2.5 Erratic movement

- ① Check that there is no overshoot. If an overshoot occurs, remove the overshoot in accordance with the procedure in 8.2.4.
- ② Set PI control validity PIENBL to 1.
- ③ Increase velocity loop gain PK1V.
- ④ Validate Vcmd offset function VOFST.
- ⑤ Change the velocity loop control period to 1 ms and increase velocity loop gain PK1V.

8.2.6 Slow response

- ① Set PI control validity PIENBL to 1.
- ② Increase velocity loop gains PK1V and PK2V.
- ③ Change the velocity loop control period to 1 ms and increase velocity loop gain PK1V.
- ④ Set 1-ms acceleration feedback function MODELACCFB to 1 and set acceleration feedback gain WKAC to 50 through 70 (normal pulse coder), 10 through 15 (high-resolution pulse coder), or 200 through 300 (serial pulse coder). Set torque command filter FILTER to about 100 Hz. Then, increase velocity loop gains PK1V and PK2V.

8. DIGITAL SERVO ADJUSTMENT PROCEDURE

8.2.7 Disconnection alarm malfunctions due to large backlash in a fully closed loop system

- ① Set disconnection alarm variable function T GALRM to 1 and set disconnection alarm level T GALMLV to the backlash level. (Set 1 per 1/64 revolutions.)

8.2.8 Quadrant protrusion

- ① Increase velocity loop gain PK1V.
- ② Validate the backlash acceleration function. For this adjustment, see the backlash acceleration function description. (see Subsections II-2.5.2 and II-2.5.3.)
- ③ Set PI control validity PIENBL to 1.
- ④ Change the velocity loop control period to 1 ms and increase velocity loop gains PK1V and PK2V.

8.2.9 Bad cut surface

If a bad cut surface occurs and has a periodic stripe, change the feedrate, taper angle, and spindle rotation so as to check the cause. If there is a problem in the feed axis, check the irregular movements of the feed axis per revolution and the frequency. After that, take the following measures:

- A. 24 irregular movements per rotation
Check to see if dead zone correction parameters PPMAX and PDDP are set correctly. If a parameter is set incorrectly, set them again.
- B. If the frequency is 10 Hz or lower
Same as the adjustment guide in Subsection 8.2.6.
- C. If the frequency is 100 Hz or higher
 - ① Decrease velocity loop gain PK2V (absolute value).
 - ② Set 1-ms acceleration feedback function MODELACCFB to 1 and set torque command filter FILTER to about 100 Hz.
 - ③ Set observer function OBENBL to 1.
 - ④ Change the velocity loop control period to 1 ms.

8.2.10 Dispersed positioning

- ① Observe the position deviation during stop. If the deviation is 0, no measures can be taken in the servo system. Adjust a backlash or posture difference. If it is a fully closed loop, adjust the scale installation.
- ② If an overshoot occurs just before stop, remove the overshoot according to the procedure in 8.2.4.
- ③ If the position deviation is dispersed during stop, set parameters in accordance with steps 4 to 8.

8. DIGITAL SERVO ADJUSTMENT PROCEDURE

- ④ Increase incomplete integral PK3V in the range where there is no overshoot.
- ⑤ Set PI control validity PIENBL to 1.
- ⑥ Increase velocity loop gains PK1V and PK2V.
- ⑦ Change the velocity loop control period to 1 ms and increase velocity loop gain PK1V.
- ⑧ Set 1-ms acceleration feedback function MODEL ACCFB to 1 and set acceleration feedback gain WKAC to 50 through 70 (normal pulse coder), 10 through 15 (high-resolution pulse coder), or 200 through 300 (serial pulse coder). Set torque command filter FILTER to about 1100. Then, increase velocity loop gains PK1V and PK2V further.

8.2.11 Unusual sound in rapid traverse

- ① Decrease velocity loop gain PK2V (absolute value).
- ② Set rms acceleration feedback function MODEL ACCFB to 1 and set torque command filter FILTER to about 100 Hz.
- ③ Set observer function OBENBL to 1.

8.2.12 Vibration cause by low gain due to long ball screw

The long and thin ball screw functions as a spring between the motor and machine. The entire system may be then resonated. The frequency at that time is 50 to 200 Hz. The motor corrects the vibration using a disturbance torque of the resonant frequency. However, if an integrator is very effective, the servo system amplifies the vibration due to the phase delay of the integrator. Set parameters in accordance with the procedure below.

- ① Set PI control validity PIENBL to 1.
- ② Decrease velocity loop gain PK1V and increase velocity loop gain PK2V.
- ③ Change the velocity loop control period to 1 ms.
- ④ Set 1-ms acceleration feedback function MODEL ACCFB to 1 and set torque command filter FILTER to about 100 Hz.
- ⑤ If the vibration cannot be stopped by changing the parameters above, use a high-resolution pulse coder.

8.2.13 Vibration when stop due to large backlash

The large backlash makes a large free portion between the motor and machine. No velocity loop gain corresponding to the calculated value may thus be obtained. A problem takes place at system start or in the surface precision when the frequency is lowered to the level in which the motor will not vibrate. The frequency when the motor vibrates in a backlash is usually several tens Hz. Set parameters in accordance with the procedure below.

- ① Set PI control validity PIENBL to 1.
- ② Decrease velocity loop gain PK1V and increase velocity loop gain PK2V.
- ③ Change the velocity loop control period to 1 ms.
- ④ Set 1-ms acceleration feedback function MODEL ACCFB to 1 and set torque command filter FILTER to about 100 Hz.

8. DIGITAL SERVO ADJUSTMENT PROCEDURE

- ⑤ If the vibration cannot be corrected by changing the parameters above, use a high-resolution pulse coder.
- ⑥ Backlash acceleration can be effectively used for a quadrant protrusion.

8.2.14 Gain is low because load inertia is much larger than torque of motor

A motor may vibrate if LDINT is set according to the calculation value when the load inertia is very large (more than four times as large as torque of motor). The motor does not operate smoothly when the gain is lowered. In this case, a velocity loop gain must be increased to ensure a good response with the velocity loop being vibration-free and stable.

- ① Set PI control validity PIENBL to 1.
- ② Increase velocity loop gains PK1V and PK2V.
- ③ Change the velocity loop control period to 1 ms and increase velocity loop gains PK1V and PK2V.
- ④ Set 1-ms acceleration feedback function MODEL ACCFB to 1 and set torque command filter FILTER to about 100 Hz.
- ⑤ If the gain cannot be increased by changing the parameter above, use a high-resolution pulse coder.

8.2.15 Bad cutting shape due to high cutting resistance

In a machine with high cutting resistance, the motor is vibrated by a disturbance torque. The cutting shape may then deteriorate. When the motor is vibrated by the disturbance torque, if the frequency is relatively low and an amplitude (absolute value of force) is large, to suppress the vibration in the servo system, enhance the robustness for disturbance by increasing the velocity loop gain. Set parameters in accordance with the procedure below.

- ① Increase velocity loop gains PK1V and PK2V.
- ② Change the velocity loop control period to 1 ms and increase velocity loop gains PK1V and PK2V.
- ③ Set 1-ms acceleration feedback function MODEL ACCFB to 1 and set torque command filter FILTER to about 100 Hz.
- ④ If the cutting shape cannot be improved by changing the parameters above, use a high-resolution pulse coder.

8. DIGITAL SERVO ADJUSTMENT PROCEDURE

8.3 Adjustment Procedure for Vibration

8.3.1 Vibration during stop

[Check items]

1. Vibration amplitude : Check it using the DGN positioning error, the VCMD and TSA signals in a check board.
2. Vibration frequency : Check it using the VCMD and TSA signals in a check board.
3. Is there sound? Does the table vibrate?

[Adjustment procedure]

The table is moved mechanically when it vibrates without motor activation. Set parameters in accordance with the procedure below when the motor is activated together with a machine. For the very low-frequency vibration (drift) during stop, see Section 8.4.

A. If motor rotates

A-1 Parameter check

- Check that the load inertia ratio is set correctly.
- Check the dead zone compensation parameter of a current loop.
- Check the parameter when a position loop is set to 1 μm and a velocity loop is set to 0.1 μm .

A-2 Validate the one pulse suppression function

- If the vibration stops, go to cause 1.
- If the vibration does not stop, go to A-3.

A-3 Decrease the velocity loop proportional gain (PK2V) by half.

- If the vibration stops, go to A-4.
- If the vibration does not stop, go to A-5.

A-4 Inspect an oscillation limit and move velocity loop gain PK2V to 70% to 80% of the oscillation limit.

- If there is no problem in the movement and cutting shape, go to cause 2. (Acceptable)
- If there is a problem in the movement or cutting shape, return to the original gain and go to A-5.

A-5 Perform each function in the following order:

- Compensation torque command function
- Velocity loop control cycle of 1 ms
- Acceleration feedback
- Use an observer or torque command filter when vibration frequency is high.

The vibration stops using any function, go to cause 3.

If the vibration does not stop, go to A-6.

8. DIGITAL SERVO ADJUSTMENT PROCEDURE

A-6 Examine the use of a high-resolution pulse coder. Go to cause 4.

B. If motor does not rotate

B-1 If the machine table vibrates when the motor does not rotate, it is considered that the machine vibrates by an external force other than the servo system. Check the causes below and take corrective measures.

- Oil pump vibration
- Vibration on floor
- Spindle vibration

[Causes]

(1) If a motor vibrates within ± 1 pulse the movement is reflected in a velocity feedback. The motor vibration may not be attenuated because PK2V amplifies the feedback pulse. The one-pulse suppression function is used to prevent this state. The function specifies that a pulse not exceeding one pulse is not reflected to PK2V when the velocity feedback direction is reversed in a pulse. The one-pulse suppression function also can prevent a minute vibration during stop.

(2) If the velocity loop vibrates during stop, the cause is primarily due to a proportional term. Therefore, the vibration during stop can be reduced by lowering velocity loop gain PK2V.

(3) These functions can be used to make the system much less likely to vibrate, while maintaining the response speed of the velocity loop. However, note that the compensation torque command function and acceleration feedback should not be used together.

Acceleration feedback detects motor acceleration and compensates a motor's torque command using the acceleration. The compensation torque command function detects velocity feedback from the motor every $250 \mu\text{s}$ and compensates torque minutely in the direction opposite to movement unless the velocity feedback value is 0.

If the vibration frequency during stop is lower than 150 Hz, the system stability is improved proportionally by a shorter velocity loop control period. If the vibration frequency is higher than 150 Hz and the velocity loop is updated every 2 ms; the vibration component is rounded and the vibration may be suppressed to some degree. In this case, when the velocity loop control period is changed from 2 ms to 1 ms, the response to velocity loop instructions is improved, and the reaction to disturbance is also enhanced. Consequently, the degree of vibration may be less.

(4) A high-resolution pulse coder can detect velocity more precise. This can raise the oscillation limit.

8. DIGITAL SERVO ADJUSTMENT PROCEDURE

8.3.2 Vibration in low-speed feed

[Check items]

1. Vibration amplitude : Check it using the DGN positioning error, the VCMD and TSA signals in a check board.
2. Vibration frequency : Check it using the VCMD and TSA signals in a check board.
3. Does the frequency change when the feedrate is changed?

[Adjustment procedure]

A-1 Parameter check

- Check that the load inertia ratio is set correctly.
- Check the parameter when a position loop is set to 1 μm and a velocity loop is set to 0.1 μm .
- Check that the position gain is set correctly.

A-2 Vibration frequency check

- If the frequency is low (ten Hz or lower), go to A-3.
- If the frequency is higher than 30 Hz, go to A-5.

(When the vibration frequency is about 10 to 30 Hz, it is sometimes difficult to judge whether you should go to A-3 or A-5. In this case, observe the TSA and TCMD waveform in the AC range in the check board.

- If the phase difference is less than 90 degrees, go to A-3. If it is more than 90 degrees, go to A-5.
- You can also do the method of trial and error.

If you can find no effect when you went to A-3, for example, go to A-5.)

A-3 Increase velocity loop gains PK1V and PK2V until the velocity loop oscillation stops.

- If the vibration stops, go to cause 1.
- If the vibration is left yet, go to A-4.

A-4 Perform each function in the following order:

- Compensation torque command function
- Velocity loop PI
- Set the velocity loop control cycle to 1 ms and increase the velocity loop gain. Go to Cause 2.

A-5 Decrease velocity loop gains PK1V and PK2V by half.

- If the vibration stops, go to cause 3.
- If the vibration does not stop, go to A-6.

A-6 Use a torque command filter or observer when the vibration frequency is very high (100 Hz or higher).

Go to cause 4.

8. DIGITAL SERVO ADJUSTMENT PROCEDURE

A-7 Perform each function below.

- Set velocity loop PI and decrease velocity loop gain PK1V to the level in which no vibration occurs.
- Set the velocity loop control cycle to 1 ms.
- Set acceleration feedback

Go to cause 5.

A-8 Examine the use of a high-resolution pulse coder. Go to cause 6.

Check that there is no problem in the movement and cutting shape for final set parameters.

[Causes]

- (1) A vibration at very low frequency is often caused by a disturbance. Increase a velocity loop gain to resist the disturbance. For more information, see Subsection 8.4.2, "Erratic movement at low speed feed."
- (2) Setting velocity loops PI or a velocity loop control cycle of 1 ms can strengthen a velocity loop against disturbance. The velocity loop gain can be further stabilized by setting the velocity loop control cycle to 1 ms.
- (3) An excessively high velocity loop gain causes a rapid vibration. In this case, it is effective to decrease a velocity loop gain. However, if the velocity loop gain is decreased excessively, the cutting shape will deteriorate or an erratic movement is caused. If the fault above occurs when the velocity loop gain is decreased until the vibration stops, keep the velocity loop gain high in some extent and suppress the vibration according to Item A-7.
- (4) An observer eliminates high-frequency signals in the high-speed feedback. Therefore, the observer can be effectively used to suppress the vibration of very high-frequency only. A torque command filter filters the torque command that is calculated by a velocity loop. A high-frequency vibration can be suppressed using the torque command filter.
- (5) If vibration is caused due to a time lag of the integrator in a velocity loop, set the velocity loop to PI control and decrease the integral gain to reduce the time lag. If the vibration frequency is lower than 160 to 200 Hz, setting the velocity loop to 1 ms may sometimes reduce the vibration level.
- (6) Using a high-resolution pulse coder, the velocity information can be detected more precisely and the velocity can be controlled accurately. This enables vibration suppression.

8. DIGITAL SERVO ADJUSTMENT PROCEDURE

8.3.3 Vibration in rapid traverse

[Check items]

1. Vibration amplitude : Check it using the DGN positioning error, the VCMD and TSA signals in a check board.
2. Vibration frequency : Check it using the VCMD and TSA signals in a check board
3. Does the frequency change when the feedrate is changed?

[Adjustment procedure]

Check to see if the vibration in a rapid traverse is caused by a velocity loop or position loop vibration. The position loop vibration appears as hunting. Lower the position gain to correct the position loop vibration. Go to A for velocity loop vibration. Go to B for position loop vibration.

A. If the velocity loop vibrates

A-1 Parameter check

- Check that the load inertia ratio is set correctly.
- Check the parameter when a position loop is set to 1 μm and a velocity loop is set to 0.1 μm .

A-2 Set the velocity loop to PI and decrease the velocity loop gain to about 70% of the original value.

- If the vibration stops, go to cause 1.
- If the vibration does not stop, go to A-3.

A-3 If the vibration frequency is high (150 Hz or higher), validate the torque command filter or observer.

- If the vibration stops, go to cause 2.
- If the vibration does not stop, go to A-4.

A-4 Perform the procedure below.

Acceleration feedback and a velocity loop control cycle of 1 ms

Velocity loop control cycle of 1 ms

- If the vibration stops, go to cause 3.
- If the vibration does not stop, go to A-5.

A-5 Decrease the velocity loop gain until vibration stops.

- Hunting occurs due to too slow velocity loop response. Go to A-6.

A-6 Decrease the position gain until hunting stops. Go to cause 4.

8. DIGITAL SERVO ADJUSTMENT PROCEDURE

B. If the position loop vibrates

B-1 Perform each function below to enhance a velocity loop response.

- Set the velocity loop to PI
- Increase velocity loop proportional gain PK2V in the range where vibration does not occur in velocity loop PI.
- Velocity loop control cycle of 1 ms
- Decrease the velocity loop integral gain PK1V in velocity loop PI.
 - If the vibration stops, go to cause 4.
 - If the vibration does not stop, go to B-2.

B-2 Use a mechanical velocity feedback function for the fully closed loop.

- If the vibration stops, go to cause 5.
- If the vibration does not stop, go to B-3.

B-3 Decrease the position gain. Go to cause 4.

[Causes]

- (1) Vibration and oscillation occur if a velocity loop gain is too high. A velocity loop proportional gain PK2V amplifies a high resonant frequency that the mechanical system has. An integral gain PK1V becomes easy to surge at 20 to 30 Hz if it is set high. Therefore, both PK1V and PK2V should be decreased if vibration occurs due to PK2V. The integral gain must also be decreased at the same time. A velocity loop response deteriorates if the gain is decreased excessively. To prevent the response deterioration, set the velocity loop to PI.

When vibration does not stop even if the velocity loop gain is decreased to about 70%, filter only a high-frequency signal as described in cause 2.

- (2) An observer eliminates high-frequency signals contained in the velocity feedback signal. A torque command filter filters the torque command (final result data) calculated by a velocity loop with a primary low-pass filter.

When the mechanical system has a strong resonance point, the observer and torque command filter prevent the amplification of the resonance of the mechanical system in the control system by making a control system unresponsive to the signals in which the frequency is higher than the resonance point.

The two functions are effective when the resonant frequency is high (150 Hz or higher). When the resonant frequency is lower than 150 Hz, the cutoff frequency of a filter must be set low. This affects badly upon the actual velocity control. The lower limit of an observer's band frequency is 30 Hz (1.5 times velocity loop bandwidth (standard)), and that of a torque command filter's band frequency is about 80 Hz (4 times the velocity loop bandwidth). The torque command filter is valid when the cutoff frequency is set to lower than a half of a vibration frequency.

When the vibration frequency is 300 Hz, set the cutoff frequency of the torque command filter to lower than about 150 Hz. For the relationship between the cutoff frequency and parameter, see Subsection II-2.9.1.

8. DIGITAL SERVO ADJUSTMENT PROCEDURE

- (3) An acceleration feedback function suppresses vibration by calculating acceleration from the motor's velocity feedback and compensating a torque command in accordance with the calculated data. The function is valid when a high-resolution pulse coder is used. When the velocity loop control period is changed from 2 ms to 1 ms, the velocity loop stability is improved. This may suppress vibration. However, the high-frequency gain for the velocity feedback is increased when vibration is higher than 150 Hz. Notice that this may enhance vibration. To control one axis at 1 ms, set the other axis controlled using the same CPU to 1 ms.
- (4) If the velocity loop response to the position gain is slow, the position loop becomes unstable and easy to surge.
To eliminate the surge, there are two methods described below.
- Enhance the velocity loop response.
 - Decrease the position gain.
- Decreasing the position gain is the last method. At first improve the velocity loop response. Decrease the position gain when hunting cannot be improved even if the velocity loop response is improved by various methods
- (5) The position loop often becomes unstable in a fully closed loop machine that has a weak rigidity. A mechanical velocity feedback function improves the stability by using the mechanical velocity as part of the velocity feedback. This function is valid for 9030-1J edition or later.

8. DIGITAL SERVO ADJUSTMENT PROCEDURE

The relationship between a vibration frequency and vibration suppression method is shown below.

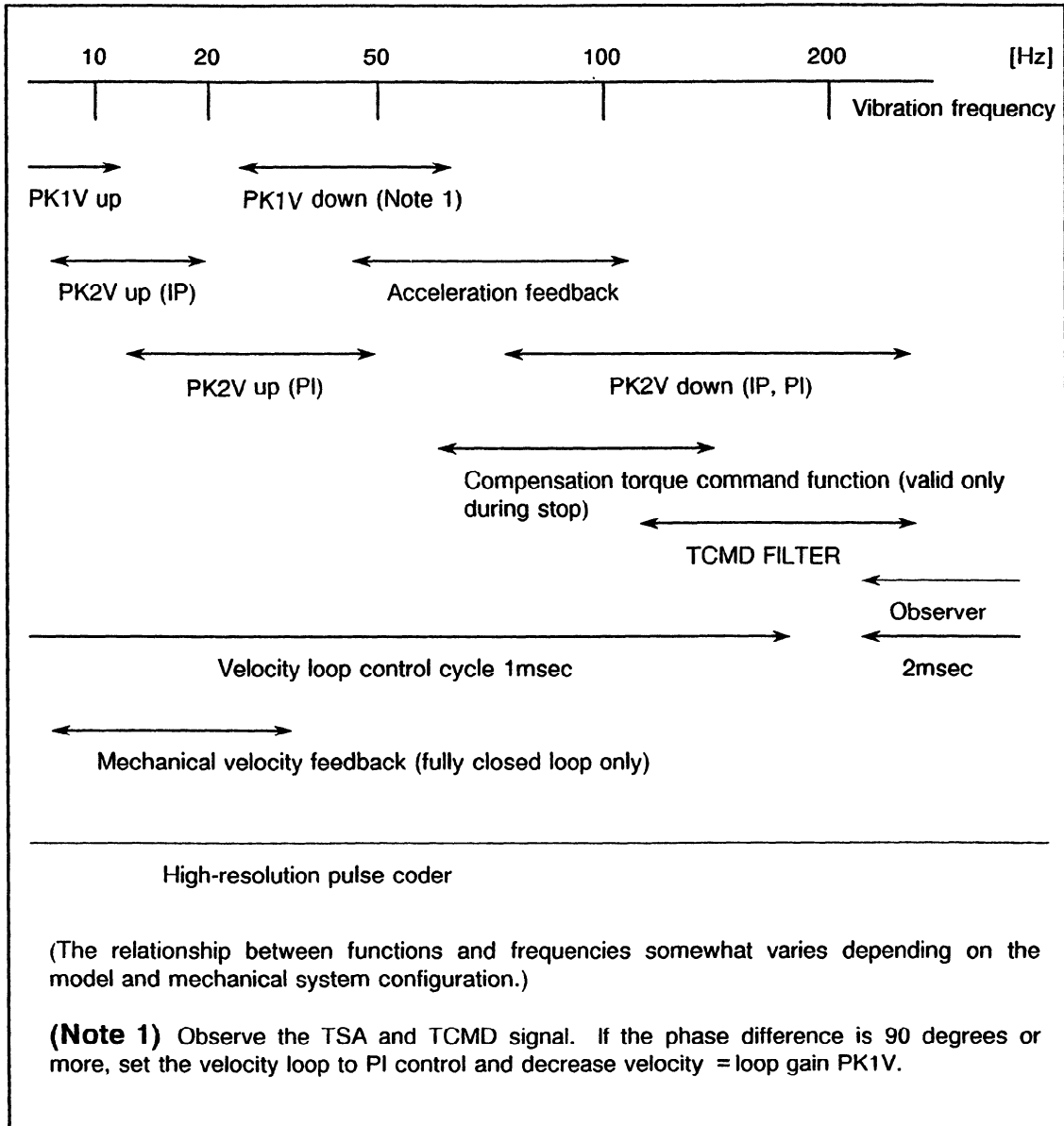

8. DIGITAL SERVO ADJUSTMENT PROCEDURE

8.3.4 Vibration at specified frequency

[Check items]

1. Vibration amplitude : Check it using the DGN positioning error, and the VCMD and TSA signals from a check board.
2. Vibration frequency : Check it using the VCMD and TSA signals from a check board.

[Adjustment procedure]

If a machine vibrates at the specified frequency, the natural vibration in a mechanical system is amplified by a servo system or the vibration cannot be suppressed by the servo system.

Set parameters in accordance with the procedure below.

A. Parameter check

- Check that the load inertia ratio is set correctly.
- Check the parameter when a position loop is set to 1 μm and a velocity loop is set to 0.1 μm .

A-1 Vibration frequency

- Low (lower than 20 Hz). Go to A-2.
- 20 to 100 Hz. Go to A-5.
- Higher than 100 Hz. Go to A-6.

A-2 Decrease the position gain by half.

- If the vibration degree is not improved or deteriorates, go to A-3.
- If the vibration stops, go to B-1.

A-3 (With the position gain returned to the former gain)

Increase velocity loop gains PK1V and PK2V to the level in which the velocity loop does not oscillate.

- If the vibration stops, go to cause 1.
- If the vibration is left, go to A-4.

A-4 Using a velocity loop control cycle of 1 ms, acceleration feedback, and similar measures, increase the velocity loop gain to suppress the oscillation.

- If the vibration stops, go to cause 2.
- If the vibration is left, go to A-8.

A-5 Set the velocity loop to PI control, decrease velocity loop gain PK1V, and check that the vibration stops. If the vibration stops, set velocity loop gain PK1V to about 70% to 80% and increase velocity loop gain PK2V as high as can without vibration.

- If the vibration stops, go to cause 3.
- If the vibration is left yet, go to A-7.

A-6 If the vibration frequency is very high (150 Hz or higher), use a torque command filter or observer. Go to cause 4.

8. DIGITAL SERVO ADJUSTMENT PROCEDURE

A-7 Perform each function below.

- Velocity loop control cycle of 1 ms
- Acceleration feedback

Go to cause 5.

A-8 Examine the use of a high-resolution pulse coder.

Check that there is no problem in the movement or cutting shape for the final set parameter.

B-1 Suppress the position loop hunting referring to the adjustment procedure in Section 8.2.3, B, "If the position loop vibrates."

[Causes]

When a machine and motor vibrate at the specified frequency and the frequency does not change if the feedrate is changed, there are two cases. One is that the mechanical system has its natural frequency and a part of it appears as disturbance. The other is that the control system's characteristic root exists in the position near an easy-to-vibrate right-half plane.

The operation in the servo system against disturbance significantly varies depending on the frequency. The velocity loop band is usually about 20 Hz. The disturbance in which the frequency is lower than a half of 20 Hz is suppressed by the servo system. However, a high-frequency disturbance cannot be suppressed by the velocity loop. The velocity loop sometimes may amplify a part of the disturbance. For this reason, if the motor vibrates or resonates at a specified high frequency, eliminate the high-frequency element contained in a TSA signal using an observer or decrease the velocity loop gain.

- (1) Increase the velocity loop gain to suppress a low-frequency disturbance.
- (2) The velocity loop becomes more stable when a velocity loop of 1 ms and the acceleration feedback function are used. The velocity loop gain can thus be stabilized using these functions.
- (3) If the velocity loop vibrates at 20 to 60 Hz, the cause is mostly due to the lag in the velocity loop integrator. To reduce the integrator lag, set the velocity loop to PI and decrease the integral gain. When the velocity loop is set to PI, no problem is caused even if the velocity loop integral gain is decreased to about 1/2 or 1/3 of the standard value. It is effective to increase velocity loop proportional gain PK2V in the range where no vibration occurs because the velocity loop integrator lag is reduced relatively.
It is also effective to set the velocity loop control period to 1 ms.
- (4) Use a torque command filter or observer to eliminate the high-frequency element contained in a TSA signal.
- (5) A velocity loop period of 1 ms is effective against vibration of 160 to 200 Hz. Acceleration feedback is effective for about 100 Hz.

8. DIGITAL SERVO ADJUSTMENT PROCEDURE

8.3.5 Vibration only during deceleration

[Check items]

1. Vibration amplitude : Check it using the DGN positioning error and the VCMD and TSA signals from a check board.
2. Vibration frequency : Check it using the VCMD and TSA signals from a check board.
3. Current waveform during deceleration : Observe it at the check pin of a servo amplifier.
4. Supply voltage
5. Torque command during deceleration

[Adjustment procedure]

- A-1 Does a current oscillate during deceleration?
- If the current oscillates, go to A-2.
 - If the current does not oscillate, go to A-5.
- A-2 Decrease current loop gain PK1 and PK2 to about 70%.
- If the oscillation stops, go to A-3.
 - If the oscillation does not stop, go to A-5.
- A-3 Is the torque in the high-speed band sufficient? (Does an excess error occur in rapid traverse?)
- If the torque is sufficient, go to cause 1.
 - If the torque is not sufficient, go to A-4.
- A-4 Use the variable speed-dependent current loop gain. Go to cause 2.
- A-5 Return the current loop gain to the former gain and validate the counter electromotive force compensation during deceleration.
- If the vibration stops, go to cause 3.
 - If the vibration does not stop, go to A-6.
- A-6 The velocity loop itself may vibrate.
Set the velocity loop parameter referring to Sections 8.3.2 through 8.3.4.

[Causes]

- (1) The current loop parameter does not oscillate for an input voltage of 110% of rated voltage. However, the current loop becomes easy to oscillate when the supply voltage rises abnormally (especially during deceleration).
In this case, decrease the current loop gain. If the output torque in the high-speed band is sufficient, the current loop gain setting causes no problem.

8. DIGITAL SERVO ADJUSTMENT PROCEDURE

- (2) If the torque in the high-speed band is insufficient and the current loop oscillates during deceleration and velocity loop gains PK1 and PK2 should be decreased. The current loop gain must be increased in the high-speed band during acceleration and in the stationary state.

This can be performed using the speed-dependent current loop variable function.

- (3) The counterelectromotive force compensation is a software function that compensates the counterelectromotive force generated by motor rotation. The compensation is only done during acceleration and in the stationary status, but not during deceleration. When a torque command becomes almost 0 in the large-friction axis or vertical axis, the sign of the torque command is continuously reversed near 0. The counterelectromotive force is thus compensated irregularly. This disturbs pulse-width modulation (PWM). The current and velocity loops may then oscillate. In this case, validate the counterelectromotive voltage compensation during deceleration to eliminate the oscillation.

8.3.6 Vibration occurs after move command entry, but not after energization only

[Check items]

1. Vibration amplitude
: Check it using the DGN positioning error and the VCMD and TSA signals from a check board.
2. Vibration frequency
: Check it using the VCMD and TSA signals from a check board.
3. How many pulses are included in the move command which causes vibration?
: Enter the move command using a manual pulse.

[Adjustment procedure]

If the motor operates with vibration when a move command is entered, go to A.

If the motor vibrates and then stops halfway when a move command is entered, go to B.

- A. If the motor operates with vibration when a move command is entered

If the velocity loop vibrates when a move command is entered, adjust the velocity loop referring to Subsections 8.3.1, "Vibration during stop," 8.3.2, "Vibration in low-speed feed", and 8.3.3, "Vibration in rapid traverse."

- B. If the motor vibrates and then stops halfway when a move command is entered

This is not due to a parameter adjustment error, but a pulse coder fault, its disconnection error or power line fault. Check that the phase C signal in pulse coder is output correctly, the feedback cable is not disconnected, or the motor power line is connected correctly. If faults are found, replace. Go to causes 1 and 2.

8. DIGITAL SERVO ADJUSTMENT PROCEDURE

[Causes]

- (1) If the phase C signal in pulse coder is not output correctly.
 - If phase C is shifted 90 degrees or more, the motor runs out of order when energized and stops when an excess error occurs.
 - If low-order bits C1 and C2 in phase C are twisted, the motor rotates, but 64 torque ripples per revolution appear.
 - If phase C is shifted 90 degrees or less, the torque in the high speed range is reduced.
 - The motor may vibrate and stop when a move command is entered.

- (2) If a power line is removed or broken, or the power line is twisted, there will be a position every 90 where the motor cannot move.
 - The motor vibrates and stops in the corresponding position when a move command is entered. Hunting occurs when the motor is accelerated rapidly. In any case, check the power line or motor winding.

8. DIGITAL SERVO ADJUSTMENT PROCEDURE

8.4 Adjustment Procedure for Drift (Erratic Movement)

8.4.1 Drift during stop state

[Check items]

1. Drift amplitude : Check the amplitude using the dial indicator or by referring to DGN position deviation.
2. The number of drift vibrations : Check it by referring to the TSA waveform or VCMD waveform of the check board.
3. Machine backlash
4. Is a disturbance source such as a fan or hydraulic pump located nearby?
If yes, what is its frequency?

[Adjustment procedure]

1. Place the velocity loop under PI control to set the velocity loop integral gain PK1V to 0.
 - If no drift is observed, go to A-1.
 - If the level of drift remains unchanged or becomes worse, go to B-1.
- A-1 Place the velocity loop under PI control to set the velocity loop integral gain to about a half of the original value.
 - If no drift is observed, go to cause 1.
 - If a drift still remains, go to A-2.
- A-2 Enable the overshoot compensation function (See Section II-2.4), and set PK3V to a value from about 32000 to 20000.
 - If not drift is observed go to cause 2.
 - If a drift still remains, go to A-3.
- A-3 Enable the incomplete integral function after disabling the overshoot compensation function, and make an adjustment by setting PK3V to a value from about 32760 to 32000.
 - If the cumulative positioning error during the stop state is close to one pulse, go to Cause 3.
 - If the delay during stop state is large, go to A-4.
- A-4 Increase the velocity loop integral gain PK1V.
If a vibration occurs at this time, increase the value of PK1V to a maximum extent according to Section 8.3. Go to cause 4.
- B-1 Increase the load inertia ratio (LDINT) to the highest value that does not cause velocity loop vibration.
 - If no drift is observed, go to cause 5.
 - If a drift still remains, go to B-2.

8. DIGITAL SERVO ADJUSTMENT PROCEDURE

B-2 Set the velocity loop control cycle to 1 ms, and further increase the velocity loop gain without causing velocity loop vibration.

- If no drift is observed, go to cause 5.
- If a drift still remains, go to B-3.

B-3 Consider a countermeasure for the vibration source or mechanical system. Go to cause 6.

[Causes]

The word "drift" used here represents a drift with a velocity loop frequency lower than about 20 to 30 Hz. For a higher-frequency, see Section 8-3.

A machine drift during stop state can occur due to two major causes. One cause is the velocity loop integrator; in this case, a drift is caused by the control system itself. The other is a large disturbance that cannot be suppressed by the motor to prevent a machine drift. In the former case, decreasing the velocity loop gain during stop state is generally useful to prevent a drift. In the latter case, however, the velocity loop gain must be increased to make the velocity loop more immune to disturbance.

So it is most important to identify the cause of a drift. One way is to remove the integrator from the velocity loop. If a drift is eliminated by doing so, the cause lies in the control system. In this case, a drift is closely associated with an overshoot, so closely examine [Causes] in Subsection 8.5.1.

- (1) A smaller integral gain under PI control decrease the value of the integrator during the stop state, thus reducing the level of drift.
- (2) Overshoot compensation can reduce the position deviation to 0, and can also decrease the value of the integrator of the velocity loop toward 0. So with the torque command being 0 when the position deviation is 0, the machine can stop in that position by friction force.
- (3) When an excessive overshoot occurs, the position deviation may become 0 only momentarily, thus theoretically disabling overshoot compensation. In such a case, no means are available except incomplete integral throughout the entire area.
- (4) When incomplete integral is used, velocity loop control is similar to analog servo control; some position deviation always remains at stop time. The position deviation value is inversely proportional to the value of PK1V if the value of PK3V is constant. So increase the value of PK1V to a maximum extent without causing vibration.
- (5) When the machine drifts due to external force even if the servo system attempts to suppress the drift, the velocity loop gain needs to be increased to make the machine immune to disturbance. In this case, the velocity loop must be stable and free from vibration. See the description of the adjustment procedure in Section 8.3 to increase the velocity loop gain without causing vibration.

8. DIGITAL SERVO ADJUSTMENT PROCEDURE

- (6) When a disturbance such as from a hydraulic pump is extremely strong, the servo system may not be able to fully eliminate its effect. In such a case, consider a countermeasure for the vibration source and mechanical system.

8.4.2 Drift low speed feed

[Check items]

1. Drift amplitude : Check the amplitude using the cutting surface or by referring to DGN position deviation.
2. The number of drift vibrations : Check it by referring to the TSA waveform or VCMD waveform of the check board (to see if it is proportional to the velocity).
3. Pitch if a scale is provided
4. Effect of the cut surface

[Adjustment procedure]

- A-1 When a scale is provided, does the drift cycle match the scale pitch or a half of the pitch?
- If there is a match, go to cause 1.
 - If there is no match, go to A-2.
- A-2 Place the velocity loop under PI control.
- If the drift is reduced to an allowable level, go to cause 2.
 - If a drift still remains, go to A-3.
- A-3 Set the velocity loop interrupt period to 1 ms, and further increase the velocity loop gain without causing vibration.
- If the drift is reduced to an allowable level, go to cause 2.
 - If a drift still remains, go to A-4.
- A-4 In very low speed feed, check whether the irregularity of drift matches the irregularity of NC distribution?
- If there is a match, go to cause 3.
 - If there is no match, go to A-5.
- A-5 Check the number of irregularities per motor revolution.
- If irregularities dependent on motor rotation are observed, go to A-6.
 - If irregularities are observed regardless of motor rotation, go to A-7.
- A-6 Make the same adjustment as described in Section 8.7.
- A-7 Disturbance is probably the cause. Suppress disturbance by increasing the velocity loop gain to a maximum extent without causing vibration.

[Causes]

A machine drift at low speed feed can occur due to two major causes. One is a command irregularity or position detection system irregularity, which affects a velocity command itself.

8. DIGITAL SERVO ADJUSTMENT PROCEDURE

Without eliminating this cause, no velocity loop parameter adjustment can solve the problem. The other is a motor torque irregularity or machine system irregularity. This cause is regarded as disturbance for the velocity loop, so a velocity loop adjustment can be made for improvement to some extent.

- (1) If an irregularity exists with a fully closed loop system due to a poor adjustment, the machine also makes an erratic movement. The DGN position deviation is stable in very low speed operation because the machine fully catches up with the scale. However, the machine actually makes erratic movements. As the velocity increases and the scale irregularity frequency exceeds the position loop range, the DGN position deviation begins drifting. In addition, the VCMD waveform begins rolling accordingly. In any case, a poor scale adjustment can adversely affect the cut surface quality, and no parameter adjustment can solve the problem. The scale must be provided by its supplier with a manual for adjustment. Make an adjustment according to the manual or ask the MTB to make an adjustment.
- (2) If a machine drift occurs for a cause such as a disturbance (or motor torque irregularity), the drift can be reduced by improving the response of the velocity loop and thus enhancing immunity to disturbance. For this purpose, place the velocity loop under PI control and set the velocity loop control cycle to 1 ms. Set the velocity loop gain to the highest possible stable level; however, a margin must be left to prevent vibration.
- (3) When extremely slow feeding is required on a taper surface, for example, along the axis in question, an NC distribution irregularity may directly cause a feed drift. In such a case, there is no fundamental solution other than setting a much finer detection unit and minimum setting unit.

8.4.3 Drift in rapid traverse acceleration/deceleration

[Check items]

1. Drift amplitude : Check it by referring to the DGN position deviation or the VCMD waveform from the check board.
2. Drift duration : Check it by referring to the TSA waveform or VCMD waveform of the check board.
3. Frequency of a drift when it lasts : Check it by referring to the TSA waveform or VCMD waveform from the check board (to see if the frequency is proportional to the feedrate).
4. Any sound

[Adjustment procedure]

First, see Subsection 8.3.3. As described in the section, check whether the vibration (drift) is caused only by the velocity loop or by the position loop.

The adjustment procedure described in Subsection 8.3.3 is applicable here.

8. DIGITAL SERVO ADJUSTMENT PROCEDURE

8.5 Adjustment Procedure for Overshoot

8.5.1 Overshoot in 1-pulse feed and 10-pulse feed

[Check items]

1. Overshoot in 1-pulse feed
2. Overshoot in 10-pulse feed
3. Movement after overshoot
 - Does the machine immediately return or does a drift occur?
 - If a drift occurs, how long does it last?
4. Waveform of the torque command when 1-pulse feed and 10-pulse feed are performed

[Adjustment procedure]

Before making an overshoot adjustment, the mechanism of the servo system in 1-pulse feed and 10-pulse feed operation must be first understood. Section II-2.4 is useful to understand the mechanism.

A-1 Place the velocity loop under PI control.

- If no overshoot is observed, go to cause 1.
- If an overshoot still occurs, go to A-2.

A-2 Increase the proportional gain of the velocity loop (by about 1.5 times) without causing vibration.

- If no overshoot is observed, go to cause 2.
- If an overshoot still occurs, go to A-3.

A-3 Set the velocity loop control cycle to 1 ms, and increase PK2V.

- If no overshoot is observed, go to cause 3.
- If an overshoot still occurs, go to A-4.

A-4 Return the gain to the original value, and enable the overshoot compensation function. (When using the overshoot compensation function, adjust PK3V within a range of about 32000 to 20000.)

- If no overshoot is observed, go to cause 4.
- If no overshoot is observed, but a drift during stop state is unsatisfactory, go to A-5.
- If no overshoot appears to occur, but an overshoot actually occurs somewhere or sometimes, go to A-6.

A-5 Use the improved version of the overshoot compensation function (which holds the torque command halfway instead of dropping it to 0 in overshoot compensation). Go to cause 5.

8. DIGITAL SERVO ADJUSTMENT PROCEDURE

A-6 Use the incomplete integral function without performing overshoot compensation. when using the incomplete integral function, adjust PK3V within a range of about 32760 to 32000.

- If the positioning error level during stop state is allowable, go to cause 6.
- If the positioning error level during stop state is not allowable, go to A-7.

A-7 Increase the velocity loop integral gain PK1V.

When vibration occurs at this time, perform setting to maximize PK1V while suppressing vibration according to Section 8.3. Go to cause 7.

[Causes]

In general, the maximum static friction of a machine observed when it begins moving from its stationary state is always greater than its kinetic friction. In 1-pulse or 10-pulse feed, the initial state is the stop state, and the value of the velocity loop integrator gradually increases. Then when the torque command has exceeded a maximum static friction level, the motor begins rotation. With a digital servo system, the value of the integrator is preserved without modification.

When the motor output torque corresponding to the value of the integrator is greater than the kinetic friction of the machine, the machine (motor) cannot stop, resulting in overshoot. This means that to eliminate overshoot in 1-pulse feed and 10-pulse feed, a large difference must be provided between the torque command value immediately before the machine moves and the torque command value immediately after the machine moves. (For detailed information, see Section II-2.4.)

- (1) When the velocity loop is placed under IP control, the torque command value immediately before the machine moves is the value of the integrator itself. On the other hand, when PI control is used, the value is (value of integrator + forward proportional). The torque for starting a machine is constant regardless of the control system. So if PI control is used, the motor starts operation when the value of the integrator is smaller. For this reason, the torque command value immediately after the machine moves becomes smaller, resulting in less overshoot. (See Subsection II-2.4.1.)
- (2) When a larger proportional gain is used under PI control, the contribution of the proportional to the torque command value before the machine moves becomes larger; on the other hand, a smaller integrator contribution results. So less overshoot occurs for the reason described above.
- (3) When the velocity loop control cycle is changed from 2 ms to 1 ms, less overshoot occurs even with the equivalent gain. In addition, a shorter control cycle raises the oscillation limit, so that the response of the velocity loop can be improved in a stable manner.

8. DIGITAL SERVO ADJUSTMENT PROCEDURE

- (4) The overshoot compensation function performs a complete integral calculation with the integrator as usual when the positional deviation is not 0. When the position deviation is 0, the overshoot compensation function performs an incomplete integral calculation. With this function, when the machine or motor has reached a designated position, the value of the integrator decreases toward 0, thus reducing overshoot. This function, unlike the ordinary incomplete integral function, applies incomplete integral only to the stop state. So the value of PK3V can be decreased, and overshoot can be reduced without affecting cut surface quality.
- (5) As explained in Item (4) above, the overshoot compensation function ultimately reduces the torque command value at stop time to 0. This means that when disturbance is applied to the machine or motor, a drift occurs within a range of +1 pulse as detectable by the detector. In some cases, such a drift is felt as vibration. In such a case, use the improved version of the overshoot compensation function, which does not reduce the torque command value beyond a certain point. (See Section II-2.4.)
- (6) When an excessive overshoot occurs, such a state where the position deviation becomes 0 can occur only momentarily, thus theoretically disabling overshoot compensation (from the viewpoint of probability). In such a case, no means are available except incomplete integral throughout the entire area.
- (7) When incomplete integral is used, velocity loop control is similar to analog servo control; some position deviation always remains at stop time. The positional deviation value is inversely proportional to the value of PK1V if the value of PK3V is constant. So increase the value of PK1V to a maximum extent without causing vibration.

[Note]

As described above, making the effect of the integrator smaller is theoretically useful for reducing overshoot. However, such a situation as explained below may occur.

With a machine that has a larger backlash, when its motor overshoots, no machine overshoot occurs as long as the motor overshoot lies within the backlash. In this case, if even a slight motor overshoot occurs, the overshoot can be compensated immediately with the velocity loop by using a higher integral gain. Thus machine overshoot can be eliminated.

8. DIGITAL SERVO ADJUSTMENT PROCEDURE

8.5.2 Overshoot at rapid traverse or cutting positioning

[Check items]

1. Overshoot at positioning : Check with the positioning error and the VCMD waveform from the check board.
2. Torque command at overshoot : Check with the check board.
3. Position gain and time constant : Check the parameters.

[Adjustment procedure]

A-1 Check the parameters.

Check whether parameters such as the velocity loop gain, position gain, and acceleration/deceleration time constant are correct.

- If a parameter is incorrect, go to cause 1.
- If the parameter are correct, go to A-2.

A-2 Check whether the torque command is saturated.

- If it is saturated, go to A-3.
- If it is not saturated, go to B-1.

A-3 Increase the acceleration/deceleration time constant.

Go to cause 2.

B-1 Make an adjustment by using the same procedure as A-1 to A-7 of Subsection 8.5.1 to eliminate overshoot at positioning time.

- If overshoot cannot be eliminated, go to B-2.

B-2 Increase the acceleration/deceleration time constant. Go to cause 3.

[Causes]

If an overshoot occurs at rapid traverse, the cause is a position loop request (that is, velocity command (i.e., position gain \times position deviation), not satisfied by the velocity loop, which is a minor loop of the position loop. The response of the velocity loop or the saturation of the torque command prevents the velocity loop from satisfying the request.

- (1) If position gain setting or velocity loop gain setting is incorrect, an overshoot can occur even when no vibration is produced.
- (2) When the torque command is saturated, the system response is determined only by the acceleration or deceleration capability of the motor regardless of the velocity loop control system (parameters). To prevent overshoot in such a case, available means are limited. An increased rapid traverse time constant must be used, or a model with a larger motor must be employed.
- (3) Overshoot may not be eliminated even by improving the velocity loop response as described above. In such a case, available means are limited. An increased rapid traverse time constant must be used, or a model with a larger motor must be employed.

8. DIGITAL SERVO ADJUSTMENT PROCEDURE

8.5.3 Overshoot in positioning with manual pulses when the backlash acceleration function is used

[Check items]

1. Overshoot measured with a dial indicator or other instruments
2. Overshoot examined by referring to the DGN position deviation

[Adjustment procedure]

A-1 Disable the backlash acceleration function.

- If no overshoot is observed, go to A-2.
- If an overshoot still remains, go to A-1 of Subsection 8.3.1.

A-2 Enable the backlash acceleration function only for cutting. Go to cause 1.

However, the following servo ROM series/version is needed:

9010/001G or later

9020/001J or later

9030/001F or later

9040/001A or later

Note that this function cannot be used for NC or Series 10.

[Causes]

- (1) The backlash acceleration function is used to eliminate quadrant protrusions in arc cutting and so forth. Usually, this function is activated even when no cutting operation is performed. So a problem may arise with positioning using the handle. To prevent such trouble, the backlash acceleration function is enabled during cutting operation only. For Series 10, however, this function cannot be used. This is because the NC does not indicate to the servo system whether cutting operation is being performed or not. For detailed information about setting, see Subsection II-2.5.2.

8. DIGITAL SERVO ADJUSTMENT PROCEDURE

8.5.4 Overshoot when feedforward is applied

[Check items]

1. Overshoot when feedforward is applied : Check with the positioning error.
2. Torque command when overshoot occurs : Check with the check board.
3. Position gain and time constant : Check the parameters.

[Adjustment procedure]

A-1 Check the parameters.

Check whether parameters such as the velocity loop gain, position gain, and rapid traverse time constant are correct.

- If a parameter is incorrect, go to cause 1.
- If the parameters are correct, go to A-2.

A-2 Check the positional deviation.

Check whether the positional deviation when feedforward is applied conforms to a calculated value.

- If it does not conform to a calculated value, check the feedforward coefficient (Subsection II-2.5.1).
- If it conforms to a calculated value, go to A-3.

A-3 Is the torque command saturated?

- If it is saturated, go to A-4.
- If it is not saturated, go to A-5.

A-4 Increase the cutting feed time constant, or decrease the feed forward coefficient. Go to cause 2.

A-5 Apply velocity loop feedforward (with the 9030/l version or later or the 9040/A version or later).

- If no overshoot is observed, go to cause 3.
- If an overshoot still remains, go to A-6.

A-6 Improve the response of the velocity loop according to the adjustment procedure described in Subsection 8.5.2.

- If no overshoot is observed, go to cause 4.
- If an overshoot still remains go to A-7.

A-7 Increase the cutting feed time constant, or decrease the feedforward coefficient. Go to cause 5.

8. DIGITAL SERVO ADJUSTMENT PROCEDURE

[Causes]

As in the case of rapid traverse, overshoot occurring when feedforward is applied is caused by the inability of the velocity loop to satisfy a position loop request. So the servo parameter adjustment as described in Subsection 8.5.2 must be made. However, there is one exception; for the type of overshoot described in this section, the method of adjustment when the torque command is saturated involves the cutting feed time constant and feedforward coefficient.

- (1) If position gain setting or velocity loop gain setting is incorrect, an overshoot can occur even when no vibration is produced.
- (2) The torque command becomes saturated when feedforward is applied, while the torque command is not saturated when feedforward is not applied. In such a case, increase the cutting feed time constant or decrease the feedforward coefficient so that the torque command will not be saturated. In any case, however, a larger cutting shape error is introduced. So perform setting by using information in Subsection II-2.5.1.
- (3) Applying velocity loop feedforward improves the response of the velocity loop to commands, thus eliminating overshoot.
- (4) Even if the torque command is not saturated, overshoot can occur due to slow response of the velocity loop. In such a case, overshoot can be reduced by improving the response of the velocity loop.
- (5) If an overshoot still remains after improving the response of the velocity loop to a maximum extent just before oscillation starts, increase the cutting feed time constant or decrease the feedforward coefficient.

8.6 Adjustment Procedure for Erratic Movement

8.6.1 Erratic movement in 1-pulse feed

[Check items]

1. Actual machine movement in 1-pulse feed : Check with a dial indicator or other instruments.
2. Position deviation change in 1-pulse feed : Check with the DGN.
3. Torque command change in 1-pulse feed : Check with the check board.

[Adjustment procedure]

- A-1 When an erratic movement occurs, is the position deviation in 1-pulse feed 0?
- An erratic movement occurs even when the position deviation is always 0. Go to A-2.
 - A position deviation remains, depending on how an erratic movement occurs. Go to A-4.
- A-2 Check whether an overshoot occurs.
- If an overshoot occurs, go to A-3.
 - If no overshoot is observed, go to A-4.
- A-3 By referring to Subsection 8.5.1, eliminate any overshoot, and enable the VCMD offset function. Go to cause 1.
- A-4 When using the incomplete integral function, increase PK3V (close to 32767) as long as no malfunction occurs.
- A-5 Increase the velocity loop gain PK1V without causing vibration.
- If no erratic movement occurs, go to cause 2.
 - If an erratic movement occurs, go to A-6.
- A-6 Set the velocity loop control cycle to 1 ms. Then, by using a function such as the compensation torque command function, increase PK1V to the highest value that does not cause velocity loop vibration.
- If no erratic movement occurs, go to cause 2.
 - If an erratic movement occurs, go to A-7.
- A-7 It appears that erratic movement cannot be eliminated by servo parameters alone. Consider a machine adjustment.

8. DIGITAL SERVO ADJUSTMENT PROCEDURE

[Causes]

When no erratic movement is observed with the DGN position deviation, 1-pulse commands actually move the machine by 0, 2, 0, 2 in some cases. Assume that the machine is stopped near an end of a unit of the 1-pulse grid of the detector. When the machine moves to the nearer grid by 1 pulse, a shorter time is required for acceleration. This means that the machine movement is decelerated by friction force immediately after the machine passes to the next unit of the grid at low speed. For this reason, the machine appears to have moved by almost no distance (from 2 to 3 in the figure below) even if the positional deviation is 0 both before and after the machine moves.

On the other hand, when the machine moves to the farther grid by 1 pulse, a longer distance must be covered. This means that machine is accelerated too far by the motor, so that the machine stops at a point in the next unit farther than the previous point (for example, from 1 to 2 in the figure below). In some cases, the machine may overshoot, then return. In such a case, the machine stops at a farther point than the previous point (for example, from 3 to 4 to 5 in the figure below).

So the machine appears to have moved by two pulses even if the positional deviation is actually 0 both before and after a move command is entered. This tends to occur when an overshoot occurs, so make an adjustment to remove overshoot.

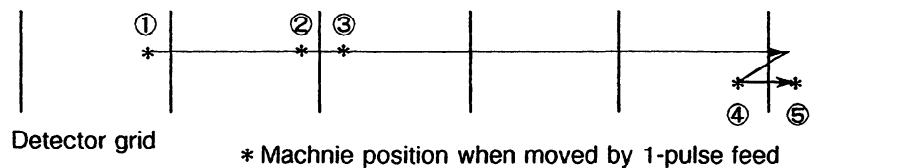

The VCMD offset function adds a 0.5 pulse to the normal velocity command (VCMD). When the position deviation is 0, the VCMD offset function gradually moves the machine in the positive direction. When the machine moves into the next grid unit, the position deviation becomes -1, and the velocity command functions to provide -0.5 pulse move, moving the machine in the negative direction.

Thus the VCMD offset function shifts the positional deviation from 0 to 1 or 1 to 0. However, a position closest to the grid position is eventually reached due to mechanical friction. In this case, the DGN position deviation is unstable, that is, shifting between 1 and 0, but the actual movement is very small. One-pulse feed operation performed in this state can move the machine one pulse at a time precisely.

- (1) The machine may make an erratic movement, and position deviation may not become 0 accordingly. To suppress such an erratic movement, increase the torque command caused by a 1-pulse position deviation, by increasing the velocity loop gain.

8. DIGITAL SERVO ADJUSTMENT PROCEDURE

8.7 Adjustment Procedure for Cut Surface

Classification of unsatisfactory cut surfaces

Unsatisfactory cut surfaces can be classified into several groups. Each group requires a different set of check items and countermeasures.

[Classification]

1. Which feed operation is used for straight cutting, single-axis linear feed or two-axis linear feed?

Go to Subsection 8.7.1 if an unsatisfactory cut surface occurs only with two-axis feed.

Go to Subsection 8.7.2 if a poor cut surface occurs with both single-axis feed and two-axis feed.

8.7.1 Cut surface occurring only with two-axis linear feed

Most unsatisfactory cut surfaces occurring only with two-axis linear feed are due to a malfunction in the feed system.

[Check items]

1. In general, unsatisfactory cut surfaces caused by a feed system malfunction are related to a machine position.

To confirm that an unsatisfactory cut surface is not caused by vibration, change the feedrate within such a range (up to 20%) that there appears no change in work movement. (If the work is fed every minute, change the feedrate. If the work is fed per rotation, change the feed amount.)

If the feed system malfunctions, the cut surface pitch does not change with a small change in feed. If the pitch changes, it may be an unsatisfactory cut surface that can occur even with single-axis feed described in Subsection 8.7.2.

2. Regard the stripes of a cut surface as contour lines viewed from one of the axes, and calculate the interval between adjacent contours.

Example: Stripes occurring at intervals of 1 mm appear in the case of cutting with an inclination of 15 degrees ($X = 1$, $Y = \tan(12)$).

The stripes can be viewed as contour lines along the X axis occurring at intervals of about 0.97 mm ($= 1 \text{ mm} \times \cos(15)$) or as contour lines occurring at intervals of about 0.26 mm ($= 1 \text{ mm} \times \sin(15)$) along the Y axis.

Whether stripes are occurring along the X axis or Y axis can be determined by checking whether the stripe interval is enlarged or reduced when the inclination is changed to 10 degrees or 20 degrees.

8. DIGITAL SERVO ADJUSTMENT PROCEDURE

Example: The interval is enlarged with an inclination of 10 degrees ($X = 1$, $Y = \tan(10)$).

If contour lines along the X axis occurring at intervals of 0.97 mm are assumed, the interval of stripes should not change significantly because $0.97 + \cos(10) = 0.98$ mm.

On the other hand, the interval of stripes along the Y axis is enlarged because $0.26 + \sin(10) = 1.49$ mm.

When contour lines along the X axis are assumed, changing the inclination to about 45 degrees produces a change of 1.4 mm ($= 0.97 \text{ mm} + \cos(45)$).

If the interval of stripes does not change as the interval of contour lines changes, then check the possibility of an unsatisfactory cut surface described in Subsection 8.7.2.

3. Confirm a calculated axis/interval with the check board.

If a probability is found that there is an erratic movement occurring at intervals of 0.26 mm along the Y axis, perform single-axis feed operation at such a feedrate that the interval of 0.26 mm is equivalent to 20 Hz, then check VCMD with the oscilloscope.

$$0.26 \text{ mm} \times 20 \times 60 \doteq F300$$

If a stripe repetition rate of 20 Hz is confirmed with a feedrate of F300, the interval of contour lines is determined to be 0.25 mm. In the case of 17.7 Hz, the interval of stripes is determined to be 0.283 mm. (It is less accurate than imagined to read an interval by checking the work visually.)

Go to Adjustment procedure upon confirmation.

4. When irregularity cannot be checked with the check board

Even if the interval of contour lines is identified, the corresponding irregularity may not be observed with the check board.

In such a case, there is a possibility that the servo system is not responsible for the poor cut surface. So check to see if the cut surface becomes worse when the servo gain is intentionally lowered.

With a digital servo system, decrease PK1V to a half. (With an analog servo system, set the RV1 scale value to 0.)

If the cut surface does not get worse when the gain is lowered, there is a high probability that the mechanical system beyond the servo system is responsible. So check with the manufacturer to see if there is any mechanical factor that corresponds to the contour lines.

8. DIGITAL SERVO ADJUSTMENT PROCEDURE

Possible mechanical factors:

1. Gear transfer irregularity when gear coupling is used
2. Transfer irregularity when a timing belt is used
3. Ball screw/nut runout
4. Poor vertical axis counterbalance (Destroy the balance intentionally)
In any case, it is necessary to determine the relationship between the amount of movement and the number of irregularities per revolution of a rotational element.
5. When a separate detector such as a scale is used
When a separate detector such as a scale is used, a malfunction of such a detector can cause an unsatisfactory cut surface. To check this type of cause, switch to semi-closed loop setting by specifying parameters, then check according to Item 3 above. If no irregularity can be observed, ask for a scale check.
Section II-2.12 details the scale.

[Adjustment procedure]

In general, an adjustment is made to suppress irregularity by increasing the gain of the velocity loop.

A particular number of irregularities per revolution may depend on a particular cause, so it is also to be checked.

A-1 Increase the integral gain (PK1V) in 50% steps.

- If there is an improvement, but vibration starts at stop time, go to A-2.
- If there is an improvement, but hunting occurs in JOG feed, go to B-1.
- If a worse cut surface results, go to C-1.
- If an improvement is made, go to cause 1.

A-2 Change the velocity loop control cycle to 1 ms.

(Change the setting of the other mate axis at the same time.)

- If vibration cannot be stopped, go to A-3.

A-3 Use the 1-pulse suppress function.

- If vibration cannot be stopped, go to A-4.

A-4 Set PK2VAUX to about 100 to 200 (with a 2000 to 3000P pulse coder).

- If vibration still occurs, decrease PK1V to a level where no vibration occurs.
Ultimately, find a trade-off between cut surface quality and vibration.

B-1 Increase the proportional gain (PK2V) by 50%.

- If vibration starts at stop time, go to A-2.
- If hunting is stopped, go to A-1.

8. DIGITAL SERVO ADJUSTMENT PROCEDURE

- C-1 When the cycle of erratic movement is 30 Hz or higher, increasing the integral gain often makes the situation worse. In this case, change the velocity loop control cycle to 1 ms.
- If an improvement is made compared with the previous processing in which 2 ms is set, go to A-1.
 - If no improvement is seen, go to C-2.
- C-2 Change the velocity loop for PI setting, and decrease the integral gain (PK1V) by about 50%.
- If no substantial change is seen, go to D-1.
 - If an improvement is made, go to cause 2.
- D-1 Increase the proportional gain to 50%.
- If an improvement is made, but vibration starts at stop time, go to A-3.

[Causes]

- (1) When a relatively slow feedrate is used (the number of motor revolutions is about 20 rpm or less), erratic movement can be suppressed for a smoother cut surface by increasing the velocity loop gain of the servo system. (Increasing the gain can improve an irregularity of up to about 20 Hz.)

If an improvement is made by increasing the gain, the cause may be a smaller gain. If possible, however, it is important to remove a factor such as a torque irregularity that caused the erratic movement. On the other hand, check for possibility that the mechanical system can also cause a torque irregularity.

- (2) If an irregularity is corrected by decreasing PK1V (integral gain), the cause is a compensation delay associated with the integrator.

When a lower integrator gain is used, a less sensitive servo system results. However, a lower integrator gain prevents the servo system from excessively responding to a 50- to 200-Hz disturbance, thus suppressing those irregularities associated with the frequencies.

However, this also means a lower gain for suppressing a 0- to 20-Hz irregularity, and a deteriorated startup response. So a close check is required to avoid these adverse effects that can be produced by a lower gain.

8. DIGITAL SERVO ADJUSTMENT PROCEDURE

8.7.2 Cut surface occurring even with single-axis feed

An unsatisfactory cut surface occurring even with single-axis feed is often caused by mechanical system vibration (not associated with a feed axis). Mechanical vibrations can be classified as vibrations synchronized with the number of revolutions of the spindle, vibrations that always have a constant frequency, and vibrations associated with a particular position.

[Check items]

1. Check the servo error of an axis that is not moving.

For a cut surface check in the case of single-axis feed, it is assumed that an axis that is not moving is completely stopped.

By checking the DGN servo error at cutting time, confirm that an axis that is not moving is completely stopped.

If a drift is observed, check its environment, and also check the relationship with the interval of the cut surface.

2. Change the spindle rate.

In the case of feeding per rotation, check that the same results can be obtained by switching to the feeding performed every minute that has the equivalent rate. Then check with feeding performed every minute. When peripheral velocity control is used, match the velocity with the rate of feeding performed every minute at a location where a poor cut surface is produced.

Change the number of spindle revolutions to such an extent (up to 20%) that the status of work does not change substantially when visually checked.

If the interval of the cut surface changes as a result, and such a change is inversely proportional to the number of spindle revolutions, the interval of the cut surface is determined to match some cutter mark interval. That is, the cause is assumed to be a vibration synchronized with the number of spindle rotations. Go to item (1).

If the cut surface interval is not inversely proportional to the number of spindle rotations (the interval widely changes or is lost in some cases), there is a higher probability that the unsatisfactory cut surface is caused by a vibration with a constant frequency. Go to item (2).

In rare cases, the cut surface interval does not change even if the number of spindle rotations is changed in feeding performed every minute. In such a case, the cut surface may be associated with a particular position. By parallel displacement of the work, check if the cut surface occurs in the same position of the machine.

8. DIGITAL SERVO ADJUSTMENT PROCEDURE

(1) Cut surface caused by vibration synchronized with spindle rotation

An unsatisfactory cut surface caused by vibration synchronized with spindle rotation has the features described below.

This type of cut surface appears when cutting, such as turning or boring, where the same part of a cutter cuts a workpiece. When a tool cuts a workpiece intermittently as in the case of milling, check other cases.

- (a) A spiral cut surface is always produced.
With face turning, a spiral cut surface appears. With boring or cylindrical turning, a screw-like cut surface appears.
- (b) When N disturbance vibrations occur per spindle rotation, the following cut surfaces appear:
 - N = about 0.8 to 1.2: Single-thread spiral
 - N = about 1.8 to 2.2: Dual-thread spiral
 - N = about 2.8 to 3.2: Triple-thread spiral
 - N = about 3.8 to 4.2: Quadruple-thread spiral
- (c) At this time, the interval of a cut surface is based on the number of cutter marks which is determined as the reciprocal of the fraction of N:
 - When N = 0.9: Single-thread spiral, every 10 cutter marks, same spiral as cutter marks
 - When N = 1.1: Single-thread spiral, every 10 cutter marks, reverse spiral as compared with cutter marks
 - When N = 1.9: Dual-thread spiral, every 10 cutter marks, same spiral as cutter marks
- (d) As the example below indicates, the fraction of N is not actually a simple number, so that the interval of a cut surface is based on a fractional number of cutter marks.

Example: Single-thread spiral cut surface (reverse direction compared with turning screw) with a pitch of 2 mm when the number of spindle rotations is 1200 rpm with 24 mm per minute (0.02 mm/rotation)

$$2 \text{ mm}/0.02 \text{ mm} = 100 \text{ cutter marks/cut surface: } N = 1.01$$

In this case, the cut surface interval is 1.6 mm when the number of spindle rotations is set to 1500 rpm, with F24 unchanged. The cut surface interval is 2.5 mm when F30 is used, with the 1200 rpm unchanged.

8. DIGITAL SERVO ADJUSTMENT PROCEDURE

This type of cut surface can result due to sliding even when the spindle and spindle motor are coupled with a belt.

Example: About seven triple-thread spirals present in 10 mm of a workpiece when the number of spindle revolutions is 1500 rpm with 60 mm per minute (0.04 mm per revolution)

$$10 \text{ mm}/(7.3)/0.04 = 107.14 \text{ cutter marks/thread}$$

$$N = 3.0093 \text{ or } 2.9907$$

- (e) Check if there is any part, such as the idler of the pulley belt of the speed change gear or spindle motor, which is rotating at an investigated speed proportional to the spindle rotation. (The belt unbalance can be a cause.)

(2) Cut surface caused by vibration with a constant frequency

An unsatisfactory cut surface caused by vibration with a constant frequency has the features described below.

Check the vibration source according to the features.

This type of cut surface appears when cutting such as turning or boring where the same part of a cutter cuts a workpiece. When a tool cuts a workpiece intermittently as in the case of milling, check other causes.

- (a) A spiral cut surface is always produced.
With face turning, a spiral cut surface appears. With boring or cylindrical turning, a screw-like cut surface appears.
- (b) When a constant vibration is present, the cut surface changes much more dynamically even with a slight change in the number of spindle revolutions, compared with the case of a vibration synchronized with spindle rotation described in item (1).
- (c) A fan motor or oil pump installed in an NC or machine can be the source of a vibration with a constant frequency.
These vibrations are in phase with the power frequency. In areas where 50 Hz is used, these vibrations often have frequencies slightly lower than 25 Hz and 50 Hz, that is, 24 Hz and 49 Hz. In areas where 60 Hz is used, these vibrations often have frequencies slightly lower than 30 Hz and 60 Hz, that is, 29 Hz and 59 Hz. So this type of cut surface becomes much more noticeable when the number of spindle revolutions is about 1500 or 1800 rpm (25 or 30 Hz), and slight change in the number of spindle revolutions dramatically changes the cut surface.

8. DIGITAL SERVO ADJUSTMENT PROCEDURE

Example: A cut surface state is predicted which can appear when a pump installed in a machine in an area using 50 Hz is making a vibration of 24.5 Hz.

- When the spindle is engaged in cutting at 1500 rpm, the spindle is rotating at 25 Hz. A disturbance vibration of 24.5 Hz matches the case of $N = 0.98$. So a cut surface will appear which has a cycle of 50 cutter marks and has the same screw as the cut screw.

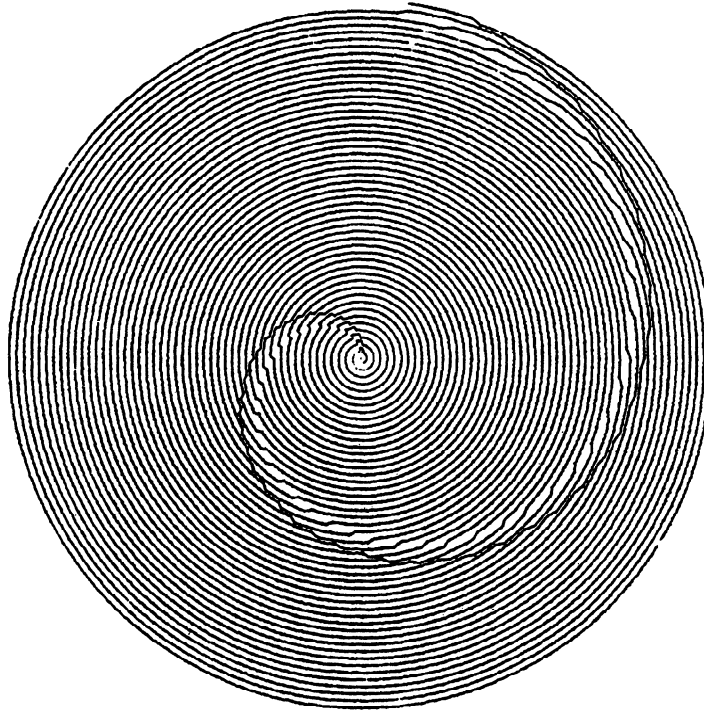

8. DIGITAL SERVO ADJUSTMENT PROCEDURE

- When the spindle is engaged in cutting at 500 rpm, the spindle is rotating at 8.33 Hz. This cycle matches $N = 2.94$. So a triple-thread, screw-like cut surface will appear which has a cycle of 16.7 cutter marks.

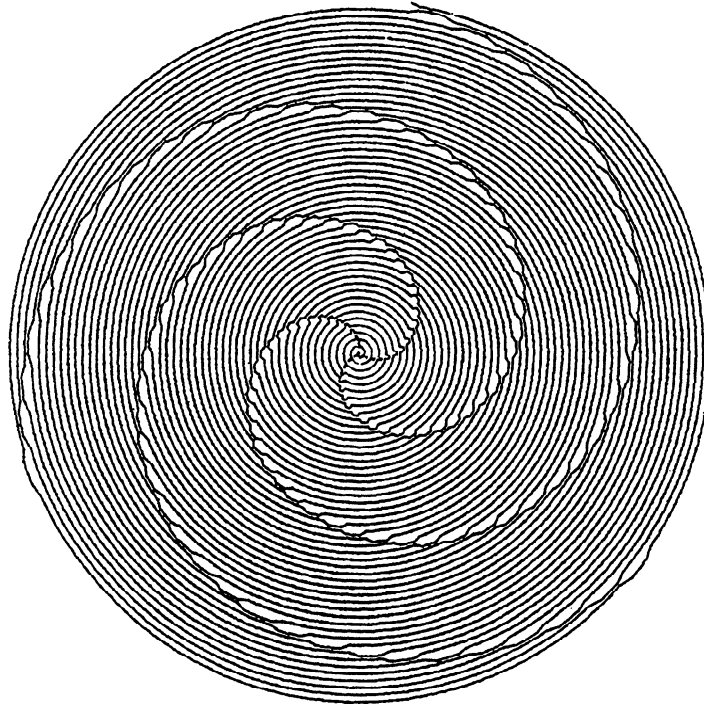

8. DIGITAL SERVO ADJUSTMENT PROCEDURE

- When the spindle is engaged in cutting at 1441 rpm, this matches $N = 1.02$. So a screw-like cut surface will appear which has the same cycle as in the case of 1500 rpm, and has the direction opposite to the cut thread.

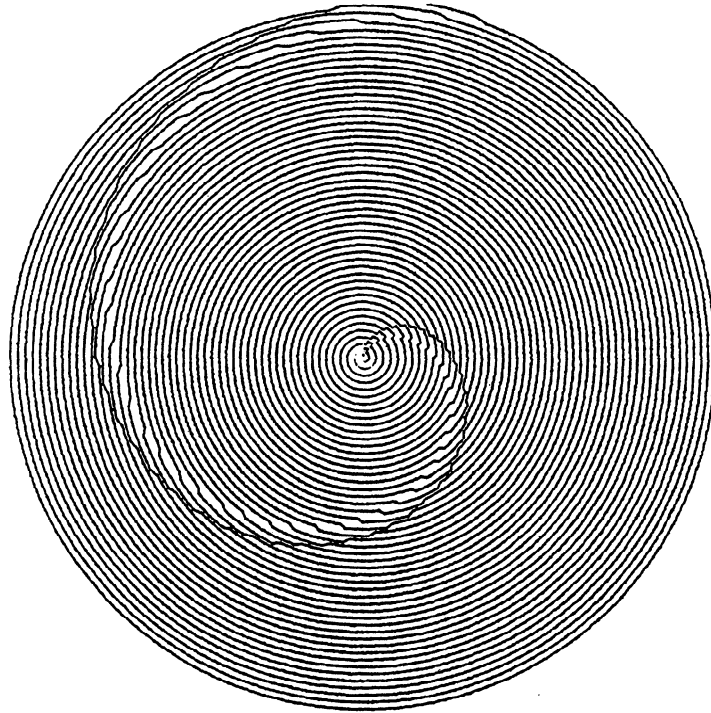

8. DIGITAL SERVO ADJUSTMENT PROCEDURE

- When the number of spindle revolutions is changed from 1500 rpm to 1470 rpm, the spindle rotation is completely synchronized with the disturbance vibration, resulting in almost no prominent cut surface feature.

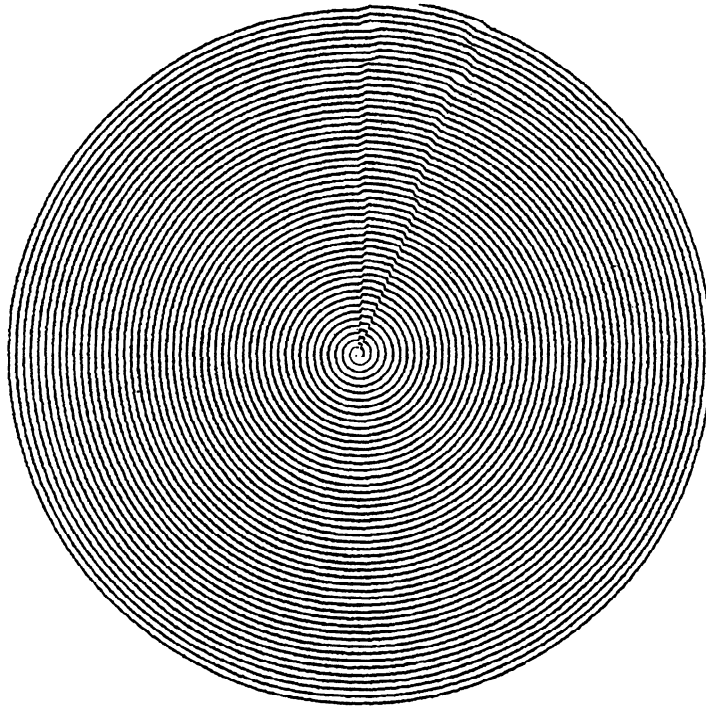

8. DIGITAL SERVO ADJUSTMENT PROCEDURE

8.8 Procedure for Adjusting the Position

8.8.1 When the positioning error is not 0 when stopping

[Check items]

1. Check the mount of servo positioning error from the DGN position deviation.
2. Check the vibration frequency with the VCMD, TSA, and TCMD signals from the check board.
3. Check set parameters (motor model, changes from standard parameters).
4. Check the following points for the machine system:
 - Semi-closed or fully closed loop
 - Horizontal or vertical axis
 - Balancer for vertical axis
 - Backlash
 - Slide or rolling

[Adjustment procedure]

- A. Check if the amount of DGN positioning error is constant.
 - If it is constant, go to A-1.
 - If it changes, go to B-1.
- A-1 Check the overshoot compensation parameter (bit 6 of No. 8x03, or No. 1808) and the incomplete integral parameter (No. 8x45 or No. 1857).
 - If only the incomplete integral (No. 8x45 or No. 1857) parameter is valid, go to A-2.
 - If both parameters are valid, go to A-3.
- A-2 Make the value of the incomplete integral (No. 8x45 or No. 1857) sufficiently close to 32767 within the range in which no overshoot occurs.
 - If the amount of DGN positioning error is 0, go to cause 1.
 - Otherwise, go to A-3.
- A-3 Enable the overshoot compensation function (bit 6 of No. 8.03 and No. 1808). Make the value of the incomplete integral (No. 8x45 and No. 1857) close to 32767.
 - If the amount of DGN positioning error is 0, go to cause 2.
 - Otherwise, go to cause 3.
- B-1 Check the VCMD offset parameter (bit 7 of No. 8x03 or No. 1808) and invalidate the parameter if it is valid.
 - If the motor stops vibrating, go to cause 4.
 - If the motor still vibrates, go to B-2.
- B-2 Check the changing frequency with the check board.
 - If the frequency is high, go to Subsection 8.2.1.
 - If the frequency is low (10 MHz or less), go to Subsection 8.3.1.

8. DIGITAL SERVO ADJUSTMENT PROCEDURE

[Causes]

- (1) When the value of the incomplete integral (PK3V) is made close to 32767, the amount of the DGN positioning error is sure to be 0. However, an overshoot may occur in a machine whose rolling is smooth without friction because linear guides are used for the machine.
If this happens, set PK3V so that overshoot does not occur, and adjust PK1V.
- (2) For overshoot compensation, like the incomplete integral (PK3V), when PK3V is made close to 32767, the amount of the DGN positioning error is sure to be 0. However, an overshoot may occur in a machine whose rolling is smooth. If this happens, adjust PK3V so that overshoot does not occur.
- (3) If the motor drifts due to the force applied by the machine while the motor stops because the overshoot compensation function is used, use the improved overshoot compensation function to stabilize the motor.
- (4) Since the VCMD offset function adds 0.5 pulse to the pulses specified by the velocity command (VCMD) for the motor, the amount of the DGN positioning error is not set to 0. (However, the actual amplitude is too small.)

8.8.2 When there is a difference in backlash between rapid traverse and cutting feed

[Check items]

1. Check the amount of servo positioning error from the DGN position deviation.
2. Check the VCMD and TSA signals from the check board.
Use these items to check whether overshoot occurs in the movement of the motor.
3. Check the following points for the machine system:
 - Semi-closed or fully closed loop
 - Horizontal or vertical axis
 - Balancer for vertical axis
 - Backlash

[Adjustment procedure]

- A. Check the VCMD and TSA waveform.
 - If no overshoot occurs, go to A-1.
 - Otherwise, go to A-2.
- A-1 Reduce the position gain or increase the time constant of rapid traverse.
 - If there is no difference in backlash between rapid traverse and cutting feed, go to cause 1.
 - If there is still a difference in backlash between rapid traverse and cutting feed, go to B.

8. DIGITAL SERVO ADJUSTMENT PROCEDURE

A-2 Specify the PI control and adjust the backlash with the incomplete integral parameter (No. 8x45 or No. 1857) or the overshoot compensation parameter (bit 6 of No. 8x03 or No. 1808). See Section 8.5 for details of the adjustment.

- If there is no difference in backlash between rapid traverse and cutting feed, go to cause 2.
- If there is still a difference in backlash between rapid traverse and cutting feed, go to B.

B. Request that the machine be reinspected and readjusted. Go to cause 3.

[Causes]

- (1) The machine overruns within backlash in spite of correct motor positioning. The only way to prevent this is to adjust the machine to lessen the impact during motor positioning so that the machine stops slowly.
- (2) Since the use of I-P control and complete integral does not decrease the torque when the machine stops, an overshoot is liable to occur. To prevent this, use the overshoot compensation as well as the P-I control and incomplete integral.
- (3) If GIB is loose, the machine is liable to overrun when it stops. There is a difference in posture between the scale and the machine position measuring positions in the fully closed loop system.

8. DIGITAL SERVO ADJUSTMENT PROCEDURE

8.8.3 Poor repetition precision

[Check items]

1. Check the amount of servo positioning error from the DGN position deviation.
2. Check the VCMD and TSA signal from the check board.
Use these items to check whether overshoot occurs in the movement of the motor.
3. Check the following points for the machine system:
 - Semi-closed or fully closed loop
 - Horizontal or vertical axis
 - Balancer for vertical axis
 - Backlash
 - Slide or rolling

[Adjustment procedure]

- A. Check the amount of DGN positioning error when the machine stops.
 - If the amount of positioning error when the machine is stopping is 0, go to A-1.
 - If the amount of positioning error when the machine is stopping is 0 and if an overshoot occurs, go to A-2.
 - If the amount of positioning error when the machine is stopping is not 0, see Subsection 8.8.1.

A-1 Adjust the machine. Go to cause 1.

A-2 Specify PI control and adjust the machine with the incomplete integral parameter (No. 8x45 or No. 1857) or overshoot compensation parameter (bit 6 of No. 8x03 or No. 1808). Alternatively, set the velocity loop control cycle to 1 ms.
→ See Section 8.5 for details of the adjustment. Go to cause 2.

[Causes]

The repetition precision (variation) value is satisfactory if it is within the minimum detection unit. It is impossible in theory to control the motor within the minimum detection unit.

- (1) If the repetition precision is poor despite correct motor positioning, it may be improved by adjusting the machine. That is, adjust the tightness of the GIB, the tension of the ball screw, or the support bearing. In particular, the vertical axis and slanted axis must be adjusted correctly.

If the machine is a fully closed system, the difference in posture of the machine may affect the repetition precision (variation).

- (2) If the machine rolling is smooth because linear guides are used for the machine, overshoot is liable to occur. The overshoot may influence the repetition precision (variation).

8. DIGITAL SERVO ADJUSTMENT PROCEDURE

8.9 Servo Positioning Error, Movement Distance, and Error in Shape

8.9.1 When the servo positioning error differs from the calculated value

[Check items]

1. Feedrate of the NC system : Check with ACTUAL FEED on the POSITION screen.
2. Validity of the machine movement distance
3. Use of the feed forward function and validity of the positioning error during cutting feed for which the feed forward function is available

[Adjustment procedure]

The servo positioning error is obtained from

$$\text{Positioning error} = \frac{\text{Feedrate (mm/min.)}}{\text{Minimum detection unit (mm) *60* position gain (S-1)}}$$

Example: The feedrate is 1000 mm/min, the minimum detection unit is 0.001 mm (1 μm), and the position gain is 30 S⁻¹. The positioning error is given by

$$\frac{1000}{0.001 \times 60 \times 30} = 555.5555$$

A-1 Check whether a correct position gain is specified.

- If it is specified, go to A-2.
- Otherwise, correct the parameter.

A-2 Check the feedrate of the NC system.

- If it is valid, go to A-3.
- Otherwise, correct the feedrate parameter and check the override signal, etc. Go to cause 1.

A-3 Check whether the machine movement distance is valid.

- If it is valid, go to A-4.
- Otherwise, check the set CMR and DMR values, the flexible feed gear rate, and the number of pulses in the pulse coder. Go to cause 2. See Subsection 8.9.2.

8. DIGITAL SERVO ADJUSTMENT PROCEDURE

A-4 Check whether the feed forward function is used and whether the positioning error is invalid during cutting feed for which the feed forward function is available.

- If it is not, go to A-5.
- Otherwise, check the specified FALPH (feed forward factor). Go to cause 3.

$$\text{Set value of FALPH} = \alpha * 4096 * \frac{\text{PULCO}}{\text{Number of position feedback pulses per motor rotation}}$$

If the number of velocity feedback pulse differs from the number of position feedback pulses, be sure to check the above set value.

A-5 Check the parameters. Go to cause 4:

- a) PULCO (the number of velocity loop pulse)
- b) PPLS (the number of position loop pulse)
- c) PLC01 (high-resolution pulse coder bit)

When a high-resolution pulse coder is used, be sure to set both the PULCO and PPLS parameters to 1/10 without setting PLC01 to 1.

[Causes]

- (1) The command velocity from the NC system is incorrect.
- (2) Because CMR, DMR, or flexible feed gear rate is set incorrectly, the movement distance specified by the command does not match the actual distance.
- (3) Since an incorrect feed forward ratio is set, the position gain is incorrect according to the ratio.
- (4) When the incorrect number of pulses is set, the position gain calculated with the number is also incorrect.

8. DIGITAL SERVO ADJUSTMENT PROCEDURE

8.9.2 Incorrect movement distance

[Check items]

1. How much is the difference between the actual movement distance and the specified one?
2. Set CMR, DMR, and flexible feed gear rate
3. Semi-closed or fully closed loop system
4. Correctness of the pulse coder specification
5. Ball screw lead and installation of the decelerator

[Adjustment procedure]

- A-1 Check whether the set CMR, DMR, and flexible feed gear rate are valid.
- If it are valid, go to A-2.
 - Otherwise, correct the set CMR and DMR. Go to cause 1.
- A-2 Check whether the machine is a semi-closed or fully-closed system.
- For a semi-closed system, go to A-3.
 - For a fully closed system, the scale is defective. Replace the scale with a new one. Go to cause 2.
- A-3 Check whether the number of pulses of the installed pulse coder is correct.
- If it is correct, the pulse coder is defective. Replace the pulse coder with a new one. Go to cause 3.
 - Otherwise, replace the pulse coder with a pulse coder whose number of pulses is correct. Go to cause 4.

[Causes]

- (1) Since incorrect CMR, DMR, flexible feed gear rate etc. are set, the movement distance specified by the command does not match the actual distance.
- (2) Since the scale is destroyed, the feedback pulses, whose number is specified, are not returned.
- (3) Since the pulse coder is destroyed, the feedback pulses, whose number is specified, are not returned.
- (4) Since the pulse coder specification is different from the expected one, the feedback pulses, whose number is specified, are not returned.

8. DIGITAL SERVO ADJUSTMENT PROCEDURE

8.9.3 When the circular shape is distorted

[Check items]

1. Distortion of a circular shape
2. DGN positioning error
3. Check the VCMD and TSA waveforms in the check boards.
4. Check the set parameters (motor model, changes from standard parameters, and NC parameter).
5. Check the following points for the machine system:
 - Semi-closed or fully closed loop
 - Backlash
 - Slide or rolling

[Adjustment procedure]

- A. Check how the circular shape is distorted.
 - If the circular shape is distorted diagonally into an elliptical one, go to A-1.
 - If the circular shape is distorted in X- or Y-axis direction into an elliptical one, go to cause 7.
 - If quadrant protrusions are produced, to to A-2.
 - If the circular shape is wavy when the feed-forward function is enabled, see Subsection 8.9.7.

- A-1 Compare the amounts of the positioning error of the two axes during cutting feed.
 - If they match, go to A-5.
 - Otherwise, go to cause 1.

- A-2 Check whether the backlash compensation data is correct.
 - If the data is correct, go to A-3.
 - Otherwise, go to cause 2.

- A-3 Check whether the FL velocity (No. 530 or No. 1623) is set for the cutting feed.
 - If it is set, go to cause 3.
 - Otherwise, go to A-4.

- A-4 Check whether overshoot occurs when the motor stops.
 - If overshoot occurs, go to Section 8.5.
 - Otherwise, go to B.

- A-5 Check the time constants for 2-axis cutting acceleration or deceleration.
 - If they are set to the same value, go to B.
 - Otherwise, go to cause 4.

- B. Check the machine system.
 - If it is a semi-closed loop system, go to cause 5.
 - If it is a fully closed loop system, go to B-1.

8. DIGITAL SERVO ADJUSTMENT PROCEDURE

B-1 Check the adjustment of the scale and Inductosyn.

- If they are adjusted incorrectly, go to cause 6.
- If they are adjusted correctly, go to cause 5.

[Causes]

- (1) If the values of feedrate and position gain parameter for the X axis are different from those for the Y axis or if incorrect servo parameters (Nos. 8x23 and 8x24 or Nos. 1876 and 1891) for two axes are set, the axes differ in the positioning error (servo delay). The circular shape is therefore distorted into an elliptical one.
- (2) If the set backlash compensation data is less or more than the amount of real backlash, quadrant protrusions are produced.
- (3) If the FL velocity is set for the cutting feedrate, the velocity command changes during deceleration as shown below. When this happens, the following quadrant protrusions are produced.

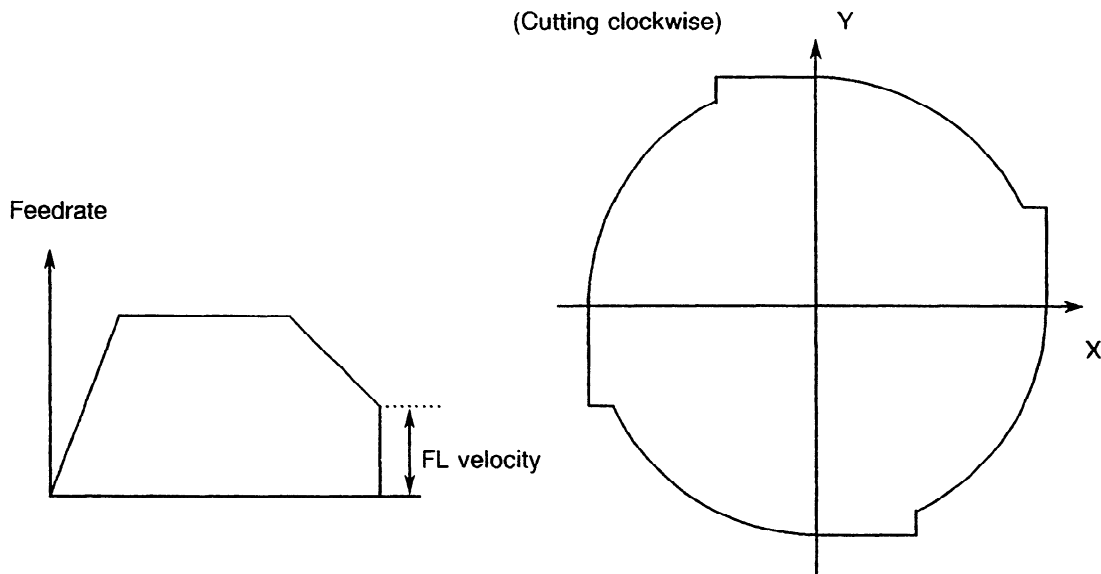

- (4) If the two axes have different time constants set for the cutting acceleration or deceleration, they also differ in initial movement velocity. When this happens, the circular shape is distorted into an elliptical one.
- (5) The machine joints such as the timing belt and coupling, friction, and difference in posture must be rechecked.
- (6) Uneven adjustment of the scale and Inductosyn between the two axes causes an elliptical shape.
- (7) A mechanical factor is suspected. For example, the horizontal and vertical axes probably do not cross at 90°.

8. DIGITAL SERVO ADJUSTMENT PROCEDURE

8.9.4 When quadrant protrusions are produced

[Check items]

1. Check the VCMD waveform from the check board.
2. Check the set parameters (motor model, changes from standard parameters, and NC parameter).
3. Check the following points for the machine system:
 - Semi-closed or fully closed loop
 - Backlash
 - Slide or rolling

[Adjustment procedure]

- A. Check whether the backlash acceleration function is valid.
 - If it is valid, go to A-2.
 - Otherwise, go to A-1.
- A-1 Specify the backlash acceleration function and adjust the acceleration while viewing the VCMD waveform. (See Subsections II-2.5.2 and II-2.5.3 for details of the adjustment.) Check whether quadrant protrusions are produced during adjustment.
 - If they are not produced, go to cause 1.
 - Otherwise, go to A-2.
 - If the adjustment is excessive and quadrant dents are produced, go to cause 2.
- A-2 Specify the PI control and increase PK1V (No. 8x43 or No. 1855) 1.5 to 2 times. Check whether quadrant protrusions are produced at that time.
 - If they are not produced, go to cause 3.
 - Otherwise, go to A-3.
- A-3 When the backlash acceleration function is valid, increase PK1V 1.5 to 2 times under PI control with the velocity loop control cycle of 1 ms. Check whether quadrant protrusions are produced at that time.
 - If they are not produced, go to cause 3.
 - Otherwise, go to B.
- B. After the above adjustments, check the TCMD waveform in the check board when the motor reverses.
 - If the rise time of the TCMD waveform is long, go to cause 4.
 - If the rise time of the TCMD waveform is short enough, go to cause 5.

[Causes]

- (1) When the motor reverses at a change in the quadrant, friction may slow the motor. This causes quadrant protrusions to be produced. The problem can be solved by specifying the backlash acceleration function to speed up the motor reversal.

8. DIGITAL SERVO ADJUSTMENT PROCEDURE

- (2) Since the backlash acceleration function may be too effective, use the backlash acceleration stop function to stop the compensation if it is too much.
- (3) If quadrant protrusions are not eliminated only by the backlash acceleration function, specify PI control and increase PK1V 1.5 to 2 times, or use a velocity loop control cycle of 1 ms to provide the motor starting torque sooner.
- (4) The above parameter adjustment proves that adjusting only the velocity loop gain does not change the motor starting torque. The capability of the motor to endure the friction and the weight of the machine must be considered.
- (5) It can be judged from the TCMD waveform that the tip of the machine tool moves slower through the motor runs. The joint with the machine (coupling), gear, timing belt, and ball screw must be checked for twists or other defects.

8.9.5 When one motor starts later than the other during straight 2-axis cutting

[Check items]

1. Check the VCMD and TCMD waveforms from the check boards.
2. Check the set parameters (motor model, changes from standard parameters, and NC parameters).
3. Check the following points for the machine system:
 - Semi-closed or fully closed loop
 - Backlash
 - Slide or rolling
 - Joints

[Adjustment procedure]

- A. Check whether correct parameters are specified for each axis motor.
 - If they are specified, go to A-1.
 - Otherwise, go to cause 1.
- A-1 Check whether the same time constant for cutting acceleration or deceleration is specified for both axis motors.
 - If the same time constant is specified, go to A-2.
 - Otherwise, go to cause 2.
- A-2 Specify PI control for the axis motor for cutting that starts later and increase PK1V 1.5 to 2 times. Check whether both motors start simultaneously.
 - If they start simultaneously, go to cause 3.
 - Otherwise, go to A-3.

8. DIGITAL SERVO ADJUSTMENT PROCEDURE

A-3 Specify PI control, specify a velocity loop control cycle of 1 ms for the axis motor that starts later, and increase PK1V 1.5 to 2 times.

Check whether both motors start simultaneously.

- If they start simultaneously, go to cause 3.
- Otherwise, go to B-1.

B. Switch NC commands for two axes.

- If the event depends on the NC commands, go to cause 4.
- Otherwise, go to B-1.

B-1 Check the TCMD waveform in the check board when the motor runs reversely.

- If the rising time of the TCMD waveform is long, go to cause 5.
- If the rising time of the TCMD waveform is short enough, go to cause 6.

[Causes]

- (1) If different feedrates and position gains are specified for the two motors, or if incorrect servo parameters are specified, one motor starts later than the other.
- (2) If different time constants are specified for cutting acceleration or deceleration, the motor for which the greater time constant is specified starts later than the other.
- (3) Specify PI control and increase PK1V 1.5 to 2 times. Alternatively, use a velocity loop control cycle of 1 ms to provide the motor starting torque sooner.
- (4) Since the NC command issuing program may be not correct, the program and NC software must be checked.
- (5) The above parameter adjustment proves that adjusting only the velocity loop gain does not change the motor starting torque. The capability of the motor to endure the friction and the weight of the machine must be considered.
- (6) It can be judged from the TCMD waveform that the tip of the machine tool moves slower though the motor runs. The joint with the machine (coupling), gear timing belt, and ball screw must be checked for twists or other defects.

8. DIGITAL SERVO ADJUSTMENT PROCEDURE

8.9.6 Incorrect corner shapes

[Check items]

1. Type of incorrect shape
2. DGN positioning error
3. Check the VCMD and TSA waveform from the check boards.
4. Check the set parameters (motor model, changes from standard parameters, and NC parameter).
5. Check the following points for the machine system:
 - Semi-closed or fully closed loop
 - Backlash
 - Slide or rolling

[Adjustment procedure]

- A. Check the type of incorrect shape.
 - If there is an error in the shape, go to cause 1.
 - If protrusions are produced at changes in the quadrant, go to A-1.
- A-1 Check whether overshoot occurs when the motor stops.
 - If overshoot occurs, see Section 8.5.
 - Otherwise, go to A-2.
- A-2 Specify PI control and increase PK1V 1.5 to 2 times.
Check whether quadrant protrusions are produced.
 - If they are not produced, go to cause 2.
 - Otherwise, go to A-3.
- A-3 Set the control cycle of the velocity loop to 1 ms, and increase the velocity loop gain as much as possible without vibration.
Check whether quadrant protrusions are produced.
 - If they are not produced, go to cause 2.
 - Otherwise, go to B.
- B. Check the TCMD waveform in the check board when the motor is reversed.
 - If the rise time of the TCMD waveform is long, go to cause 3.
 - If the rise time of the TCMD waveform is short enough, go to cause 4.

[Causes]

- (1) An error in shape occurs because the servo motor runs slower than specified by the NC command. To eliminate the error, specify the feed forward function, increase the position gain, or reduce the cutting time constant.
- (2) Quadrant protrusions are produced because the motors start late at changes in the quadrant. To make the motors start sooner, specify PI control and increase PK1V 1.5 to 2 times. Alternatively, use a velocity loop control cycle of 1 ms to get the motor starting torque sooner.

8. DIGITAL SERVO ADJUSTMENT PROCEDURE

- (3) The above parameter adjustment probes that adjusting only the velocity loop gain does not change the motor starting torque. The capability of the motor to endure the friction and the weight of the machine must be considered.
- (4) It can be judged from the TCMD waveform that the tip of the machine tool moves slower though the motor runs. The joint with the machine (coupling), gear, timing belt, and ball screw must be checked for twists or other defects.

8.9.7 Feed forward

[Check items]

1. Check the VCMD and TSA waveform from the check board.
2. Check the set parameters (motor model, changes from standard parameters, and NC parameter).

[Adjustment procedure]

- A-1 Check whether the arc shape becomes wavy without feed forward.
 - If it becomes wavy, see the adjustment procedure for vibration in Section 8.3.
 - Otherwise, go to A-2.
- A-2 Check the servo ROM series/version
 - If the servo ROM is 9020/001I or earlier, or 9030/001C or earlier, go to cause 1.
 - If the servo ROM is 9020/001H or later, or 9030/001D or later, go to A-3.
- A-3 Specify the velocity loop feed forward (No. 1962 or No. 8x69) parameter.
 - If the shape is improved, go to cause 2.
 - If the shape remains unchanged, go to cause 3.

[Causes]

- (1) Since underflow occurs during calculation in the feed forward function, the servo ROM must be replaced.

Applicable servo ROM series/version: 9030/001D or later, or 9020/001H or later

- (2) If the response for velocity is slower than that for position, good stability cannot be obtained.
The velocity loop feed forward function promotes the response of the velocity loop and eliminates vibration.
- (3) The current feed forward factor cannot be specified for rigidity of the machine. Gradually reduce the feed forward factor during the adjustment in A-3.

8. DIGITAL SERVO ADJUSTMENT PROCEDURE

8.10 Adjustment Procedure for Eliminating Current Loop Problems

8.10.1 Current vibration

[Check items]

1. Vibration of the actual current : Check the check pin on the servo amplifier.
2. Vibration frequency of the current : Check the check pin on the servo amplifier.
3. Does the table vibrate according to the vibration of the current?
4. Power voltage
5. Time at which the current vibrates (Does the vibration occur in the stopped state, during low-speed rotation, high-speed rotation, deceleration, or normal operation?)

[Adjustment procedure]

- A-1 Check the following parameters and the velocity feedback pulse count PULCO.
Current loop gains PK1, Pk2
Phase-lead compensation PVPA, counterelectromotive force compensation factor EMFCMP, etc.
- If the parameters are valid, go to A-2.
 - If an invalid parameter is found, go to cause 1.
- A-2 Check the servo amplifier.
Check that the correct amplifier is used.
Check that the correct axes are used when the 2- or 3-axis amplifier is used.
- If the servo amplifier is used correctly, go to A-3.
 - If the servo amplifier is not used correctly, go to cause 2.
- A-3 When the current vibrates in the stopped state, or during low-speed rotation or normal operation
The current loop may oscillate because of excessive current loop gain due to high power voltage. Decrease current loop gains PK1 and PK2 to 70%.
- If oscillation stops, go to A-4.
 - If oscillation still continues, go to A-7.
- A-4 Perform rapid traverse with decreased current loop gain.
- If there is sufficient torque at high-speed operation, go to cause 3.
 - If the torque is insufficient at high-speed operation, go to A-5.
- A-5 Using the speed-dependent current loop gain function, increase the current loop gain only for the high-speed area. Go to cause 4.
- A-6 Vibration of the current loop only for the high-speed area.
→ The counterelectromotive force compensation function is effective during deceleration.
Go to cause 5.

8. DIGITAL SERVO ADJUSTMENT PROCEDURE

A-7 Hardware, such as the power line, feedback cable, command cable, servo amplifier, motor, or pulse coder, may be faulty, or the wiring may be incorrect. Check the wiring. If the wiring is correct, replace the hardware in sequence from the component easiest to replace.

[Causes]

- (1) The current vibrates if the current loop gain is too large. In addition, a phase-lead compensation value or counterelectromotive force compensation value which differs substantially from the value that should be set may cause the current to begin vibrating when the rotation speed has exceeded a certain level. These points should be kept in mind especially when a high-resolution pulse coder is used.
- (2) If the maximum current of an amplifier being used is lower than the required level, the equivalent current loop gain becomes higher, causing vibration.
- (3) Unless current vibration is due to a hardware failure or wrong connection, it can be removed by decreasing the gain of the current loop.
- (4) In the high-speed area, because of the counterelectromotive force developed on the motor, the voltage that can be used by the motor effectively is lower than the DC link voltage. Therefore, current vibration may be suppressed. On the other hand, a lag in the current loop may cause insufficient torque. If this occurs, the speed-dependent current loop gain function is effective. In the low-speed area, this function decreases the current loop gain to suppress vibration, and in the high-speed area, it increases the gain accordingly.
- (5) See Cause 3 in Subsection 8.3.5.

8.10.2 Insufficient torque in the high-speed area

[Check items]

1. Actual current during high-speed rotation : Check the check pin on the servo amplifier.
2. Torque command during high-speed rotation : Check the command from the check board.
3. Torque command during low-speed feed : Measure the friction in the machine system.

[Adjustment procedure]

A-1 Check the parameters.

Current loop gains Pk1 and PK2, velocity feedback pulse count PULCO, phase-lead compensation PVPA, counterelectromotive power compensation factor EMFCMP, current limit TQLIM, etc.

- If an invalid parameter is found, go to cause 1.
- If the parameters are valid, go to A-2.

8. DIGITAL SERVO ADJUSTMENT PROCEDURE

A-2 Check the servo amplifier

Check that the correct amplifier is used.

Check that the correct axes are used when the 2- or 3-axis amplifier is used.

- If an incorrect servo amplifier is used, go to cause 2.
- If the correct servo amplifier is used, go to A-3.

A-3 Use the speed-dependent current loop gain function.

- If the torque is sufficient in the high-speed area, go to cause 3.
- If the torque is insufficient, go to A-4.

A-4 Obtain the torque required for operating the machine at a specified speed, or the torque required for acceleration.

- If the required torque is larger than the maximum torque output by the motor, go to A-5.
- If the required torque is smaller than the maximum torque output by the motor, go to A-6.

A-5 The selection of an acceleration time constant or motor is faulty.

A-6 A hardware failure may occur in the pulse coder, motor, or other parts.

[Causes]

- (1) If the PK1 or PK2 value is too small, sufficient torque cannot be produced in the high-speed area. Insufficient torque may also be observed when an invalid phase-lead compensation value or counterelectromotive force compensation value is used. These points should be kept in mind especially when a high-resolution pulse coder is used.
- (2) If the maximum current of the amplifier used is higher than the required level, the equivalent current loop gain becomes lower, and may cause insufficient torque in the high-speed area.
- (3) See cause 4 in Subsection 8.10.1.

8. DIGITAL SERVO ADJUSTMENT PROCEDURE

8.10.3 Current distortion observed when the load increases

[Check items]

1. Vibration of the actual current
: Check the check pin on the servo amplifier
2. Vibration frequency of the current
: Check the check pin on the servo amplifier.
3. Does the table vibrate according to the vibration of the current?
4. Power voltage
5. Current level at which the current begins to be distorted
: Check the check pin on the servo amplifier.

[Adjustment procedure]

A-1 Check the parameters.

Current loop gains PK1 and PK2, phase-lead compensation PVPA, counterelectromotive power compensation factor EMFCMP, etc.

- If an invalid parameter is found, go to cause 1.
- If the parameters are valid, go to A-2.

A-2 Decrease current loop gains PK1 and PK2 to approximately 70%.

- If the current distortion is eliminated, go to cause 2.
- If the current distortion remains, go to A-3.

A-3 Proceed with adjustment following A-3 and subsequent steps in Subsection 8.10.1.

[Causes]

- (1) See cause 1 in Subsection 8.10.1.
- (2) When a motor having a large rated current is used, magnetic saturation may occur as the current flowing through the motor increases. If this occurs, the current may be distorted because the equivalent inductance of the motor coils decreases. This phenomenon is apt to occur in the AC30S. etc.
The phenomenon can be removed by decreasing current loop gains PK1 and PK2. Be sure to check that sufficient torque is observed in the high-speed area and that the actual current is not too high in the high-speed area. If the check reveals some difficulty, use the speed-dependent current loop gain function when decreasing the gains.

8. DIGITAL SERVO ADJUSTMENT PROCEDURE

8.10.4 Excessive current value, or heated motor

[Check items]

1. Vibration of the actual current : Check the check pin on the servo amplifier.
2. Current value : Check the check pin on the servo amplifier.
3. Load torque
4. Number of pulses in the pulse coder
5. NC ROM version and servo ROM version

[Adjustment procedure]

A-1 Check the parameters.

Current loop gain PK1 and PK2, phase-lead compensation PVPA, counterelectromotive power compensation factor EMFCMP, etc.

- If an invalid parameter is found, go to cause 1.
- If the parameters are valid, go to A-2.

A-2 Check whether the current is vibrating.

- If the current is vibrating, go to A-3.
- If the current is not vibrating, go to A-4.

A-3 Decrease current loop gains PK1 and PK2 to approximately 70%. Go to cause 2.

A-4 Check whether the current is excessive only in the high-speed area or in the entire area.

- If the current is excessive in the entire area, go to A-6.
- If the current is excessive only in the high-speed area, go to A-5.

A-5 Use the speed-dependent current loop gain change function.

Fine-adjust the phase-lead compensation parameter to reduce the current.

Increase velocity loop gains PK1 and PK2 by approximately 20%. Go to cause 3.

A-6 Check whether the friction torque in the machine is greater than the expected value.

[Causes]

- (1) If a value for phase-lead compensation parameter PVPA or counterelectromotive force compensation parameter EMFCMP differs substantially from the value that should be set, the current loop may vibrate. If it does not vibrate, the actual current may increase excessively.
These point should be kept in mind especially when a high-resolution pulse coder is used.
- (2) If the current loop gain is too high under some influence, the current may vibrate, which increases the current and prevents effective use of the current.
- (3) Unless the current vibrates, as the gain of the current loop is increased, the current becomes lower especially in the high-speed area. An almost optimum value is already set for the phase-lead compensation parameter. However, it may require fine adjustment because the optimum value varies slightly according to the number of revolutions and load torque. This adjustment can decrease the current a little in the high-speed area.

8. DIGITAL SERVO ADJUSTMENT PROCEDURE

8.10.5 Large difference observed in the high-speed area between the value in the torque command and the actual current

[Check items]

1. The speed at which the actual current begins to deviate from the value in the torque command
: Check the TCMD from the check board and the check pin on the servo amplifier.
2. Difference between the value in the torque command and the actual current

[Adjustment procedure]

A-1 Check the parameters.

Current loop gains PK1 and PK2, phase-lead compensation PVPA, counterelectromotive force compensation factor EMFCMP, etc.

- If an invalid parameter is found, go to cause 1.
- If the parameters are valid, go to A-2.

A-2 Increase the counterelectromotive force compensation parameter by approximately 50%.

- If no problems are detected during rapid traverse or deceleration, go to cause 2.
- If the current is distorted during rapid traverse or deceleration, go to A-3.

A-3 Compensate the deceleration counterelectromotive force during deceleration. Go to cause 3.

[Causes]

The deviation of the actual current from the value of the torque command at high-speed rotation may be due to the influence of the motor counterelectromotive force. The counterelectromotive force compensation function is provided for eliminating the influence of the counterelectromotive force and matching the value of the torque command with the actual current.

In normal operation, a small difference between the torque command value and the actual current is permitted. In the high-speed area, however, when the counterelectromotive force causes the torque command to be saturated at an earlier state, the torque in the high-speed area may be restricted unnecessarily.

- (1) If the value of the counterelectromotive force compensation or phase-lead compensation parameter greatly deviates from the standard value, the actual current may increase, or the actual current may deviate greatly from the value in the torque command. These point should be kept in mind especially when a high-resolution pulse coder is used.
- (2) As explained above, the counterelectromotive force compensation matches the actual current and the value in the torque command. The standard compensation factor in the parameter is set so that it is 70% of the calculation.
By increasing the counterelectromotive force compensation factor by 40 to 50%, the difference between the actual current and the value in the torque command can be decreased further.

8. DIGITAL SERVO ADJUSTMENT PROCEDURE

- (3) Increasing the counterelectromotive force compensation factor can decrease the difference between the actual current and the value in the torque command. When a motor having high counterelectromotive force is used, however, the compensation value of the counterelectromotive force (included in the PWM command) may be too large. As a result, the DC link voltage level may be exceeded, or positive/negative inversion may occur momentarily in the torque command. If such problems occur during regular operation, the actual current becomes distorted. In this case, the bit that enables deceleration counterelectromotive force compensation must be set to enable counterelectromotive force compensation not only at acceleration but in the whole area.

8.10.6 Current distorted only at deceleration

[Check items]

1. Amplitude of the actual current vibration at deceleration
: Check the check pin on the servo amplifier.
2. Vibration frequency of the actual current at deceleration
: Check the check pin on the servo amplifier.
3. Distortion of the actual current during acceleration or rapid traverse
: Check the check pin on the servo amplifier.
4. Distortion of the TSA waveform and VCMD waveform during deceleration
: Check from the check board.

[Adjustment procedure]

If the current is distorted only during deceleration, it is necessary to find whether the distortion involves the current loop only or also involves the velocity loop. (The velocity loop oscillates at deceleration, and it causes the current to become distorted.) If vibration involves the current loop only, it is a simple matter to decrease the current loop gain to eliminate oscillation.

Check the parameters.

A-1 Check the parameters.

Current loop gains PK1 and PK2, phase-lead compensation PVPA, counterelectromotive force compensation factor EMFCMP, etc.

- If an invalid parameter is found, go to cause 1.
- If the parameters are valid, go to A-2.

A-2 Try deceleration with current loop gains PK1 and PK2 approximately halved.

- If the distortion of the current is improved, go to A-3.
- If the distortion of the current is not corrected, go to B-1.

A-3 Decrease current loop gains PK1 and PK2 to approximately 70%.

- If sufficient torque is observed during acceleration, go to cause 1.
- If the torque becomes insufficient during acceleration, or the actual current is excessive during rapid traverse, go to A-4.

A-4 Use the speed-dependent current loop gain change function. Go to cause 2.

8. DIGITAL SERVO ADJUSTMENT PROCEDURE

B-1 See the explanation of vibration in Subsection 8.3.5, and adjust the velocity loop.

[Causes]

- (1) If a parameter for the current loop is invalid or excessive, the current may vibrate. If the power voltage is high and the equivalent current loop gain becomes higher, the counter electromotive force of the motor decreases the equivalent current loop gain at acceleration, and so vibration does not occur. At deceleration, however, the counter electromotive force increases the equivalent current loop gain, which may cause oscillation. If this occurs, decrease the current loop gain.
- (2) Decreasing the current loop gain can correct the distortion of the current, but may cause insufficient torque at acceleration or produce an excessive current during rapid traverse. If this occurs, use the speed-dependent current loop gain change function to increase the current loop gain only in the high-speed area. The speed-dependent current loop gain change function changes the current loop gain to a higher level only for acceleration and rotation at constant speed. As soon as the function detects deceleration, it changes the gain to the original level. This function provides high current loop response to acceleration and stability during deceleration at the same time.

8. DIGITAL SERVO ADJUSTMENT PROCEDURE

8.11 Return to Reference Position

8.11.1 When the origin is shifted or varies at return to reference position

[Check items]

1. Has the machine position shifted?
: Check the position of the machine with the dial indicator and laser measuring machine.
2. The amount of shift
3. The length of the deceleration dog
4. Relationship between the return start position, dog position, and the origin
5. Return mode
: Check whether return to the reference position was made in the manual or automatic mode. Check whether the return operation was performed for the first time since power was turned on.
6. Use of the absolute position detector
7. Amount of movement per motor rotation, and the setting of CMR and DMR
8. Setting of rapid traverse rate, FL rate, and rapid traverse time constant
9. Check whether the system is a fully closed or semi-closed loop.
10. Setting of the reference counter and the number of pulses

[Adjustment procedure]

- A-1 Check whether the absolute position pulse coder is used.
- If the absolute position pulse coder is used, see Subsection 8.11.2.
 - If the absolute position pulse coder is not used, go to A-2.
- A-2 Check that the system is a fully-closed loop system.
- If the system is fully-closed, see Subsection 8.11.3.
 - If the system is semi-closed, go to A-3.
- A-3 Check whether the machine position has shifted.
- If the machine position has shifted, go to A-4.
 - If the machine position has not shifted and only the position indication show a shift, check whether the NC workpiece coordinate offset is invalid. Go to cause 1.
- A-4 Determine the amount of shift.
- For one grid, see Subsection 8.11.4.
 - For several pulses, see Subsection 8.11.5.
 - For other than the above, go to A-5.

8. DIGITAL SERVO ADJUSTMENT PROCEDURE

A-5 Check that the number of pulses and the setting of the reference counter match.

- If they match, go to A-6.
- If they do not match, correct the setting of the reference counter. Go to cause 2.

* The reference counter must be set carefully especially when 1- μ control is performed with a high-resolution pulse coder. If 1 is set for the PLC01 parameter, the capacity of the reference counter is 10 times as large as the set value.

A-6 The pulse coder is faulty. → Replace the pulse coder.

[Causes]

- (1) When the machine has been returned to the reference position, the position indication at the NC side sometimes shows a non-zero value. This depends on the setting of a parameter such as the work coordinate offset.
- (2) To return to the reference position manually, a grid signal is generated in synchronization with the signal indicating one rotation of the motor (phase Z signal). The move command is counted by a counter that counts up to the value specified for the reference counter capacity and returns to zero. Then the machine is moved from the deceleration dog and stopped at the first grid point. This means that the value to be set for the reference counter must be equal to or a divisor of the number of pulses required for one rotation of the motor.

8.11.2 When the absolute value pulse coder is used and the origin varies

[Check items]

1. Has the machine position shifted?
: Check the position of the machine with the dial indicator and laser measuring machine.
2. The range of variation
3. Mode used for return to the reference position
: Check that the manual mode is used for return to the reference position.
Check whether the return operation was performed for the first time after the absolute value pulse coder was installed.

[Adjustment procedure]

- A1 Set parameters so that the machine is returned to the reference position without detecting the absolute position, then retry the return operation.
- If the origin has not shifted, go to A-2.
 - If the origin is still shifted, see A-2 and subsequent steps in Subsection 8.11.1.
- A-2 Check whether the machine position has shifted.
- If the machine position has shifted, go to A-3.
 - If the machine position has not shifted and only the position indication shows a shift, check whether the NC workpiece coordinate offset is invalid. Go to cause 1.
- A-3 The absolute position pulse coder is faulty. Replace the pulse coder.

[Causes]

- (1) When the machine has been returned to the reference position, the position indication at the NC side sometimes shows a non-zero value. This depends on the setting of a parameter such as the work coordinate offset.

8. DIGITAL SERVO ADJUSTMENT PROCEDURE

8.11.3 When the origin varies in the fully-closed system

[Check items]

1. Check whether the origin still varies in the semi-closed system.
2. Has the machine position shifted?
 - : Check the position of the machine with the dial indicator and laser measuring machine.
3. The range of variation
4. The relationship between the start position of return to the reference position, dog position, origin, and the position at which a signal indicating one rotation is issued

[Adjustment procedure]

- A-1 Check whether the origin varies also in the semi-closed system.
- If the origin has not shifted, go to A-2.
 - If the origin is still shifted, see A-3 and subsequent steps in Subsection 8.11.1.
- A-2 Check whether the machine position has shifted.
- If the machine position has shifted, go to A-3.
 - If the machine position has not shifted and only the position indication shows a shift, check whether a parameter such as the NC workpiece coordinate offset is invalid. Go to cause 1.
- A-3 Check the range of variation.
- For one grid, see Subsection 8.11.4.
 - For other than the above, go to A-4.
- A-4 Check whether the signal indicating one rotation (phase Z signal) is supplied from the semi-closed system. Check the parameter (bit 1 of parameter No. 1815 for the Series 10, 11, 12, and 15) and the signal connection (for series 0).
- If the setting is valid, go to A-5.
 - If the setting is invalid, correct the setting. Go to cause 2.
- A-5 The linear scale and its interface circuit are faulty.
- Replace the linear scale and interface circuit.

[Causes]

- (1) When the machine has been returned to the reference position, the position indication at the NC side sometimes shows a non-zero value. This depends on the setting of a parameter such as the work coordinate offset.
- (2) When the phase Z signal is supplied from the semi-closed system (motor), the position of the origin varies unless the capacity of the reference counter is equal to or a divisor of the number of fully-closed feedback pulses sent after one rotation of the motor. Therefore, the phase Z signal must be supplied from the fully-closed system, or the capacity of the reference counter must be corrected.

8. DIGITAL SERVO ADJUSTMENT PROCEDURE

8.11.4 When the origin has shifted by one grid point

[Check items]

1. The length of deceleration dog
2. The relationship between the start position of return to the reference position, dog position, and the origin
3. Return mode
 - : Check whether the machine was returned to the reference position in the manual or automatic mode. Check whether the return operation was performed for the first time since power was turned on.
4. Setting of rapid traverse rate, FL rate, and rapid traverse time constant

[Adjustment procedure]

- A-1 Decrease the FL rate, and retry.
- If the origin is still shifted, go to A-2.
 - The origin is not shifted, the deceleration dog is too close to the origin. Change the position of the deceleration dog, or change the origin by grid shift. Go to cause 1.
- A-2 Decrease the rapid traverse time constant, or decrease the rapid traverse rate, then retry.
- If the origin is still shifted, go to A-3.
 - If the origin has not shifted, extend the length of the deceleration dog. Alternatively, decrease the rapid traverse time constant. Go to cause 2.
- A-3 The setting of the reference counter is invalid. Check whether the setting is two times as large as the value that should be set.
- Correct the setting. Go to cause 3.

[Causes]

- (1) After a signal indicating that the deceleration dog has been turned off is output by the hardware, it takes some time (up to approximately 20 ms) for the software in the digital servo to recognize the signal. In addition, the time required for the recognition varies. As a result, if the deceleration dog is too close to the origin, the software sometimes fails to capture the signal.
- (2) If too large a value is set for the rapid traverse time constant, or the deceleration dog is too short, the FL rate may not be reached within the deceleration dog. When the deceleration dog is turned off in such a condition, the return operation does not stop until the FL rate is detected, even if the grid point is reached.

8. DIGITAL SERVO ADJUSTMENT PROCEDURE

- (3) To return to the reference position manually, a grid signal is generated in synchronization with the signal indicating one rotation of the motor (phase z signal). The move command is counted by a counter that counts up to the value specified for the reference counter capacity and returns to zero. Then the machine is moved from the deceleration dog and stopped at the first grid point. This means that the value to be set for the reference counter must be equal to or a divisor of the number of pulses required for one rotation of the motor.

8.11.5 When the origin varies by several pulses

[Check items]

1. The range of variation
2. Return mode
 - : Check the machine was returned to the reference position in the manual or automatic mode. Check whether the return operation was performed for the first time since the power was turned on.

[Adjustment procedure]

- A-1 Does the origin vary only the first time after power is turned on?
 - If it does not, go to A-2.
 - If it does, the phase Z signal may be split. To prevent possible malfunctioning due to noise, ensure grounding. Replace the pulse coder. Go to cause 1.
- A-2 The capacity of the reference counter is set incorrectly.

[Causes]

- (1) The grid signal is generated on the rising edge of the signal indicating one rotation (phase Z signal). If the phase Z signal is split, the grid signal is shifted by the amount of the split, and the origin is shifted accordingly.

II. DIGITAL SERVO SOFTWARE

Part II explains the servo functions of the following series.
 (For startup of the digital servo, see Chapter I-3.)

Digital servo ROM

Series	Latest version	Application	Model
9000 9001	S N	General machine tools	Series 10, 11, 12, 0-A
9002	L	High-speed positioning units	Series 0-PA
9010	G	General machine tools	Series 10, 11, 12, 0-B
9020	L	General machine tools	Series 10, 11, 12, 0-B, 0-C (16 bit)
9022	D	High-speed positioning units	Series 0-PB, 0-PC (16 bit)
9030	N	General machine tools	Series 15, 0-C (32 bit)
9031	J	For hybrid control	Series 15, 0-C (32 bit)
9032	C	High-speed positioning units	Series 15, 0-PC (32 bit)
9039	A	For automatic adjustment	Series 15, 0-C (32 bit)
9040	C	For serial pulse coders	Series 15, 0-C (32 bit)

The digital servo ROM 9050 series for Series 16 will be explained in Part III of this manual.

(Note) Always replace a digital servo ROM with a ROM of the same series. If the ROM is replaced with another series of ROM, problems may occur.

1. SERVO PARAMETERS

This chapter explains NC parameters related to the digital servo.

1.1 Details of Parameters

1.1.1 Symbols, addresses, and setting ranks of the digital servo parameters

Symbol	Series 0	Series15	Rank	Parameter meaning
PLC01	No. 0037 bit7	No. 1804 bit0	*A⊙	High resolution bit
SPTPx(x:X,Y,Z,4)	0037 bity	(y = 0,1,2,3)	*A⊙	Separate detector enabled/disabled
AMR	8X01	1806	*A⊙	Pulse coder AMR setting
PFSEL		1807 bit3	*A⊙	Separate detector enabled/disabled
OPTX		1815 bit1	*A⊙	Separate detector enabled/disabled
MTRID	8X20	1874	*A⊙	Motor type
LDINT	8X21	1875	*A⊙	Load inertia ratio
DIRCTL	8X22	1879	*A⊙	Motor rotating direction
PULCO	8X23	1876	*A⊙	Number of pulses for velocity feedback
PPLS	8X24	1891	*A⊙	Number of pulses for position feedback
TGALRM	8X03 bit1	1808 bit1	*B⊙	Broken-wire alarm detection level set by software
OBENBL	8X03 bit2	1808 bit2	*B⊙	Observer function
PIENBL	8X03 bit3	1808 bit3	*B⊙	IP-PI switching
1PSPRS	8X03 bit4	1808 bit4	*B⊙	One-pulse suppress function
BLENBL	8X03 bit5	1808 bit5	*B⊙	Backlash acceleration function
OVSCMP	8X03 bit6	1808 bit6	*B⊙	Overshoot prevention function
VOFST	8X03 bit7	1808 bit7	*B⊙	VCMD offset function
TIB0	8X04 bit1	1809 bit1	*B⊙	Velocity loop control period
FEEDFD	8X05 bit1	1883 bit1	*B○	Feed-forward function
BRKCTL	8X05 bit6	1883 bit6	*B○	Gravity-axis brake control function
FCBLCM	8X06 bit0	1884 bit0	*B○	Closed loop backlash bit
PKVER	8X06 bit2	1884 bit2	*B○	Velocity dependent current loop gain variable
MODEL ACCFB	8X06 bit4	1884 bit4	*B○	1-ms acceleration feedback function
DCBEMF	No. 8X06 bit6	No. 1884 bit6	*B○	Bit for reverse electromotive force compensation during deceleration
ADBLSH	8X09 bit2	1953 bit2	*B	New backlash acceleration function bit
BLCUT	8X09 bit6	1953 bit6	*B	Bit for backlash acceleration during cutting
BLSTP	8X09 bit7	1953 bit7	*B	Backlash acceleration stop function
SPBIT	8X10 bit0	1954 bit0	*B	Bit for a 10000-pulse pulse coder
BLTEN	8X10 bit3	1954 bit3	*B	Tenfold backlash acceleration function

1. SERVO PARAMETERS

Symbol	Series 0	Series15	Rank	Parameter meaning
PGEXPD	8X11 bit5	1955 bit5	*B	Function for enlarging the position gain setting range
DPFBCT	8X11 bit7	1955 bit7	*B	Dual position feedback function
MSFEN	8X12 bit1	1956 bit1	*B	Machine velocity feedback function
VCMD1	No.8X12 bit4	No.1956 bit4	*B	VCMD output variable bit
VCMD2	8X12 bit5	1956 bit5	*B	VCMD output variable bit
PK1V	8X43	1855	*B	Velocity loop (integration) gain
PK2V	8X44	1856	*B	Velocity loop (proportion) gain
PK3V	8X45	1857	*B	Imperfect integration coefficient
BLCMP	8X48	1860	*B	Backlash compensation acceleration parameter
DPFMAX	8X49	1961	*B	Maximum amplitude of dual position feedback
TGALMLV	8X64	1892	*B	TG alarm level
PK2VAUX	8X66	1894	*B	Compensation torque command
FILTER	8X67	1895	*B	Torque command filter
FALPH	8X68	1961	*B	Feed-forward coefficient
VFFLT	8X69	1962	*B	Velocity loop feed-forward coefficient
ERBLM	8X70	1963	*B	Backlash compensation acceleration parameter
PBLCT	8X71	1964	*B	Backlash compensation acceleration parameter
AALPH	8X74	1967	*B	Velocity dependent current loop gain
MODEL	8X75	1968	*B	
WKAC	8X76	1969	*B	1-ms acceleration feedback gain
OSCTPL	8X77	1970	*B	Overshoot prevention counter
DPFCH1	8X78	1971	*B	Conversion coefficient for dual position feedback (numerator)
DPFCH2	8X79	1972	*B	Conversion coefficient for dual position feedback (denominator)
DPFTC	8X80	1973	*B	Time constant for dual position feedback
DPFZW	8X81	1974	*B	Zero width for dual position feedback
BLENDL	8X82	1975	*B	Backlash acceleration stop amount
MOFCTL	8X83	1976	*B	Gravity-axis brake control timer
SDMR1	8X84	1977	*B⊙	Flexible feed gear numerator
SDMR2	8X85	1978	*B⊙	Flexible feed gear denominator
TCPRLD	8X87	1980	*B	Backlash acceleration torque offset
MCNFB	8X88	1981	*B	Machine velocity feedback gain
BLBSL	8X89	1982	*B	Base pulse for backlash acceleration
ONEPSL		1992	*B	One-pulse suppression level for serial pulse coder A
TIA0	8X04 bit0	1809 bit0	*C⊙	

1. SERVO PARAMETERS

Symbol	Series 0	Series15	Rank	Parameter meaning
TRW0	8X04 bit2	1809 bit2	*C◎	
TRW1	8X04 bit3	1809 bit3	*C◎	
DLY0	8X04 bit6	1809 bit6	*C◎	
DLY1	8X04 bit7	1809 bit7	*C◎	
PK1	8X40	1852	*C◎	Current loop gain
PK2	8X41	1853	*C◎	Current loop gain
PK3	8X42	1854	*C◎	Current loop gain
PK4V	8X46	1858	*C	Velocity loop gain
POA1	8X47	1859	*C	Velocity control observer parameter
POK1	8X50	1862	*C	Velocity control observer parameter
POK2	8X51	1863	*C	Velocity control observer parameter
PPMAX	8X53	1865	*C	Current dead-zone compensation
PDDP	8X54	1866	*C	Current dead-zone compensation
PHYST	8X55	1867	*C	Current dead-zone compensation
EMFCMP	No.8X56	No.1868	*C	Reverse electromotive force compensation
PVPA	8X57	1869	*C	Current phase control
PALPH	8X58	1870	*C	Current phase control
EMFBAS	8X59	1871	*C	Reverse electromotive force compensation
TQLIM	8X60	1872	*C◎	Torque limit
EMFLMT	8X61	1873	*C	Reverse electromotive force compensation
POVC1	8X62	1877	*C	Overload protection coefficient
POVC2	8X63	1878	*C	Overload protection coefficient
POVCLMT	8X65	1893	*C	Overload protection coefficient
PTCURR	8X86	1979	*C◎	Rated current parameter
DEPVPL	8X98	1991	*C	Phase shift compensation during deceleration

Rank *A : Parameters set by MTB

Rank *B : Parameters are automatically set by the system, but may be changed as required.

Rank *C : Parameters are automatically set by the system and must not be changed.

◎ : After set values have been changed, the power must be turned off then on again.
(For both Series 0-C (32 bits) and Series 15)

○ : After set values have been changed, the power must be turned off then on again.
(For Series 0-C (32 bits) only)

1. SERVO PARAMETERS

(Note 1) In parameter Nos. in Series 0, X represents an axis No.

Example : No. 8X00

Parameter No. 8X00 for the first axis is No. 8100, and parameter No. 8X00 for the second axis is No. 8200.

(Note 2) Bit (y = 0, 1, 2, 3) represents a bit position.

(Note 3) For all series other than Series 0-C and Series 15, PPMAX, PDDP, EMFCMP, and PVPA are regarded as rank A.

(Note 4) The meanings and symbol names of parameter Nos. 8X04 (Series 0) and 1809 (Series 10, 11, 12, and 15) differ between Series 0-C (32 bits) and Series 15, and other systems. See Sections 1.3 and 1.4.

(Note 5) In the ROM 9040 series for serial pulse coders, the parameters for flexible feed gear setting (SDMR1 and SDMR2) are regarded as rank *A.

1.1.2 Parameter description

This section explains the meanings of parameters. Be sure to set parameters not explained here to 0.

In each of the following parameter formats, the upper part is the format for Series 0, and the lower part is for Series 10, 11, 12, and 15.

Parameter No.	Parameter							
8X00							DGPRM	HRPLC
1804							DGPRM	PLC01
	b7	b6	b5	b4	b3	b2	b1	b0
Standard setting :	0	0	0	0	0	0	1	0

For Series 10, 11, 12, and 15

PLC01 By using the high-resolution pulse coder or serial pulse coder, separate 0.1 μ m control for each axis is :

0 : Not performed.
1 : Performed.

When bit 0 (PLC01) of parameter No. 1804 is set to 1 for Series 10, 11, 12, or 15, the weight of the following parameters is multiplied by ten.

- No. 1827 Effective area
- No. 1828 Positioning deviation limit for each axis when traveling
- No. 1829 Positioning deviation limit for each axis when stopped

1. SERVO PARAMETERS

- No. 1830 Positioning deviation limit for each axis when the servo is off
- No. 1832 Positioning deviation limit for each axis when feeding is stopped
- No. 1837 Positioning deviation limit for each axis at rigid tapping
- No. 1850 Amount of grid shift
- No. 1876 Number of velocity feedback pulses
- No. 1891 Number of position feedback pulses
- No. 1896 Capacity of reference counter
- No. 1816 bits 0 to 3 Capacity of reference counter

For Series 0-C

- HRPLC By using the high-resolution pulse coder or serial pulse coder, $0.1\mu\text{m}$ control is :
- 0 : Not performed.
 - 1 : Performed.

(Note) If $0.1\mu\text{m}$ control is performed using the high-resolution pulse coder in Series 0, set bit 7 of No. 37 to 1. In Series 0, $0.1\mu\text{m}$ control cannot be performed separately for each axis.

For Series 0-C, setting bit 0 (HRPLC) of No. 8X00 to 1 increases the magnitude of the following parameters by a factor of ten :

- No. 8X23 Number of pulses for velocity feedback : Set value \times 10
- No. 8X24 Number of pulses for position feedback : Set value \times 10
- No. 0004 Reference counter capacity : Set value \times 10
- No. 0504 Move position deviation : Set value \times 10
- No. 0508 Grid shift : Set value \times 10

- DGPRM When power is turned on, the digital servo parameters for the motor are :
- 1 : Not set.
 - 0 : Set.

If a motor No. is set for the motor type (Nos. 8X20 and 1874) this parameter is set to 0, the standard parameters for the motor are set automatically when the power is turned on and this parameter is changed to 1.

Parameter No. Parameter

8X01	AMR7	AMR6	AMR5	AMR4	AMR3	AMR2	AMR1	AMR0
1806	AMR7	AMR6	AMR5	AMR4	AMR3	AMR2	AMR1	AMR0
	b7	b6	b5	b4	b3	b2	b1	b0

AMR7 to AMR0: Set AMR values according to the number of pulses output from the pulse coder of the motor.

1. SERVO PARAMETERS

AMR								Number of pulses output from the pulse coder of the motor (value before multiplication by 4) (According to motor type)
7	6	5	4	3	2	1	0	
0	0	0	1	1	1	1	1	2000P
0	0	0	1	1	0	1	0	2500P
0	0	0	1	0	0	0	1	3000P
0	0	0	0	1	1	0	1	10000P
0	0	0	0	0	0	0	1	12500P, 15000P
0	0	1	1	1	1	1	1	20000P
0	0	1	1	1	0	1	0	25000P
0	0	1	1	0	0	0	1	30000P
1	0	0	1	0	0	0	0	(1000P 5-0)
0	0	0	1	0	1	0	1	(2000P 3-0S, 4-0S)
Setting the AMR for the 9040 series ROM for a serial pulse coder (motor with serial pulse coder A or B)								
1	0	0	0	0	0	1	0	AC 5-0 (with serial pulse coder A)
0	0	0	0	0	0	1	1	AC 4-0S, 3-0S (with serial pulse coder A)
0	0	0	0	0	0	0	0	AC 70S to 2-0S (with serial pulse coders A and B).
0	0	0	0	0	0	0	0	AC 70S to 40S (with serial pulse coder C)
1	0	0	0	0	0	0	0	AC 5-0 (with serial pulse coder C)

1. SERVO PARAMETERS

Parameter No. Parameter

8X02				0	1			
1807				0	PFSEL			
	b7	b6	b5	b4	b3	b2	b1	b0

Series 0

Standard setting : 0 0 0 0 1 0 0 0

For Series 0, be sure to set the parameter as shown above.

Series 10, 11, 12, and 15

Standard setting : 0 0 0 0 0 0 0 0

The following parameter is valid only for Series 10, 11, 12, and 15 :

PFSEL For position detection, a position detector not mounted on the motor, such as a separate pulse coder or optical scale, is :

1 : Used

0 : Not used (Standard setting)

8X03	VOFST	OVSCMP	BLENBL	1PSPRS	PIENBL	OBENBL	TGALRM	
1808	VOFST	OVSCMP	BLENBL	1PSPRS	PIENBL	OBENBL	TGALRM	
	b7	b6	b5	b4	b3	b2	b1	b0

Series 0

Standard setting : 0 0 0 0 0 0 0 0

(Note) The setting above is the standard setting for Series 0-C (32 bits) and Series 15. In Series 0-A, 0-B, and 0-C (16 bits), and Series 10, 11, and 12, bit 0 has different meanings. Be sure to set *NDL8, the symbol of bit 0, to 1. For details, see Sections 1.3 and 1.4.

TGALRM : The broken-wire alarm detecting level of the position detector is :

0 : Set to the standard level.

1 : Reduced to 1/4 of the standard setting.

(Valid for editions 9000/H and 9000/I only)

1 : Reduced to a sensitivity specified separately

(Valid for editions 9000/J and later)

Related parameters :

8X64 (Series 0) 1892 (Series 10, 11, 12, and 15)

1. SERVO PARAMETERS

OBENBL : The velocity control observer is :

0 : Not used (Standard setting)

1 : Used (Valid for editions 9000/E, 9001/B, and later)

(For details of this function, see Section 2.3.3)

Related parameters :

8X47 (Series 0) 1859 (Series 10, 11, 12, and 15)

8X50 (Series 0) 1862 (Series 10, 11, 12, and 15)

8X51 (Series 0) 1863 (Series 10, 11, 12, and 15)

Note that this function is not available with the 3-0, 4-0, and 5-0 motors.

PIENBL : Velocity control is :

0 : Set to IP (Standard setting)

1 : Set to PI (Valid for editions 9000/E, 9001/B, and later)

(For details of this function, see Section 2.9.1)

1PSPRS : The one-pulse suppress function is :

0 : Not used (Standard setting)

1 : Used (Valid for editions 9000/E, 9001/B, and later)

(For details of this function, see Section 2.2.2)

BLENBL : The backlash acceleration function is :

0 : Not used (Standard setting)

1 : Used (Valid for editions 9000/H, 9001/E, and later)

(For details of this function, see Section 2.5.2)

Related parameters :

8X48 (Series 0) 1860 (Series 10, 11, 12, and 15)

OVSCMP : The overshoot compensation function is :

0 : Disabled (Standard setting)

1 : Enabled

(Valid for editions 9000/K, 9001/G, and later)

(For details, see Section 2.4.1)

Related parameters :

8X45 (Series 0) 1857 (Series 10, 11, 12, and 15)

8X77 (Series 0) 1970 (Series 10, 11, 12, and 15)

VOFST : The VCMD offset function is :

0 : Not used (Standard setting)

1 : Used (Valid for editions 9000/F, 9001/D, and later)

(For details, see Section 2.6)

1. SERVO PARAMETERS

Parameter No. Parameter

8X04	DLY1	DLY0			TRW1	TRW0	TIB0	TIA0
1809	DLY1	DLY0			TRW1	TRW0	TIB0	TIA0

b7 b6 b5 b4 b3 b2 b1 b0

Standard setting : 0 1 0 0 0 1 0 0

(Motor types 1 to 38)

0 1 0 0 0 1 1 0

(Motor types 39 and later)

TIB0 : The velocity loop control period is set to :

0 : 2 msec

1 : 1 msec

When initialized, these parameters are automatically set to the standard values. Never change the standard setting.

TIB0 (velocity loop control period), however, may be changed during servo parameter adjustment.

(Note) The settings above are the standard settings for Series 0-C (32 bits) and Series 15. With Series 0-A, 0-B, 0-C (16 bits), Series 10, 11, and 12, the standard setting is 00011010 when the velocity loop control period is set to 2 ms. For details, see Sections 1.3 and 1.4.

8X05		BLKCTL					FEEDFD	
1883		BLKCTL					FEEDFD	

b7 b6 b5 b4 b3 b2 b1 b0

Standard setting : 0 0 0 0 0 0 0 0

FEEDFD : The feed forward function is :

0 : Disabled

1 : Enabled

(For details, see Section 2.5.1)

Related parameters :

8X68 (Series 0) 1961 (Series 10, 11, 12, and 15),

8X69 (Series 0) 1962 (Series 10, 11, 12, and 15)

1. SERVO PARAMETERS

BLKCTL : The vertical axis brake control function is :

0 : Disabled

1 : Enabled

(Valid for editions 9030/N, 9040/C, and later)

Related parameters :

8X83 (Series 0-C) 1976 (Series 15)

If MCC is turned off as soon as a servo alarm is generated on the vertical axis, the arm may drop along the vertical axis. This function is provided to prevent the arm from dropping.

In parameter No. 8X83 (Series 0-C) or 1976 (Series 15), set the delay time required before MCC is turned off.

Parameter No. Parameter

8X06	DCBEMF		MODEL ACCFB		PKVER		FCBLCM
1884	DCBEMF		MODEL ACCFB		PKVER		FCBLCM

b7 b6 b5 b4 b3 b2 b1 b0

Standard setting : 0 0 0 0 0 0 0 0

FCBLCM : In closed loop feedback :

0 : Backlash compensation pulses are used for compensation.

1 : Backlash compensation pulses are not used for position compensation.

(Valid for the 9000/S, 9001/N, and later)

(For details, see Section 2.5.2)

Related parameters :

8X48 (Series 0) 1860 (Series 10, 11, 12, and 15)

If this parameter is set to 1, quadrant protrusions caused by backlash can be reduced even in a closed loop system.

Generally, in a closed loop system, backlash compensation is not set since it causes position deviation. If FCBLCM and BLENBL are set to 1, however, protrusions can be reduced without position deviation.

(Note) In the 9000 and 9001 series, when this function is used, the magnitude of BLMCMP in parameter No. 8X48 (Series 0) or 1860 (Series 10, 11, and 12) is increased by a factor of 8.

If 4000 is set in a semi-closed loop system, a typical value for a closed system is 500.

1. SERVO PARAMETERS

PKVER : The velocity dependent current loop gain variable function is :
 0 : Disabled
 1 : Enabled (Valid for editions 9020/B and later)
 (For details, see Section 2.8.2)
 Related parameters :
 8X74 (Series 0) 1967 (Series 10, 11, 12, and 15)

MODEL ACCFB :
 The 1-ms acceleration feedback function is :
 0 : Disabled
 1 : Enabled (Valid for editions 9020/E, 9030/E, 9040/A, and later)
 (For details, see Section 2.3.1)
 Related parameters :
 8X67 (Series 0) 1895 (Series 10, 11, 12, and 15)
 8X76 (Series 0) 1969 (Series 10, 11, 12, and 15)

DCBEMF : During deceleration, reverse electromotive force compensation is:
 0 : Disabled
 1 : Enabled (Valid for editions 9000/R, 9001/M, 9010/D, 9020/C, and later)

Parameter No. Parameter

8X09	BLSTP	BLCUT				ADBLSH		
1953	BLSTP	BLCUT				ADBLSH		

b7 b6 b5 b4 b3 b2 b1 b0

Standard setting : 0 0 0 0 0 0 0 0

ADBLSH : The new backlash acceleration function is :
 0 : Disabled
 1 : Enabled (Valid for editions 9030/K, 9040/B, and later)
 (For details, see Section 2.5.3)
 Related parameters :
 8X48 (Series 0) 1860 (Series 15)
 8X71 (Series 0) 1964 (Series 15)
 8X87 (Series 0) 1980 (Series 15)

BLCUT : The function for enabling the backlash acceleration function only during cuttings :
 0 : Disabled
 1 : Enabled
 (Valid for editions 9010/G, 9020/J, 9030/F, 9040/A, and later)
 (For details, see Section 2.5.2)

1. SERVO PARAMETERS

BLSTP : The backlash acceleration stop function is :
 0 : Disabled
 1 : Enabled (Valid for editions 9010/G, 9020/J, 9030/F, 9040/A, and later)
 (For details, see Section 2.5.2)
 Related parameters :
 8X82 (Series 0) 1975 (Series 10, 11, 12, and 15)

Parameter No. Parameter

8X10					BLTEN			SPBIT
1954					BLTEN			SPBIT

b7 b6 b5 b4 b3 b2 b1 b0

Standard setting : 0 0 0 0 0 0 0 0

SPBIT : When 1- μ m control is applied with a 10000-pulse pulse coder, the function for simplifying the setting is :
 0 : Invalidated. (For details of the setting, see Chapter 3 of Part I.)
 1 : Validated. (Valid with 9030/P, 9031/H, 9040/D, and later editions)

BLTEN : Multiplication of the backlash acceleration amount by 10
 (For high-resolution pulse coders) is :
 0 : Disabled
 1 : Enabled (Valid for editions 9030/I, 9040/A, and later)
 (For details of the function, see Section 2.5.2.)
 Related parameters :
 8X48 (Series 0) 1860 (Series 15)

8X11	DPFBCT		PGEXPD					
1955	DPFBCT		PGEXPD					

b7 b6 b5 b4 b3 b2 b1 b0

Standard setting : 0 0 0 0 0 0 0 0

PGEXPD : The function for enlarging the position gain setting range is :
 0 : Invalidated. (For details of the function, see Subsection 1.7.5.)
 1 : Validated. (Valid with 9030/O, 9031/H, 9040/D, and later editions)

1. SERVO PARAMETERS

DPFBCT : The dual position feedback function is :

0 : Invalidated. (For details of the function, see Subsection 2.3.5.)

1 : Validated. (Valid with 9031/F and later editions)

Related parameters :

8X61 (Series 0) 1849 (Series 15)

8X78 (Series 0) 1971 (Series 15)

8X79 (Series 0) 1972 (Series 15)

8X80 (Series 0) 1973 (Series 15)

8X81 (Series 0) 1974 (Series 15)

Parameter No. Parameter

8X12			VCMD2	VCMD1			MSFEN	
1956			VCMD2	VCMD1			MSFEN	

b7 b6 b5 b4 b3 b2 b1 b0

Standard setting : 0 0 0 0 0 0 0 0

MSFEN : The machine velocity feedback function is :

0 : Disabled

1 : Enabled (Valid for editions 9030/K, 9040/B, and later)

(For details of this function, see Section 2.5.2)

Related parameters :

8X88 (Series 0) 1981 (Series 15)

VCMD1, VCMD2 :

The VCMD waveform is converted according to the table below.

(See the check board in Chapter I-6.)

VCMD2	VCMD1	Signal level for conventional VCMD output
0	0	1 (Unchanged)
0	1	1 / 4
1	0	1 / 16
1	1	1 / 64

(Valid for editions 9030/K, 9040/A, and later)

1. SERVO PARAMETERS

Parameter No. Parameter

8X20	Motor type
1874	Motor type

The digital servo ROM holds the standard parameters for each motor model. If DGPRM is set to 0, the standard values associated with the motor type specified in this parameter are automatically set when the power is turned on.

The range of data differs depending on the ROM edition as follows :

9000E, 9001B	and later editions: 3 to 14
9000H, 9001E	and later editions: 3 to 25
9000L, 9001H, 9010A	and later editions: 3 to 26
9000N, 9001K, 9002J, 9010B, 9020A	and later editions: 3 to 36
9000P, 9001L, 9002K, 9010C, 9020B, 9022A	and later editions: 3 to 38
9010F, 9020E, 9022B, 9030A	and later editions: 3 to 41
9010G, 9020F, 9022C, 9030B	and later editions: 3 to 67
9020K, 9030G 9031A,	and later editions: 3 to 72
9030J 9031D,	and later editions: 3 to 73
9030K, 9031E	and later editions: 3 to 78
9031F, 9040A	and later editions: 3 to 83
90300, 9031H, 9040D	and later editions: 3 to 84

If the data range is exceeded, an alarm is generated.

Drawing No. of amplifier 185 V input type (A06B-6057-HXXX)

Motor type No.	3(42)	4	5	6	7	8	9	10	11
Motor Drawing No.	0531	0532	0533	0521	0522	0513	0512	0501	0505
Motor model	5-0	4-0S	3-0S	2-0	1-0	0	5	10	20S/1500

Motor type No.	12	13	14(54)	15(56)	16(57)	18(59)	19(60)
Motor Drawing No.	0502	0503	0506	0561	0562	0571	0572
Motor model	20S	30	30/2000	0L	5L	7L	10L

Motor type No.	38(58)
Motor Drawing No.	0564
Motor model	6L

1. SERVO PARAMETERS

Drawing Nos. of 200 to 220 V amplifiers (A06B-6058-H20X, H30X)

Motor type No.	21	22	22	23	24	25
Motor Drawing No.	0311	0312	0372	0313	0314	0315
Motor model	2-0S	1-0S	1-0SP	0S	5S	10S

Drawing Nos. 200 to 230 V amplifiers (A06B-6058-H00X, H22X, H32X, H33X)
(A06B-6066-H00X, H22X, H23X, H24X)

Motor type No.	27(43)	28(44)	29	30(46)	30(46)	31(63)	32(48)	2(49)
Motor Drawing No.	0532	0533	0311	0312	0372	0313	0314	0316
Motor model	4-0S	3-0S	2-0S	1-0S	1-0SP	0S	5S	6S

Motor type No.	37(45)	37(45)	33(50)	34(51)	35(52)	36(53)	(80)	(82)
Motor Drawing No.	0310	0371	0315	0505	0502	0590	0382	0384
Motor model	2-0S	2-0SP	10S	20S/1500	20S	30S	5T	10T

Drawing Nos. of 200 to 230 V amplifiers for large motors (A06B-6058-H101, H102)

Motor type No.	39	40	41
Motor Drawing No.	0331	0332	0333
Motor model	50S	60S	70S

Drawing Nos. of 200 to 230 V amplifiers for high-speed motors (A06B-6058-H00X)

Motor type No.	61	61	62	62	63	64	65
Motor Drawing No.	0310	0371	0309	0373	0313	0514	0317
Motor model	2-0S	2-0SP	1-0S/3000	1-0SP/3000	0S	5S/3000	10S/3000

Motor type No.	66	67	73	78	79	81	83	84
Motor Drawing No.	0318	0319	0320	0583	0381	0383	0386	0374
Motor model	20S/3000	30S/3000	6S/3000	40S/2000	0T/3000	5T/3000	10T/3000	0-0SP

1. SERVO PARAMETERS

Drawing Nos. of amplifiers for L Series high-speed motors (A06B-6057-HXXX)

Motor type No.	68	69	70	71	72
Motor Drawing No.	0561	0562	0564	0571	0572
Motor model	0L (3000)	5L (3000)	6L (3000)	7L (3000)	10L (2250)

(Note 1) Numbers in parentheses in the motor type No. row are the motor type numbers for when the velocity loop control period is 1 msec.

(Note 2) For large or high-speed motors, the standard velocity loop control period is 1 msec.

(Note 3) Motor type Nos. 74 to 77 are special parameters for piston lathes and must therefore not be used.

(Note 4) The velocity loop control period is changed for a pair of axes at a time (i.e., the first axis and second axis, the third axis and fourth axis etc.). The period for both axes is determined by the parameter of the odd-numbered axis. If the first axis is selected from the standard parameters for the 1-ms control period (39 or later), the second axis must be selected from the same parameters.

(Note 5) The motor type number for an SP motor is assigned in the same way as for normal motors. (For 1-0SP, the same motor type number used for 1-0S is assigned, and for 2-0SP, the same number used for 2-0S is assigned.) If the high-resolution pulse coder (10000P) is used, however, the standard parameter needs to be changed.

1. SERVO PARAMETERS

Parameter No.	Parameter
8X21	Load inertia ratio (LDINT)
1875	Load inertia ratio (LDINT)

The ratio of the machine load inertia to the motor rotor inertia is calculated from the following equation :

$$\text{Load inertia ratio} = \frac{\text{Machine load inertia}}{\text{Motor rotor inertia}} \times 256$$

Data range : 0 to 32767

Example : Motor model 10 ($J_m = 0.10$), machine inertia ($J_l = 0.05$)
 Set value = $0.05/0.10 \times 256 = 128$

When this parameter is set, velocity loop gains PK1V and PK2V are multiplied by $(1 + LDINT/256)$.
 For details, see Section 2.9.2.

8X22	Motor rotation direction (DIRCTL)
1879	Motor rotation direction (DIRCTL)

DIRCTL : Set the rotation direction of the motor.

- 111 : Normal connection
(The motor rotates clockwise as viewed from the detector.)
- 111 : Reverse connection
(The motor rotates counterclockwise as viewed from the detector.)

If a value other than 111 or - 111 is set, an alarm is generated.

1. SERVO PARAMETERS

Parameter No.	Parameter
8X23	Number of pulses for velocity feedback (PULCO)
1876	Number of pulses for velocity feedback (PULCO)

Data unit : PULSE/REV.

Data range : 1 to 32767

Set the number of pulses per motor rotation in the detector used for velocity feedback. When calculating the number of pulses, assume that four pulses appear in one pulse cycle period of phase A or B. Unless a value greater than zero is set, an alarm is generated.

This value is set according to standard values for the pulse coder built into the motor as follows :

2000P : 8000

2500P : 10000

3000P : 12000

10000P : 4000 (when PLCO1 or HRPLC is set to 1)

12500P : 5000 (when PLCO1 or HRPLC is set to 1)

15000P : 6000 (when PLCO1 or HRPLC is set to 1)

20000P : 8000 (when PLCO1 or HRPLC is set to 1)

25000P : 10000 (when PLCO1 or HRPLC is set to 1)

30000P : 12000 (when PLCO1 or HRPLC is set to 1)

For serial pulse coders A and B: 8192

819 (when PLCO1 or HRPLC is set to 1)

1. SERVO PARAMETERS

Parameter No. Parameter

Parameter No.	Parameter
8X24	Number of pulses for position feedback (PPLS)
1891	Number of pulses for position feedback (PPLS)

Data unit : PULSE/REV.

Data range : 1 to 32767

Set the number of pulses per motor rotation in the detector used for position feedback. When calculating the number of pulses, assume that four pulses appear in one pulse cycle period for phase A and B. The set value is not changed by DMR or CMR. If a value of zero or less is set for the parameter, an alarm is generated.

If the motor has an incremental pulse coder and no separate detector is used, set the same value as for PULCO. If the motor has serial pulse coder A or B, and no separate detector is used, set the following :

12500
1250 (when PLC01 is set to 1)

When a separate detector is used

Example 1 : 1 μ m optical scale and machine travel of 5 mm per motor rotation
Set value : 5000

Example 2 : 0.5 μ m optical scale and machine travel of 10 mm per motor rotation
Set value : 20000

Example 3 : 0.1 μ m optical scale and machine travel of 1 mm per motor rotation
Set value : 10000

(Note) When a 0.1 μ m position detector is used and the set value does not exceed 32767, set PLC01 to 0. (If the value is over 32767, see Example 4.)

Example 4 : 0.1 μ m optical scale and machine travel of 4 mm per motor rotation
Set value : 4000 (PLCO1 or HRPLC is set to 1.)

(Note) Since PLC01 is set to 1, set PULCO to 1/10 of the calculated value. When the resolution of the motor pulse coder is greater than 0.1 μ m even though a 0.1 μ m position detector is used, it is impossible to reduce vibration to 0.1 μ m or lower when the motor is stopped. In this case, use a high-resolution pulse coder so that the resolution of the motor pulse coder is lower than the resolution of the position detector.

1. SERVO PARAMETERS

- Example 5 : 2 mm/1 λ Inductosyn, machine travel of 8 mm per motor rotation, and a 4000P/1 λ A/D converter
Set value : 16000
- Example 6 : Rotary Inductosyn of 360 λ (720 poles) per rotation, 2 degrees (gear reduction ratio: 1/180) per motor rotation, and a 4000P/1 λ A/D converter
Set value : 8000
- Example 7 : Rotary Inductosyn of 180 λ (360 poles) per rotation, 6 degrees (gear reduction ratio: 1/60) per motor rotation, and a 4000P/1 λ A/D converter
Set value : 12000

This parameter is equivalent to the loop gain multiplier of an analog servo. If position gain for each axis has to be changed in Series 0, the actual position gain can be changed by setting a value different from a calculated value. (However, this means that if an incorrect setting is made, the position gains of all the axes will not match.)

- Example : The position loop gain (position gain) is set to 30 (1/S), the pulse coder built into the motor is used as the position detector, and the number of pulses is 2500P.

Parameter	Correct setting	Value after change
PULCO	10000	10000
PPLS	10000	12000
Actual position gain	30	25

In this case, a perfectly round circle cannot be produced.

1. SERVO PARAMETERS

Parameter No. Parameter

Parameter No.	Parameter
8X40	Current loop gain (PK1)
1852	Current loop gain (PK1)

Data range : 1 to 32767

(See Subsection 2.8.1 for details)

8X41	Current loop gain (PK2)
1853	Current loop gain (PK2)

Data range : -1 to 32767

(See Subsection 2.8.1 for details)

8X42	Current loop gain (PK3)
1854	Current loop gain (PK3)

Data range : -1 to 32767

(See Subsection 2.8.1 for details)

8X43	Velocity loop (integration) gain (PK1V)
1855	Velocity loop (integration) gain (PK1V)

Data range : 1 to 32767

The gain of the low area of the velocity loop is set. By increasing this gain, rigidity, positioning accuracy, and response characteristic are improved.

(See Subsection 2.9.2 for details)

1. SERVO PARAMETERS

Parameter No. Parameter

8X44	Velocity loop (proportion) gain (PK2V)
1856	Velocity loop (proportion) gain (PK2V)

Data range : -1 to 32767

The gain of the high area of the velocity loop is set.
(See Subsection 2.9.2 for details)

8X45	Coefficient of incomplete integration (PK3V)
1857	Coefficient of incomplete integration (PK3V)

Data range : 0 to 32767

Standard setting : 0

A coefficient for incomplete integration (for making servo rigidity finite) is set (ranging from about 32760 to 32600). This parameter is valid for editions 9000/F, 9001/D and later. For earlier editions, the parameter has a different meaning, and must be set to 0.
(See Subsection 2.4.2 for details)

8X46	Velocity loop gain (PK4V)
1858	Velocity loop gain (PK4V)

Data range : -1 to 32767

Standard setting : The value is set automatically at power-on.
 Compensates the velocity loop for delay due to sampling.

8X47	Velocity control observer parameter (POA1)
1859	Velocity control observer parameter (POA1)

Data range : 0 to 32767

Standard setting : The value is set automatically at power-on time.
(For details of the function, see Subsection 2.3.3.)

1. SERVO PARAMETERS

Parameter No. Parameter

8X48	Velocity-control backlash-acceleration amount (BLCMP)
1860	Velocity-control backlash-acceleration amount (BLCMP)

Data range : 0 to 32767

Standard setting : 0

Set the amount of backlash compensation acceleration.

(For details of this function, see Subsections 2.5.2 and 2.5.3.)

(Note) For ROM editions before the 9000/G and 9001/D, this parameter has a different meaning. For these editions, set the value set automatically at power-on.

8X49	
1861	

Data range : 0 to 32767

Standard setting : 0

(Note) For ROM editions before the 9000/H, this parameter has a different meaning. For these editions, set the value set automatically at power-on.

8X50	Velocity control observer parameter (POK1)
1862	Velocity control observer parameter (POK1)

Data range : 0 to 32767

Standard setting : The value is set automatically at power-on.

(For details of this function, see Subsection 2.3.3.)

1. SERVO PARAMETERS

Parameter No. Parameter

8X51	Velocity control observer parameter (POK2)
1863	Velocity control observer parameter (POK2)

Data range : 0 to 32767

Standard setting : The value is set automatically at power-on.

(For details of this function, see Subsection 2.3.3.)

8X52	Not used
1864	Not used

Data range : 0 to -32767

Standard setting : 0

(Note) The value is set automatically at power-on.

8X53	Current dead-zone compensation (PPMAX)
1865	Current dead-zone compensation (PPMAX)

Data range : 0 to 32767

Standard setting : The value is set automatically at power-on.

(For details of this function, see Subsection 2.8.4.)

(Note) If the NC used is other than Series 15 or 0-C, the value for the 2000P pulse coder is set as the standard value. This value must be multiplied by $N_p/2000$.

(N_p represents the number of pulses on the pulse coder.)

See Sections 1.3 and 1.4.

1. SERVO PARAMETERS

Parameter No. Parameter

8X54	Current dead-zone compensation (PDDP)
1866	Current dead-zone compensation (PDDP)

Data range : 0 to 32767

Standard setting : The value is set automatically at power-on.

(For details, see Subsection 2.8.4.)

(Note) If the NC used is other than Series 15 or 0-C, the value for the 2000P pulse coder is set as the standard value. This value must be multiplied by 2000/Np.

(Np represents the number of pulses on the pulse coder.)

See Sections 1.3 and 1.4.

8X55	Current dead-zone compensation (PHYST)
1867	Current dead-zone compensation (PHYST)

Data range : 0 to 32767

Standard setting : The value is set automatically at power-on.

8X56	Backelectromotive force compensation (EMFCMP)
1868	Backelectromotive force compensation (EMFCMP)

Data range : 0 to 32767

Standard setting : The value is set automatically at power-on.

This parameter improves the current-loop characteristic during high-speed rotation.

(For details of this function, see Subsection 2.8.3.)

(Note1) If the NC used is other than Series 15 or 0-C, the value for the 2500P pulse coder is set as the standard value. This standard value must be multiplied by 2500/Np.

(Np represents the number of pulses on the pulse coder.)

See Sections 1.3 and 1.4.

1. SERVO PARAMETERS

(Note 2) Editions 9000/M, 9001/J, and earlier do not have this function, 0 is always set at power-on. If this function is required, replace the servo ROM with the 9000/N, 9001/K, or a later ROM edition. (With the 9010, 9020, 9030, 9040, 9002, and 9022 series, this function is available from edition A on.)

(Note 3) For edition 9000/J, 9001/F, or earlier, this parameter has a different meaning. For these editions, the value is set automatically at power-on.

Parameter No. Parameter

8X57	Current-phase control (PVPA)
1869	Current-phase control (PVPA)

Data range : 0 to 32767

Standard setting : The value is set automatically at power-on.
(For edition 9000/J, 9001/F, or later)

(For details of this function, See Subsection 2.8.3.)

(Note1) If the NC used is other than Series 15 or 0-C, the value for the 2500P pulse coder is set as the standard value. This standard value must be multiplied by 2500/Np. (Np represents the number of pulses on the pulse coder.)
See Sections 1.3 and 1.4.

(Note2) For edition 9000/H, 9001/E, or earlier, set this value according to the combination of the motor model and pulse coder by referring to the parameter table for edition 9000/J, 9001/F, or later.

8X58	Current-phase control (PALPH)
1870	Current-phase control (PALPH)

Data range : 0 to 32767

(For details of this function, see Subsection 2.8.3.)

(Note) The value is set automatically at power-on.

1. SERVO PARAMETERS

Parameter No. Parameter

8X59	Back electromotive force compensation (EMFBAS)
1871	Back electromotive force compensation (EMFBAS)

Data range : 0 to 32767

Standard setting : 0

(For details of this function, see Subsection 2.8.3.)

Set the minimum speed used for back electromotive force compensation. If DCBEMF (bit 6 of 8X06 (Series 0) or bit 6 of 1884 (Series 10, 11, 12, and 15)) is set to 1, set this parameter to 10.

8X60	Torque limit (TQLIM)
1872	Torque limit (TQLIM)

Data range : 0 to 32767

(For details, see Subsection 2.8.2.)

(Note) The value is set automatically at power-on. The standard value is for maximum torque (torque occurring when the maximum current set by the amplifier is used). It can be set to a lower value.

8X61	Back electromotive force compensation (EMFLMT)
1873	Back electromotive force compensation (EMFLMT)

Data range : 0 to 32767

Standard setting : The value is set automatically at power-on. (For edition 9000/N, 9001/K, or later). For 9000K/L/M or 9001G/H/J, set an appropriate value according to the motor model by referencing the parameter table in Section 2.16.

This parameter sets the limit on the level of back electromotive force compensation.

(For details of this function, see Subsection 2.8.3.)

(Note) For editions 9000/J, 9001/F, and earlier, this parameter has a different meaning. For these editions, the value is set automatically at power-on.

1. SERVO PARAMETERS

Parameter No. Parameter

8X62	Overload protection coefficient (OVC1)
1877	Overload protection coefficient (OVC1)

Data range : 0 to 32767

Standard setting : The value is set automatically at power on.

This parameter sets the coefficient of an alarm generated to protect the motor and transistor from overload.

(For details of function, see Subsection I-7.3.4.)

8X63	Overload protection coefficient (OVC2)
1878	Overload protection coefficient (OVC2)

Data range : 0 to 32767

Standard setting : The value is set automatically at power on.

This parameter sets the coefficient of an alarm generated to protect the motor and transistor from overload.

(For details of function, see Subsection I-7.3.4.)

8X64	TG alarm level (TGALMLV)
1892	TG alarm level (TGALMLV)

Data range : 1 to 32767

Standard setting : 4

The parameter sets the broken-wire detection alarm level in the position detector.
(Unit : 1/32 motor rotation)

In a closed loop machine, when a large backlash is present and at least 1/64 rotation of backlash occurs in the motor shaft, the amount of backlash is set in this parameter. This is motor rotation without a corresponding position detector indication.

This parameter is not valid unless bit 1 TGALRM of parameter No. 8X03 (Series 0) or 1808 (Series 10, 11, 12, and 15) is set to 1.

(For details of this parameter, see Subsection I-7.3.2.)

(Note) For edition 9000/I or earlier, this parameter has a different meaning. For these editions, set the value set automatically at power-on.

1. SERVO PARAMETERS

Parameter No. Parameter

8X65	Overload protection coefficient (OVCLMT)
1893	Overload protection coefficient (OVCLMT)

Data range : 0 to 32767

Standard setting : The value set is automatically at power-on.

This parameter sets the coefficient of an alarm generated to prevent the motor and transistor from overload.

8X66	PK2VAUX
1894	PK2VAUX

Data range : -32767 to 32767

Standard setting : 0

If a positive value is set, the compensation torque command function can be used. (This function is available with editions 9000/H, 9001/E and later. It is not supported by the 9002 and 9022 series.)

The compensation torque command function suppresses vibration when the motor is stopped. Set this parameter to around 500,000/Np (Np represents the number of pulses on the pulse coder), depending on the motor model. (For the 2000P, set it to around 250.)

Since when the value set is too large, vibration may occur, smaller values are desirable. (For details of the function, see Subsection 2.2.1.)

If a negative value is set, the 250- s acceleration feedback function can be used. (The function is available with editions 9030/M, 9040/C, and later.)

Set the following value :

- When a normal pulse coder is used : About -500 to -1000
- When a high-resolution pulse coder is used : About -100 to -200
- When serial pulse coders A and B are used : About -10 to -20

If the set value is too large, vibration may occur. (For details of this function, see Subsection 2.3.1.)

1. SERVO PARAMETERS

Parameter No. Parameter

8X67	Torque command filter (FILTER)
1895	Torque command filter (FILTER)

Data range : 0 to 4096

Standard setting : 0

This parameter is set to remove high frequency noise from a torque command.
(Valid for editions 9020/E, 9030/E, 9040/A and later.)

(For details of setting, see Subsection 2.3.3.)

8X68	Feed-forward coefficient (FALPH)
1961	Feed-forward coefficient (FALPH)

Data range : 0 to 32767

Standard setting : 0

This parameter sets the coefficient for feed-forward control. In general, a coefficient of 4096 corresponds to 1.

(Valid for editions 9010/B, 9020/A, 9030/A, 9040/A and later.)

(For details of this function, see Subsection 2.5.1.)

8X69	Velocity-loop feed-forward coefficient (VFFLT)
1962	Velocity-loop feed-forward coefficient (VFFLT)

Data range : 0 to 32767

Standard setting : 0

This parameter sets the coefficient for velocity-loop feed-forward control.
(Valid editions the 9010/B, 9020/A, 9030/A, 9040/A, and later.)

(For details of this function, see Subsection 2.5.1.)

1. SERVO PARAMETERS

Parameter No. Parameter

8X70	Backlash compensation-acceleration parameter (ERBLM)
1963	Backlash compensation-acceleration parameter (ERBLM)

Data range : 0 to 32767

Standard setting : 0

This parameter is used for synchronizing backlash compensation acceleration when motor rotation is reversed.

(Valid for editions 9010/B, 9020/A, 9030/A, 9040/A, and later.)

(For details of this function, see Subsection 2.5.2.)

8X71	Backlash compensation-acceleration parameter (PBLCT)
1964	Backlash compensation-acceleration parameter (PBLCT)

Data range : 0 to 32767

Standard setting : 0

This parameter sets the number of times backlash acceleration compensation is to be performed. Acceleration is performed (the set value + 1) times.

(Valid for editions 9010/B, 9020/A, 9030/A, 9040/A, and later.)

(For details of this function, see Subsections 2.5.2 and 2.5.3.)

8X74	Velocity-dependent current-loop gain (AALPH)
1967	Velocity-dependent current-loop gain (AALPH)

Data range : 0 to 32767

Standard setting : 0

This parameter is used to change the current loop gain according to the velocity. The current loop gain can be increased in high speed ranges.

(Valid for editions 9020/B, 9030/A, 9040/A and later.)

(For details of this function, see Subsection 2.8.2.)

1. SERVO PARAMETERS

Parameter No. Parameter

8X76	1-ms acceleration feedback gain (WKAC)
1969	1-ms acceleration feedback gain (WKAC)

Data range : 0 to 32767

Standard setting : 0

This parameter is used to make the velocity loop stable. It determines the gain for acceleration feedback. When using this function, set the velocity loop control period to 1 ms, and use a torque command filter.

Set the following values so that no vibration is generated :

- When a normal pulse coder is used : Around 50 to 70
- When the high-resolution pulse coder is used : Around 10 to 15
- When serial pulse coders A and B are used : Around 200 to 300

If the value set is too large, unusual sounds or vibration may be generated.
(Valid for editions 9020/E, 9030/E, 9040/A, and later.)

(For details of this function, see Subsection 2.3.1.)

8X77	Overshoot prevention counter (OSCTPL)
1970	Overshoot prevention counter (OSCTPL)

Data range : 0 to 32767

Standard setting : 0

When the overshoot prevention function is used by setting bit 6 (OVSCMP) of parameter No. 8X03 (Series 0) or 1808 (Series 10, 11, 12, and 15) to 1, the motor sometimes flutters when stopped. If this occurs, set this parameter.
(Valid for editions 9020/J, 9030/F, 9040/A, and later.)

(For details of this function, see Subsection 2.4.1.)

1. SERVO PARAMETERS

Parameter No. Parameter

8X78	Conversion coefficient of dual position feedback (numerator) (DPFCH1)
1971	Conversion coefficient of dual position feedback (numerator) (DPFCH1)

Data range : 0 to 32767 (For details of this function, see Subsection 2.3.5.)

Standard setting : 0
(Valid with 9031/F and later editions)

8X79	Conversion coefficient of dual position feedback (denominator) (DPFCH2)
1972	Conversion coefficient of dual position feedback (denominator) (DPFCH2)

Data range : 0 to 32767 (For details of this function, see Subsection 2.3.5.)

Standard setting : 0
(Valid with 9031/F and later editions)

8X80	Time constant of dual position feedback (DPFTC)
1973	Time constant of dual position feedback (DPFTC)

Data range : 0 to 32767 (For details of this function, see Subsection 2.3.5.)

Standard setting : 0
(Valid with 9031/F and later editions)

8X81	Zero-point amplitude of dual position feedback (DPFZW)
1974	Zero-point amplitude of dual position feedback (DPFZW)

Data range : 0 to 32767 (For details of this function, see Subsection 2.3.5.)

Standard setting : 0
(Valid with 9031/F and later editions)

1. SERVO PARAMETERS

Parameter No. Parameter

8X82	Backlash acceleration stop amount (BLENDL)
1975	Backlash acceleration stop amount (BLENDL)

Data range : 0 to 32767

Standard setting : 0

Set this parameter to prevent excess compensation of backlash acceleration.
(Valid for editions 9010/G, 9020/J, 9030/F, 9040/A, and later.)

(For details of this function, see Subsection 2.5.2.)

8X83	Gravity-axis brake control timer (MOFCT)
1976	Gravity-axis brake control timer (MOFCT)

Data unit : msec

Data range : 1 to 32767

Standard setting : 0

Set the delay time required before servo amplifier MCC is turned off by vertical-axis brake control.

(Valid for editions 9030/N, 9040/C and later.)

8X84	Flexible feed gear numerator (SDMR1)
1977	Flexible feed gear numerator (SDMR1)

Data range : 1 to 32767

Standard setting : 0

1. SERVO PARAMETERS

Parameter No. Parameter

8X85	Flexible feed gear denominator (SDMR2)
1978	Flexible feed gear denominator (SDMR2)

Data range : 1 to 32767

Standard setting : 0

The flexible feed gear function can be used by setting SDMR1 and SDMR2 to a value not less than 1.

(Valid for editions 9030/J, 9031/H, 9040/A and later.)

For details, see the description of flexible feed gear setting in Subsection I-3.4.3.

8X86	Rated current parameter (RTCURR)
1979	Rated current parameter (RTCURR)

Data range : 1 to 32767

Standard setting : Depends on the motor

This parameter is used to display the percentage of actual-current-to-rated-current on the servo adjustment screen. The value depends on the motor used and is set automatically. Never change this value.

(Valid for editions 9030/J, 9040/A, and later.)

8X87	Torque offset for new backlash acceleration (TCPRLD)
1980	Torque offset for new backlash acceleration (TCPRLD)

Data range : 0 to 32767

Standard setting : 0

Set this parameter if there is a torque offset for a vertical axis when the new backlash acceleration function is used.

(Valid for editions 9030/K, 9040/B, and later.)

(For details of this function, see Subsection 2.5.3.)

1. SERVO PARAMETERS

Parameter No. Parameter

8X88	Machine speed feedback gain (MCNFB)
1981	Machine speed feedback gain (MCNFB)

Data range : 0 to 32767

Standard setting : 0

This parameter sets a feedback gain when the machine speed feedback function is used.
(Valid for editions 9030/K, 9040/B, and later.)

(For details of this function, see Subsection 2.3.2.)

8X89	Base pulse for backlash acceleration (BLBSL)
1982	Base pulse for backlash acceleration (BLBSL)

Data range : 0 to 32767

Standard setting : 0

This parameter prevents excess compensation when the backlash acceleration function is used.

(Valid for editions 9020/L, 9030/L, 9040/A, and later.)

(For details of this function, see Subsection 2.5.2.)

8X98	Phase shift compensation coefficient during deceleration (DEPVPL)
1991	Phase shift compensation coefficient during deceleration (DEPVPL)

Data range : 0 to 32767 (For details of this function, see Subsection 2.8.5.)

Standard setting : Depends on the motor.

This parameter determines what per cent of the value of parameter No. 8X57 (Series 0-C) or 1869 (Series 15) is used as the phase shift coefficient during deceleration. The standard setting must not be changed.

(Valid with 9040/E and later editions)

1. SERVO PARAMETERS

Parameter No. Parameter

Parameter No.	Parameter
8X99	Not used
1992	One-pulse suppression level for serial pulse coder A or B (ONEPSL)

Data range : 0 to 32767 (For details of this function, see Subsection 2.2.3.)

Standard setting : 400

This parameter determines the one-pulse suppression level for serial pulse coder A or B. It can be used only with a system of Series 15 whose parameters are extended.
(Valid with 9040/E and later editions)

1. SERVO PARAMETERS

1.2 Setting Method and Characters of the Velocity Loop Control Cycle 1 msec

A higher velocity loop gain can be obtained by changing the velocity loop control cycle to 1 msec. In machines that have weak rigidity, such as large machines and machines with long ball screws, the velocity loop gain may not be raised without vibration during machine stop. This function is very effective. Note however that in machines that have a resonance of 200 - 300 Hz there is a possibility that vibration will increase at high frequencies instead.

(1) Applicable Servo ROM Series/Versions

9020/001B and later	9031/001A and later	9040/001/A and later
9022/001B and later	9032/001A and later	(1 msec is used in Series 9040.)
9030/001A and later	9034/001A and later	

(2) Parameter Setting Method

a) When changing velocity loop control cycle from 2 msec to 1 msec

① Change velocity loop control period setting parameter.

Series 10, 11, 12	Series 0-A, -B, -C(16bit)	
No. 1809	No. 8X04	bit 1 = 1 → 0
Series 15	Series 0-C, (32bit)	(2msec) (1msec)
No. 1809	No. 8X04	bit 1 = 0 → 1
		(2msec) (1msec)

② Change velocity loop gain parameter.

Series 10, 11, 12, 15	Series 0	
No. 1855	No. 8X43 (PK1V)	* Set to 60% of 2msec value
No. 1857	No. 8X45 (PK3V)	$32768 - (32768 - PK3V) / 2$
		However, when 0 is set, leave the setting at 0.
No. 1858	No. 8X46 (PK4V)	-16471 → -8235

③ Change observer related parameter.

Series 10, 11, 12, 15	Series 0	
No. 1859	No. 8X47 (POA1)	* Set to half the 2msec value
No. 1862	No. 8X50 (POK1)	1677 → 956
No. 1863	No. 8X51 (POK2)	1788 → 510

1. SERVO PARAMETERS

- b) The method of setting the 1 msec standard parameter (motor model No. 39 and after) is the same as that for setting 2 msec parameters.

(Note) For the velocity loop control period, 2 axes are set as a pair (the 1st axis and the 2nd axis, the 3rd axis and the 4th axis, etc.). The period is decided by the parameter of the odd numbered axis. Therefore, it is not possible to set a 1 msec. interruption period for an even numbered axis only, or a 1 msec. period for an odd numbered axis only.

1. SERVO PARAMETERS

(3) Procedure to Use When High-frequency Vibration Arises from Setting a Velocity Loop Control Cycle of 1 msec

If the control cycle of the velocity loop is set to 1 ms, vibration when the machine has stopped may increase in machines having a machine resonance of 200 - 300 Hz.

In this case, by using a torque command filter, high-frequency vibration can be suppressed and by raising gain, precision and responsiveness can be increased.

① Method of setting

No. 8X06bit4 (Series 0)

Acceleration feedback is valid.

No. 1884bit4 (Series 10,11,12,15)

0→1

No. 8X67 (Series 0)

Torque command filter value

No. 1895 (Series 10,11,12,15)

For the setting value, refer to the 1 msec column in the table given below.

(Set the cut-off frequency at about 50% of the resonance frequency.)

Table 1.2 Torque command filter parameters

*Cut off frequency (Hz)	Velocity control cycle (msec)		
	2msec	1msec	0.25msec
60	1927	2810	3728
65	1810	2723	3698
70	1700	2638	3670
75	1596	2557	3641
80	1499	2478	3612
85	1408	2401	3584
90	1322	2327	3556
95	1241	2255	3528
100	1166	2185	3501
110	1028	2052	3446
120	907	1927	3392
130	800	1810	3339
140	705	1700	3287
150	622	1596	3236
160	548	1499	3186
170	484	1408	3136
180	427	1322	3087
190	376	1241	3039
200	332	1166	2992
220	258	1028	2899
240	201	907	2810
260	156	800	2723
280	121	705	2638
300	94	622	2557

1. SERVO PARAMETERS

1.3 Parameters Changed in Series 0-C

Between Series 0-C16bit and Series 0-C32bit, some of the servo parameters have been changed. Two types of changes have been made.

- ① First is for the change of the NC from Series 0-A and 0-B to Series 0-C
In Series 0-B and earlier, the standard parameter value had to be recalculated and changed according to the number of pulses of the pulse coder.
With series 0-C, however, this change is no longer required, thus simplifying parameter setting.
- ② Other is for the change of the NC from Series 0-C16bit to Series 0-C32bit
The servo software series is functionally upgraded from Series 9020 to Series 9030. With this upgrading, some of the servo parameter functions have been changed together with some setting values. If this change is not implemented, trouble such as motor vibration can occur.

(1) Applicable ROM Series

- ① The change of the NC from Series 0-A and 0-B Series 0-C is performed by NC software, so it is applicable to Series 0-C or any upgraded series, independently of the digital servo ROM edition.
- ② The change of the NC from Series 0-C16bit to Series 0-C32bit is performed by the change of servo software from Series 9020 to Series 9030. When power to the NC is turned on, the NC software series and edition are displayed on the screen together with the servo ROM series and edition. If such information is not displayed, Series 9020 (Series 0-C16bit) is used.

(2) Setting Parameters

- (a) For changing from series 0-A and 0-B to series 0-C16bit
For servo parameter setting in Series 0-B or earlier, the standard values of the following parameters had to be recalculated and changed according to the number of pulses of the pulse coder. In Series 0-C, however, the following standard values can be set without additional calculation. (Since the NC internally calculates the values according to the number of pulses, recalculation is not necessary.)

Parameter No.	Parameter name	Symbol
8X53	Current dead zone compensation	PPMAX
8X54	Current dead zone compensation	PDDP
8X56	Backelectromotive force compensation	EMFCMP
8X57	Phase-lead correction	PVPA

1. SERVO PARAMETERS

(b) For changing from series 0-A and 0-B to series 0-C32bit

Method 1 : Set the standard parameters

- ① Set the standard parameters. The conventional method (enter motor type no.) can be used without modification.
- ② Standard values that had to be changed to match the machine should still be changed as before. However, the following parameters are now changed by the CNC.

Parameter No.	Parameter name	Symbol
8X53	Current dead zone compensation	PPMAX
8X54	Current dead zone compensation	PDDP
8X56	Backelectromotive force compensation	EMFCMP
8X57	Phase-lead correction	PVPA

Method 2 : Set by changing conventional parameter values

- ① Enter the conventional parameters from tape or floppy disk into the NC (under emergency stop state).
- ② Then change the setting of 8X04 as described below.

Bit 1 sets a velocity control period, but it has the meaning opposite to the previous one. So change the setting of this bit from the previous setting.

Set the other bits as shown below.

	b7	b6	b5	b4	b3	b2	b1	b0
8X04	0	1	0	0	0	1	1 or 0	0

Before
 1 → 0 For 2ms
 0 → 1 For 1ms

- ③ Finally, change the following parameters to the standard values :

Parameter No.	Parameter name	Symbol
8X53	Current dead zone compensation	PPMAX
8X54	Current dead zone compensation	PDDP
8X56	Backelectromotive force compensation	EMFCMP
8X57	Phase-lead correction	PVPA

1. SERVO PARAMETERS

(c) For changing from series 0-C16bit to series 0-C32bit

Method 1 : Set the standard parameters

- ① Set the standard parameters. The conventional method (enter motor type no.) can be used without modification.
- ② Standard values that had to be changed to match to the machine should still be changed at setting as before.

Method 2 : Setting by changing conventional parameter values

- ① Enter the conventional parameters from tape or floppy disk into the NC (under emergency stop state).
- ② Then change the setting of 8X04 as described below.

Bit 1 sets a velocity loop control period, but it has the meaning opposite to the previous one. So change the setting of this bit from the previous setting.

Setting the other bits as shown below.

	b7	b6	b5	b4	b3	b2	b1	b0
8X04	0	1	0	0	0	1	1 or 0	0

Before
1 → 0 2ms
0 → 1 1ms

1. SERVO PARAMETERS

(3) Detailed Explanation of Parameters Changed with Series 0-C32bit

Parameter No.	Parameter							
8X03	VOFST	OVSCMP	BLENBL	1PSPRS	PIENBL	OBENBL	TGALRM	
	b7	b6	b5	b4	b3	b2	b1	b0
Standard setting :	0	0	0	0	0	0	0	0

With Series 9020, bit 0 is used for *NDL8, and its standard value is 1. With Series 9030, this bit is not used, and its standard value is 0.

(When the standard parameter setting method is used, bit 0 is set to 0.)

For bits 0 to 7, the same parameter meanings and settings as Series 0-A, B, C16bit apply.

8X04	DLY1	DLY0			TRW1	TRW0	TIB0	TIA0
	b7	b6	b5	b4	b3	b2	b1	b0
Standard setting :	0	1	0	0	0	1	0	0
							(Motor types 1 to 38)	
	0	1	0	0	0	1	1	0
							(Motor types 39 to 67)	

TIB0 Set a velocity loop control period :

0 : Sets 2 msec.

1 : Sets 1 msec.

(Note) For velocity loop control periods, the first and second axes are paired, and the third and fourth axes are paired. The velocity loop control period is determined by the parameter of the odd axis.

So if the first axis is selected from the standard parameters (39 or later) for 1 msec velocity control period, the second axis must also be selected from the standard parameters (39 or later) for 1-msec velocity control period.

DLY1, DLY0, TRW1, TRW0, TIA0

Be sure to set the standard values. Never change the standard values.

1. SERVO PARAMETERS

(4) Setting in Series 0-A, 0-B, and 0-C (16 bit)

Parameter No. Parameter

8X03	VOFST	OVSCMP	BLENBL	1PSPRS	PIENBL	OBENBL	TGALRM	*NDL8
	b7	b6	b5	b4	b3	b2	b1	b0

Standard setting : 0 0 0 0 0 0 0 1

8X04			TRW1	TRW0	TINA1	TINA0	TINB1	TINB0
	b7	b6	b5	b4	b3	b2	b1	b0

Standard setting : 0 0 0 1 1 0 1 0

In Series 0-A, 0-B, and 0-C (16 bits), the above standard values are set.
 Always set *NDL8 to 1. Be sure to always set the parameters of No. 8X04 to standard values.

1.4 Parameters to be Changed in Series 15

In the servo software 9030 and 9040 Series for Series 15, there have been some changes of the parameter setting method compared with the Series 10, 11 and 12.

(1) Applicable Servo ROM Series/Versions

Because the servo software for Series 15 is the 9030 and 9040 Series, it can be used for all applications of this series.

Series 9030/001A version and later Series 9040/001A version and later

(2) Parameter Setting Method

For servo parameter setting in Series 10, 11, and 12, the following parameters had to be recalculated and changed according to the number of pulses of the pulse coder. In Series 15, however, the following standard values can be set without additional calculation. (Since the NC internally calculates the values according to the number of pulses, recalculation is not necessary.)

Parameter No.	Parameter name	Symbol
1865	Current deadband range compensation	PPMAX
1866	Current deadband range compensation	PDDP
1868	Back electric motive force compensation	EMFCMP
1869	Phase control compensation	PVPA

(Note) However, in the case of setting the 0.1 μ detection (set PLC01 for high-resolution setting 1804 bit 0 PLC01 to "1"), for version numbers of the NC ROM other than those written below (old version) the calculation described above is not performed.

Machine type name	(Series)	Version number
Series 15 AM9A	(A001)	B version and earlier
Series 15 AM14	(A002)	D version and earlier
Series 15 AT9A	(A201)	A version and earlier
Series 15 AT14	(A202)	A version and earlier
Series 15 MM9A	(AA01)	B version and earlier
Series 15 MM14	(AA02)	B version and earlier
Series 15 MF	(A102)	A version and earlier
Series 15 MT	(A302)	A version and earlier
Series 15 MM9A	(AA03)	A version and earlier
Series 15 49A	(A401)	A version and earlier
Series 15 A414	(A402)	B version and earlier
Series 15 MF	(AB02)	A version and earlier

Therefore, if setting 0.1 μ detection (set PLC01 1804 bit0 to "1"), either replace with a new ROM or perform the calculation given below and change the parameter data.

1. SERVO PARAMETERS

Parameter No.	Parameter name	Symbol	Calculation
1865	Current deadband range compensation	PPMAX	Set value × 10
1866	Current deadband range compensation	PDDP	Set value/10
1868	Back electric motive force compensation	EMFCMP	Set value/10
1869	Phase control compensation	PVPA	Set value/10

(3) Parameter where meaning has changed in Series 15

Parameter No. Parameter

1808	VOFST	OVSCMP	BLNBL	1PSPRS	PIENBL	OBENBL	TGALRM	
	b7	b6	b5	b4	b3	b2	b1	b0
Standard setting :	0	0	0	0	0	0	0	0

Bit 0 was 1 by standard setting(It was *NDL8 in series 9020.)

This bit is 0 by standard setting (unused in series 9030.)

Bits 1 to 7 do not change in meaning and setting compared with Series 10 and 11.

1809	DLY1	DLY0			TRW1	TRW0	TIB0	TIA0
	b7	b6	b5	b4	b3	b2	b1	b0
Standard setting :	0	1	0	0	0	1	0	0
								(Motor types 1 to 38)
	0	1	0	0	0	1	1	0
								(Motor types 39 or later)

TIB0 Velocity loop control cycle :

0 : Sets 2 msec.

1 : Sets 1 msec.

(Note) For velocity loop control periods, axes are grouped in pairs (the first and second axes, the third and fourth axes, etc.). The velocity loop control period is determined by the parameter of the odd axis.

Therefore, when the 1st axis velocity control cycle is selected from the 1 msec velocity control parameters (39 or later), the 2nd axis must also be selected from the 1 msec velocity control parameters (39 or later).

DLY1, DLY0, TRW1, TRW0, TIA0

Be sure to use the standard setting values. Don't change.

1. SERVO PARAMETERS

(4) Setting in Series 10, 11, and 12

Parameter No.	Parameter							
1808	VOFST	OVSCMP	BLENBL	1PSPRS	PIENBL	OBENBL	TGALRM	*NDL8
	b7	b6	b5	b4	b3	b2	b1	b0
	Standard setting :	0	0	0	0	0	0	1
1809			TRW1	TRW0	TINA1	TINA0	TINB1	TINB0
	b7	b6	b5	b4	b3	b2	b1	b0
	Standard setting :	0	0	0	1	1	0	1

In Series 10, 11, and 12, the above standard values are set. Always set *NDL8 to 1. Be sure to always set the parameters of No. 1809 to standard values.

2. SERVO FUNCTIONS

2.1 Servo Functions According to Software Versions

2.1.1 Servo functions according to software versions

As of May 1, 1991

Function \ Series	General machine tool							High-speed positioning		
	90000	90010	90120	90230	90331	90410	90022	90222	90322	
I-P or PI control	E	B	A	A	A	A	A	C	A	A
1-pulse suppression	E	B	A	A	A	A	A	C	A	A
1-pulse suppression for serial	-	-	-	-	-	-	E	-	-	-
OVC alarm	E	B	A	A	A	A	A	C	B	A
TG alarm A	E	B	A	A	A	A	A	C	A	A
TG alarm B inductosyn	H	E	A	A	A	A	A	C	A	A
TG alarm C level variable	J	F	A	A	A	A	A	C	A	A
TG alarm D full-closed	S	N	E	E	A	A	A	-	B	A
Observer	J	F	A	A	A	A	A	C	A	A
VCMD offset	F	D	A	A	A	A	A	-	B	A
Correction torque	H	E	A	A	A	A	A	-	-	-
Backlash acceleration A semi-closed	H	E	-	-	-	-	-	-	A	-
Backlash acceleration B semi/full-closed	S	N	-	-	-	-	-	-	-	-
Backlash compensation acceleration C	-	-	A	A	A	A	A	-	B	A
Backlash compensation acceleration D	-	-	G	J	F	A	A	-	-	A
Backlash compensation acceleration E	-	-	-	-	I	C	A	-	-	A
Backlash compensation acceleration F	-	-	-	-	K	-	B	-	-	-
Overshoot compensation A	K	G	A	A	A	A	A	-	B	A
Overshoot compensation B	-	-	-	J	F	A	A	-	-	A
Hybrid function	-	-	-	-	-	A	-	-	-	-
Dual position feedback function	-	-	-	-	-	F	-	-	-	-
Tandem function	-	-	-	-	-	D	-	-	-	-

The letters of the alphabet show the ROM versions.

2. SERVO FUNCTIONS

Function \ Series	General machine tool							High-speed positioning		
	9000	9001	9010	9020	9030	9031	9040	9022	9022	9032
TG/overload subdivided	S	N	E	D	A	A	A	—	B	A
OVC alarm actual current detection	—	—	B	A	A	A	A	—	A	A
Torque monitor actual current detection	—	—	B	B	A	A	A	—	B	A
Velocity loop control cycle 1 msec	—	—	—	B	A	A	A	—	B	A
Speed-dependent current loop gain variable	—	—	—	B	A	A	A	—	B	A
Acceleration feedback A	—	—	—	E	E	A	A	—	—	—
Acceleration feedback B	—	—	—	—	—	—	—	F	A	A
Acceleration feedback C	—	—	—	—	M	—	C	—	—	—
Feedforward control A	—	—	E	D	A	A	A	—	B	A
Feedforward control B	—	—	—	—	I	C	A	—	—	A
Feedforward control C	—	—	—	—	J	D	A	—	—	—
Minus backlash compensation	—	—	F	F	A	A	A	—	B	A
Integration at low speeds	—	—	—	—	—	—	—	C	A	A
Position gain switching	—	—	—	—	—	—	—	J	A	A
Back electric motive force compensation enabled	K	G	A	A	A	A	A	C	A	A
Back electric motive force compensation enabled when decelerating	R	M	D	C	A	A	A	J	A	A
Flexible feed gear	—	—	—	—	J	H	A	—	—	C
Full-close speed feedback function A	—	—	—	—	K	E	B	—	—	C
Full-close speed feedback function B	—	—	—	—	—	—	C	—	—	—
VCMD serial out variable waiting function	—	—	—	—	K	E	A	—	—	C
Disturbance-estimation observer function	—	—	—	—	M	—	—	—	—	—
Vertical axis brake control function	—	—	—	—	N	—	C	—	—	—
Function for setting a 10000-pulse pulse coder	—	—	—	—	N	H	D	—	—	—

The letters of the alphabet show the ROM versions.

2. SERVO FUNCTIONS

Series	General machine tool							High-speed positioning		
	9 0 0 0	9 0 0 1	9 0 1 0	9 0 2 0	9 0 3 0	9 0 3 1	9 0 4 0	9 0 2 2	9 0 2 2	9 0 3 2
Function for changing the phase shift compensation at deceleration	—	—	—	—	—	—	D	—	—	—
Function for enlarging the position gain setting range	—	—	—	—	O	H	D	—	—	—

The letters of the alphabet show the ROM versions.

(Note 1) The digital servo ROM should be replaced with that of the same series. If a ROM from a different series is used, an error may occur.

(Note 2) TG alarm A/B/C/D

TG alarm B adds TG alarm for inductosyn to TG alarm A.

TG alarm C makes alarm levels variable to TG alarm B.

TG alarm D partially changes TG alarm detection for full closed loop to TG alarm C. (Upgraded)

(Note 3) Backlash acceleration

Backlash acceleration A is backlash acceleration in semi-closed.

Backlash acceleration B adds a full closed loop backlash acceleration to Backlash acceleration A.

Backlash acceleration C upgrades backlash acceleration B.

It is possible to precisely control backlash acceleration.

Backlash acceleration D upgrades backlash acceleration C and prevents excessive compensation.

E allows backlash acceleration to be increased 10 times.

Backlash acceleration F is an improved version of E. It simplifies parameter setting and enables optimum acceleration, regardless of the cutting conditions.

(Note 4) Feed forward control

As B is an upgraded form of A, and provides quick response by simultaneously reducing acceleration/deceleration shock and applying feed forward to the speed loop.

(Note 5) Acceleration feedback

A is 1-msec acceleration feedback for general machine tools.

B is 250- μ sec acceleration feedback for high-speed positioning machines.

C is 250- μ sec acceleration feedback for general machine tools.

(Note 6) Overshoot correction

Overshoot correction B has reduced fluctuation at stop compared with A.

(Note 7) Full close speed feedback

B allows the coefficient of fully-closed speed feedback to be increased by a factor of 10.

2.1.2 Digital servo ROM for Power Mate

The table below shows the relationship between the Power Mate and the series and editions of digital servo ROM.

Power Mate	Applicable pulse coder	Series of servo ROM	Latest edition
MODEL A	Phase-A/B pulse coder	9034	F
MODEL B	Phase-A/B pulse coder	9044	A
	Serial pulse coder	9054	B
MODEL C	Serial pulse coder only	9050	H

(Note) The servo ROM of series 9054 can control phase-A/B pulse coder and serial pulse coders A and B. The servo ROM of series 9050 can control serial pulse coders A, B, and C.

Series and Editions of Servo ROM and the Functions

Series of servo ROM	Edition	Servo functions provided	Motor type
Series 9034	A	Same functions as series 9030, edition E	3 to 72
	B	Functions of series 9030, edition I and the flexible feed gear function	3 to 73
	D	Function for changing the weight of the VCMD serial out Machine velocity feedback function New backlash acceleration	3 to 78
	E	Dual position feedback function 250- μ s acceleration feedback function	3 to 84
	F	Function for setting a 10000-pulse pulse coder Function for enlarging the position gain setting range	3 to 84
Series 9044	A	Same functions as series 9034, edition D	3 to 78
Series 9054	A	Same functions as series 9040, edition B	3 to 83
	B	Same functions as series 9054, edition A	3 to 84
Series 9050	See Part III.		

2. SERVO FUNCTIONS

Each servo parameter of the Power Mate corresponds to a servo parameter of Series 0-C or 16. The two rightmost digits of the numbers of the parameters corresponding to each other are identical.

Power Mate-MODEL A, B	Series 0-C	
10□□	8X□□	(X indicates the axis number.)
		First axis : X = 1
		Second axis : X = 2
Power Mate-MODEL C	Series 16	
1X□□	20□□	(X indicates the axis number.)
		First axis : X = 0
		Second axis : X = 2

When setting a servo parameter of the Power Mate, read the description of the servo parameter corresponding to it.

2.2 Functions for Suppressing Vibration at Machine Stop

Two functions are provided to suppress vibration at machine stop; the compensation torque command and the one-pulse suppression function.

2.2.1 Compensation torque command function

The following is a block diagram for when the compensation torque command is used.

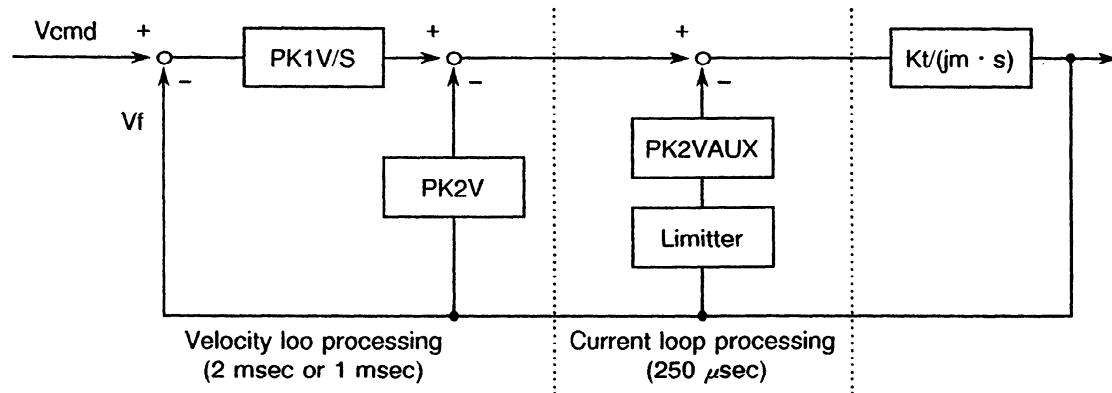

Fig. 2.2.1

As shown in the figure above, command function operates in a high-speed current loop as the proportional term, $PK2V$, operates in a velocity loop. This reduces the instability due to the time lag of the software and the vibration during stopping and low-speed operation.

However, this function only compensates one pulse in 250 μ sec. Therefore, this function is not activated at a speed exceeding 4kpps (4k pulses per second). If the compensation is made excessively, the vibration during stopping often becomes higher or overshoot occurs. Vibration may occur during feeding. When this function is used, check that no vibration occurs with a feedrate of 4 kpps or less after parameter setting.

(1) Applicable Servo ROM Series/Versions

Series	9000/1H edition or later	9020/1A edition or later	9040/1A edition or later
	9001/1E edition or later	9030/1A edition or later	
	9010/1A edition or later	9031/1A edition or later	

(Note) In the 9002 and 9022 series, this function is not supported.

(2) Parameter Setting

- ① Set $PK2VAUX$ to 500000/N with parameter number 8X66 (series 0) or 1894 (series 10/11/12/15). Character Np indicates the number of pulses of the pulse coder.
- ② Adjust the $PK2VAUX$ value and set a parameter which eliminates vibration during stopping and eliminates overshoot.
- ③ Feed at a speed of 4 kpps or less and check that no vibration occurs.

2.2.2 One-pulse suppression function

This function suppresses the vibration with a digital servo motor while the machine is stopping.

(1) Applicable Servo ROM Series/Versions

9020/001 Edition A and after	9031/001 Edition A and after
9022/001 Edition A and after	9032/001 Edition A and after
9030/001 Edition A and after	9040/001 Edition A and after

(2) Setting the Parameter for the One-Pulse Suppression Function

No.8X03 (Series 0), No.1808 (Series 10, 11, 12, 15)
 Bit 4 = 1 The one-pulse suppression function is valid.

(3) Detailed Explanation

This function suppresses only the vibration while the machine is stopping.
 Suppose that a motor is vibrating due to a disturbance as shown below. When the one-pulse suppression function is validated the first feedback pulse after reversal is not longer allowed to enter the proportional term PK2V in the velocity loop. This prevents the vibration caused by the disturbance from being strengthened by the proportional term and suppresses the vibration while the machine is stopping. Only one pulse after reversal can be suppressed by the one-pulse suppression function.
 Therefore, this function does not work for vibrations of more than one pulse during stopping or any vibration during movement.

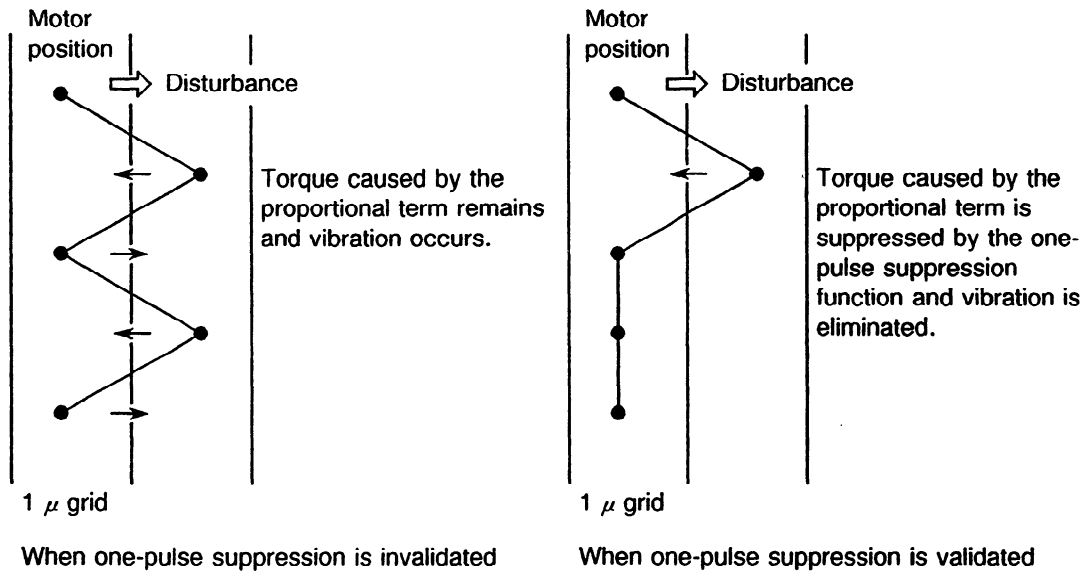

2.2.3 One-pulse suppression function for serial pulse coder A or B

The one-pulse suppression function for serial pulse coder A or B suppresses vibrations when the machine stops.

(1) Series and editions of applicable servo ROM

Series 9040, edition E and later editions

(2) Setting parameters

① Related parameters

Bit for validating the function : Bit 4 of parameter No. 8X03 (Series 0-C) or No. 1808 (Series 15): When the bit is set to 0, the function is invalidated. When the bit is set to 1, the function is validated.

Bit for specifying the suppression level : Parameter No. 1992 (Series 15)

(Note) Series 0-C does not have a parameter for setting the suppression level. The level of 400 is automatically selected.

In Series 15 with the NC software whose servo parameter area is not extended, the suppression level parameter cannot be used. The level is always set to 400.

② Meanings of parameters

(a) The function is validated or invalidated by bit 4 of parameter No. 8X03 (Series 0-C) or 1808 (Series 15) as in the conventional system.

(b) The parameter for specifying the suppression level is valid for serial pulse coder A or B. It cannot be used for pulse coder C.

When 0 is specified as the level parameter of Series 15, the suppression level is automatically set to 400. However, the required suppression level can be specified, depending on the number of position feedback pulses.

The expression below represents the relationship between the number of position feedback pulses and the level parameter:

$$\text{Level parameter} = \frac{4000000 \text{ (strictly, } 2^{22}\text{)}}{\text{Number of position feedback pulses/rev}}$$

The level parameter is inversely proportional to the number of position feedback pulses. The standard setting of the parameter is geared to 10000 position feedback pulses per revolution. If the standard setting cannot suppress vibrations when the machine stops, calculate the required value according to the expression above and use the calculated value.

2.3 Machine-resonance Suppression Function

2.3.1 Acceleration feedback function

The acceleration feedback function is used to control velocity loop oscillation by using motor velocity feedback signal multiplied by the acceleration feedback gain to compensate the torque command.

This function can stabilize a servo that is unstable when motor and machine have a spring coupling or when the external inertia is great compared to the motor inertia. It makes the motor inertia appear larger. This is effective when vibration is about 50 to 150Hz.

Fig. 2.3.1 is a velocity loop block flow chart that includes acceleration feedback function.

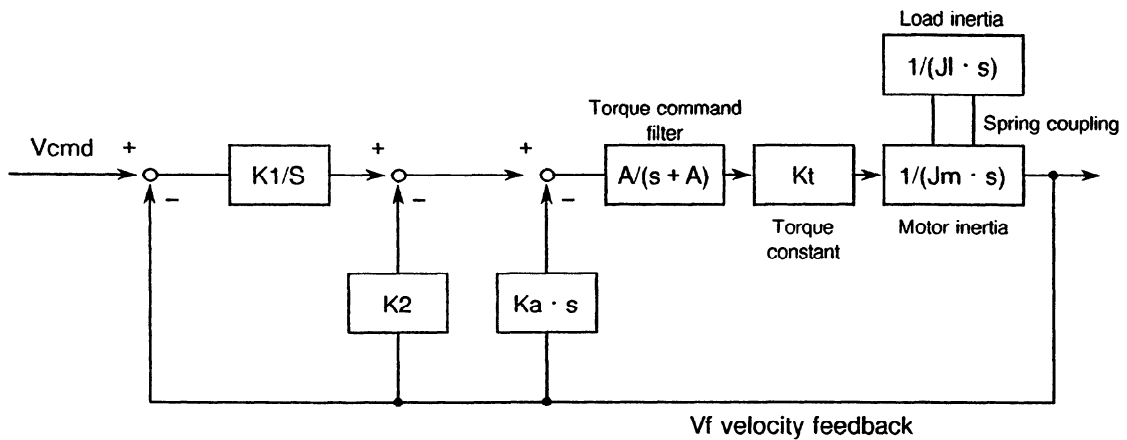

- K1 : velocity loop integral gain
- K2 : velocity loop ratio gain
- Ka : acceleration feedback gain

Fig. 2.3.1 Velocity Loop Block Flow Chart

When this acceleration feedback function is used, sampling noise may be generated. A torque command filter is inserted to remove this noise.

(1) Applicable Servo ROM Series/Versions

- Series 9020/001E and subsequent editions
- 9030/001E and subsequent editions
- 9031/001A and subsequent editions
- 9040/001A and subsequent editions

(Note) It is possible to use the acceleration feedback function in the high speed positioning function software (9002, 9022 and 9032 series), but the gain and filter settings differ. (See Section 2.11.4)

(2) Parameter Setting

(a) Set the speed loop control cycle to 1 msec.

- Series 0-B/0-C (16 bit)
Set bit 1 of No.8X04 to 0 from 1.
- Series 0-C (32 bit)
Set bit 1 of No.8X04 to 1 from 0.
- Series 10, 11, 12
Set bit 1 of No.1809 to 0 from 1.
- Series 15
Set bit 1 of No.1809 to 1 from 0.

(b) Function bit

- Series 0
Set bit 4 of No.8X06 to 1 from 0.
- Series 10, 11, 12, 15
Set bit 4 of No.1884 to 1 from 0.

(c) Function parameter

Set values in parameters No.8X76 (Series 0) and No. 1969 (Series 10, 11, 12, and 15) by referring to the following standard values.

For normal pulse coder	:	Approx. 50 to 70
For high-resolution pulse coder	:	Approx. 10 to 15
For serial pulse coder	:	Approx. 200 to 300

If the acceleration feedback gain is too big, vibrations will occur during acceleration and deceleration. In this case decrease the feedback gain.

When the acceleration feedback function is used, it is necessary to insert a torque command filter. Set 1100 to No.8X67 (Series 0) and No.1895 (Series 10, 11, 12, 15).
(Never input 2400 or more; the vibration may be increased.)

When changing the parameter of the torque command filter, refer to the "Velocity control cycle msec." item in Table 2.3.1.

2. SERVO FUNCTIONS

Table 2.3.1 Parameters of torque command filter
No.8X67 (Series 0), No.1895 (Series 10, 11, 12, 15)

Cut-off Frequency (Hz)	Velocity control cycle (msec.)		
	2 msec	1 msec	0.25 msec
60	1927	2810	3728
65	1810	2723	3698
70	1700	2638	3670
75	1596	2557	3641
80	1499	2478	3612
85	1408	2401	3584
90	1322	2327	3556
95	1241	2255	3528
100	1166	2185	3501
110	1028	2052	3446
120	907	1927	3392
130	800	1810	3339
140	705	1700	3287
150	622	1596	3236
160	548	1499	3186
170	484	1408	3136
180	427	1322	3087
190	376	1241	3039
200	332	1166	2992
220	258	1028	2899
240	201	907	2810
260	156	800	2723
280	121	705	2638
300	94	622	2557

(3) 250- μ sec acceleration feedback function

If vibration of the machine at stop is too violent for the 1-msec acceleration feedback function to operate normally, the 250- μ sec acceleration feedback function can be applied in the following series and versions.

(a) Applicable ROM series/versions

9030 series 1M version and later
9040 series 1C version and later

(b) Parameter setting

Invalidate the 1-msec acceleration feedback function.

Then set a negative value in the PK2VAUX parameter. The 250- μ sec acceleration feedback function will then be validated automatically.

Set the following value for the 250- μ sec acceleration feedback function:

- No.8X66 (Series 0-C), No.1894 (Series 15)
- For normal resolution pulse coder : Approx. - 500 to - 1000
- For high-resolution pulse coder : Approx. - 100 to - 200
- For serial pulse coder : Approx. - 10 to - 20

2.3.2 Machine speed feedback function

In many fully closed systems, the machine position is detected by a separate detector and positioning was controlled according to the detected positioning information. The speed is controlled by detecting the motor speed with the pulse coder on a motor. When distortion or shakiness between the motor and the machine is big, the machine speed differs from the motor speed during acceleration and deceleration. Hence, it is difficult to maintain high position loop gain. This machine speed feedback function allows adding the speed of the machine itself to the speed control in a fully closed system, making the position loop stable.

(1) Applicable Servo ROM Series/Versions

- 9030 Series 001 Edition K and after
- 9040 Series 001 Edition A and after

(2) Control Block Diagram

Fig. 2.3.2 is a control block diagram.

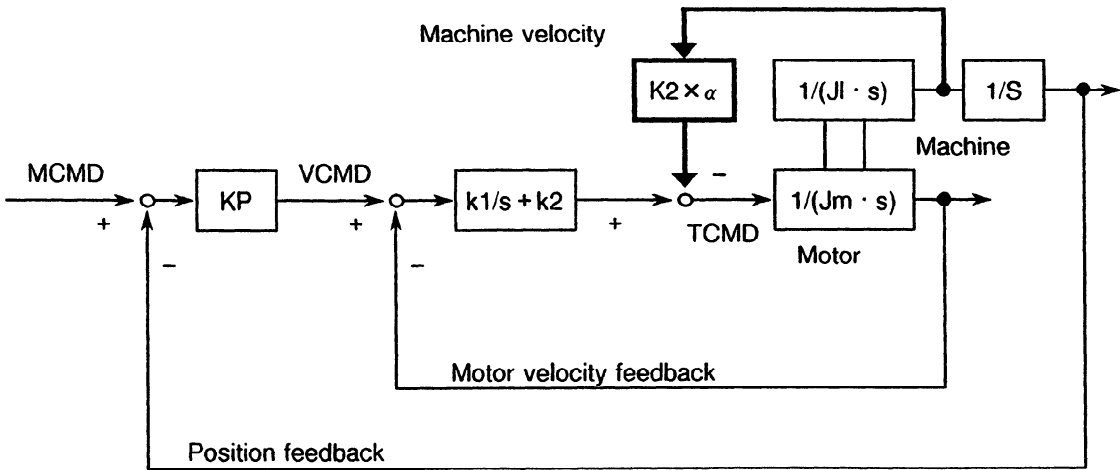

Fig. 2.3.2

As shown in Fig.2.3.2, this function corrects the torque command by multiplying the machine speed by coefficient, α , as shown by the bold line. When $\alpha = 1$, the torque command is corrected equally by the motor speed and the machine speed.

2. SERVO FUNCTIONS

(3) Parameter Set-Up

Functional bit

When bit 1 = 1 in No.1956 (Series 15) or No.8X12 (Series 0-C), this function is validated.

Feedback coefficient MCNFB No.1981 (Series 15) , No.8X88 (Series 0-C)

$MCNFB = 4096 \times \alpha \times (PULCO)/(PPLS)$

PULCO Number of speed feedback pulses per motor revolution

No.1876 (Series 15), No.8X23 (Series 0-C)

PPLS Number of position feedback pulses per motor revolution

No.1891 (Series 15), No.8X24 (Series 0-C)

The value of α will be about 0.3 to 1.0.

If a machine has a resonant frequency of about 200Hz to 400Hz, the resonance can be amplified by feeding back the machine speed, resulting in noise and/or vibration. If this happens, eliminate the resonance using either of the following procedures.

(a) Using a torque command filter

(b) Using an observer (When the observer is validated after the machine speed feedback function is validated, both the motor speed and the machine speed are filtered by the observer at the same time.)

See Section 2.3.3 for how to set the parameters of (a) and (b).

2.3.3 Observer and torque command filter

The observer and torque command filter are used to eliminate the high-frequency component and to stabilize a velocity loop when a mechanical system resonates at high frequency of several hundred Hertz.

The observer is a status observer that estimates the controlled status variables using mainly the software (sometimes capacitors, resistors, or operational amplifiers.)

In a digital servo system, the speed and disturbance torque in the control system are defined as status variables. They are also estimated in the observer. An estimated speed consisting of two estimated values is used as feedback. The observer interrupts the high-frequency component of the actual speed when it estimates the speed. High-frequency vibration can thus be eliminated.

The torque command filter applies a primary low-pass filter to the torque command to prevent high-frequency resonance, as does the observer.

This appendix first describes the observer and torque command filter, then compares their characteristics.

(1) Observer

Fig. 2.3.3 (a) shows a block diagram of the velocity loop including an observer.

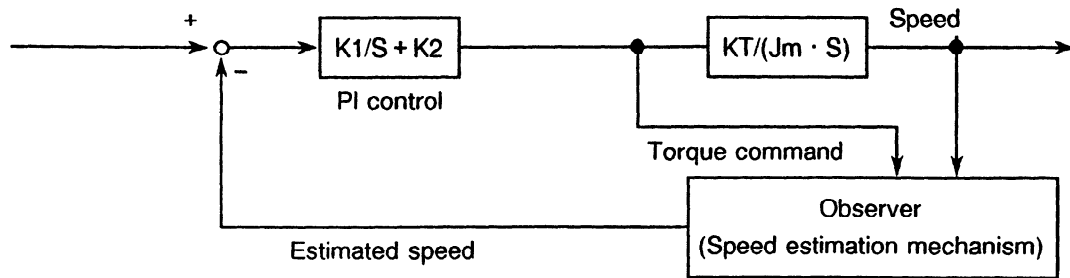

Fig. 2.3.3 (a) Configuration of velocity loop including observer

Fig. 2.3.3 (b) shows a block diagram of the observer.

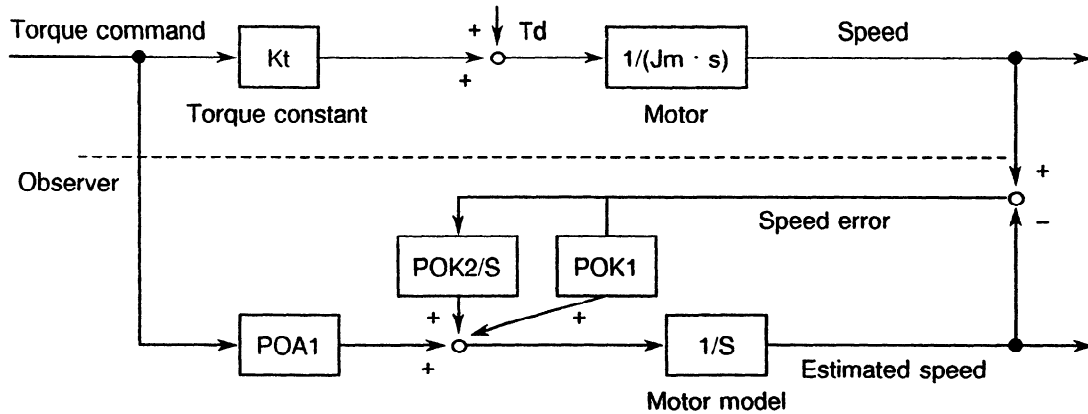

Fig. 2.3.3 (b) Observer model

POA1, POK1, and POK2 in Fig. 2.3.3 (b) correspond to digital servo parameters. The observer has an integrator as a motor model. POA1 is a coefficient that converts the torque command into motor acceleration and is the characteristic value of the motor. The motor model is accelerated by this value. The actual motor is also accelerated by the torque and disturbance torque that it generates.

The disturbance torque works on the actual motor. There is a time lag in the current loop. The POA1 value does not completely coincide with the actual motor. This is why the motor's actual velocity (velocity fb) differs from the motor speed estimated by an observer. The observer is compensated by this difference. The motor model is compensated proportionally (POK1), and the observer is compensated integrally (POK2/s).

POK1 and POK2 act as a secondary low-pass filter between the actual speed and estimated speed. The cutoff frequency and damping are determined by the POK1 and POK2 values. The difference between the observer and low-pass filter lies in the existence of a POA1 term.

2. SERVO FUNCTIONS

Using POA1, the observer's motor model can output an estimated speed that has a smaller phase delay than the low-pass filter.

When an observer function is validated, the estimated speed in Fig. 2.3.3 (b) is used as velocity feedback to the velocity control loop. A high-frequency component (100 Hz or more) contained in the actual motor speed due to the disturbance torque's influence may be further amplified by the velocity loop, and make the entire system vibrate at high frequency. The high frequency contained in the motor's actual speed is eliminated by using the velocity feedback that the observer outputs. High-frequency vibration can be suppressed by feeding back a low frequency with the phase delay suppressed.

(a) Parameter setting

- ① No.1808 (Series 10, 11, 12, 15), No.8X03 (Series 0) Bit 2 = 1 Observer validity
- ② No.1859 (Series 10, 11, 12, 15), No.8X47 (Series 0) POA1
 No.1862 (Series 10, 11, 12, 15), No.8X50 (Series 0) POK1
 No.1863 (Series 10, 11, 12, 15), No.8X51 (Series 0) POK2

Use the POA1, POK1, and POK2 values that are set as standard. Change these parameters when a velocity loop control cycle is changed to 1 msec.

The cutoff frequency and the POK1 and POK2 parameter values are shown in Table 2.3.3.

Table 2.3.3 Cutoff Frequency and the POK1 and POK2 Parameter Values

Cutoff frequency (Hz)	Velocity loop control cycle: 2msec		Velocity loop control cycle: 1msec	
	POK1	POK2	POK1	POK2
10	666	237	348	62
20	1220	867	666	237
30	1677	1788	956	510
40	2053	2918	1220	867
50	2359	4192	1460	1297
60	2607	5560	1677	1788
70	2807	6983	1874	2332

The standard parameter is set so that the cut-off frequency of the filter is 30Hz. Filtering, however, is especially effective for vibration frequencies from 150Hz to 180Hz.

Generally, the observer is not effective unless its cut-off frequency is 1/5 to 1/6 of the disturbance frequency. If, however, this band is too low (20Hz or less), the velocity loop gain may be too low, causing a drift or surge. Normally set at least 1.5 times the velocity loop bandwidth (typically 20 Hz so set cutoff frequency 30 Hz).

(2) Torque Command Filter

The torque command filter applies a primary low-pass filter to the torque command. Fig. 2.3.3 (c) shows the configuration of a velocity loop including the torque command filter.

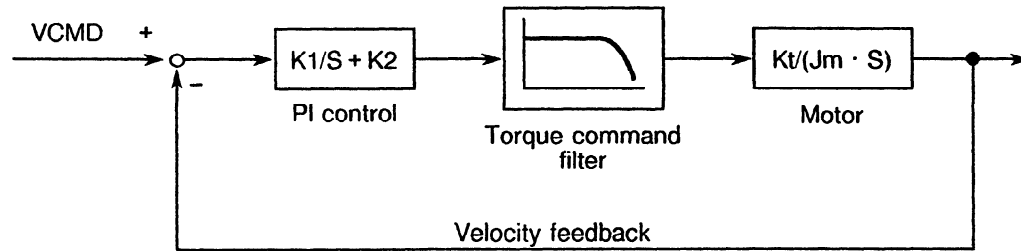

Fig. 2.3.3 (c) Configuration of velocity loop including torque command filter

As shown in Fig. 2.3.3 (c), the torque command filter applies a low-pass filter to the torque command calculated by the velocity loop. When a mechanical system contains a high resonant frequency of more than 100Hz, the resonant frequency component is also contained in the velocity feedback shown in Fig 2.3.3 (c) and may be amplified by proportional term. However, the resonance is prevented by interrupting the high-frequency component of the torque command using the filter.

(a) Parameter setting

- ① No.1865 (Series 10; 11, 12, 15) and No.8X67 (Series 0)

See Table 2.3.1 in Section 2.3.1 for the relationships between the cut-off frequency of the torque command filter and parameters.

If the cutoff frequency is set to a half of the resonant frequency, the filter operation is effective. If the cutoff frequency is set to less than 80Hz, the entire velocity loop fluctuates and cannot be controlled stably. (Normally set 4 times the velocity loop bandwidth which is typically set at 20 Hz. So set cutoff at 80 Hz).

(3) Proper User of the Observer and Torque Command Filter

The torque command filter is set in the forward direction. Therefore, there are fewer bad influences exerted upon the entire velocity control system than the observer that filters a feedback signal. If the resonance is very strong and it cannot be eliminated, use the observer. Use the torque command filter first when the mechanical system resonates at high frequency. If the resonance cannot be eliminated, use the observer.

2.3.4 Disturbance-estimation observer

An ordinary digital servo observer estimates the motor speed and disturbance with software so that the delay can be reduced as much as possible. It suppresses machine resonance by removing the high frequency resonance component included in the actual speed of the motor.

This type of conventional observer is used as the disturbance estimation observer. However, in this observer, not estimated speed but the estimated value of the disturbance torque on the motor is fed back to the torque command. This function increases the rigidity of the servo system especially for disturbances of 10Hz to 30Hz.

(1) Applicable servo ROM series/versions

9030 series/M version and later

(2) Control block diagram

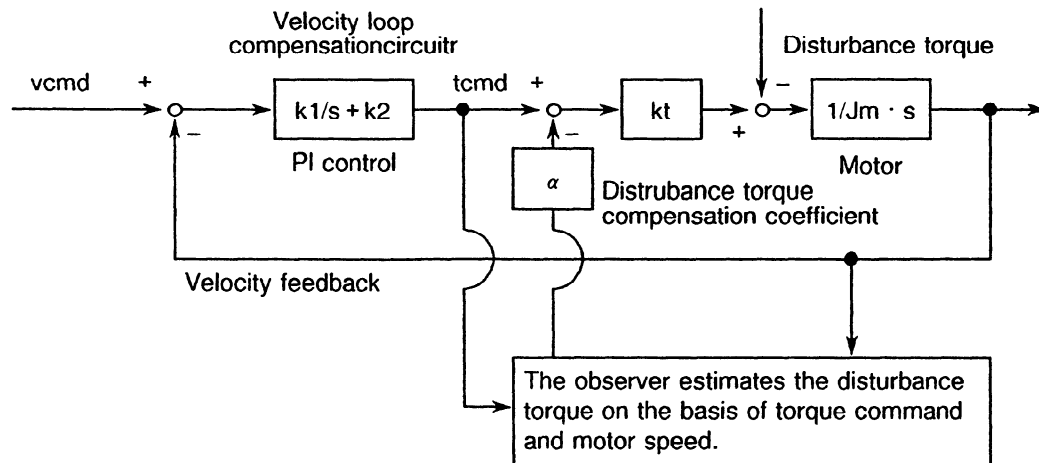

Fig. 2.3.4 Velocity Loop Configuration Using Disturbance Estimation Observer

This observer reduces the effect of disturbance by estimating the disturbance torque on the motor, and compensating the torque command on the basis of the estimated value. This function is effective in suppressing disturbances from 10Hz to 30Hz.

This function cannot be used along with an ordinary observer function.

(3) Parameter setting

- (a) Set the velocity loop control period to 1 msec.
- For Series 0-C (32 bits) : Change No.8X04, bit 1 from 0 to 1.
 - For Series 15 : Change No.1809, bit 1 from 0 to 1.

2. SERVO FUNCTIONS

(b) Function bit

No.8X12 (Series 0-C), No.1956 (Series 15), bit 6 = 1

(c) Changing observer parameters

Change parameters as follows:

POK1 No.8X51 (Series 0-C), No.1862 (Series 15) : 956 → 3570

POK2 No.8X52 (Series 0-C), No.1863 (Series 15) : 510 → 1269

(d) Setting the torque command compensation coefficient () for the disturbance estimation observer

Set the following values to the ROBUST No.8X90 (Series 0-C) and No.1983 (Series 15).

For normal pulse coder : Approx. 2000 to 3000

For high-resolution pulse coder : Approx. 500 to 1000

2.3.5 Dual position feedback function

A machine with a great backlash may cause vibrations in a closed loop system even if it works steadily in a semi-closed loop system. The dual position feedback function controls the machine so that it operates as steadily as in the semi-close system.

(1) General control method

The following block diagram shows the general method of dual position feedback control:

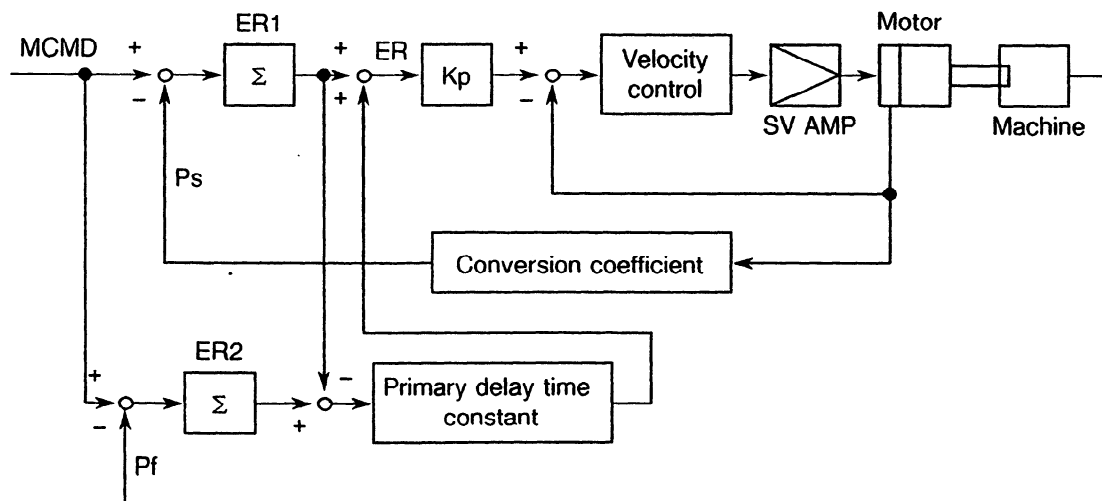

As shown in the diagram above, error counter ER1 in the semi-closed loop system and error counter ER2 in the closed loop system are used. The primary delay time constant is calculated as follows:

$$\text{Primary delay time constant} = (1 + \tau s)^{-1}$$

2. SERVO FUNCTIONS

The actual error, ER, depends on the time constant, as described below:

- 1) When time constant τ is 0
 $ER = ER1 + (ER2 - ER1) = ER2$ (error counter of the closed loop system)
- 2) When time constant τ is ∞
 $ER = ER1$ (error counter of the semi-closed loop system)

This shows that control can be changed according to the primary delay time constant. The semi-closed loop system applies control at the transitional stage and the closed loop system applies control in positioning.

This method allows vibrations during traveling to be controlled as in the semi-closed loop system.

(2) Series and editions of applicable servo ROM

Series 9031, edition F and later editions

Series 9050, edition F and later editions

(3) Parameters

Series 0-C	Series 15	Series 16, 18	
No. 8X11	No. 1955	No. 2019	bit 7 : Validates the dual position feedback function.
No. 8X49	No. 1861	No. 2049	: Specifies the maximum amplitude of dual position feedback.
No. 8X78	No. 1971	No. 2078	: Specifies a conversion coefficient of dual position feedback.
No. 8X79	No. 1972	No. 2079	: Specifies a conversion coefficient of dual position feedback.
No. 8X80	No. 1973	No. 2080	: Specifies a primary delay time constant (ms) of dual position feedback.
No. 8X81	No. 1974	No. 2081	: Specifies the zero-point amplitude of dual position feedback.

(4) Setting parameters

Series 0-C Series 15 Series 16, 18

No. 8X11	No. 1955	No. 2019	bit 7	:	Validates the dual position feedback function.
----------	----------	----------	-------	---	--

When the bit is set to 1, the function is validated.
--

2. SERVO FUNCTIONS

Series 0-C Series 15 Series 16, 18

No. 8X49	No. 1861	No. 2049	:	Specifies the maximum amplitude of dual position feedback.
Data unit	:	Minimum detection unit in the closed loop system ($\mu\text{m}/\text{p}$) $\times 64$		
Set value	:	Maximum amplitude (μm)/(Minimum detection unit in the closed loop system $\times 64$)		
(Note) When the parameter is set to 0, the compensation is not clamped.				
When this parameter is set to another value, the compensation is clamped if an error between the positions in the semi-closed loop system and closed loop system is larger than that value. The recommended value is twice the sum of the backlash compensation and pitch error compensation. If this value cannot be specified, zero must be set.				

No. 8X78	No. 1971	No. 2078	:	Specifies the conversion coefficient of dual position feedback (numerator).
No. 8X79	No. 1972	No. 2079	:	Specifies the conversion coefficient of dual position feedback (denominator).
Set value	:	Specify the fraction obtained by the following expression, reduced to the simplest form.		
No. 8X78	=	No. 1971	=	Number of position feedback pulses per motor revolution
No. 8X79	=	No. 1972	=	Number of velocity feedback pulses per motor revolution

No. 8X80	No. 1973	No. 2080	:	Specifies a primary delay time constant of dual position feedback.
Data unit	:	ms		
Set value	:	The standard range is 100 to 150 ms.		
(Note) When the value is set to 32767 ms, only the semi-closed loop system applies control.				
If the operation becomes unsteady during acceleration or deceleration, increase the value.				

No. 8X81	No. 1974	No. 2081	:	Specifies the zero-point amplitude of dual position feedback.
Data unit	:	Minimum detection unit in the closed loop system ($\mu\text{m}/\text{p}$)		
Set value	:	Zero-point amplitude (μm)/Minimum detection unit in the closed loop system		
(Note) Positioning is carried out according to the pulse width corresponding to the value specified in this parameter.				
First specify zero. If deflection occurs when the machine stops, increase the value.				

2.4 Overshoot Prevent Function

2.4.1 Overshoot compensation

This is a function to prevent overshoot in digital servo on such occasions as when 1-pulse feed is used.

(1) Applicable Servo ROM Series/Versions

- 9020 Series/J version and later
- 9030 Series/F version and later
- 9031 Series/A version and later

(2) Detailed Explanation

(a) Servo System Configuration

Fig. 2.4.1 (a) shows the servo system configuration. Fig 2.4.1 (b) shows the velocity loop configuration.

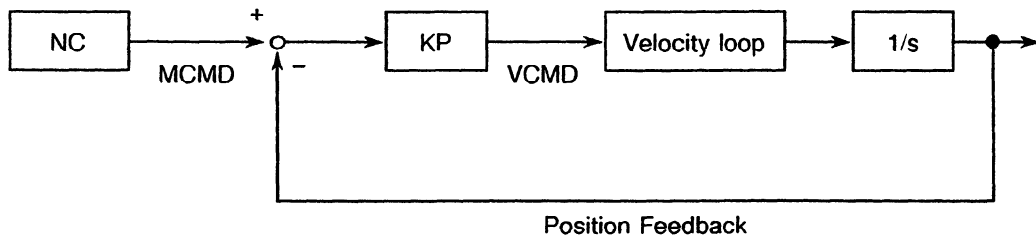

- MCMD Motion command
- VCMD Velocity command
- Kp Position gain

Fig. 2.4.1 (a) Digital Servo System Configuration

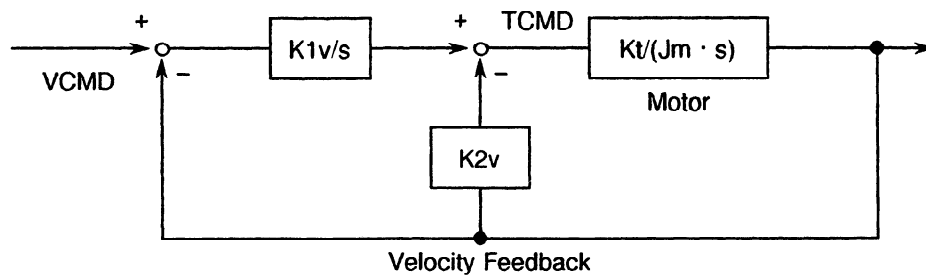

- K1v Velocity loop integrated gain
- K2v Velocity loop ratio gain
- TCMD Torque command
- /s Integrator

Fig. 2.4.1 (b) Velocity Loop Configuration

2. SERVO FUNCTIONS

(b) To begin, we will explain the situation when incomplete integration and overshoot compensation are not used.

First, the 1-pulse motion command is issued from NC. Initially, because the Position Feedback and Velocity Feedback are "0", the 1-pulse multiplied position gain K_p value is generated as the velocity command (VCMD).

Because the motor will not immediately move as a result of friction and suchlike in the machine, the integrator is accumulated according to the VCMD. When the value of this integrator is equal to that of the torque command, if the value of the integrator becomes great from the friction in the machine system, the motor will move and VCMD will become "0" as the value of MCMD and the Position Feedback becomes equal.

Furthermore, the Velocity Feedback becomes "1" only when it is moved, and afterwards becomes "0". Therefore the torque command is held fixed.

The above situation is shown in Fig. 2.4.1(c).

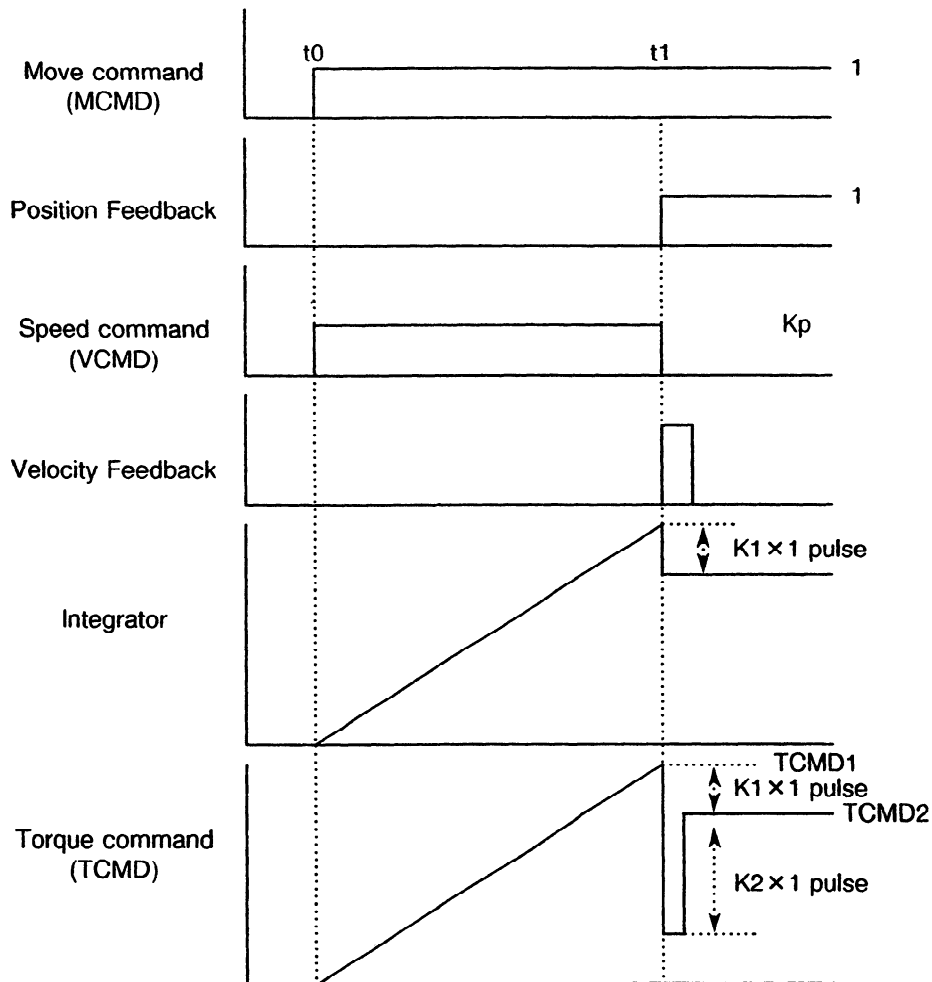

Fig. 2.4.1 (c)

2. SERVO FUNCTIONS

If Fig. 2.4.1 (c) on the previous page, the torque (TCMD1) when movement has started becomes even greater than the machine static friction level. Furthermore, when the motor has moved 1 pulse, it finally comes settled at the TCMD 2 level.

Because the moving frictional power of the machine is smaller than the maximum rest frictional power, if the final torque TCMD2 in Fig. 2.4.1 (c) is smaller than the moving friction level, the following will occur. Although the motor will stop at the place where it has moved 1 pulse, when the TCMD2 is greater than the moving friction level the motor cannot stop and overshoot will occur.

The overshoot compensation function is a function to prevent the occurrence of this phenomenon.

(c) Response to 1 pulse movement commands

(i) Torque commands for standard settings (when there is no overshoot)

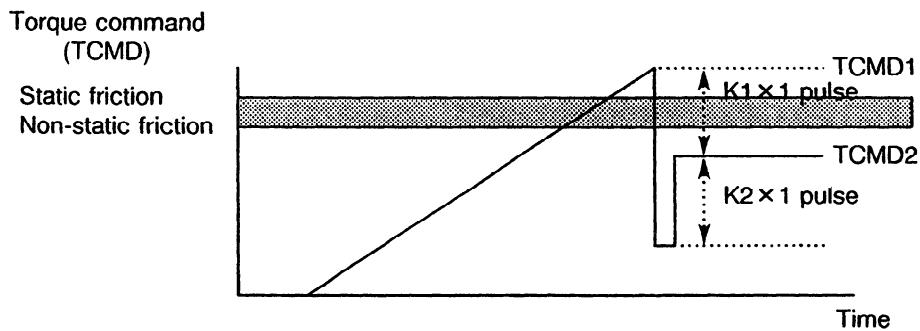

Fig. 2.4.1 (d) Torque Commands (When There is no Overshoot)

(ii) Torque commands for standard settings (during overshoot)

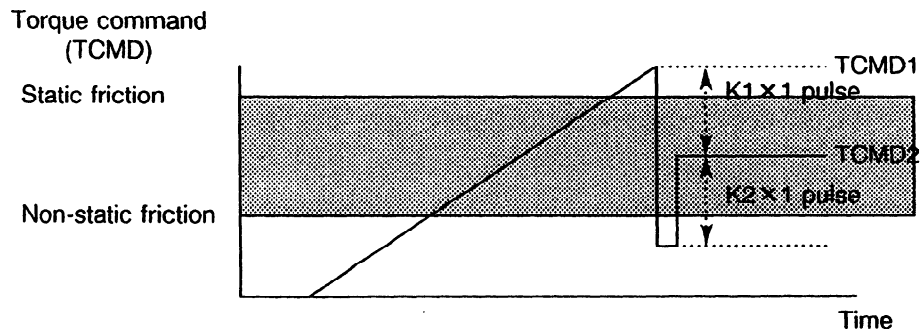

Fig. 2.4.1 (e) Torque Commands (During Overshoot)

2. SERVO FUNCTIONS

(i) Conditions to prevent further overshoot are as follows.

When

$$\text{TCMD1} > \text{static friction} > \text{non-static friction} > \text{TCMD2} \dots\dots \textcircled{1}$$

and there is a relationship there to

$$\text{TCMD1} > \text{static friction} > \text{TCMD2} > \text{non-static friction} \dots\dots \textcircled{2}$$

regarding static and non-static friction like that of (ii), use the existing overshoot compensation in order to make $\textcircled{2}$ into $\textcircled{1}$.

The torque command status at that time is shown in (iii).

(iii) Torque command when overshoot compensation is used

Series 10, 11, 12, 15	Series 0	
No.1808	No.8X03	Overshoot compensation valid at Bit 6 = 1
No.1857	No.8X45 (PK3V)	Insert a value of around 30000 to 250000
<p>(Example) when PK3V = 32000 time constant approx. 84 msec when PK3V = 30000 time constant approx. 22 msec when PK3V = 25000 time constant approx. 7 msec (when speed loop interrupt cycle is 2 msec)</p>		

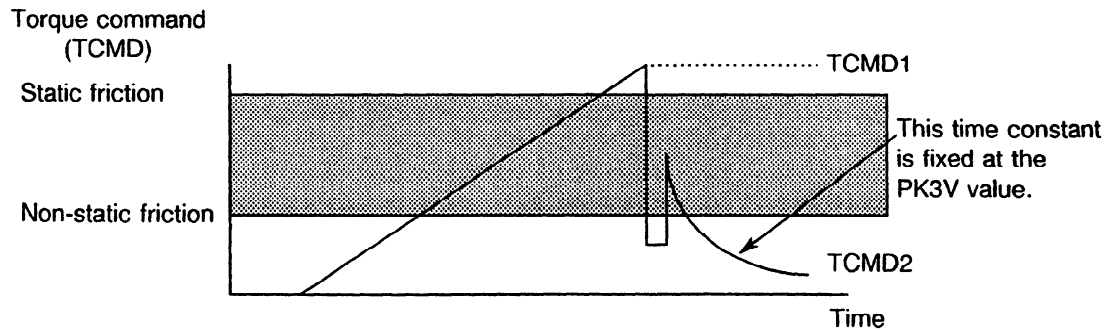

Fig. 2.4.1 (f) Torque Command (When Overshoot is Used)

If this overshoot compensation function is used, it is possible to prevent overshoot so that the relationship between machine static and non-static friction and TCMD2 satisfies $\textcircled{1}$, but in order that torque TCMD during machine stop is

$$\text{TCMD2} = 0$$

the servo rigidity during machine stop is insufficient and it is possible that there will be some unsteadiness at ± 1 pulse during machine stop.

There is an additional function to prevent this unsteadiness in the improved type overshoot prevention function and the status of the torque command at that time is shown in (iv).

2. SERVO FUNCTIONS

(iv) Torque command when the improved type overshoot compensation is used

Series 10, 11, 12, 15	Series 0	
No.1808	No.8X03	Bit 6 = 1 (Overshoot compensation valid)
No.1857	No.8X45	around 32300 (PK3V)
No.1970	No.8X77	around 50 (Overshoot protection counter incomplete integral count)

When overshooting with this parameter, try increasing the value of the overshoot protection counter by 10. Conversely, when there is no overshooting, but unsteadiness occurs easily during machine stop, decrease the overshoot protection counter value by 10.
When overshoot protection counter = 0 it is the same as existing overshoot compensation.

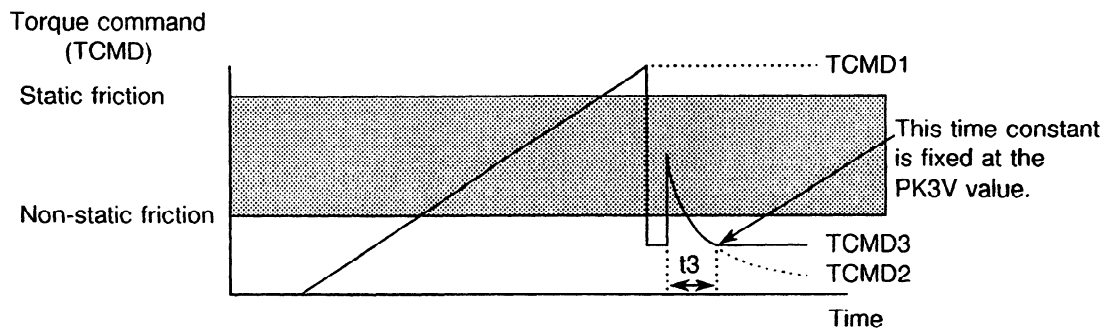

Fig. 2.4.1 (g) $t_3 = \text{Overshoot protection counter} \times \text{Velocity loop control cycle (1 msec, 2 msec)}$

If this function is used, the final torque command is TCMD3 and if the parameter PK3V and t_3 is fixed so that this value becomes less than the non-static friction level, overshoot is nullified and because torque command is maintained to some degree during machine stop, it is possible to decrease unsteadiness during machine stop.

2.4.2 PK3V value, the time constant of the integrator reduction, and the saturated value of the torque command

The incomplete integral is a parameter used to prevent overshoot. The relationship between the PK3V value and the time constant of the velocity loop integrator reduction and the relationship between the PK3V value and the saturated value of the torque command for a one-pulse position error will be explained below.

(1) PK3V value and the time constant for integrator reduction

The PK3V value is 0 in the normal complete integral state. The value actually used is 32768.

Sum (n) is given by the following expression:

$$\text{Sum (n)} = k_3 \times \text{Sum (n - 1)} + k_1 \times (\text{Vcmd (n)} - \text{Vfb (n)})$$

Where,

$k_3 = (\text{PK3V}/32768)$	$0 < K_3 < 1$
Velocity loop integrator value for (n - 1) times	Sum (n - 1)
Velocity loop integrator value for n times	Sum (n)
Velocity command (n times)	Vcmd (n)
Velocity feedback (n times)	Vfb (n)
Integral gain	k1

Vcmd (n) and Vfb (n) become 0 when movement is completed. The integrator operation is then determined by k3.

If the velocity loop control cycle is Ts (set to 2 msec or 1 msec), the integrator value after n x Ts (s) is obtained for the initial value of the integrator, so, is represented by the following expression:

$$\text{Sum (n)} = \text{So} \times (k_3)^n$$

The integrator value is directly used as a torque command. Therefore, the torque command is also held after it is stopped when k3 is 1 (i.e., when PK3V is 0). In cases other than above, the torque is decreased according to k3. Assume that the time constant for the decrease is Tau. The relationship between Tau and k3 is as follows:

$$\exp(-n \times \text{Ts}/\text{Tau}) = (k_3)^n$$

As a result, the expression below is obtained.

$$\text{Tau} = \text{Ts}/\ln(32768/\text{PK3V})$$

where, ln means natural logarithm.

2. SERVO FUNCTIONS

Table 2.4.2 shows the relationship between PK3V and Tau.

Table 2.4.2 Relationship between PK3V and Tau

PK3V	Tau [sec]	
	Ts = 1 msec	Ts = 2 msec
32760	4.09	8.19
32740	1.17	2.34
32700	0.481	0.962
32600	0.195	0.389
32000	0.042	0.084
30000	0.011	0.022
25000	3.7×10^{-3}	7.4×10^{-3}

By comparing the time between stopping and overshooting and the Tau value in the table, the PK3V value can be roughly calculated when an overshoot compensation function is used.

(2) Relationship between the PK3V value and the saturated value of the torque command

When an incomplete integral function is used, the torque command is saturated halfway for specified VCMD. The saturated value is balanced when it is lower than the mechanical friction. A positional deviation then remains.

Assume that the velocity command is a fixed value A when the machine is stopped. The integrator value after $n \times T_s$ (sec) is obtained from

$$\text{Sum}(n) = k_3 \times \text{Sum}(n) + k_1 \times A$$

$$\text{Sum}(n) = \frac{1}{1 - k_3} \times (1 - (k_3)^n) \times k_1 \times A$$

Consequently, the torque command is saturated by the following expression.

$$\frac{k_1 \times A}{1 - k_3}$$

Kp : Positional gain (1/s)

N : Pulses per motor rotation

fn : Velocity loop frequency band (Hz) (with 20 Hz as standard)

Jm : Motor inertia (Kg.cm.s²)

Kt : Torque constant (Kg.cm/A)

2. SERVO FUNCTIONS

In this case, assume that k_1 is $(J_m/K_t) \times (2 \times \pi \times f_n)^2$.

The saturated value of the torque command for a one-pulse command can be represented more pragmatic than before by the following expression:

$$T_{cmd} = \frac{1}{1 - (PK3V/32768)} \times K_1 \times \frac{K_p}{N} \times 2 \times \pi \times T_s \text{ [A]}$$

where, $\pi = 3.14$

A numerical example is as follows:

$$PK3V = 32700$$

$$f_n = 20 \text{ (Hz)}$$

$$N = 8000 \text{ (Pulse)}$$

$$K_p = 30 \text{ (1/sec)}$$

$$J_m = 0.1 \text{ (Kg} \cdot \text{cm} \cdot \text{sec}^2)$$

$$K_t = 10 \text{ (Kg} \cdot \text{cm/A)}$$

$$T_s = 2 \text{ (msec)}$$

Therefore,

$$K_1 = \frac{0.1}{10} \times (2 \times \pi \times 20)^2 = 157.9$$

The torque command is thus saturated for one pulse as given by the expression below.

$$T_{cmd} = \frac{1}{1 - (32700/32768)} \times 158 \times \frac{30}{8000} \times 2 \times \pi \times \frac{2}{1000} = 3.6 \text{ [A]}$$

The block diagram when an incomplete integral function is used and the status when a torque command is saturated are shown below.

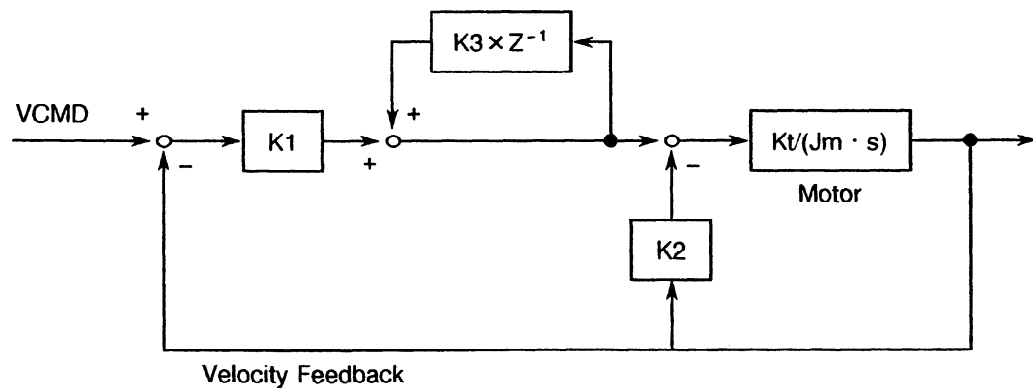

Fig. 2.4.2 (a) Velocity loop using incomplete integral

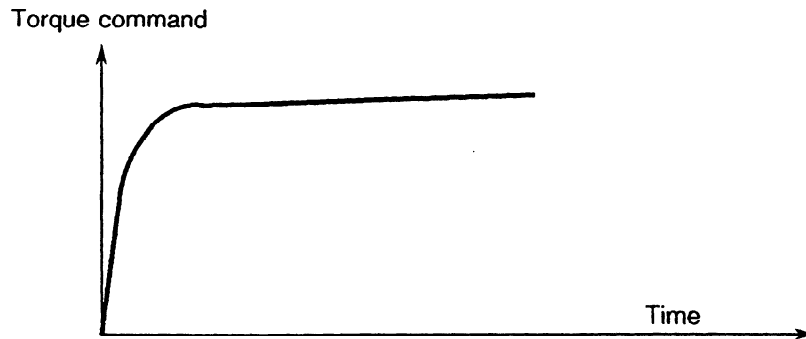

Fig. 2.4.2 (b) Torque command saturation

2.5 Shape-error Suppression Function

2.5.1 Feed-forward setting

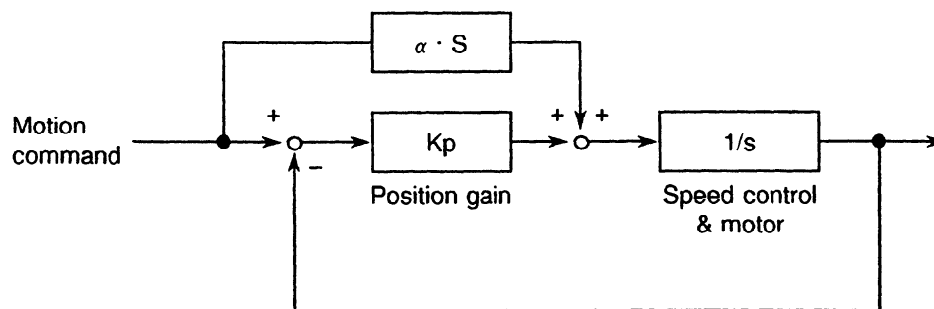

Fig. 2.5.1 (a) Feed forward control block diagram

By adding the feed forward item in the servo system shown in Fig. 2.5.1 (a), at constant speed the amount of position displacement ϵ will be

$$\epsilon = V / (A \times PG / (1 - \alpha))$$

- V : Feed rate (mm/s)
- A : Minimum detection unit (mm)
- PG : Position gain
- α : Feed forward coefficient (0 to 1)

becomes $(1 - \alpha)$ times.

From this, the error R1 (mm) in the direction of the radius at the time of circular cutting is

$$\Delta R1 = (1 - \alpha^2) \times V^2 / (2 \times PG^2 \times R)$$

- V : Feed rate (mm/s)
- R : Radius (mm)
- PG : Position gain
- α : Feed forward coefficient (0 to 1)

2. SERVO FUNCTIONS

Which means that by entering the feed forward coefficient, for example $\alpha = 0.7$, the shape error ΔR_1 caused by delay of the servo system will be reduced to approximately 1/2.

Also, there is shape error generated by the position command delay when using the acceleration/deceleration time constant after the 2-axis interpolation. This error, ΔR_2 (mm) is as shown below when performing circular cutting:

- ① In the case of exponential acceleration/deceleration after interpolation:

$$\Delta R_2 = T^2 \times V^2 / (2 \times R)$$

- ② In the case of linear acceleration/deceleration after interpolation:

$$\Delta R_2 = T^2 \times V^2 / (24 \times R)$$

V : Feed rate (mm/s)

R : Radius (mm)

T : Acceleration/deceleration time constant (s)

Thus, the shape error ΔR in the direction of radius on circular cutting is as shown below:

$$\Delta R = \Delta R_1 + \Delta R_2$$

The shape error in the direction of the radius during circular cutting is as shown in Fig. 2.5.1 (b) below.

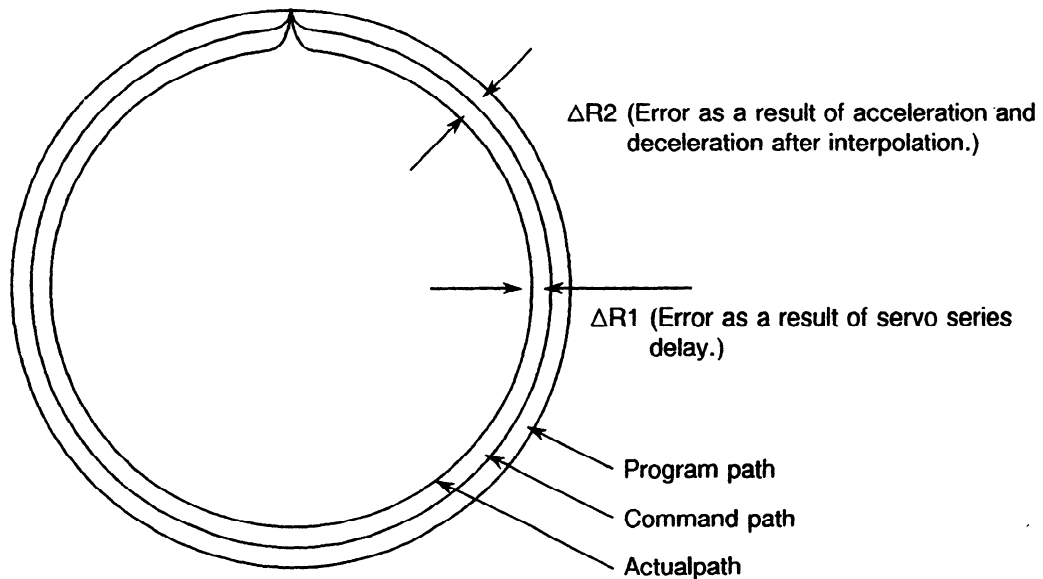

Fig. 2.5.1 (b) Path error during circular cutting

2. SERVO FUNCTIONS

(1) Applicable Servo ROM Series/Versions

Series 9010 series 001/E version and later	9032 series 001/A version and later
9020 series 001/D version and later	9034 series 001/A version and later
9030 series 001/A version and later	9040 series 001/A version and later
9031 series 001/A version and later	

(2) How to Set Parameters

As described in outline, as the feed forward α is made larger, the shape error due to delay in servo system becomes smaller and the shape error becomes theoretically 0 in the case of $\alpha = 1$. However, α cannot be allowed to be equal to 1 since the torque obtained from motor is limited in the servo system and the shock in deceleration by motor may be too much for the machine. However, when the acceleration/deceleration time constant in motion command is increased, the shock decreases and the feed forward term can be large. However, the error ΔR_2 increases. Then, perform the following for the adjustment procedures:

(a) Set parameters as shown below:

- No.1808 (Series 10, 11, 12, 15), No.8X03 (Series 0) Bit 3 = 1 PI control valid
- No.1883 (Series 10, 11, 12, 15), No.8X05 (Series 0) Bit 1 = 1 Feed forward valid
- No.1961 (Series 10, 11, 12, 15), No.8X68 (Series 0) Feed forward term FALPH

$$FALPH = \alpha \times 4096 \times \frac{\text{Number of speed feedback pulses (No.8X23 1876)}}{\text{Number of position feedback pulses per motor rotation}}$$

- (b) Turn on the power gain after turning off the power once and installing the check board.
- (c) Check to see if the VCMD has overshoot or the status of shock on acceleration/deceleration using a check board by moving the axis at maximum speed in cutting feed of program operation (Note 1).
- (d) Make the acceleration/deceleration time constant T larger or α smaller in the case of overshoot or excessive shock. Make the acceleration time constant T smaller or α larger if there is no overshoot or excessive shock.
- (e) Select the combination of T and α for the smallest shape error ΔR .

$$\Delta R = \Delta R_1 + \Delta R_2$$

$$= (1 - \alpha^2) \times V^2 / (2 \times K_p^2 \times R) + T^2 \times V^2 / (2 \times R) \quad [\text{Exponential acc/dec}]$$

or

$$= (1 - \alpha^2) \times V^2 / (2 \times K_p^2 \times R) + T^2 \times V^2 / (24 \times R) \quad [\text{Linear acc/dec}] \quad (\text{Note 2})$$

To reduce the shape error ΔR without changing the machine shock or overshoot at acceleration/deceleration too much, R1 and R2 should be about the same. The following table shows the values of α and T which satisfy this condition. Set this parameter by referring to the following table.

2. SERVO FUNCTIONS

Feed forward coefficient α	Exponential T (msec)	Linear T (msec)
0.5	32	96
0.7	24	80
0.9	16	48
0.95	8	32

(For position gain $K_p = 30$ [1/s])

If the acceleration/deceleration-before-interpolation function is used along with this function, the above time constant can be greatly reduced, also reducing the shape error.

(Note 1) Feed forward function is valid from NC ROM series as shown below.

Applicable NC	NC ROM series and versions
Series 0-MB	0415 series 08 version or thereafter 0417 series 01 version or thereafter
Series 11M	2060 series 07 version or thereafter 2061 series 05 version or thereafter 2062 series 06 version or thereafter 2063 series 05 version or thereafter
Series 11-MF	2161 series 04 version or thereafter 2062 series 04 version or thereafter
Series 15M	Corresponds to all

(Note 2) As shown in the above expression, the shape error at the command side becomes small and the feed forward effect becomes clearer in linear acceleration/deceleration than in exponential acceleration/deceleration. The linear acceleration/deceleration (on cutting) can be specified optionally.

(3) Improvements of the Feed Forward Function

- (a) The following improvements of the feed forward function have been made in 9030/version I and later.
(compatible with 9031/C version, 9032/A version, 9034/B version, 9040/1A version and later)
 - (i) Smoothing has been applied to the feed forward function, thereby proving smooth movement.

2. SERVO FUNCTIONS

- (ii) By increasing responsiveness of the velocity loop by the application of feed forward, the feed forward coefficient of the position loop can be increased above the previous level.

However, with this and subsequent versions, in cases where the cutting feed rate of 0.1μ systems is greater than 12m/min, be certain to set the velocity loop to a 1 msec control cycle whenever using feed forward control. (Fast feed is completely unrelated.)

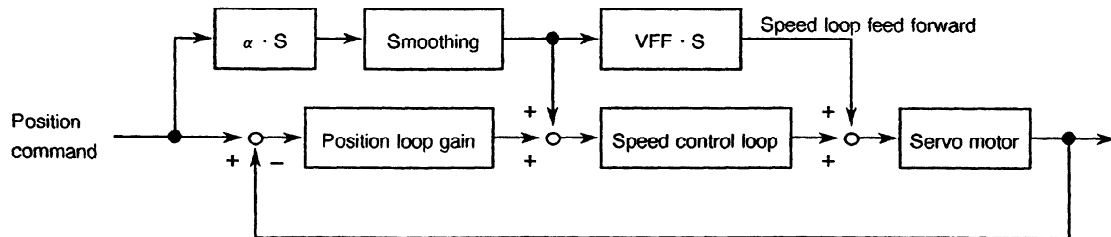

Fig. 2.5.1 (c) New feed forward control

(b) Parameter setting method

First, set the feed forward as previously done. At this time, smoothing is conducted automatically. Next, when applying feed forward to the velocity loop, set:

No.1962 (Series 15), No.8X69 (Series 0-C) Velocity loop feed forward coefficient (VFF)

The VFF standard when the velocity loop control cycle is 1 msec is:

$$VFF = (-PK2V) \times (\text{Load inertia} + \text{rotor inertia}) / (\text{rotor inertia}) \times (0.04) \times (2000/Np)$$

The VFF standard when the velocity loop control cycle is 2 msec is:

$$VFF = (-PK2V) \times (\text{Load inertia} + \text{rotor inertia}) / (\text{rotor inertia}) \times (0.01) \times (2000/Np)$$

Set values of this order. (Np is the pulse number of the pulse coder.)

Example: When using AC10S, a load inertia of $JL = 0.15\text{kgcmS}^2$, a velocity loop of 1 msec and 2000P, AC10S rotor inertia is $JM = 0.10\text{kgcmS}^2$ and $PK2V = -2328$, which give:

$$VFF = (2328) \times (0.15 + 0.10) / (0.10) \times (0.04) \times (2000/2000) = 233 \text{ approx.}$$

When using high resolution pulse in 1μ detection, use PK2V as standard data before dividing by 10.

2.5.2 Backlash compensation, acceleration function

If the influence of backlash and friction is large in the machine, a delay may be produced on reversal of motor, thus resulting in quadrant protrusion on circular cutting.

This is a backlash compensation acceleration function to improve quadrant protrusion, but there are a lot of parameters and setting method and adjustment is difficult. The aim of this section is to remove some of the problems by giving explanations on minimum adjustment methods.

(1) Applicable Servo ROM Series/Versions

- | | |
|--|--|
| 1) Series 9010/001A versions and later | 2) Series 9010/001G versions and later |
| Series 9020/001A versions and later | Series 9020/001J versions and later |
| Series 9030/001A versions and later | Series 9030/001F versions and later |
| Series 9040/001A versions and later | Series 9040/001A versions and later |

(2) Order of Parameter Adjustment

(Step 1) Backlash compensation amount setting

Parameter number

Series 10, 11, 12, 15 Series 0

(x) No.1851 No.535 to 538 (Backlash compensation amount)

① When semi-closed (motor encoder for position feedback)

The machine backlash amount is set → (Step 2)

② When full-closed (separate encoder for position feedback)

- In spite of being full-closed when there is backlash in the machine the machine backlash amount is set → (Step 2)

- When there is no backlash in the machine it is set to "1" → (y)

(y) No.1884 No.8X06 Set (full closed setting) Bit 0 = 1

(Step 2) Measure the circle by using a checkboard or DBB measuring instrument.

(a) Result of the measurement 1

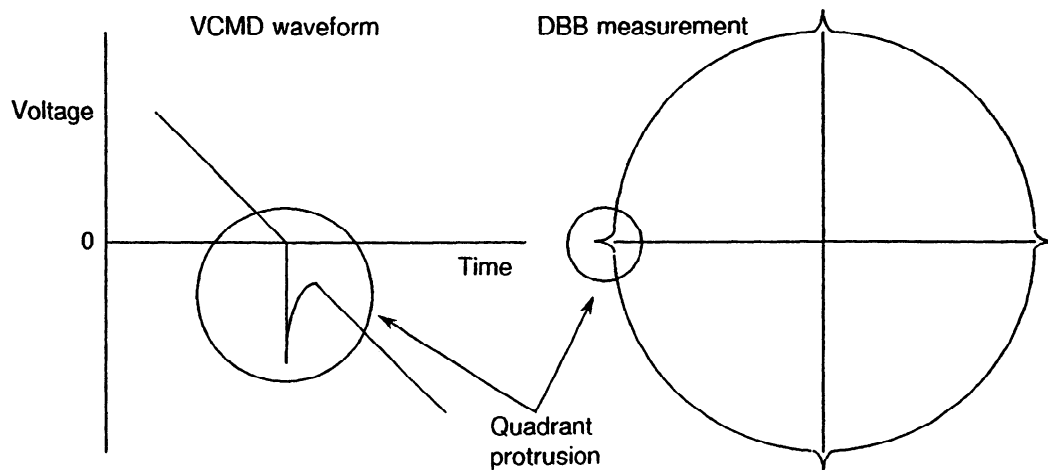

Fig. 2.5.2 (a) VCMD Waveform and DBB Measurement 1

2. SERVO FUNCTIONS

(b) Result of the measurement 2

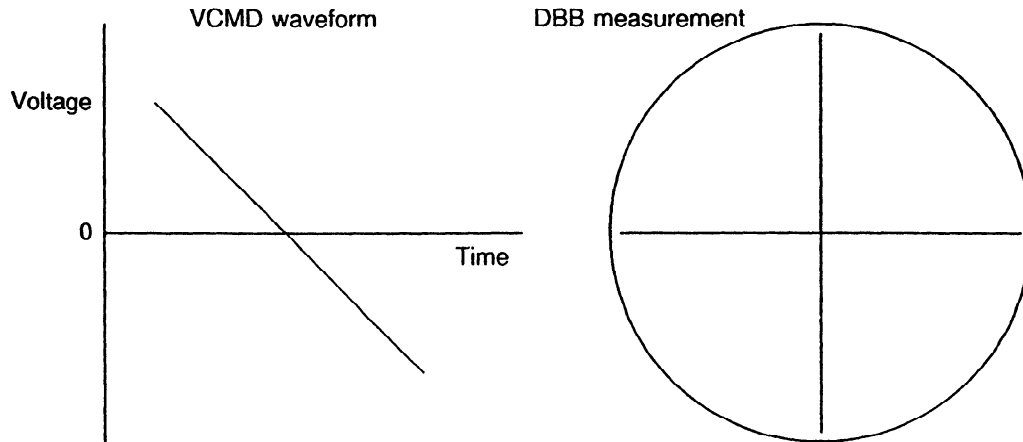

Fig. 2.5.2 (b) VCMD Waveform and DBB Measurement 2

- If the result of the measurement is like Fig. 2.5.2 (a) → (Step 3)
- If the result of the measurement is like Fig. 2.5.2 (b) adjustment is complete.

(Step 3) Settings to get the result of the measurement 1 of (Step 2) close to the result of the measurement 2.

① Parameter number

Series 10, 11, 12, 15 Series 0

(x) No.1808 No.8X03 bit 5 (backlash acceleration validated)

(y) No.1860 No.8X48 (backlash acceleration amount)

(z) No.1964 No.8X71 (backlash acceleration rotation)

Backlash acceleration function is validated by bit 5 = 1 of parameter (x).

Set backlash acceleration amount to around 500 by parameter (y).

Set acceleration time = $[2 \text{ msec} \times (\text{parameter} + 1)]$ to around 7 to 9 by parameter (z).

- If VCMD waveform is Fig. 2.5.2 (c) the rough adjustment is complete.
- If VCMD waveform is Fig. 2.5.2 (d) rough compensation is insufficient and therefore parameter (z) is made bigger.
- If VCMD waveform is Fig. 2.5.2 (e) → (Step 3)-2.

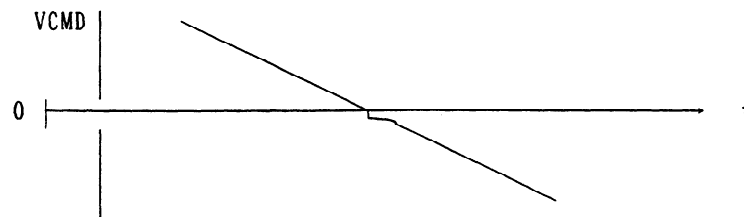

Fig. 2.5.2 (c) VCMD Waveform a

2. SERVO FUNCTIONS

Fig. (c)

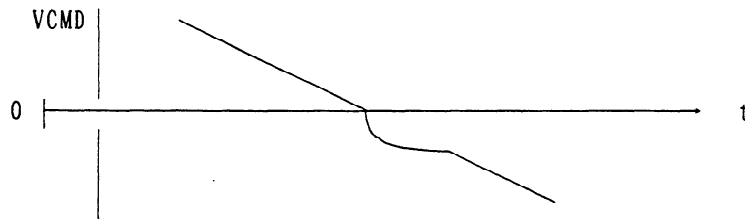

Fig. 2.5.2 (d) VCMD Waveform b

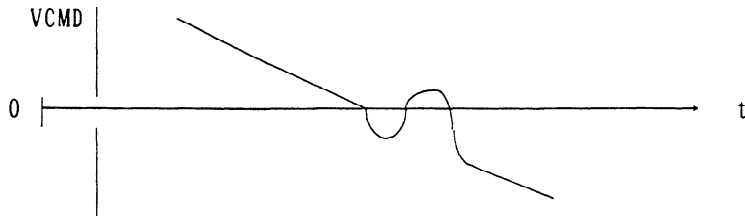

Fig. 2.5.2 (e) VCMD Waveform c

② The functions given below are valid from the applicable ROM (2) ROM.

Parameter number

Series 10, 11, 12, 15 Series 0

(x) No.1953 No.8X09 bit 7 (backlash acceleration stop function valid)

(y) No.1975 No.8X82 BLEND (backlash acceleration stop timing)

(x) Parameter bit 7 = 1 and the backlash acceleration stop function is validated.

(y) Parameter BLEND setting

Common to both the semi-close and full-close system. The backlash amount when the machine was moved in semi-close multiplied by 5 times the pulse count calculated from the feedback pulse.

Example 1: Semi-close, when using normal pulse coder 1 pulse = 1 μ backlash amount is 10 μ .

$$\text{BLEND} = (10 \mu) \div (1 \mu) \times 5 = 50$$

Example 2: Full-close, when backlash amount = 5 μ when the full close has been turned into semi-close by using scale 1 pulse = 1 μ high resolution pulse coder (equivalent to 1 pulse = 0.1 μ).

$$\text{BLEND} = (5 \mu) \div (0.1 \mu) \times 5 = 250$$

(i) If VCMD waveform is Fig. (c) the rough adjustment is complete.

(ii) If VCMD waveform is Fig. (d) the (y) parameter is made smaller.

2. SERVO FUNCTIONS

Adjustment points of Steps 2 and 3

In sstep 2, the backlash acceleration amount is set a little low and the acceleration count a little high and adjustment is carried out with the acceleration count moving up and down. A slightly excessive setting is better than an insufficient one. This is because the protrusions and cutting in reverse direction by excess of backlash acceleration can be protected with the Step 3 backlash acceleration stop function.

This procedure allows normal backlash compensation to be adjusted.

(Supplement 1) Disregard the backlash acceleration function during handle feed.

Series 10, 11, 12, 15	Series 0		
No.1953	No.8X09	bit 6	(Validates backlash acceleration function during cutting only.)

This function can invalidate the handle feed in order to validate the backlash acceleration function during cutting only when the above mentioned parameter bit 6 is changed to 1.

(Supplement 2) Backlash compensation timing

Backlash compensation can be added when the position command value is reversed, but in high speed cutting etc., reversal timing slips due to machine friction and servo delay etc. When this happens, it is possible to decide the backlash compensation timing by observing the error counter amount and a simple explanation of that function is given in the following figure.

Parameter number

Series 10, 11, 12, 15	Series 0		
No.1963	No.8X70		(Compensation timing)

Normally set at 0. The following is an example when the set value is changed from 0 to 2.

2. SERVO FUNCTIONS

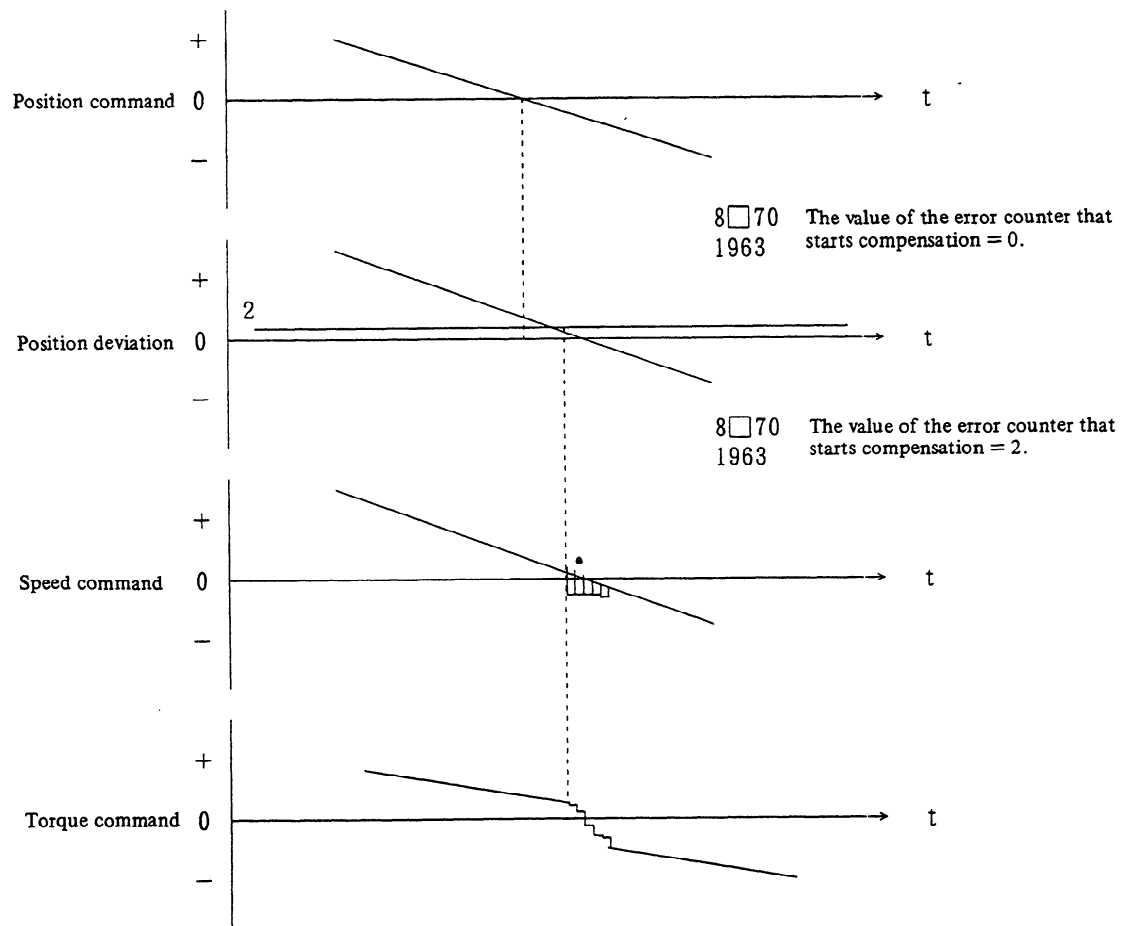

2.5.3 New backlash acceleration function

Backlash acceleration is used to reduce the quadrant protrusion that occurs when a different quadrant is to be handled in arc cutting. This acceleration has been improved as described below. As a result, it is easier to set parameters and it is possible to correct the optimum acceleration under the same parameter even if the cutting conditions such as friction or speed are changed.

When a change-of-direction command is sent from NC to the servo system, the servo software starts backlash acceleration after the motor has actually changed direction. In the former control method, the amount to be added to VCMD (amount of backlash acceleration) was controlled regularly. In the new method, however, the amount of backlash acceleration varies exponentially enabling it to accelerate at the optimum rate.

2. SERVO FUNCTIONS

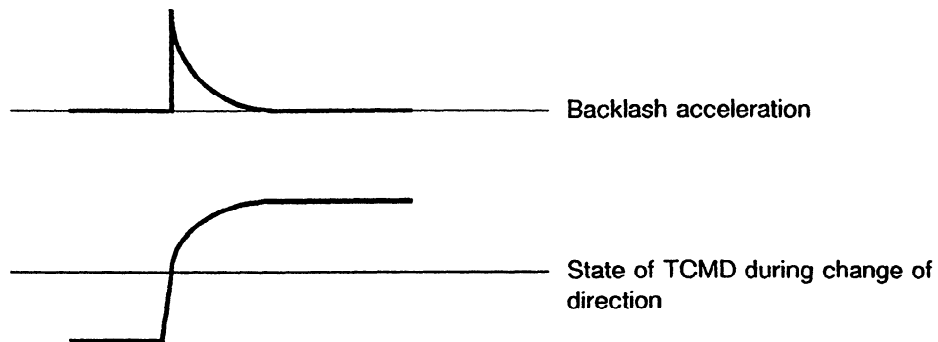

(1) Applicable ROM Series/Versions

9030 Series 001 Edition K and after
9040 Series 001 Edition A and after

(2) Parameter Set-Up

No.1851 (Series 15) No.535 to No.538 (Series 0-C) Amount of backlash
(It shall be set to 1 for a fully closed system. No.1884 (Series 15) No.8X06 (Series 0-C) Bit 0 = 1)

No.1808 (Series 15) No.8X03 (Series 0-C) Bit 5 = 1 (Backlash acceleration is validated.)

No.1953 (Series 15) No.8X09 (Series 0-C) Bit 2

When it is set as Bit 2 = 1, the new backlash acceleration function is validated, and when set at 0, the former backlash acceleration function is validated.

When the new backlash acceleration function is valid (No.1953 (Series 15) No.8X09 (Series 0-C) Bit 2 = 1):

No.1860 (Series 15) No.8X48 (Series 0-C) Time constant of backlash acceleration

For the standard pulse coder, set at about 5000.

For a high-resolution pulse coder, set at about 1000.

For a serial pulse coder, set at about 1000.

No.1964 (Series 15) No.8X71 (Series 0-C) The time in which this function becomes valid
Unit 2 ms

Generally, set at 50 to 100.

The meanings of terms such as backlash acceleration stop function and BLCUT are the same as before.

When the required torque differs depending on the feed direction as in the case of a vertical axis, measure the offset of torque using either of the following procedures.

2. SERVO FUNCTIONS

(3) Explanation of Function

The amount of DGN error during one-pulse feeding normally changes as follows:

Command pulse	+1	+1	+1	+1	+1	+1
Amount of DGN error	1 → 0	1 → 0	1 → 0	1 → 0	1 → 0	1 → 0

Alternatively, the amount of error may change as follows depending on the friction of the machine or the adjustment of the servo motor. This change is generally called the "phenomenon of erratic movement".

Command pulse	+1	+1	+1	+1
Position in Fig. 1	A → B	B → C	C → D	D → E
Amount of DGN error	0	1 → 0 → -1 → 0	0	1 → 0 → -1 → 0

The machine movement in this state can be represented by Fig. 2.6.1 (a).

Suppose that the machine in the figure is located at position A in a grid within one pulse of the detector at the beginning. When it moves on pulse in the positive direction, the required acceleration time can be shorter because it was located near an adjacent grid. Consequently, it passes the grid at low speed and stops at position B in the figure due to friction. During this movement, the amount of DGN error seems to be zero because the movement is too small. (Actually, it has changed from 1 to 0, but this change does not influence the amount of DGN error.)

When another command is input to move one more pulse in the positive direction, the motor is accelerated because the movement to pass over the grid is longer in this case. As a result, the inertia of the movement exceeds the friction and the machine cannot stop at the target grids position. Instead, it stops near the next grid or, by overshooting, at position C in the figure. It appears that the amount of DGN error change $1 \rightarrow 0 \rightarrow -1 \rightarrow 0$ during this movement. This movement repeats because C is near a grid, like position A.

This type of movement is frequently observed on a machine with very large static friction that requires larger initial torque but moves very smoothly once it has begun to move because of very small dynamic friction.

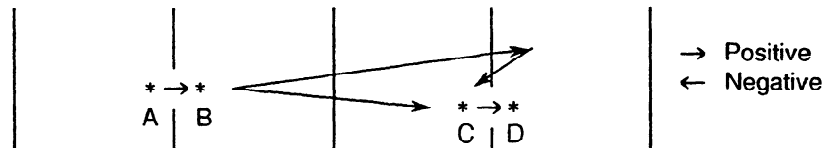

Fig. 2.6.1 (a)

2. SERVO FUNCTIONS

When the VCMD offset function is applied to eliminate the erratic movement, a velocity command of 0.5 pulse is added to the regular velocity command (VCMD). The result is that when a command is input to move one pulse in the positive direction from position A in the figure, the machine does not stop at position B, but keeps moving gradually in the positive direction up to the next grid. When it passes over the next grid even slightly, the velocity command from VCMD changes to $-1 + 0.5 = -0.5$ pulse and the machine returns in the negative direction.

By repeating this movement, the machine stops near grid B', C' or D', eliminating the erratic movement. See Fig. 2.6.1 (b) below.

It must be noted that this function always gives a machine a velocity command of 0.5 pulse, which may cause vibration depending on the static friction of the machine.

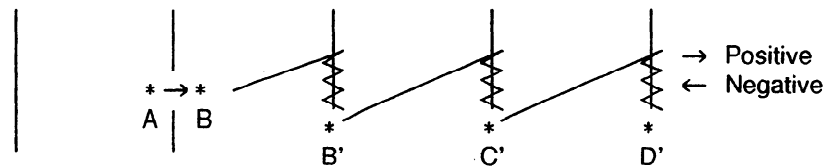

Fig. 2.6.1 (b)

2.7 Automatic Digital Servo Velocity Loop Gain Adjustment Function

The automatic digital servo velocity loop gain adjustment function measures the gain and frequency described below for each axis of a machine. To do this, the function vibrates the motor and machine with an amplitude of several hundred μm :

- The gain satisfies a velocity loop frequency band if specified.
- The frequency band allows the velocity loop to be achieved in a stable manner for each axis.

As mentioned above, the automatic adjustment function determines whether a specified velocity loop response characteristic can be achieved when the velocity loop is stable up to the cut-off frequency. The automatic adjustment function also determines a load inertial ratio (velocity gain) for achieving the response characteristic, if achievable.

Therefore, the automatic adjustment function can be used effectively for the following applications when a machine with a relatively high rigidity is used:

- To check the quantitative relationship between a load inertia ratio and the dynamic characteristic of the velocity loop including the machine system
- To determine the limit of the response characteristics that can be achieved in a stable manner

However, the result of automatic adjustment cannot be directly used as an optimal setting for the machine. Which setting to use ultimately is determined after repeating automatic adjustment operations several times under different target periods, taking the response characteristic and stability into consideration.

2. SERVO FUNCTIONS

- (1) Quantitative relationship between velocity loop target periods and velocity loop gains determined by automatic adjustment

To determine the limit of the machine's load inertia ratio (velocity gain) and to determine the relationship between a velocity loop gain and the response characteristic of the velocity loop including the machine system, data needs to be collected by making automatic adjustments with several target periods.

Suppose that a position gain of about 30 (1/sec) is needed for an axis. In this case, the position loop can be almost thoroughly controlled without incurring problems such as swell and hunting if a band (20 Hz to 28 Hz), which is 4 to 6 times wider than that for the position gain, can be obtained as a velocity loop band frequency. The band 28 Hz corresponds to a time constant of 35 msec, so automatic adjustment needs to be started with a twofold time constant, which is about 70 msec. Then the target period is reduced by 5 msec step by step to collect the results of automatic adjustment for each frequency.

The results of automatic adjustment can be viewed easily by plotting the results as shown in Fig. 2.7.1 with the inverses of the target periods (band frequencies) along the horizontal axis and velocity loop gains along the vertical axis.

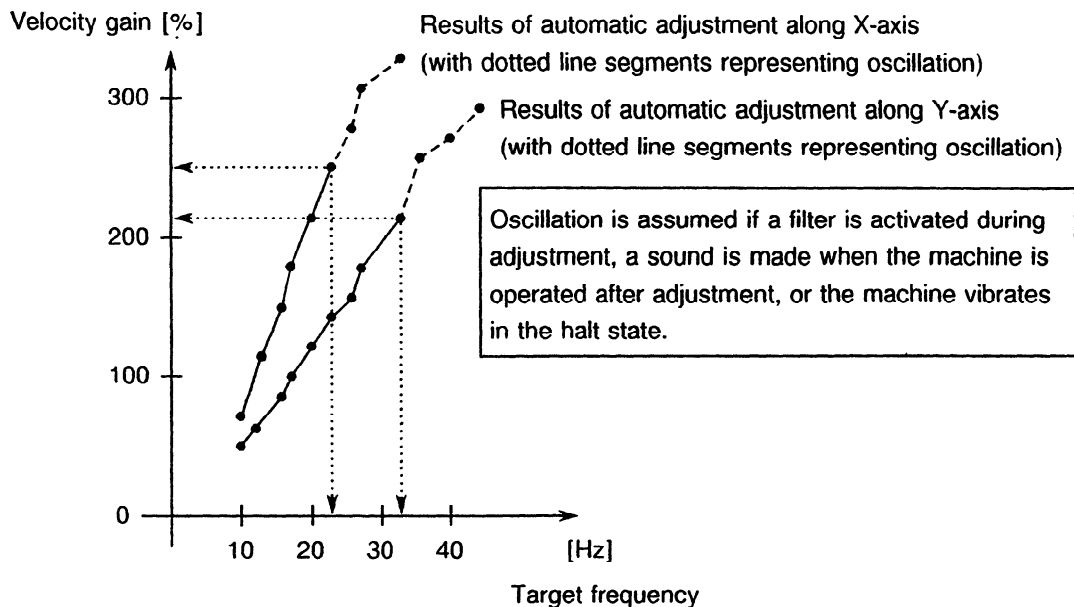

Fig. 2.7.1 Example of Results of Automatic Adjustment

Fig. 2.7.1 shows the results of automatic adjustment along the X-axis and Y-axis of a machine. Theoretically, the target frequencies (inverses of target periods) are proportional to the velocity gains. As a higher target frequency (shorter target period) is used, velocity loop oscillation can occur more easily during automatic adjustment. In such a case, the results of adjustment become less precise. In addition, a shorter target period activates the torque command filter during automatic adjustment. Ultimately, the adjustment becomes impossible, and a longer

2. SERVO FUNCTIONS

target period is used automatically. This phenomenon occurs in the dotted line segments in Fig. 2.7.1. So in this example, the maximum allowable velocity loop band frequency is about 22 Hz for the X-axis, and about 33 Hz for the Y-axis.

Thus, automatic adjustment can be regarded as having the function of a sort of measuring equipment that quantitatively relates a physical quantity (velocity loop response characteristic) with the velocity loop gain parameter of the digital servo. Furthermore, automatic adjustment can be regarded as a means of setting a gain that matches the environment where the machine is used, and also as a means of checking the mechanical rigidities of the axes, based on the results of adjustment as shown in Fig. 2.7.1.

(2) Determining the velocity loop gain using the results of automatic adjustment

As described in (1) above, the automatic adjustment function does not directly implement an optimal state for each axis, but is a means of determining a velocity loop gain to achieve a given target period. Accordingly, a velocity loop gain needs to be determined from Fig. 2.7.1, depending on the situation.

Case 1: When the maximum stable servo rigidity and response characteristics are to be achieved for each axis

In this case, make the following settings, providing some oscillation margin for each axis:

X-axis	Band frequency: 20 Hz	Velocity gain: 220%
Y-axis	Band frequency: 30 Hz	Velocity gain: 200%

Case 2: When the response characteristics of the velocity loop as well as the position loop gain are to be made exactly the same for each axis so that each axis can have the same response characteristics in acceleration/deceleration

In this case, make the following settings, matching the setting of the Y-axis to those of the X-axis (which has a low maximum allowable band frequency):

X-axis	Band frequency: 20 Hz	Velocity gain: 220%
Y-axis	Band frequency: 20 Hz	Velocity gain: 200%

Case 3: When the machine's rigidity is low, and high surface precision and reduced effects of friction in direction inversion are required, but the machine is not subject to severe acceleration/deceleration

This is often the case with machines with a low mechanical rigidity such as large machines and machines involving a belt joint or slanted axis. Particularly when a machine involves some level of friction, the velocity loop can become slightly unstable in the high frequency area. However, unless acceleration/deceleration is performed with a short time constant, such instability poses no actual problem.

2. SERVO FUNCTIONS

When a high surface precision in low-speed cutting or a high response characteristic when reversing direction is required in using these machines, the following parameter adjustments are needed based on the results of automatic adjustment:

- A higher velocity loop gain is set to increase the servo rigidity in the halt state or low-speed feed operation.
- The velocity loop is placed under PI control to increase the response characteristic without reducing the stability of the velocity loop.
- An observer is used to prevent machine system resonance.
- The acceleration feedback function is used to enable the machine to be more immune to disturbance.
- The backlash acceleration function is used for improvement in direction reversal.

(3) Automatic adjustment parameter setting with Series 9039

Install a servo ROM for automatic adjustment.

Series 15 : Replace the servo ROM with a Series 9039 ROM for automatic adjustment.
(The drawing number used when ordering an automatic adjustment ROM for the Series 15 is A02B-0094-K501#9039.)

Series 0-C : Install a ROM cassette for automatic adjustment. (The drawing number used when ordering an automatic adjustment cassette for Series 0-C is A02B-0098-C198#9039.)

Initialize the standard parameters for the servo motor.

No.18 (Series 15), No. 8X20 (Series 0-C) (motor type): Specify the motor type of the machine to be adjusted (NC all-axis motor type number 39 or up).

No. 1804 (Series 15), No. 8X00 (Series 0-C): Set bit 1 = 0 (initialization).

Turn off the power to the NC, then turn it on again.

Make the following settings on the ordinary screen after emergency stop:

No. 1829 (Series 15), Nos. 593-596 (Series 0-C): (Positioning deviation limit for each axis when stopped) = 32767

No. 1808 (Series 15), No. 8X03 (Series 0-C): Bit 3 = 0 (IP control)

No. 1971 (Series 15), No. 8X78 (Series 0-C): (Vibration amplitude) = number of pulse coder pulses

Example: When a 3000-pulse pulse coder is used: Vibration amplitude = 3000

No. 1973 (Series 15), No. 8X80 (Series 0-C): (Velocity loop gain compensation coefficient) = 40

No. 1974 (Series 15), No. 8X81 (Series 0-C): (Target period compensation coefficient) = 500

2. SERVO FUNCTIONS

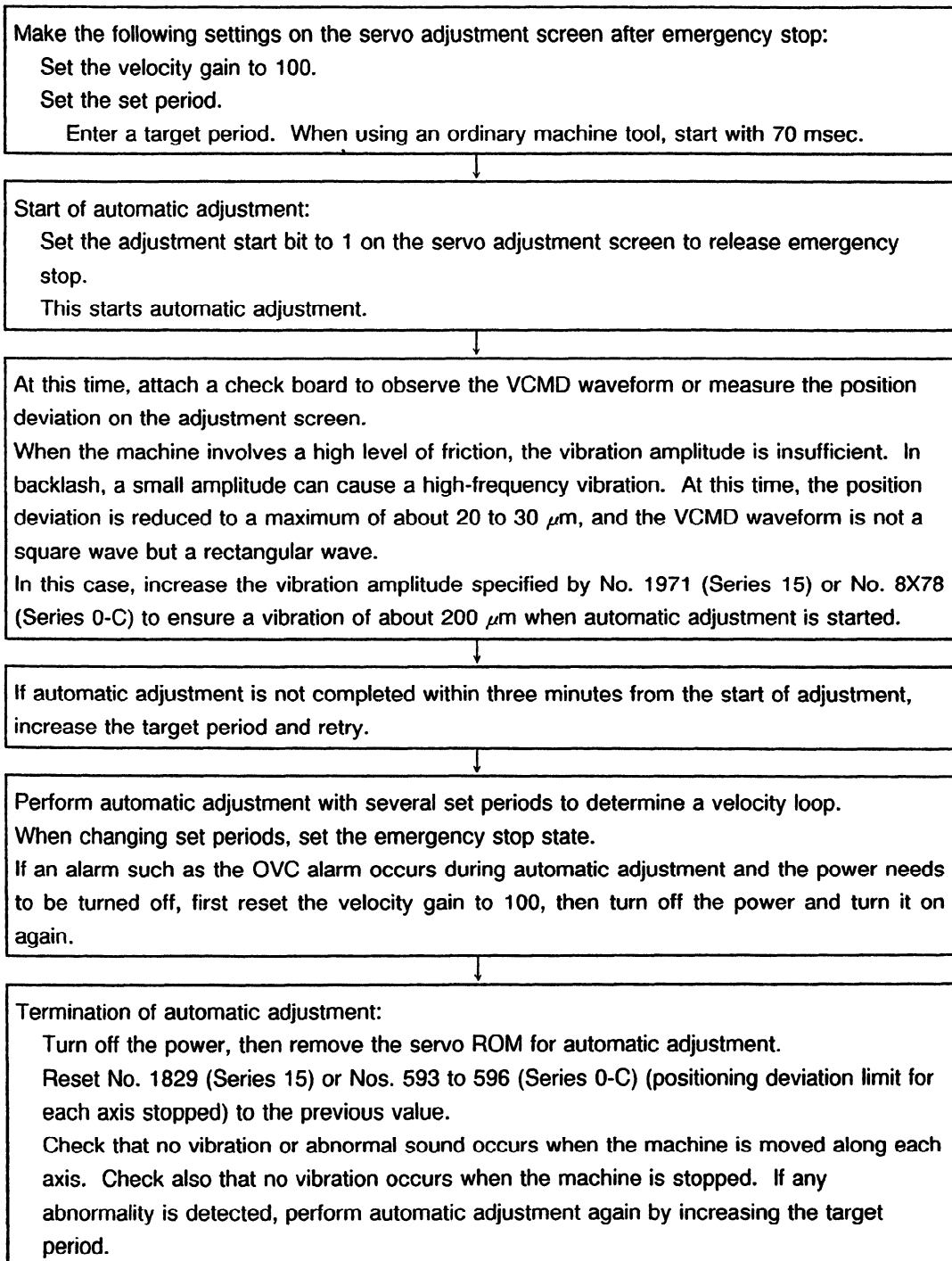

2. SERVO FUNCTIONS

(4) Automatic adjustment with actual machines

In automatic adjustment with an actual machine, when the machine's rigidity is sufficiently high and no significant backlash or friction is involved, the velocity loop gain for a target period can be found using the standard automatic adjustment parameter settings. With an actual machine, however, the result of automatic adjustment may be inaccurate, or adjustment may not terminate in a short time. The possible causes are described below.

(a) When there is large backlash or friction between the motor and machine

In this case, if the vibration amplitude is small, the motor vibrates just within such a backlash, making the vibration cycle faster. If the machine's friction is large, the machine cannot be started, but the motor alone vibrates at a fast cycle. In this case, the vibration amplitude set for automatic adjustment needs to be made larger than the standard value to vibrate the machine with sufficient amplitude.

(b) When the machine system has high-frequency resonance characteristics

When the machine system has a high, strong resonance of 200 Hz or more, the resonance component becomes apparent as the velocity loop gain is increased during automatic adjustment, thus causing velocity loop resonance. In this case, the automatic adjustment software detects the resonance, and the torque command filter is automatically activated. If the resonance continues, the target period is extended automatically. In this case, however, a long time is required until completion of automatic adjustment, or an inaccurate adjustment value is produced because the adjustment is completed with a marginal level of resonance.

In this case, the gain set for automatic adjustment needs to be reduced to 70% to 80%.

(c) When the rigidity of the machine is low as in the case of a machine involving a belt joint, and the resonance frequency of the machine system is low

With a low-rigidity machine such as a machine involving a belt joint, it is difficult to achieve a high frequency band for the velocity loop in a stable manner. If automatic adjustment is attempted with such a target period, velocity loop resonance occurs during automatic adjustment, resulting in an unsuccessful adjustment. For example, the target period is automatically reduced, or the result of adjustment is inaccurate. Thus, with a machine that cannot have a high frequency band by nature, the automatic adjustment function cannot find the corresponding gain for achieving a high frequency band, and the adjustment produces a low value.

Therefore, with a low-rigidity machine, when a high-speed (or high-frequency) command is entered which causes the dynamic characteristic of the machine to dominate, vibration is caused with a gain that makes the velocity loop unstable. In this case, a relatively lower gain is required, and in particular, the target period needs to be extended to ensure stability. When high surface precision or smooth operation in direction reversal is

2. SERVO FUNCTIONS

particularly required, an even fine adjustment needs to be made, taking the results of automatic adjustment into consideration. This can be illustrated in terms of the frequency characteristics, as shown in Fig. 2.7.2.

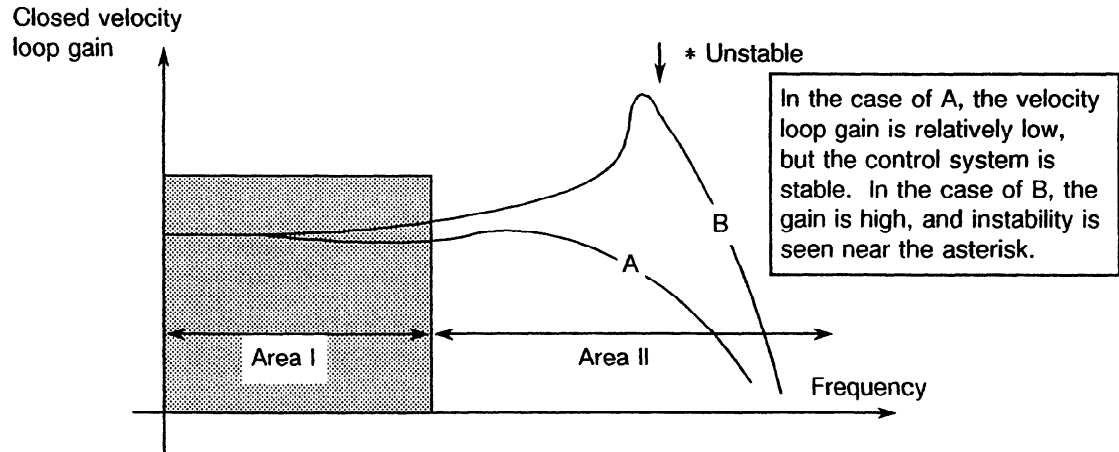

Fig. 2.7.2(a) Velocity Loop Transfer Characteristic (Gain Characteristic)

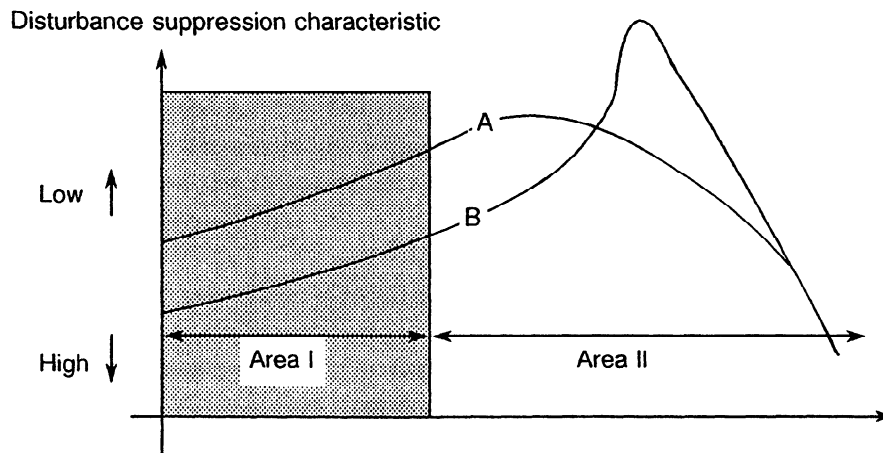

Fig. 2.7.2(b) Velocity Loop Disturbance Suppression Characteristic

Fig. 2.7.2(a) shows the gain characteristic of a low-rigidity machine. Curve A represents the case where the gain of the velocity loop is not so high, and the velocity loop is stable. Curve B represents the case where the gain is high and the velocity loop is unstable. In this case, instability appears at about 30 Hz to 100 Hz.

Fig. 2.7.2(b) shows the position deviation when the disturbance is applied to the servo system. The curve on the lower side represents a higher level of disturbance suppression. In area I where the velocity loop is stable, the higher the gain, the higher the level of disturbance suppression. When the velocity loop is unstable (area II), the disturbance suppression characteristics deteriorate.

2. SERVO FUNCTIONS

When a command for the axis requires quick response characteristics, the setting of B produces an adverse effect because the command involves many high-frequency components (area II components). On the other hand, when the command requires moderate changes, the portion of area I becomes dominant, and the setting of B is superior in surface precision and so forth.

The setting of B is unstable, so that automatic adjustment does not determine the gain of B. However, when a command is of the latter type described above, the setting of B is better than the setting of A.

2.8 Current Loop Function

2.8.1 Current loop gain

This appendix covers the construction and parameter of the current loop for digital servo motor. Under no circumstances change the parameter of the current loop. It has been determined in consideration of the stability of the current loop, and the output torque and the current in the high velocity zone.

(1) Construction of Current Loop

Fig. 2.8.1 shows the construction of the current loop.

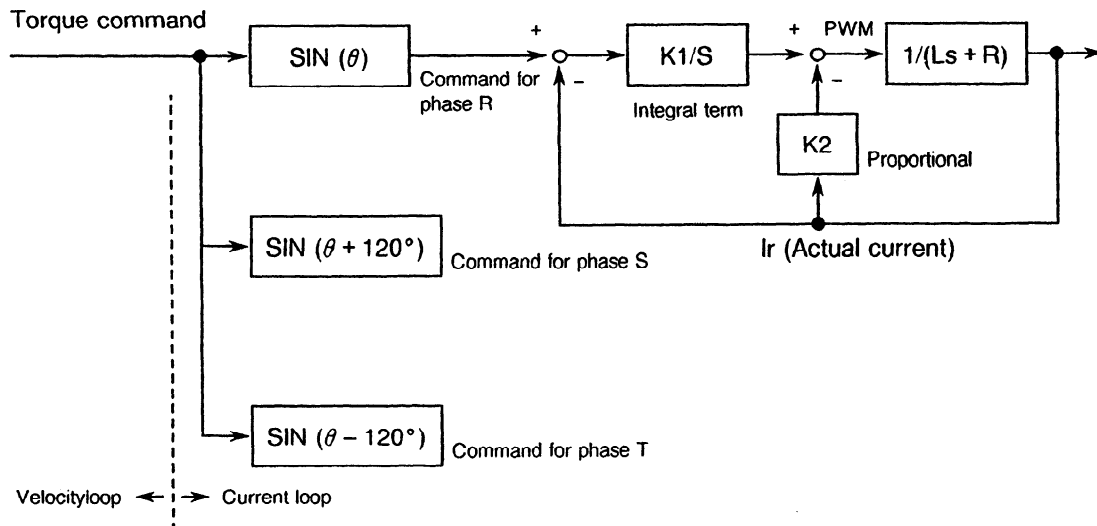

Fig. 2.8.1 Construction of current loop

In Fig. 2.8.1, the current command is calculated in the velocity loop. In the current loop, a command is input to each phase, R, S and T, each shifted by 120 degrees, corresponding to the phase of the rotor. Each phase is handled through IP control as shown in Fig. 2.8.1, and the PWM command (voltage command) is calculated.

The voltage specified by the voltage command activates the motor.

(2) Parameter for Current Loop

IP control is used in the current loop as shown in Fig. 2.8.1. The integral gain of the loop is equivalent to PK1 and the proportional gain is equivalent to PK2. PK1 and PK2 are determined by the inductance and resistance of the motor, the detection resistance of the applied amplifier, or the conversion table in the software. The standard model is designed to enable the current to start up in about 750 μ s, which is equivalent to three times longer than the cut-in interval in the current loop.

Increasing PK1 improves the start-up characteristics of the current, but the current loop is liable to become unstable.

If the standard value of current loop parameter PK1, PK2, or PK3 has to be changed for some reason, please contact us.

2.8.2 Torque limit (current limit)

In the FANUC digital servo motor, the current for current commands is limited by the software to protect the amplifier, motor, and A/D converter.

(1) Detailed Explanation

① Parameter No. of torque limit (current limit)
No.8X60 (Series 0), No.1872 (Series 10, 11, 12, 15)

② Definition of parameter of torque limit (current limit)

$$\text{Value of torque limit (current limit) (Ap)} = I_L (Ap) \times \frac{\text{Parameter value}}{7282}$$

The value I_L , is determined as listed below according to the type of motor.

Table 2.8.2 Servo Motors and Values of I_L

Applicable servo motor	Value of I_L
5-0	2 Ap
3-0, 4-0, 3-0S, 4-0S	4 Ap
1-0, 2-0, 1-0S, 2-0S, 1-0S/3000	12 Ap
0, 5, 10, 0S, 5S, 10S, 20S/1500, 0L, 0T/3000, 5T, 10T, 0-0S, 0-0SP	40 Ap
20, 30, 20S, 30S, 5L, 6L, 5S/3000, 10S/3000, 5T/3000, 10T/3000	80 Ap
30/2000, 40, 7L, 10L	100 Ap
*7L, 10L, 20S/3000, 30S/3000, 40S/2000	130 Ap
50S	200 Ap
60S, 70S	300 Ap

* For C series servo amplifier (A06B-6066-H008)

2.8.3 Current loop function for high motor output at high-speed rotation

The AC servo motor, which is a permanent-magnet synchronous motor, generates counter-electromotive force when it rotates. Since it is an AC motor, a command instruction for each of the R, S, and T phases takes the form of sinusoidal wave at constant rotation. A higher-speed rotation, however, the command frequency becomes higher, so that problems such as a current loop phase delay and decreased gain arise.

The digital servo has the following functions to produce a higher torque even at high-speed rotation and to minimize currents at high speed rotation for reduced heat dissipation by the motor and so forth:

- Phase-lead compensation
- Counterelectromotive force compensation
- Speed-dependent current loop gain

This section explains these functions.

(1) Applicable servo ROM series/versions

Phase-lead compensation function : Any version in any series

Counterelectromotive force compensation function : 9000/1K, 9001/1G, 9002/1C versions and later.
For other series, any version.

Speed-dependent current loop gain variable function : 9020/1B, 9022/1B, 9030/1A, 9031/1A,
9032/1A, 9034/1A, 9040/1A versions and later

2. SERVO FUNCTIONS

(2) Phase-lead compensation

Fig. 2.8.3 (a) shows the block diagram of a current loop phase. The current loop parameter is set so that the frequency of this open-loop transfer function is about 200Hz.

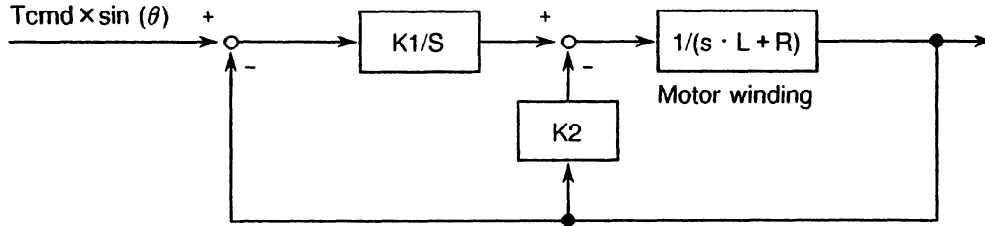

Fig. 2.8.3 (a) Block Diagram of a Current Loop Phase

When a current (output) is viewed from a command (input), the transfer function is represented by a second-order system, and its cut-off frequency is about 200Hz. The 200-Hz cut-off frequency means that a phase delay begins to appear at about 100Hz.

Let θ (phase R position) be the magnetic flux direction. Then assume that the current (i_o) lags the magnetic flux phase by ϕ when current commands for the R, S, and T phases are entered at the phases of $\sin(\theta)$, $\sin(\theta + 120^\circ)$, and $\sin(\theta - 120^\circ)$, respectively. In this case, the useful component (used for motor output) is represented as $i_o \times \cos(\phi)$, and the component of $i_o \times \sin(\phi)$ is a dead current. Thus as a larger current loop phase delay occurs, the useful current component becomes smaller. So in a situation where the torque command is saturated, the torque producible by the motor becomes small. Even if the torque command is not saturated, larger dead currents result. When an eight-pole motor rotates at 2000 rpm, the command frequency F_n for each current loop phase is calculated as

$$F_n = \frac{2000}{60} \times \frac{8}{2} = 133\text{Hz}$$

Phase-lead compensation advances a command beforehand to correct a current loop delay described above. By doing so, a power factor near 1 is achieved with a lead by a command canceling a current loop delay, and current can be furnished to the motor even at high-speed rotation.

With the digital servo, such an algorithm is employed that the phase lead amount is proportional to the velocity. So, with respect to the rotational speed of the motor V , the lead angle θ_p by phase-lead compensation can be represented as follows:

$$\theta_p = K_p \times V$$

2. SERVO FUNCTIONS

This K_p corresponds to the parameter PVPA. At this time, the command phases of the R, S, and T phases are $\sin(\theta + \theta_p)$, $\sin(\theta + \theta_p + 120^\circ)$, and $\sin(\theta + \theta_p - 120^\circ)$, respectively (where θ represents the position of the R phase). With this phase lead, a current loop phase delay in a high-speed area can be corrected to some extent.

Numeric example: When a 2500-pulse pulse coder and the phase-lead compensation parameter PVPA = 2330 are used, $\theta_p = 66^\circ$ at 2000 rpm. This phase-lead angle θ_p is proportional to the number of pulses of the pulse coder, the PVPA parameter, and the number of revolutions, and is clamped at about 80° .

(3) Backelectromotive force compensation

The AC servo motor is a permanent-magnet synchronous motor, and generates counter-electromotive force when it rotates. The value of backelectromotive force varies from motor to motor. For example, the AC10S produces a counter-electromotive force of about 185V (0-peak) across lines when it rotates at 2000 rpm; according to the AC SERVO MOTOR Series Descriptions (B-65002), the backelectromotive force constant $K_e = 38\text{V/krpm}$ (effective voltage-phase voltage). (The DC link voltage of the amplifier is 282V for 200-V power input.)

The backelectromotive force has a disturbance factor for the current loop; the torque command involves both the effect of backelectromotive force and the conventional effect of flowing current through motor windings. As backelectromotive force increases at high-speed rotation, a separation occurs between the torque command and actual current. Thus even if a current saturation level is not reached, the torque command becomes saturated, limiting the torque in a high-speed rotation area of the motor. To prevent this, the digital servo software calculates the backelectromotive force of the motor at all times, and a calculated voltage is added to a PWM command output from the current loop. Thus backelectromotive force is corrected without involving the torque command.

Backelectromotive force takes the form of sinusoidal wave and has an amplitude proportional to the speed of the motor, with its phase being $\sin(\theta)$ where θ is the rotor position of each phase. So the voltage correction value can be represented as

$$K_v \times V \times \sin(\theta)$$

This K_v corresponds to the backelectromotive force correction coefficient EMFCMP.

As the standard parameter, about 70 percent of a calculated value is adopted for a motor with the specification of 2000 rpm, and the best value experimentally obtainable is adopted for a motor with the specification of 3000 rpm.

2. SERVO FUNCTIONS

(4) Speed-dependent current loop gain change function

With the phase-lead compensation function and backelectromotive force compensation function described above, a current loop phase delay in high-speed area and torque command increase can be corrected to some extent. With a high-speed (3000 rpm) motor, however, only a smaller actual current compared with the torque command can flow due to deteriorated current loop gain characteristics, resulting in an insufficient torque. On the other hand, the phase-lead compensation function attempts a linear approximation for a current loop phase delay, which, in nature, does not change linearly with respect to speed. This means that it is difficult for the function to cover an area from about 1000 rpm to 3000 rpm.

Basically, a current loop phase delay can be minimized, and a decrease in gain can be suppressed effectively by increasing the current loop gains PK1 and PK2. However, increasing PK1 and PK2 can cause trouble such as current oscillation and HC alarm especially when power supply voltage increases in low-speed operation or deceleration.

The speed-dependent current loop gain change function increases the current loop gain only in high-speed acceleration or stable operation, and returns the gain to the original value in low-speed operation or deceleration. In high-speed acceleration or stable operation, the current loop gain is lowered equivalently by a factor such as backelectromotive force, so there is no problem in increasing the gain.

The original current loop gains are PK1o and PK2o, while the digital servo software calculates the gains, PK1 and PK2, used for current control as follows:

$$PK1 = PK1o \times (1 + P(V))$$

$$PK2 = PK2o \times (1 + P(V))$$

Here, P(V) in acceleration or operation at constant speed is given by

$$P(V) = Np \times V \times (AALPH) / (3 \times 10^{10})$$

where V : Rotational speed of motor (rpm)
 Np : Number of pulses of pulse coder
 AALPH : Speed-dependent current loop gain parameter (8 × 74, 1967)

Example: P(V) = 0.4 when Np = 2000 [pulse], V = 3000 [rpm], and AALPH = 2000. This means that when the number of revolutions is 3000 rpm, the current loop gain is increased by 40% compared with when the motor is stopped.

At deceleration time, $P(V) = 0$. (See Fig. 2.8.3 (b))

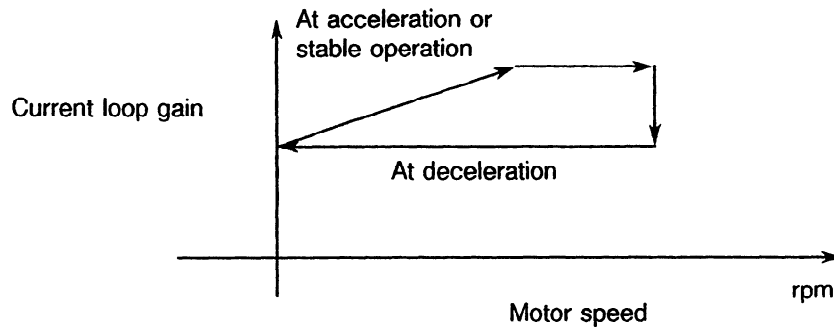

Fig. 2.8.3 (b)

2.8.4 Parameters for dead zone correction of current

In the current servo amplifier design, transistors are used as switching elements to activate a motor. In transistors, there is a switching delay at each ON and OFF operation. Therefore, a dead zone of several tens of microseconds, in which neither the upper nor lower transistor in the bridge is actuated, is provided in reference to the switching signal. This prevents a short circuit between the upper and the lower transistor.

Because of this dead zone there is a delay in the micro current, and the feed becomes uneven 24 times per motor revolution (18 times in the case of a 3-0S or 4-0S motor). A parameter for the dead zone correction in the current is used to prevent this delay, thereby correcting PWM.

The optimum values are assigned to this parameter according to the characteristics of each amplifier and motor. Therefore, do not change any standard values.

(1) Applicable Servo ROM Series/Versions

The software of all editions for all series is applicable. (As a standard, software is provided with every motor.)

(2) Detailed Explanation of Function

The parameter relating to this function is as follows.

2. SERVO FUNCTIONS

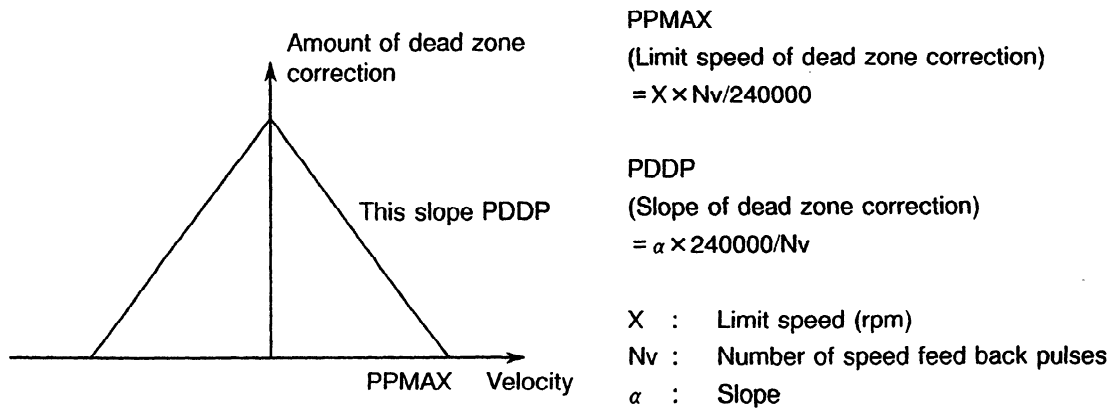

Fig. 2.8.4 (a)

With this correction, the actual current changes as shown Fig. 2.8.4 (b).

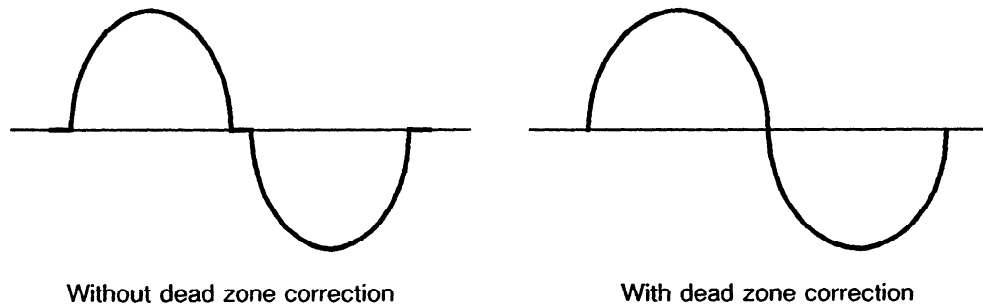

Fig. 2.8.4 (b)

If the dead zone correction parameter is not assigned correctly, the current does not form an ideal sine wave, resulting in an uneven feed 24 times per revolution.

(Note) For the systems of Series 0-A and 0-B, and Series 10, 11, 12 and 15, it is necessary to change PPMAX and PDDP in the dead zone parameter according to the number of speed feed-back pulses. For Series 0-C and Series 15, however, it is not necessary because the NC makes the necessary changes.

2.8.5 Variable phase advancement compensation function for deceleration

To improve the characteristics of the deceleration torque of the motor, this function allows the current phase advancement compensation at deceleration to be variable.

(1) Applicable servo ROM series and editions

Series 9040, editions E and later

(2) Parameter setting

① Parameter No.

No. 8X98 (Series 0-C), No. 1991 (Series 15)

Increment system : %

Setting range : 0 to 100

② Detailed explanation

This parameter determines what percentage of the value (phase advancement compensation coefficient for acceleration) set in No. 8X57 ((Series 0-C) or No. 1869 (Series 15) is to be used as a phase advancement coefficient for deceleration. When the value 0 is set, the function of current phase advancement compensation for deceleration is disabled.

(Note) For motors that require characteristic improvement, the standard parameter value is used. Therefore, the standard value set in this parameter should not be changed.

2.9 Position Loop and Velocity Loop Functions

2.9.1 Characteristics of the position loop and velocity loop

(1) Position Loop characteristics and Modification by Parameters

Fig. 2.9.1 (a) shows the block diagram of a velocity loop and position loop when I-P control is used. For simplicity of explanation a continuous analog system with an ideal current loop is assumed. The actual loop is digital and has sampling effects.

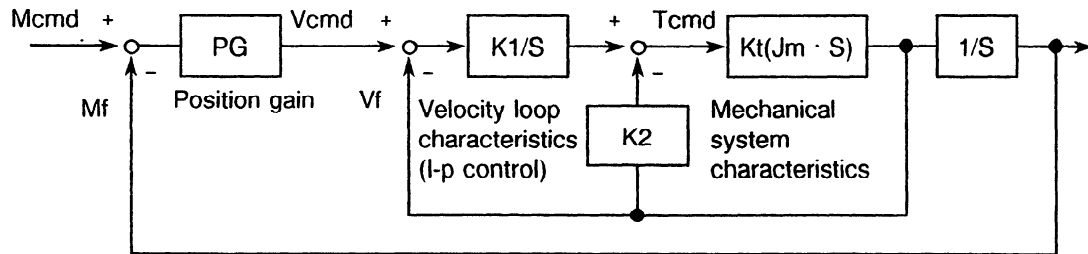

where PG : Position gain
 K1 : Velocity loop integral gain
 K2 : Velocity loop proportional gain
 Kt : Torque constant
 Jm : (Motor rotor inertia) + (load inertia)

Fig. 2.9.1 (a) Block Diagram of a Velocity Loop and Position Loop

As seen from Fig. 2.9.1 (a), a velocity command (V_{cmd}) is generated from a position gain (PG) and the deviation between a position command (M_{cmd}) and position feedback (M_f). The V_{cmd} and velocity feedback (V_f) are then applied to a velocity compensator consisting of an integral element ($K1/S$) and proportional element ($K2$) to generate a T_{cmd} (torque command). The T_{cmd} , together with mechanical system characteristics including a motor torque constant and inertia, generates a V_f . An M_f is generated by integrating a V_f . In this block diagram, the current loop characteristic is approximated to 1; $T_{cmd} \times K_t = \text{motor torque}$.

In Fig. 2.9.1 (a), the position loop is a portion where a V_{cmd} is generated from an M_{cmd} and M_f , and its characteristics largely depend on the PG. A PG the unit s^{-1} . When a step command is entered from an M_{cmd} , the M_f starts up with a time constant which is the reciprocal of the PG. This means that if the velocity loop has a time constant that is determined by about one-third to one-tenth PG, the response of the velocity loop does not affect the entire characteristics including the position loop (that is, the velocity loop is approximated to 1.) The position loop has only a proportional controller (that is, a PG). So if there is no deviation between a position command and position feedback, no velocity command is generated. This results in a servo positioning error. This positioning error is represented by expression ①.

2. SERVO FUNCTIONS

$$\epsilon = F / (A \times 60 \times PG) \quad \text{Expression ①}$$

F : Feed rate (mm/minute)
 A : Minimum detection unit (mm)
 PG : Position gain (s^{-1})

When $PG = 30$, $F = 1000$, and $A = 0.001$, for example, positioning error ϵ is

$$\epsilon = 1000 / (0.001 \times 60 \times 30) = 555.55$$

This positioning error causes a dimensional error in simultaneous two-axis cutting.

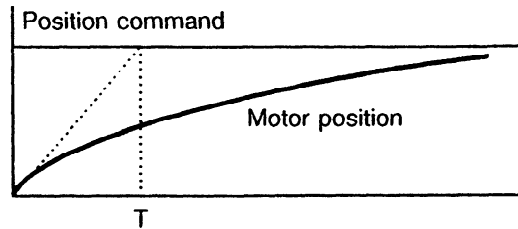

Fig. 2.9.1 (b)

Let T be a start-up time when a step is provided as a position command as shown above. Then

$$T = 1 / PG (s^{-1})$$

(2) Velocity Loop characteristics and Modification by Parameters

The transfer function of the closed velocity loop (I-P control) in the block diagram (Fig. 2.9.1 (a)) can be written as

$$H(S) = \frac{V_f}{V_{cmd}} = \frac{(K_t/J_m) \times K_1}{S^2 + (K_t/J_m) \times K_2 \cdot S + (K_t/J_m) \times K_1} \quad \text{Expression ②}$$

By definition the dynamic equation of motion for a position servo

when $(K_t/J_m) \times K_2 = 2\zeta\omega_n$ Expression ③

$(K_t/J_m) \times K_1 = \omega_n^2$ Expression ④

Expression ② is

$$H(S) = \frac{\omega_n^2}{S^2 + 2\zeta\omega_n S + \omega_n^2} \quad \text{Expression ⑤}$$

where $\omega_n = \sqrt{(K_t/J_m) \times K_1}$ Undamped natural frequency Expression ⑥

$\zeta = K_2 / 2 \times \sqrt{(K_t/J_m) \times K_1}$ Damping ratio Expression ⑦

K_1 and K_2 are related to $PK1V$ and $PK2V$ by a constant. Treat as unity for standard setting (20Hz, 0.7 damping).

2. SERVO FUNCTIONS

From the above, the frequency response of the velocity loop is obtained as follows:

$$H(j\omega) = \frac{\omega_n^2}{(\omega_n^2 - \omega^2) + j(2\zeta\omega_n)\omega} \quad \text{Expression ⑧}$$

Then gain and phase characteristics can be determined as

$$|H(j\omega)| = \sqrt{\frac{\omega_n^4}{(\omega_n^2 - \omega^2)^2 + (2\zeta\omega_n)^2 \omega^2}} \quad \text{Expression ⑨}$$

$$\angle H(j\omega) = -\tan^{-1} \left[\frac{(2\zeta\omega_n)\omega}{\omega_n^2 - \omega^2} \right] \quad \text{Expression ⑩}$$

With the digital servo system, the velocity loop parameter PK1V corresponds to K1, and Pk2V corresponds to K2. The standard parameters of the current digital servo system are set so that $f_n = 20$ (Hz) (that is, $\omega_n = 2\pi f_n = 126$) and $\zeta = 0.71$ for a single motor alone. This is based on the previous discussion that if the velocity loop has a time constant that is determined by about one-third to one-tenth PG, value 1/3 to 1/10 times as small as PG, the response of the velocity loop is sufficient. That is, when $PG = 30s^{-1}$, the time constant is 33 msec, which is equivalent to 4.8Hz, and a velocity loop range about five times greater is provided.

Even when the digital servo system is attached to a machine, the characteristics of $f_n = 20$ (Hz) and $\zeta = 0.71$ can be obtained by setting the load inertia ratio LDINT so that it matches the load inertia of the machine. It follows that to increase the PG more than $30s^{-1}$ or use feedforward, the velocity loop gain must be increased accordingly.

On the other hand, if the standard velocity loop gain cannot be maintained due to trouble such as velocity loop high-frequency oscillation, the PG may need to be decreased or a larger time constant may need to be used.

Here, let us change the value of K1 from the standard value to the following; graph 1 is then obtained:

1. K1 (standard) : $\zeta = 0.71$ $f_n = 20$
2. K1 (2 times) : $\zeta = 0.50$ $f_n = 28.3$
3. K1 (1/2 times) : $\zeta = 1.00$ $f_n = 14.1$

As can be seen from the graph, as K1 is increased, the velocity loop range increases, thus improving the frequency response. However, deteriorated damping results, and an increased gain can be seen. For this reason, when K1 is increased excessively, the velocity loop becomes unstable. In addition, oscillation can occur near the crossover frequency at the time of acceleration or deceleration.

Next, let us change the value of K2 from the standard value to the following; graph 2 is then obtained:

1. K2 (standard) : $\zeta = 0.71$ $f_n = 20$
2. K2 (2 times) : $\zeta = 1.42$ $f_n = 20$
3. K2 (1/2 times) : $\zeta = 0.35$ $f_n = 20$

2. SERVO FUNCTIONS

Graph 2 shows that when K_2 is decreased, the gain at high frequencies remain unchanged. However, deteriorated damping results, and an abrupt increase in gain can be seen near the crossover frequency. That is, K_2 contributes to the stability of the velocity loop; the velocity loop can become unstable at about 20 Hz if K_2 is decreased excessively.

Finally, graph 3 shows the effect observed when the load inertia is changed as follows:

- | | | | |
|--|---|----------------|--------------|
| 1. $J_m = 1$ (single motor unit) | : | $\zeta = 0.71$ | $f_n = 20$ |
| 6. $J_m = 2$ (same load as motor) | : | $\zeta = 0.50$ | $f_n = 14.1$ |
| 7. $J_m = 4$ (load 3 times greater than motor) | : | $\zeta = 0.35$ | $f_n = 10$ |

When load inertia is applied, the overall gain decreases, deteriorated damping results, and the velocity loop becomes unstable near the crossover frequency. This is the reason why vibration tends to occur when the load inertia is greater. In such a case, setting the load inertia ratio parameter (LDINT0) proportionally increases both K_1 and K_2 , produces the same characteristics as the standard characteristics. With an actual machine, however, the coupling of the motor and inertia is not rigid, but backlash and twist are involved, so that the gain may not be able to be increased to a theoretically calculated value. In such a case, the position gain should be decreased.

It follows that if vibration occurs at high frequency with an actual machine, K_2 (PK2V) needs to be decreased. In addition, if the response deteriorates or hunting occurs at start-up due to an insufficient velocity loop bandwidth with respect to the position gain, K_1 (PK1V) needs to be increased. However, an oscillation of about 20Hz can occur if K_1 is changed excessively with respect to K_2 or vice versa. So when I-P control is used, K_1 and K_2 should be changed within about 1/2 to 2 times, and the status (stability at acceleration/deceleration) of the machine needs to be checked with the TSA waveform in an adjustment.

(3) Velocity Loop Characteristics Changes Under I-P Control and PI Control

Fig. 2.9.1 (c) shows the block diagram of PI control.

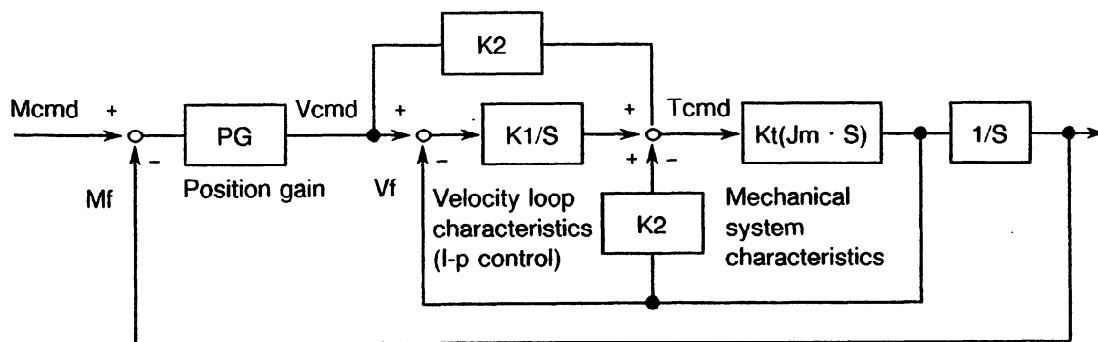

where	PG :	Position gain	Kt :	Torque constant
	K1 :	Velocity loop integral gain	Jm :	(Motor rotor inertia) + (load inertia)
	K2 :	Velocity loop proportional gain		

Fig. 2.9.1 (c) Block Diagram of PI Control

2. SERVO FUNCTIONS

The transfer function of the closed velocity loop in the block diagram can be calculated as

$$H(S) = \frac{V_f}{V_{cmd}} = \frac{(K_t/J_m) \times K_2 \cdot S + (K_t/J_m) \times K_1}{S^2 + (K_t/J_m) \times K_2 \cdot S + (K_t/J_m) \times K_1} \quad \text{Expression ⑩}$$

when

$$(K_t/J_m) \times K_2 = 2\zeta\omega_n \quad \text{Expression ⑪}$$

$$(K_t/J_m) \times K_1 = \omega_n^2 \quad \text{Expression ⑫}$$

Expression ⑩ is

$$H(S) = \frac{2\zeta\omega_n S + \omega_n^2}{S^2 + 2\zeta\omega_n S + \omega_n^2} \quad \text{Expression ⑬}$$

$$\text{where } \omega_n = \sqrt{(K_t/J_m) \times K_1} \quad \text{Expression ⑭}$$

$$\zeta = K_2/2 \times \sqrt{(K_t/J_m) \times K_1} \quad \text{Expression ⑮}$$

From the above, the frequency response of the velocity loop is obtained as follows:

$$H(j\omega) = \frac{\omega_n^2 + j(2\zeta\omega_n)\omega}{(\omega_n^2 - \omega^2) + j(2\zeta\omega_n)\omega} \quad \text{Expression ⑯}$$

Then gain and phase characteristics can be determined as

$$|H(j\omega)| = \sqrt{\frac{\omega_n^4 + (2\zeta\omega_n)^2 \omega^2}{(\omega_n^2 - \omega^2)^2 + j(2\zeta\omega_n)^2 \omega^2}} \quad \text{Expression ⑰}$$

$$\angle H(j) = -\tan^{-1} \left[\frac{(2\zeta\omega_n)\omega^3}{\omega_n^4 + \{(2\zeta\omega_n)^2 - \omega_n^2\}\omega^2} \right] \quad \text{Expression ⑱}$$

Graphs 4, 5, and 6 shows the frequency responses under PI control when K1, K2, and load inertia are changed, as in the case of I-P control.

The graphs indicate that when PI control is used, the high-frequency gain does not change even if K1 is increased, an improved stability is obtained, and the high-frequency gain is increased, thus enhancing the response. When the same standard values are entered, some differences can be seen compared with I-P control. One difference is a higher high-frequency gain. This means that oscillation tends to occur at high frequency in stop state, but the response is increased. So the capability of initial start-up in response to a position step command is improved, and gradual positioning is performed in stop operation, thus suppressing overshoot. When a different load inertia is used, the same tendency as in the case of I-P control is observed. From the viewpoint of phase, however, a decrease toward 180° is seen with I-P control. On the other hand, it is a smaller decrease of 90° with PI control; this means less oscillation tends to occur.

2. SERVO FUNCTIONS

In an actual parameter adjustment when PI control is used, the response is not deteriorated significantly even if the K1 gain is decreased by a factor of 5. However, a larger positional deviation can result at stop or move time due to friction. No stability deterioration occurs even if K2 is increased, so the gain can be increased until high-frequency oscillation occurs at stop time, and so forth.

Finally, the characteristics associated with disturbance (that is equivalent to the characteristics of Vf from the viewpoint of Tcmd because disturbance mainly appears as torque) are discussed. The following transfer function calculation applies to both I-P control and PI control:

$$D(S) = \frac{V_f}{T_d} = \frac{(1/J_m) \cdot S}{S^2 + (K_t/J_m) \times K_2 \cdot S + (K_t/J_m) \times K_1} \quad \text{Expression ④}$$

With the characteristics, K1 is a dominant factor near the frequency range, and K2 is a dominant factor for the high frequency. This means that a larger K1 value can suppress disturbance more efficiently. A smaller K2 value can lower the high-frequency gain, so that oscillation at stop time due to disturbance can be prevented.

Therefore, in the case of a smaller machine assembled fairly rigidly, an adjustment should be made to improve its resistance to disturbance and improve its response by increasing the velocity loop gain (especially K1) under I-P control. With a larger machine whose joints and ball screws involve backlash and spring elements, K2 should be increased and K1 should be decreased as much as possible under PI control. K2, however, must be increased within the range in which oscillation is not generated. K1 must be decreased within the range in which disturbance suppression is effective.

In addition, for a machine which needs a higher PG, or which causes overshoot when using the feed forward function, setting should be done under PI control.

2. SERVO FUNCTIONS

Velocity loop frequency characteristics

Graph 1 I-P control: When K1 is changed

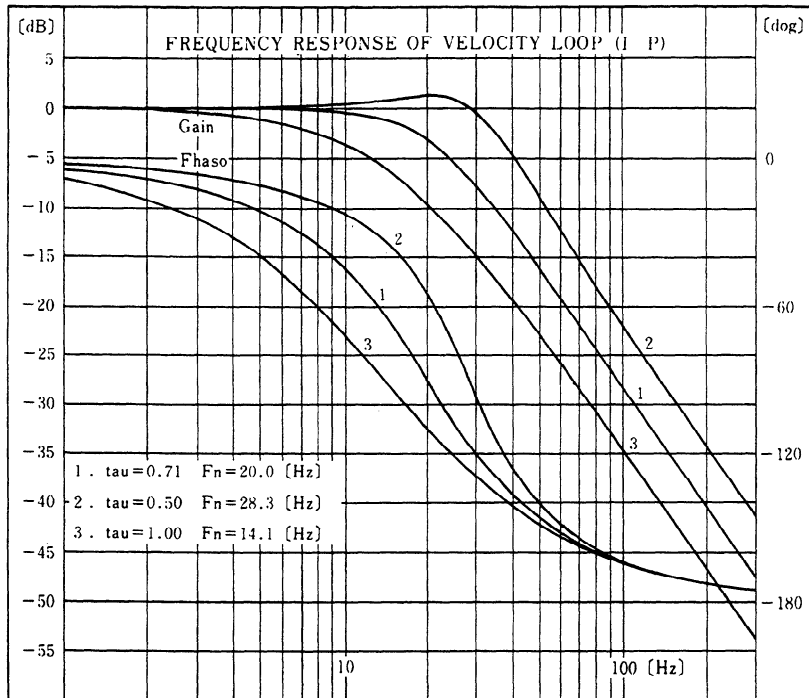

Graph 2 I-P control: When K2 is changed

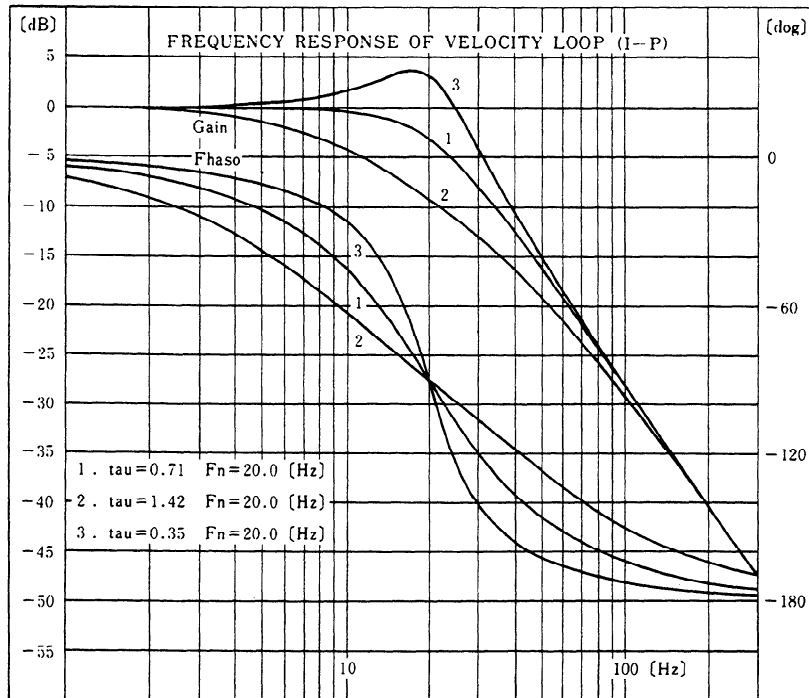

2. SERVO FUNCTIONS

Graph 3 I-P control: When load inertia is changed

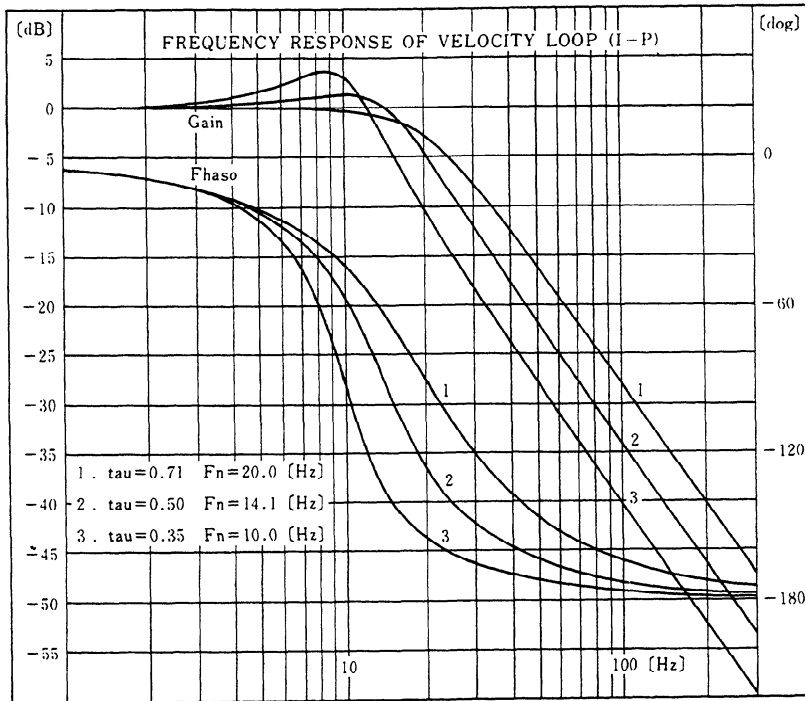

Graph 4 PI control: When K_1 is changed

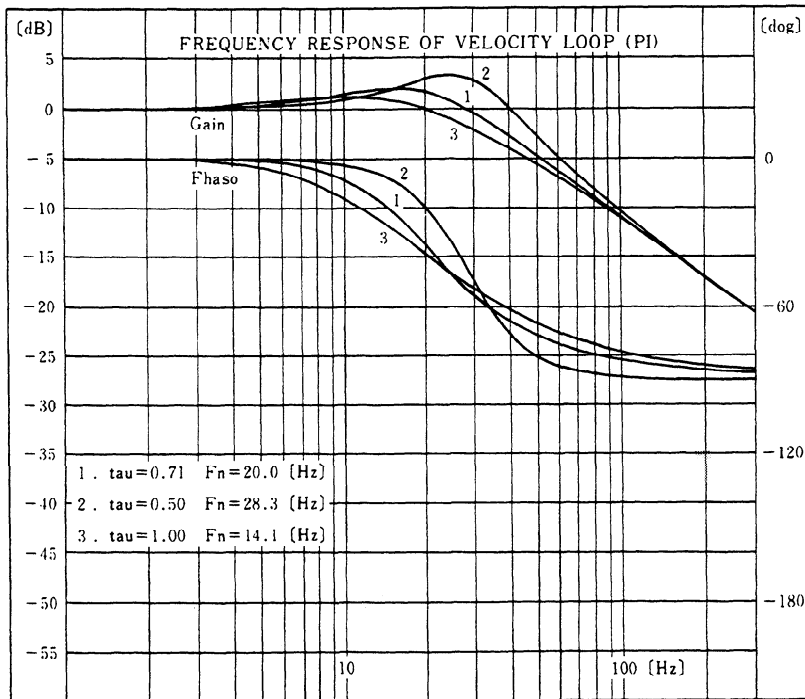

2. SERVO FUNCTIONS

Graph 5 PI control: When K2 is changed

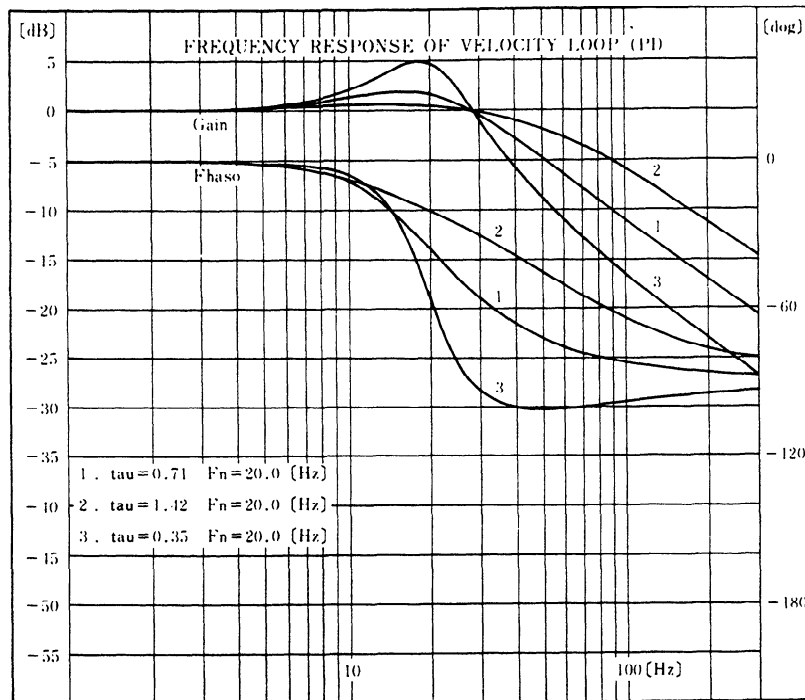

Graph 6 PI control: When load inertia is changed

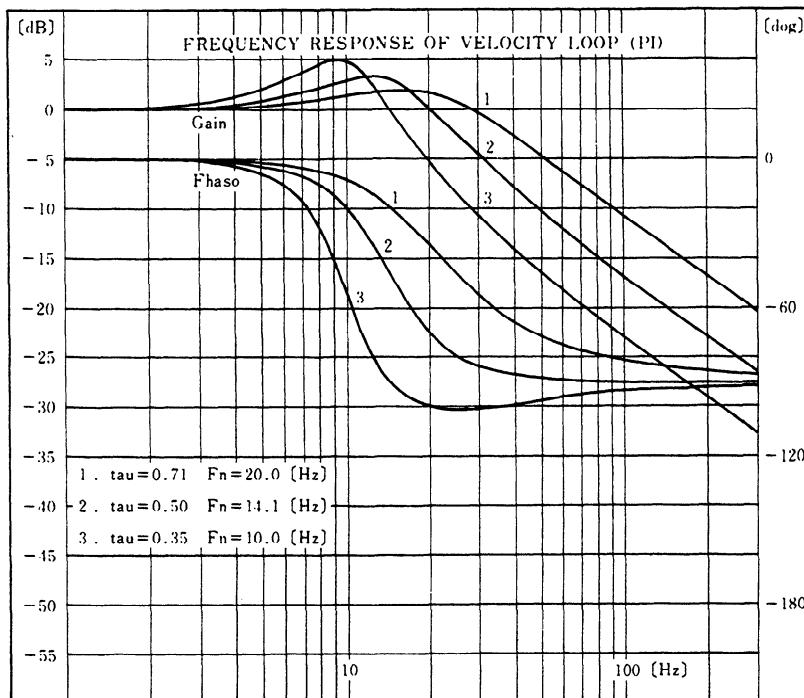

2.9.2 Setting the load inertia ratio (LDINT)

- (1) Set parameter number of the load inertia ratio (LDINT)

Series 0	No.8X21
Series 10, 11, 12, and 15	No.1875

- (2) Setting and meaning of the load inertia ratio (LDINT)

The machine load inertia ratio for the inertia of the motor rotor is calculated and set by the following expression:

$$\text{Load inertia ratio} = \frac{\text{Load inertia}}{\text{Motor rotor inertia}} \times 256$$

Setting range: 0 to 32767

Setting a value in the parameter corresponds to making velocity loop gains PK1V and PK2V (1 + LDINT/256) times. When the calculated value is set, the velocity loop response under load becomes the same as originally set for the motor without a connected load.

- (3) Example of setting the load inertia ratio (LDINT)

When rotor inertia J_m of motor model 10 is 0.10 and the load inertia J_l is 0.05, the set value is represented by the following expression:

$$\text{Set value} = \frac{0.05}{0.10} \times 256 = 128$$

- (4) Caution when setting the load inertia ratio (LDINT)

Setting the load inertia ratio (LDINT) parameter is described in Item (2). This value is set assuming that the load is rigidly applied to the motor. Therefore, in the actual machine adjustment, the set value may significantly differ from the calculated value due to rigidity, friction, backlash, etc.

- (5) Relationship between the frequency characteristic and load inertia ratio (LDINT) in the velocity loop compensation circuit

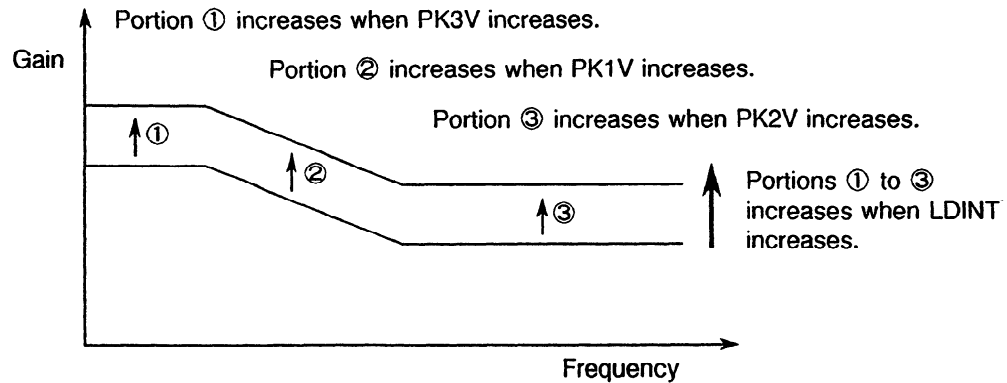

Fig. 2.9.2

2.10 Return to Reference Position

The procedure for returning to the reference position is classified into the grid method and the magnetic switch method. In the grid method, the motor is synchronized with the motor's one-rotation signal to produce a grid point. The motor is then decelerated to an FL speed using a deceleration dog. The motor then stops at the first grid point via the deceleration dog. This grid point is used as the origin. In the magnetic switch method, the motor stops immediately after a signal is sent from the magnetic switch. This stop point is used as the origin.

The feature of the grid method is that a motor always stops at the same point if the FL speed is less than a fixed value. The magnetic switch method has a simple configuration. In the magnetic switch method, however, the origin position is shifted or deviated in proportion to speed. Presently, almost all machines employ the grid method.

(Note) The magnetic switch method cannot be used in F0.

(1) The grid method for returning to the reference position

There are three grid reference position reset modes as follows:

- (a) Reference position reset when power to an incremental pulse coder is turned on for the first time, after an absolute pulse coder is installed for the first time, and when a grid shift is altered

2. SERVO FUNCTIONS

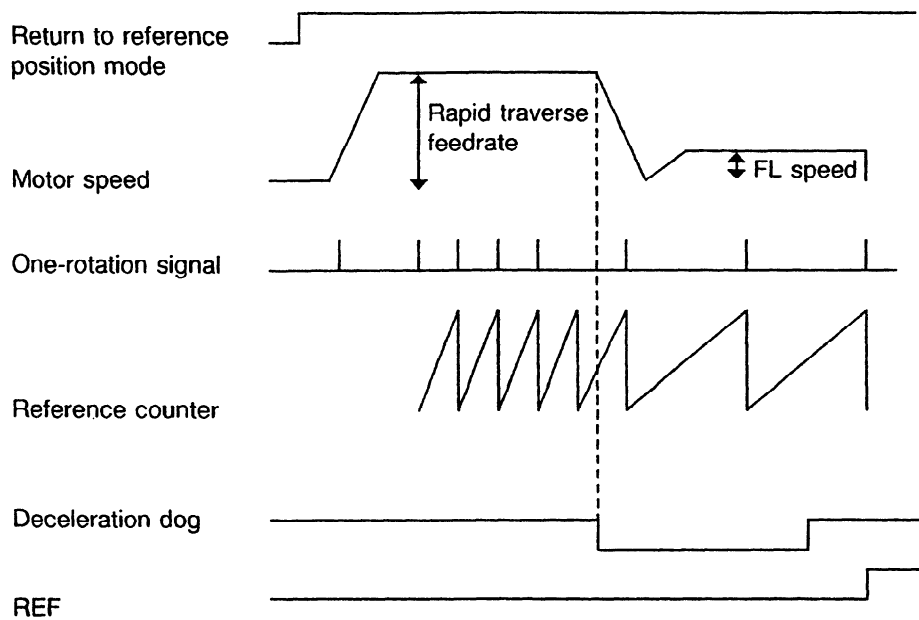

- (i) In the return to reference position mode, a reference counter is reset to 0 synchronized with a one-rotation signal when the motor is activated in the direction of the origin at a speed exceeding a fixed value (with a positioning error of 128 or more and a high resolution of 1280 or more). If a grid shift is set, the reference counter is set to the grid shift value. After that, the reference counter functions as a ring counter. The counter counts a command pulse and is reset by the reference counter capacity. A grid point is then generated synchronized with the one-rotation signal.
 - (ii) The motor is decelerated to the FL speed when it passes the deceleration dog. After leaving the deceleration dog, the motor stops at the next grid point referring to distribution command and reference counter and sets an REF return to reference position completion flag. The reference position is then reset.
- (b) Second or subsequent return to reference position when power to incremental and absolute pulse coders is turned on
- A reference counter has already been set and a grid has already been established, so only step (a) (ii) is executed to terminate the return to the reference position.
- (c) First return to the reference position when power to an absolute pulse coder is turned on
- (i) APC communication is performed to establish the current position. The distance from the origin is calculated at that time. The distance from a grid is also calculated. This value is assigned to a reference counter. This enables the grid to be established. The sequence of step (a) (i) is therefore not required.
 - (ii) The sequence of step (a) (ii) is executed to terminate resetting the reference position.

2. SERVO FUNCTIONS

(2) Parameter Setting for the Grid Method for Returning to the Reference Position

(a) Selecting the method for returning to the reference position

Series 10, 11, 12, 15 No.1005 Bit 1 = 0

(Grid method for returning to reference position)

(b) Setting the reference counter capacity

Series 10, 11, 12, 15 No.1816 (bit type) Bits 3 to 0

No.1896 (word type)

Series 0-A, 0-B, 0-C (16 bits) No.004 to 007 (bit type) Bits 3 to 0

Series 0-C (32 bits) No.004 to 007 (bit type) Bits 3 to 0

No.570 to 573 (word type)

(Note) The word type indicates any reference counter capacity. If this parameter is 0, a conventional bit type is valid.

If it consists of numerics other than 0, the parameter that is set above is valid.

This capacity must be the same as the number of position pulses per motor rotation or must be set to a divisor of the number of pulses. If the capacity is set incorrectly, the motor does not stop at the same position. (See Section I-3.4.2 for details about setting.)

(c) FL speed setting

Series 10, 11, 12, 15 No.1425 (word type, each axis)

Series 0 No.537 (word type, all axes)

(Note) The FL speed must be reduced when the return position is deviated.

(d) Rapid traverse speed setting

Series 10, 11, 12, 15 No.1420 (word type, each axis)

Series 0 No.559 to 562 (word type, each axis)

(Note) If the positioning error during rapid traverse is less than 128 pulses (1280 pulses for a high-resolution pulse coder), the reference position cannot be reset. Accelerate the rapid traverse.

(e) Setting the time constant for rapid traverse acceleration or deceleration

Series 10, 11, 12, 15 No.1620 (word type, each axis)

Series 0 No.522 to 525 (word type, each axis)

(Note) If the motor cannot be decelerated until it reaches the FL speed in a deceleration dog, it cannot be return to the reference position. In this case, lengthen the deceleration dog, decelerate the rapid traverse, or decrease the time constant for rapid traverse acceleration or deceleration.

2. SERVO FUNCTIONS

(3) The magnetic switch method for returning to the reference position

The sequence of the magnetic switch method is shown in the figure below.

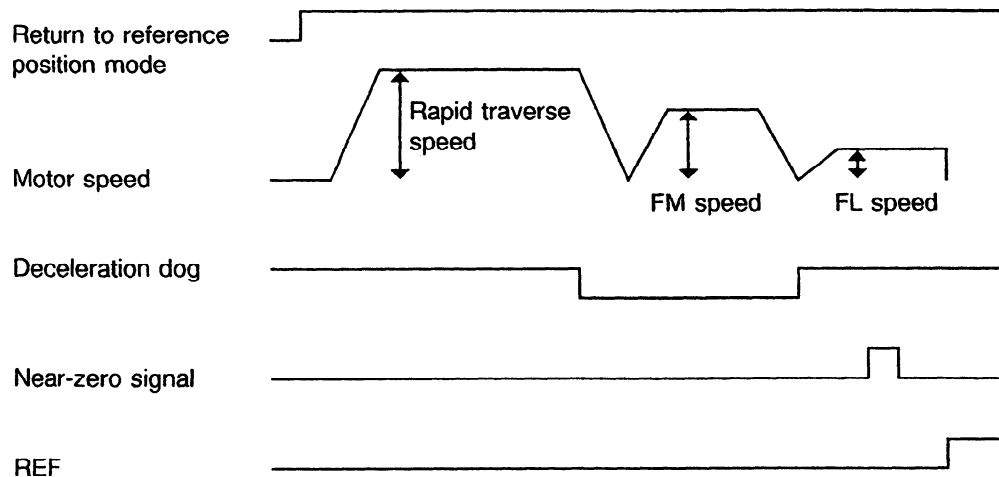

- ① In the return to reference position mode, the motor traverses rapidly in the direction of the origin, then decelerated to the FM speed when it passes the deceleration dog.
- ② After leaving the deceleration dog, the motor decelerates to the FL speed, then stops immediately after a near-zero signal is sent. The motor then sends an REF signal back to terminate returning the reference position. The FL speed is proportionally related to the deviation in the return to the reference position.

(4) Parameter setting for the magnetic switch method for returning to the origin

- ① Selecting method for returning to the reference position
Series 10, 11, 12, 15 No.1005 Bit 1 = 1
(magnetic switch method for returning to the reference position)
- ② Near-zero signal extraction selection
Series 10, 11, 12 No.1815 Bit 1 = 1
Series 15 No.1815 Bit 1 = 0
- ③ Setting the rapid traverse speed
Series 10, 11, 12, 15 No.1420 (word type, each axis)
- ④ Setting the FM speed
Series 10, 11, 12, 15 No.1424 (word type, each axis)
- ⑤ Setting the FL speed
Series 10, 11, 12, 15 No.142b (word type, each axis)

**2.11 Servo Software for High-speed Positioning Machine
(Punch Press, PC Board Drilling Machine, etc.)**

To use FANUC digital AC servo for a high-speed positioning machine, the following servo software is prepared.

(1) Applicable Servo ROM Series/Versions

- Series 9002/001C and subsequent revisions
- 9022/001A and subsequent revisions
- 9032/001A and subsequent revisions

Servo ROM series	Applicable NC
9002	Series 0-PB Series 00-PB Series 11
9022	Series 0-PB (upgraded) Series 00-PB(upgraded) Series 0-PC (16 bits) Series 11 (upgraded)
9032	Series 15 Series 0-PC (32 bits)

This servo software is explained below.

2. SERVO FUNCTIONS

(2) Parameters related to Series 11 and 15

	B7	B6	B5	B4	B3	B2	B1	B0
1804							DGPRM	PLC01
1806	AMR7	AMR6	AMR5	AMR4	AMR3	AMR2	AMR1	AMR0
1807				0	PFSEL			
1808	VOFST	OVSCMP	BLNBL	1PSPRS	PIENBL	OBENBL	TGALRM	*NDL8
1809			TRW1	TRW0	TINA1	TINA0	TINB1	TINB0

- 1852 : Current loop gain (PK1)
- 1853 : Current loop gain (PK2)
- 1854 : Current loop gain (KP3)
- 1855 : Velocity loop gain (PK1V)
- 1856 : Velocity loop gain (PK2V)
- 1857 : Incomplete integration coefficient (PK3V)
- 1858 : Velocity loop gain (PK4V)
- 1859 : Speed control observer parameter (POA1)
- 1860 : Speed control backlash correction improvement (BLCMP)
- 1861* : Integration speed preset value at low speed (POA3)
- 1862 : Speed control observer parameter (POK1)
- 1863 : Speed control observer parameter (POK2)
- 1864* : Integration preset value at low speed (POK3)
- 1865 : Current deadband compensation (PPMAX)
- 1866 : Current deadband compensation (PDDP)
- 1867 : Current deadband compensation (PHYST)
- 1868 : Counter electromotive force correction (EMFCMP)
- 1869 : Current phase control (PVPA)
- 1870 : Current phase control (PALPH)
- 1871* : Position gain switching speed preset value (PGTWN)
- 1872 : Torque limit (TQLIM)
- 1873 : Back electromotive force correction (EMFLMT)
- 1874 : Motor type
- 1875 : Load inertia ratio (LDINT)
- 1876 : Speed feedback pulses (PULCO)
- 1877 : Overload protective coefficient (OVC1)
- 1878 : Overload protective coefficient (OVC2)
- 1879 : Motor rotating direction (DIRCTL)

(Note) The asterisked (*) parameters, which differ from those for a general machine tool, are ones for a high-speed positioning machine.

2. SERVO FUNCTIONS

1883							FEEDFD	PKVER
------	--	--	--	--	--	--	--------	-------

1884	PGTWN	DCBEMF	FCBLCM			SSG1		
------	-------	--------	--------	--	--	------	--	--

- 1891 : Position detecting feedback pulse numbers (PPLS)
 1892 : TG alarm level (TGALMLV)
 1893 : Overload protecting coefficient (OVCLMT)
1894* : Acceleration feedback (WKAC)
1895* : Torque command filter (TCFIL)
 1961 : Feedforward coefficient (FALPH)
 1962 : Feedforward filter (VFFCT)
 1963 : Backlash correcting acceleration parameter (ERBLM)
 1964 : Backlash correcting acceleration parameter (PBLCT)
 1967 : Speed dependent current loop gain parameter (AALPH)

(3) Parameters related to Series 0

	B7	B6	B5	B4	B3	B2	B1	B0
8X00							DGPRM	PLC01
8X01	AMR7	AMR6	AMR5	AMR4	AMR3	AMR2	AMR1	AMR0
8X02					PFSEL			
8X03	VOFST	OVSCMP	BLENBL	1PSPRS	PIENBL	OBENBL	TGALRM	*NDL8
8X04			TRW1	TRW0	TINA1	TINA0	TINB1	TINB0
8X05							FEEDFD	PKVER
8X06	PGTWN	DCBEMF	FCBLCM			SSG1		

- 8X20 : Motor type
 8X21 : Load inertia ratio (LDINT)
 8X22 : Motor rotating direction (DIRCTL)
 8X23 : Speed feedback pulse numbers (PULCO)
 8X24 : Position feedback pulse numbers (PPLS)
 8X40 : Current loop gain (PK1)
 8X41 : Current loop gain (PK2)
 8X42 : Current loop gain (PK3)
 8X43 : Speed loop gain (PK1V)
 8X44 : Speed loop gain (PK2V)
 8X45 : Incomplete integration coefficient (PK3)
 8X46 : Speed loop gain (PK4)

2. SERVO FUNCTIONS

8X47	:	Speed control observer parameter (P0A1)
8X48	:	Speed control backlash correcting improvement (BLCMP)
<u>8X49*</u>	:	<u>Speed preset value of integration at low speed (POA3)</u>
8X50	:	Speed control observer parameter (POK1)
8X51	:	Speed control observer parameter (POK2)
<u>8X52*</u>	:	<u>Speed preset value of integration at low speed (POK3)</u>
8X53	:	Current deadband correction (PPMAX)
8X54	:	Current deadband correction (PDDP)
8X55	:	Current deadband correction (PHYST)
8X56	:	Counter electromotive force correction (EMFCMP)
8X57	:	Current phase control (PVPA)
8X58	:	Current phase control (PALPH)
<u>8X59*</u>	:	<u>Position gain switching speed preset value (PGTWN)</u>
8X60	:	Torque limit (TQLIM)
8X61	:	Counter electromotive force correction (EMFLMT)
8X62	:	Overload protecting coefficient (OVC1)
8X63	:	Overload protecting coefficient (OVC2)
8X64	:	TG alarm level (TGALMLV)
8X65	:	Overload protecting coefficient (OVCLMT)
<u>8X66*</u>	:	<u>Acceleration feedback (WKAC)</u>
<u>8X67*</u>	:	<u>Torque command filter (TCFIL)</u>
8X68	:	Feedforward coefficient (FALPH)
8X69	:	Forward filter (VFFLT)
8X70	:	Backlash correcting acceleration parameter (ERBLM)
8X71	:	Backlash correcting acceleration parameter (PBLCT)
8X74	:	Speed dependent current loop gain parameter (AALPH)

(Note) The asterisked (*) parameters, which differ from those for a general machine tool, are ones for a high-speed positioning machine.

2. SERVO FUNCTIONS

(4) Parameter details (for high-speed positioning machine)

In the following parameter explanation, Parameter No. for Series 0 and Series 11 and 15 is indicated on the upper and lower stages respectively.

Unlike those for general machine tools, these parameters are used for the high-speed positioning machine.

Parameter No.	Parameter							
8X06	PGTWN	DCBEMF	FCBLCM			SSG1		
1884	PGTWN	DCBEMF	FCBLCM			SSG1		
	B7	B6	B5	B4	B3	B2	B1	B0
Standard setting:	0	0	0	0	0	0	0	0

SSG1 (Integration at low speed)

Relevant parameters

In speed control:

0 : Integration is carried out regardless of the speed.

1 : Integration is carried out only at low speed and stop.

8X49	8X52
1861	1864

Note: When SSG1 (integration at low speeds) is used, set the speed control to PI control.

Set parameter No.8X03 (Series 0) and 1808 (Series 11 and 15) Bit 3 to 1.

FCBLCM In full-closed feedback:

0 : Backlash correcting pulse is handled normally.

1 : Backlash correcting pulse is not used for position correction.

8X48
1860

DCBEMF Back EMF compensation for deceleration:

0 : not corrected.

1 : corrected.

PGTWN (Position gain switching)

According to the speed, the position gain is:

0 : not doubled

1 : doubled

8X59
1871

2. SERVO FUNCTIONS

Parameter No.	Parameter
8X49	Speed preset value of integration at low speed (POA3)
1861	Speed preset value of integration at low speed (POA3)
	Data range : 0 to 32767 (After 9002C/9022A/9032A)
	Standard setting : 0
8X52	Speed preset value of integration at low speed (POK3)
1864	Speed preset value of integration at low speed (POK3)
	Data range : 0 to 32767 (After 9002C/9022A/9032A)
	Standard setting : 0
8X59	Position gain switching speed preset value (PGTWN)
1871	Position gain switching speed preset value (PGTWN)
	Data range : 0 to 32767 (After 9002J/9022A/9032A)
8X66	Acceleration feedback gain (WKAC)
1894	Acceleration feedback gain (WKAC)
	Data range : 0 to 32767 (After 9002F/9022A/9032A)
	Standard setting : 0
<p>Note: When the acceleration feedback is used, use the torque command filter of Parameter No.8X67 (Series 0) and 1895 (Series 11 and 15) together.</p>	
8X67	Torque command filter (TCFIL)
1895	Torque command filter (TCFIL)
	Data range : 0 to 4096 (After 9002F/9022A/9032A)
	Standard setting : 0

2.11.1 Special function

(1) Integration at low speed (SSG1)

The integrator for speed control is effective only at low speed an stop. This function makes it possible to increase startup and fall at acceleration and deceleration. However, no integrator functions out of the setting speed range when moving.

	Parameter No.	Parameter
Function bit:	8X06	B7 B6 B5 B4 B3 B2 B1 B0
	1884	0 0 0 0 0 1 0 0
Function parameter:	8X49	POA3 - Integration at low speed (Speed preset value for disabling the integrator)
	1861	
		Data range : 0 to 32767 Standard preset value : 100 to 2000
Function parameter:	8X52	POK3 - Integration at low speed (Speed preset value for enabling the integrator)
	1864	
		Data range : 0 to 32767 Standard preset value : 100 to 2000

Setting method : The speed for enabling and disabling the integrator can be calculated by the following equation.

(a) POA3 (speed preset value for disabling the integrator)

$$POA3 = \frac{32767}{480} \times \left(1 + \frac{LDINT}{256}\right) \times Xrpm$$

(b) POK3 (speed preset value for enabling the integrator)

$$POK3 = \frac{\frac{32767}{480} \times \left(\frac{Np}{2000}\right)^2 \times Xrpm}{\left(1 + \frac{LDINT}{256}\right)}$$

LDINT : Load inertia ratio
Np : Encoder pulse numbers

2. SERVO FUNCTIONS

Example: Assuming the speed to be X, encoder pulse numbers to be 2,500P/rev, and load inertia ratio ILDINT to be 300

when X = 10 rpm, P0A3 is found by:

$$P0A3 = \frac{32767}{480} \times \left(1 + \frac{300}{256}\right) \times 10 \text{ rpm}$$

$$= 1483$$

when X = 15 rpm, P0K3 is found by:

$$P0K3 = \frac{\frac{32767}{480} \times \left(\frac{2500}{2000}\right)^2 \times 15 \text{ rpm}}{\left(1 + \frac{300}{256}\right)}$$

$$= 737$$

(2) Position gain polygonal line (PGTWN)

This function doubles the position gain in low ranges. It is used when the positioning time is long and the motor stop time becomes short.

	Parameter No.	Parameter							
Function bit:	8X06	B7	B6	B5	B4	B3	B2	B1	B0
	1884	1	0	0	0	0	1	0	0
Function parameter:	8X59	Speed preset value for doubling the position gain							
	1871								
		Data range		: 0 to 32767					
		Standard preset value		: 0 to 32767 (for 2000P)					

Setting method : Assuming the speed to be X and the encoder pulse numbers to be N, the speed preset value Y is:

$$Y = \frac{32767}{1920 \times \frac{2000}{N_p}} \times X \text{ rpm}$$

Example: Y = 1280 when $N_p = 3000\text{P/rev.}$ and X = 50 rpm.

When $N_p = 3000\text{P/rev.}$ 50 rpm or less position gain can be doubled by inputting 1280 to Y.

(3) Acceleration feedback (WKAC)

When external inertia is larger than the motor inertia, and the system is unstable, this function can stabilize the servo system. If it is made larger than required, an abnormal noise will occur from the motor; therefore, use the minimum value so that no noise occurs.

When the acceleration feedback is used, it is necessary to insert a torque command filter. The filter value should be approx. 2000 to 3700.

Function bit: None

Function parameter:	8X66	WKAC Acceleration feedback gain
	1894	
		Data range : 0 to 32767
		Standard preset value : 100 to 1000

Function bit: None

Function parameter:	8X67	TCFIL Torque command filter
	1895	
		Data range : 0 to 4096
		Standard preset value : 2000 to 3700

The torque command filter filters the current control torque command.

See the item for the 0.25 msec velocity control period in Table 1 of Section II-2.3.1 when setting the torque command filter. Set the cut-off frequency at about 50% of the resonance frequency.

However, vibration may be increased; therefore, take due care when using it. (3800 or more is absolutely inhibited.)

2.11.2 High-speed positioning function

(1) Function for high-speed positioning

The following may be used:

- ① PI control for speed control
- ② Integration for speed control at low speeds
- ③ Position gain switching

(2) Effective function for vibration countermeasures

For highly torsional system, such as a high-speed positioning machine, the acceleration feedback is used to stabilize the system. The torsional vibration can be controlled by using this function.

2. SERVO FUNCTIONS

(Note) The 9002/9022/9032 series differ in parameters from the ROM series for a general machine tool:

(a) Difference in parameter meaning

Series 0	Series 10, 11, 15	9002, 9022, 9032 series	ROM series for general machine tool
No.8X59	No.1871	Position gain switching speed preset value (PGTWN)	Back EMF voltage correction (EMFBAS)
No.8X66	No.1894	Acceleration feedback (WKAC)	PK2VAUX

(b) Bit position different in bit type parameter

Parameter name	9002, 9022, 9032 series		ROM series for general machine tool
FCBLCM	Series 0	No.8X06 Bit 5	Series 0 No.8X06 Bit 0
	Series 10, 11, 15	No.1884 Bit 5	Series 10, 11, 15 No.1884 Bit 0
PKVER	Series 0	No.8X05 Bit 0	Series 0 No.8X06 Bit 2
	Series 10, 11, 15	No.1883 Bit 0	Series 10, 11, 15 No.1884 Bit 2

2.11.3 Method of adjustment

Series 0 is explained for the standard case.

(1) Setting

Before conducting adjustment, make the following settings for the standard servo parameters.

- 8X06 : Make Bit 2 equal to 1 (low-speed integration valid)
- 8X03 : Make Bit 3 equal to 1 (P1 control)
- 8X49 : Low-speed integration P0A3 100
- 8X52 : Low-speed integration P0K3 100
- 8X21 : Load inertia ; 0
- 8X43 : Velocity loop integral gain ; 50 to 200
- 8X44 : Velocity loop ratio gain ; $\text{Standard value} \times \left(1 + \frac{\text{Load inertia}}{\text{Motor inertia}}\right)$
- 96 to 99 : Time constant ; 100 msec
- 452 to 455 : Position gain ; 4000 to 5000 (0.01 sec^{-1})

Using the function of integration for speed control at low speeds, and making load inertia equal to 1, adjust the integration gain, ratio gain, time constant, and position gain.

2. SERVO FUNCTIONS

(2) Positioning waveform and hit rate

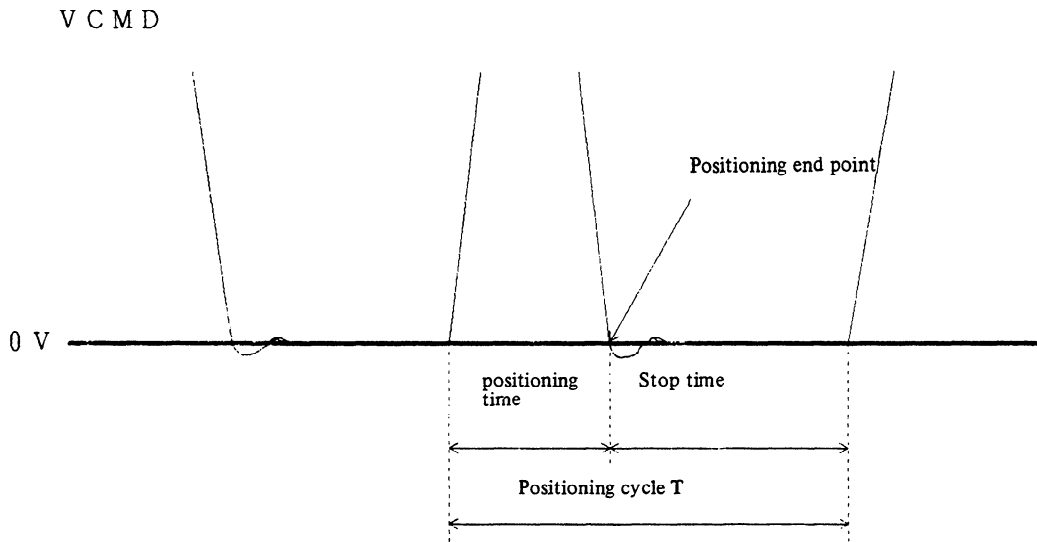

Reducing the positioning cycle allows increase in the hit rate.

$$\text{Hit rate} = \frac{60000 \text{ msec}}{T \text{ msec}}$$

(3) Adjustment

- (a) Adjust the ratio gain (PK2V) so that the waveform when there is 25 mm feed becomes like B.

(In the case that the printed board drilling machine is 2.54 mm feed.)

In the case of overshooting (waveform A), raise the ratio gain (PK2V).

In the case of undershooting (waveform C), lower the ratio gain (PK2V).

(What is being described here is the increase to one side. For example, from - 100 to - 200.)

- (b) When the ratio gain (PK2V) only cannot be adjusted, change the time constant and position gain a little at a time. However, do not change outside the range in which there is no vibration. Change the time constant 20 msec at a time and change the position gain 2 (1/s) at a time. Change the parameters in the following manner in order to change the waveform.

- ① To change the waveform from A to B : Lengthen the time constant.
Lower the position gain.
- ② To change the waveform from B to C : Shorten the time constant.
Raise the position gain.

(Note) If the ratio gain (PK2V) and position gain are greatly over-set the oscillation limit will be exceeded and it will oscillate. Accordingly, determine the oscillation limit and take as a limit a value of about 70% of this. Furthermore, when it is desired to slightly raise the oscillation limit of the ratio gain (PK2V), use the acceleration feedback function. However, depending on the system, the situation may worsen.

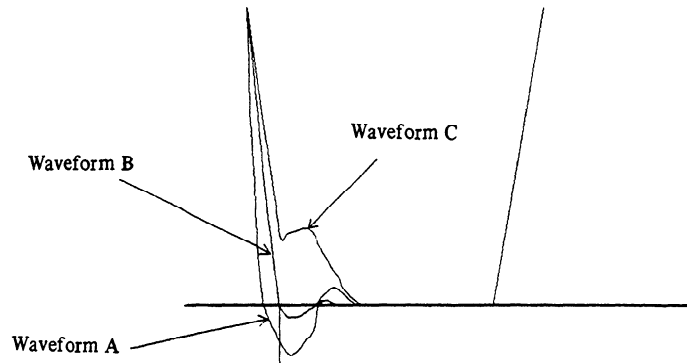

- (c) Next, with the above values check the waveform of a short distance. If the waveform is undershooting, use the position gain switching function. The waveform will become as shown below.

No.8X06 "1" is valid in BIT 7 (Position gain switching valid)

No.8X59 250

When changing the value of parameter No.8X59 by 50 at a time, the waveform will become like B.

(If it is excessively raised, it may vibrate.)

When using the position gain switching function, lower the position gain. In the low speed range, because the position gain becomes double, it may vibrate.

- (d) When using Series 0-P as a turret press, depending on the distance it is possible to change the time constant, position gain and speed.

For details, refer to the Series 0-P maintenance manual.

2.11.4 Servo parameter setting for combined punch press and laser machine tools

In combined punch press and laser machine tools, a problem arises in the cutting path of the laser machine tool when parameters are set for positioning of the punch press alone. Therefore, functions are needed that are valid in punch press mode, but invalid in laser machining mode.

- (1) Applicable Servo ROM Series/Versions

9022/001C version and thereafter

9032/001A version and thereafter

(2) Parameter Setting Method and Action

In the case of combined punch press and laser machine tools

	Parameter No.	Parameter							
Function bit:	8X10	B7	B6	B5	B4	B3	B2	B1	B0
	1954	1	0	0	0	0	0	0	0

In the case where the laser mode is specified by M code during the machining program, the following two functions become invalid:

- Position gain switching
- Low-speed integration

These above-listed functions enable faster positioning in punch press mode, but position loop gain and speed loop gain become discontinuous at low speed, and therefore, the cutting path is inaccurate. For this reason these functions are invalid in laser cutting mode.

2.12 Types of Scales

To improve and maintain the accuracy of machine tools, it may be necessary to install a direct-position detector (so-called scale feedback).

In general, electrically magnifying the graduations of the scale from a period of 8 microns 2 mm gives a resolution of 0.1 to 1 micron. the electrical magnifying circuit of some scales must be adjusted, and incorrect adjustment may result in an error of several microns.

This error affects the positioning, and results in an erratic output signal if the table is operated continuously. This in turn degrades the quality of the machined surfaces.

The causes of degraded machine surfaces resulting from errors in the scale can be classified into two groups.

(a) An erratic output signal is generated for each graduation period, the servo is used (or attempted to be used) as the signal, and the table is driven erratically. In this case, the machined surface exhibits stripes whose pitch equals the scale graduation (or half of the period). These stripes may be reduced by adjusting the circuit if the scale is adjustable.

(b) There is a substantial gap between the motor and the scale, causing a delay in the position loop, which in turn results in erratic table motion. This problem cannot be solved unless the machine gap is eliminated.

In either case, it is easy to identify if the scale is responsible for the problem. Simply isolate the scale (using the motor's built-in pulse coder) using a parameter.

Linear scales can be classified into three groups by their construction.

2. SERVO FUNCTIONS

Some separate position detectors operate with the same principle as linear scales. The position detectors have advantages and disadvantages similar to those of linear scales.

(1) Inductosyn (Resolver)

With Inductosyn, an energizing current operating at several kilohertz is drawn through a zigzag scale pattern, generally secured on the bed. The scale has a shape resembling a comb. The current is detected by a head, or slider, positioned opposite the scale pattern at a certain gap.

- The advantage of Inductosyn is superior contamination resistance.
- The graduation period is 2 mm.
- An A/D converter made by Mitsubishi heavy Industries, Ltd. is used to connect the scale to a NC.
- The A/D converter must be adjusted.
- Since the 2-mm graduation period is longer than the other two, it is not likely to result in the degraded surface quality even when the scale is poorly adjusted. However, measuring the roundness may reveal steps resembling contours.

(2) Magnescale

- With the Magnescale, a magnetic pattern is detected.
- This scale also has superior contamination resistance.
- The graduation period is 0.2 mm.
- An adjustment volume control is provided in the detection circuit.
- A frequency of around 10 Hz may result during finish cutting at an approximate feed rate of F100, eventually causing a degradation in the surface smoothness.

(3) Optical Scale (Optical Encoder)

With the optical scale, the position is detected by the light transmitted through slots marked on the glass. As this scale is susceptible to contamination, it is generally housed in a case for general purposes (1 micron). Since the graduation period, of 8 to 40 microns, is less than the others, maladjustment is not likely to affect the surface roughness except for a very gradual inclination (such as one degree or about 1/100).

The features of the products are as follows:

Nikon Co., Ltd.

- The graduation period is 8 microns.
- The encoder is factory set. It is not possible to adjust it in the field.

Heidenhein Co., Ltd.

- Encoders made by this company have a high reputation among machine tool manufacturers.
- The graduation periods are 10 microns and 20 microns.
- It is necessary to adjust the open-type encoders. It is not possible to adjust the encoders housed inside a case.

2. SERVO FUNCTIONS

Futaba Denshi Co., Ltd.

- The graduation periods are 16 microns and 40 microns.
- An adjustment mechanism is provided on the head.

Mitsutoyo Co., Ltd.

- The graduation periods are 10 microns and 20 microns.
- The encoder is factory set. It is not possible to adjust it in the field.

2.13 Difference due to the Sliding Surface and the Guide Types

In general, the machine is driven by a ball screw. However, there are many types of mechanisms for supporting the machine weight and for the guides.

In some cases, separate mechanism are used for the linear-motion guide and to support the weight. However, one mechanism is usually used for the two functions.

The mechanisms are briefly classified below, listing their advantages and disadvantages.

Note that the explanations are made from FANUC's viewpoint, and do not necessarily represent the view points of the machine manufacturers.

(1) Mechanism that Supports the Weight and Guides the Motion Using Friction Surface

Supporting the weight using static friction has the disadvantages of greater starting torque, greater motion torque, greater delay in turning when cutting an arc, etc. However, its advantage is smaller runout because the reaction force resulting from the intermittent cutting is absorbed by the friction surfaces.

If the friction is high and exceeds the required speed reduction torque when reducing the table speed and stopping it, the motor will stop while pushing the machine. This provides stable repetitive positioning accuracy without any over shooting.

Although greater friction increases the load on the motor, the positioning force and kinetic energy will be dissipated by the friction when the gravity shaft is lowered or its speed is reduced. Therefore, regenerative discharge load is reduced.

Since the friction is reduced mostly by lubricant, the motion at the start of work each day is not perfect. This is understood by most machine manufacturers and end users.

In general, the curve of the fixed rail has no adverse affect since the guide provided on the moving side is sufficiently long.

2. SERVO FUNCTIONS

(a) Ground surface (rail) and sliding guide

Although this type requires a lot of labor, it provides the most stable motion.

Lubricant is trapped in on the sliding surface in convex and concave areas resembling fish scales. This construction ensures stable lubrication, and the metal to metal contact ensures high rigidity.

The disadvantage is that the motion is liable to become too stiff, depending on the adjustment of the gib used to eliminate the gap. (The gib is a spacer resembling a wedge.)

(b) Ground surface (rail) and turkite

This type is used by many manufacturers since it does not involve the sliding technique.

Although it is possible to obtain high accuracy with this type, the table motion may change overtime after lubricating the gap intermittently.

It is possible to check if the table motion has changed by stopping the supply of lubricant and checking if the repetitive motion varies slightly.

(2) Mechanism that Supports the Weight by Rolling and Guides the Motion Using Friction Surfaces

If the load becomes too great when the weight is supported by the friction surfaces, the machine may be placed on a roller pack, i.e., a set of rollers.

With this mechanism, the disadvantage of rolling stated under item (3) are not so pronounced. It seems to be possible to obtain characteristics similar to that of the friction guide described in item (1) above.

(3) Mechanism that Supports the Weight and Guides the Motion by Rolling

In general, this mechanism is always used for machines with substantial travel since it involves less friction. An example is the punch press.

Since the starting torque and the moving torque are also lower when the rolling motion is properly adjusted, the mechanism provides a good response when changing the direction of motion.

However, the lower friction torque means that the reaction force from the machine during intermittent cutting is directly transferred to the motor, causing motor movement.

In addition, a lower motion torque leaves more starting torque. Therefore, feeding the table using minute strokes results in overshooting.

Furthermore, replacing the friction guide with the rolling guide reduces the load on the motor but increases the load for the regenerative discharge. Even with the reduced load on the motor, the regenerative alarm tends to be frequently activated if the positioning frequency alone is increased. Rigidity against the load changes drastically depending on the shape of the rolling object.

2. SERVO FUNCTIONS

Although the rigidity can be neglected in case of a roller, the rigidity of a ball is lower than expected. (It becomes clear if one imagines how a roller and a ball deform.)

Because all the machines are designed to require low motion torque during the rapid feeding, it is possible that the machine requires excessive torque at the beginning of work each day. At this time, the lubricating temperature of the balls is low and the viscosity is high, causing insufficient table acceleration. This problem can usually be eliminated by operating the table through several strokes. However, it may be necessary for the machine manufacturer to increase the time constant for the machine or, if the time constant does not have much margin, it may be necessary for the users to limit the duty by 50% at the beginning of work each day.

(a) LM guide (trademark registered by THK) and similar structures

This type of guide is commonly used for many mass-produced machines. This is because the machine parts, such as the bed, the guide, etc., are easily manufactured.

However, since it is not possible to control the distances between the rolling balls, the table is liable to seize if the balls become clogged. (A spacer ball has been designed to minimize clogging of the balls, but it is not perfect.)

Furthermore, the use of balls means that the rigidity against the load is not sufficiently high. Some mechanisms use applied pressure to increase the rigidity. However, the pressure tends to increase the starting torque and make the balls more liable to become clogged.

In addition, the dust seal on the guide acts as another source of friction. Some guide manufacturers claim that the coefficient of friction is as low as about 0.01. However, none of the guides used for the machine tools have such a low coefficient.

Because of the contact angle of the balls, the ball bearing housing the balls has lower rigidity against tensile force than compressive force. Therefore, the motion of the table may become unstable depending on the position of the table and the direction of the force.

In general, there are two rails each having two guides.

The curve of the installed rail may be directly picked up because it is guided at only two points.

(b) Cross-roller guide

This guide consists of cylindrical rollers placed between V-shaped grooves arranged in opposition to each other.

Although this guide provides high rigidity, it is rarely used now because the V-shaped grooves require high accuracy.

Its disadvantage is that, despite the length of the rail, it does not provide a long stroke (travel distance). As a result, the guide is made to overhang the roller guide, if provided, and is used.

The overhang may cause the machine to tilt as the mechanism travels beyond the center of gravity.

2. SERVO FUNCTIONS

(4) Mechanism that Supports the Weight and Guides the Motion by Static Pressure

On some types of this mechanism, oil or air is blown between the two opposing guide surfaces which support the table. There are two reasons for this arrangement.

- The size and weight of the machine prevent the table from being supported by rolling or friction guides.
- As very accurate motion is required, it is necessary to eliminate the effects of the starting torque resulting from the rolling or friction.

This type of guide is used only for special machines.

For large machines that require a static pressure guide, it is not possible to regard the table as a rigid object. It is better to regard the table as partially floating rather than uniformly floating.

In addition, it would be difficult to maintain a given stopping position if there is no friction.

Therefore, adequate friction is necessary even when very highly accurate motion is required.

(5) Differences in Motion Resulting from the Friction Characteristics

Examples of desirable and undesirable friction characteristics are shown below in terms of stability when the table is stopped, accuracy when slowing down and stopping the table, and feeding the table in increments.

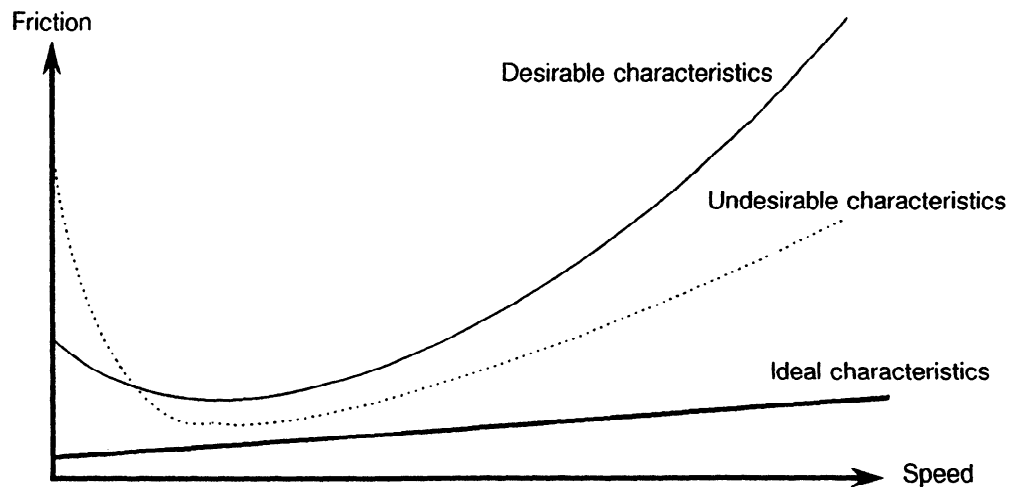

The undesirable characteristics are given first. The friction substantially drops after start up, making it difficult to feed the table by one pulse. Similarly, since the table stops at relatively low kinetic friction, the holding current for the motor (the current when the table is stopped) is also low.

2. SERVO FUNCTIONS

Since its static friction is substantially higher than the kinetic friction, it takes some time for the motor to reach a torque which overcomes the static friction for driving the table. This means there is a delay in response. In addition, the holding current may deviate depending on the case, which results in unstable positioning accuracy.

The desirable characteristics are as follows. The difference between the static friction and the kinetic friction is small, and there may be a relatively big current remaining when the table is stopped. However, the current level should be constant each time the table stops and the time required for the next start-up is also stabilized.

The ideal friction characteristics are where the friction is constant when the table is stopped, where the friction is not reduced after starting up, and where the friction does not increase at higher speeds. Of course, these characteristics cannot occur at the same time.

2.14 Machine Elements Used in Machine Tool

Machine tools use many components such as gears, belts, couplings, ball screws and bearings, and also many mechanisms, such as counterbalances and hydraulic cylinders.

This appendix describes the influence of such components and mechanisms on the servo system, referring to problems experienced in the past.

Like Section 2.13, the following material is described from FANUC's viewpoint, and may not agree with the manufacturer's opinion.

(1) Gears

Gears are used for connection with a feed screw to change the drive ratio or to reduce the margin when using a coupling.

In rare cases, a feed screw cannot be used or an applicable feed screw cannot be produced because the machine is too big. In this case, a rack (a linear gear) and pinion (a small gear) is used to convert rotation to linear movement.

For a rotating shaft that requires larger reduction ratio, a worm is used.

The use of gears depends on each manufacturer's design. The use of gears has the following advantages and disadvantages.

Advantages

- When a screw provides a long lead or does not require a fast feed rate, the use of gears to reduce the drive ratio increases the thrust and enables finer positioning.
- The use of a coupling causes runout with a shaft and/or coupling, and has a bad influence on screws. The use of gears eliminates this problem.

2. SERVO FUNCTIONS

Disadvantages

- All gears have backlash. Therefore, using a pair of gears causes the load (inertia) on the motor to change depending on whether the teeth are in contact.
If the gain is adjusted with the teeth of the gears in contact, and hence the load is applied to the motor, the gears oscillate when the teeth are not in contact and the teeth beat against each other, resulting in large vibration. In particular, if the load is big, an observer must be used.
- However precisely a pair of gears is made, there will be a transfer error, and the rotation of the motor will not exactly coincide with that of the screw.
Some manufacturers whose design connects the motor and screw by gears use a separate detector for the screw whenever applicable.
For users of a machine such as a small lathe, it is very important that the finished surface of workpiece has a good appearance. a separate position detector therefore seems to be necessary for such machines because the finished surface is influenced by uneven feeding of the gears.
- Although properly finished gears cause no problems, poorly finished gears may cause noise and/or vibration whose frequency is a multiple of the number of teeth on the gears.
The frequency of the noise and/or vibration caused by gears is always proportional to the feed rate. Observe the TSA signal carefully and check the relationship to the number of teeth per motor revolution.

Example:	Number of teeth of the gear attached to the motor	20
	Mechanical movement per revolution of the motor	8 mm
	Feed rate	1200 mm/min

$$1200 \text{ (mm/min)} \div 8 \text{ (mm/rev)} \times 20 \text{ (/rev)} \div 60 \text{ (sec/min)} = 50 \text{ (sec}^{-1} = \text{Hz)}$$

Even if noise and/or vibration is caused because of poor finish of the gears, the level may differ depending on the rotational direction. In other words, if the noise and/or vibration changes depending on the direction of movement, it is possible that it results from the gears.

More about backlash:

In general, backlash is regarded as the caused of problems and is suspected to be the cause when a servo does not function well. However, backlash is not always troublesome. It is impossible to eliminate back lash.

(It is impossible to adjust the runout of gears to zero in actual installation. Hence eliminating backlash means that part of one gear is in contact with the other. If the gears are in contact, the load torque will always be uneven, and this will cause problems.)

Backlash of the teeth is relatively small when converted to a rotational angle.

Example:	Gear for motor Module 2; Number of teeth 20; reference circle \varnothing 40 mm
	Mechanical movement per motor revolution 8 mm

$$\pi \times 40 \text{ (mm)} \div 8000 = 15.7 \text{ (}\mu\text{/pulse)}$$

2. SERVO FUNCTIONS

This means that 15- μ backlash on a tooth corresponds only to 1 μ in the direction of movement.

Provided that the pressure angle of a gear is 20 degrees, the 15- μ backlash on a tooth is equivalent to a shaft distance of 43 μ .

That is, even if a gear causes a runout of 43 μ , the backlash resulting from it is only 1 μ .

In other words, if the runout of a gear is adjusted to 45 μ or less in actual installation, it is possible to minimize the backlash to 1 μ or less.

It is understood from the above equation that looser adjustment is allowable if the diameter of the gear is larger. (The smaller the diameter is, the tighter is the required adjustment.)

(2) Timing Belts

The advantages of belts, or the reasons for using them, and their disadvantages are as follows.

Advantages

- A belt enables changing the drive ratio as a gear does.
- A belt provides greater flexibility than gears when setting the shaft distance between a motor and a screw. (It is impossible to mount a screw and a motor in a reverse direction because it is impossible to set the shaft distance as long as the motor width.)
- The shaft distance can be less accurate than that for a gear, as the belt tension can be adjusted.
- Vibration caused by backlash is less frequent than when gears are used.

Disadvantages

- The rotational torque becomes uneven when the tension is tightened to some extent to achieve the required accuracy.
- The problem of noise and/or vibration generated at the teeth is more frequent than with gears.
- Because belts require a certain tension in addition to the transfer torque, the shaft is more likely to be bent or broken.
- Backlash varies depending on the change in tension.
- The rigidity of connection is relatively low when the belt is not tight.

Even when noise and/or vibration is generated, it is not possible to adjust the tension to maintain accuracy. The degree of noise and/or vibration does not always depend on whether a belt is defective.

It seems that the only trouble caused by a belt is delayed and/or uneven response because of insufficient tension.

However, having the belt as tight as possible does not guarantee better operation. Most breakages of the shaft in Model 0/5 AC servo motor are due to excessive belt tension.

The radial load for Model 0/5 is 70kg as stated in the specifications. (A load exceeding 300 kg is necessary to break the shaft in practical applications, but the total load including the transfer torque should be kept as small as possible.)

2. SERVO FUNCTIONS

The radial load for Model 10 or larger models is 450kg as stated in the specifications. This load should not be exceeded in any application.

In both cases, the allowable load is that applied at the tip of the shaft.

When a pulley is located near the motor, the shaft can withstand a bigger load because the moment becomes smaller.

(3) Coupling

The simplest way to connect a motor and a ball screw is directly.

This requires appropriate accuracy in concentricity, parallelism, and rotational runout between the two shafts.

Flexible coupling using leaf springs is available to absorb any variations.

In installing this type of coupling, certain accuracy is still required so that the specified transfer accuracy and rigidity can be achieved.

In actual installation, however, it is probable that the required accuracy cannot be achieved with a coupling even though the machine is operating within the guaranteed runout of the servo motor and within the guaranteed error of the machine itself.

Even if the runout of the motor shaft is as big as one unit, once the shaft is installed on a machine with a coupling, the runout is absorbed as the shaft and the bearing deflect.

As the ball screw rotates, it receives an additional force because of this.

To eliminate this additional force, the coupling is disassembled before mounting and the motor side and the ball screw side are mounted in advance, each using a Spannelemente. By controlling the tightening of each Spannelemente, the runout of the coupling can be controlled to about 1/100 ms. (Some manufacturers have incorporated this procedure in their installation.)

The reader may feel that it is not always necessary to use a flexible coupling because this troublesome mounting is the solution. In practice, some manufacturers use a rigid coupling that has a Spannelemente on each side.

This type of coupling is first mounted on a motor and its runout is controlled by adjusting the Spannelemente. Then, it is mounted on the machine and the Spannelemente on the ball screw side is tightened.

The runout of the coupling is controlled also to be about 1/100 mm, and the remaining runout is absorbed by the deflection of the motor shaft.

Problems caused by a coupling

There seem to be two problems caused by a coupling.

- The table zig-zags because it is deflected as it receives the load of the coupling.
- If a flexible coupling is used to absorb a large runout and the runout exceeds the guaranteed limit for the coupling, the torsional rigidity of the coupling decreases sharply. As the rigidity decreases, that coupling functions as a spring and causes noise and/or vibration.

If there is noise and/or vibration when a square leaf spring is used with a flexible coupling, the noise and/or vibration increases at four particular portions per revolution.

In both cases, the problem is with the machine. Nothing can be done but to ask the machine manufacturers to remount the motor and the screw by shifting the phase and to understand that the problem occurs in the same phase as that of the coupling.

2. SERVO FUNCTIONS

(4) Ball Screws and Bearings

It is very difficult to identify the problems that result from ball screws and bearings.

Bearings are also used in a motor. It seems that noise and/or vibration resulting from a bearing relates to how many balls in the bearing pass over a flaw per motor revolution.

In short, it is necessary to check how far the balls move while the inner ring (rotor) of a bearing completes one revolution.

Bearings used for Model 10 and some other models contain 9 balls. The balls move only 4/10 of a revolution while the inner ring completes one revolution. This movement is equivalent to about 3.5 balls.

Therefore, if there is a flaw on the outer ring, 3.5 balls pass over the flaw per motor revolution.

If there is a flaw on the inner ring, 5.5 balls pass the flaw per motor revolution.

As a result, the noise and/or vibration of a motor, when operating at 2000 rpm, will be as follows.

Outer ring : $2000 \div 60 \times 3.5 = 116.7$ or approximately 117 Hz

Inner ring : $2000 \div 60 \times 5.5 = 183.3$ or approximately 183 Hz

In this way it is possible to identify the cause of noise and/or vibration having either of these frequencies. But the movement of the balls per revolution of the inner ring can be clarified only by checking with the manufacturer.

If it is possible to check the inside of a bearing, it is recommended to turn it manually and measure the movement of the balls.

(5) Counterbalances and Hydraulic Cylinders

Three-axis machining center or slanted lathe has a shaft along the axis of gravity.

A brake prevents the material being processed from lowering while the power is off, and a servo motor holds it during operation. If the material is very heavy in this system, the load on the motor becomes large. Hence, a larger motor or a regenerative discharge unit becomes necessary.

A counterbalance or balancer consisting of a hydraulic cylinder is used to eliminate the need for a larger motor or a regenerative discharge unit. The counter balance and balancer consisting of a hydraulic cylinder has the following advantages and disadvantages.

When a balancer is used to support the weight and the retention force of the balancer is in precise equilibrium with the weight, the positioning may become unstable.

This results from the shift of the center of gravity of the moving object, the shift of the tensile position of the balancer, and the shift in the position of the ball screw and the guide. The shift in these areas causes a moment to be applied to the moving object during movement. The magnitude of the moment varies depending on the direction of movement and the rate of deceleration of stopping (deceleration is constant).

In this case, it may be possible to resolve the problem by putting the balance out of equilibrium.

2. SERVO FUNCTIONS

(a) Counterbalances

Advantages

- Even if the power is off, the moving object will not fall because it is balanced by a weight.

Disadvantages

- The weight increases the inertia applied to the motor, causing the acceleration/ deceleration and controllability of the machine to deteriorate.
- The weight and the supporting wire chain are liable to resonate.

Machine manufacturers generally determine the strength of the chain considering the safety factor for the weight. For servo operation however, the weight functions as a free moving load supported by a wire and the wire functions as a spring supporting the load.

In other words, the safety of the wire chain does not relate so much to its length provided the thickness is constant, but the rigidity is inversely proportional to the length.

If the cutting surface after an abrupt movement or stop is very bad on a unit and if a counterbalance is used on a shaft of the unit, it is necessary to check whether the servo motor is influenced by the counterbalance.

To confirm the influence by the counterbalance, check VCMD immediately after the shaft stops at a short time constant, such as in feed cutting.

If VCMD oscillates at a low frequency, such as about 10 Hz, and its amplitude decreases, it is regarded that the servo motor has been influenced by the counterbalance.

Increase the gain to the maximum value to reduce the swing caused by the counterbalance.

To adjust a machine, it is advisable to tighten the GIB and increase the friction.

(b) Hydraulic cylinders

Advantages

- Hydraulic cylinder generates a force but does not increase the inertia applied to a motor, so neither the acceleration/deceleration nor regenerative performance deteriorates.

Disadvantages

- Because the machine oil moves as the cylinder moves, the oil may cause a pulsation when it passes through a device to regulate the oil pressure or a valve.
This pulsation accelerates the moving object, resulting in noise and/or vibration.
To observe this effect, FANUC requests the manufacturer to turn off the hydraulic pressure line. This check shall be conducted after ensuring that the motor can withstand the weight of the moving object.

2.15 Resonant Frequency of Ball Screws

A machine has its natural resonant frequency, which is independent of the operating conditions, such as feed rate. A component of the frequency sometimes appears in the form of vibration or resonance.

This appendix describes the natural resonant frequency in the case of a ball screw.

(1) Natural resonance of ball screws

The following is regarded as the natural vibration of a ball screw.

- (i) Longitudinal vibration : Vibration caused by the longitudinal expansion and contraction of the ball screw
- (ii) Torsional vibration : Vibration caused by the torsion within a ball screw
- (iii) Transverse vibration : Vibration perpendicular to the shaft of a ball screw

There is another natural torsional vibration caused when loads are attached to both ends of a ball screw.

Regarding items (i), (ii) and (iii) above, Table 1 below lists the basic resonant frequency of a ball screw made of steel, supposing that the length of the screw is L [m] and diameter is d [mm].

Table 2.15 Resonant Frequency of Steel Ball Screw at Each Mode

Type of vibration		Resonant frequency [Hz]
Longitudinal vibration		$f_1 = 2.59 \times 10^3/L$
Torsional vibration		$f_2 = 1.61 \times 10^3/L$
Transverse vibration	Boundary condition of both ends Supported and supported	$f_3 = 2.03 \times d/L^2$
	Fixed and fixed	$f_4 = 4.60 \times d/L^2$
	Supported and fixed	$f_5 = 3.17 \times d/L^2$

(Note 1) “Fixed” and “Supported” for transverse vibration mean the following. When the force at the end a ball screw works is perpendicular to the shaft (more exactly, when a moment is applied to the cross section), the screw is said to be “Fixed”. When such a force is not perpendicular to the shaft, the screw is said to be “supported”. In general, fixed screws are often used on machining centers and supported screws are often used on grinders.

Numerical examples : Suppose that $L = 1$ [m] and $d = 40$ [mm],

$f_1 = 2590$ [Hz]
 $f_2 = 1610$ [Hz]
 $f_3 = 81$ [Hz]
 $f_4 = 184$ [Hz]
 $f_5 = 127$ [Hz]

2. SERVO FUNCTIONS

(2) Resonance including loads attached to both ends of a ball screw

Next, let us examine the case in which two loads (one being a motor) are attached to either end of a ball screw and they resonate due to the torsion of the screw.

Suppose that the loads are J_m and J_l , the angular displacements are θ_m and θ_l , and the torque applied to each is T_m and T_l . This system can be represented in as Fig. 2.15 (a) below.

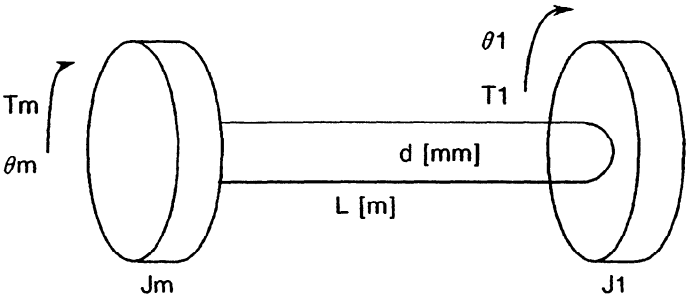

Fig. 2.15 (a)

Also, suppose that the ball screw is elastic and requires a torque of K_m per unit angle of torsion. Then, the above system can be shown in a block diagram as in Fig. 2.15 (b) below.

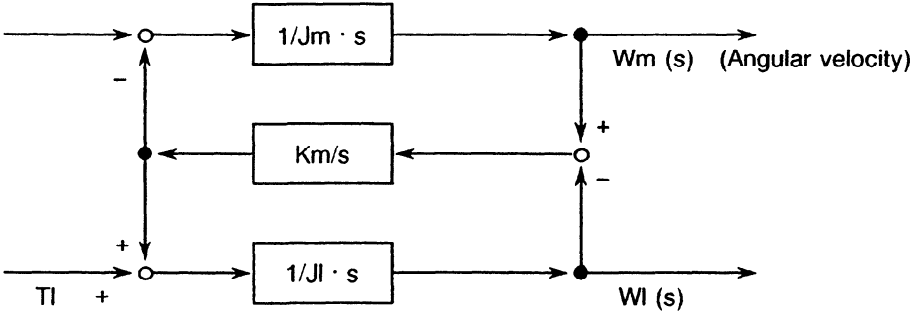

Fig. 2.15 (b) Model for Spring System

In the system shown in Fig. 2.15 (b), the difference $\Delta\theta (s)$ between the angular displacement $\theta_m (s)$ on the motor side and $\theta_l (s)$ on the load side is as follows.

$$\Delta\theta (s) = \frac{T_m/J_m + T_l/J_l}{s^2 + K_m \times (1/J_m + 1/J_l)}$$

The characteristic root of this transfer function is:

$$s = \pm j \sqrt{K_m \times (1/J_m + 1/J_l)}$$

2. SERVO FUNCTIONS

Consequently, the resonant frequency of this system becomes:

$$f = (1/(2 \times \pi)) \times \sqrt{K_m \times (1/J_m + 1/J_l)}$$

Suppose that the length is L [m] and the diameter is d [mm]. K_m for a steel ball screw is given by $K_m = 8.25 \times 10^{-2} \times d^4/L$ [Kgcm].

$$f = 4.57 \times 10^{-2} \times \sqrt{K_m \times (1/J_m + 1/J_l) \times d^4/L} \text{ [Hz]}$$

(Numeric example) If $L = 1$ m, $d = 30$ mm, $J_m = J_l = 0.1$ kgcms², the result is:

$$f = 4.57 \times 10^{-2} \times \sqrt{(1/0.1 + 1/0.1) \times 30^4/1} = 184 \text{ [Hz]}$$

In the above calculation, the following data for steel is used.

Longitudinal modulus of elasticity (Young's modulus) $E = 21500$ [kg/mm²]

Traverse modulus of elasticity $G = 8300$ [kg/mm²]

Specific gravity 7.86

2. SERVO FUNCTIONS

Parameter Table No. 21-a (PARAM110)

ROM VERSION 9040/1C 9031/1F

PARAM110	Symbol	Motor model Drawing No. of motor Motor type	#1	6S	5-0	4-0	3-0	2-0	1-0	0	5	10	20/1500	20	30	30/2000	FS15	Power Mate C	
																		FS0	Power Mate C
1852	INTST		0044	0044	0044	0044	0044	0044	0044	0044	0044	0044	0044	0044	0044	0044			
1853	PA1	8a40	469	750	241	460	669	322	469	828	1720	944	808	370	1452	705			
1854	PA2	8a41	-1625	-2000	-527	-1461	-2126	-1103	-1625	-2782	-2781	-5532	-3074	-3882	-5576	-2716			
1855	PA3	8a42	-2596	-2596	-1873	-2373	-2374	-2488	-2503	-2457	-3052	-2622	-2646	-2665	-2665	-2665			
1856	PA4	8a43	388	388	80	104	96	267	217	226	359	654	824	535	505	674			
1857	PA5	8a44	-1082	-1932	-300	-517	-477	-1330	-1082	-1127	-1789	-3259	-4103	-2666	-2516	-3356			
1858	PA6	8a45	1045	0	0	0	0	0	0	0	0	0	0	0	0	0			
1859	PA7	8a46	-16471	-16471	-16471	-16471	-16471	-16471	-16471	-16471	-16471	-16471	-16471	-16471	-16471	-16471			
1860	PA8	8a47	7012	3929	0	14668	18697	5709	7012	6732	4243	2329	1850	2847	3017	2261			
1861	BLCMP	8a48	0	0	0	0	0	0	0	0	0	0	0	0	0	0			
1862	RESERV	8a49	0	0	0	0	0	0	0	0	0	0	0	0	0	0			
1863	POK1	8a50	1677	1677	1677	1677	1677	1677	1677	1677	1677	1677	1677	1677	1677	1677			
1864	POK2	8a51	1788	1788	1788	1788	1788	1788	1788	1788	1788	1788	1788	1788	1788	1788			
1865	RESERV	8a52	0	0	0	0	0	0	0	0	0	0	0	0	0	0			
1866	PPMAX	8a53	21	21	21	21	21	21	21	21	21	21	21	21	21	21			
1867	PPDP	8a54	3787	3787	3787	3787	3787	3787	3787	3787	3787	3787	3787	3787	3787	3787			
1868	PVST	8a55	319	319	319	319	319	319	319	319	319	319	319	319	319	319			
1869	EMFCMP	8a56	5000	5000	0	638	1129	636	1287	1218	1648	2103	9549	2731	3270	1961			
1870	PVPA	8a57	2330	3750	2330	2330	2330	2800	2330	2330	2330	2800	2330	2800	2800	2330			
1871	PALPH	8a58	57	64	57	57	57	64	57	57	57	64	43	57	43	57			
1872	PPAS	8a59	0	0	0	0	0	0	0	0	0	0	0	0	0	0			
1873	TOLIM	8a60	7282	7282	7282	7282	7282	7282	7282	7282	7282	7282	7282	7282	7282	7282			
1874	ENLMT	8a61	0	0	0	120	120	120	120	120	120	120	120	120	120	120			
1875	POVCL1	8a62	32485	32485	32514	32543	32576	32507	32519	32712	32645	32321	32155	32386	32303	32254			
1876	POVC2	8a63	3112	3556	3173	2817	2401	3265	3112	706	1539	5685	4771	5807	6421	6421			
1877	BITPA1		0	0	0	0	0	0	0	0	0	0	0	0	0	0			
1878	TGALMLY	8a64	1064	4	4	4	4	4	4	4	4	4	4	4	4	4			
1879	POVCLM1	8a65	9256	10522	9437	8375	7136	9713	9256	2094	4567	16660	22907	14219	17329	19176			
1884	PK2VAUX	8a66	0	0	0	0	0	0	0	0	0	0	0	0	0	0			
1885	FILTER	8a67	0	0	0	0	0	0	0	0	0	0	0	0	0	0			
1886	RESERV		0	0	0	0	0	0	0	0	0	0	0	0	0	0			
1887	RESERV		0	0	0	0	0	0	0	0	0	0	0	0	0	0			
1888	RESERV		0	0	0	0	0	0	0	0	0	0	0	0	0	0			
1889	FALPH	8a68	1068	0	0	0	0	0	0	0	0	0	0	0	0	0			
1890	VFFLT	8a69	1069	0	0	0	0	0	0	0	0	0	0	0	0	0			
1891	ERBLM	8a70	1070	0	0	0	0	0	0	0	0	0	0	0	0	0			
1892	PBLCT	8a71	1071	0	0	0	0	0	0	0	0	0	0	0	0	0			
1893	RESERV	8a72	1072	0	0	0	0	0	0	0	0	0	0	0	0	0			
1894	RESERV	8a73	1073	0	0	0	0	0	0	0	0	0	0	0	0	0			
1895	AALPH	8a74	1074	0	0	0	0	0	0	0	0	0	0	0	0	0			
1896	MODEL	8a75	1075	0	0	0	0	0	0	0	0	0	0	0	0	0			
1897	WAAC	8a76	1076	0	0	0	0	0	0	0	0	0	0	0	0	0			
1898	OSCTPL	8a77	1077	0	0	0	0	0	0	0	0	0	0	0	0	0			
1899	RESERV	8a78	1078	0	0	0	0	0	0	0	0	0	0	0	0	0			
1900	RESERV	8a79	1079	0	0	0	0	0	0	0	0	0	0	0	0	0			
1901	RESERV	8a80	1080	0	0	0	0	0	0	0	0	0	0	0	0	0			
1902	RESERV	8a81	1081	0	0	0	0	0	0	0	0	0	0	0	0	0			
1903	BLENDL	8a82	1082	0	0	0	0	0	0	0	0	0	0	0	0	0			
1904	NOFCTL	8a83	1083	0	0	0	0	0	0	0	0	0	0	0	0	0			
1905	SDMRI	8a84	1084	0	0	0	0	0	0	0	0	0	0	0	0	0			
1906	SDMR2	8a85	1085	0	0	0	0	0	0	0	0	0	0	0	0	0			
1907	RTCURR	8a86	1086	0	0	0	0	0	0	0	0	0	0	0	0	0			
1908	TDPLD	8a87	1087	0	0	0	0	0	0	0	0	0	0	0	0	0			

Parameter Table No. 21-b (PARAM110)

Symbol	Motor model Drawing No. of motor Motor type	0L 0561	5L 0562	6L 0563	7L 0571	10L 0572	7LM 0573	2-OS* 0311	1-OS* 0312	OS* 0313	5S* 0314	10S* 0315	40 0581	4-OS 0532	3-OS 0533	ROM VERSION			
																FS15	Power Mate C	9040/1C	
																		25	28
PARAM110																			
INIST		0044	0044	0044	0044	0044	0044	0044	0044	0044	0044	0044	0044	0044	0044	0044	0044		
PK1	8040	2000	1360	1076	590	700	1006	1648	1170	1500	1500	2591	1511	460	736	0044	0044		
PK2	8041	5635	4000	3846	1600	2000	3359	3088	2289	2400	2781	5540	5829	730	1500	0044	0044		
PK3	8042	2614	2647	2680	2685	2701	2663	2488	2485	2475	3052	2623	2672	2333	2374	0044	0044		
PK1V	8043	31	31	42	215	270	150	134	163	204	272	467	307	104	96	0044	0044		
PK2V	8044	1044	1044	1044	1044	1044	1044	1044	1044	1044	1044	1044	1044	1044	1044	0044	0044		
PK3V	8045	1045	1045	1045	1045	1045	1045	1045	1045	1045	1045	1045	1045	1045	1045	0044	0044		
PK4V	8046	1046	1046	1046	1046	1046	1046	1046	1046	1046	1046	1046	1046	1046	1046	0044	0044		
POA1	1858	8047	8047	8047	8047	8047	8047	8047	8047	8047	8047	8047	8047	8047	8047	0044	0044		
BLCMP	1860	8048	8048	8048	8048	8048	8048	8048	8048	8048	8048	8048	8048	8048	8048	0044	0044		
RESERV	1861	8049	8049	8049	8049	8049	8049	8049	8049	8049	8049	8049	8049	8049	8049	0044	0044		
POK1	1862	8050	8050	8050	8050	8050	8050	8050	8050	8050	8050	8050	8050	8050	8050	0044	0044		
POK2	1863	8051	8051	8051	8051	8051	8051	8051	8051	8051	8051	8051	8051	8051	8051	0044	0044		
RESERV	1864	8052	8052	8052	8052	8052	8052	8052	8052	8052	8052	8052	8052	8052	8052	0044	0044		
PPMAX	1865	8053	8053	8053	8053	8053	8053	8053	8053	8053	8053	8053	8053	8053	8053	0044	0044		
PDDP	1866	8054	8054	8054	8054	8054	8054	8054	8054	8054	8054	8054	8054	8054	8054	0044	0044		
PHYST	1867	8055	8055	8055	8055	8055	8055	8055	8055	8055	8055	8055	8055	8055	8055	0044	0044		
ENFCMP	1868	8056	8056	8056	8056	8056	8056	8056	8056	8056	8056	8056	8056	8056	8056	0044	0044		
PVPA	1869	8057	8057	8057	8057	8057	8057	8057	8057	8057	8057	8057	8057	8057	8057	0044	0044		
PALPH	1870	8058	8058	8058	8058	8058	8058	8058	8058	8058	8058	8058	8058	8058	8058	0044	0044		
PPBAS	1871	8059	8059	8059	8059	8059	8059	8059	8059	8059	8059	8059	8059	8059	8059	0044	0044		
TQLIM	1872	8060	8060	8060	8060	8060	8060	8060	8060	8060	8060	8060	8060	8060	8060	0044	0044		
ENFLMT	1873	8061	8061	8061	8061	8061	8061	8061	8061	8061	8061	8061	8061	8061	8061	0044	0044		
POVC1	1877	8062	8062	8062	8062	8062	8062	8062	8062	8062	8062	8062	8062	8062	8062	0044	0044		
POVC2	1878	8063	8063	8063	8063	8063	8063	8063	8063	8063	8063	8063	8063	8063	8063	0044	0044		
BITPAL	1892	8064	8064	8064	8064	8064	8064	8064	8064	8064	8064	8064	8064	8064	8064	0044	0044		
TGALMLV	1893	8065	8065	8065	8065	8065	8065	8065	8065	8065	8065	8065	8065	8065	8065	0044	0044		
POVCLMT	1894	8066	8066	8066	8066	8066	8066	8066	8066	8066	8066	8066	8066	8066	8066	0044	0044		
PK2VAUX	1895	8067	8067	8067	8067	8067	8067	8067	8067	8067	8067	8067	8067	8067	8067	0044	0044		
FILTER																			
RESERV																			
RESERV																			
RESERV																			
FALPH	8068	1068	1068	1068	1068	1068	1068	1068	1068	1068	1068	1068	1068	1068	1068	0044	0044		
VFFLT	1961	8069	8069	8069	8069	8069	8069	8069	8069	8069	8069	8069	8069	8069	8069	0044	0044		
FRBLM	1962	8070	8070	8070	8070	8070	8070	8070	8070	8070	8070	8070	8070	8070	8070	0044	0044		
BLCT	1963	8071	8071	8071	8071	8071	8071	8071	8071	8071	8071	8071	8071	8071	8071	0044	0044		
RESERV	1964	8072	8072	8072	8072	8072	8072	8072	8072	8072	8072	8072	8072	8072	8072	0044	0044		
RESERV	1965	8073	8073	8073	8073	8073	8073	8073	8073	8073	8073	8073	8073	8073	8073	0044	0044		
RESERV	1966	8074	8074	8074	8074	8074	8074	8074	8074	8074	8074	8074	8074	8074	8074	0044	0044		
ALPH	1967	8075	8075	8075	8075	8075	8075	8075	8075	8075	8075	8075	8075	8075	8075	0044	0044		
MODEL	1968	8076	8076	8076	8076	8076	8076	8076	8076	8076	8076	8076	8076	8076	8076	0044	0044		
WAC	1969	8077	8077	8077	8077	8077	8077	8077	8077	8077	8077	8077	8077	8077	8077	0044	0044		
OSCTPL	1970	8078	8078	8078	8078	8078	8078	8078	8078	8078	8078	8078	8078	8078	8078	0044	0044		
RESERV	1971	8079	8079	8079	8079	8079	8079	8079	8079	8079	8079	8079	8079	8079	8079	0044	0044		
RESERV	1972	8080	8080	8080	8080	8080	8080	8080	8080	8080	8080	8080	8080	8080	8080	0044	0044		
RESERV	1973	8081	8081	8081	8081	8081	8081	8081	8081	8081	8081	8081	8081	8081	8081	0044	0044		
RESERV	1974	8082	8082	8082	8082	8082	8082	8082	8082	8082	8082	8082	8082	8082	8082	0044	0044		
BLENDL	1975	8083	8083	8083	8083	8083	8083	8083	8083	8083	8083	8083	8083	8083	8083	0044	0044		
WOFCTL	1976	8084	8084	8084	8084	8084	8084	8084	8084	8084	8084	8084	8084	8084	8084	0044	0044		
SDMR1	1977	8085	8085	8085	8085	8085	8085	8085	8085	8085	8085	8085	8085	8085	8085	0044	0044		
SDMR2	1978	8086	8086	8086	8086	8086	8086	8086	8086	8086	8086	8086	8086	8086	8086	0044	0044		
RTCURR	1979	8087	8087	8087	8087	8087	8087	8087	8087	8087	8087	8087	8087	8087	8087	0044	0044		
TDPDLD	1980	8088	8088	8088	8088	8088	8088	8088	8088	8088	8088	8088	8088	8088	8088	0044	0044		

2. SERVO FUNCTIONS

Parameter Table No. 21-c (PARAM110)

Symbol PARAM110	Motor model Drawing No. of motor Motor type	Power Mate C											70S 0333 41			
		FS15	2-OS 0311 29	1-OS 0312 30	OS 0313 31	5S 0314 32	10S 0315 33	20S/1500 0505 34	20S 0502 35	30S 0590 36	2-OS 0310 37	6L 0564 38		50S 0331 39	60S 0332 40	ROM VERSION 9040/1C
		FS0	0044	0044	0044	0044	0044	0044	0044	0044	0044	0044		0044	0044	0846
INTST																
PK1	8040	1040	1648	1170	1500	1800	2591	3414	4224	5044	5860	6682	7504	8326	9148	9970
PK2	8041	1041	-3088	-2289	-1490	-791	908	1707	2526	3345	4164	4983	5802	6621	7440	8259
PK3	8042	1042	-2488	-2488	-2475	-2462	-2449	-2436	-2423	-2410	-2397	-2384	-2371	-2358	-2345	-2332
PK1V	8043	1043	194	163	132	101	70	40	10	-20	-50	-80	-110	-140	-170	-200
PK2V	8044	1044	-665	-812	-1015	-1218	-1421	-1624	-1827	-2030	-2233	-2436	-2639	-2842	-3045	-3248
PK3V	8045	1045	0	0	0	0	0	0	0	0	0	0	0	0	0	0
PK4V	8046	1046	-1647	-1647	-1647	-1647	-1647	-1647	-1647	-1647	-1647	-1647	-1647	-1647	-1647	-1647
POA1	8047	1047	11417	9349	7481	5602	3723	1844	0	0	0	0	0	0	0	0
BLCMP	8048	1048	0	0	0	0	0	0	0	0	0	0	0	0	0	0
RESERV	8049	1049	0	0	0	0	0	0	0	0	0	0	0	0	0	0
POK1	8050	1050	1677	1677	1677	1677	1677	1677	1677	1677	1677	1677	1677	1677	1677	1677
POK2	8051	1051	1788	1788	1788	1788	1788	1788	1788	1788	1788	1788	1788	1788	1788	1788
RESERV	8052	1052	0	0	0	0	0	0	0	0	0	0	0	0	0	0
PPMAX	8053	1053	21	21	21	21	21	21	21	21	21	21	21	21	21	21
PDPP	8054	1054	3787	3787	3787	3787	3787	3787	3787	3787	3787	3787	3787	3787	3787	3787
PHYST	8055	1055	319	319	319	319	319	319	319	319	319	319	319	319	319	319
EMFCMP	8056	1056	1589	2147	2705	3263	3821	4379	4937	5495	6053	6611	7169	7727	8285	8843
PVPA	8057	1057	2330	1864	1398	932	466	0	0	0	0	0	0	0	0	0
PALPH	8058	1058	57	46	35	24	13	2	0	0	0	0	0	0	0	0
PPBAS	8059	1059	0	0	0	0	0	0	0	0	0	0	0	0	0	0
QLIM	8060	1060	4855	7282	9709	12136	14573	17010	19447	21884	24321	26758	29195	31632	34069	36506
ENFLMT	1873	1061	120	120	120	120	120	120	120	120	120	120	120	120	120	120
POV1C	1877	1062	32704	32627	32550	32473	32396	32319	32242	32165	32088	32011	31934	31857	31780	31703
POV2C	1878	1063	806	1766	2626	3486	4346	5206	6066	6926	7786	8646	9506	10366	11226	12086
BITPAL			0	0	0	0	0	0	0	0	0	0	0	0	0	0
TGALMLV	8064	1064	4	4	4	4	4	4	4	4	4	4	4	4	4	4
POVCLMT	1899	1065	2390	5245	9100	12955	16810	20665	24520	28375	32230	36085	39940	43795	47650	51505
PK2VAD	1894	1066	0	0	0	0	0	0	0	0	0	0	0	0	0	0
FILTER	1895	1067	0	0	0	0	0	0	0	0	0	0	0	0	0	0
RESERV			0	0	0	0	0	0	0	0	0	0	0	0	0	0
RESERV			0	0	0	0	0	0	0	0	0	0	0	0	0	0
RESERV			0	0	0	0	0	0	0	0	0	0	0	0	0	0
FALPH	8068	1068	0	0	0	0	0	0	0	0	0	0	0	0	0	0
VFFLT	1962	1069	0	0	0	0	0	0	0	0	0	0	0	0	0	0
FRLM	1963	1070	0	0	0	0	0	0	0	0	0	0	0	0	0	0
PBLCT	1964	1071	0	0	0	0	0	0	0	0	0	0	0	0	0	0
RESERV	1965	1072	0	0	0	0	0	0	0	0	0	0	0	0	0	0
RESERV	1966	1073	0	0	0	0	0	0	0	0	0	0	0	0	0	0
RESERV	1967	1074	0	0	0	0	0	0	0	0	0	0	0	0	0	0
AALPH	1968	1075	0	0	0	0	0	0	0	0	0	0	0	0	0	0
MODEL	1969	1076	0	0	0	0	0	0	0	0	0	0	0	0	0	0
WRAC	1970	1077	0	0	0	0	0	0	0	0	0	0	0	0	0	0
OSCTPL	1971	1078	0	0	0	0	0	0	0	0	0	0	0	0	0	0
RESERV	1972	1079	0	0	0	0	0	0	0	0	0	0	0	0	0	0
RESERV	1973	1080	0	0	0	0	0	0	0	0	0	0	0	0	0	0
RESERV	1974	1081	0	0	0	0	0	0	0	0	0	0	0	0	0	0
RESERV	1975	1082	0	0	0	0	0	0	0	0	0	0	0	0	0	0
RLNDL	1976	1083	0	0	0	0	0	0	0	0	0	0	0	0	0	0
MOFCTL	1977	1084	0	0	0	0	0	0	0	0	0	0	0	0	0	0
SDMR1	1978	1085	0	0	0	0	0	0	0	0	0	0	0	0	0	0
SDMR2	1979	1086	1137	1685	2233	2781	3329	3877	4425	4973	5521	6069	6617	7165	7713	8261
RTCURR	1980	1087	0	0	0	0	0	0	0	0	0	0	0	0	0	0
TDPLD			0	0	0	0	0	0	0	0	0	0	0	0	0	0

2. SERVO FUNCTIONS

Parameter Table No. 21-d (PARAM110)

Symbol	Motor model Drawing No. of motor Motor type	Power Mate C													30S/2000		ROM VERSION 9040/1C		
		Parameter No.																	
		FS15	FS0	4-0S	3-0S	2-0S	1-0S	0S	5S	6S	10S	20S/1500	20S	30S	30S/2000	40			
INTST																			
PK1	8d40	0046	0046	0046	0046	0046	0046	0046	0046	0046	0046	0046	0046	0046	0046	0046	0046	0046	0046
PK2	8d41	241	460	241	736	390	1170	1500	1500	750	2591	1311	3414	3414	705	1511	1511	1511	1511
PK3	8d42	-730	-1500	-730	-1500	-810	-2289	-2400	-2400	-2000	-5540	-2477	-7650	-7650	-2716	-5829	-5829	-5829	-5829
PK4	8d43	-1873	-2373	-1873	-2374	-2480	-2485	-2475	-3052	-2596	-2623	-2649	-2663	-2663	-2669	-2672	-2672	-2672	-2672
PK5	8d43	45	38	45	53	111	91	113	151	216	260	458	201	375	282	282	282	282	282
PK6	8d44	-300	-517	-300	-477	-991	-812	-1013	-1355	-1932	-2328	-4103	-1797	-3356	-2326	-2326	-2326	-2326	-2326
PK7	8d45	0	0	0	0	0	0	0	0	0	0	0	0	0	0	0	0	0	0
PK8	8d46	-8235	-8235	-8235	-8235	-8235	-8235	-8235	-8235	-8235	-8235	-8235	-8235	-8235	-8235	-8235	-8235	-8235	-8235
PK9	8d47	7334	7334	7334	7948	3806	4674	3740	2801	1964	1630	925	2112	1131	1502	1502	1502	1502	1502
PK10	8d48	0	0	0	0	0	0	0	0	0	0	0	0	0	0	0	0	0	0
PK11	8d49	0	0	0	0	0	0	0	0	0	0	0	0	0	0	0	0	0	0
PK12	8d50	956	956	956	956	956	956	956	956	956	956	956	956	956	956	956	956	956	956
PK13	8d51	510	510	510	510	510	510	510	510	510	510	510	510	510	510	510	510	510	510
PK14	8d52	0	0	0	0	0	0	0	0	0	0	0	0	0	0	0	0	0	0
PK15	8d53	21	21	21	21	21	21	21	21	21	21	21	21	21	21	21	21	21	21
PK16	8d54	3787	3787	3787	3787	3787	3787	3787	3787	3787	3787	3787	3787	3787	3787	3787	3787	3787	3787
PK17	8d55	319	319	319	319	319	319	319	319	319	319	319	319	319	319	319	319	319	319
PK18	8d56	629	629	629	1129	1589	2147	1350	2403	5000	5520	3549	5456	1961	3478	3478	3478	3478	3478
PK19	8d57	2330	2330	2330	2330	2330	1864	2330	2330	3150	3500	2197	7200	2330	2800	2800	2800	2800	2800
PK20	8d58	57	46	57	57	57	46	57	57	64	64	52	50	57	43	43	43	43	43
PK21	8d59	0	0	0	0	0	0	0	0	0	0	0	0	0	0	0	0	0	0
PK22	8d60	7282	7282	7282	7282	7282	7282	7282	7282	7282	7282	7282	7282	7282	7282	7282	7282	7282	7282
PK23	8d61	120	120	120	120	120	120	120	120	120	120	120	120	120	120	120	120	120	120
PK24	8d62	32514	32543	32514	32576	32623	32672	32722	32677	32485	32539	32155	32386	32530	32254	32340	32340	32340	32340
PK25	8d63	2817	2817	2817	2401	1811	1766	578	1142	3536	2364	7859	2971	6421	5355	5355	5355	5355	5355
PK26	8d64	0	0	0	0	0	0	0	0	0	0	0	0	0	0	0	0	0	0
PK27	8d65	9437	8375	9437	7136	5377	5245	1715	3388	10522	8515	22907	8834	19176	15972	15972	15972	15972	15972
PK28	8d66	0	0	0	0	0	0	0	0	0	0	0	0	0	0	0	0	0	0
PK29	8d67	0	0	0	0	0	0	0	0	0	0	0	0	0	0	0	0	0	0
PK30	8d68	0	0	0	0	0	0	0	0	0	0	0	0	0	0	0	0	0	0
PK31	8d69	0	0	0	0	0	0	0	0	0	0	0	0	0	0	0	0	0	0
PK32	8d70	0	0	0	0	0	0	0	0	0	0	0	0	0	0	0	0	0	0
PK33	8d71	0	0	0	0	0	0	0	0	0	0	0	0	0	0	0	0	0	0
PK34	8d72	0	0	0	0	0	0	0	0	0	0	0	0	0	0	0	0	0	0
PK35	8d73	0	0	0	0	0	0	0	0	0	0	0	0	0	0	0	0	0	0
PK36	8d74	0	0	0	0	0	0	0	0	0	0	0	0	0	0	0	0	0	0
PK37	8d75	0	0	0	0	0	0	0	0	0	0	0	0	0	0	0	0	0	0
PK38	8d76	0	0	0	0	0	0	0	0	0	0	0	0	0	0	0	0	0	0
PK39	8d77	0	0	0	0	0	0	0	0	0	0	0	0	0	0	0	0	0	0
PK40	8d78	0	0	0	0	0	0	0	0	0	0	0	0	0	0	0	0	0	0
PK41	8d79	0	0	0	0	0	0	0	0	0	0	0	0	0	0	0	0	0	0
PK42	8d80	0	0	0	0	0	0	0	0	0	0	0	0	0	0	0	0	0	0
PK43	8d81	0	0	0	0	0	0	0	0	0	0	0	0	0	0	0	0	0	0
PK44	8d82	0	0	0	0	0	0	0	0	0	0	0	0	0	0	0	0	0	0
PK45	8d83	0	0	0	0	0	0	0	0	0	0	0	0	0	0	0	0	0	0
PK46	8d84	0	0	0	0	0	0	0	0	0	0	0	0	0	0	0	0	0	0
PK47	8d85	0	0	0	0	0	0	0	0	0	0	0	0	0	0	0	0	0	0
PK48	8d86	2261	2129	2261	1966	1706	1685	1084	1354	1966	1768	3801	1801	2654	2941	2941	2941	2941	2941
PK49	8d87	0	0	0	0	0	0	0	0	0	0	0	0	0	0	0	0	0	0

Parameter Table No. 21-f (PARAM110)

ROM VERSION
9040/1C

PARAM110	Symbol	Motor model Drawing No. of motor Motor type Parameter No.	6L(H) 0564 70	7L(H) 0571 71	10L(H) 0572 72	6S(H) 73
	FS15	Power Mate C	0846			
1852	INTST	8040	880	0846	0846	0846
1853	PK1	1040	850	890	700	1000
1854	PK2	1041	-2300	-1600	-2000	-2400
1855	PK3	1042	-2652	-2685	-2701	-2459
1856	PK4	1043	34	119	150	135
1857	PK5	1044	-309	-1070	-1346	-1205
1858	PK6	1045	0	0	0	0
1859	PK7	1046	-8235	-8235	-8235	-8235
1860	PK8	1047	12292	3547	2820	3148
1861	BLCMP	1048	0	0	0	0
1862	RESERV	1049	0	0	0	0
1863	POK1	1050	956	956	956	956
1864	POK2	1051	510	510	510	510
1865	RESERV	1052	0	0	0	0
1866	PPMAX	1053	21	21	21	21
1867	PPDDP	1054	3787	3787	3787	3787
1868	PHYST	1055	319	319	319	319
1869	EMFCMP	1056	1240	3200	4800	3200
1870	PVPA	1057	2330	3200	3200	2300
1871	PALPH	1058	57	64	64	64
1872	PPBAS	1059	0	0	0	5
1873	TQLIM	1060	6918	7282	7282	6918
1874	ENFLMT	1061	120	120	120	120
1875	POVCI	1062	32614	32299	31875	32693
1876	POVC2	1063	1928	5857	11158	940
1892	BITPAL	1064	68	68	68	68
1893	TGALMLV	1065	4	4	4	4
1894	POVCLMT	1066	5727	17509	32767	2787
1895	PK2VAUX	1067	0	0	0	0
	FILTER	1067	0	0	0	0
	RESERV	1067	0	0	0	0
	RESERV	1068	0	0	0	0
	FALPH	1068	0	0	0	0
	VFLT	1069	0	0	0	0
	ERBLM	1070	0	0	0	0
	PRLCT	1071	0	0	0	0
	RESERV	1072	0	0	0	0
	RESERV	1073	0	0	0	0
	AALPH	1074	4000	4000	4000	3200
	MODEL	1075	0	0	0	0
	WKAC	1076	0	0	0	0
	OSCTPL	1077	0	0	0	0
	RESERV	1078	0	0	0	0
	RESERV	1079	0	0	0	0
	RESERV	1080	0	0	0	0
	RESERV	1081	0	0	0	0
	BLENDL	1082	0	0	0	0
	MOFCTL	1083	0	0	0	0
	SDMR1	1084	0	0	0	0
	SDMR2	1085	0	0	0	0
	RTCURR	1086	1761	3079	4261	1228
	TDPLD	1087	0	0	0	0
	RESERV	1087	0	0	0	0
	RESERV	1088	0	0	0	0
	RESERV	1089	0	0	0	0
	RESERV	1090	0	0	0	0

FROM VERSION
9040/1C

Parameter Table No. 21-g (PARAM110)

PARAM110	Symbol	Motor model	6L	5L	6L	5L	40S(II)	0T(H)	5T	5T(II)	10T	10T(H)
		Drawing No. of motor	0564	0562	0564	0562	0583	0381	0382	0383	0384	0385
		Motor type	74	75	76	77	78	79	80	81	82	83
		Parameter No.										
		FS15	Power Mate C									
1852	INTST	8040	0846	0843	0843	0846	0846	0846	0046	0846	0046	0846
1853	PK1	1040	1051	1612	1527	3646	811	701	670	456	600	409
1854	PK2	1041	-2661	-4176	-4473	-12081	-3385	-2038	-1600	-1153	-1153	-946
1855	PK3	1042	-2652	-2647	-2691	-2689	-2666	-2390	-2473	-2498	-2550	-2543
1856	PK1V	1043	17	15	25	15	280	260	287	209	450	349
1857	PK2V	1044	-1081	-602	-1852	-1172	-2511	-2329	-2568	-1877	-4034	-3124
1858	PK3V	1045	0	0	0	0	0	0	0	0	0	0
1859	PK4V	1046	-7206	-7206	-6177	-6177	-8235	-8235	-8235	-8235	-8235	-8235
1860	POA1	1047	768	1518	384	759	1512	1630	1478	2022	941	1215
1861	BLCMP	1048	0	0	0	0	0	0	0	0	0	0
1862	RESERV	1049	0	0	0	0	0	0	0	0	0	0
1863	POK1	1050	956	956	511	511	956	956	956	956	956	956
1864	POK2	1051	510	510	136	136	510	510	510	510	510	510
1865	RESERV	1052	0	0	0	0	0	0	0	0	0	0
1866	PPMAX	1053	21	21	21	21	21	21	21	21	21	21
1867	PDDP	1054	9750	4875	4875	4875	3787	3787	3787	3787	3787	3787
1868	PHYST	1055	319	319	319	319	319	319	319	319	319	319
1869	EMFCMP	1056	1240	1097	1240	1097	4800	4008	4400	3684	4590	4008
1870	PPA	1057	2330	2330	2330	2330	3200	4200	4000	3000	3355	2330
1871	PALPH	1058	57	57	57	57	60	43	64	64	57	57
1872	PPRAS	1059	0	0	0	0	5	5	0	5	0	5
1873	TOLIM	1060	6918	6918	6918	6918	7282	7282	7282	7282	7282	7282
1874	ENFLMT	1061	120	120	120	120	120	120	120	120	120	120
1875	POVCL	1062	32614	32698	32614	32698	32345	32703	32669	32714	32532	32623
1876	POVC2	1063	1925	877	1925	877	5290	819	1235	674	2948	1788
1877	BITPA1	1064	4608	4608	4608	4608	68	68	0	68	0	68
1878	TGALMLV	1065	4	4	4	4	4	4	4	4	4	4
1879	POVCLMT	1066	5716	2602	5716	2602	15775	2428	3665	1998	8766	5308
1880	PK2VAUX	1067	0	0	0	0	0	0	0	0	0	0
1881	FILTER	1067	0	0	0	0	0	0	0	0	0	0
1882	BITPA2	1067	256	256	-32512	-32512	0	0	0	0	0	0
1883	BITPA3	1068	0	0	0	0	0	0	0	0	0	0
1884	BITPA4	1069	2048	1720	2900	2900	0	0	0	0	0	0
1885	FALPH	1068	0	0	0	0	0	0	0	0	0	0
1886	VFLLT	1069	0	0	0	0	0	0	0	0	0	0
1887	ERBLM	1070	0	0	0	0	0	0	0	0	0	0
1888	PBLCT	1071	0	0	0	0	0	0	0	0	0	0
1889	RESERV	1072	0	0	0	0	0	0	0	0	0	0
1890	RESERV	1073	0	0	0	0	0	0	0	0	0	0
1891	AALPH	1074	0	0	0	0	0	0	0	0	0	0
1892	MODEL	1075	0	0	0	0	0	0	0	0	0	0
1893	WFAC	1076	0	0	0	0	0	0	0	0	0	0
1894	OSCTPL	1077	0	0	0	0	0	0	0	0	0	0
1895	RESERV	1078	16384	16384	16384	16384	0	0	0	0	0	0
1896	RESERV	1079	0	0	0	0	0	0	0	0	0	0
1897	RESERV	1080	0	0	0	0	0	0	0	0	0	0
1898	RESERV	1081	0	0	0	0	0	0	0	0	0	0
1899	BLENDL	1082	0	0	0	0	0	0	0	0	0	0
1900	NOFCTL	1083	0	0	0	0	0	0	0	0	0	0
1901	SDMR1	1084	0	0	0	0	0	0	0	0	0	0
1902	SDMR2	1085	0	0	0	0	0	0	0	0	0	0
1903	RTCURR	1086	1760	1187	1760	1187	2923	1147	1409	1040	2179	1696
1904	TDPLD	1087	0	0	0	0	0	0	0	0	0	0

2. SERVO FUNCTIONS

Parameter Table No. 22-a (PARAM112)

PARAM112	Symbol	Motor model Drawing No. of motor	Motor type	FS15	Power Mate C										ROM VERSION			
					#1	2	3	4	5	6	7	8	9	10	20/1500	20	30	30/2000
					6S	5-0	4-0	3-0	2-0	1-0	0	5	10	20/1500	20	30	30/2000	
						0531	0532	0533	0521	0522	0513	0512	0501	0505	0502	0503	0506	
1852	INTST	8040	1040	0044	0044	0044	0044	0044	0044	0044	0044	0044	0044	0044	0044	0044	0044	9030/10
1853	PK1	8041	1041	469	750	457	460	669	322	469	878	1720	944	808	870	1452	705	9031/1H
1854	PK2	8042	1042	-999	-2000	-1625	-1461	-2126	-1103	-1625	-2782	-2781	-3532	-3074	-3682	-5576	-2716	
1855	PK3	8043	1043	-2596	-2596	-1873	-2374	-2374	-2488	-2503	-2457	-3052	-2622	-2649	-2669	-2669	-2669	
1856	PK4	8044	1044	388	388	53	104	96	267	217	226	359	654	824	505	674	674	
1857	PK5	8045	1045	-1082	-1932	-300	-517	-477	-1330	-1082	-1127	-1789	-3259	-4103	-2666	-2516	-3356	
1858	PK6	8046	1046	0	0	0	0	0	0	0	0	0	0	0	0	0	0	
1859	PK7	8047	1047	-16471	-16471	-16471	-16471	-16471	-16471	-16471	-16471	-16471	-16471	-16471	-16471	-16471	-16471	
1860	PK8	8048	1048	3929	3929	0	14668	15897	5709	7012	6732	4243	2329	1850	2847	3017	2261	
1861	PK9	8049	1049	0	0	0	0	0	0	0	0	0	0	0	0	0	0	
1862	PK10	8050	1050	0	0	0	0	0	0	0	0	0	0	0	0	0	0	
1863	PK11	8051	1051	1677	1677	1677	1677	1677	1677	1677	1677	1677	1677	1677	1677	1677	1677	
1864	RESERV	8052	1052	1788	1788	1788	1788	1788	1788	1788	1788	1788	1788	1788	1788	1788	1788	
1865	PK12	8053	1053	0	0	0	0	0	0	0	0	0	0	0	0	0	0	
1866	PK13	8054	1054	21	21	21	21	21	21	21	21	21	21	21	21	21	21	
1867	PK14	8055	1055	3787	3787	3787	3787	3787	3787	3787	3787	3787	3787	3787	3787	3787	3787	
1868	PK15	8056	1056	319	319	319	319	319	319	319	319	319	319	319	319	319	319	
1869	PK16	8057	1057	5000	5000	0	629	1129	636	1287	1218	1648	2103	3549	2731	3270	1961	
1870	PK17	8058	1058	3750	3750	2330	2330	2330	2800	2330	2330	2330	2800	2800	2800	2800	2330	
1871	PK18	8059	1059	64	64	57	57	57	64	57	57	57	64	43	57	43	57	
1872	PK19	8060	1060	7282	7282	7282	7282	7282	7282	7282	7282	7282	7282	7282	7282	7282	7282	
1873	PK20	8061	1061	0	0	0	0	0	0	0	0	0	0	0	0	0	0	
1877	PK21	8062	1062	32485	32485	32514	32543	32576	32507	32519	32712	32645	32321	32155	32386	32303	32254	
1878	PK22	8063	1063	3112	3536	3173	2817	2401	3265	3112	706	1539	5855	7659	4771	5807	6421	
1892	PK23	8064	1064	0	0	0	0	0	0	0	0	0	0	0	0	0	0	
1893	PK24	8065	1065	4	4	4	4	4	4	4	4	4	4	4	4	4	4	
1894	PK25	8066	1066	9256	10522	9437	8375	7136	9713	9256	2094	4567	16660	22907	14219	17329	19176	
1895	PK26	8067	1067	0	0	0	0	0	0	0	0	0	0	0	0	0	0	
1961	RESERV	8068	1068	0	0	0	0	0	0	0	0	0	0	0	0	0	0	
1962	RESERV	8069	1069	0	0	0	0	0	0	0	0	0	0	0	0	0	0	
1963	RESERV	8070	1070	0	0	0	0	0	0	0	0	0	0	0	0	0	0	
1964	RESERV	8071	1071	0	0	0	0	0	0	0	0	0	0	0	0	0	0	
1965	RESERV	8072	1072	0	0	0	0	0	0	0	0	0	0	0	0	0	0	
1966	RESERV	8073	1073	0	0	0	0	0	0	0	0	0	0	0	0	0	0	
1967	RESERV	8074	1074	0	0	0	0	0	0	0	0	0	0	0	0	0	0	
1968	RESERV	8075	1075	0	0	0	0	0	0	0	0	0	0	0	0	0	0	
1969	RESERV	8076	1076	0	0	0	0	0	0	0	0	0	0	0	0	0	0	
1970	RESERV	8077	1077	0	0	0	0	0	0	0	0	0	0	0	0	0	0	
1971	RESERV	8078	1078	0	0	0	0	0	0	0	0	0	0	0	0	0	0	
1972	RESERV	8079	1079	0	0	0	0	0	0	0	0	0	0	0	0	0	0	
1973	RESERV	8080	1080	0	0	0	0	0	0	0	0	0	0	0	0	0	0	
1974	RESERV	8081	1081	0	0	0	0	0	0	0	0	0	0	0	0	0	0	
1975	RESERV	8082	1082	0	0	0	0	0	0	0	0	0	0	0	0	0	0	
1976	RESERV	8083	1083	0	0	0	0	0	0	0	0	0	0	0	0	0	0	
1977	RESERV	8084	1084	0	0	0	0	0	0	0	0	0	0	0	0	0	0	
1978	RESERV	8085	1085	0	0	0	0	0	0	0	0	0	0	0	0	0	0	
1979	RESERV	8086	1086	2239	1966	2261	2129	1966	2239	2239	1064	1572	2474	3801	2285	2523	2654	
1980	RESERV	8087	1087	0	0	0	0	0	0	0	0	0	0	0	0	0	0	

2. SERVO FUNCTIONS

Parameter Table No. 22-b (PARAM112)

PARAM112	Symbol	Motor model Drawing No. of motor Motor type	Power Mate C													3-OS						
			FS15	0L	5L	6L	7L	10L	7LM	2-OS*	1-OS*	OS*	5S*	10S*	40		4-OS					
	INTST			0044	0044	0044	0044	0044	0044	0044	0044	0044	0044	0044	0044	0044	0044	0044	0044			
1852	PK1	8040	1040	0044	0044	0044	0044	0044	0044	0044	0044	0044	0044	0044	0044	0044	0044	0044	0044	0044		
1853	PK2	8041	1041	0044	0044	0044	0044	0044	0044	0044	0044	0044	0044	0044	0044	0044	0044	0044	0044	0044	0044	
1854	PK3	8042	1042	0044	0044	0044	0044	0044	0044	0044	0044	0044	0044	0044	0044	0044	0044	0044	0044	0044	0044	
1855	PK1V	8043	1043	0044	0044	0044	0044	0044	0044	0044	0044	0044	0044	0044	0044	0044	0044	0044	0044	0044	0044	
1856	PK2V	8044	1044	0044	0044	0044	0044	0044	0044	0044	0044	0044	0044	0044	0044	0044	0044	0044	0044	0044	0044	
1857	PK3V	8045	1045	0044	0044	0044	0044	0044	0044	0044	0044	0044	0044	0044	0044	0044	0044	0044	0044	0044	0044	
1858	PK4V	8046	1046	0044	0044	0044	0044	0044	0044	0044	0044	0044	0044	0044	0044	0044	0044	0044	0044	0044	0044	
1859	POA1	8047	1047	0044	0044	0044	0044	0044	0044	0044	0044	0044	0044	0044	0044	0044	0044	0044	0044	0044	0044	
1860	BLCHP	8048	1048	0044	0044	0044	0044	0044	0044	0044	0044	0044	0044	0044	0044	0044	0044	0044	0044	0044	0044	
1861	RESERV	8049	1049	0044	0044	0044	0044	0044	0044	0044	0044	0044	0044	0044	0044	0044	0044	0044	0044	0044	0044	
1862	FOK1	8050	1050	0044	0044	0044	0044	0044	0044	0044	0044	0044	0044	0044	0044	0044	0044	0044	0044	0044	0044	
1863	POK2	8051	1051	0044	0044	0044	0044	0044	0044	0044	0044	0044	0044	0044	0044	0044	0044	0044	0044	0044	0044	
1864	RESERV	8052	1052	0044	0044	0044	0044	0044	0044	0044	0044	0044	0044	0044	0044	0044	0044	0044	0044	0044	0044	
1865	PPMAX	8053	1053	0044	0044	0044	0044	0044	0044	0044	0044	0044	0044	0044	0044	0044	0044	0044	0044	0044	0044	
1866	PDDP	8054	1054	0044	0044	0044	0044	0044	0044	0044	0044	0044	0044	0044	0044	0044	0044	0044	0044	0044	0044	
1867	PHYST	8055	1055	0044	0044	0044	0044	0044	0044	0044	0044	0044	0044	0044	0044	0044	0044	0044	0044	0044	0044	
1868	ENFCMP	8056	1056	0044	0044	0044	0044	0044	0044	0044	0044	0044	0044	0044	0044	0044	0044	0044	0044	0044	0044	
1869	PYPA	8057	1057	0044	0044	0044	0044	0044	0044	0044	0044	0044	0044	0044	0044	0044	0044	0044	0044	0044	0044	
1870	PALPH	8058	1058	0044	0044	0044	0044	0044	0044	0044	0044	0044	0044	0044	0044	0044	0044	0044	0044	0044	0044	
1871	PPBAS	8059	1059	0044	0044	0044	0044	0044	0044	0044	0044	0044	0044	0044	0044	0044	0044	0044	0044	0044	0044	
1872	TOLIN	8060	1060	0044	0044	0044	0044	0044	0044	0044	0044	0044	0044	0044	0044	0044	0044	0044	0044	0044	0044	
1873	ENFLMT	8061	1061	0044	0044	0044	0044	0044	0044	0044	0044	0044	0044	0044	0044	0044	0044	0044	0044	0044	0044	
1877	FOVCL	8062	1062	0044	0044	0044	0044	0044	0044	0044	0044	0044	0044	0044	0044	0044	0044	0044	0044	0044	0044	
1878	POV2C	8063	1063	0044	0044	0044	0044	0044	0044	0044	0044	0044	0044	0044	0044	0044	0044	0044	0044	0044	0044	
1882	BITPA1	8064	1064	0044	0044	0044	0044	0044	0044	0044	0044	0044	0044	0044	0044	0044	0044	0044	0044	0044	0044	
1893	FOVCLMT	8065	1065	0044	0044	0044	0044	0044	0044	0044	0044	0044	0044	0044	0044	0044	0044	0044	0044	0044	0044	
1894	PK2VAUX	8066	1066	0044	0044	0044	0044	0044	0044	0044	0044	0044	0044	0044	0044	0044	0044	0044	0044	0044	0044	
1895	FILTER	8067	1067	0044	0044	0044	0044	0044	0044	0044	0044	0044	0044	0044	0044	0044	0044	0044	0044	0044	0044	
1961	RESERV																					
1962	FALPH	8068	1068	0044	0044	0044	0044	0044	0044	0044	0044	0044	0044	0044	0044	0044	0044	0044	0044	0044	0044	
1963	UFFLT	8069	1069	0044	0044	0044	0044	0044	0044	0044	0044	0044	0044	0044	0044	0044	0044	0044	0044	0044	0044	
1964	ERBLM	8070	1070	0044	0044	0044	0044	0044	0044	0044	0044	0044	0044	0044	0044	0044	0044	0044	0044	0044	0044	
1965	PBLCT	8071	1071	0044	0044	0044	0044	0044	0044	0044	0044	0044	0044	0044	0044	0044	0044	0044	0044	0044	0044	
1966	RESERV	8072	1072	0044	0044	0044	0044	0044	0044	0044	0044	0044	0044	0044	0044	0044	0044	0044	0044	0044	0044	
1967	RESERV	8073	1073	0044	0044	0044	0044	0044	0044	0044	0044	0044	0044	0044	0044	0044	0044	0044	0044	0044	0044	
1968	AALPH	8074	1074	0044	0044	0044	0044	0044	0044	0044	0044	0044	0044	0044	0044	0044	0044	0044	0044	0044	0044	
1969	MODEL	8075	1075	0044	0044	0044	0044	0044	0044	0044	0044	0044	0044	0044	0044	0044	0044	0044	0044	0044	0044	
1970	WVAC	8076	1076	0044	0044	0044	0044	0044	0044	0044	0044	0044	0044	0044	0044	0044	0044	0044	0044	0044	0044	
1971	OSCTPL	8077	1077	0044	0044	0044	0044	0044	0044	0044	0044	0044	0044	0044	0044	0044	0044	0044	0044	0044	0044	
1972	RESERV	8078	1078	0044	0044	0044	0044	0044	0044	0044	0044	0044	0044	0044	0044	0044	0044	0044	0044	0044	0044	
1973	RESERV	8079	1079	0044	0044	0044	0044	0044	0044	0044	0044	0044	0044	0044	0044	0044	0044	0044	0044	0044	0044	
1974	RESERV	8080	1080	0044	0044	0044	0044	0044	0044	0044	0044	0044	0044	0044	0044	0044	0044	0044	0044	0044	0044	
1975	BLENDL	8081	1081	0044	0044	0044	0044	0044	0044	0044	0044	0044	0044	0044	0044	0044	0044	0044	0044	0044	0044	
1976	MOFCTL	8082	1082	0044	0044	0044	0044	0044	0044	0044	0044	0044	0044	0044	0044	0044	0044	0044	0044	0044	0044	
1977	SDMR1	8083	1083	0044	0044	0044	0044	0044	0044	0044	0044	0044	0044	0044	0044	0044	0044	0044	0044	0044	0044	
1978	SDMR2	8084	1084	0044	0044	0044	0044	0044	0044	0044	0044	0044	0044	0044	0044	0044	0044	0044	0044	0044	0044	
1979	RTCURR	8085	1085	0044	0044	0044	0044	0044	0044	0044	0044	0044	0044	0044	0044	0044	0044	0044	0044	0044	0044	
1980	TUPLD	8086	1086	0044	0044	0044	0044	0044	0044	0044	0044	0044	0044	0044	0044	0044	0044	0044	0044	0044	0044	
		8087	1087	0044	0044	0044	0044	0044	0044	0044	0044	0044	0044	0044	0044	0044	0044	0044	0044	0044	0044	0044

ROM VERSION
9030/1O
9030/1P
9031/1H

Parameter Table No. 22-c (PARAM112)

PARAM112	Symbol	Motor model Drawing No. of motor Motor type	Power Mate C										6L	50S	60S	70S	
			FS15	FS0	1-0S	2-0S	0S	5S	10S	20S/1500	20S	30S					2-0S
1852	INTST	8m40	0044	0044	0044	0044	0044	0044	0044	0044	0044	0044	0044	0044	0044	0044	0846
1853	PK1	8m41	1648	1170	1600	1500	2591	1131	1261	1261	3414	380	850	850	999	1451	1334
1854	PK2	8m42	-3088	-2289	-2400	-2781	-5540	-2477	-2577	-2577	-7650	-319	-2300	-2300	-3600	-6000	-5297
1855	PK3	8m43	-2488	-2485	-2475	-3052	-2623	-2649	-2646	-2646	-2480	-2480	-2652	-2652	-1957	-2259	-2723
1856	PK4	8m44	134	163	204	212	467	824	535	535	361	200	62	168	130	145	145
1857	PK5	8m45	-665	-812	-1015	-1355	-2328	-4103	-2666	-2666	-1797	-997	-309	-309	-1502	-1165	-1295
1858	PK6	8m46	0	0	0	0	0	0	0	0	0	0	0	0	0	0	0
1859	PK7	8m47	-16471	-16471	-16471	-16471	-16471	-16471	-16471	-16471	-16471	-16471	-16471	-16471	-8235	-8235	-8235
1860	PK8	8m48	11417	9349	7481	5602	3261	1850	2647	2647	4224	7611	0	2526	3259	2931	0
1861	BLCMP	8m49	0	0	0	0	0	0	0	0	0	0	0	0	0	0	0
1862	RESERV	8m50	1677	1677	1677	1677	1677	1677	1677	1677	1677	1677	1677	1677	956	956	956
1863	POK1	8m51	1788	1788	1788	1788	1788	1788	1788	1788	1788	1788	1788	1788	510	510	510
1864	POK2	8m52	1051	1051	1051	1051	1051	1051	1051	1051	1051	1051	1051	1051	510	510	510
1865	RESERV	8m53	0	0	0	0	0	0	0	0	0	0	0	0	0	0	0
1866	PPMAX	8m54	21	21	21	21	21	21	21	21	21	21	21	21	21	21	21
1867	PDDP	8m55	3787	3787	3787	3787	3787	3787	3787	3787	3787	3787	3787	3787	3787	3787	3787
1868	PIVST	8m56	319	319	319	319	319	319	319	319	319	319	319	319	319	319	319
1869	ENFCMP	8m57	1589	1589	1589	1589	1589	1589	1589	1589	1589	1589	1589	1589	1589	1589	1589
1870	PVPA	8m58	2330	2330	2330	2330	2330	2330	2330	2330	2330	2330	2330	2330	2330	2330	2330
1871	PALPH	8m59	57	46	57	57	64	52	57	57	50	57	57	57	57	57	57
1872	PPBAS	8m60	1059	1059	1059	1059	1059	1059	1059	1059	1059	1059	1059	1059	1059	1059	1059
1873	TOLIN	8m61	4855	7282	7282	7282	7282	7282	7282	7282	6918	7282	6918	6918	6560	6560	6560
1874	ENFLMT	8m62	120	120	120	120	120	120	120	120	120	120	120	120	120	120	120
1875	POVCL1	8m63	32704	32722	32722	32722	32722	32722	32722	32722	32722	32722	32722	32722	32722	32722	32722
1876	POVCL2	8m64	806	1166	578	1142	2864	7659	4771	4771	2971	1811	1928	4365	3358	6086	6086
1877	BITPAL	8m65	0	0	0	0	0	0	0	0	0	0	0	0	0	0	0
1878	TGALMLV	8m66	4	4	4	4	4	4	4	4	4	4	4	4	4	4	4
1879	POVCLMT	8m67	2390	5245	1715	3398	8515	42907	14219	14219	8834	5377	5727	13002	9990	18168	18168
1880	PK2VAUX	8m68	0	0	0	0	0	0	0	0	0	0	0	0	0	0	0
1881	FILTER	8m69	0	0	0	0	0	0	0	0	0	0	0	0	0	0	0
1882	RESERV	8m70	0	0	0	0	0	0	0	0	0	0	0	0	0	0	0
1883	RESERV	8m71	0	0	0	0	0	0	0	0	0	0	0	0	0	0	0
1884	RESERV	8m72	0	0	0	0	0	0	0	0	0	0	0	0	0	0	0
1885	RESERV	8m73	0	0	0	0	0	0	0	0	0	0	0	0	0	0	0
1886	RESERV	8m74	0	0	0	0	0	0	0	0	0	0	0	0	0	0	0
1887	RESERV	8m75	0	0	0	0	0	0	0	0	0	0	0	0	0	0	0
1888	RESERV	8m76	0	0	0	0	0	0	0	0	0	0	0	0	0	0	0
1889	RESERV	8m77	0	0	0	0	0	0	0	0	0	0	0	0	0	0	0
1890	RESERV	8m78	0	0	0	0	0	0	0	0	0	0	0	0	0	0	0
1891	RESERV	8m79	0	0	0	0	0	0	0	0	0	0	0	0	0	0	0
1892	RESERV	8m80	0	0	0	0	0	0	0	0	0	0	0	0	0	0	0
1893	RESERV	8m81	0	0	0	0	0	0	0	0	0	0	0	0	0	0	0
1894	RESERV	8m82	0	0	0	0	0	0	0	0	0	0	0	0	0	0	0
1895	RESERV	8m83	0	0	0	0	0	0	0	0	0	0	0	0	0	0	0
1896	RESERV	8m84	0	0	0	0	0	0	0	0	0	0	0	0	0	0	0
1897	RESERV	8m85	0	0	0	0	0	0	0	0	0	0	0	0	0	0	0
1898	RESERV	8m86	0	0	0	0	0	0	0	0	0	0	0	0	0	0	0
1899	RESERV	8m87	0	0	0	0	0	0	0	0	0	0	0	0	0	0	0
1900	RESERV	8m88	1137	1685	1064	1354	1768	3801	2285	2285	1801	1706	1761	2653	2326	3137	0

ROM VERSION
9030/1O
9030/1P
9031/1H

2. SERVO FUNCTIONS

ROM VERSION
9030/10
9030/1P
9031/1H

Parameter Table No. 22-f (PARAM112)

PARAM112	Symbol	Motor model Drawing No. of motor	Power Mate C				6S(H)
			6L(H)	7L(H)	10L(H)	6S(H)	
		FS0	0564	71	0572	73	
		Parameter No.	70	71	72	73	
	INTST		0846	0846	0846	0846	
	PK1	8040	850	590	700	1000	
	PK2	8041	-2300	-1600	-2000	-2400	
	PK3	8042	-2652	-2685	-2701	-2459	
	PK1V	8043	34	119	150	135	
	PK2V	8044	-309	-1070	-1346	-1205	
	PK3V	8045	0	0	0	0	
	PK4V	8046	-8235	-8235	-8235	-8235	
	POA1	8047	12292	3547	2820	3148	
	BLCMP	8048	0	0	0	0	
	RESERV	8049	0	0	0	0	
	POK1	8050	956	956	956	956	
	FOR2	8051	510	510	510	510	
	RESERV	8052	0	0	0	0	
	PPMAX	8053	21	21	21	21	
	DDDP	8054	3787	3787	3787	3787	
	PHYST	8055	319	319	319	319	
	EMFCMP	8056	1240	3200	4800	3200	
	PVPA	8057	2330	3200	3200	2300	
	PALPH	8058	57	64	64	64	
	PPBAS	8059	0	0	0	5	
	TQLIM	8060	6918	7282	7282	6918	
	ENFLMT	8061	120	120	120	120	
	POVCI	8062	32614	32299	31875	32893	
	POVCC	8063	1928	5867	11158	940	
	BITPA1		68	68	68	68	
	TGALMLY	8064	4	4	4	4	
	POVCLMT	8065	5727	17509	32767	2787	
	PK2VAUX	8066	0	0	0	0	
	FILTER	8067	0	0	0	0	
	RESERV		0	0	0	0	
	RESERV		0	0	0	0	
	RESERV		0	0	0	0	
	RESERV		0	0	0	0	
	FALPH	8068	0	0	0	0	
	VFFLT	8069	0	0	0	0	
	ERBLM	8070	0	0	0	0	
	PBLCT	8071	0	0	0	0	
	RESERV	8072	0	0	0	0	
	RESERV	8073	0	0	0	0	
	AALPH	8074	4000	4000	4000	3200	
	MODEL	8075	0	0	0	0	
	WKAC	8076	0	0	0	0	
	OSCTPL	8077	0	0	0	0	
	RESERV	8078	0	0	0	0	
	RESERV	8079	0	0	0	0	
	RESERV	8080	0	0	0	0	
	RESERV	8081	0	0	0	0	
	BLENDL	8082	0	0	0	0	
	NOFCTL	8083	0	0	0	0	
	SDMR1	8084	0	0	0	0	
	SDMR2	8085	0	0	0	0	
	RTCURR	8086	1761	3079	4261	1228	
	TDPLD	8087	0	0	0	0	
		1960					

2. SERVO FUNCTIONS

Parameter Table No. 23-a (PARAM113)

PARAM113 Symbol	Motor model Drawing No. of motor Motor type	#1	6S	5-0 0531	4-0 0532	3-0 0533	2-0 0521	1-0 0522	0 0513	5 0512	10 0501	20/1500 0505	30 0503	30/2000 0506	ROM VERSION			
															FS15	Power Mate C	9030/10	9040/1D
																	FS15	Power Mate C
INTST																		
PK1	8040	0044	0044	0044	0044	0044	0044	0044	0044	0044	0044	0044	0044	0044	0044			
PK2	8041	1040	750	457	460	669	322	469	828	1720	944	808	1452	705				
PK3	8042	1041	-2000	-999	-1461	-2126	-1103	-1625	-2782	-3532	-3074	-3682	-5576	-2716				
PK4	8043	1042	-2596	-1873	-2373	-2374	-2488	-2503	-2457	-3052	-2822	-2649	-2646	-2669				
PK1V	8044	1043	388	53	104	96	267	217	226	359	654	824	585	674				
PK2V	8045	1044	-1932	-300	-517	-477	-1330	-1082	-1127	-1789	-3259	-4103	-2666	-3356				
PK3V	8045	1045	0	0	0	0	0	0	0	0	0	0	0	0				
PK4V	8046	1046	-16471	-16471	-16471	-16471	-16471	-16471	-16471	-16471	-16471	-16471	-16471	-16471				
POA1	8047	1047	3929	0	14668	15897	5709	7012	6132	4243	2329	1830	2847	3017	2261			
BLOMP	8048	1048	0	0	0	0	0	0	0	0	0	0	0	0				
RESERV	8049	1049	0	0	0	0	0	0	0	0	0	0	0	0				
POK1	8050	1050	1677	1677	1677	1677	1677	1677	1677	1677	1677	1677	1677	1677				
POK2	8051	1051	1788	1788	1788	1788	1788	1788	1788	1788	1788	1788	1788	1788				
RESERV	8052	1052	0	0	0	0	0	0	0	0	0	0	0	0				
PPMAX	8053	1053	21	21	21	21	21	21	21	21	21	21	21	21				
PDPP	8054	1054	3787	3787	3787	3787	3787	3787	3787	3787	3787	3787	3787	3787				
PHYST	8055	1055	319	319	319	319	319	319	319	319	319	319	319	319				
EMFCMP	8056	1056	5000	0	629	1129	636	1287	1218	1648	2103	3549	2731	3270	1961			
PVPA	8057	1057	3750	2330	2330	2330	2800	2330	2330	2330	2800	2330	2800	2330				
PALPH	8058	1058	64	57	57	57	64	57	57	57	64	43	57	43				
PPBAS	8059	1059	0	0	0	0	0	0	0	0	0	0	0	0				
TQLIM	8060	1060	7282	7282	7282	7282	7282	7282	7282	7282	7282	7282	6918	6554				
ENFLMT	8061	1061	0	0	120	120	120	120	120	120	120	120	120	120				
POVC1	8062	1062	32519	32514	32543	32576	32507	32519	32712	32645	32321	32155	32386	32354				
POVC2	8063	1063	3112	3173	2817	2401	3265	3112	706	1539	5585	7659	4771	5807	6421			
BITP1A1			0	0	0	0	0	0	0	0	0	0	0	0				
TGALMLV	8064	1064	4	4	4	4	4	4	4	4	4	4	4	4				
POVCLNT	8065	1065	9437	9437	8375	7136	9713	9256	2094	4567	16660	22907	14219	19176				
PK2VAUX	8066	1066	0	0	0	0	0	0	0	0	0	0	0	0				
FILTER	8067	1067	0	0	0	0	0	0	0	0	0	0	0	0				
RESERV			0	0	0	0	0	0	0	0	0	0	0	0				
RESERV			0	0	0	0	0	0	0	0	0	0	0	0				
RESERV			0	0	0	0	0	0	0	0	0	0	0	0				
RESERV			0	0	0	0	0	0	0	0	0	0	0	0				
FALPH	8068	1068	0	0	0	0	0	0	0	0	0	0	0	0				
VFFELT	8069	1069	0	0	0	0	0	0	0	0	0	0	0	0				
FRBLM	8070	1070	0	0	0	0	0	0	0	0	0	0	0	0				
PBLCT	8071	1071	0	0	0	0	0	0	0	0	0	0	0	0				
RESERV	8072	1072	0	0	0	0	0	0	0	0	0	0	0	0				
RESERV	8073	1073	0	0	0	0	0	0	0	0	0	0	0	0				
RESERV	8074	1074	0	0	0	0	0	0	0	0	0	0	0	0				
MODEL	8075	1075	0	0	0	0	0	0	0	0	0	0	0	0				
WKAC	8076	1076	0	0	0	0	0	0	0	0	0	0	0	0				
OSCTPL	8077	1077	0	0	0	0	0	0	0	0	0	0	0	0				
RESERV	8078	1078	0	0	0	0	0	0	0	0	0	0	0	0				
RESERV	8079	1079	0	0	0	0	0	0	0	0	0	0	0	0				
RESERV	8080	1080	0	0	0	0	0	0	0	0	0	0	0	0				
RESERV	8081	1081	0	0	0	0	0	0	0	0	0	0	0	0				
BLENDL	8082	1082	0	0	0	0	0	0	0	0	0	0	0	0				
MOFCTL	8083	1083	0	0	0	0	0	0	0	0	0	0	0	0				
SDMR1	8084	1084	0	0	0	0	0	0	0	0	0	0	0	0				
SDMR2	8085	1085	0	0	0	0	0	0	0	0	0	0	0	0				
RTCURR	8086	1086	2239	2261	2129	1966	2293	2239	1064	1572	2474	3801	2285	2654				
TDPLD	8087	1087	0	0	0	0	0	0	0	0	0	0	0	0				

2. SERVO FUNCTIONS

Parameter Table No. 23-c (PARAM113)

Symbol	Motor model Drawing No. of motor Motor type	Parameter No.													70S
		Power Mate C													
		FS15	FS0	1-OS	OS	5S	10S	20S/1500	20S	30S	2-OS	6L	50S	60S	
PARAM113				0312	0313	0314	0315	0505	0502	0590	0310	0331	0332	0333	
		29	31	30	31	32	33	34	35	36	37	39	40	41	
		0044	0044	0044	0044	0044	0044	0044	0044	0044	0044	0044	0044	0044	0044
INTST	8040	1648	1500	1170	1500	1500	2591	1131	1261	3414	390	850	1451	1334	0846
PK1	8041	-3088	-2400	-2289	-2400	-2781	-5640	-2477	-2577	-7650	-810	-2300	-6000	-5287	1451
PK2	8042	-2488	-2465	-2465	-2475	-3052	-2849	-2849	-2646	-2663	-2480	-2652	-2259	-2723	1451
PK3	8043	134	163	163	204	272	467	324	535	361	200	62	130	145	1451
PK1V	8044	-665	-1015	-812	-1015	-1355	-2328	-4103	-2666	-1797	-997	-309	-1165	-1295	1451
PK2V	8045	0	0	0	0	0	0	0	0	0	0	0	0	0	0
PK3V	8046	-16471	-16471	-16471	-16471	-16471	-16471	-16471	-16471	-16471	-16471	-16471	-8235	-8235	-8235
PK4V	8047	11417	7481	9349	7481	5602	3261	1850	2847	4224	7611	0	2526	2931	2931
BLCMP	8048	0	0	0	0	0	0	0	0	0	0	0	0	0	0
RESERV	8049	0	0	0	0	0	0	0	0	0	0	0	0	0	0
POR1	8050	1677	1677	1677	1677	1677	1677	1677	1677	1677	1677	1677	956	956	956
POR2	8051	1788	1788	1788	1788	1788	1788	1788	1788	1788	1788	1788	510	510	510
RESERV	8052	0	0	0	0	0	0	0	0	0	0	0	0	0	0
PPMAX	8053	21	21	21	21	21	21	21	21	21	21	21	21	21	21
PDP	8054	3787	3787	3787	3787	3787	3787	3787	3787	3787	3787	3787	3787	3787	3787
PHYST	8055	319	319	319	319	319	319	319	319	319	319	319	319	319	319
EMFCMP	8056	1589	2147	1350	2403	5520	3549	2731	5456	1589	1240	4444	4884	6668	6668
PVPA	8057	2330	2330	1864	2330	3500	2797	2600	7200	2330	2330	2330	2800	3040	3040
DALPH	8058	57	57	46	57	64	52	57	57	50	57	57	57	57	57
PPBAS	8059	0	0	0	0	0	0	0	0	0	0	0	0	0	0
QLIM	8060	4855	7282	7282	7282	7282	7282	7282	6918	6918	7282	6918	6560	6560	6560
ENFLT	8061	120	120	120	120	120	120	120	120	120	120	120	120	120	120
POVCI	8062	32704	32627	32627	32677	32539	32155	32386	32530	32530	32623	32614	32439	32281	32281
POVCE	8063	806	1766	1766	578	1142	2864	7659	4771	2971	1811	1928	3358	6086	6086
BITPAL		0	0	0	0	0	0	0	0	0	0	0	84	84	84
TGALMLV	8064	4	4	4	4	4	4	4	4	4	4	4	4	4	4
POVCLM	8065	2390	1715	5245	3388	8515	22907	14219	8834	8834	5377	5727	9990	18168	18168
PKZVAUX	8066	0	0	0	0	0	0	0	0	0	0	0	1100	1100	1100
FILTER	8067	0	0	0	0	0	0	0	0	0	0	0	0	0	0
RESERV		0	0	0	0	0	0	0	0	0	0	0	0	0	0
RESERV		0	0	0	0	0	0	0	0	0	0	0	0	0	0
RESERV		0	0	0	0	0	0	0	0	0	0	0	0	0	0
FALPH	8068	0	0	0	0	0	0	0	0	0	0	0	0	0	0
VFFLT	8069	0	0	0	0	0	0	0	0	0	0	0	0	0	0
FRLM	8070	0	0	0	0	0	0	0	0	0	0	0	0	0	0
PBLCT	8071	0	0	0	0	0	0	0	0	0	0	0	0	0	0
RESERV	8072	0	0	0	0	0	0	0	0	0	0	0	0	0	0
RESERV	8073	0	0	0	0	0	0	0	0	0	0	0	0	0	0
AALPH	8074	0	0	0	0	0	0	0	0	0	0	0	0	0	0
MODEL	8075	0	0	0	0	0	0	0	0	0	0	0	400	400	400
WAAC	8076	0	0	0	0	0	0	0	0	0	0	0	15	15	15
OSCTPL	8077	0	0	0	0	0	0	0	0	0	0	0	0	0	0
RESERV	8078	0	0	0	0	0	0	0	0	0	0	0	0	0	0
RESERV	8079	0	0	0	0	0	0	0	0	0	0	0	0	0	0
RESERV	8080	0	0	0	0	0	0	0	0	0	0	0	0	0	0
RESERV	8081	0	0	0	0	0	0	0	0	0	0	0	0	0	0
RESERV	8082	0	0	0	0	0	0	0	0	0	0	0	0	0	0
BLFNDL	8083	0	0	0	0	0	0	0	0	0	0	0	0	0	0
MOFCTL	8084	0	0	0	0	0	0	0	0	0	0	0	0	0	0
SDMRI	8085	0	0	0	0	0	0	0	0	0	0	0	0	0	0
SDMR2	8086	0	0	0	0	0	0	0	0	0	0	0	0	0	0
RTCURR	8087	1137	1685	1685	1064	1354	1768	3801	2285	1801	1705	1761	2326	3137	3137
TDPLD	1980	0	0	0	0	0	0	0	0	0	0	0	0	0	0

ROM VERSION
 9030/1Q
 9031/1J
 9040/1D

2. SERVO FUNCTIONS

Parameter Table No. 23-d (PARAM113)

PARAM113	Symbol	Motor model Drawing No. of motor Motor type	Power Mate C																ROM VERSION	
			Parameter No.																9030/1Q	9040/1D
			FS15	5-0	4-OS	3-OS	2-OS	1-OS	OS	5S	6S	10S	20S/1500	20S	30S	30/2000	40			
	IATST		0531	0532	0533	0310	0312	0313	0314	0316	0315	0505	0502	0590	0506	0581				
	PK1	8d40	42	43	44	45	46	47	48	49	50	51	52	53	54	55				
	PK2	8d41	0046	0046	0046	0046	0046	0046	0046	0046	0046	0046	0046	0046	0046	0046	0046			
	PK3	8d42	460	736	736	390	1170	1500	1500	750	2591	1131	1261	3414	705	1511				
	PK4	8d43	-999	-730	-1500	-2289	-2400	-2781	-2000	-2000	-5540	-2477	-2577	-7650	-2716	-5829				
	PK5	8d44	-1873	-2373	-2374	-2480	-2485	-2475	-3052	-2596	-2623	-2649	-2646	-2663	-2669	-2672				
	PK6	8d45	58	58	53	111	91	113	151	216	260	458	298	201	375	282				
	PK7	8d46	-300	-517	-477	-997	-812	-1015	-1355	-1932	-2328	-4103	-2666	-1797	-3356	-2526				
	PK8	8d47	-8235	-8235	-8235	-8235	-8235	-8235	-8235	-8235	-8235	-8235	-8235	-8235	-8235	-8235				
	PK9	8d48	7334	7948	7948	3806	4674	3740	2801	1964	1630	925	1424	2112	1131	1302				
	PK10	8d49	0	0	0	0	0	0	0	0	0	0	0	0	0	0				
	PK11	8d50	956	956	956	956	956	956	956	956	956	956	956	956	956	956				
	PK12	8d51	510	510	510	510	510	510	510	510	510	510	510	510	510	510				
	PK13	8d52	0	0	0	0	0	0	0	0	0	0	0	0	0	0				
	PK14	8d53	21	21	21	21	21	21	21	21	21	21	21	21	21	21				
	PK15	8d54	3787	3787	3787	3787	3787	3787	3787	3787	3787	3787	3787	3787	3787	3787				
	PK16	8d55	319	319	319	319	319	319	319	319	319	319	319	319	319	319				
	PK17	8d56	0	629	1129	1589	2147	1350	2403	5000	5520	3549	2731	5456	1961	3478				
	PK18	8d57	2330	1861	2330	2330	1864	2330	2330	3750	3500	2797	2600	7200	2330	2800				
	PK19	8d58	57	46	57	57	46	57	57	64	64	52	57	50	57	43				
	PK20	8d59	0	0	0	0	0	0	0	0	0	0	0	0	0	0				
	PK21	8d60	7282	7282	7282	7282	7282	7282	7282	7282	7282	7282	6918	6554	7282	7282				
	PK22	8d61	120	120	120	120	120	120	120	120	120	120	120	120	120	120				
	PK23	8d62	32514	32543	32576	32623	32627	32722	32677	32685	32539	32155	32386	32530	32254	32340				
	PK24	8d63	3173	2817	2401	1811	1766	578	1142	3536	2864	7659	4771	2971	6421	5555				
	PK25	8d64	0	4	4	4	4	4	4	4	4	4	4	4	4	4				
	PK26	8d65	9437	8375	7136	5377	5245	1715	3388	10522	8515	22907	14219	8834	19176	15972				
	PK27	8d66	0	0	0	0	0	0	0	0	0	0	0	0	0	0				
	PK28	8d67	0	0	0	0	0	0	0	0	0	0	0	0	0	0				
	PK29	8d68	0	0	0	0	0	0	0	0	0	0	0	0	0	0				
	PK30	8d69	0	0	0	0	0	0	0	0	0	0	0	0	0	0				
	PK31	8d70	0	0	0	0	0	0	0	0	0	0	0	0	0	0				
	PK32	8d71	0	0	0	0	0	0	0	0	0	0	0	0	0	0				
	PK33	8d72	0	0	0	0	0	0	0	0	0	0	0	0	0	0				
	PK34	8d73	0	0	0	0	0	0	0	0	0	0	0	0	0	0				
	PK35	8d74	0	0	0	0	0	0	0	0	0	0	0	0	0	0				
	PK36	8d75	0	0	0	0	0	0	0	0	0	0	0	0	0	0				
	PK37	8d76	0	0	0	0	0	0	0	0	0	0	0	0	0	0				
	PK38	8d77	0	0	0	0	0	0	0	0	0	0	0	0	0	0				
	PK39	8d78	0	0	0	0	0	0	0	0	0	0	0	0	0	0				
	PK40	8d79	0	0	0	0	0	0	0	0	0	0	0	0	0	0				
	PK41	8d80	0	0	0	0	0	0	0	0	0	0	0	0	0	0				
	PK42	8d81	0	0	0	0	0	0	0	0	0	0	0	0	0	0				
	PK43	8d82	0	0	0	0	0	0	0	0	0	0	0	0	0	0				
	PK44	8d83	0	0	0	0	0	0	0	0	0	0	0	0	0	0				
	PK45	8d84	0	0	0	0	0	0	0	0	0	0	0	0	0	0				
	PK46	8d85	0	0	0	0	0	0	0	0	0	0	0	0	0	0				
	PK47	8d86	2261	2129	1966	1706	1685	1054	1354	1966	1768	3801	2285	1801	2654	2941				
	PK48	8d87	0	0	0	0	0	0	0	0	0	0	0	0	0	0				

Parameter Table No. 23-e (PARAM113)

Symbol	Motor model Drawing No. of motor	Motor type	FS15	FS0	Power Mate C	PARAM113										FROM VERSION				
						0L	5L	6L	7L	10L	2-OS(H)	1-OS(H)	OS(H)	5S(H)	10S(H)	20S(H)	30S(H)	OL(H)	5L(H)	
						0561 56	0562 57	0564 58	0571 59	0572 60	0310 61	0309 62	0313 63	0514 64	0317 65	0318 66	0319 67	0461 68	0562 69	9030/TQ
PARAM113																				
INTST																				
PK1	8d40	1040	0046	0046	0046	0046	0046	0046	0046	0046	0046	0046	0046	0046	0046	0046	0046	0046	0046	0046
PK2	8d41	1041	2000	1360	850	590	390	700	700	450	450	600	672	1090	542	708	2000	1360	850	590
PK3	8d42	1042	-5635	-4000	-2300	-1800	-810	-2000	-2000	-900	-900	-1600	-1574	-2360	-1377	-1811	-5635	-4000	-2300	-1800
PK4	8d43	1043	-2614	-2647	-2652	-2652	-2480	-2701	-2701	-2303	-2303	-2517	-2526	-2825	-2654	-2664	-2614	-2647	-2652	-2652
PK5	8d44	1044	17	17	34	119	111	150	150	128	128	126	136	287	305	346	18	17	17	17
PK6	8d45	1045	-156	-156	-309	-1070	-997	-1346	-1346	-1146	-1146	-1127	-1215	-2571	-2734	-3097	-156	-156	-156	-156
PK7	8d46	1046	-8235	-8235	-8235	-8235	-8235	-8235	-8235	-8235	-8235	-8235	-8235	-8235	-8235	-8235	-8235	-8235	-8235	-8235
PK8	8d47	1047	23820	24290	12292	3547	3806	2820	2820	3311	3311	3366	3124	1476	1388	1226	23820	24290	12292	3547
PK9	8d48	1048	0	0	0	0	0	0	0	0	0	0	0	0	0	0	0	0	0	0
PK10	8d49	1049	0	0	0	0	0	0	0	0	0	0	0	0	0	0	0	0	0	0
PK11	8d50	1050	956	956	956	956	956	956	956	956	956	956	956	956	956	956	956	956	956	956
PK12	8d51	1051	510	510	510	510	510	510	510	510	510	510	510	510	510	510	510	510	510	510
PK13	8d52	1052	0	0	0	0	0	0	0	0	0	0	0	0	0	0	0	0	0	0
PK14	8d53	1053	21	21	21	21	21	21	21	21	21	21	21	21	21	21	21	21	21	21
PK15	8d54	1054	3787	3787	3787	3787	3787	3787	3787	3787	3787	3787	3787	3787	3787	3787	3787	3787	3787	3787
PK16	8d55	1055	319	319	319	319	319	319	319	319	319	319	319	319	319	319	319	319	319	319
PK17	8d56	1056	1075	1097	1240	3200	2100	4000	4000	2520	2520	2620	2620	3780	5400	6000	2000	2000	2000	2000
PK18	8d57	1057	2330	2330	2330	2330	2330	2330	2330	2330	2330	2330	2330	2330	2330	2200	2330	2330	2330	2330
PK19	8d58	1058	57	57	57	57	57	57	57	57	57	57	57	57	57	57	57	57	57	57
PK20	8d59	1059	0	0	0	0	0	0	0	0	0	0	0	0	0	0	0	0	0	0
PK21	8d60	1060	7282	6918	8918	7282	7282	7282	7282	7282	7282	7282	7282	7282	7282	7282	6918	6918	7282	7282
PK22	8d61	1061	120	120	120	120	120	120	120	120	120	120	120	120	120	120	120	120	120	120
PK23	8d62	1062	32695	32698	32614	32299	32623	31875	31875	32519	32519	32712	32594	32578	32495	32470	32695	32698	32695	32698
PK24	8d63	1063	912	877	1928	5867	1811	11158	11158	3112	3112	706	924	2381	3410	3723	912	877	877	877
PK25	8d64	1064	4	4	4	4	4	4	4	4	4	4	4	4	4	4	4	4	4	4
PK26	8d65	1065	2706	2602	5727	17609	5377	32767	32767	92556	92556	2094	2740	7075	10144	11081	2706	2602	2602	2602
PK27	8d66	1066	0	0	0	0	0	0	0	0	0	0	0	0	0	0	0	0	0	0
PK28	8d67	1067	0	0	0	0	0	0	0	0	0	0	0	0	0	0	0	0	0	0
PK29	8d68	1068	0	0	0	0	0	0	0	0	0	0	0	0	0	0	0	0	0	0
PK30	8d69	1069	0	0	0	0	0	0	0	0	0	0	0	0	0	0	0	0	0	0
PK31	8d70	1070	0	0	0	0	0	0	0	0	0	0	0	0	0	0	0	0	0	0
PK32	8d71	1071	0	0	0	0	0	0	0	0	0	0	0	0	0	0	0	0	0	0
PK33	8d72	1072	0	0	0	0	0	0	0	0	0	0	0	0	0	0	0	0	0	0
PK34	8d73	1073	0	0	0	0	0	0	0	0	0	0	0	0	0	0	0	0	0	0
PK35	8d74	1074	0	0	0	0	0	0	0	0	0	0	0	0	0	0	0	0	0	0
PK36	8d75	1075	0	0	0	0	0	0	0	0	0	0	0	0	0	0	0	0	0	0
PK37	8d76	1076	0	0	0	0	0	0	0	0	0	0	0	0	0	0	0	0	0	0
PK38	8d77	1077	0	0	0	0	0	0	0	0	0	0	0	0	0	0	0	0	0	0
PK39	8d78	1078	0	0	0	0	0	0	0	0	0	0	0	0	0	0	0	0	0	0
PK40	8d79	1079	0	0	0	0	0	0	0	0	0	0	0	0	0	0	0	0	0	0
PK41	8d80	1080	0	0	0	0	0	0	0	0	0	0	0	0	0	0	0	0	0	0
PK42	8d81	1081	0	0	0	0	0	0	0	0	0	0	0	0	0	0	0	0	0	0
PK43	8d82	1082	0	0	0	0	0	0	0	0	0	0	0	0	0	0	0	0	0	0
PK44	8d83	1083	0	0	0	0	0	0	0	0	0	0	0	0	0	0	0	0	0	0
PK45	8d84	1084	0	0	0	0	0	0	0	0	0	0	0	0	0	0	0	0	0	0
PK46	8d85	1085	0	0	0	0	0	0	0	0	0	0	0	0	0	0	0	0	0	0
PK47	8d86	1086	1210	1187	1761	3079	1706	4261	4261	2239	2239	1064	1218	1814	2344	2450	1210	1187	1187	1187
PK48	8d87	1087	0	0	0	0	0	0	0	0	0	0	0	0	0	0	0	0	0	0

ROM VERSION
9030/1Q
9031/1J
9040/1D

Parameter Table No. 23-f (PARAM113)

Symbol	PARAM113	Motor model Drawing No. of motor	6L(H) 0564	7L(H) 0571	10L(H) 0572	6S(H) 73	Power Mate C	Motor Type	
								FS0	FS1
INTST			0846	0846	0846	0846			
PK1	1852	8040	850	590	700	1000	0846		0846
PK2	1853	8041	-300	-1600	-2000	-2400			
PK3	1854	8042	-2652	-2685	-2701	-2459			
PK1V	1855	8043	34	119	150	135			
PK2V	1856	8044	-309	-1070	-1346	-1205			
PK3V	1857	8045	0	0	0	0			
PK4V	1858	8046	-8235	-8235	-8235	-8235			
POA1	1859	8047	1292	3547	2820	3148			
BLCMP	1860	8048	0	0	0	0			
RESERV	1861	8049	0	0	0	0			
FOK1	1862	8050	956	956	956	956			
POK2	1863	8051	510	510	510	510			
RESERV	1864	8052	0	0	0	0			
PPMAX	1865	8053	21	21	21	21			
PDDP	1866	8054	3787	3787	3787	3787			
PHYST	1867	8055	319	319	319	319			
EMFCMP	1868	8056	1240	3200	4800	3200			
PYPA	1869	8057	2330	3200	3200	2300			
PALPH	1870	8058	64	64	64	64			
PPBAS	1871	8059	0	0	0	5			
TOLIN	1872	8060	6918	7282	7282	6918			
ENFLMT	1873	8061	120	120	120	120			
POVCI	1877	8062	32614	32239	31875	32693			
POVC2	1878	8063	1928	5867	11158	940			
BITPA1			68	68	68	68			
TGALMLV	1882	8064	4	4	4	4			
POVCLMT	1893	8065	5727	17509	32767	2787			
PK2VAUX	1894	8066	0	0	0	0			
FILTER	1895	8067	0	0	0	0			
RESERV			0	0	0	0			
RESERV			0	0	0	0			
RESERV			0	0	0	0			
FALPH	1961	8068	0	0	0	0			
VFLTI	1962	8069	0	0	0	0			
ERBLM	1963	8070	0	0	0	0			
PBLCT	1964	8071	0	0	0	0			
RESERV	1965	8072	0	0	0	0			
RESERV	1966	8073	0	0	0	0			
AALPH	1967	8074	4000	4000	4000	3200			
MODEL	1968	8075	0	0	0	0			
WKAC	1969	8076	0	0	0	0			
OSCTPL	1970	8077	0	0	0	0			
RESERV	1971	8078	0	0	0	0			
RESERV	1972	8079	0	0	0	0			
RESERV	1973	8080	0	0	0	0			
RESERV	1974	8081	0	0	0	0			
BLENDL	1975	8082	0	0	0	0			
NOFCTL	1976	8083	0	0	0	0			
SDMRI	1977	8084	0	0	0	0			
SDMR2	1978	8085	0	0	0	0			
RTCURR	1979	8086	1761	3079	4261	1228			
TDPLD	1980	8087	0	0	0	0			

ROM VERSION
9030/1Q
9031/1J
9040/1D

Parameter Table No. 23-g (PARAM113)

Symbol	Motor model	6L	5L	6L	5L	40S(H)	0T(H)	5T	5T(H)	10T	10T(H)	00SP(H)
PARAM113	Drawing No. of motor	0564	0562	0564	0562	0583	0381	0382	0383	0384	0385	0374
Parameter No.	Motor type	74	75	76	77	78	79	80	81	82	83	84
FS15	Power Mate C	0846	0843	0843	0843	0846	0846	0046	0846	0046	0846	0846
1852	INTST	0846	0843	0843	0843	0846	0846	0046	0846	0046	0846	0846
1853	PK1	1040	1040	1040	1040	1040	1040	1040	1040	1040	1040	1040
1854	PK2	1041	1041	1041	1041	1041	1041	1041	1041	1041	1041	1041
1855	PK3	1042	1042	1042	1042	1042	1042	1042	1042	1042	1042	1042
1856	PK1V	1043	1043	1043	1043	1043	1043	1043	1043	1043	1043	1043
1857	PK2V	1044	1044	1044	1044	1044	1044	1044	1044	1044	1044	1044
1858	PK3V	1045	1045	1045	1045	1045	1045	1045	1045	1045	1045	1045
1859	PK4V	1046	1046	1046	1046	1046	1046	1046	1046	1046	1046	1046
1860	POA1	1047	1047	1047	1047	1047	1047	1047	1047	1047	1047	1047
1861	BLCMP	1048	1048	1048	1048	1048	1048	1048	1048	1048	1048	1048
1862	RESERV	1049	1049	1049	1049	1049	1049	1049	1049	1049	1049	1049
1863	POK1	1050	1050	1050	1050	1050	1050	1050	1050	1050	1050	1050
1864	POK2	1051	1051	1051	1051	1051	1051	1051	1051	1051	1051	1051
1865	RESERV	1052	1052	1052	1052	1052	1052	1052	1052	1052	1052	1052
1866	PFMAX	1053	1053	1053	1053	1053	1053	1053	1053	1053	1053	1053
1867	PDDP	1054	1054	1054	1054	1054	1054	1054	1054	1054	1054	1054
1868	PHYST	1055	1055	1055	1055	1055	1055	1055	1055	1055	1055	1055
1869	ENFCMP	1056	1056	1056	1056	1056	1056	1056	1056	1056	1056	1056
1870	P1PA	1057	1057	1057	1057	1057	1057	1057	1057	1057	1057	1057
1871	PALPH	1058	1058	1058	1058	1058	1058	1058	1058	1058	1058	1058
1872	PPBAS	1059	1059	1059	1059	1059	1059	1059	1059	1059	1059	1059
1873	TOLIM	1060	1060	1060	1060	1060	1060	1060	1060	1060	1060	1060
1874	EMFMT	1061	1061	1061	1061	1061	1061	1061	1061	1061	1061	1061
1875	POV1	1062	1062	1062	1062	1062	1062	1062	1062	1062	1062	1062
1876	POV2	1063	1063	1063	1063	1063	1063	1063	1063	1063	1063	1063
1877	BITPA1	1064	1064	1064	1064	1064	1064	1064	1064	1064	1064	1064
1878	BITPA2	1065	1065	1065	1065	1065	1065	1065	1065	1065	1065	1065
1879	TGALMLV	1066	1066	1066	1066	1066	1066	1066	1066	1066	1066	1066
1880	POVCLMT	1067	1067	1067	1067	1067	1067	1067	1067	1067	1067	1067
1881	PK2VAUX	1068	1068	1068	1068	1068	1068	1068	1068	1068	1068	1068
1882	FILTR	1069	1069	1069	1069	1069	1069	1069	1069	1069	1069	1069
1883	BITPA3	1070	1070	1070	1070	1070	1070	1070	1070	1070	1070	1070
1884	BITPA4	1071	1071	1071	1071	1071	1071	1071	1071	1071	1071	1071
1885	FALPH	1072	1072	1072	1072	1072	1072	1072	1072	1072	1072	1072
1886	VFFLT	1073	1073	1073	1073	1073	1073	1073	1073	1073	1073	1073
1887	ERBLM	1074	1074	1074	1074	1074	1074	1074	1074	1074	1074	1074
1888	PBLCT	1075	1075	1075	1075	1075	1075	1075	1075	1075	1075	1075
1889	RESERV	1076	1076	1076	1076	1076	1076	1076	1076	1076	1076	1076
1890	RESERV	1077	1077	1077	1077	1077	1077	1077	1077	1077	1077	1077
1891	RESERV	1078	1078	1078	1078	1078	1078	1078	1078	1078	1078	1078
1892	RESERV	1079	1079	1079	1079	1079	1079	1079	1079	1079	1079	1079
1893	RESERV	1080	1080	1080	1080	1080	1080	1080	1080	1080	1080	1080
1894	RESERV	1081	1081	1081	1081	1081	1081	1081	1081	1081	1081	1081
1895	RESERV	1082	1082	1082	1082	1082	1082	1082	1082	1082	1082	1082
1896	BLENDL	1083	1083	1083	1083	1083	1083	1083	1083	1083	1083	1083
1897	MOFCTL	1084	1084	1084	1084	1084	1084	1084	1084	1084	1084	1084
1898	SDMR1	1085	1085	1085	1085	1085	1085	1085	1085	1085	1085	1085
1899	SDMR2	1086	1086	1086	1086	1086	1086	1086	1086	1086	1086	1086
1900	SDCURR	1087	1087	1087	1087	1087	1087	1087	1087	1087	1087	1087
1901	TDPLD	1088	1088	1088	1088	1088	1088	1088	1088	1088	1088	1088

III. SERIES 9050 DIGITAL SERVO SOFTWARE FOR Series 16

Part III, "Digital Servo Software for Series 16/18", describes the servo software for the following series.

Digital Servo ROM

ROM series	Latest edition	Use	Model
9050	I	For general machine tools (machine tools must have a serial pulse coder.)	Series 16 Series 18

This part describes the following points:

- (1) Series and edition of applicable servo ROM 3 -
- (2) Specifications 3 -
- (3) Parameter setting 3 -
- (4) Servo parameter setting 3 -
- (5) Alarm cause analysis 3 -
- (6) Changes in the specifications of the diagnostic board 3 -
- (7) Servo parameters for the Series 16 3 -
- (8) New functions 3 -

1. SPECIFICATIONS

(1) Series and edition of applicable servo ROM

Series 9050, editions 001A and later

(2) Specifications

- Series 9050 is the digital servo software for the Series 16/18. It has been designed to drive servo motors which have serial pulse coders.
- The 9050 series software is available for the following pulse coders:

Type	Maximum number of detection pulses	Communication with absolute values	Applicable motor
Serial pulse coder A	1,000,000P/rev	Provided	S series motor
Serial pulse coder B	250,000P/rev	Provided	T series motor
Serial pulse coder C	40,000P/rev	Not provided	S series motor

The ROM edition used to drive a motor is determined by the pulse coder mounted on the motor.

Serial pulse coders A and B : Series 9050, editions 001A and later
 Serial pulse coder C : Series 9050, editions 001B and later

For details of servo parameter setting for motors with each type of pulse coder, see the following description.

For the function of each parameter and the method of adjustment, see the relevant section in Parts I and II. The correspondence with the parameter numbers of Series 0 is as follows:

Series 16/18	Series 0
20□□	
X	81□□
Y	82□□
Z	83□□
:	

This means that the servo parameters of Series 16/18 correspond to those servo parameters of Series 0 that have the same numbers in the lower two digits. For information about the digital servo ROM for the Power Mate, see Section 2.1.2 in Part II.

1. SPECIFICATIONS

- (3) List of additional functions available with each edition (functions added to 9050 Series, edition B)

Additional function	Edition
Serial pulse coder dummy function	D
High-speed positioning function	D
Advanced feed-forward function	F
Dual position feedback function	F
Nonlinear control function	F
One-pulse suppress function for serial pulse coders A and B	G
Phase advancement compensation function for deceleration	G

2. SETTING PARAMETER

- (1) Be sure to use a flexible feed gear.

When using a motor with a serial pulse coder, be sure to use flexible feed gear for setting DMR. If flexible feed gear is not used, an alarm will be issued.

- (a) Serial pulse coders A and B

$$\frac{\text{Numerator of DMR (No.2084)}}{\text{Denominator of DMR (No.2085)}} = \frac{\text{Desired number of position feedback pulses per revolution of the motor}}{1,000,000}$$

(Note 1) Since the maximum value that can be set for both the numerator and denominator of DMR is 32767, use values obtained by dividing the numerator and denominator by a common value.

(Note 2) When the T series motor (serial pulse coder B) is used, the numerator of DMR (No.2084) must be 250,000 or less and the denominator of DMR (No.2085) must be 1,000,000.

(Note 3) The numerator must be smaller than or equal to the denominator. If a numerator larger than the denominator is set, an alarm will occur.

- (b) Serial pulse coder C

$$\frac{\text{Numerator of DMR (No. 2084)}}{\text{Denominator of DMR (No.2085)}} = \frac{\text{Desired number of position feedback pulses per revolution of the motor}}{40,000}$$

(Note) Since the maximum value that can be set for both the numerator and denominator of DMR is 32767, use values obtained by dividing the numerator and denominator by a common value.

- (2) Use motor No.39 or later.

The motor number used must be 39 or later (standard velocity loop period of 1 ms). If a motor with different velocity loop period is used, an alarm will be issued.

- (3) Set the dummy function for an axis with no servo amplifier or motor connected

Set the dummy function for an axis with no servo amplifier or motor connected. Then alarms associated with the serial pulse coders and amplifiers do not occur.

No. 2009 bit 0 = 1: Enables the dummy function
(available with Series 9050, editions D and later)

2. SETTING PARAMETER

For details of parameter setting, see the following description.

(4) Procedure for setting parameters

Enter the following from the NC keypad.

- (i) Function key <SYSTEM> → [SYSTEM] → [▷] → [SV - PRM]

The following servo setting screen appears on the CRT.

Servo setting		01000 N0000
	X axis	Z axis
INITIAL SET BITS	00000000	00000000
Motor ID No.	0	0
AMR	00000000	00000000
CMR	0	0
Feed gear	N 0	0
(N/M)	M 0	0
Direction Set	0	0
Velocity Pulse No	0	0
Position Pulse No	0	0
Ref counter	0	0
(Value Setting)		

Fig. 2

Initially set bits	:	No.2000
Motor ID No.	:	No.2020
AMR	:	No.2001
CMR	:	No.1820
Feed gear	N :	No.2084
(N/M)	M :	No.2085
Direction Set	:	No.2022
Velocity Pulse No	:	No.2023
Position Pulse No	:	No.2024
Ref counter	:	No.1821

- (ii) Specify all parameters on the screen above to complete the initial setting of servo parameters.

Specify each parameter according to the flowcharts shown below.

2. SETTING PARAMETER

(5) Setting parameters

(a) Flowchart 1

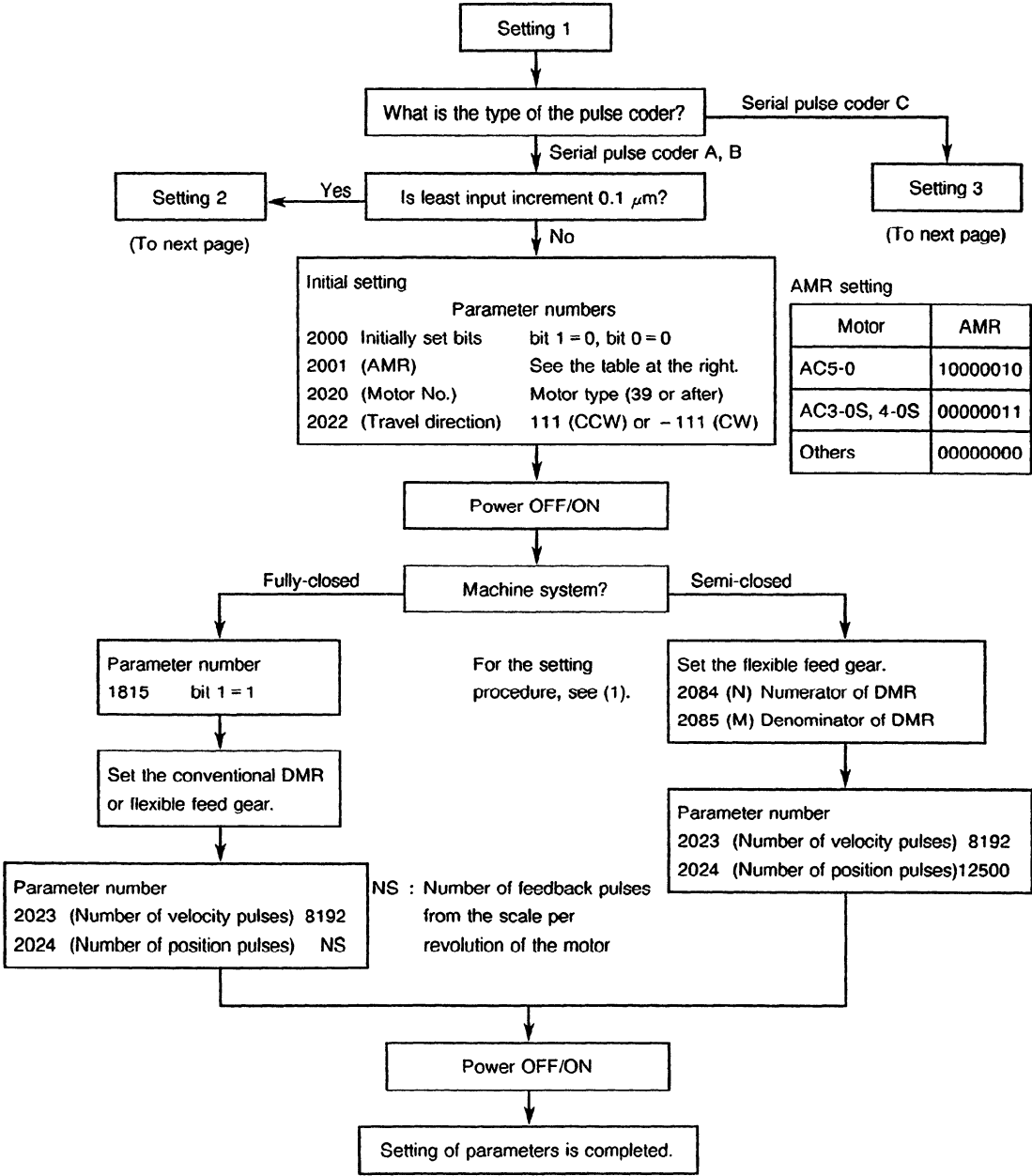

2. SETTING PARAMETER

(b) Flowchart 2

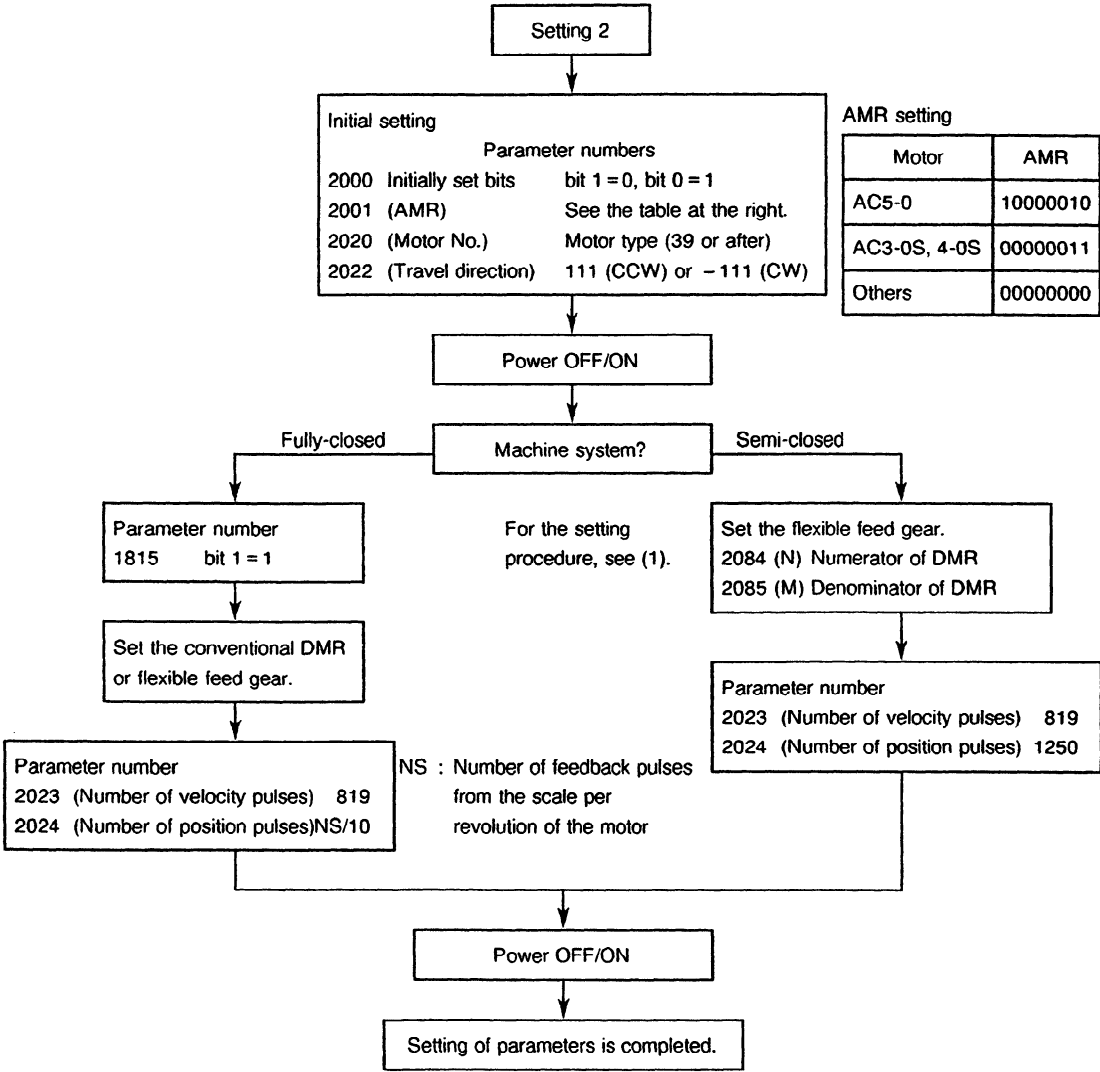

2. SETTING PARAMETER

(c) Flowchart 3

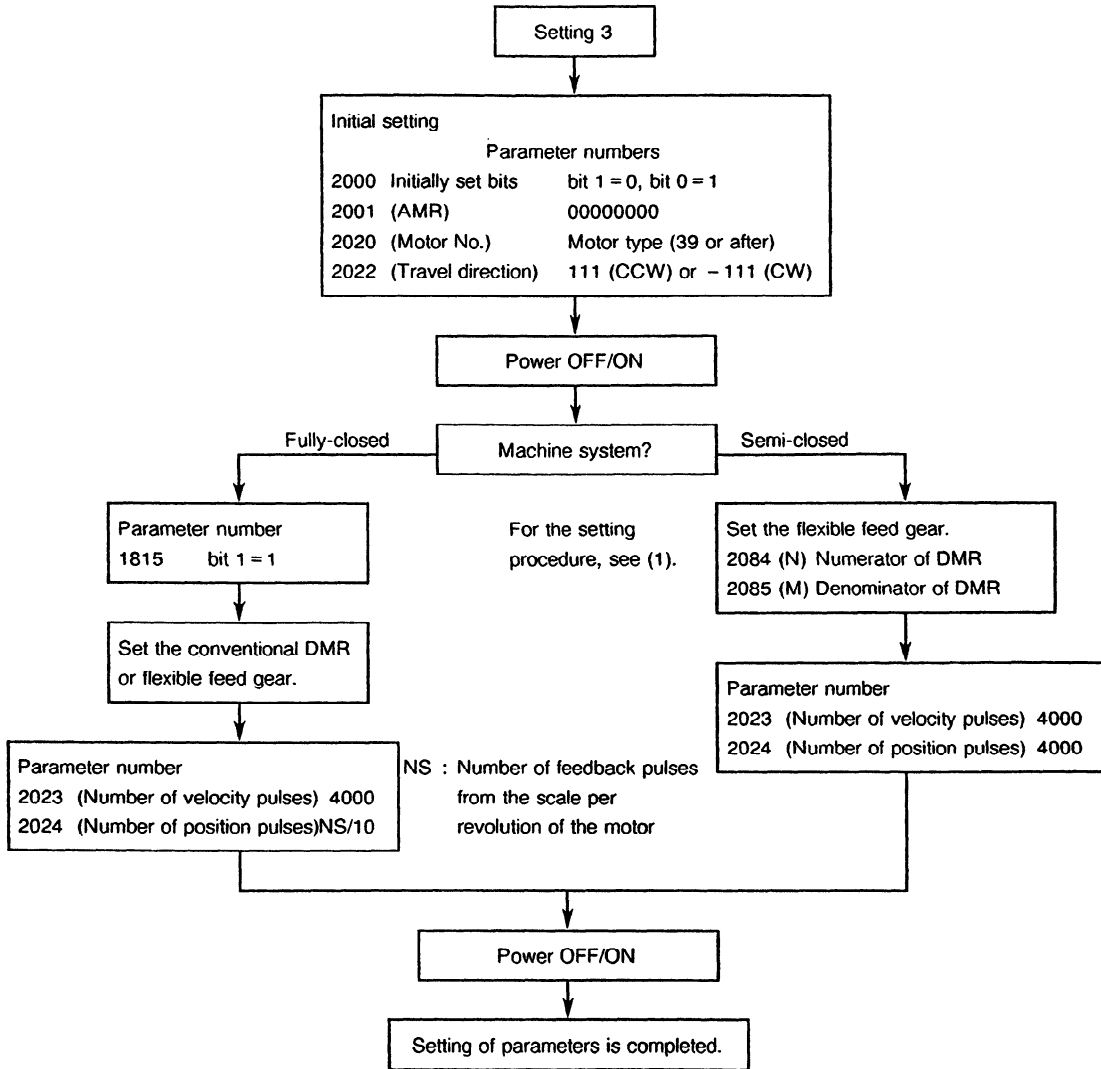

3. ADJUSTING PARAMETERS

(1) Enter the following from the NC keypad.

(i) Function key <SYSTEM> → [SYSTEM] → [▷] → [SV-TUN]

The following servo adjustment screen appears on the CRT.

Servo adjustment		01000 N0000	
X axis			
Func bit	00000000	Alarm 1	00000000
Loop gain	3000	Alarm 2	00000000
Tuning st	0	Alarm 3	00000000
Set period	0	Alarm 4	00000000
Int. gain	113	Alarm 5	00000000
Prop. gain	-1015	Loop gain	3000
Filter	0	Pos error	55555
Veloc gain	100	Current (%)	5
		Speed (rpm)	1000
(Value Setting)			

Fig. 3

Function bit	:	No.2003
Loop gain	:	No.1825
Tuning st	:	No.2009 bit 1
Set period	:	No.2079
Int. gain	:	No.2043
Prop. gain	:	No.2044
Filter	:	No.2067
Veloc gain	:	$\frac{\text{No.2021} + 256}{256} \times 100 (\%)$
Alarm 1	:	DGN No.200
Alarm 2	:	DGN No.201
Alarm 3	:	DGN No.202
Alarm 4	:	DGN No.203
Alarm 5	:	DGN No.204
Loop gain	:	The actual servo loop gain is indicated.
Pos error	:	The axis error is indicated. DGN No.300
Current (%)	:	The current value of the axis is indicated as a percentage of the rated current.
Speed (rpm)	:	The actual motor speed is indicated.

3. ADJUSTING PARAMETERS

(2) On this screen, check that no alarms are issued. While monitoring the value of position error, adjust the velocity gain, integral gain, and proportional gain according to the load of the machine.

(Note) When only a motor is connected, the velocity gain is 100%. When the load inertia is equal to the motor inertia, adjust the velocity gain to 200%.
See chapter I-8 and sec. II-2.9 for adjustment method.

4. ANALYZING ALARM CAUSES

- (1) When the following message is displayed on the NC screen, check the bits of alarms 1 and 5 on the servo adjustment screen: 414 AXIS DETECT ERR.

One of the following bits must be turned on.

	B7	B6	B5	B4	B3	B2	B1	B0
Alarm 1	OVL	LVAL	OVC	HCAL	HVAL	DCAL	FBAL	OFAL

- OFAL : An overflow occurs in the digital servo.
- DCAL : A regenerative discharge alarm has been detected in the servo amplifier. Check the LED for the servo amplifier.
- HVAL : An overvoltage alarm has been detected in the servo amplifier. Check the LED for the servo amplifier.
- HCAL : An abnormal current alarm has been detected in the servo amplifier. Check the LED for the servo amplifier.
- OVC : An overcurrent alarm has been detected in the digital servo.
- LVAL : An insufficient voltage alarm has been detected in the servo amplifier. Check the LED for the servo amplifier.

	B7	B6	B5	B4	B3	B2	B1	B0
Alarm 5		OFSTER	MCCALM					

- OFSTER : A current conversion error has occurred in the digital servo. Replace the Axis PC board in the NC machine.
- MCCALM : A magnetic contactor contact in the servo amplifier has welded. Check the LED for the servo amplifier.

- (2) When the following message is displayed on the NC screen, check the bits of alarms 1 and 2 on the servo adjustment screen: 400 AXIS OVER LOAD, or 416 AXIS DISCONNECT.

First check the bits of alarm 1.

	B7	B6	B5	B4	B3	B2	B1	B0
Alarm 1	OVL	LVAL	OVC	HCAL	HVAL	DCAL	FBAL	OFAL

When the "400 AXIS OVER LOAD" message is displayed, bit 7 is set to 1.
 When the "416 AXIS DISCONNECT" message is displayed, bit 1 is set to 1.

To examine the alarm cause, check the bits of alarm 2.

	B7	B6	B5	B4	B3	B2	B1	B0
Alarm 2	ALDF			EXPC				

4. ANALYZING ALARM CAUSES

The bits of alarms 1 and 2 indicate one of the alarm causes listed in the table below:

Alarm cause	Alarm 1		Alarm 2	
	Bit 7 OVL	Bit 2 FBAL	Bit 4 ALDF	Bit 2 EXPC
Motor overheated	1	0	1	0
Amplifier overheated	1	0	0	0
Built-in pulse coder disconnected (hardware)	0	1	1	0
Separate pulse coder disconnected (hardware)	0	1	1	1
Pulse coder disconnected (software)	0	1	0	0

Example: When the DISCONNECT alarm is issued and bit 7 of alarm 2 is set to 1 (alarm 2: 10000000), the built-in pulse coder is disconnected in hardware.

- (3) When the following message is displayed on the NC screen, check the bits of alarms 3 and 5 on the servo adjustment screen: 350 SPC ALARM.

	B7	B6	B5	B4	B3	B2	B1	B0
Alarm 3		CSAL	BLAL	PHAL	RCAL	BZAL	CKAL	SPHAL

- CSAL : The serial pulse coder is defective. Replace it.
- BLAL : The battery voltage is low. Replace the battery.
- PHAL : The serial pulse coder or feedback cable is defective. Replace the serial pulse coder or feedback cable.
- RCAL : The serial pulse coder is defective. Replace it.
- BZAL : The power has been supplied to the pulse coder for the first time. Turn the power off and check that the battery is connected. Then turn the power on and execute the return operation to the zero point.
- CKAL : The serial pulse coder is defective. Replace it.
- SPHAL : The serial pulse coder or feedback cable is defective. Replace the pulse coder or cable.

	B7	B6	B5	B4	B3	B2	B1	B0
Alarm 5				LDALM	PMALM			

- PMALM : A feedback pulse error has occurred because serial pulse coder C or the feedback cable is defective. Replace the pulse coder or cable.
- LDALM : The LED indicates that serial pulse coder C is defective. Replace it.

4. ANALYZING ALARM CAUSES

- (4) When the following message is displayed on the NC screen, check the bits of alarm 4 on the servo adjustment screen: 351 SPC ALARM.

	B7	B6	B5	B4	B3	B2	B1	B0
Alarm 4	DTERR	CRCERR	STBERR	PRMALM				

DTERR : A communication error occurred from the serial pulse coder because the pulse coder, feedback cable, or the circuit for receiving feedback signals is defective. Replace the pulse coder, feedback cable, or the Axis PC board in the NC machine.

CRCERR : A communication error occurred from the serial pulse coder because the pulse coder, feedback cable, or the circuit for receiving feedback signals is defective. Replace the pulse coder, feedback cable, or the Axis PC board in the NC machine.

STBERR : A communication error occurred from the serial pulse coder because the pulse coder, feedback cable, or the circuit for receiving feedback signals is defective. Replace the pulse coder, feedback cable, or the Axis PC board in the NC machine.

- (5) When the following message is displayed on the NC screen, check the bits of alarm 4 on the servo adjustment screen: 4□7 □AXIS DGTL PARAM.

	B7	B6	B5	B4	B3	B2	B1	B0
Alarm 4	DTERR	CRCERR	STBERR	PRMALM				

When bit 4 is set to 1:

- (Cause 1) No. 2084 is set 0, or No. 2085 is set to 0.
- (Action) Set a flexible feed gear in No. 2084 or No. 2085.
- (Cause 2) The velocity loop period is set to 2 msec (No.2004 bit 1 = 0).
- (Action) Initialize the all-axis motor type number (No. 2020) to 39 or greater.
- (Cause 3) When bit 0 of No. 2000 is set to 1, No. 2047 (POA1) may overflow.
- (Action) Set No. 2047 to 0. (Note, however, that the observer function is disabled.)
- (Cause 4) A position gain exceeding the allowable setting range may have been set.
- (Action) Enable the position gain setting range extension function (No. 2047 bit 4 = 1).
- (Cause 5) When bit 0 of No. 2000 is set to 1, the value set in No. 2024 is 13100 or greater.
- (Action) See the note below.

When bit 4 is set to 0:

- The setting of No.2020 is invalid.
- The setting of No.2023 is invalid.
- The setting of No.2024 is invalid.
- The setting of No.2022 is invalid.
- An overflow occurred during parameter calculation.
Check the parameter values and bit 0 of No. 2000.

4. ANALYZING ALARM CAUSES

- The setting of parameter No. 1023 for axis selection is invalid. In particular, when two pairs of X and Z are involved as in the case of the TT system, be careful not to assign the same numbers to X and Z on the main side and X and Z on the sub side.

Example 1) Main X : 1
 Z : 2
 Sub X : 1 In this case, an alarm occur.
 Z : 2

Example 2) Main X : 1
 Z : 2
 Sub X : 5 In this case, no alarm occurs.
 Z : 6

(Note 1) When bit 0 of No. 2000 is set to 1 and the setting of No. 2024 is 13100 or greater, change the servo parameters according to the flow described below.

No. 2023	Number of velocity pulses	Current setting/E
No. 2024	Number of position pulses	Current setting/E

E represents a value that causes the current setting of No. 2024 divided by E to be 13100 or less.

No. 2043	Current setting/E
No. 2044	Current setting/E
No. 2047	Current setting × E
No. 2053	Current setting × E
No. 2054	Current setting/E
No. 2056	Current setting/E
No. 2057	Current setting/E
No. 2074	Current setting × E
No. 2076	Current setting × E

Turn the power off, then turn it on again.

End of changing the parameter settings

5. CHECK BOARD

(1) Location of signal output

In the conventional pulse coder and the serial pulse coder, TSA signals are output to different pins as shown below. Other signals are output to identical pins.

[Conventional pulse coder]

Check pin	TSAL	TSAM	CH1	CH2	CH3	CH4	CH5	CH6
Signal	TSA	TSA	VCMD	TCMD	VCMD	TCMD	×	×
	L axis	M axis	L axis	L axis	M axis	M axis		

[Serial pulse coders A, B, and C]

Check pin	TSAL	TSAM	CH1	CH2	CH3	CH4	CH5	CH6
Signal	×	×	VCMD	TCMD	VCMD	TCMD	TSA	TSA
			L axis	L axis	M axis	M axis	L axis	M axis

(2) Converting the VCMD waveform

On the diagnostic board, one of the following four magnification rates can be selected for the VCMD waveform.

Note that with Series 9050, editions F and later, the VCMD waveform conversion of serial pulse coder C is the same as that of serial pulse coders A and B.

[Serial pulse coders A and B for semi-closed loop with Series 9050, editions earlier than F]

No.2012		Semi-closed loop
bit 5	bit 4	Speed specified by velocity command/5 V
0	0	0.9155 rpm/5 V
0	1	14 rpm/5 V
1	0	234 rpm/5 V
1	1	3750 rpm/5 V

5. CHECK BOARD

[Serial pulse coder C with Series 9050, editions earlier than F]

No.2012		Semi-closed loop, closed loop
bit 5	bit 4	Speed specified by velocity command/5 V
0	0	96 rpm/5 V
0	1	384 rpm/5 V
1	0	1536 rpm/5 V
1	1	6144 rpm/5 V

[Serial pulse coders A, B, and C for closed loop with Series 9050, editions earlier than F]

No.2012		Closed loop
bit 5	bit 4	Speed specified by velocity command/5 V
0	0	468 rpm/5 V
0	1	1875 rpm/5 V
1	0	7500 rpm/5 V

[Serial pulse coders A, B, and C with Series 9050, editions F and later]

No.2012		Semi-closed loop, closed loop
bit 5	bit 4	Speed specified by velocity command/5 V
0	0	0.9155 rpm/5 V
0	1	14 rpm/5 V
1	0	234 rpm/5 V
1	1	3750 rpm/5 V

(3) Converting the TSA waveform

[Serial pulse coders A and B]
3750 rpm/5 V

[Serial pulse coder C]
3840 rpm/5 V

Note that with Series 9050, editions F and later, the TSA waveform conversion of serial pulse coder C is the same as that of serial pulse coders A and B.

(4) Converting the TCMD waveform

No changes have been made to the conventional system.

5. CHECK BOARD

(5) Configuration of the diagnostic board of the Series 16

When the diagnostic board is used with the Series 16, the conventional diagnostic board, cable (with keyed connector), and an adapter are required.

As shown below, signals for the diagnostic board of the Series 16 and analog signals for controlling the spindle are output to identical connectors on the Adapter PC board.

For details of adapters, refer to the operator's manual of the Series 16. The following is a description of item, relating to the diagnostic board taken from this manual.

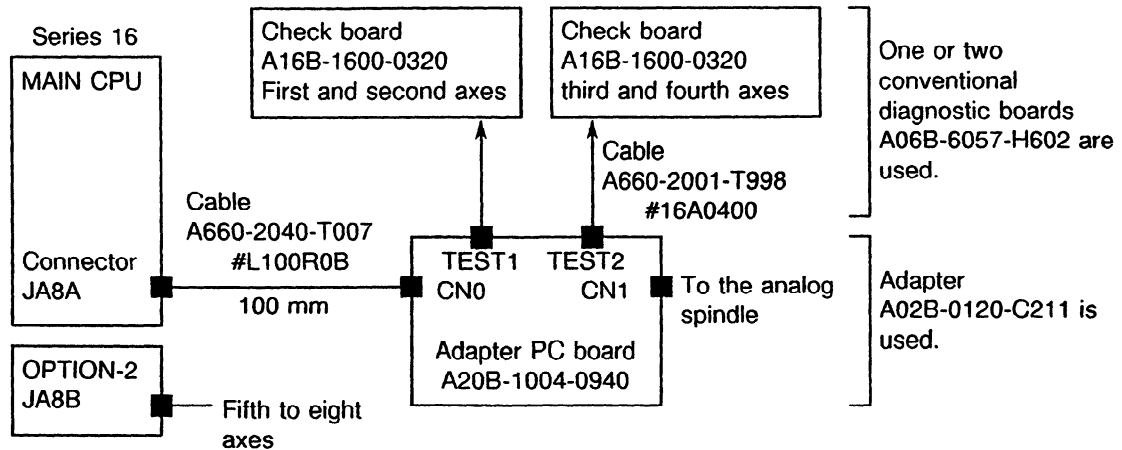

Specifications of the diagnostic board and adapter

No.	Name and parts/attachments included
A06B-6057-H602	Check board with a connector having a key for preventing reverse insertion Printed circuit board A16B-1600-0320 Cable A660-2001-T998#16A0400 (The cable has a connector with a key for preventing reverse insertion on both ends.)
A02B-0120-C211	Adapter (Required only for the Series 16) Adapter PC board A20B-1004-0940 Adapter cable A660-2040-T007#L100R0B (The cable is used to connect the Series 16 and adapter PCB.)

6. PARAMETERS

(1) Symbols, addresses, and setting ranks of the parameters of the digital servo

Symbol	Series 16	Rank	Description of parameter
PLC01	No.2000 bit 0	*A	High-resolution bit
OPTx	No.1815 bit 1	*A	Separated detector enabled/disabled
AMR	No.2001	*A	AMR setting for pulse coder
MTRID	No.2020	*A	Motor type
LDINT	No.2021	*A	Load inertia ratio
DIRCTL	No.2022	*A	Direction of motor rotation
PULCO	No.2023	*A	Number of feedback pulses for velocity detection
PPLS	No.2024	*A	Number of feedback pulses for position detection
SDMR1	No.2984	*A	Numerator of flexible feed gear
SDMR2	No.2085	*A	Denominator of flexible feed gear
PGEXPD	No.2000 bit 4	*B	Position gain setting range extension function
TGALRM	No.2003 bit 1	*B	Detection level for software disconnection alarm
OBENBL	No.2003 bit 2	*B	Observer function
PIENBL	No.2003 bit 3	*B	Changeover between IP and PI
1PSPRS	No.2003 bit 4	*B	One-pulse suppress function
BLENBL	No.2003 bit 5	*B	Backlash acceleration function
OVSCMP	No.2003 bit 6	*B	Overshoot prevention function
VOFST	No.2003 bit 7	*B	VCMD offset function
FEEDFD	No.2005 bit 1	*B	Feed forward function
BRKCTL	No.2005 bit 6	*B	Gravity-axis brake control function
FCBLCM	No.2006 bit 0	*B	Fully-closed backlash bit
PKVER	No.2006 bit 2	*B	Current loop gain variable with velocity
MODEL ACCFB	No.2006 bit 4	*B	1-ms acceleration feedback function
DCBEMF	No.2006 bit 6	*B	Bit for back electromotive force compensation during deceleration
SERDMY	No.2009 bit 0	*B	Serial dummy function
ADBLSH	No.2009 bit 2	*B	New backlash acceleration function
BLCUT	No.2009 bit 6	*B	Bit for backlash acceleration during cutting
BLSTP	No.2009 bit 7	*B	Backlash acceleration stop function
BLTEN	No.2010 bit 3	*B	Tenfold backlash acceleration function
POLENB	No.2010 bit 7	*B	Punch/laser switching mode
FVELFB	No.2012 bit 1	*B	Machine velocity feedback function
VCMD1	No.2012 bit 4	*B	VCMD output variable bit
VCMD2	No.2012 bit 5	*B	VCMD output variable bit
PGTWNB	No.2015 bit 0	*B	Position gain switching function
SSG1	No.2015 bit 1	*B	Integration function for low speed
DPFBCT	No.2019 bit 7	*B	Dual position feedback function
TWNSP	No.2028	*B	Velocity enabling position gain switching
INTSP1	No.2029	*B	Velocity enabling integration for low speed (acceleration)

6. PARAMETERS

Symbol	Series 16	Rank	Description of parameter
INTSP2	No.2030	*B	Velocity enabling integration for low speed (deceleration)
PK1V	No.2043	*B	Velocity loop gain
PK2V	No.2044	*B	Velocity loop gain
PK3V	No.2045	*B	Imperfect integration coefficient
BLCMP	No.2048	*B	Backlash compensation acceleration parameter
DPFMXL	No.2049	*B	Maximum dual position feedback amplitude
TGALMLV	No.2064	*B	TG alarm level
PK2VAUX	No.2066	*B	Compensation torque command function
FILTER	No.2067	*B	Torque command filter
FALPH	No.2068	*B	Feed forward coefficient
VFFLT	No.2069	*B	Feed forward coefficient
ERBLM	No.2070	*B	Backlash compensation acceleration parameter
PBLCT	No.2071	*B	Backlash compensation acceleration parameter
AALPH	No.2074	*B	Current loop gain variable with velocity
WKAC	No.2076	*B	Acceleration feedback gain
OSCTP	No.2077	*B	Overshoot prevention counter
DPFMXL	No.2078	*B	Dual position feedback conversion coefficient (numerator)
DPFMXL	No.2079	*B	Dual position feedback conversion coefficient (denominator)
DPFMXL	No.2080	*B	Dual position feedback time constant
DPFMXL	No.2081	*B	Dual position feedback zero width
BLEND	No.2082	*B	Backlash acceleration stop amount
BLEND	No.2082	*B	Backlash acceleration stop amount
MOFCT	No.2083	*B	Gravity-axis brake control timer
TCPRLD	No.2087	*B	Backlash acceleration torque offset
MCNFB	No.2088	*B	Machine velocity feedback gain
BLBSL	No.2089	*B	Base pulse for backlash acceleration
ACCSPL	No.2091	*B	Nonlinear control function
ADFF1	No.2092	*B	Advanced feed-forward coefficient
ONEPSL	No.2099	*B	One-pulse suppression for serial pulse coders A and B
PRMCAL	No.2000 bit 3	*C	Servo parameter calculation bit
PFSEL	No.2002 bit 3	*C	Separated detector bit
TINA0	No.2004 bit 0	*C	
TINB0	No.2004 bit 1	*C	
TRW0	No.2004 bit 2	*C	
TRW1	No.2004 bit 3	*C	
DLY0	No.2004 bit 6	*C	
DLY1	No.2004 bit 7	*C	
PK1	No.2040	*C	Current loop gain
PK2	No.2041	*C	Current loop gain

6. PARAMETERS

Symbol	Series 16	Rank	Description of parameter
PK3	No.2042	*C	Current loop gain
PK4V	No.2046	*C	Velocity loop gain
POA1	No.2047	*C	Velocity control observer parameter
POK1	No.2050	*C	Velocity control observer parameter
POK2	No.2051	*C	Velocity control observer parameter
PPMAX	No.2053	*C	Current dead-zone compensation
PDDP	No.2054	*C	Current dead-zone compensation
PHYST	No.2055	*C	Current dead-zone compensation
EMFCMP	No.2056	*C	Back electromotive force compensation
PVPA	No.2057	*C	Current phase control
PALPH	No.2058	*C	Current phase control
EMFBAS	No.2059	*C	Back electromotive force compensation
TQLIM	No.2060	*C	Torque limit
EMFLMT	No.2061	*C	Back electromotive force compensation
POVC1	No.2062	*C	Overload protection coefficient
POVC2	No.2063	*C	Overload protection coefficient
POVCLMT	No.2065	*C	Overload protection coefficient
RTCURR	No.2086	*C	Rated current parameter
DEPVPL	No.2098	*C	Phase advancement compensation for deceleration

*A rank : The parameter must be set and adjusted by the machine tool builder.

*B rank : The parameter is set automatically, but can be adjusted as required.

*C rank : The parameter is set automatically and must not be changed.

(2) Executing 0.1- μ m control

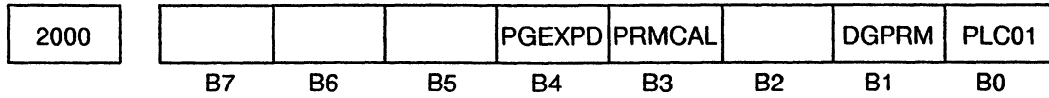

Turn on the option parameter for 0.1- μ m control and set PLC01 (bit 0 of parameter 2000, Series 16) to 1. This parameter cannot be used to execute 0.1- μ m control of each axis.

When the setting described above is made, the magnitude of the following two parameters will be changed:

No.2023: Setting value \times 10: Number of velocity feedback pulses (unit: number of pulses)

No.2024: Setting value \times 10: Number of position feedback pulses (unit: number of pulses)

In the Series 15 and Series 0-C, the magnitude of additional parameters is changed. In the Series 16, only the magnitude of these two parameters is changed.

(3) Using fully-closed feedback (separate detector)

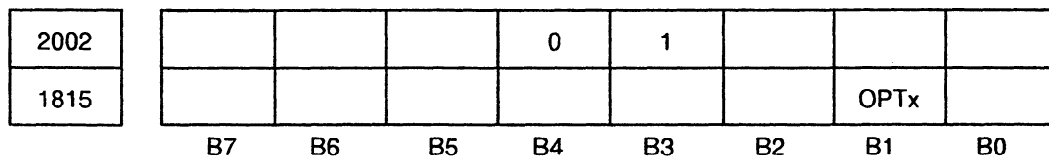

OPTx : A separate detector for position detection is :
 0 : Not used
 1 : Used

The AC servo motor contains a pulse coder for detecting speed. It is recommended that the machine be driven with the built-in pulse coder. Check the operation of the machine before driving it with the separate detector.

When a separate detector is used, two parameters must be changed: the parameter for setting use of a separate detector (described above) and No.2024 (Series 16) for setting the number of position detection pulses per revolution of the motor.

(4) Simplifying the setting of servo parameters

Parameter No.	Parameter							
2000				PGEXPD	PRMCAL		DGPRM	PLC01
	B7	B6	B5	B4	B3	B2	B1	B0
Standard setting:	0	0	0	0	1	0	1	0

Series 16 and Series 18 set bit 3 of No. 2000 to 1. The bit is used to execute automatic calculation of servo parameters. Be sure not to change set value 1. It is automatically specified when the power is turned on.

When the bit is set to 1, the following parameters are automatically calculated according to the number of pulses of the pulse coder.

- No. 2043 : Velocity loop gain (PK1V)
- No. 2044 : Velocity loop gain (PK2V)
- No. 2047 : Velocity control observer parameter (POA1)
- No. 2053 : Current dead-zone compensation (PPMAX)
- No. 2054 : Current dead-zone compensation (PDDP)
- No. 2056 : Back electromotive force compensation (EMFCMP)
- No. 2057 : Current phase control (PVPA)
- *No. 2059 : Back electromotive force compensation (EMFBAS)
- *No. 2074 : Current loop gain variable with velocity (AALPH)
- *No. 2076 : Acceleration feedback gain (WKAC)

An asterisk (*) indicates a new parameter which has not been provided in the Series 0-C or Series 15.

These servo parameters are automatically calculated and must not be changed.

(5) Parameters

Parameter No.	Parameter							
2000				PGEXPD	PRMCAL		DGPRM	PLC01
	B7	B6	B5	B4	B3	B2	B1	B0
Standard setting:	0	0	0	0	1	0	1	0

PLC01 : In the system for which serial pulse coder A is used, 0.1- μ m control is:
 1 : Executed
 0 : Not executed
 (Note) This parameter cannot be used for 0.1- μ m control of each axis.
 Serial pulse coder C is:
 1 :Used
 0 :Not used

DGPRM : When the power is turned on, the digital servo parameters of the motor to be used are:
 1 : Set
 0 : Not set
 When the parameter is set to 0 after specifying a motor type, the standard values for the motor are automatically set in the corresponding parameters. Then this parameter is automatically set to 1.

PRMCAL: This bit is used for calculation of servo parameters. Be sure not to change the standard setting of 1.

PGEXPD: The position gain setting range extension function is:
 0 : Not used
 1 : Used
 (This provision is available with Series 9050, editions B and later.)
 (For detailed information, see Section 7.5.1 in Part I.)

2001	AMR7	AMR6	AMR5	AMR4	AMR3	AMR2	AMR1	AMR0
	B7	B6	B5	B4	B3	B2	B1	B0

AMR7 to AMR0 : These values must be specified according to the motor to be used.

When serial pulse coder A or B is used:

Applicable motor type	B7	B6	B5	B4	B3	B2	B1	B0
AC5-0	1	0	0	0	0	0	1	0
AC4-0S, AC3-0S	0	0	0	0	0	0	1	1
AC2-0S or later	0	0	0	0	0	0	0	0

6. PARAMETERS

When serial pulse coder C is used:

Bit arrangement	B7	B6	B5	B4	B3	B2	B1	B0
All motors	0	0	0	0	0	0	0	0

Parameter No.	Parameter							
2002					PFSEL			
	B7	B6	B5	B4	B3	B2	B1	B0
Standard setting:	0	0	0	0	0	0	0	0
2003	VOFST	OVSCMP	BLENBL	1PSPRS	PIENBL	OBENBL	TGALRM	
	B7	B6	B5	B4	B3	B2	B1	B0
Standard setting:	0	0	0	0	0	0	0	0

TGALRM : The alarm detection level for motor rotation without feedback is:

0 : Set to the standard value.

1 : Reduced to the sensitivity separately specified.

Related parameter: 2064

OBENBL : The speed control observer is:

0 : Not used

1 : Used

Related parameters: 2047, 2050, and 2051

The speed control observer cannot be used for the model 3-0, 4-0, or 5-0 motor.

PIENBL : Speed control is set to:

0 : IP

1 : PI

1PSPRS : When the direction is reversed in speed control, one pulse is:

0 : Not suppressed

1 : Suppressed

BLENBL : In speed control, backlash compensation is:

0 : Not improved

1 : Improved

Related parameter: 2048

OVSCMP : Overshoot compensation is:

0 : Invalidated

1 : Validated

Related parameter: 2045

VOFST : VCMD is:

0 : Not offset

1 : Offset

6. PARAMETERS

Parameter No.	Parameter							
2004			TRW1	TRW0	TINA1	TINA0	TINB1	TINB0
	B7	B6	B5	B4	B3	B2	B1	B0
Standard setting:	0	1	0	0	0	1	1	0

When the power is turned on with DGPRM set to 0, the standard value is set in this parameter.
The standard value must not be changed.

2005		BRKCTL					FEEDFD	
	B7	B6	B5	B4	B3	B2	B1	B0
Standard setting:	0	0	0	0	0	0	0	0

FEEDFD : The feed forward function is:
 0 : Invalidated
 1 : Validated
 Related parameters: 2068, 2069

BRKCTL : The vertical-axis brake control function is:
 0 : Invalidated
 1 : Validated
 Related parameter: 2083

2006		DCBEMF		MODEL ACCFB		PKVER		FCBLCM
	B7	B6	B5	B4	B3	B2	B1	B0
Standard setting:	0	0	0	0	0	0	0	0

FCBLCM : In fully-closed feedback, backlash compensation pulses are:
 0 : Handled normally.
 1 : Not used for position compensation.
 Related parameter: 2048

In fully-closed feedback, backlash compensation is not usually set because it will cause a deviation in position. When FCBLCM and BLENBL are set to 1, a protrusion is reduced without causing a deviation in position.

PKVER : The function of current loop gain variable with velocity is:
 0 : Invalidated
 1 : Validated
 Related parameter: 2074

MODEL ACCFB : The 1-ms acceleration feed back function is:
 0 : Invalidated
 1 : Validated
 Related parameter: 2076

6. PARAMETERS

DCBEMF : At deceleration, back electromotive force compensation is:
 0 : Invalidated
 1 : Validated

Parameter No.	Parameter							
2009	BLSTP	BLCUT				ADBLSH		SERDMY
	B7	B6	B5	B4	B3	B2	B1	B0
Standard setting:	0	1	0	0	0	0	0	0

SERDMY : The serial pulse coder feedback dummy function is:
 0 : Invalidated
 1 : Validated
 (This capability is available with Series 9050, editions D and later.)

ADBLSH : The new backlash acceleration function is:
 0 : Invalidated
 1 : Validated
 Related parameters: 2048, 2087

BLCUT : The function that validates the backlash acceleration function only at cutting is:
 0 : Invalidated
 1 : Validated

BLSTP : The backlash acceleration stop function is:
 0 : Invalidated
 1 : Validated
 Related parameters: 2066, 2082

2010	POLENB				BLTEN			
	B7	B6	B5	B4	B3	B2	B1	B0
Standard setting:	0	0	0	0	0	0	0	0

BLTEN : The function to multiply the backlash acceleration amount by 10 (for a high-resolution pulse coder) is:
 0 : Invalidated
 1 : Validated
 Related parameter: 2048

POLENB : The punch/laser switching function is:
 0 : Invalidated
 1 : Validated
 (This capability is available with Series 9050, editions D and later.)

6. PARAMETERS

Parameter No.	Parameter							
2012			VCMD2	VCMD2			FVELFB	
	B7	B6	B5	B4	B3	B2	B1	B0
Standard setting:	0	0	0	0	0	0	0	0

FVELFB : The machine velocity feedback function is:
 0 : Invalidated
 1 : Validated
 Related parameter: 2088

VCMD1, VCMD2 : The output magnification rate for the VCMD waveform is set as shown below:

Serial pulse coders A, B, and C after 9050 series F version

VCMD2	VCMD1	Spindle speed/5V, specified by a velocity command
0	0	0.9155 rpm/5V
0	1	14 rpm/5V
1	0	234 rpm/5V
1	1	3750 rpm/5V

See Section 5.(2) for information about the VCMD waveform conversion of serial pulse coder C with Series 9050, editions earlier than F.

2015							SSG1	PGTWN
	B7	B6	B5	B4	B3	B2	B1	B0
Standard setting:	0	0	0	0	0	0	0	0

PGTWN : The position gain switching function is:
 0 : Invalidated
 1 : Validated
 (This capability is available with Series 9050, editions D and later.)
 Related parameter: 2028

SSG1 : The integration function for low speed is:
 0 : Invalidated
 1 : Validated
 (This capability is available with Series 9050, editions D and later.)
 Related parameters: 2029, 2030

6. PARAMETERS

Parameter No.	Parameter							
2019	DPFBCT							
	B7	B6	B5	B4	B3	B2	B1	B0
Standard setting:	0	0	0	0	0	0	0	0

DPFBCT : The dual position feedback function is:
 0 : Invalidated
 1 : Validated
 (This capability is available with Series 9050, editions F and later.)
 Related parameters: 2049, 2078, 2079, 2080, 2081

2020	Motor type
------	------------

The digital servo ROM holds the standard parameters for each motor model. When DGPRM is set to 0, the standard values of the motor to be used are set at power on. The data range of the ROM depends on the ROM version.

9050A or later : 39 to 83

9050E or later : 39 to 84

When the data range is exceeded, an alarm will be issued.

Drawing No. of an amplifier with 185-V input (A06B-6057-HXXX)

Motor type	42	54	56	57	58	59	60
Drawing No. of motor	0531	0506	0561	0562	0564	0571	0572
Motor model	5-0	30/2000	0L	5L	6L	7L	10L

Drawing No. of an amplifier with input of 200 to 230-V
 (A06B-6058-H00X, -H22X, -H32X, -H33X)

Motor type	43	44	45	46	47	48	49
Drawing No. of motor	0532	0533	0310	0312	0313	0314	0316
Motor model	4-0S	3-0S	2-0S	1-0S	0S	5S	6S

Motor type	50	51	52	53	80	82
Drawing No. of motor	0315	0505	0502	0590	0382	0384
Motor model	10S	20S/1500	20S	30S	5T	10T

6. PARAMETERS

Drawing No. of an amplifier for a large-scale motor with input of 200 to 230-V
(A06B-6058-H101, -H102)

Motor type	39	40	41
Drawing No. of motor	0331	0332	0333
Motor model	50S	60S	70S

Drawing No. of an amplifier for a high-speed motor with input of 200 to 230-V
(A06B-6058-H00X)

Motor type	61	62	63	64	65	66
Drawing No. of motor	0310	0309	0313	0514	0317	0318
Motor model	2-0S	1-0S/3000	0S	5S/3000	10S/3000	20S/3000

Motor type	67	73	78	79	81	83	84
Drawing No. of motor	0319	0320	0583	0381	0383	0385	0374
Motor model	30S/3000	6S/3000	40S/2000	0T/3000	5T/3000	10T/3000	0-0SP

Drawing No. of amplifier for an L Series high-speed motor
(A06B-6057-HXXX) (A06B-6066-HXXX)

Motor type	68 (56)	69 (57)	70 (58)	71 (59)	72 (60)
Drawing No. of motor	0561	0562	0564	0571	0572
Motor model	0L (3000)	5L (3000)	6L (2000)	7L (3000)	10L (2250)

The motor type numbers in parentheses are applicable when the C Series amplifier is used with Series 9050, editions I and later. (See Note 3.)

(Note 1) In servo ROM of Series 9050, the standard velocity loop period is 1 ms. When one of the motor types listed above is specified, the velocity loop period is set to 1 ms at startup.

(Note 2) Motor type Nos. 74 to 77 are special parameters for piston lathes. They should not be used.

(Note 3) Series 9050, editions I and later allow the L Series high-speed motors (AC0L to 10L) to be driven with the C Series amplifier. When using this capability, be sure to select the motor type numbers 56 to 60.

6. PARAMETERS

Parameter No. _____ Parameter _____

2021

Load inertia ratio (LDINT)

The ratio of the load inertia of the machine to the rotor inertia of the motor is calculated according to the following expression. The value obtained from the expression is set.

$$\text{Load inertia ratio} = \frac{\text{Load inertia of the machine}}{\text{Rotor inertia of the motor}} \times 256$$

Data range : 0 to 32767

Example : When the motor model is 10 ($J_m = 0.10$) and the machine inertia is 0.05 ($J_1 = 0.05$)

$$\text{Setting value} = \frac{0.05}{0.10} \times 256 = 128$$

When this parameter is set, the PK1V and PK2V velocity loop gains are multiplied by $(1 + LDINT/256)$.

2022

Rotation direction of the motor (DIRCTL)

DIRCTL : The rotation direction of the motor is set.

- 111 : Normal connection (clockwise rotation, viewed from the detector)
- 111 : Reverse connection (counterclockwise rotation, viewed from the detector)

If any other value is set, an alarm will be issued.

2023

Number of feedback pulses for velocity detection (PULCO)

Data unit : Pulse/rev.

Data range : 1 to 32767

When serial pulse coder A or B is built into the motor : 8192 (PLC01 is set to 0.)

When serial pulse coder A or B is built into the motor : 819 (PLC01 is set to 1.)

When serial pulse coder C is built into the motor : 4000 (PLC01 is set to 1.)

6. PARAMETERS

Parameter No.	Parameter
2024	Number of feedback pulses for position detection (PPLS)

Data unit : Pulse/rev.

Data range : 1 to 32767

If a value of zero or smaller is set in this parameter, an alarm will be issued.

When a separate detector is not used:

For serial pulse coder A or B : 12500 (PLC01 is set to 0.)

For serial pulse coder A or B : 1250 (PLC01 is set to 1.)

For serial pulse coder C : 4000 (PLC01 is set to 1.)

When a separate detector is used:

The value set in this parameter is the number of pulses per revolution of the motor of the detector used for position feedback. The number of pulses must be calculated under the assumption that the number of pulses is four for one pulse cycle of phases A and B. The setting value is not affected by DMR or CMR.

Example 1: When a 1- μm optical scale is used and machine movement is 5 mm per revolution of the motor

Setting value : 5000

Example 2: When a 0.5- μm optical scale is used and machine movement is 10 mm per revolution of the motor

Setting value : 20000

Example 3: When a 0.1- μm optical scale is used and machine movement is 1 mm per revolution of the motor

Setting value : 10000

(Note) Even when a 0.1- μm position detector is used, PLC01 must be set to 0 if the setting value does not exceed 32767. (When the setting value exceeds 32767, see example 4 below.)

Example 4: When a 0.1- μm optical scale is used and machine movement is 4 mm per revolution of the motor

Setting value : 4000 (PLC01 is set to 1)

(Note) Because PLC01 is set to 1, PULCO must be set to one-tenth of the calculated value. When the 0.1- μm position detector is used and the resolution of the pulse coder of the motor is greater than 0.1 μm , position variation at stop will be greater than 0.1 μm . To prevent this from happening, the resolution of the pulse coder of the motor must be smaller than that of the position detector. In this case, use a high-resolution pulse coder.

6. PARAMETERS

Example 5: When a 2 mm/1 λ Inductosyn is used with an A/D converter of 4000 P/1 λ and machine movement is 8 mm per revolution of the motor
Setting value : 16000

Example 6: When a rotary Inductosyn of 360 λ per revolution (720 poles) is used with an A/D converter of 4000 P/1 λ for two degrees per revolution of the motor (gear reduction ratio of 1/180)
Setting value : 8000

Example 7: When a rotary Inductosyn of 180 λ per revolution (360 poles) is used with an A/D converter of 4000 P/1 λ for six degrees per revolution of the motor (gear reduction ratio of 1/60)
Setting value : 12000

This parameter corresponds to the loop gain constant of the analog servo.

Parameter No.	Parameter
2028	Velocity enabling position gain switching (TWNSP)

Data range : 1 to 32767
Standard setting : 0

This parameter sets a maximum velocity that doubles the position gain.
(This provision is available with Series 9050, editions D and later.)
(For detailed information, see Section 3.7.3.)

2029	Acceleration-time velocity enabling integration function for low speed (INTSP1)
------	---

Data range : 1 to 32767
Standard setting : 0

This parameter sets a velocity that disables the integrator during acceleration.
(This capability is available with Series 9050, editions D and later.)
(For detailed information, see Section 3.7.3.)

2030	Deceleration-time velocity enabling integration function for low speed (INTSP2)
------	---

Data range : 1 to 32767
Standard setting : 0

This parameter sets a velocity that disables the integrator during deceleration.
(This capability is available with Series 9050, editions D and later.)
(For detailed information, see Section 3.7.3.)

6. PARAMETERS

Parameter No.	Parameter
---------------	-----------

2040	Current loop gain (PK1)
------	-------------------------

Data range : 1 to 32767

2041	Current loop gain (PK2)
------	-------------------------

Data range : - 1 to 32767

2042	Current loop gain (PK3)
------	-------------------------

Data range : - 1 to 32767

Standard setting : The standard vlaue set at power on.

These parameters set a current loop gain.

When DGPRM is set to 0, the standard values are set at power on.

2043	Integral velocity loop gain (PK1V)
------	------------------------------------

Data range : 1 to 32767

This parameter sets a low-speed velocity loop gain. When the value is increased, the rigidity, position accuracy and response are improved.

2044	Proportional velocity loop gain (PK2V)
------	--

Data range : - 1 to 32767

This parameter sets a high-speed velocity loop gain.

2045	Imperfect integration coefficient (PK3V)
------	--

Data range : 0 to 32767

Standard setting : 0

This parameter sets the coefficient of imperfect integration, which limits the rigidity of servo. The coefficient is set in the range 32600 to 32760. When the OVSCMP bit is on, the coefficient can be reduced to within 32000 to 20000.

6. PARAMETERS

Parameter No.	Parameter
---------------	-----------

2046	Velocity loop gain (PK4V)
------	---------------------------

Data range : - 1 to 32767
Standard setting : The standard value set at power on.

This parameter sets the velocity loop gain.

2047	Velocity control observer parameter (POA1)
------	--

Data range : 0 to 32767
Standard setting : The standard value set at power on.

2048	Coefficient of backlash acceleration (BLCMP)
------	--

Data range : 0 to 32767
Standard setting : 0

This parameter sets the amount of backlash compensation acceleration.

2049	Maximum dual position feedback amplitude (DPFML)
------	--

Data range : 0 to 32767
Standard setting : 0

(This provision is available with Series 9050, editions F and later.)
(For detailed information, see Section 2.3.5 in Part II.)

2050	Velocity control observation parameter (POK1)
------	---

Data range : 0 to 32767
Standard setting : The standard value set at power on.

2051	Velocity control observation parameter (POK2)
------	---

Data range : 0 to 32767
Standard setting : The standard value set at power on.

6. PARAMETERS

Parameter No.	Parameter
---------------	-----------

2052

Not used

Data range : 0 to - 32767

Standard setting : 0

(Note) The standard value set at power on.

2053

Current dead-zone compensation (PPMAX)
--

Data range : 0 to 32767

Standard setting : The standard value set at power on.

2054

Current dead-zone compensation (PDDP)

Data range : 0 to 32767

Standard setting : The standard value set at power on.

2055

Current dead-zone compensation (PHYST)
--

Data range : 0 to 32767

Standard setting : The standard value set at power on.

2056

Back electromotive force compensation (EMFCMP)
--

Data range : 0 to 32767

Standard setting : The standard value set at power on.

This parameter improves the current loop during high-speed rotation.

2057

Current phase control (PVPA)

Data range : 0 to 32767

Standard setting : The standard value set at power on.

2058

Current phase control (PALPH)

Data range : 0 to 32767

Standard setting : The standard value set at power on.

6. PARAMETERS

Parameter No.	Parameter
2059	Back electromotive force compensation (EMFBAS)

Data range : 0 to 32767
Standard setting : The standard value set at power on.

This parameter sets the minimum velocity at which back electromotive force is compensated. When DCBEMF (No 2006, bit 6 in Series 16) is set to 1, 10 must be set in this parameter.

2060	Torque limit (TQLIM)
------	----------------------

Data range : 0 to 32767
Standard setting : The standard value set at power on.

2061	Back electromotive force compensation (EMFLMT)
------	--

Data range : 0 to 32767
Standard setting : The standard value set at power on.

This parameter sets the limit of compensation for back electromotive force.

2062	Overload protection coefficient (OVC1)
------	--

Data range : 0 to 32767

This parameter sets the coefficient of the alarm for protecting the motor and transistor from overload.

2063	Overload protection coefficient (OVC2)
------	--

Data range : 0 to 32767

This parameter sets the coefficient of the alarm for protecting the motor and transistor from overload.

2064	TG alarm level (TGALMLV)
------	--------------------------

Data range : 1 to 32767
Standard setting : 4

6. PARAMETERS

This parameter sets the alarm detection level for motor rotation without receiving feedback. (Unit: 1/32 motor revolution) When backlash is 1/64 revolution or greater on the motor shaft in a machine with fully-closed feedback, the backlash amount is set. This parameter is validated only when bit 1, TGALRM, of No.2003 (Series 16) is set to 1.

Parameter No.	Parameter
2065	Overload protection coefficient (OVCLMT)

Data range : 1 to 32767
Standard setting : The standard value set at power on.

This parameter sets the coefficient of alarm for protecting the motor and transistor from overload.

2066	PK2VAUX
------	---------

Data range : 0 to 32767
Standard setting : 0

The function of this parameter depends on whether the value specified is positive or negative. If a positive value is specified, the compensation torque command function is validated. This function suppresses variations at stop. The value specified depends on the motor model. Usually, a value around 500,000/Np (Np is the number of pulses of the pulse coder) is specified. If the specified value is too large, oscillation will occur. The value specified must be as small as possible.

If a negative value is specified, the 250- μ s acceleration feedback function is validated. The value specified depends on the serial pulse coder, as shown below: See Section 7.1.

When serial pulse coder A or B is used : About - 10

When serial pulse coder C is used : About - 250

When the specified value is too large, oscillation may occur.

2067	Torque command filter (FILTER)
------	--------------------------------

Data range : 0 to 4096
Standard setting : 0

This parameter is used to eliminate the RF noise from the torque command. Coefficient one is represented by 4096.

6. PARAMETERS

Parameter No.	Parameter
2068	Forward-feed coefficient (FALPH)

Data range : 0 to 100

Standard setting : 0

This parameter sets the coefficient of forward-feed control.

$$(\text{SETTING VALUE}) = \alpha \times 100 (\%)$$

When α is 1, set the forward-feed control coefficient to 100%. See Section 7.2.

2069	Forward-feed filter coefficient (VFFLT)
------	---

Data range : 0 to 1600

Standard setting : 0

This parameter sets the coefficient of forward-feed control.

$$(\text{Setting value}) = \frac{\text{Load inertia} + \text{Rotor inertia}}{\text{Rotor inertia}} \times 100 (\%)$$

Set the coefficient according to the expression above. The value set may be slightly different from the value obtained by the expression, depending on the value set in PK2V (No.2044).

2070	Backlash compensation acceleration parameter (ERBLM)
------	--

Data range : 0 to 32767

Standard setting : 0

This parameter is used to synchronize backlash compensation acceleration when the rotation of the motor is reversed.

2071	Backlash compensation acceleration parameter (PBLCT)
------	--

Data range : 0 to 32767

Standard setting : 0

This parameter sets the number of compensations for backlash compensation acceleration. Acceleration is executed once more than the number of times indicated by the value set in this parameter.

6. PARAMETERS

Parameter No.	Parameter
2074	Current loop gain variable with velocity (AALPH)

Data range : 0 to 32767
Standard setting : The standard value set at power on.

This parameter enables the current loop gain to be varied according to the velocity. The current loop gain can be increased in high speed ranges.

2076	1-ms acceleration feedback gain (WKAC)
------	--

Data range : 0 to 32767
Standard setting : The standard value set at power on.

This parameter is used to give stability to the velocity loop. It determines the 1-ms acceleration feedback gain. To use this function, set velocity loop sampling to 1 ms and use the torque command filter.

2077	Overshoot prevention counter (OSCTPL)
------	---------------------------------------

Data range : 0 to 32767
Standard setting : 0

When the parameter of the overshoot prevention function, bit 6 (OVSCMPW) of No.2003 (Series 16), is set to 1, the motor may vibrate when stopped. Specify this parameter to prevent this.

2078	Dual position feedback conversion coefficient (numerator) (DPFCH1)
------	--

Data range : 0 to 32767
Standard setting : 0

(This provision is available with Series 9050, editions F and later.)
(For detailed information, see Section 2.3.5 in Part II.)

2079	Dual position feedback conversion coefficient (denominator) (DPFCH2)
------	--

Data range : 0 to 32767
Standard setting : 0

(This provision is available with Series 9050, editions F and later.)
(For detailed information, see Section 2.3.5 in Part II.)

6. PARAMETERS

Parameter No.	Parameter
2080	Dual position feedback primary delay time constant (DPFTC)

Data range : 0 to 32767

Standard setting : 0

(This provision is available with Series 9050, editions F and later.)

(For detailed information, see Section 2.3.5 in Part II.)

2081	Dual position feedback zero width (DPFZW)
------	---

Data range : 0 to 32767

Standard setting : 0

(This provision is available with Series 9050, editions F and later.)

(For detailed information, see Section 2.3.5 in Part II.)

2082	Backlash acceleration stop amount (BLENDL)
------	--

Data range : 0 to 32767

Standard setting : 0

When this parameter is specified, excessive compensation of backlash acceleration can be prevented.

2083	Gravity-axis brake control timer (MOFCTL)
------	---

Data unit : ms

Data range : 1 to 32767

Standard setting : 0

This parameter sets the delay time for turning off the MCC of the servo amplifier in vertical-axis brake control.

2084	Numerator of flexible feed gear (SDMR1)
------	---

Data range : 1 to 32767

Standard setting : 0

6. PARAMETERS

Parameter No.	Parameter
2085	Denominator of flexible feed gear (SDMR2)

Data range : 1 to 32767
Standard setting : 0

The flexible feed gear function can be used when 1 or greater is specified in SDMR1 and SDMR2.

2086	Rated current parameter (RTCURR)
------	----------------------------------

Data range : 1 to 32767
Standard setting : Depends on the motor to be used.

This parameter is used to indicate the ratio of the actual current to the rated current. A standard value is set according to the motor. The standard value must not be changed.

2087	New backlash acceleration torque offset (TCPRLD)
------	--

Data range : 0 to 32767
Standard setting : 0

This parameter is set when a torque offset is used for the vertical axis in new backlash acceleration.

2088	Machine velocity feedback gain (MCNFB)
------	--

Data range : 0 to 32767
Standard setting : 0

This parameter sets the feedback gain when the machine velocity feedback function is used.
(Setting value) = $\alpha \times 100$ (%)
When α is 1, set the machine velocity feedback coefficient to 100%.

2089	Base pulse for backlash acceleration (BLBSL)
------	--

Data range : 0 to 32767
Standard setting : 0

This parameter is used to prevent excessive compensation in backlash acceleration.

6. PARAMETERS

Parameter No.	Parameter
2091	Nonlinear control input (ACCSPL)

Data range : 0 to 32767

Standard setting : 0

(This provision is available with Series 9050, editions F and later.)

(For detailed information, see Section 3.7.5.)

2092	Advanced feed-forward coefficient (ADFF1)
------	---

Data range : 0 to 32767

Standard setting : 0

(This provision is available with Series 9050, editions F and later.)

(For detailed information, see Section 3.7.4.)

2098	Phase advancement compensation for deceleration (DEPVPL)
------	--

Data range : 0 to 32767

Standard setting : Depends on the motor.

This parameter determines what percentage of the value set in No. 2057 is to be used for current phase advancement compensation for deceleration. Be sure not to change the set standard value.

(This provision is available with Series 9050, editions G and later.)

(For detailed information, see Section 2.8.5 in Part II.)

2099	One-pulse suppression level for serial pulse coders A and B (ONEPSL)
------	--

Data range : 0 to 32767

Standard setting : 400

This parameter is valid for serial pulse coders A and B only. This parameter is not applicable to serial pulse coder C.

(This provision is available with Series 9050, editions G and later.)

Note that this parameter can be used only with NC software with extended servo parameters.

(For detailed information, see Section 2.2.3 in Part II.)

7. FUNCTIONS FOR Series 16

7.1 250- μ s Acceleration Feedback Function

The acceleration feedback function suppresses mechanical vibration. The specifications of this function have been changed in part for 9050/001B and subsequent editions.

(1) Differences in editions

The specifications of the acceleration feedback function have been changed for 9050/001A and 9050/001B as shown below:

9050/001A	9050/001B
1-ms acceleration feedback function (available in any system state)	1-ms acceleration feedback function (available in any system state)
250- μ s acceleration feedback function (available only in the system stop state)	250- μ s acceleration feedback function (available in any system state)

As listed in the table above, the 250- μ s acceleration feedback function was previously available only in the system stop state. Now, the function is available in any system state.

Along with the change described above, the procedure for setting parameters has been changed as shown below:

9050/001A	9050/001B
1-ms acceleration feedback function (available in any system state) No.2006 bit 4 = 1 No.2076 (acceleration feedback amount) Serial A : About 400 to 600 No.2067 (torque command filter) Set a value around 1100 (200Hz), regardless of the type of pulse coder.	1-ms acceleration feedback function (available in any system state) No.2006 bit 4 = 1 No.2076 (acceleration feedback amount) Serial A : About 200 to 300 Serial C : About 10 to 15 No.2067 (torque command filter) Set a value around 1100 (200Hz), regardless of the type of pulse coder.
250- μ s acceleration feedback function (available only in the system stop state) No.2006 bit 3 = 1 No.2066 (acceleration feedback amount) Serial A : About 10 to 20 No.2091 (stop state decision parameter) Set a value equal to the amplitude of the error pulse on the servo adjustment screen multiplied by 2.	250- μ s acceleration feedback function (available in any system state) No.2066 (acceleration feedback amount) Serial A : About -10 to -20 Serial C : About -250 to -500 (Note) When a positive value is set in No.2066, another function is validated. Set this parameter to a negative value. For details, see the description of No.2066 in Section 6.

7.2 Simplifying the Parameter Setting Method

Some users complained that it was difficult and inconvenient to have to calculate parameters for the feed forward and machine velocity feedback functions according to the number of pulses of the pulse coder. The following changes have been made to simplify the setting method for serial coder A or B.

(1) Position feed forward coefficient (No.2068)

[Setting method for 9050/001A]

$$(\text{Setting vlaue}) = \alpha \times 4096 \times \frac{8192}{\text{Number of position feedback pulses per revolution of the motor}}$$

α : Feed forward coefficient 0 or 1

[Setting method for 9050/001B]

$$(\text{Setting value}) = \alpha \times 100 (\%)$$

α : Feed forward coefficient 0 or 1

(2) Velocity feed forward coefficient (No.2069)

[Setting method for 9050/001A]

$$(\text{Setting value}) = (-PK2V) \times \frac{\text{Rotor inertia} + \text{Load inertia}}{\text{Rotor inertia}} \times 0.04 \times \frac{8192}{\text{Number of position feedback pulses per revolution of the motor}}$$

[Setting method for 9050/001B]

$$(\text{Setting value}) = \frac{\text{Rotor inertia} + \text{Load inertia}}{\text{Rotor inertia}} \times 100 (\%)$$

The setting value calculated from the expressions shown above is a typical value. The value should be adjusted according to the setting value of the velocity loop gain (No.2044) and the load status of the machine.

(3) Machine velocity feedback coefficient (No.2088)

[Setting method for 9050/001A]

$$(\text{Setting vlaue}) = \alpha \times 4096 \times \frac{8192}{\text{Number of position feedback pulses per revolution of the motor}}$$

α : Machine velocity feedback coefficient

[Setting method for 9050/001B]

$$(\text{Setting value}) = \alpha \times 100 (\%)$$

α : Machine velocity feedback coefficient

7.3 High-Speed Positioning Functions

Series 9050 supports the high-speed positioning functions that were supported by Series 9032. The following high-speed functions are usable:

- Position gain switching function
- Integration function for low speed
- Punch/laser switching function
- 250- μ sec acceleration feedback function (available with Series 9050, editions 001B and later).

These functions are the same as those of Series 9032 except for the parameter numbers and increment systems.

(1) Applicable servo ROM series/editions

Series 9050, editions D and later

(2) Outline of each function

(a) Position gain switching function

At a velocity not exceeding that set in No. 2028, the position gain is doubled. This prevents undershooting in positioning and stopping.

No.	Increment system	Setting
2015 bit0 2028	0.01rpm	This function is enabled when this bit is set to 1. Set the maximum velocity that doubles position gain.

(b) Integration function for low speed

The integral gain is valid only at a velocity not exceeding that set in No. 2029. This suppresses vibration during movement, and maintains positioning precision.

No.	Increment system	Setting
2015 bit1 2029	0.01rpm	This function is enabled when this bit is set to 1. Set a velocity that disables integral gain during acceleration.
2030	0.01rpm	Set a velocity that disables integral gain during deceleration.

(c) Punch/laser switching function

When a machine incorporating a punch press and laser is used, two modes are available. One is the punch press mode, which requires positioning only. The other is the laser mode, which requires both path setting and positioning.

7. FUNCTION FOR Series 16

In the punch press mode, the position gain switching function and the integration function for low speed can be used. In the laser mode, these functions can degrade path accuracy. With the punch/laser switching function, the user can enable or disable these functions, depending on the mode.

No.	Setting
2010 bit7	This function is enabled when this bit is set to 1.

(d) 250- μ sec acceleration feedback function

When the load inertia exceeds the motor inertia, this function can improve system stability. This function is available with Series 9050, editions B and later.

No.	Setting
2066	This function is enabled when a negative value is set. For serial A and B : About -10 to -20 For serial C : About -250 to -100

7.4 Advanced Feed-Forward Function

This function is part of the advanced control function, and provides a control method for high-speed, high-precision machining. This function generates feed-forward data by using velocity data one ITP ahead, and shortens the delay due to smoothing. Thus this function allows much higher speed, higher precision machining than the current feed-forward control method.

The current feed-forward control method performs smoothing to eliminate the velocity error that occurs every ITP (Fig. 7.4.1). However, smoothing causes a feed-forward data delay.

By using distribution data one ITP ahead, advanced feed-forward control generates feed-forward data with no delay (Fig. 7.4.2). Thus advanced feed-forward control provides a higher level of control than the current feed-forward control method.

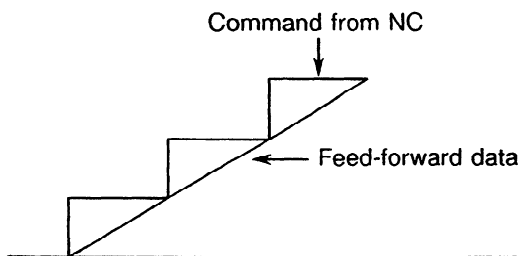

Fig. 7.4.1 Current Feed-Forward Control

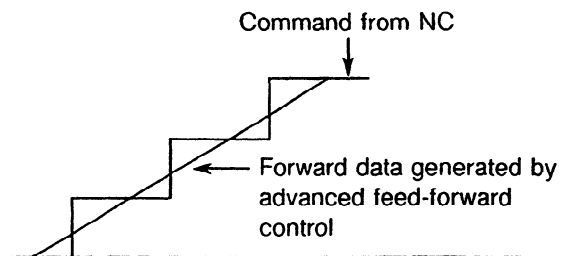

Fig. 7.4.2 Advanced Feed-Forward Control

(1) Applicable servo ROM series/editions

Series 9050, editions F and later

Advanced feed-forward control is available with Series 16 and 18, but not with Power Mate Model-C. Note, however, that when this control method is used with Series 16 or 18, the existing NC software needs to be modified for compatibility with advanced control.

(2) Parameter settings

A description of the parameter settings required to use advanced feed-forward control with Series 16 follows. With Series 9050, the parameters settings associated with feed-forward are simplified as described below.

① The parameters are set as described below.

First, set the following parameters as in the case of the current feed-forward control method:

No. 2003 bit3 = 1 : Enables PI control.
 No. 2005 bit1 = 1 : Enables feed-forward.
 No. 2069 Velocity loop feed-forward coefficient (VFF) (in %)

$$VFF = \frac{\text{Load inertia} + \text{rotor inertia}}{\text{Rotor inertia}} \times 100$$

Then set the advanced feed-forward control parameter as follows:

No. 2092 Advanced feed-forward control coefficient (in 0.01%)
 Advanced feed-forward control coefficient = $\alpha \times 10000$
 ($0 \leq \alpha \leq 1$)
 Example : When $\alpha = 93.5\%$, No. 2092 = 9350

Advanced control, when used together with the pre-interpolation acceleration/deceleration function of the NC, allows α to be set to a value near 1, thus providing a high level of control.

② Advanced control is enabled by specifying the G codes described below in the program. This specification also enables advanced feed-forward control.

G08 P1 : Turns on the advanced control mode.
 G08 P0 : Turns off the advanced control mode.

When the advanced control mode is turned off, the current feed-forward coefficient (No. 2068) is valid.

$$\text{Current feed-forward coefficient (No. 2068)} = \alpha \times 100 \quad (0 \leq \alpha \leq 1)$$

7.5 Nonlinear Control Function

With this function, the gain of the velocity loop can be increased by applying nonlinear input to a torque command. When this function is used, the system makes a high-fidelity response to a higher position gain. Therefore, control can be exercised with a higher response characteristic and less overshoot and swell. This function also allows machines capable of high-speed positioning to reduce the time required for positioning.

(1) Outline of control method

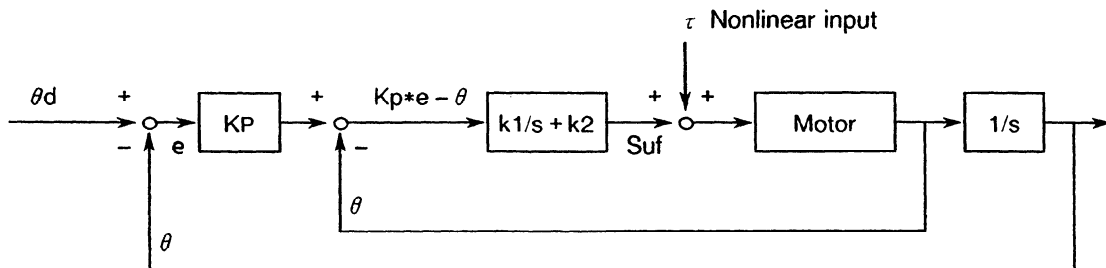

As shown above, PI input (velocity loop error) can be made zero by applying the nonlinear switching input, τ , to a torque command. At this time, the velocity loop gain becomes very high, and the system operates, depending only on the position gain.

(2) Applicable servo ROM series/editions

Series 9050, editions F and later

(3) Parameter and method of adjustment

No. 2091	Data range	: 0 to 32767
	Standard setting	: 0
	Guideline for setting	: 5000 to 20000

When a value is set in the parameter, this function is enabled. The smaller the value set, the greater the influence of nonlinear control. Note, however, that when an excessively low value is set, a vibrating sound occurs when the machine stops or starts movement. In particular, when the dumping factors (such as friction) of the machine system are small, vibration can easily be produced, thus producing no significant effects.

To use this function with a vertical axis, set the torque offset parameter as described below.

No. 2087	Data range	: 0 to 32767
	Standard setting	: 0

7. FUNCTION FOR Series 16

Control the machine so that it move along the axis in the positive and negative directions at a very low speed, and measure the actual currents on the servo adjustment screen. Let A% be the current in the positive direction, B% be the current in the negative direction, and C be the value of No. 2086. Then, set No. 2086 as follows (including the sign):

$$\text{No. 2086} = C \times (A + B)/200$$

Example : When A = 20%, B = - 60%, and C = 1600, the value - 320 is to be set in No. 2087.

Even more efficient high-speed positioning can be achieved when this function is used together with the position gain switching function (for doubling the position gain in a low-speed area).

8. TABLES OF STANDARD DIGITAL SERVO PARAMETERS

8. TABLES OF STANDARD DIGITAL SERVO PARAMETERS

Tables of standard digital servo parameters for Series 16/18 and Power Mate MODEL-C follow.

Symbol	Motor model Drawing No. of motor 9050/B, C Motor type	50S 0331 39	60S 0332 40	70S 0333 41	5-0 0531 42	4-0S 0532 43	3-0S 0533 44	2-0S 0310 45	1-0S 0312 46	0S 0313 47	5S 0314 48	6S 0316 49	10S 0315 50	20S/1500 0505 51	20S 0502 52	FROM VERSION	
																9050/1B	9050/1C
INTST																	
PK1	1040	0846	0846	0846	0046	0046	0046	0046	0046	0046	0046	0046	0046	0046	0046		
PK2	2041	999	1451	1334	241	460	736	390	1170	1500	1500	750	2591	1131	1261		
PK3	2042	-3600	-6000	-5297	-527	-730	-1500	-810	-2289	-2400	-2781	-2000	-5540	-2477	-2577		
PK1V	2043	-1957	-2259	-2723	-1873	-2373	-2374	-2480	-2485	-3052	-3052	-2596	-2633	-2649	-2646		
PK2V	2044	168	130	145	45	58	53	111	91	113	151	216	260	458	298		
PK3V	2045	-1502	-1165	-1295	-300	-517	-477	-997	-812	-1015	-1355	-1932	-2328	-4103	-2666		
PK4V	2046	-8235	-8235	-8235	-8235	-8235	-8235	-8235	-8235	-8235	-8235	-8235	-8235	-8235	-8235		
POA1	2047	0	0	0	0	7334	7948	3806	4674	3740	2801	1964	1630	925	1424		
BLCMP	2048	0	0	0	0	0	0	0	0	0	0	0	0	0	0		
RESERV	2049	0	0	0	0	0	0	0	0	0	0	0	0	0	0		
POK1	2050	956	956	956	956	956	956	956	956	956	956	956	956	956	956		
POK2	2051	510	510	510	510	510	510	510	510	510	510	510	510	510	510		
RESERV	2052	0	0	0	0	0	0	0	0	0	0	0	0	0	0		
PPMAX	2053	21	21	21	21	21	21	21	21	21	21	21	21	21	21		
PDPP	2054	3787	3787	3787	3787	3787	3787	3787	3787	3787	3787	3787	3787	3787	3787		
PHYST	2055	319	319	319	319	319	319	319	319	319	319	319	319	319	319		
EMFCMP	2056	4444	4884	6668	0	629	1129	1589	2147	1350	2403	5000	5520	3549	2781		
PVPA	2057	2300	2800	3040	2330	1861	2330	2330	1864	2330	2330	3750	3500	2797	2600		
PPALPH	2058	57	57	57	57	46	57	57	46	57	57	64	64	52	57		
PPBAS	2059	20	20	20	20	0	0	0	0	0	0	0	0	0	0		
TQLIM	2060	6560	6560	6560	7282	7282	7282	7282	7282	7282	7282	7282	7282	7282	6918		
EMFLMT	2061	120	120	120	120	120	120	120	120	120	120	120	120	120	120		
POVC1	2062	32419	32499	32281	32514	32543	32576	32623	32627	32722	32677	32485	32539	32155	32386		
POVC2	2063	4365	3358	6086	3173	2817	2401	1811	1766	578	1142	3536	2864	1659	4771		
BTPAL	2064	84	84	84	4	4	4	4	4	4	4	4	4	4	4		
TGALMLY	2065	4	4	4	4	4	4	4	4	4	4	4	4	4	4		
POVCLMT	2066	13002	9990	18168	9437	8375	7136	5377	5245	1715	3388	10522	8515	22907	14219		
PK2VAUX	2067	1100	1100	1100	0	0	0	0	0	0	0	0	0	0	0		
FILTER	RESERV	0	0	0	0	0	0	0	0	0	0	0	0	0	0		
RESERV	RESERV	0	0	0	0	0	0	0	0	0	0	0	0	0	0		
RESERV	RESERV	0	0	0	0	0	0	0	0	0	0	0	0	0	0		
FALPH	2068	0	0	0	0	0	0	0	0	0	0	0	0	0	0		
VFFLT	2069	0	0	0	0	0	0	0	0	0	0	0	0	0	0		
ERBLM	2070	0	0	0	0	0	0	0	0	0	0	0	0	0	0		
PBLCT	2071	0	0	0	0	0	0	0	0	0	0	0	0	0	0		
RESERV	2072	0	0	0	0	0	0	0	0	0	0	0	0	0	0		
RESERV	2073	0	0	0	0	0	0	0	0	0	0	0	0	0	0		
AALPH	2074	400	400	400	0	0	0	0	0	0	0	0	0	0	0		
MODEL	2075	0	0	0	0	0	0	0	0	0	0	0	0	0	0		
WKAC	2076	15	15	15	0	0	0	0	0	0	0	0	0	0	0		
OSCTPL	2077	0	0	0	0	0	0	0	0	0	0	0	0	0	0		
RESERV	2078	0	0	0	0	0	0	0	0	0	0	0	0	0	0		
RESERV	2079	0	0	0	0	0	0	0	0	0	0	0	0	0	0		
RESERV	2080	0	0	0	0	0	0	0	0	0	0	0	0	0	0		
RESERV	2081	0	0	0	0	0	0	0	0	0	0	0	0	0	0		
BLENDL	2082	0	0	0	0	0	0	0	0	0	0	0	0	0	0		
MOFCTL	2083	0	0	0	0	0	0	0	0	0	0	0	0	0	0		
SDMR1	2084	0	0	0	0	0	0	0	0	0	0	0	0	0	0		
SDMR2	2085	0	0	0	0	0	0	0	0	0	0	0	0	0	0		
RTCURR	2086	2653	2326	3137	2261	2129	1966	1706	1685	1064	1354	1966	1768	3801	2285		
TDPLD	2087	0	0	0	0	0	0	0	0	0	0	0	0	0	0		

8. TABLES OF STANDARD DIGITAL SERVO PARAMETERS

Parameter Table No. 1-b (PARAM110)

Symbol	Motor model Drawing No. of motor 9050/B, C Motor type	Parameter No. of motor													FROM VERSION		
		30S	30/2000	40	0L	5L	6L	7L	10L	2-OS(H)	1-OS(H)	0S(H)	5S(H)	10S(H)	20S(H)	9050/1B	9050/1C
INTST		0046	0046	0046	0046	0046	0046	0046	0046	0046	0046	0046	0046	0046	0046		
PK1	1040	3414	705	1511	2000	1360	850	590	700	390	450	1019	612	1090	0846	0846	0846
PK2	1041	-7650	-5829	-5635	-4000	-2300	-1600	-2000	-2000	-810	-900	-2872	-1574	-2360	-1721	-2360	-1721
PK3	1042	-2663	-2659	-2614	-2614	-2647	-2652	-2685	-2701	-2480	-2503	-2517	-2526	-2625	-2654	-2654	-2654
PK4	1043	201	375	282	18	17	34	119	150	111	128	126	136	287	305	287	305
PK5	1044	-1797	-3356	-2526	-159	-156	-309	-1070	-1346	-997	-1146	-1127	-1215	-2571	-2734	-2571	-2734
PK6	1045	0	0	0	0	0	0	0	0	0	0	0	0	0	0	0	0
PK7	1046	-8235	-8235	-8235	-8235	-8235	-8235	-8235	-8235	-8235	-8235	-8235	-8235	-8235	-8235	-8235	-8235
PK8	1047	2112	1131	1502	23820	24290	12292	3547	2820	3806	3311	3366	3124	1476	1388	1476	1388
PK9	1048	0	0	0	0	0	0	0	0	0	0	0	0	0	0	0	0
PK10	1049	0	0	0	0	0	0	0	0	0	0	0	0	0	0	0	0
PK11	1050	956	956	956	956	956	956	956	956	956	956	956	956	956	956	956	956
PK12	1051	510	510	510	510	510	510	510	510	510	510	510	510	510	510	510	510
PK13	1052	0	0	0	0	0	0	0	0	0	0	0	0	0	0	0	0
PK14	1053	21	21	21	21	21	21	21	21	21	21	21	21	21	21	21	21
PK15	1054	3787	3787	3787	3787	3787	3787	3787	3787	3787	3787	3787	3787	3787	3787	3787	3787
PK16	1055	319	319	319	319	319	319	319	319	319	319	319	319	319	319	319	319
PK17	1056	5456	1961	3478	1075	1097	1240	3200	4000	2100	2520	2520	2520	3780	4200	3780	4200
PK18	1057	7200	2330	2800	2330	2330	2330	2330	2330	2330	2330	2330	2330	2330	2330	2330	2330
PK19	1058	50	57	43	57	57	57	64	64	57	57	57	57	57	57	57	57
PK20	1059	0	0	0	0	0	0	0	0	0	0	0	0	0	0	0	0
PK21	1060	6918	6554	7282	7282	6918	6918	7282	7282	7282	7282	7282	7282	7282	7282	7282	7282
PK22	1061	120	120	120	120	120	120	120	120	120	120	120	120	120	120	120	120
PK23	1062	32530	32254	32340	32595	32598	32614	32299	31875	32623	32519	32712	32694	32578	32495	32578	32495
PK24	1063	2971	6421	5355	912	877	1928	5867	11158	1811	3112	706	924	2381	3410	2381	3410
PK25	1064	0	0	0	0	0	0	0	0	0	0	0	0	0	0	0	0
PK26	1065	4	4	4	4	4	4	4	4	4	4	4	4	4	4	4	4
PK27	1066	8834	19176	15972	2706	2602	5727	17509	32767	5377	9256	2094	2740	7075	10144	7075	10144
PK28	1067	0	0	0	0	0	0	0	0	0	0	0	0	0	0	0	0
PK29	1068	0	0	0	0	0	0	0	0	0	0	0	0	0	0	0	0
PK30	1069	0	0	0	0	0	0	0	0	0	0	0	0	0	0	0	0
PK31	1070	0	0	0	0	0	0	0	0	0	0	0	0	0	0	0	0
PK32	1071	0	0	0	0	0	0	0	0	0	0	0	0	0	0	0	0
PK33	1072	0	0	0	0	0	0	0	0	0	0	0	0	0	0	0	0
PK34	1073	0	0	0	0	0	0	0	0	0	0	0	0	0	0	0	0
PK35	1074	0	0	0	0	0	0	0	0	0	0	0	0	0	0	0	0
PK36	1075	0	0	0	0	0	0	0	0	0	0	0	0	0	0	0	0
PK37	1076	0	0	0	0	0	0	0	0	0	0	0	0	0	0	0	0
PK38	1077	0	0	0	0	0	0	0	0	0	0	0	0	0	0	0	0
PK39	1078	0	0	0	0	0	0	0	0	0	0	0	0	0	0	0	0
PK40	1079	0	0	0	0	0	0	0	0	0	0	0	0	0	0	0	0
PK41	1080	0	0	0	0	0	0	0	0	0	0	0	0	0	0	0	0
PK42	1081	0	0	0	0	0	0	0	0	0	0	0	0	0	0	0	0
PK43	1082	0	0	0	0	0	0	0	0	0	0	0	0	0	0	0	0
PK44	1083	0	0	0	0	0	0	0	0	0	0	0	0	0	0	0	0
PK45	1084	0	0	0	0	0	0	0	0	0	0	0	0	0	0	0	0
PK46	1085	0	0	0	0	0	0	0	0	0	0	0	0	0	0	0	0
PK47	1086	1801	2654	2941	1210	1187	1761	3079	4261	1706	2239	1064	1218	1814	2344	1814	2344
PK48	1087	0	0	0	0	0	0	0	0	0	0	0	0	0	0	0	0

8. TABLES OF STANDARD DIGITAL SERVO PARAMETERS

ROM VERSION
9050/1B
9050/1C

Parameter Table No. 1-c (PARAM110)

Symbol	Motor model	30S(H)	0L(H)	5L(H)	6L(H)	7L(H)	10L(H)	6S(H)
INTST		0846	0846	0846	0846	0846	0846	0846
PK1	1040	708	2000	1360	350	590	700	1000
PK2	2041	-1811	-5635	-4000	-2300	-1600	-2000	-2400
PK3	2042	-2664	-2614	-2647	-2652	-2685	-2701	-2459
PK1V	2043	346	18	17	34	119	150	135
PK2V	2044	-3097	-159	-156	-309	-1070	-1346	-1205
PK3V	2045	0	0	0	0	0	0	0
PK4V	2046	-8235	-8235	-8235	-8235	-8235	-8235	-8235
POA1	2047	1226	23820	24290	12292	3547	2820	3148
BLCMP	2048	0	0	0	0	0	0	0
RESERV	2049	0	0	0	0	0	0	0
POK1	2050	956	956	956	956	956	956	956
POK2	2051	510	510	510	510	510	510	510
RESERV	2052	0	0	0	0	0	0	0
PRMAX	2053	21	21	21	21	21	21	21
PDP	2054	3787	3787	3787	3787	3787	3787	3787
PHYST	2055	319	319	319	319	319	319	319
EMFCMP	2056	4200	2000	2000	1240	3200	4800	3200
PVPA	2057	2330	2330	2330	2330	2330	2330	2330
PALPH	2058	57	57	57	57	64	64	64
PBAS	2059	5	5	5	0	0	0	5
TQLM	2060	7282	7282	6918	6918	7282	7282	6918
ENFLMT	2061	120	120	120	120	120	120	120
POV1	2062	32470	32695	32698	32614	32299	31875	32693
POV2	2063	3723	912	877	1928	5867	11156	940
BITPAL		68	68	68	68	68	68	68
TGALMLV	2064	4	4	4	4	4	4	4
POVCLNT	2065	11081	2706	2602	5727	17509	32767	2787
PKZYADX	2066	0	0	0	0	0	0	0
FILTER	2067	0	0	0	0	0	0	0
RESERV		0	0	0	0	0	0	0
RESERV		0	0	0	0	0	0	0
RESERV		0	0	0	0	0	0	0
FALPH	2068	0	0	0	0	0	0	0
VFFLT	2069	0	0	0	0	0	0	0
FRBLM	2070	0	0	0	0	0	0	0
PBLCT	2071	0	0	0	0	0	0	0
RESERV	2072	0	0	0	0	0	0	0
RESERV	2073	0	0	0	0	0	0	0
AALPH	2074	2520	3000	3000	4000	4000	4000	3200
MODEL	2075	0	0	0	0	0	0	0
WAC	2076	0	0	0	0	0	0	0
OSCTPL	2077	0	0	0	0	0	0	0
RESERV	2078	0	0	0	0	0	0	0
RESERV	2079	0	0	0	0	0	0	0
RESERV	2080	0	0	0	0	0	0	0
RESERV	2081	0	0	0	0	0	0	0
BLNDL	2082	0	0	0	0	0	0	0
MOPCTL	2083	0	0	0	0	0	0	0
SDMR1	2084	0	0	0	0	0	0	0
SDMR2	2085	0	0	0	0	0	0	0
RTCURR	2086	2450	1210	1187	1761	3079	4261	1228
TDPLD	2087	0	0	0	0	0	0	0

8. TABLES OF STANDARD DIGITAL SERVO PARAMETERS

ROM VERSION
9050/1B
9050/1C

Parameter Table No. 1-d (PARAM110)

Symbol	Motor model	6L	5L	6L	5L	40S(H)	0T(H)	5T	5T(H)	10T	10T(H)
9050/B, C Motor type	Drawing No. of motor	0564	0562	0564	0562	0583	0381	0382	0383	0384	0385
Parameter No.	Motor type	74	75	76	77	78	79	80	81	82	83
FS16 Power Mate C											
1KTST											
2040	1040	0846	0846	0843	0843	0846	0846	0846	0846	0846	0846
2041	1041	1612	1527	1527	3646	811	701	670	456	600	409
2042	1042	-4476	-4473	-4473	-12081	-3885	-2038	-1600	-1019	-1153	-946
2043	1043	-2632	-2647	-2691	-2689	-2666	-2390	-2473	-2498	-2550	-2543
2044	1044	17	15	25	15	280	260	287	209	450	349
2045	1045	-1081	-602	-1852	-1172	-2511	-2329	-2568	-1877	-4034	-3124
2046	1046	-7206	-7206	-6177	-6177	-8235	-8235	-8235	-8235	-8235	-8235
2047	1047	768	1518	384	759	1512	1630	1478	2022	941	1215
2048	1048	0	0	0	0	0	0	0	0	0	0
2049	1049	0	0	0	0	0	0	0	0	0	0
2050	1050	956	956	511	511	956	956	956	956	956	956
2051	1051	510	510	136	136	510	510	510	510	510	510
2052	1052	0	0	0	0	0	0	0	0	0	0
2053	1053	21	21	21	21	21	21	21	21	21	21
2054	1054	9750	4875	4875	4875	3787	3787	3787	3787	3787	3787
2055	1055	319	319	319	319	319	319	319	319	319	319
2056	1056	1240	1097	1240	1097	4800	4008	4400	3684	4590	4008
2057	1057	2330	2330	2330	2330	3200	4200	4000	3000	3335	2330
2058	1058	57	57	57	57	64	64	64	64	57	57
2059	1059	0	0	0	0	5	5	5	5	5	5
2060	1060	6918	6918	6918	6918	7282	7282	7282	7282	7282	7282
2061	1061	120	120	120	120	120	120	120	120	120	120
2062	1062	32614	32698	32614	32698	32345	32703	32669	32714	32532	32525
2063	1063	4608	4608	4608	4608	68	68	68	68	68	68
2064	1064	4	4	4	4	4	4	4	4	4	4
2065	1065	5716	2602	5716	2602	15775	2428	3665	1998	8766	5308
2066	1066	0	0	0	0	0	0	0	0	0	0
2067	1067	256	256	-32512	-32512	0	0	0	0	0	0
2068	1068	16384	16384	16384	16384	0	0	0	0	0	0
2069	1069	0	0	0	0	0	0	0	0	0	0
2070	1070	0	0	0	0	0	0	0	0	0	0
2071	1071	0	0	0	0	0	0	0	0	0	0
2072	1072	0	0	0	0	0	0	0	0	0	0
2073	1073	0	0	0	0	0	0	0	0	0	0
2074	1074	0	0	0	0	0	3158	0	2106	0	3421
2075	1075	0	0	0	0	0	0	0	0	0	0
2076	1076	0	0	0	0	0	0	0	0	0	0
2077	1077	0	0	0	0	0	0	0	0	0	0
2078	1078	16384	16384	16384	16384	0	0	0	0	0	0
2079	1079	0	0	0	0	0	0	0	0	0	0
2080	1080	0	0	0	0	0	0	0	0	0	0
2081	1081	0	0	0	0	0	0	0	0	0	0
2082	1082	0	0	0	0	0	0	0	0	0	0
2083	1083	0	0	0	0	0	0	0	0	0	0
2084	1084	0	0	0	0	0	0	0	0	0	0
2085	1085	0	0	0	0	0	0	0	0	0	0
2086	1086	1760	1187	1760	1187	2923	1147	1409	1040	2179	1696
2087	1087	0	0	0	0	0	0	0	0	0	0
TDPLD											

8. TABLES OF STANDARD DIGITAL SERVO PARAMETERS

 ROM VERSION
9050/1D

Parameter Table No. 2-a (PARAM112)

9050/D	Motor model Drawing No. of motor Motor type	Parameter No.														20S/1500	20S
		50S	60S	70S	5-0	4-0S	3-0S	2-0S	1-0S	0S	5S	6S	10S	20S/1500	20S		
		0331	0332	0333	0531	0532	0533	0310	0312	0313	0314	0316	0315	0505	0502		
		39	40	41	42	43	44	45	46	47	48	49	50	51	52		
		0846	0846	0846	0046	0046	0046	0046	0046	0046	0046	0046	0046	0046	0046		
	1040	999	1451	1334	457	460	736	1170	1500	1500	1500	750	7591	0046	0046		
	2040	0846	1451	1334	457	460	736	1170	1500	1500	1500	750	7591	0046	0046		
	2041	0846	1451	1334	457	460	736	1170	1500	1500	1500	750	7591	0046	0046		
	2042	0846	1451	1334	457	460	736	1170	1500	1500	1500	750	7591	0046	0046		
	2043	0846	1451	1334	457	460	736	1170	1500	1500	1500	750	7591	0046	0046		
	2044	0846	1451	1334	457	460	736	1170	1500	1500	1500	750	7591	0046	0046		
	2045	0846	1451	1334	457	460	736	1170	1500	1500	1500	750	7591	0046	0046		
	2046	0846	1451	1334	457	460	736	1170	1500	1500	1500	750	7591	0046	0046		
	2047	0846	1451	1334	457	460	736	1170	1500	1500	1500	750	7591	0046	0046		
	2048	0846	1451	1334	457	460	736	1170	1500	1500	1500	750	7591	0046	0046		
	2049	0846	1451	1334	457	460	736	1170	1500	1500	1500	750	7591	0046	0046		
	2050	0846	1451	1334	457	460	736	1170	1500	1500	1500	750	7591	0046	0046		
	2051	0846	1451	1334	457	460	736	1170	1500	1500	1500	750	7591	0046	0046		
	2052	0846	1451	1334	457	460	736	1170	1500	1500	1500	750	7591	0046	0046		
	2053	0846	1451	1334	457	460	736	1170	1500	1500	1500	750	7591	0046	0046		
	2054	0846	1451	1334	457	460	736	1170	1500	1500	1500	750	7591	0046	0046		
	2055	0846	1451	1334	457	460	736	1170	1500	1500	1500	750	7591	0046	0046		
	2056	0846	1451	1334	457	460	736	1170	1500	1500	1500	750	7591	0046	0046		
	2057	0846	1451	1334	457	460	736	1170	1500	1500	1500	750	7591	0046	0046		
	2058	0846	1451	1334	457	460	736	1170	1500	1500	1500	750	7591	0046	0046		
	2059	0846	1451	1334	457	460	736	1170	1500	1500	1500	750	7591	0046	0046		
	2060	0846	1451	1334	457	460	736	1170	1500	1500	1500	750	7591	0046	0046		
	2061	0846	1451	1334	457	460	736	1170	1500	1500	1500	750	7591	0046	0046		
	2062	0846	1451	1334	457	460	736	1170	1500	1500	1500	750	7591	0046	0046		
	2063	0846	1451	1334	457	460	736	1170	1500	1500	1500	750	7591	0046	0046		
	2064	0846	1451	1334	457	460	736	1170	1500	1500	1500	750	7591	0046	0046		
	2065	0846	1451	1334	457	460	736	1170	1500	1500	1500	750	7591	0046	0046		
	2066	0846	1451	1334	457	460	736	1170	1500	1500	1500	750	7591	0046	0046		
	2067	0846	1451	1334	457	460	736	1170	1500	1500	1500	750	7591	0046	0046		
	2068	0846	1451	1334	457	460	736	1170	1500	1500	1500	750	7591	0046	0046		
	2069	0846	1451	1334	457	460	736	1170	1500	1500	1500	750	7591	0046	0046		
	2070	0846	1451	1334	457	460	736	1170	1500	1500	1500	750	7591	0046	0046		
	2071	0846	1451	1334	457	460	736	1170	1500	1500	1500	750	7591	0046	0046		
	2072	0846	1451	1334	457	460	736	1170	1500	1500	1500	750	7591	0046	0046		
	2073	0846	1451	1334	457	460	736	1170	1500	1500	1500	750	7591	0046	0046		
	2074	0846	1451	1334	457	460	736	1170	1500	1500	1500	750	7591	0046	0046		
	2075	0846	1451	1334	457	460	736	1170	1500	1500	1500	750	7591	0046	0046		
	2076	0846	1451	1334	457	460	736	1170	1500	1500	1500	750	7591	0046	0046		
	2077	0846	1451	1334	457	460	736	1170	1500	1500	1500	750	7591	0046	0046		
	2078	0846	1451	1334	457	460	736	1170	1500	1500	1500	750	7591	0046	0046		
	2079	0846	1451	1334	457	460	736	1170	1500	1500	1500	750	7591	0046	0046		
	2080	0846	1451	1334	457	460	736	1170	1500	1500	1500	750	7591	0046	0046		
	2081	0846	1451	1334	457	460	736	1170	1500	1500	1500	750	7591	0046	0046		
	2082	0846	1451	1334	457	460	736	1170	1500	1500	1500	750	7591	0046	0046		
	2083	0846	1451	1334	457	460	736	1170	1500	1500	1500	750	7591	0046	0046		
	2084	0846	1451	1334	457	460	736	1170	1500	1500	1500	750	7591	0046	0046		
	2085	0846	1451	1334	457	460	736	1170	1500	1500	1500	750	7591	0046	0046		
	2086	0846	1451	1334	457	460	736	1170	1500	1500	1500	750	7591	0046	0046		
	2087	0846	1451	1334	457	460	736	1170	1500	1500	1500	750	7591	0046	0046		

8. TABLES OF STANDARD DIGITAL SERVO PARAMETERS

 ROM VERSION
9050/1D

Parameter Table No. 2-b (PARAM112)

Motor model Drawing No. of motor 9050/D Motor type	Parameter No. FS16 Power Mate C	30S	30/2000	40	OL	5L	6L	7L	10L	2-OS(H)	1-OS(H)	OS(H)	5S(H)	10S(H)	20S(H)
Symbol	Power Mate C	0580	0506	0581	0561	0562	0564	0571	0572	0310	0309	0313	0514	0317	0318
INTST		0046	0046	0046	0046	0046	0046	0046	0046	0846	0846	0846	0846	0846	0846
PA1	1040	3414	705	1511	2000	1360	850	590	700	390	450	600	672	1090	677
PK2	1041	-7650	-5829	-5635	-4000	-2300	-1600	-2000	-2000	-810	-900	-1600	-1574	-2360	-1721
PK3	1042	-2663	-2669	-2672	-2614	-2647	-2652	-2685	-2701	-2480	-2503	-2517	-2526	-2654	-2654
PK4V	1043	201	375	282	18	17	34	119	150	111	128	126	136	287	305
PK2V	1044	-1797	-3356	-2526	-159	-156	-309	-1070	-1346	-997	-1146	-1127	-1215	-2571	-2734
PK3V	1045	0	0	0	0	0	0	0	0	-8235	-8235	-8235	-8235	-8235	-8235
PK4V	1046	-8235	-8235	-8235	-8235	-8235	-8235	-8235	-8235	-8235	-8235	-8235	-8235	-8235	-8235
POA1	1047	2112	1131	1502	23820	24290	12292	3547	2820	3806	3311	3366	3124	1476	1388
BLCMP	2048	0	0	0	0	0	0	0	0	0	0	0	0	0	0
RESERV	2049	0	0	0	0	0	0	0	0	0	0	0	0	0	0
RESERV	2050	956	956	956	956	956	956	956	956	956	956	956	956	956	956
POK1	1050	510	510	510	510	510	510	510	510	510	510	510	510	510	510
POK2	1051	510	510	510	510	510	510	510	510	510	510	510	510	510	510
RESERV	2052	0	0	0	0	0	0	0	0	0	0	0	0	0	0
RESERV	2053	21	21	21	21	21	21	21	21	21	21	21	21	21	21
PPMAX	1053	3787	3787	3787	3787	3787	3787	3787	3787	3787	3787	3787	3787	3787	3787
PRDP	2054	319	319	319	319	319	319	319	319	319	319	319	319	319	319
PHYST	2055	5456	1961	3478	1075	1097	1240	4000	2100	2520	2520	2520	2520	3780	4200
ENFCMP	2056	7200	2330	2800	2330	2330	2330	3200	3200	2330	2330	2330	2330	2330	2330
PVPA	2057	50	57	43	57	57	57	64	64	57	57	57	57	57	57
PALPH	1058	0	0	0	0	0	0	0	0	0	0	0	0	0	0
PPBAS	2059	6918	6554	7282	7282	6918	6918	7282	7282	7282	7282	7282	7282	7282	7282
TOALM1	1060	120	120	120	120	120	120	120	120	120	120	120	120	120	120
ENFLM1	2061	32530	32254	32340	32695	32698	32614	32299	31875	32623	32519	32712	32694	32578	32495
POVC1	1062	2971	6421	5355	912	877	1928	5867	11188	1811	3112	706	924	2381	3410
POVC2	1063	0	0	0	0	0	0	0	0	68	68	68	68	68	68
BITPA1	1064	4	4	4	4	4	4	4	4	4	4	4	4	4	4
TGALM1	2065	8834	19176	15972	2706	2602	5727	17509	32767	5377	9256	2094	2740	7075	10144
POVCLM1	1065	0	0	0	0	0	0	0	0	0	0	0	0	0	0
PK2VAUX	2066	0	0	0	0	0	0	0	0	0	0	0	0	0	0
FILTER	2067	0	0	0	0	0	0	0	0	0	0	0	0	0	0
RESERV		0	0	0	0	0	0	0	0	0	0	0	0	0	0
RESERV		0	0	0	0	0	0	0	0	0	0	0	0	0	0
RESERV		0	0	0	0	0	0	0	0	0	0	0	0	0	0
RESERV		0	0	0	0	0	0	0	0	0	0	0	0	0	0
FALPH	1068	0	0	0	0	0	0	0	0	0	0	0	0	0	0
VFFLT	1069	0	0	0	0	0	0	0	0	0	0	0	0	0	0
EBBLA	1070	0	0	0	0	0	0	0	0	0	0	0	0	0	0
PBLCT	2071	0	0	0	0	0	0	0	0	0	0	0	0	0	0
RESERV	2072	0	0	0	0	0	0	0	0	0	0	0	0	0	0
RESERV	2073	0	0	0	0	0	0	0	0	0	0	0	0	0	0
AALPH	1074	0	0	0	0	0	0	0	0	1680	2940	4000	2100	2520	2100
MODEL	1075	0	0	0	0	0	0	0	0	0	0	0	0	0	0
WKAC	2076	0	0	0	0	0	0	0	0	0	0	0	0	0	0
OSCTPL	2077	0	0	0	0	0	0	0	0	0	0	0	0	0	0
RESERV	2078	0	0	0	0	0	0	0	0	0	0	0	0	0	0
RESERV	2079	0	0	0	0	0	0	0	0	0	0	0	0	0	0
RESERV	2080	0	0	0	0	0	0	0	0	0	0	0	0	0	0
RESERV	2081	0	0	0	0	0	0	0	0	0	0	0	0	0	0
BLENDL	2082	0	0	0	0	0	0	0	0	0	0	0	0	0	0
NOFCTL	1083	0	0	0	0	0	0	0	0	0	0	0	0	0	0
SDMR1	2084	0	0	0	0	0	0	0	0	0	0	0	0	0	0
SDMR2	2085	0	0	0	0	0	0	0	0	0	0	0	0	0	0
FTCURR	2086	1801	2654	2941	1210	1187	1761	3079	4261	1706	2239	1064	1218	1814	2344
TDPLD	2087	0	0	0	0	0	0	0	0	0	0	0	0	0	0

8. TABLES OF STANDARD DIGITAL SERVO PARAMETERS

ROM VERSION
9050/1D

Parameter Table No. 2-c (PARAM112)

Motor model Drawing No. of motor 9050/D Motor type	30S(H) 0319 67	0L(H) 0561 68	5L(H) 0562 69	6L(H) 0564 70	7L(H) 0571 71	10L(H) 0572 72	6S(H) 0572 73
Symbol							
Parameter No.							
FS16 Power Mate C							
2040	0846	0846	0846	0846	0846	0846	0846
PK1	1040	2000	1360	850	590	700	1000
PK2	1041	-5835	-4000	-2300	-1600	-2000	-2400
PK3	2042	-2614	-2647	-2652	-2685	-2701	-2459
PK1V	2043	18	17	34	119	150	135
PK2V	2044	-3097	-156	-309	-1070	-1346	-1205
PK3V	2045	0	0	0	0	0	0
PK4V	2046	-8235	-8235	-8235	-8235	-8235	-8235
POA1	2047	23820	24290	12292	3547	2820	3148
BLCMP	2048	0	0	0	0	0	0
RESERV	2049	0	0	0	0	0	0
POK1	2050	956	956	956	956	956	956
POK2	2051	510	510	510	510	510	510
RESERV	2052	0	0	0	0	0	0
PPMAX	2053	21	21	21	21	21	21
PDDP	2054	3787	3787	3787	3787	3787	3787
PHYST	2055	319	319	319	319	319	319
EMFCMP	2056	4200	2000	1240	3200	4800	3200
PVPA	2057	2330	2330	2330	3200	3200	2300
PALPH	2058	57	57	57	64	64	64
PPBAS	2059	5	5	5	0	0	5
TQLJM	2060	7282	6918	6918	7282	7282	6918
ENFLMT	2061	120	120	120	120	120	120
POVCI	2062	32470	32895	32698	32614	31875	32693
POV2	2063	3723	912	877	1928	5867	11158
B1TPA1	2064	68	68	68	68	68	68
TGALMLV	2065	4	4	4	4	4	4
POVCLMT	2066	11081	2706	2602	5727	17509	32767
PK2VAUX	2067	0	0	0	0	0	0
FILTER	RESERV	0	0	0	0	0	0
RESERV	RESERV	0	0	0	0	0	0
RESERV	RESERV	0	0	0	0	0	0
RESERV	RESERV	0	0	0	0	0	0
FALPH	2068	0	0	0	0	0	0
VFFLT	2069	0	0	0	0	0	0
ERBLM	2070	0	0	0	0	0	0
PBLCT	2071	0	0	0	0	0	0
RESERV	2072	0	0	0	0	0	0
RESERV	2073	0	0	0	0	0	0
AALPH	2074	2520	3000	3000	4000	4000	3200
MODEL	2075	0	0	0	0	0	0
WKAC	2076	0	0	0	0	0	0
OSCTPL	2077	0	0	0	0	0	0
RESERV	2078	0	0	0	0	0	0
RESERV	2079	0	0	0	0	0	0
RESERV	2080	0	0	0	0	0	0
RESERV	2081	0	0	0	0	0	0
BLENDL	2082	0	0	0	0	0	0
MOFCTL	2083	0	0	0	0	0	0
SDMR1	2084	0	0	0	0	0	0
SDMR2	2085	0	0	0	0	0	0
RTCURR	2086	2450	1187	1761	3079	4261	1228
TDFLD	2087	0	0	0	0	0	0

8. TABLES OF STANDARD DIGITAL SERVO PARAMETERS

 ROM VERSION
9050/1D

Parameter Table No. 2-d (PARAM112)

Motor model Drawing No. of motor 9050/D Motor type	6L 0554 74	5L 0552 75	6L 0564 76	5L 0562 77	40S(H) 0583 78	0T(H) 0381 79	5T 0382 80	5T(H) 0383 81	10T 0384 82	10T(H) 0385 83	00SP(H) 0374 84
Symbol	6L	5L	6L	5L	40S(H)	0T(H)	5T	5T(H)	10T	10T(H)	00SP(H)
Parameter No.	0554	0552	0564	0562	0583	0381	0382	0383	0384	0385	0374
FS16. Power Mate C	74	75	76	77	78	79	80	81	82	83	84
INTST	0846	0846	0843	0843	0846	0846	0046	0846	0046	0846	0846
PK1	1040	1612	1527	3646	811	701	670	456	600	409	294
PK2	1041	-4176	-4473	-12091	-3385	-2038	-1600	-1019	-1153	-946	-990
PK3	1042	-2652	-2691	-2659	-2666	-2390	-2473	-2498	-2550	-2543	-2455
PK1V	1043	17	25	15	280	260	287	209	450	349	100
PK2V	1044	-1081	-1852	-1172	-2511	-3329	-2568	-1877	-4034	-3124	-898
PK3V	1045	0	0	0	0	0	0	0	0	0	0
PK4V	1046	-7206	-6177	-6177	-8235	-8235	-8235	-8235	-8235	-8235	-8235
PKA1	1047	768	384	759	1512	1630	1478	2022	941	1215	4228
BLCMP	1048	0	0	0	0	0	0	0	0	0	0
RESERV	1049	0	0	0	0	0	0	0	0	0	0
POK1	1050	956	511	511	956	956	956	956	956	956	956
POK2	1051	510	136	136	510	510	510	510	510	510	510
RESERV	1052	0	0	0	0	0	0	0	0	0	0
PFMAX	1053	21	21	21	21	21	21	21	21	21	21
PDDP	1054	9750	4875	4875	3787	3787	3787	3787	3787	3787	3787
PVST	1055	319	319	319	319	319	319	319	319	319	319
EMFCMP	1056	1240	1097	1097	4800	4008	4400	3684	4590	4008	1971
PYPA	1057	2330	2330	2330	3200	4200	4000	3000	3335	2330	2330
PALPH	1058	57	57	57	60	43	64	64	57	57	57
PPRAS	1059	0	0	0	5	5	0	5	0	5	5
TOLIM	1060	6918	6918	6918	7282	7282	7282	7282	7282	7282	7282
ENLMT	1061	120	120	120	120	120	120	120	120	120	120
POVC1	1062	32614	32614	32698	32345	32703	32669	32714	32532	32625	32569
POVC2	1063	1925	877	1925	5290	819	1235	674	2948	1788	2482
BITPA1	1064	4608	4608	4608	68	68	0	68	0	68	68
TGALMLY	1065	4	4	4	4	4	4	4	4	4	4
POVCLMT	1066	5716	2602	5716	15775	2428	3665	1998	8766	5308	7376
PKZVAUX	1067	0	0	0	0	0	0	0	0	0	0
FILTR	1067	0	0	0	0	0	0	0	0	0	0
BITPA2	256	256	-32512	-32512	0	0	0	0	0	0	0
BITPA3	0	0	0	0	0	0	0	0	0	0	0
BITPA4	0	0	0	0	0	0	0	0	0	0	0
FALPH	2048	1720	2900	2900	0	0	0	0	0	0	0
VFPLT	0	0	0	0	0	0	0	0	0	0	0
ERBLM	1068	0	0	0	0	0	0	0	0	0	0
PBLCT	1070	0	0	0	0	0	0	0	0	0	0
RESERV	1071	0	0	0	0	0	0	0	0	0	0
RESERV	1072	0	0	0	0	0	0	0	0	0	0
RESERV	1073	0	0	0	0	0	0	0	0	0	0
AALPH	1074	0	0	0	0	0	0	2105	0	3421	2917
MODEL	1075	0	0	0	3333	3158	0	0	0	0	0
WKAC	1076	0	0	0	0	0	0	0	0	0	0
OSCTPL	1077	0	0	0	0	0	0	0	0	0	0
RESERV	1078	16384	16384	16384	0	0	0	0	0	0	0
RESERV	1079	0	0	0	0	0	0	0	0	0	0
RESERV	1080	0	0	0	0	0	0	0	0	0	0
RESERV	1081	0	0	0	0	0	0	0	0	0	0
BLENDL	1082	0	0	0	0	0	0	0	0	0	0
MOFCTL	1083	0	0	0	0	0	0	0	0	0	0
SDMR1	1084	0	0	0	0	0	0	0	0	0	0
SDMR2	1085	0	0	0	0	0	0	0	0	0	0
SDMR2	1086	1760	1187	1760	2923	1147	1409	1040	2179	1696	1998
TDPLD	1087	0	0	0	0	0	0	0	0	0	0

8. TABLES OF STANDARD DIGITAL SERVO PARAMETERS

 ROM VERSION
9050/1F

Parameter Table No. 3-a (PARAM113)

9050/F	Motor model Drawing No. of motor Motor type	50S 0331 33	60S 0332 40	70S 0333 41	5-0 0531 42	4-0S 0532 43	3-0S 0533 44	2-0S 0310 45	1-0S 0312 46	0S 0313 47	5S 0314 48	6S 0316 49	10S 0315 50	20S/1500 0505 51	20S 0502 52
	Parameter No.														
	FS16 Power Mate C														
	Symbol														
	INTST	0846	0846	0846	0046	0046	0046	0046	0046	0046	0046	0046	0046	0046	0046
	PK1	999	1451	1334	457	460	736	390	1170	1500	1500	750	2891	1151	1261
	PK2	-3600	-6000	-5297	-999	-730	-1500	-810	-2289	-2400	-2181	-2000	-5840	-2477	-2577
	PK3	-1957	-2259	-2723	-1873	-2373	-2374	-2480	-2485	-2475	-3052	-2596	-2649	-2646	-2646
	PK1V	168	130	145	30	58	53	111	91	113	151	216	260	418	298
	PK2V	-1502	-1165	-1295	-300	-517	-477	-497	-812	-1015	-1355	-1932	-2328	-4103	-2686
	PK3V	0	0	0	0	0	0	0	0	0	0	0	0	0	0
	PK4V	-8235	-8235	-8235	-8235	-8235	-8235	-8235	-8235	-8235	-8235	-8235	-8235	-8235	-8235
	POA1	2576	3259	2931	0	7334	7948	3806	4674	3740	2801	1964	1630	925	1424
	BLCMP	0	0	0	0	0	0	0	0	0	0	0	0	0	0
	RESERV	0	0	0	0	0	0	0	0	0	0	0	0	0	0
	POK1	956	956	956	956	956	956	956	956	956	956	956	956	956	956
	POK2	510	510	510	510	510	510	510	510	510	510	510	510	510	510
	RESERV	0	0	0	0	0	0	0	0	0	0	0	0	0	0
	PPMAX	21	21	21	21	21	21	21	21	21	21	21	21	21	21
	PDDP	3787	3787	3787	3787	3787	3787	3787	3787	3787	3787	3787	3787	3787	3787
	PHYST	319	319	319	319	319	319	319	319	319	319	319	319	319	319
	EMFCMP	4444	4884	6668	0	629	1129	1589	2147	1350	2403	5000	5520	3549	2731
	VPFA	2800	3040	3040	2330	1861	2330	2330	1864	2330	2330	3750	3500	2797	2600
	PALPH	57	57	57	57	46	57	57	46	57	57	64	64	52	57
	PPBAS	20	20	20	20	0	0	0	0	0	0	0	0	0	0
	TOLIM	6560	6560	6560	7282	7282	7282	7282	7282	7282	7282	7282	7282	7282	6918
	ENFLMT	120	120	120	120	120	120	120	120	120	120	120	120	120	120
	POVCI	32419	32499	32281	32514	32543	32576	32623	32627	32722	32677	32485	32339	32155	32386
	POVCC	4365	3358	6086	3173	2817	2401	1811	1766	578	1142	3536	2864	7659	4771
	BITPAL	84	84	84	84	0	0	0	0	0	0	0	0	0	0
	TGALMLV	4	4	4	4	4	4	4	4	4	4	4	4	4	4
	FOVCLMT	13002	9990	18168	9437	8375	7136	5377	5245	1715	3388	10522	8515	22907	14219
	PK2VAUX	0	0	0	0	0	0	0	0	0	0	0	0	0	0
	FILTER	1100	1100	1100	0	0	0	0	0	0	0	0	0	0	0
	RESERV	0	0	0	0	0	0	0	0	0	0	0	0	0	0
	RESERV	0	0	0	0	0	0	0	0	0	0	0	0	0	0
	RESERV	0	0	0	0	0	0	0	0	0	0	0	0	0	0
	FALPH	0	0	0	0	0	0	0	0	0	0	0	0	0	0
	VFFLT	0	0	0	0	0	0	0	0	0	0	0	0	0	0
	ERBLM	0	0	0	0	0	0	0	0	0	0	0	0	0	0
	PBLCT	0	0	0	0	0	0	0	0	0	0	0	0	0	0
	RESERV	0	0	0	0	0	0	0	0	0	0	0	0	0	0
	RESERV	0	0	0	0	0	0	0	0	0	0	0	0	0	0
	RESERV	0	0	0	0	0	0	0	0	0	0	0	0	0	0
	AALPH	400	400	400	0	0	0	0	0	0	0	0	0	0	0
	MODEL	0	0	0	0	0	0	0	0	0	0	0	0	0	0
	WKAC	15	15	15	15	15	15	15	15	15	15	15	15	15	15
	OSCTPL	0	0	0	0	0	0	0	0	0	0	0	0	0	0
	RESERV	0	0	0	0	0	0	0	0	0	0	0	0	0	0
	RESERV	0	0	0	0	0	0	0	0	0	0	0	0	0	0
	RESERV	0	0	0	0	0	0	0	0	0	0	0	0	0	0
	RESERV	0	0	0	0	0	0	0	0	0	0	0	0	0	0
	RESERV	0	0	0	0	0	0	0	0	0	0	0	0	0	0
	BLENDL	0	0	0	0	0	0	0	0	0	0	0	0	0	0
	NOFCTL	0	0	0	0	0	0	0	0	0	0	0	0	0	0
	SDMR1	0	0	0	0	0	0	0	0	0	0	0	0	0	0
	SDMR2	0	0	0	0	0	0	0	0	0	0	0	0	0	0
	RESERV	2653	2326	3137	2291	2129	1966	1706	1685	1064	1354	1966	1768	3801	2285
	RTCURR	0	0	0	0	0	0	0	0	0	0	0	0	0	0
	TDPLD	0	0	0	0	0	0	0	0	0	0	0	0	0	0

8. TABLES OF STANDARD DIGITAL SERVO PARAMETERS

ROM VERSION
9050/F

Parameter Table No. 3-b (PARAM113)

Motor model	30S	30/2000	40	OL	5L	6L	7L	10L	2-OS(H)	1-OS(H)	OS(H)	5S(H)	10S(H)	20S(H)
Drawing No. of motor	0590	0506	0581	0561	0582	0564	0571	0572	0310	0309	0313	0514	0317	0318
Motor type	53	54	55	56	57	58	59	60	61	62	63	64	65	66
Parameter No.														
FS16 Power Mate C														
Symbol	0046	0046	0046	0046	0046	0046	0046	0046	0846	0846	0846	0846	0846	0846
INTST	3414	705	1511	2000	1360	850	590	700	390	450	600	672	1090	542
PK1	1040	0	-7650	-5829	-4000	-2300	-1600	-2000	-810	-900	-1600	-1574	-2360	-1377
PK2	1041	0	-2663	-2672	-2647	-2652	-2685	-2701	-2480	-2503	-2517	-2526	-2654	-2654
PK3	1042	0	201	282	17	34	119	150	111	128	126	136	287	305
PK4	1043	0	-1797	-2526	-159	-309	-1070	-1346	-997	-1146	-1127	-1215	-2571	-2734
PK5	1044	0	0	0	0	0	0	0	0	0	0	0	0	0
PK6	1045	0	-8235	-8235	-8235	-8235	-8235	-8235	-8235	-8235	-8235	-8235	-8235	-8235
PK7	1046	0	1502	23820	24230	12292	3547	2820	3806	3311	3366	3124	1476	1388
PK8	1047	0	0	0	0	0	0	0	0	0	0	0	0	0
PK9	1048	0	0	0	0	0	0	0	0	0	0	0	0	0
PK10	1049	0	0	0	0	0	0	0	0	0	0	0	0	0
PK11	1050	956	956	956	956	956	956	956	956	956	956	956	956	956
PK12	1051	510	510	510	510	510	510	510	510	510	510	510	510	510
PK13	1052	0	0	0	0	0	0	0	0	0	0	0	0	0
PK14	1053	21	21	21	21	21	21	21	21	21	21	21	21	21
PK15	1054	3787	3787	3787	3787	3787	3787	3787	3787	3787	3787	3787	3787	3787
PK16	1055	319	319	319	319	319	319	319	319	319	319	319	319	319
PK17	1056	1961	3478	1075	1097	1240	3200	4000	2100	2520	2520	2520	3780	5400
PK18	1057	7200	2800	2330	2330	2330	2330	2330	2330	2330	2330	2330	2330	2330
PK19	1058	50	57	43	57	57	64	64	57	57	57	57	57	57
PK20	1059	0	0	0	0	0	0	0	0	0	0	0	0	0
PK21	1060	6918	7282	7282	6918	6918	7282	7282	7282	7282	7282	7282	7282	7282
PK22	1061	120	120	120	120	120	120	120	120	120	120	120	120	120
PK23	1062	32530	32340	32895	32598	32614	32299	31875	32623	32519	32712	32594	32578	32495
PK24	1063	2971	6421	5355	912	877	1928	11158	1811	3112	706	924	2381	3410
PK25	1064	0	0	0	0	0	0	0	0	0	0	0	0	0
PK26	1065	4	4	4	4	4	4	4	4	4	4	4	4	4
PK27	1066	8834	19176	15972	2706	5727	17509	32767	5377	9256	2094	2740	7075	10144
PK28	1067	0	0	0	0	0	0	0	0	0	0	0	0	0
PK29	1068	0	0	0	0	0	0	0	0	0	0	0	0	0
PK30	1069	0	0	0	0	0	0	0	0	0	0	0	0	0
PK31	1070	0	0	0	0	0	0	0	0	0	0	0	0	0
PK32	1071	0	0	0	0	0	0	0	0	0	0	0	0	0
PK33	1072	0	0	0	0	0	0	0	0	0	0	0	0	0
PK34	1073	0	0	0	0	0	0	0	0	0	0	0	0	0
PK35	1074	0	0	0	0	0	0	0	0	0	0	0	0	0
PK36	1075	0	0	0	0	0	0	0	0	0	0	0	0	0
PK37	1076	0	0	0	0	0	0	0	0	0	0	0	0	0
PK38	1077	0	0	0	0	0	0	0	0	0	0	0	0	0
PK39	1078	0	0	0	0	0	0	0	0	0	0	0	0	0
PK40	1079	0	0	0	0	0	0	0	0	0	0	0	0	0
PK41	1080	0	0	0	0	0	0	0	0	0	0	0	0	0
PK42	1081	0	0	0	0	0	0	0	0	0	0	0	0	0
PK43	1082	0	0	0	0	0	0	0	0	0	0	0	0	0
PK44	1083	0	0	0	0	0	0	0	0	0	0	0	0	0
PK45	1084	0	0	0	0	0	0	0	0	0	0	0	0	0
PK46	1085	0	0	0	0	0	0	0	0	0	0	0	0	0
PK47	1086	1801	2654	2941	1210	1187	3079	4261	1706	2239	1064	1218	1814	2344
PK48	1087	0	0	0	0	0	0	0	0	0	0	0	0	0
PK49	1088	0	0	0	0	0	0	0	0	0	0	0	0	0

8. TABLES OF STANDARD DIGITAL SERVO PARAMETERS

ROM VERSION
9050/1F

Parameter Table No. 3-c (PARAM113)

Motor model	30S(H)	0L(H)	5L(H)	6L(H)	7L(H)	10L(H)	6S(H)
Drawing No. of motor	0319	0561	0562	0564	0571	0572	73
9050/F Motor type	67	68	69	70	71	72	73
Symbol	Parameter No.	Parameter No.	Parameter No.	Parameter No.	Parameter No.	Parameter No.	Parameter No.
	FS16 Power Mate C						
INTST	0846	0846	0846	0846	0846	0846	0846
PK1	1040	2000	1360	850	590	700	1000
PK2	1041	-1811	-5635	-2300	-1600	-2000	-2400
PK3	1042	-2664	-2647	-2632	-2685	-2701	-2459
PK1V	1043	346	18	34	119	150	135
PK2V	1044	-3097	-159	-309	-1070	-1346	-1205
PK3V	1045	0	0	0	0	0	0
PK4V	1046	-8235	-8235	-8235	-8235	-8235	-8235
POA1	1047	1226	23820	12292	3547	2820	3148
BLCMP	2048	0	0	0	0	0	0
RESERV	2049	0	0	0	0	0	0
POX1	1050	956	956	956	956	956	956
POX2	1051	510	510	510	510	510	510
RESERV	2052	0	0	0	0	0	0
PPMAX	2053	50	21	21	21	21	21
PDPDP	2054	3787	3787	3787	3787	3787	3787
PHYST	2055	319	319	319	319	319	319
EMFCMP	2056	6000	2000	1240	3200	4800	3200
PVPA	2057	2200	2330	2330	3200	3200	2300
PALPH	2058	57	57	57	64	64	64
PPBAS	2059	5	5	5	0	0	5
TLFLM	2060	7282	6918	6918	7282	7282	6918
EMFLMT	2061	120	120	120	120	120	120
POVC1	2062	32470	32698	32614	32299	31875	32693
POVC2	2063	3723	912	877	1928	5667	940
BITPAL	1064	68	68	68	68	68	68
TGALMLV	2064	4	4	4	4	4	4
POVCLMT	1065	11081	2706	2602	5727	17509	2787
PK2VAUX	2066	0	0	0	0	0	0
FILTER	2067	0	0	0	0	0	0
RESERV	2068	0	0	0	0	0	0
RESERV	2069	0	0	0	0	0	0
RESERV	2070	0	0	0	0	0	0
FALPH	1068	0	0	0	0	0	0
VFFLT	1069	0	0	0	0	0	0
ERBLM	2070	0	0	0	0	0	0
PRICT	2071	0	0	0	0	0	0
RESERV	2072	0	0	0	0	0	0
RESERV	2073	0	0	0	0	0	0
AALPH	2074	0	3000	3000	4000	4000	3200
MODEL	2075	0	0	0	0	0	0
WKAC	2076	0	0	0	0	0	0
OSCTPL	2077	0	0	0	0	0	0
RESERV	2078	0	0	0	0	0	0
RESERV	2079	0	0	0	0	0	0
RESERV	2080	0	0	0	0	0	0
RESERV	2081	0	0	0	0	0	0
BLENDL	2082	0	0	0	0	0	0
MOFCTL	2083	0	0	0	0	0	0
SDMR1	2084	0	0	0	0	0	0
SDMR2	2085	0	0	0	0	0	0
RTCURR	2086	2450	1210	1187	1761	3079	4261
TDPLD	2087	0	0	0	0	0	1228

8. TABLES OF STANDARD DIGITAL SERVO PARAMETERS

ROM VERSION
9050/1F

Parameter Table No. 3-d (PARAM113)

Motor model Drawing No. of motor 9050/F Motor type	6L 0564 74	5L 0562 75	6L 0564 76	5L 0562 77	40S(H) 0583 78	0T(H) 0381 79	5T 0382 80	5T(H) 0383 81	10T 0384 82	10T(H) 0385 83	00SP(H) 0374 84
Symbol	0846	0846	0846	0843	0846	0846	0046	0846	0046	0846	0846
INTST	1040	1040	1040	0843	0846	0846	0046	0846	0046	0846	0846
PK1	1041	1041	1041	0843	0846	0846	0046	0846	0046	0846	0846
PK2	1042	1042	1042	0843	0846	0846	0046	0846	0046	0846	0846
PK3	1043	1043	1043	0843	0846	0846	0046	0846	0046	0846	0846
PK4	1044	1044	1044	0843	0846	0846	0046	0846	0046	0846	0846
PK5	1045	1045	1045	0843	0846	0846	0046	0846	0046	0846	0846
PK6	1046	1046	1046	0843	0846	0846	0046	0846	0046	0846	0846
PK7	1047	1047	1047	0843	0846	0846	0046	0846	0046	0846	0846
PK8	1048	1048	1048	0843	0846	0846	0046	0846	0046	0846	0846
PK9	1049	1049	1049	0843	0846	0846	0046	0846	0046	0846	0846
PK10	1050	1050	1050	0843	0846	0846	0046	0846	0046	0846	0846
PK11	1051	1051	1051	0843	0846	0846	0046	0846	0046	0846	0846
PK12	1052	1052	1052	0843	0846	0846	0046	0846	0046	0846	0846
PK13	1053	1053	1053	0843	0846	0846	0046	0846	0046	0846	0846
PK14	1054	1054	1054	0843	0846	0846	0046	0846	0046	0846	0846
PK15	1055	1055	1055	0843	0846	0846	0046	0846	0046	0846	0846
PK16	1056	1056	1056	0843	0846	0846	0046	0846	0046	0846	0846
PK17	1057	1057	1057	0843	0846	0846	0046	0846	0046	0846	0846
PK18	1058	1058	1058	0843	0846	0846	0046	0846	0046	0846	0846
PK19	1059	1059	1059	0843	0846	0846	0046	0846	0046	0846	0846
PK20	1060	1060	1060	0843	0846	0846	0046	0846	0046	0846	0846
PK21	1061	1061	1061	0843	0846	0846	0046	0846	0046	0846	0846
PK22	1062	1062	1062	0843	0846	0846	0046	0846	0046	0846	0846
PK23	1063	1063	1063	0843	0846	0846	0046	0846	0046	0846	0846
PK24	1064	1064	1064	0843	0846	0846	0046	0846	0046	0846	0846
PK25	1065	1065	1065	0843	0846	0846	0046	0846	0046	0846	0846
PK26	1066	1066	1066	0843	0846	0846	0046	0846	0046	0846	0846
PK27	1067	1067	1067	0843	0846	0846	0046	0846	0046	0846	0846
PK28	1068	1068	1068	0843	0846	0846	0046	0846	0046	0846	0846
PK29	1069	1069	1069	0843	0846	0846	0046	0846	0046	0846	0846
PK30	1070	1070	1070	0843	0846	0846	0046	0846	0046	0846	0846
PK31	1071	1071	1071	0843	0846	0846	0046	0846	0046	0846	0846
PK32	1072	1072	1072	0843	0846	0846	0046	0846	0046	0846	0846
PK33	1073	1073	1073	0843	0846	0846	0046	0846	0046	0846	0846
PK34	1074	1074	1074	0843	0846	0846	0046	0846	0046	0846	0846
PK35	1075	1075	1075	0843	0846	0846	0046	0846	0046	0846	0846
PK36	1076	1076	1076	0843	0846	0846	0046	0846	0046	0846	0846
PK37	1077	1077	1077	0843	0846	0846	0046	0846	0046	0846	0846
PK38	1078	1078	1078	0843	0846	0846	0046	0846	0046	0846	0846
PK39	1079	1079	1079	0843	0846	0846	0046	0846	0046	0846	0846
PK40	1080	1080	1080	0843	0846	0846	0046	0846	0046	0846	0846
PK41	1081	1081	1081	0843	0846	0846	0046	0846	0046	0846	0846
PK42	1082	1082	1082	0843	0846	0846	0046	0846	0046	0846	0846
PK43	1083	1083	1083	0843	0846	0846	0046	0846	0046	0846	0846
PK44	1084	1084	1084	0843	0846	0846	0046	0846	0046	0846	0846
PK45	1085	1085	1085	0843	0846	0846	0046	0846	0046	0846	0846
PK46	1086	1086	1086	0843	0846	0846	0046	0846	0046	0846	0846
PK47	1087	1087	1087	0843	0846	0846	0046	0846	0046	0846	0846

8. TABLES OF STANDARD DIGITAL SERVO PARAMETERS

 ROM VERSION
9050/1G

Parameter Table No. 4-a (PARAM114)

Motor model Drawing No. of motor	Parameter No.																20S/1500 0505	20S 0502
	50S 0331	60S 0332	70S 0333	5-0 0431	4-0S 0532	3-0S 0533	2-0S 0310	1-0S 0312	0S 0313	5S 0314	6S 0316	10S 0315	20S/1500 0505	20S 0502				
9050/G Motor type	039	40	41	42	43	44	45	46	47	48	49	50	51	52				
Symbol	0846	0846	0846	0846	0846	0846	0846	0846	0846	0846	0846	0846	0846	0846	0846	0846		
1:1ST	0846	0846	0846	0846	0846	0846	0846	0846	0846	0846	0846	0846	0846	0846	0846	0846		
PA1	1040	1040	1040	1040	1040	1040	1040	1040	1040	1040	1040	1040	1040	1040	1040	1040		
PA2	1041	1041	1041	1041	1041	1041	1041	1041	1041	1041	1041	1041	1041	1041	1041	1041		
PK3	2041	2041	2041	2041	2041	2041	2041	2041	2041	2041	2041	2041	2041	2041	2041	2041		
PK3V	2042	2042	2042	2042	2042	2042	2042	2042	2042	2042	2042	2042	2042	2042	2042	2042		
PK4V	2043	2043	2043	2043	2043	2043	2043	2043	2043	2043	2043	2043	2043	2043	2043	2043		
PK2V	2044	2044	2044	2044	2044	2044	2044	2044	2044	2044	2044	2044	2044	2044	2044	2044		
PK3V	2045	2045	2045	2045	2045	2045	2045	2045	2045	2045	2045	2045	2045	2045	2045	2045		
PK4V	2046	2046	2046	2046	2046	2046	2046	2046	2046	2046	2046	2046	2046	2046	2046	2046		
POA1	2047	2047	2047	2047	2047	2047	2047	2047	2047	2047	2047	2047	2047	2047	2047	2047		
BLGMP	2048	2048	2048	2048	2048	2048	2048	2048	2048	2048	2048	2048	2048	2048	2048	2048		
RESERV	2049	2049	2049	2049	2049	2049	2049	2049	2049	2049	2049	2049	2049	2049	2049	2049		
POX1	2050	2050	2050	2050	2050	2050	2050	2050	2050	2050	2050	2050	2050	2050	2050	2050		
POX2	2051	2051	2051	2051	2051	2051	2051	2051	2051	2051	2051	2051	2051	2051	2051	2051		
RESERV	2052	2052	2052	2052	2052	2052	2052	2052	2052	2052	2052	2052	2052	2052	2052	2052		
PPMAX	2053	2053	2053	2053	2053	2053	2053	2053	2053	2053	2053	2053	2053	2053	2053	2053		
POXP	2054	2054	2054	2054	2054	2054	2054	2054	2054	2054	2054	2054	2054	2054	2054	2054		
POXP	2055	2055	2055	2055	2055	2055	2055	2055	2055	2055	2055	2055	2055	2055	2055	2055		
EMCMP	2056	2056	2056	2056	2056	2056	2056	2056	2056	2056	2056	2056	2056	2056	2056	2056		
PPA	2057	2057	2057	2057	2057	2057	2057	2057	2057	2057	2057	2057	2057	2057	2057	2057		
PALPH	2058	2058	2058	2058	2058	2058	2058	2058	2058	2058	2058	2058	2058	2058	2058	2058		
PPDAS	2059	2059	2059	2059	2059	2059	2059	2059	2059	2059	2059	2059	2059	2059	2059	2059		
TQLIN	2060	2060	2060	2060	2060	2060	2060	2060	2060	2060	2060	2060	2060	2060	2060	2060		
ENELMT	2061	2061	2061	2061	2061	2061	2061	2061	2061	2061	2061	2061	2061	2061	2061	2061		
POVCL	2062	2062	2062	2062	2062	2062	2062	2062	2062	2062	2062	2062	2062	2062	2062	2062		
POVCL	2063	2063	2063	2063	2063	2063	2063	2063	2063	2063	2063	2063	2063	2063	2063	2063		
BITPA1	2064	2064	2064	2064	2064	2064	2064	2064	2064	2064	2064	2064	2064	2064	2064	2064		
TGALMLV	2065	2065	2065	2065	2065	2065	2065	2065	2065	2065	2065	2065	2065	2065	2065	2065		
POVCLMT	2066	2066	2066	2066	2066	2066	2066	2066	2066	2066	2066	2066	2066	2066	2066	2066		
PK2VALX	2067	2067	2067	2067	2067	2067	2067	2067	2067	2067	2067	2067	2067	2067	2067	2067		
FILTR	2068	2068	2068	2068	2068	2068	2068	2068	2068	2068	2068	2068	2068	2068	2068	2068		
RESERV	2069	2069	2069	2069	2069	2069	2069	2069	2069	2069	2069	2069	2069	2069	2069	2069		
RESERV	2070	2070	2070	2070	2070	2070	2070	2070	2070	2070	2070	2070	2070	2070	2070	2070		
RESERV	2071	2071	2071	2071	2071	2071	2071	2071	2071	2071	2071	2071	2071	2071	2071	2071		
RESERV	2072	2072	2072	2072	2072	2072	2072	2072	2072	2072	2072	2072	2072	2072	2072	2072		
RESERV	2073	2073	2073	2073	2073	2073	2073	2073	2073	2073	2073	2073	2073	2073	2073	2073		
AALPH	2074	2074	2074	2074	2074	2074	2074	2074	2074	2074	2074	2074	2074	2074	2074	2074		
MODEL	2075	2075	2075	2075	2075	2075	2075	2075	2075	2075	2075	2075	2075	2075	2075	2075		
YKAC	2076	2076	2076	2076	2076	2076	2076	2076	2076	2076	2076	2076	2076	2076	2076	2076		
OSCTPL	2077	2077	2077	2077	2077	2077	2077	2077	2077	2077	2077	2077	2077	2077	2077	2077		
RESERV	2078	2078	2078	2078	2078	2078	2078	2078	2078	2078	2078	2078	2078	2078	2078	2078		
RESERV	2079	2079	2079	2079	2079	2079	2079	2079	2079	2079	2079	2079	2079	2079	2079	2079		
RESERV	2080	2080	2080	2080	2080	2080	2080	2080	2080	2080	2080	2080	2080	2080	2080	2080		
RESERV	2081	2081	2081	2081	2081	2081	2081	2081	2081	2081	2081	2081	2081	2081	2081	2081		
BLENDL	2082	2082	2082	2082	2082	2082	2082	2082	2082	2082	2082	2082	2082	2082	2082	2082		
NOFCTL	2083	2083	2083	2083	2083	2083	2083	2083	2083	2083	2083	2083	2083	2083	2083	2083		
SDMR1	2084	2084	2084	2084	2084	2084	2084	2084	2084	2084	2084	2084	2084	2084	2084	2084		
SDMR2	2085	2085	2085	2085	2085	2085	2085	2085	2085	2085	2085	2085	2085	2085	2085	2085		
FTCURR	2086	2086	2086	2086	2086	2086	2086	2086	2086	2086	2086	2086	2086	2086	2086	2086		
TDPLD	2087	2087	2087	2087	2087	2087	2087	2087	2087	2087	2087	2087	2087	2087	2087	2087		
MCXFB	2088	2088	2088	2088	2088	2088	2088	2088	2088	2088	2088	2088	2088	2088	2088	2088		
RESERV	2089	2089	2089	2089	2089	2089	2089	2089	2089	2089	2089	2089	2089	2089	2089	2089		
RESERV	2090	2090	2090	2090	2090	2090	2090	2090	2090	2090	2090	2090	2090	2090	2090	2090		
RESERV	2091	2091	2091	2091	2091	2091	2091	2091	2091	2091	2091	2091	2091	2091	2091	2091		
ACCPL	2092	2092	2092	2092	2092	2092	2092	2092	2092	2092	2092	2092	2092	2092	2092	2092		
VMPK3V	2093	2093	2093	2093	2093	2093	2093	2093	2093	2093	2093	2093	2093	2093	2093	2093		
BLCMP2	2094	2094	2094	2094	2094	2094	2094	2094	2094	2094	2094	2094	2094	2094	2094	2094		
AHORL	2095	2095	2095	2095	2095	2095	2095	2095	2095	2095	2095	2095	2095	2095	2095	2095		
RAHLSL	2096	2096	2096	2096	2096	2096	2096	2096	2096	2096	2096	2096	2096	2096	2096	2096		
RESERV	2097	2097	2097	2097	2097	2097	2097	2097	2097	2097	2097	2097	2097	2097	2097	2097		
RESERV	2098	2098	2098	2098	2098	2098	2098	2098	2098	2098	2098	2098	2098	2098	2098	2098		
DEPFL	2099	2099	2099	2099	2099	2099	2099	2099	2099	2099	2099	2099	2099	2099	2099	2099		
ONEPFL	2099	2099	2099	2099	2099	2099	2099	2099	2099	2099	2099	2099	2099	2099	2099	2099		

8. TABLES OF STANDARD DIGITAL SERVO PARAMETERS

ROM VERSION
9050/1G

Parameter Table No. 4-c (PARAM114)

Motor model Drawing No. of motor 9050/G Motor type	30S(H) 0319 61	01(H) 0561 88	5L(H) 0652 89	6L(H) 0564 70	7L(H) 0571 71	10L(H) 0572 72	6S(H) 0572 73
Symbol	Parameter No. FS16 Power Mate C						
INTST	0846	0846	0846	0846	0846	0846	0846
PK1	2040	2000	1360	850	590	700	1000
PK2	2041	-1811	-5635	-4000	-1600	-2000	-2400
PK3	2042	-2614	-2647	-2652	-2685	-2701	-2459
PK1V	2043	346	18	34	119	150	135
PK2V	2044	-3097	-159	-309	-1070	-1346	-1205
PK3V	2045	0	0	0	0	0	0
PK4V	2046	-8235	-8235	-8235	-8235	-8235	-8235
PK4	2047	1226	23620	24290	12292	3447	3148
BLCMP	2048	0	0	0	0	0	0
RESERV	2049	0	0	0	0	0	0
PK1Z	2050	956	956	956	956	956	956
PK2Z	2051	510	510	510	510	510	510
RESERV	2052	0	0	0	0	0	0
PK3Z	2053	50	21	21	21	21	21
PK3A	2054	3767	3767	3767	3767	3767	3767
PK3B	2055	319	319	319	319	319	319
PK3C	2056	6000	2000	1240	3200	4800	3200
PK3D	2057	2200	2330	2330	3200	3200	2300
PK3E	2058	57	57	57	64	64	64
PK3F	2059	5	5	5	0	0	5
PK3G	2060	7282	6918	6918	7282	7282	6918
PK3H	2061	1061	120	120	120	120	120
PK3I	2062	32470	32698	32614	32299	31875	32693
PK3J	2063	3723	912	877	1928	5667	940
PK3K	2064	68	68	68	68	68	68
PK3L	2065	4	4	4	4	4	4
PK3M	2066	11081	2706	2602	5727	17609	2787
PK3N	2067	0	0	0	0	0	0
RESERV	2068	0	0	0	0	0	0
RESERV	2069	0	0	0	0	0	0
RESERV	2070	0	0	0	0	0	0
RESERV	2071	0	0	0	0	0	0
RESERV	2072	0	0	0	0	0	0
RESERV	2073	0	0	0	0	0	0
RESERV	2074	0	3000	3000	4000	4000	3200
RESERV	2075	0	0	0	0	0	0
RESERV	2076	0	0	0	0	0	0
RESERV	2077	0	0	0	0	0	0
RESERV	2078	0	0	0	0	0	0
RESERV	2079	0	0	0	0	0	0
RESERV	2080	0	0	0	0	0	0
RESERV	2081	0	0	0	0	0	0
RESERV	2082	0	0	0	0	0	0
RESERV	2083	0	0	0	0	0	0
RESERV	2084	0	0	0	0	0	0
RESERV	2085	0	0	0	0	0	0
RESERV	2086	2450	1210	1187	1751	4261	1228
RESERV	2087	0	0	0	0	0	0
RESERV	2088	0	0	0	0	0	0
RESERV	2089	0	0	0	0	0	0
RESERV	2090	0	0	0	0	0	0
RESERV	2091	0	0	0	0	0	0
RESERV	2092	0	0	0	0	0	0
RESERV	2093	0	0	0	0	0	0
RESERV	2094	0	0	0	0	0	0
RESERV	2095	0	0	0	0	0	0
RESERV	2096	0	0	0	0	0	0
RESERV	2097	0	0	0	0	0	0
RESERV	2098	0	0	0	0	0	0
RESERV	2099	400	400	400	400	400	400

8. TABLES OF STANDARD DIGITAL SERVO PARAMETERS

ROM VERSION
9050/1G

Parameter Table No. 4-d (PARAM114)

Motor model Drawing No. of motor 9050/g Motor type	6L 74	5L 75	6L 76	5L 77	40S(H) 78	OT(H) 79	5T 80	5T(H) 81	LOT 82	LOT(H) 83	QOSP(H) 84
Symbol	0846	0845	0843	0843	0845	0846	0046	0845	0046	0846	0845
FS16 Power Mate C	0846	0845	0843	0843	0845	0846	0046	0845	0046	0846	0845
IMTST	1040	1612	1527	3846	892	701	570	456	600	409	294
PK1	1041	-2661	-4473	-12081	-2877	-2038	-1500	-1019	-1153	-346	-990
PK2	2042	-2652	-2691	-2889	-2656	-2300	-2473	-2498	-2550	-243	-2455
PK3	2043	317	55	200	287	209	209	209	450	349	100
PK4	2044	-1081	-602	-1172	-2311	-2329	-2368	-1877	-4034	-3124	-838
PK5	2045	0	-7206	0	0	0	0	0	0	0	0
PK6	2046	768	1518	384	759	1512	1630	1478	2022	941	4228
PK7	2047	0	0	0	0	0	0	0	0	0	0
PK8	2048	0	0	0	0	0	0	0	0	0	0
PK9	2049	956	511	511	956	956	956	956	956	956	956
PK10	2050	510	510	136	510	510	510	510	510	510	510
PK11	2051	0	0	0	0	0	0	0	0	0	0
PK12	2052	0	0	0	0	0	0	0	0	0	0
PK13	2053	21	21	21	50	21	21	21	21	21	21
PK14	2054	9750	4875	4875	3787	3787	3787	3787	3787	3787	3787
PK15	2055	319	319	319	319	319	319	319	319	319	319
PK16	2056	1240	1097	1240	1097	4008	4400	3684	4590	4008	1971
PK17	2057	2330	2330	2330	3200	4300	4000	3000	3335	2330	2330
PK18	2058	57	57	57	60	43	64	64	57	57	57
PK19	2059	0	0	0	0	0	0	0	0	0	0
PK20	2060	6918	6918	6918	7282	7282	7282	7282	7282	7282	7282
PK21	2061	120	120	120	120	120	120	120	120	120	120
PK22	2062	32598	32598	32598	32345	32703	32589	32714	32532	32525	32569
PK23	2063	1925	877	877	5290	819	1235	674	2548	1788	2482
PK24	2064	4608	4608	4608	68	68	0	68	0	68	68
PK25	2065	5716	2602	5716	4	4	4	4	4	4	4
PK26	2066	0	0	0	0	0	0	0	0	0	0
PK27	2067	255	256	-32512	-32512	0	0	0	0	0	0
PK28	2068	1720	2900	2900	2900	0	0	0	0	0	0
PK29	2069	0	0	0	0	0	0	0	0	0	0
PK30	2070	0	0	0	0	0	0	0	0	0	0
PK31	2071	0	0	0	0	0	0	0	0	0	0
PK32	2072	0	0	0	0	0	0	0	0	0	0
PK33	2073	0	0	0	0	0	0	0	0	0	0
PK34	2074	0	0	0	0	0	0	0	0	0	0
PK35	2075	0	0	0	0	0	0	0	0	0	0
PK36	2076	0	0	0	0	0	0	0	0	0	0
PK37	2077	0	0	0	0	0	0	0	0	0	0
PK38	2078	16384	16384	16384	16384	0	0	0	0	0	0
PK39	2079	0	0	0	0	0	0	0	0	0	0
PK40	2080	0	0	0	0	0	0	0	0	0	0
PK41	2081	0	0	0	0	0	0	0	0	0	0
PK42	2082	0	0	0	0	0	0	0	0	0	0
PK43	2083	0	0	0	0	0	0	0	0	0	0
PK44	2084	0	0	0	0	0	0	0	0	0	0
PK45	2085	0	0	0	0	0	0	0	0	0	0
PK46	2086	1187	1187	1760	1187	1147	1409	1040	2179	1696	1998
PK47	2087	0	0	0	0	0	0	0	0	0	0
PK48	2088	0	0	0	0	0	0	0	0	0	0
PK49	2089	0	0	0	0	0	0	0	0	0	0
PK50	2090	0	0	0	0	0	0	0	0	0	0
PK51	2091	0	0	0	0	0	0	0	0	0	0
PK52	2092	0	0	0	0	0	0	0	0	0	0
PK53	2093	0	0	0	0	0	0	0	0	0	0
PK54	2094	0	0	0	0	0	0	0	0	0	0
PK55	2095	0	0	0	0	0	0	0	0	0	0
PK56	2096	0	0	0	0	0	0	0	0	0	0
PK57	2097	0	0	0	0	0	0	0	0	0	0
PK58	2098	0	0	0	0	0	0	0	0	0	0
PK59	2099	400	400	400	400	400	400	400	400	400	400

8. TABLES OF STANDARD DIGITAL SERVO PARAMETERS

FROM VERSION
9050/11

Parameter Table No. 5-b (PARAM116)

Motor model	30S	30/2000	40	0L(C)	5L(C)	6L(C)	7L(C)	10L(C)	2-OS(H)	1-OS(H)	OS(H)	5S(H)	10S(H)	20S(H)	
Drawing No. of motor	0590	0506	0581	0561	0562	0564	0571	0572	0510	0309	0313	0514	0317	0318	
Motor type	53	54	55	56	57	58	59	60	61	62	63	64	65	66	
Parameter No.															
FS16 Power Mate C															
Symbol															
1XTST	0046	0046	0046	0846	0846	0846	0846	0846	0846	0846	0846	0846	0846	0846	0846
PK1	3414	705	1511	1600	1360	850	590	700	390	430	600	672	1090	542	542
PK2	2041	-2716	-5629	-4508	-4000	-2300	-1600	-2000	-810	-900	-1600	-1574	-2360	-1377	-1377
PK3	2042	-2663	-2672	-2614	-2547	-2652	-2685	-2701	-2480	-2503	-2517	-2526	-2654	-2654	-2654
PK4	2043	201	375	282	17	34	92	116	111	128	126	136	287	305	305
PK5	2044	-1797	-3356	-2526	-159	-309	-623	-1035	-997	-1146	-1127	-1215	-2571	-2734	-2734
PK6	2045	0	0	0	0	0	0	0	0	0	0	0	0	0	0
PK7	2046	-8235	-8235	-8235	-8235	-8235	-8235	-8235	-8235	-8235	-8235	-8235	-8235	-8235	-8235
PK8	2047	2117	1131	1507	24290	12332	4511	3666	3806	3211	3366	3124	1476	1388	1388
PK9	2048	0	0	0	0	0	0	0	0	0	0	0	0	0	0
PK10	2049	0	0	0	0	0	0	0	0	0	0	0	0	0	0
PK11	2050	956	956	956	956	956	956	956	956	956	956	956	956	956	956
PK12	2051	510	510	510	510	510	510	510	510	510	510	510	510	510	510
PK13	2052	0	0	0	0	0	0	0	0	0	0	0	0	0	0
PK14	2053	21	21	21	21	21	21	21	21	21	21	21	21	21	21
PK15	2054	3787	3787	3787	3787	3787	3787	3787	3787	3787	3787	3787	3787	3787	3787
PK16	2055	319	319	319	319	319	319	319	319	319	319	319	319	319	319
PK17	2056	5456	1961	3478	2000	1240	4500	4800	2100	2520	2520	2520	3780	5400	5400
PK18	2057	7200	2330	2800	2330	2330	3000	3200	2330	2330	2330	2330	2330	2330	2330
PK19	2058	50	57	43	57	57	64	64	57	57	57	57	57	57	57
PK20	2059	0	0	0	0	0	0	0	0	0	0	0	0	0	0
PK21	2060	6918	6554	7282	5462	7282	7282	7282	7282	7282	7282	7282	7282	7282	7282
PK22	2061	120	120	120	120	120	120	120	120	120	120	120	120	120	120
PK23	2062	32530	3254	32340	32585	32514	32489	32237	32519	32519	32712	32594	32578	32495	32495
PK24	2063	2371	6421	5355	912	1928	3482	6640	1811	3112	706	924	2381	3410	3410
PK25	2064	0	0	0	0	0	0	0	0	0	0	0	0	0	0
PK26	2065	4	4	4	4	4	4	4	4	4	4	4	4	4	4
PK27	2066	8334	15976	15972	2706	5727	10360	32707	5577	5556	2692	2740	705	1014	1014
PK28	2067	0	0	0	0	0	0	0	0	0	0	0	0	0	0
PK29	2068	0	0	0	0	0	0	0	0	0	0	0	0	0	0
PK30	2069	0	0	0	0	0	0	0	0	0	0	0	0	0	0
PK31	2070	0	0	0	0	0	0	0	0	0	0	0	0	0	0
PK32	2071	0	0	0	0	0	0	0	0	0	0	0	0	0	0
PK33	2072	0	0	0	0	0	0	0	0	0	0	0	0	0	0
PK34	2073	0	0	0	0	0	0	0	0	0	0	0	0	0	0
PK35	2074	0	0	0	0	0	0	0	0	0	0	0	0	0	0
PK36	2075	0	0	0	0	0	0	0	0	0	0	0	0	0	0
PK37	2076	0	0	0	0	0	0	0	0	0	0	0	0	0	0
PK38	2077	0	0	0	0	0	0	0	0	0	0	0	0	0	0
PK39	2078	0	0	0	0	0	0	0	0	0	0	0	0	0	0
PK40	2079	0	0	0	0	0	0	0	0	0	0	0	0	0	0
PK41	2080	0	0	0	0	0	0	0	0	0	0	0	0	0	0
PK42	2081	0	0	0	0	0	0	0	0	0	0	0	0	0	0
PK43	2082	0	0	0	0	0	0	0	0	0	0	0	0	0	0
PK44	2083	0	0	0	0	0	0	0	0	0	0	0	0	0	0
PK45	2084	0	0	0	0	0	0	0	0	0	0	0	0	0	0
PK46	2085	0	0	0	0	0	0	0	0	0	0	0	0	0	0
PK47	2086	1801	2654	2941	1210	1761	2369	3277	1706	2239	1064	1218	1814	2344	2344
PK48	2087	0	0	0	0	0	0	0	0	0	0	0	0	0	0
PK49	2088	0	0	0	0	0	0	0	0	0	0	0	0	0	0
PK50	2089	0	0	0	0	0	0	0	0	0	0	0	0	0	0
PK51	2090	0	0	0	0	0	0	0	0	0	0	0	0	0	0
PK52	2091	0	0	0	0	0	0	0	0	0	0	0	0	0	0
PK53	2092	0	0	0	0	0	0	0	0	0	0	0	0	0	0
PK54	2093	0	0	0	0	0	0	0	0	0	0	0	0	0	0
PK55	2094	0	0	0	0	0	0	0	0	0	0	0	0	0	0
PK56	2095	0	0	0	0	0	0	0	0	0	0	0	0	0	0
PK57	2096	0	0	0	0	0	0	0	0	0	0	0	0	0	0
PK58	2097	0	0	0	0	0	0	0	0	0	0	0	0	0	0
PK59	2098	0	0	0	0	0	0	0	0	0	0	0	0	0	0
PK60	2099	400	400	400	400	400	400	400	400	400	400	400	400	400	400

8. TABLES OF STANDARD DIGITAL SERVO PARAMETERS

ROM VERSION
9050/11

Parameter Table No. 5-c (PARAM116)

Symbol	Motor model Drawing No. of motor	30S(H)	0L(H)	5L(H)	5L(H)	6L(H)	7L(H)	10L(H)	6S(H)
9050/1 Motor type	Parameter No.	67	68	69	70	71	72	73	
F.S16 Power Mate C									
INTST		0846	0846	0846	0846	0846	0846	0846	0846
PK1	1040	708	1600	1360	850	590	590	700	1000
PK2	1041	-1811	-4508	-4000	-2300	-1600	-2000	-2000	-2400
PK3	1042	-2664	-2614	-2647	-2652	-2701	-2459	-2459	-2459
PK4	1043	346	18	17	34	119	150	135	135
PK5	1044	-3037	-159	-156	-309	-1070	-1346	-1205	-1205
PK6	1045	0	0	0	0	0	0	0	0
PK7	1046	-8235	-8235	-8235	-8235	-8235	-8235	-8235	-8235
PK8	1047	1725	23820	24290	17292	3547	2820	3148	3148
PK9	1048	0	0	0	0	0	0	0	0
RESERV	1049	0	0	0	0	0	0	0	0
PK10	1050	956	956	956	956	956	956	956	956
PK11	1051	510	510	510	510	510	510	510	510
RESERV	1052	0	0	0	0	0	0	0	0
PPMAX	1053	50	21	21	21	21	21	21	21
PDP	1054	3787	3787	3787	3787	3787	3787	3787	3787
PHYST	1055	319	319	319	319	319	319	319	319
EMPCMP	1056	6000	2000	2000	1240	4500	4800	3200	3200
PVPA	1057	2200	2330	2330	2330	3000	3200	2300	2300
PALPH	1058	57	57	57	57	64	64	64	64
PBRAS	1059	5	5	5	5	5	5	5	5
TOLIN	1060	7282	5462	5462	7282	7282	7282	7282	7282
EMFLT	1061	170	170	170	170	170	170	170	170
POVCL	1062	32495	32495	32495	32495	32495	32495	32495	32495
POVCL	1063	3722	3722	3722	3722	3722	3722	3722	3722
BITP1	1064	68	68	68	68	68	68	68	68
BITP2	1065	4	4	4	4	4	4	4	4
BITP3	1066	11091	2706	2602	5727	17509	32767	2787	2787
BITP4	1067	0	0	0	0	0	0	0	0
BITP5	1068	0	0	0	0	0	0	0	0
BITP6	1069	0	0	0	0	0	0	0	0
BITP7	1070	0	0	0	0	0	0	0	0
BITP8	1071	0	0	0	0	0	0	0	0
BITP9	1072	0	0	0	0	0	0	0	0
RESERV	1073	0	0	0	0	0	0	0	0
RESERV	1074	0	0	0	0	0	0	0	0
RESERV	1075	0	3000	3000	4000	4000	4000	3200	3200
MODEL	1076	0	0	0	0	0	0	0	0
MODEL	1077	0	0	0	0	0	0	0	0
MAC	1078	0	0	0	0	0	0	0	0
OSSTL	1079	0	0	0	0	0	0	0	0
RESERV	1080	0	0	0	0	0	0	0	0
RESERV	1081	0	0	0	0	0	0	0	0
RESERV	1082	0	0	0	0	0	0	0	0
RESERV	1083	0	0	0	0	0	0	0	0
RESERV	1084	0	0	0	0	0	0	0	0
RESERV	1085	0	0	0	0	0	0	0	0
RESERV	1086	2450	1210	1187	1761	3079	4261	1228	1228
RESERV	1087	0	0	0	0	0	0	0	0
RESERV	1088	0	0	0	0	0	0	0	0
RESERV	1089	0	0	0	0	0	0	0	0
RESERV	1090	0	0	0	0	0	0	0	0
RESERV	1091	0	0	0	0	0	0	0	0
RESERV	1092	0	0	0	0	0	0	0	0
RESERV	1093	0	0	0	0	0	0	0	0
RESERV	1094	0	0	0	0	0	0	0	0
RESERV	1095	0	0	0	0	0	0	0	0
RESERV	1096	0	0	0	0	0	0	0	0
RESERV	1097	0	0	0	0	0	0	0	0
RESERV	1098	0	0	0	0	0	0	0	0
RESERV	1099	400	400	400	400	400	400	400	400

8. TABLES OF STANDARD DIGITAL SERVO PARAMETERS

 ROM VERSION
9050/11

Parameter Table No. 5-d (PARAM116)

Motor model	6L	5L	6L	5L	6L	5L	40S(H)	0T(H)	5T	5T(H)	10T	10T(H)	00SP
Drawing No. of motor	0564	0562	0564	0562	0564	0562	0583	0381	0382	0383	0384	0385	0374
Motor type	74	75	76	75	76	77	78	79	80	81	82	83	84
Parameter No.	Power Mate C												
Symbol	0846	0846	0843	0846	0843	0843	0846	0846	0046	0846	0046	0846	0846
INTST	0846	0846	0843	0846	0843	0843	0846	0846	0046	0846	0046	0846	0846
PK1	1040	1051	1527	1612	1527	3646	892	701	670	456	600	409	294
PK2	2041	1041	-473	-4176	-473	-12081	-2877	-2038	-1600	-1019	-1153	-946	-990
PK3	2042	-2652	-2691	-2647	-2691	-2689	-2666	-2390	-2473	-2498	-2550	-2445	-2455
PK1V	1043	17	21	15	21	15	280	280	287	209	450	349	70
PK2V	1044	-1081	-1852	-602	-1852	-1172	-2511	-2329	-2568	-1877	-4034	-3124	-898
PK3V	1045	0	0	0	0	0	0	0	0	0	0	0	0
PK4V	2046	-7206	-6177	-2206	-6177	-6177	-8235	-8235	-8235	-8235	-8235	-8235	-8235
POA1	2047	1518	384	1518	384	759	1512	1630	1478	2022	941	1215	4228
BLCAP	2048	0	0	0	0	0	0	0	0	0	0	0	0
RESERY	2049	0	0	0	0	0	0	0	0	0	0	0	0
POK1	2050	956	511	956	511	511	956	956	956	956	956	956	956
POK2	2051	510	136	510	136	136	510	510	510	510	510	510	510
RESERY	2052	0	0	0	0	0	0	0	0	0	0	0	0
PPMAX	2053	21	21	21	21	21	50	21	21	21	21	21	21
PDPP	2054	9750	4875	9750	4875	4875	3787	3787	3787	3787	3787	3787	3787
PHVST	2055	319	319	319	319	319	319	319	319	319	319	319	319
ENFCMP	2056	1240	1097	1240	1097	1097	4800	4008	4400	3884	4590	4008	1971
PVPA	2057	2330	2330	2330	2330	2330	3200	4200	4000	3000	3335	2330	2330
P1LPH	2058	57	57	57	57	57	60	43	64	64	57	57	57
PBRAS	2059	0	0	0	0	0	5	5	0	5	0	5	5
TO1V	2060	6918	6918	6918	6918	6918	7282	7282	7282	7282	7282	7282	7282
EXP1AT	2061	1120	1120	1120	1120	1120	1220	1220	1220	1220	1220	1220	1220
POYCI	2062	32514	32696	32514	32696	32696	32345	32703	32703	32714	32532	32523	32589
POYC2	2063	1525	877	1525	877	877	5290	815	1235	674	2948	1788	2462
BITTT	2064	4598	4508	4598	4508	4508	68	62	62	62	62	62	62
TGALLV	2064	4	4	4	4	4	4	4	4	4	4	4	4
POVCLV	2065	5716	2602	5716	2602	2602	15775	2428	3555	1998	8766	5308	7375
PR2VAVX	2066	0	0	0	0	0	0	0	0	0	0	0	0
FILTRV	2067	256	256	256	256	256	0	0	0	0	0	0	0
RESERY	2068	0	0	0	0	0	0	0	0	0	0	0	0
RESERY	2069	0	0	0	0	0	0	0	0	0	0	0	0
RESERY	2070	0	0	0	0	0	0	0	0	0	0	0	0
RESERY	2071	0	0	0	0	0	0	0	0	0	0	0	0
RESERY	2072	0	0	0	0	0	0	0	0	0	0	0	0
RESERY	2073	0	0	0	0	0	0	0	0	0	0	0	0
RESERY	2074	0	0	0	0	0	0	0	0	0	0	0	0
MODEL	2075	0	0	0	0	0	3333	3158	0	2105	0	3421	2917
WKAC	2076	0	0	0	0	0	0	0	0	0	0	0	0
OSCTPL	2077	16384	16384	16384	16384	16384	0	0	0	0	0	0	0
RESERY	2078	0	0	0	0	0	0	0	0	0	0	0	0
RESERY	2079	0	0	0	0	0	0	0	0	0	0	0	0
RESERY	2080	0	0	0	0	0	0	0	0	0	0	0	0
RESERY	2081	0	0	0	0	0	0	0	0	0	0	0	0
RESERY	2082	0	0	0	0	0	0	0	0	0	0	0	0
RESERY	2083	0	0	0	0	0	0	0	0	0	0	0	0
RESERY	2084	0	0	0	0	0	0	0	0	0	0	0	0
RESERY	2085	0	0	0	0	0	0	0	0	0	0	0	0
RESERY	2086	1760	1187	1760	1187	1187	2923	1147	1408	1040	2178	1696	1998
RESERY	2087	0	0	0	0	0	0	0	0	0	0	0	0
RESERY	2088	0	0	0	0	0	0	0	0	0	0	0	0
RESERY	2089	0	0	0	0	0	0	0	0	0	0	0	0
RESERY	2090	0	0	0	0	0	0	0	0	0	0	0	0
RESERY	2091	0	0	0	0	0	0	0	0	0	0	0	0
RESERY	2092	0	0	0	0	0	0	0	0	0	0	0	0
RESERY	2093	0	0	0	0	0	0	0	0	0	0	0	0
RESERY	2094	0	0	0	0	0	0	0	0	0	0	0	0
RESERY	2095	0	0	0	0	0	0	0	0	0	0	0	0
RESERY	2096	0	0	0	0	0	0	0	0	0	0	0	0
RESERY	2097	0	0	0	0	0	0	0	0	0	0	0	0
RESERY	2098	0	0	0	0	0	0	0	0	0	0	0	0
RESERY	2099	400	400	400	400	400	400	400	400	400	400	400	400

INDEX

250- μ s acceleration feedback function 3 - 42

< A >

AC servo amplifier maintenance 1 - 45
Ac servo motor maintenance 1 - 91
Acceleration feedback function 2 - 57
Acceptance and storage of AC servo motor 1 - 91
Adjusting parameters 3 - 8
Adjustment procedure for cut surface 1 - 197
Adjustment procedure for drift (erratic movement) 1 - 184
Adjustment procedure for eliminating current loop problems 1 - 222
Adjustment procedure for erratic movement 1 - 195
Adjustment procedure for overshoot 1 - 188
Adjustment procedure for vibration 1 - 171
Advanced feed-forward function 3 - 45
Alarm for incorrect servo parameter setting 1 - 145
Alarms detected by servo software 1 - 120
Alarms detected in the servo amplifier 1 - 135
Alarms of the serial pulse coder 1 - 154
Amplifier interchangeability 1 - 79
AMR parameter setting 1 - 22
Analyzing alarm causes 3 - 10
APC alarm 1 - 153
Automatic digital servo velocity loop gain adjustment function 2 - 90

< B >

Backlash compensation, acceleration function 2 - 82
Bad cut surface 1 - 168
Bad cutting shape due to high cutting resistance 1 - 170
Block diagram of digital servo parameters 1 - 160

< C >

C series servo amplifiers 1 - 71, 1 - 75
Characteristics of the position loop and velocity loop 2 - 106
Check board 3 - 14
Check boards 1 - 96
Check terminals 1 - 74
Checkboard connections 1 - 98
Classification of error messages 1 - 116
CMR, DMR, and reference counter setting 1 - 24
Compensation torque command function 2 - 54
Configuration of digital servo parameters 1 - 156
Configuration 1 - 2, 1 - 96

Connecting the phase C signal for a separately installed pulse coder (only for series 0) . .	1 - 95
Connection of the discharge unit	1 - 81
Current distorted only at deceleration	1 - 228
Current distortion observed when the load increases	1 - 225
Current loop function for high motor output at high-speed rotation	2 - 99
Current loop function	2 - 97
Current loop gain	2 - 97
Current vibration	1 - 222
Cut surface occurring even with single-axis feed	1 - 201
Cut surface occurring only with two-axis linear feed	1 - 197

< D >

Details of parameters	2 - 1
Difference due to the sliding surface and the guide types	2 - 134
Digital servo adjustment procedure	1 - 156
Digital servo adjustment using the servo adjustment screen	1 - 161
Digital servo alarms	1 - 113
Digital servo block diagram	1 - 100
Digital servo ROM for Power Mate	2 - 52
Disconnection alarm malfunctions due to large backlash in a fully closed loop system . .	1 - 168
Dispersed positioning	1 - 168
Disturbance-estimation observer	2 - 65
Drift during stop state	1 - 184
Drift low speed feed	1 - 186
Drift in rapid traverse acceleration/deceleration	1 - 187
Dual position feedback function	2 - 66

< E >

Erratic movement in 1-pulse feed	1 - 195
Erratic movement	1 - 167
Erratic-movement-prevention Function (VCMD offset function)	2 - 88
Error messages of Series 0	1 - 116
Error messages of Series 15 (including series 10, 11 and 12)	1 - 117
Excessive current value, or heated motor	1 - 226
Excessive positional deviation	1 - 150

< F >

Feed forward	1 - 221
Feed-forward setting	2 - 77
Function for enlarging the position gain setting range	1 - 149
Functions for Series 16	3 - 42
Functions for suppressing vibration at machine stop	2 - 54

< G >

Gain is low because load inertia is much larger than torque of motor	1 - 170
--	---------

< H >

High-speed positioning function	2 - 128
High-speed positioning functions	3 - 44
Hunting during movement	1 - 166

< I >

Incorrect corner shapes	1 - 220
Incorrect movement distance	1 - 214
Information required to set digital servo parameter	1 - 22
Initialization flowchart when 1- μ m control is applied	
with a 10000-pulse pulse coder	1 - 10, 1 - 18
Initialization flowchart when high-resolution pulse coder is used	1 - 8, 1 - 16
Initialization flowchart when serial pulse coder A or B is used	1 - 11, 1 - 19
Initialization flowchart when serial pulse coder C is used	1 - 13, 1 - 21
Initialization flowchart when standard pulse coder is used	1 - 7, 1 - 15
Initializing digital servo motor parameters	1 - 3
Insufficient torque in the high-speed area	1 - 223

< K >

Kinds of separate type electric discharge unit	1 - 84
--	--------

< L >

Large difference observed in the high-speed area between the value in the torque command and the actual current	1 - 227
Leakage current and selection of the ground fault interrupter	1 - 86
Leakage current	1 - 86

< M >

Machine elements used in machine tool	2 - 138
Machine speed feedback function	2 - 60
Machine-resonance suppression function	2 - 57
Maintenance parts location on PCBs	1 - 52
Measuring the leakage current when the AC servo motor series S is operating	1 - 88
Method of adjustment	2 - 129
Motor current	1 - 76
Motor type numbers	1 - 36
Mounting AC servo motor	1 - 91

< N >

New backlash acceleration function	2 - 86
Non-coincident positioning error	1 - 167
Nonlinear control function	3 - 47

<O>

Observer and torque command filter	2 - 61
Old checkboard (A16B-1600-0210) output signal	1 - 109
Old ROM version number output signal	1 - 111
One-pulse suppression function for serial pulse coder A or B	2 - 56
One-pulse suppression function	2 - 55
Output signal	1 - 99
Overshoot at rapid traverse or cutting positioning	1 - 191
Overshoot compensation	2 - 69
Overshoot during stop	1 - 167
Overshoot in 1-pulse feed and 10-pulse feed	1 - 188
Overshoot in positioning with manual pulses when the backlash acceleration function is used	1 - 192
Overshoot prevent function	2 - 69
Overshoot when feedforward is applied	1 - 193

<P>

Parameter adjustment for each fault	1 - 166
Parameter description	2 - 4
Parameters changed in series 0-c	2 - 41
Parameters for dead zone correction of current	2 - 103
Parameters to be changed in series 15	2 - 46
Parameters	3 - 17
PK3V value, the time constant of the integrator reduction, and the saturated value of the torque command	2 - 74
Poor repetition precision	1 - 211
Position loop and velocity loop functions	2 - 106
Procedure for adjusting the position	1 - 208

<Q>

Quadrant protrusion	1 - 168
---------------------------	---------

<R>

Reference data for the check board	1 - 109
Reference data on alarms	1 - 128
Replacement of pulse coder	1 - 93
Resonant frequency of ball screws	2 - 144
Return to reference position	1 - 230, 2 - 116

<S>

S series 2-axis amplifier interchangeability	1 - 79
S series 3-axis amplifier interchangeability	1 - 80
S series servo amplifiers	1 - 70, 1 - 74

Servo amplifier state indication	1 - 70
Servo functions according to software versions	2 - 49
Servo functions	2 - 49
Servo parameter setting for combined punch press and laser machine tools	2 - 131
Servo parameters	2 - 1
Servo positioning error, movement distance, and error in shape	1 - 212
Servo software (series 9040) for serial pulse coder	1 - 34
Servo software for high-speed positioning machine (punch press, PC board drilling machine, etc.)	2 - 120
Servo-related alarms detected by the NC	1 - 145
Setting method and characters of the velocity loop control cycle 1 msec	2 - 38
Setting parameter	3 - 3
Setting procedure on servo menu	1 - 4
Setting series 0 digital servo parameters	1 - 6
Setting series 15 digital servo parameters	1 - 14
Setting terminals for C series servo amplifiers	1 - 78
Setting terminals for printed circuit boards	1 - 78
Setting terminals for S series servo amplifiers	1 - 78
Setting the flexible feed gear function	1 - 29
Setting the load inertia ratio (LDINT)	2 - 115
Shape-error suppression function	2 - 77
Simplifying the parameter setting method	3 - 43
Slow response	1 - 167
Socket exchange periods	1 - 112
Special function	2 - 126
Specifications	3 - 1
Starting up digital servo	1 - 3
Symbols, addresses, and setting ranks of the digital servo parameters	2 - 1
Symbols, parameter Nos., and rank of digital servo parameters	1 - 156

<T>

Tables of standard digital servo parameters	3 - 49
TCMD signal	1 - 105
Torque limit (current limit)	2 - 98
Troubleshooting digital servo devices	1 - 113
Troubleshooting for the DCAI alarm	1 - 136
Troubleshooting for the FBAL (disconnection) alarm	1 - 120
Troubleshooting for the HVAL alarm	1 - 139
Troubleshooting for the HVAL alarm	1 - 138
Troubleshooting for the LV alarm	1 - 141
Troubleshooting for the MCC alarm	1 - 144
Troubleshooting for the OFAL (overflow) alarm	1 - 120
Troubleshooting for the OVC (overload) alarm	1 - 125
Troubleshooting for the OVL alarm	1 - 142
TSA signal	1 - 106
Types of scales	2 - 132

Types and configurations of servo amplifiers	1 - 45
Types of unit and designated specifications	1 - 97

<U>

Unusual should in rapid traverse	1 - 169
--	---------

<V>

Variable phase advancement compensation function for deceleration	2 - 105
VCMD signal	1 - 100
Vibration at specified frequency	1 - 179
Vibration cause by low gain due to long ball screw	1 - 169
Vibration during motor stop	1 - 166
Vibration during stop	1 - 171
Vibration in low-speed feed	1 - 173
Vibration in rapid traverse	1 - 175
Vibration occurs after move command entry, but not after energization only	1 - 182
Vibration only during deceleration	1 - 181
Vibration when stop due to large backlash	1 - 169

<W>

When one motor starts later than the other during straight 2-axis cutting	1 - 218
When one or more axes are not used in a two-axis or three-axis amplifier	1 - 85
When quadrant protrusions are produced	1 - 217
When the absolute value pulse coder is used and the origin varies	1 - 232
When the circular shape is distorted	1 - 215
When the origin has shifted by one grid point	1 - 234
When the origin is shifted or varies at return to reference position	1 - 230
When the origin varies by several pulses	1 - 235
When the origin varies in the fully-closed system	1 - 233
When the positioning error is not 0 when stopping	1 - 208
When the servo positioning error differs from the calculated value	1 - 212
When there is a difference in backlash between rapid traverse and cutting feed	1 - 209

Revision Record
FANUC AC SERVO AMPLIFIER MAINTENANCE MANUAL (B-65005E)

06	Dec. '91	<ol style="list-style-type: none"> 1. Great change of composition 2. Correction of errors of the 05th edition 3. Addition of explanation of raising digital servo standing 4. C series amplifier explanation is added. 5. Addition of parameter table 6. Addition of explanation of servo software for Series16 			
05	Aug. '90	<ol style="list-style-type: none"> 1. Chapter 7 have been added. 2. Parameter tables have been added. 3. APPENDIX 1-19 have been corrected. 4. APPENDIX 20-46 have been added. 5. Errors have been corrected. 			
04	Sep. '89	<ol style="list-style-type: none"> 1. Servo amp.6058-H229, H230, H231 have been added. 2. Parameter tables have been added. 3. APPENDIX 1, 2, 5, 7, 8, 9, 11, 12, 14, 15 and 18 have been corrected. 4. APPENDIX 19 have been added. 			
03	Apl. '89	<ol style="list-style-type: none"> 1. Parameter tables have been added. 2. APPENDIX 2 have been converted. 3. APPENDIX 19 have been added. 			
02	Oct. '88	<ol style="list-style-type: none"> 1. Parameters of Series 15 have been added. 2. Contents of large-sized servos (50S, 60S, 70S) have been added. 3. Appendixes 3-12 have been added. 			
01	Nov. '87	_____	07	Aug. '92	<ol style="list-style-type: none"> 1. Correction of errors of the 06th edition 2. Addition of explanation of servo function added since the 06th edition 3. Addition of parameter table 4. Addition of servo amp. H008, H236, H246, H266
Edition	Date	Contents	Edition	Date	Contents

- *No part of this manual may be reproduced in any form.*
- *All specifications and designs are subject to change without notice.*