

---

# Chapter 1

---

## Safety

<b>1</b>	<b>For your safety</b>	<b>1-3</b>
<b>2</b>	<b>Terms</b>	<b>1-5</b>
<b>3</b>	<b>Operational safety</b>	<b>1-6</b>
3.1	Intended use	1-6
3.2	Authorized personnel	1-7
<b>4</b>	<b>Hazards</b>	<b>1-8</b>
4.1	Overview of laser classes	1-8
	Laser classes of the machine	1-8
	Laser classes of laser device and components	1-8
4.2	Hazards due to laser radiation	1-9
4.3	Danger due to bright light	1-10
4.4	Dangers from magnetic fields	1-10
4.5	Dangers due to the open electrical cabinet	1-10
4.6	Dangers due to live parts	1-11

4.7	Dangers handling workpieces	1-11
	Sharp-edged workpieces	1-11
	Hot workpieces	1-12
4.8	Risks due to remote support	1-12
4.9	Dangers when using the MobileControl app	1-12
4.10	Hazardous materials	1-13
	Dusts, exhaust air	1-13
	Hazardous materials due to cutting oils	1-14
	Hazardous substances derived from poly-ethylene films	1-14
<b>5</b>	<b>Measures to be taken by the manufacturer</b>	<b>1-15</b>
5.1	Danger zones and safeguarding device	1-15
5.2	Warning signs at the machine	1-19
<b>6</b>	<b>Organizational measures to be taken by the user</b>	<b>1-21</b>
6.1	Observe warnings and warning signs	1-21
6.2	Training and instructing operators	1-21
	Measures applicable worldwide	1-21
	Protection against laser radiation: Additional information for Germany	1-22
	Protection against laser radiation: Additional information for the USA	1-23
6.3	Duty of care when handling the machine	1-23
6.4	Pay attention to water protection	1-24
6.5	Using spare parts, accessories, software and operating materials	1-25
6.6	Safety data sheet on hazardous materials	1-26
<b>7</b>	<b>Overview of residual risks</b>	<b>1-27</b>
<b>8</b>	<b>Disassembly and disposal</b>	<b>1-29</b>

# 1. For your safety

**Regulations and guidelines** With the CE marking and the EU Declaration of Conformity, TRUMPF confirms that the machine meets the basic health and safety requirements of the EC Machinery Directive.

This TRUMPF machine was registered and certified for North America by the US Food and Drug Administration (FDA), Center for Devices and Radiological Health (CDRH), as per the Federal Performance Standard Title 21 Chapter 1 Section 1040.

The CE marking is located on the nameplate of the machine. The EU Declaration of Conformity is delivered along with the machine.

**Chapter Safety** This chapter describes the safety concept. The chapter describes how potential dangers can be avoided. The overview of residual risks contains measures to be taken by the operator in order to reduce the residual risks.

## Note

The operator must adhere to the valid safety and accident prevention regulations of the respective country and the safety laws of the state and of the region!

**Warnings and warning signs** Certain operations can be a source of danger during operation. The documentation contains warnings before the instructions for these activities. There are warning plates on the machine.

A warning contains signaling words that have been explained in the following table:

Signaling word	Description
DANGER	... refers to great dangers. If not avoided, it can result in death and serious injuries.
WARNING	Refers to a dangerous situation. It could lead to serious injuries, if it is not avoided.
CAUTION	... indicates a potentially dangerous situation. It could lead to injuries, if it is not avoided.
NOTICE	If such a situation is not observed, it can lead to damage to property.

Signaling words

Tab. 1-1

---

Example of a warning:



**! DANGER**

---

### **Suspended load!**

**Falling loads could lead to severe bodily injury or even death.**

- Observe safety regulations for the handling of heavy loads.
  - Never walk under a suspended load.
  - Use tested and appropriately sized tackle and means of transportation.
  - Employ qualified technicians to transport the machine.
  - Carry out transport in accordance with the transport regulations.
-

## 2. Terms

Term	Description
Laser	Device for generating laser radiation. Lasers consist of a resonator that comprises a laser active medium and a partially reflective and translucent mirror.
Laser device	Laser plus components for operating the laser such as control technology, energy supply, cooling system, gas system etc.
Laser product	Machine, to which a laser device is connected or should be connected later. The terms "machine" and "laser product" are used as synonyms in this document.
Laser Network	A laser network is comprised of several processing systems which are connected to a laser device via laser light cable. The processing systems can use the laser radiation in alteration.
Processing optics	Processing optics is a generic term. It can mean either a laser cutting head, a laser welding head or a combination head depending on the machine.

Terms

Tab. 1-2

### 3. Operational safety

The machine can result in the following dangers if it is used inappropriately or for purposes other than those intended, or else if it is not safe to operate:

- Dangers to the safety of the operator.
- Damage to the machine and to other property of the operator.
- Negative effect on the effective functioning of the machine.

Area of application in the USA:

- Notice: Use of controls or adjustments or performance of procedures other than those specified herein may result in hazardous radiation exposure.

#### 3.1 Intended use

**Machine** The user may use the machine only in the industrial sector.

Installation, operating and transport conditions defined by TRUMPF must be adhered to and maintenance work must be carried out in accordance with the Operator's manual. The operator must observe the specifications of the country in which it is being operated as well as national and regional safety and accident prevention regulations.

The operator may laser cut the materials described in the data collection. The user may process other materials only after consulting TRUMPF.

##### Note

Standard values for the flatness of metallic materials for hot-rolled sheets are DIN EN ISO 9444-2 and DIN EN 10051 and for cold-rolled sheets DIN EN 10131.

The laser device may be operated, only if all protective and safety devices are in place and working.

In case of malfunctions, the laser device must be switched off immediately and prevented from being switched on again.

The following is not allowed:

- Unauthorized alteration or conversion of the machine by the user or personnel.
- Operating the machine with a laser device that TRUMPF has not supplied with this machine, without consulting TRUMPF.

- Any working procedure that impairs the safety.
- Laser cutting
  - of plastics.
  - of wood.
  - of sheets layered with PVC foil.
  - of magnesium.

<b>Laser protection device</b>	<p>The machine's laser protection devices, for example the window of the safety cabin, are designed for the wavelength and the power of the laser device delivered with the machine.</p> <p>If a laser device is connected with a different wavelength or power, or if the machine was supplied without a laser, then the user is obliged to check the effectiveness and suitability of the existing laser protection devices. The user is responsible for safe operation.</p>
<b>Laser network</b>	<p>If a product from a different manufacturer is connected to a TRUMPF laser device or if a TRUMPF product is connected to the laser device of a different manufacturer, then the user is responsible for the safe operation of the laser network.</p>
<b>Disclaimer</b>	<p>Any use going beyond this is considered to be unauthorized use. TRUMPF is not liable for any damage, especially personnel injuries and production failures resulting from this. The risk is borne solely by the operator. The warranty will be voided.</p>

## 3.2 Authorized personnel

- Operation, setting and maintenance work may only be carried out by authorized, trained and instructed personnel.
- Qualified personnel may:
  - Transporting the machine to the installation site.
  - Carry out work at the laser-specific, hydraulic, pneumatic and electrical modules.
  - Disassemble the machine and its components.

## 4. Hazards

### 4.1 Overview of laser classes

Laser products are divided into laser classes as per the European standard EN 60825-1 (USA: ANSI Z136.1, ANSI B11.21). The laser class corresponds to the hazard level of the laser light emitted.

#### Laser classes of the machine

Operation mode	Description	Class	
Normal mode	Normal mode is the mode of the machine in the entire scope of function including the maintenance work that has been described in the operator's manual.	Characteristics: <ul style="list-style-type: none"> <li>▪ The machine is controlled by a program or by hand.</li> <li>▪ The protective devices are activated.</li> <li>▪ The processing optics is in working position above the workpiece when the laser beam is switched on.</li> <li>▪ The personnel is located outside the danger zone.</li> </ul>	1
Service mode	Service mode is the mode of the machine for service work.	Service work includes the following: <ul style="list-style-type: none"> <li>▪ Setting up optical assemblies of the machine.</li> <li>▪ Adjustment and checking of the laser beam.</li> </ul>	4

Laser classes of the machine

Tab. 1-3

#### Laser classes of laser device and components

Laser device, component	Class
Laser device with open hood	4
Pilot laser at the emission opening of the laser device	3R
Pilot laser at the exit of the focusing optics	2
Laser device with closed hood	1
Laser light cable	1

Laser classes of laser device and components

Tab. 1-4



## 4.2 Hazards due to laser radiation

### Solid-state laser TruDisk

The laser device TruDisk is a class 4 solid-state laser.

Solid-state lasers generate intensive light in the invisible near-infrared spectral range with a wavelength of 1030 nm.

Biological tissue absorbs light in different ways. It is usually converted into heat and causes thermal damage (e.g. burns, destruction of protein) and permanent retina damage.

Eyes and skin are especially at risk due to direct and reflective laser radiation.

 **DANGER**

#### Invisible, high-energy laser radiation!

**Risk of severe skin burns and damage to the eyes. Vision impairment and blindness!**

- Only operate the machine with the safety devices active.
- Check the safety devices for damage daily.
- Observe warning signs and warning symbols.

 **DANGER**

#### Incorrect laser safety glasses!

**Serious eye injuries. Impairment to sight and blindness!**

- Do not confuse laser safety glasses for lasers with different wavelengths.
- Before using laser safety glasses, check whether they are approved for the wavelength of the laser radiation.

### Machine pilot laser

The machine can include a laser diode of class 3R. The light of the laser diode is used for adjustment work.

 **WARNING**

#### Risk of eye injuries due to laser radiation!

**Laser radiation causes irreparable damage to the eyes.**

- Do not look directly into the beam.

<b>Wavelength</b>	532 nm
<b>Max. power output</b>	≤1 mW
<b>Class</b>	3R

Pilot laser technical data

Tab. 1-5

### 4.3 Danger due to bright light

There is secondary radiation during laser processing. It is composed of ultraviolet (<400 nm), harsh, visible and infrared radiation (>780 nm).

The safety cabin and the viewing window screen the ultraviolet radiation effectively. The proportion of infrared radiation is negligible.

Looking into the harsh light at the processing point causes permanent eye damage. The processing of galvanized sheet steel is particularly critical. The permissible monitoring duration without eye protection is only a few minutes per day. For all other materials permitted by TRUMPF, the monitoring duration without eye protection is considerably longer.

 **WARNING**

---

**Danger due to harsh light during laser processing!****Intensive visible light causes permanent damage to the retina!**

- Never look directly into the harsh light at the processing point without eye protection.
  - Protect eyes with dark sunglasses or put dark film on the windows of the safety cabin.
  - Do not operate a machine with damaged viewing windows.
- 

### 4.4 Dangers from magnetic fields

### 4.5 Dangers due to the open electrical cabinet

The electrical cabinet may be opened only by an electrician.

 **DANGER**

---

**Electrical voltage!****Electric shock!**

- Keep the electrical cabinet closed.
  - Before opening the electrical cabinet: turn off the MAIN SWITCH and secure it against being switched back on again. Wait for the discharging time (at least 5 minutes).
-

 **CAUTION****Hot components!****Burns!**

- Keep electrical cabinet closed.
- Before opening the electrical cabinet: switch off the main switch and secure against being switched back on.
- Wait for the cooling phase (minimum 5 minutes).

## 4.6 Dangers due to live parts

 **DANGER**

**The power supply for the extinguisher system is not switched off by the main switch of the machine!**

**Electric shock!**

- Only a qualified electrician may do work on electrical parts.
- Before opening the compact dust extractor, switch off the extinguisher.
- Before touching, ensure that there is no live voltage present.

 **DANGER****Live parts in the laser device TruDisk!****Risk of electric shock!**

- Only an electrician may work on electrical devices.
- Before repair work: Switch off the laser device and secure it against being switched on again.
- Before touching: check whether the parts are de-energized.

## 4.7 Dangers handling workpieces

Processing workpieces can be dangerous. These dangers and measures are different for every workpiece.

### Sharp-edged workpieces

 **WARNING**

**Workpieces have sharp edges!**

**Risk of injury!**

- Wear personal safety equipment.

## Hot workpieces

### WARNING

#### Hot workpieces after machining!

##### Burns.

- Wear protective gloves.
- Use auxiliary tools to remove the workpiece.
- Avoid direct contact with hot surfaces.

## 4.8 Risks due to remote support

Remote support is used to establish a connection between the machine and Technical Service.

The service engineer can access the user interface to analyze problems and in some cases to eliminate them directly.

### WARNING

#### Activated remote support!

##### Injury and damage to property.

- Only persons trained by TRUMPF may take part in a remote support session.
- If doubts arise regarding the qualifications of the persons involved or if comprehension issues arise, TRUMPF can refuse remote support or terminate the remote support session.

## 4.9 Dangers when using the MobileControl app

The MobileControl app (option) allows the user to remotely control the machine via a mobile terminal.

### WARNING

#### Remote control of the machine with one mobile terminal!

- While the remote control is in use, do not enter the machine's danger zone.
- The remote control may only be activated if the machine is ready for operation.
- Use of the remote control is forbidden for maintenance work on the machine.
- Before this mode of control is activated, the operator must ensure that no one is in the danger zone.

## 4.10 Hazardous materials

In the case of hazardous materials, TRUMPF indicates the sources of danger only as an example. The user must estimate the danger caused by a processed material. The user must check and initiate the required measures.



### Non-functioning suction system!

**Gasses and particles that are hazardous to health enter the respiratory tract during laser processing.**

- Only carry out work when the exhaust system is in working order.

## Dusts, exhaust air

The machine must always be operated with the bulkheads installed so that the dust can be picked up.

### Exhaust air compact dust extractor, regulation outside of Germany

The user must comply with the national regulations for handling exhaust air from the compact dust extractor and the dusts it contains.

### Exhaust air compact dust extractor, regulation Germany

For the laser processing of stainless steel and materials from which harmful substances can arise as suspended dust, the exhaust air of the compact dust extractor must be passed outside into the open air.

In Germany, the limits for the return of cleaned air into the room air are defined in "Technical Rules for Hazardous Materials TRGS 560".

### Note

For the laser processing of mild steel or aluminum, for example, the cleaned air of the compact dust extractor may be fed back into the room air.

### Cleaning the machine

The machine may only be cleaned with an industrial vacuum cleaner which meets at least the standards for "dust-class M" according to IEC/EN 60335-2-69.

In some countries, national regulations stipulate that an industrial vacuum cleaner of "dust class H" must be used for cleaning.

### Further Information

The databases from GESTIS contain limit values for dust concentrations and notes about danger (hazardous substance information system of the German Social Accident Insurance). The databases are available via the Internet in German and English.

---

## Hazardous materials due to cutting oils

If metallic materials are processed with cutting oils, this might lead to organic compounds (liquid or gaseous) during laser cutting or welding.

### Note

If there is a danger of dangerous emissions, the user must carry out measurements and implement safety measures.

## Hazardous substances derived from polyethylene films

Certain materials are covered with a polyethylene film in order to protect the surface.

Polyethylene film is vaporized during laser cutting. The resulting organic compounds (e.g. alkane) do not exceed the exhaust air limit values.

However some of the resulting organic compounds lead to smell load in very small concentrations (ppb area) in the exhaust air.

## 5. Measures to be taken by the manufacturer

The danger zone of the machine is safeguarded by safety equipment. The machine may only be operated with these safety devices.

### 5.1 Danger zones and safeguarding device

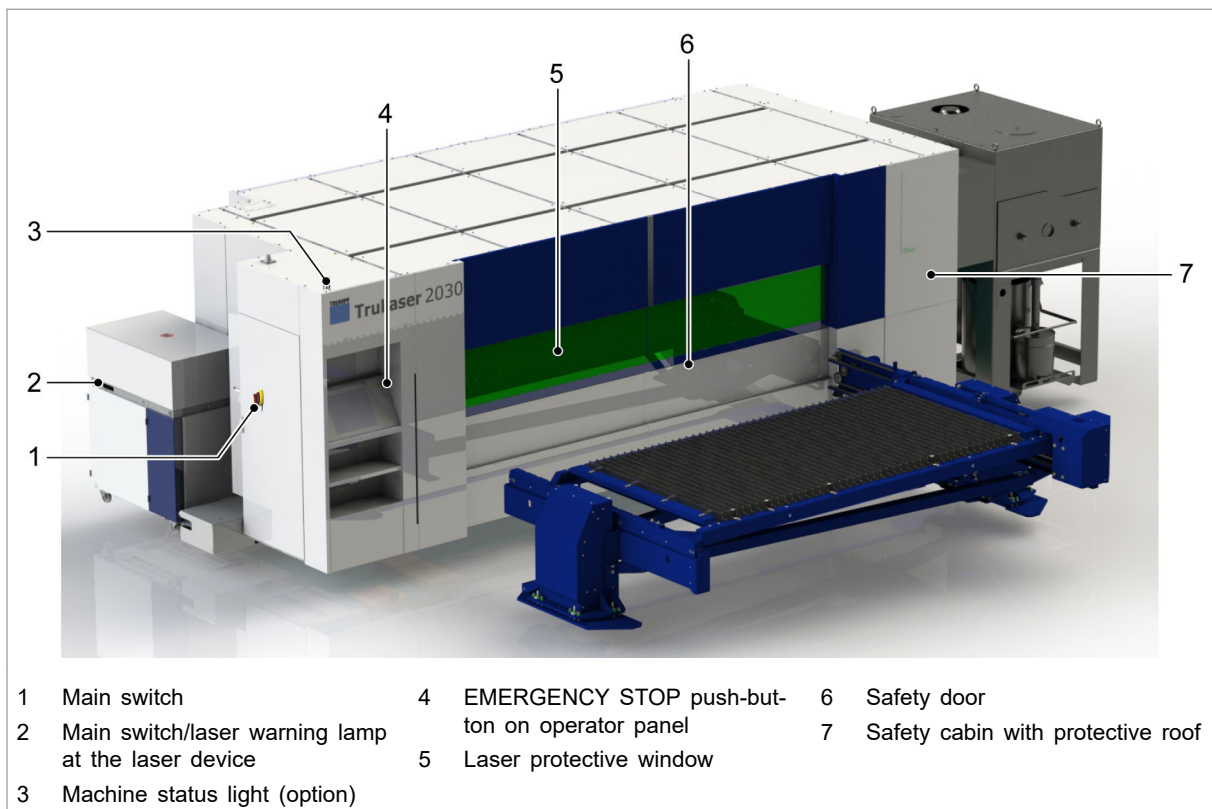

Safety devices TruLaser 2030

Fig. 95359

**Safety cabin** The machine with a completely closed safety cabin is supplied, as a standard, with one or more safety doors. The safety doors are electrically secured and monitored by the control system. The laser beam is only ignited when the safety doors are closed. If the safety door is opened during machining, then a FEED HOLD is triggered.

**Pallet changer light curtain** When using a pallet changer (option), the danger zone around the pallet changer outside the machine is optionally secured by a light curtain. The danger zone is secured in all operating modes of the control.

The interrupted light curtain triggers a feed hold during the movement of the pallet changer. The movement of the pallet and the pallet changer stop automatically.

**Hood for laser device** Lasers (beam generators) are covered with hoods. The hoods are monitored by safety switches and should only be opened with the appropriate tools. Only the technical service engineers or appropriately trained personnel are allowed to open the hoods.

**Main switch** The machine is switched on and off via the main switch. The main switch can be secured against being switched on again using a padlock.

The main switch has two switch settings:

Switch setting 0	The machine is switched off and the voltage supply of the machine is interrupted.
Switch setting 1	The machine is switched on.

Tab. 1-6

**EMERGENCY STOP push-button** EMERGENCY STOP has the following effect:

- power supply to the machine is interrupted (24 V control voltage is maintained).
- The laser beam is switched off.
- The shutter switch of the installed light path (LLK) is disabled in the laser device.
- The gas supply of the processing gas is interrupted.
- All axis motions stop.
- All drives are switched off electrically.
- The compact dust extractor is shut down.

**FEED HOLD** A FEED HOLD leads to the following:

- All axis motions are stopped.
- The laser beam is switched off.

**BEAM-BLOCK key switch** The BEAM BLOCK key switch is on the control panel.

Left switch setting	The beam block is not active: the shutter switch of the installed light path is released.
Right switch setting	The beam block is active: the shutter switch of the installed light path is disabled. The key must be removed in this setting.

Tab. 1-7



**OPERATION LOCK key switch on the laser device**

The laser device can be protected against unauthorized switching on using the OPERATION-LOCK key switch.

Switch setting 0	The laser device cannot be switched on when the key switch is in this switch setting. The key can be removed.
Switch setting 1	The laser device can be switched on when the key switch is in this switch setting.

Tab. 1-8

**Key switch for operating lock**

The key switch is on the control panel. It can be turned to two positions. In the right switch setting, the key must be removed and safely kept.

Left switch setting	Normal mode.
Right switch setting	Operating lock: <ul style="list-style-type: none"> <li>▪ Feed hold is triggered.</li> </ul>

Tab. 1-9

**Safety-Mode key switch**

The SAFETY-MODE key switch is located on the control panel. It can be turned to two positions. In the right switch setting the key must be removed and stored safely.

Left switch setting	Normal mode.
Right switch setting	The machine and all safety relevant components is shut down safely. All axis motions are stopped and locked, the laser beam is switched off. Parallel to production operation of components is not possible.

Tab. 1-10

**Exhaust system in the work area**

The workspace of the machine is permanently vacuum-cleaned. Depending on the configuration of the system, this can happen in different ways:

- Flap channel in combination with exhaust trap
- **Or** Suction connection pieces for stationary room suction system
- **Or** Traveling room suction system
- **Or** Suction tube with ventilation grids.
- **Or** Suction tube beneath the laser cutting head.

**Note**

The following table depicts a recommendation from TRUMPF, which achieves the best suction effect for a majority of the processed tubes. In individual cases, other constellations might be more effective:

The exhaust and filter system offered in combination with the machine (referred to as the compact dust extractor in the following) is designed such that the emitted aerosols and dusts in the work area can be suctioned and efficiently separated when the machine is used as intended.

Laser processing can only start once the compact dust extractor is in operation and at least one of the flaps in the exhaust piping is open.

After the end of processing, the work area continues to be suctioned according to the applied lag time.

**Machine status light** The machine status light visualizes the machine's operating status (operation, error or idle state).

**Laser warning lamp at the laser device** Laser warning lamps on the laser device indicate that the laser light is being emitted at the processing point or that the laser is ready to emit laser light even when laser light is no longer being emitted (in the "Laser is on" status).

The laser warning lamp is part of the laser device's safety device and is monitored. If the LED is faulty, the laser cannot be put into operation.

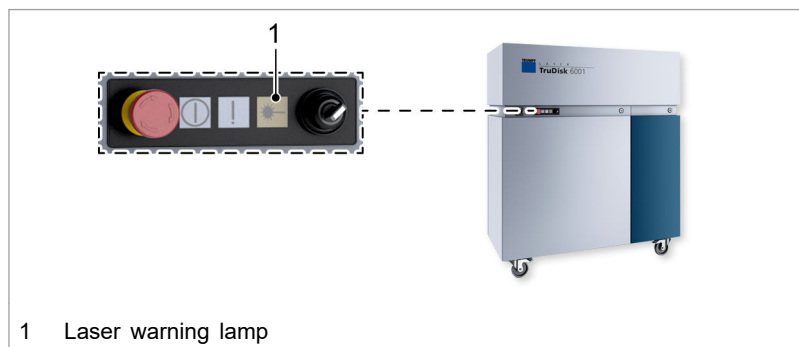

Laser warning lamp

Fig. 87662

## 5.2 Warning signs at the machine

Warning signs draw attention to dangers when operating the machine.

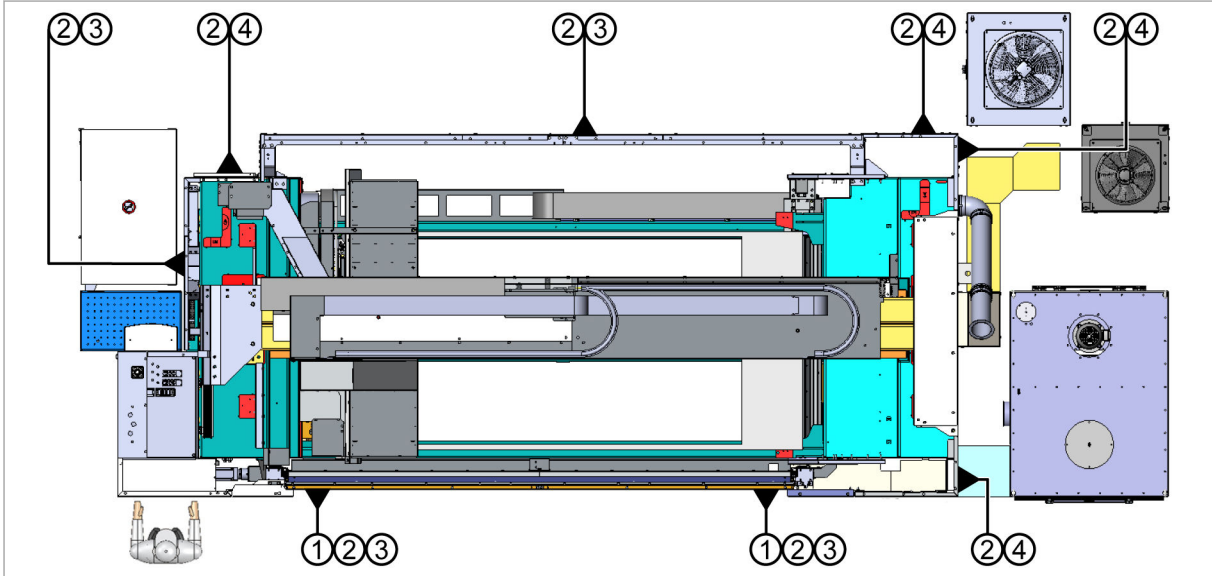





Danger signs and sign numbers

Fig. 95361

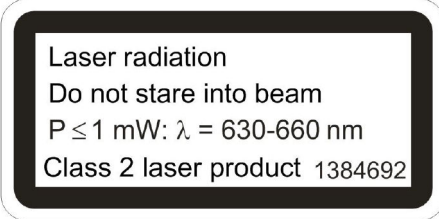
Warning signs draw attention to dangers when operating the machine.

Sign no.	Warning signs	Meaning
1		Class 1 laser product
2, 3		Caution - Invisible class 4 laser radiation when the cover is open and the safety lock is bypassed. Avoid direct or scattered laser radiation on your eyes or skin.
2, 4		Caution - Invisible class 4 laser radiation when the cover is open. Avoid direct or scattered laser radiation on your eyes or skin.

Sign no.	Warning signs	Meaning
2, 5	 	<p>Laser radiation – do not look into the beam.</p> <p>Laser class 2</p>
-		Warning of laser beam.
-		Warning of electrical voltage.
		Entering the area prohibited.
		Climbing on prohibited.

Danger signs on the machine

Tab. 1-11

## **6. Organizational measures to be taken by the user**

### **6.1 Observe warnings and warning signs**

Certain operations can be a source of danger during operation. The documentation contains warnings before the instructions for these activities and warning signs are provided on the machine.

### **6.2 Training and instructing operators**

#### **Measures applicable worldwide**

The user must take the following measures before the personnel start working on the machine:

- Train personnel appropriately.
- Inform the personnel about the possible dangers and the safety measures. Chapter 1 "Safety" forms the basis.
- Keep personal safety equipment ready.
- As far as possible, ensure personnel wear protective gear (e.g. gloves, safety shoes, hearing protection, safety glasses...).
- Define responsibilities for safety, operation, maintenance, setting work and service.
- Require that personnel read the technical documentation of the machine. Recommendation: obtain written confirmation from the personnel.
- Inform personnel about measures for protecting against laser radiation:
  - Instruct the personnel in operating processes of the laser.
  - Use laser radiation protection correctly, e.g., wear laser safety glasses.
  - Instruct the personnel about the accident prevention procedures.
  - Explain the biological effects of laser radiation on eyes and skin.
- For fault diagnosis and error correction, a connection will be made via remote support between the machine and TRUMPF Technical Service. When the machine is commissioned, the user will be informed about the procedure and possible risks of remote support. The user must provide safety instruction to operators who are involved in the remote support.

**Protection against laser radiation in setup mode**

Only personnel trained and instructed in laser radiation and appropriately equipped may carry out adjustment and setup work in setup mode. In setup mode, the machine's laser corresponds to class 4.

- The personnel must wear laser safety glasses that conform to the requirements of the following standards: IEC/EN 60825-1 or EN 207, ANSI Z87.1 for the USA.
- If necessary, the danger zone must also be secured by the customer (e.g. with portable barriers made of sheet steel and/or laser safety glass).

**Appointing a laser safety officer**

When the user operates the machine during setup mode, or carries out adjustment and setup work in setup mode, he or she must designate a laser safety officer in writing.

The user has to observe regulations and laws.

The standard IEC/EN 60825 as well as ANSI-Norm Z136.1, which is for the USA, describe the area of responsibility of the laser safety officer.

## **Protection against laser radiation: Additional information for Germany**

**Observe accident prevention regulations**

In Germany, the employer's liability insurance association accident prevention regulation "Laser radiation" (DGUV regulation 11, formerly numbered BGV B2).

**Training a laser safety officer**

The following organizations in Germany train laser safety officers, for example:

- Berufsgenossenschaft für Feinmechanik und Elektrotechnik (German Employer's Liability Insurance Association for Precision Mechanics and Electrical Engineering), Postfach 510580, Gustav Heinemann Ufer, D-50968 Cologne, Germany.
- Physikalisch-Technische Bundesanstalt (Physical-technical Federal Agency), Bundesallee 100, D-38116 Braunschweig.
- TÜV Akademie Bayern/Hessen GmbH (Technical Inspection Academy of Bavaria/Hesse Ltd), Postfach 210420, Westendstraße 199, D-80686 München, Germany.
- Technische Akademie Esslingen, Postfach 1265, In den Anlagen 5, 73760 Esslingen, Germany.

## Protection against laser radiation: Additional information for the USA

### Appointing a laser safety officer

The following instances, the user must appoint a laser safety officer:

- For class 3B or 4 laser systems.
- The user operates the machine in setup mode.
- The user carries out adjustment and setup work in setup mode.

The area of responsibility of the laser safety officer is defined in the ANSI standard Z136.1. The standard can be obtained from the American Laser Institute.

Laser Institute of America (LIA)  
13501 Ingenuity Drive, Suite 128  
Orlando, FL 32826  
[www.laserinstitute.org](http://www.laserinstitute.org)

LIA also offers training courses for laser safety officers.

## 6.3 Duty of care when handling the machine

### Checking the danger zone and safety devices

The operator must always make sure that nobody is within the danger zone before starting up the machine.

The operator may only operate the machine using safety devices. Safety devices may not be removed or put out of operation.

Once per shift, preferably before starting the production:

- Check the safety light barriers and the light grids for proper function.
- Check the safety cabin, especially viewing window, safety fencing and service door to ensure that there is no damage: do not operate the machine if a viewing window is damaged (deep scorching, hole, crack, bubble formation etc.).

After all work on safety light barriers and light grids, particularly when the layout has changed:

- Check the safety light barriers and the light grids for proper function.

### Ensuring the perfect working order

User:

- The user must ensure that the machine is installed as per the installation plan and installation conditions.
- The user must ensure that only authorized personnel works at the machine.

- The user must ensure that damaged or missing warning signs on the machine are replaced.
- The user or the persons appointed by him/her must operate the machine when it is in perfect working order.
- The user must ensure that the work station is kept clean and tidy by issuing appropriate instructions and conducting inspections.
- The user must ensure that the working areas are supplied with sufficient fresh air.

Operator:

- The operator must immediately report changes (including the operating performance) occurring in the machine to the user. The machine must be checked for externally visible defects and damage at least once per shift.
- The operator must immediately press the EMERGENCY STOP push-button if a laser protection window is damaged during laser operation. Processing may only be continued once the laser protection window has been replaced.

**Observing the shutdown procedure**

The prescribed switch-off procedures must be adhered to during all work (e.g. setting and maintenance work).

## 6.4 Pay attention to water protection

Water-pollutant substances (e.g. oil) should not enter the ground or into water bodies.

Cooling water may be disposed off together with waste water only in agreement with the local waste disposal authority.

**The Federal Republic of Germany**

The principle of precaution is applicable for machines in the Federal Republic of Germany: water should not become contaminated when using water-pollutant substances (Federal Water Act WHG).

The plant decree and the administrative regulations of the Federal states explain how this principle of precaution should be adhered to.

<b>Water-pollutant materials</b>	Lubricants
<b>Water Hazard Class</b>	WHC 2
<b>Volume of water-pollutant materials</b>	≤1000 l
<b>Hazard level of the machine</b>	A

Water protection specifications

Tab. 1-12



**Outside the Federal Republic of Germany**

Outside the Federal Republic of Germany, the respective national regulations as regards water protection must be adhered to.

## 6.5 Using spare parts, accessories, software and operating materials

**Using spare parts, accessories and software**

Spare parts and accessories that have not been released by TRUMPF (in the following: "External parts and accessories") are not checked. Installing and using external parts and accessories can change design-related properties of the machine and weaken the safety.

Only software that has been approved for installation by TRUMPF may be installed.

**Liability disclaimer**

- TRUMPF is not liable for damage if external parts and accessories are used or if spare parts and accessories approved by TRUMPF are not installed or replaced properly.
- TRUMPF cannot be held liable for damages resulting from the installation or operation of software which is not approved by TRUMPF.

**Using permissible operating materials as per the regulations**

The permissible operating materials (especially lubricating and cleaning agents) must be used as per the regulations. If a safety data sheet has been prescribed for the manufacturer of the operating material (European Directive 1907/2006 REACH), the instructions in it must be followed, such as:

- Chemical properties.
- Physical and safety-related specifications.
- Transport.
- Regulations
- Safety measures, storage, and handling.
- Procedures in the event of accidents or fires.
- Specifications for toxicology and ecology.
- Waste code with prescribed disposal method for the operating material.

**Note**

Safety data sheets can be obtained from the manufacturers of the respective operating materials.

---

## 6.6 Safety data sheet on hazardous materials

The safety data sheets e.g. for lubricants, cleaners or gases can be downloaded from the TRUMPF web page: <http://www.trumpf.com/s/msds>.

## 7. Overview of residual risks

The machine has residual risks in spite of its safety devices and construction type.

The following overview of residual risks is a summary of the main potential threats to life and limb posed by the machine.

Any additional precautions that can be taken by the machine user to reduce residual risks are specified in the overview of residual risks.

For detailed descriptions of the measures: (see "Hazards", pg. 1-8).

Residual risk	Hazard area	Type of danger	Measure to be taken by the user
<b>Mechanical elements</b>			
Squeezing or impact	Motion of the X, Y and Z axis and the pallet	Risk of injury	-
	Movement of the front door.	Risk of injury	-
scissors	Raising, lowering, and traveling of the pallet	Risk of injury	-
Cutting and cutting to size	Sharp-edged workpieces	Risk of injury	<ul style="list-style-type: none"> <li>▪ Wear protective clothing and laser safety glasses.</li> <li>▪ Use of tools to remove workpieces.</li> </ul>
By interception or coiling	Chain drive of the pallet changer.	Risk of injury	-
Due to being drawn in or caught	Pallet movement	Risk of injury	-
Due to fluids and gases being expelled under high pressure	cut assist gas	Risk of injury	-
<b>Electrical system</b>			
Electrical contact and proximity to parts under high voltage	Directly with parts that are normally live.	Risk of fatal injury	-
	Indirectly with parts that are live due to defects.	Risk of fatal injury	-
	Contact with parts storing electrical charges.	Risk of fatal injury	-
<b>Heat</b>			
Due to thermal radiation or spurting, melted parts.	Ejected slag spatters	Risk of injury	-
Due to touching	Hot workpieces	Risk of injury	<ul style="list-style-type: none"> <li>▪ Wear protective clothing and laser safety glasses.</li> <li>▪ Use of tools to remove workpieces.</li> <li>▪ Securing of the danger zone by the customer.</li> </ul>

Residual risk	Hazard area	Type of danger	Measure to be taken by the user
Due to flames or explosion.	Fires/detonations due to concentration of oxygen	Risk of injury	
<b>Radiation</b>			
Laser	Radiation during service work.	Risk of injury	Wear protective clothing and laser safety glasses.
<b>Secondary radiation</b> (extremely bright and intensive light at the machining point)			
Eye contact	Due to plasma formation, intense, visible radiation at the machining point.	Risk of injury Permanent damage to the retina	<ul style="list-style-type: none"> <li>▪ Personal eye protection: wear glasses with darkened lenses or hold a darkened plate in front of your eyes.</li> <li>▪ Observe national regulations.</li> </ul>
<b>Materials</b>			
Through contact with or by inhaling toxic fluids, gases, mist, vapors, and dust	Cutting gas, dust, aerosols, cutting oils, PE-coated profiles	Health hazard	<ul style="list-style-type: none"> <li>▪ Ventilate the workplace sufficiently.</li> <li>▪ Observe the notes in the operator's manual.</li> </ul>
<b>Fire and explosion</b>			
Fire hazard	Entire system	Risk of injury	Estimate danger of fire as part of the operational hazard analysis. Implement appropriate fire protection measures in accordance with valid national regulations.
	Reflection of laser radiation	Risk of injury	-
	Compact dust extractor	Risk of injury	<ul style="list-style-type: none"> <li>▪ Keep a CO<sub>2</sub> hand-held fire extinguisher ready (fire classification B).</li> </ul>
<b>Malfunction or incorrect function</b>			
Malfunction of energy supply	Drives	Risk of injury	-
	Control voltage	Risk of injury	-
<b>Suspended load</b>			

Residual risks

Tab. 1-13

## 8. Disassembly and disposal

TRUMPF recommends that TRUMPF machine tools be disassembled and disposed of by Technical Service or a specialist disposal company. The following information is to be passed on to the specialist disposal company performing the disposal work, to guarantee fast, environmentally sound and safe disposal.

The following points should be observed when disposing of a TRUMPF machine tool.

### Preparing disassembly

- Remove dirt, in particular dust that can be stirred up or that can be hazardous during disassembly.
- Close off the disassembly and storage area over a wide area.
- Move down movable parts and suspended loads as far as possible. Secure or support suspended loads in the event of a defective machine.
- Have the machine disconnected from the power supply by a trained electrician.
- If available: close off the compressed air and gas supply and disconnect from the machine.
- Depressurize components under pressure (e.g. compressed air line).
- Wait at least an hour to allow any residual voltage in the machine to dissipate and hot components to cool down. All assemblies/components can then be touched.

### Overview of hazardous materials Declaration of substances in acc. with GB/T 26572-2011 (China RoHS 2)

The declaration of substances is only necessary for the area of application in China.



Conformity label at the nameplate

Fig. 82463

Part designation	Hazardous substances					
	Lead	Mercury	Cadmium	Hexavalent chromium	Polybrominated biphenyls	Polybrominated diphenyl ethers
	(Pb)	(Hg)	(Cd)	(Cr <sup>+6</sup> )	(PBB)	(PBDE)
Basic machine	X	O	O	O	O	O
Laser	X	O	O	O	O	O
Compact dust extractor	X	O	O	O	O	O
Process cooler	X	O	O	O	O	O

Part designation	Hazardous substances					
	Lead	Mercury	Cadmium	Hexavalent chromium	Polybrominated biphenyls	Polybrominated diphenyl ethers
	(Pb)	(Hg)	(Cd)	(Cr <sup>+6</sup> )	(PBB)	(PBDE)
<p>O: Indicates that this hazardous substance is present in all homogeneous materials for the parts listed. In terms of EIP-A, EIP-B and EIP-C, the value is below the limit stipulated in GB/T 26572-2011.</p>						
<p>X: Indicates that this hazardous substance in all homogeneous materials in terms of EIP-A, EIP-B and EIP-C is above the limit value stipulated in GB/T 26572-2011.</p>						
<p>Comments: -</p>						

Tab. 1-14

- Remove**
- Poisonous vapors can result when thermally cutting painted components or components made out of composite materials!
    - Select a suitable cutting process.
    - or**
    - Wear a suitable protective mask and ensure there is a sufficient supply of fresh air.
  - Secure top-heavy assemblies to prevent them from tipping over and carefully put them in a good transport position (center of gravity down).
  - Moving assemblies may be unbraked after being disconnected from the power supply!
    - Fix movable assemblies prior to disassembly/transport, so that the center of gravity cannot move in an uncontrolled manner.
  - Mechanical stresses can be released when undoing chains, ropes and steel constructions!
    - Wear suitable protective gear and close off the area over a wide area.
  - On defective machines, parts of the hydraulic system and the compressed air system can still be under pressure!

- Transporting assemblies**
- Close off transport routes and storage positions over a wide area.
  - Use suitable lifting gear. See installation conditions.
  - Fasten assemblies above the center of gravity as far as possible.

---

# Chapter 2

---

## Installation conditions

	To what does this apply?	2-3
<b>1</b>	<b>Planning aid</b>	<b>2-4</b>
<b>2</b>	<b>Installation site</b>	<b>2-6</b>
2.1	Preparing transport	2-6
	Transport dimensions	2-6
2.2	Space requirements	2-7
2.3	Floor requirements	2-7
2.4	Floor quality	2-8
2.5	Weight load	2-9
2.6	Stress due to vibration	2-10
2.7	Ambient conditions	2-10
2.8	Exhaust air system of the compact dust extractor	2-12
2.9	Cable racks for laser light cables	2-13
<b>3</b>	<b>Gas supply</b>	<b>2-14</b>
3.1	Cutting gases	2-14

	Purity	2-14
	Cutting gas consumption	2-15
	Supply lines for cutting gas supply	2-17
	Requirements on the connection point of the machine	2-19
	Cutting gas supply with cylinders or bundles	2-20
	Cutting gas supply with gas tank	2-21
3.2	Nitrogen for cutting unit ventilation	2-22
<b>4</b>	<b>Electrical supply</b>	<b>2-23</b>
4.1	Power supply	2-23
	Power supply configuration	2-24
	Residual current device (RCD)	2-25
	Connection to an uninterruptable power supply installation	2-26
	Isolating transformer	2-26
4.2	Connected load, fuse protection	2-29
4.3	Power consumption	2-29
4.4	Network link	2-30
<b>5</b>	<b>Compressed air supply</b>	<b>2-32</b>
<b>6</b>	<b>Operating materials</b>	<b>2-34</b>
6.1	Workpieces	2-34
6.2	Cooling water	2-34
<b>7</b>	<b>Transport</b>	<b>2-38</b>
7.1	Permitted auxiliary tools	2-38
7.2	Checking, unloading and transporting the machine	2-39
	On delivery: check the machine	2-39
	Unloading and transporting the machine	2-39
	Transport TruDisk laser device	2-40
7.3	TRUMPF service work	2-42



## To what does this apply?

The installation conditions contain all information for preparing the installation and start-up of the machine including the laser.

### Note

The TruLaser 2030 is a system for laser cutting metal materials. The machine is designed for machining flat sheets.

**Laser cutting of plastics with the TruLaser 2030 is not permissible!**

### Who does what?

**Customer:** All the conditions described in this chapter must be fulfilled before the machine is delivered.

If this is not the case, the TRUMPF service technicians will not be able to put the machine into service.

Pass along the respective subsections in accordance with the following planning aid to the specialist companies/plants (e.g. electrical installer, specialist plant for industrial gases...) in a timely manner.

### Note

During commissioning, the main switch on the machine may only be switched on by TRUMPF service personnel.

**TRUMPF Technical Service:** start-up of the machine is performed by TRUMPF service technicians.

This includes:

- Installing, aligning, leveling and securing the machine.
- Laying laser light cable.
- Filling up the process cooler.
- Connecting the machine to the supplies (with the exception of the electrical power supply).
- Conducting a functional test.
- Instructing personnel

## 1. Planning aid

The planning aid provides an overview of the measures to be taken and preparations to be made.

For details, refer to the corresponding sections of these installation conditions.

Time before the delivery of the machine	Planning criterion	Measures
15 weeks	Personnel and training	<ul style="list-style-type: none"> <li>▪ Appoint a member of staff to be responsible for preparations for the delivery of the machine.</li> <li>▪ Appoint operating and service personnel and programmers.</li> <li>▪ Arrange training schedules for specialist personnel.</li> <li>▪ Appoint a laser safety officer in accordance with EN60825-1 (VBG 93).</li> </ul>
14 weeks, but no later than week...	Installation site	<ul style="list-style-type: none"> <li>▪ Determine the installation site of the machine, taking into account the space requirements according to the installation plan.</li> <li>▪ Check floor conditions:               <ul style="list-style-type: none"> <li>- Floor quality.</li> <li>- Flatness.</li> <li>- Oil-resistant floor without expansion joints.</li> </ul> </li> <li>▪ Take the weight and dimensions of the machine into account.</li> <li>▪ Check the requirements for ambient conditions:               <ul style="list-style-type: none"> <li>- Room temperature.</li> <li>- Exposure to sunlight.</li> <li>- Purity of the ambient air</li> </ul> </li> <li>▪ Check the transport route:               <ul style="list-style-type: none"> <li>- Gateway openings</li> <li>- Header heights.</li> <li>- Cable rack heights.</li> <li>- Room to move freely around corners etc.</li> </ul> </li> </ul>
12 weeks, but no later than week ....	Electrical supply	<ul style="list-style-type: none"> <li>▪ Install electrical connections at the installation site.</li> <li>▪ Lay the conductor cross-section and fuse protection according to the legal requirements.</li> </ul>
12 weeks, but no later than week ...	Gas supply	<ul style="list-style-type: none"> <li>▪ Arrange for the installation of the cutting gas supply at the installation site.</li> <li>▪ Decide about the gas supply method (cylinders, cylinder bundles, gas tank).               <ul style="list-style-type: none"> <li>- Procure the required fittings.</li> </ul> </li> <li>▪ Together with the gas supplier: design gas conduits.</li> </ul>
12 weeks, but no later than week ...	Compressed air supply	<ul style="list-style-type: none"> <li>▪ Arrange for the installation of the compressed air supply at the installation site.               <ul style="list-style-type: none"> <li>- Take into account connection, purity, compressed air requirements.</li> </ul> </li> </ul>
4 weeks but no later than week ....	Operating materials	<ul style="list-style-type: none"> <li>▪ Demineralized water.</li> <li>▪ Stock up on supplies of cutting gases, operating materials for the chiller.</li> </ul>
4 weeks but no later than week ....	Cable racks	Mount cable racks for laying the laser light cable (with external TruDisk laser device only).

Time before the delivery of the machine	Planning criterion	Measures
4 weeks but no later than week ....	Transport	Provide auxiliary transport equipment.
4 weeks but no later than week ....	Laser safety	<p><b>Valid for Germany:</b></p> <p>Register the laser machining system with the employer's liability insurance association and with the trade board.</p> <p>Observe the regulations applicable in the country of operation.</p> <p>Make laser safety glasses available for service work, safety glasses for laser light with a wavelength of 1030 nm.</p>
During installation and start-up	Electrical installation	Have the system connected by a professional electrician.

Planning aid

Tab. 2-1

## 2. Installation site

**What does the customer need to do?**

Please consult a structural analyst for professional support, particularly regarding the topic of **floor requirements**. Give the structural analyst the "Installation site" section and the foundation plan/installation layout.

**Platform installation**

If supply units of the machine, such as process coolers, compact dust extractors or electrical cabinets, are put up on a platform, note the following:

- The platform does not belong to the machine's scope of delivery.
- The platform must meet applicable standards and national regulations concerning safety of being stepped on.
- Leaking water, oil or other operating materials have to be captured.

### 2.1 Preparing transport

Before the machine is delivered, check:

- Whether there is sufficient space for transport to the installation site.
- Whether the floor can be crossed with armored rollers.
- Whether gates, header heights, cable rack heights are sufficient.

### Transport dimensions

**Note**

The transport dimensions were calculated to include packaging and pallet, and correspond to the status at the time of delivery.

Component		Length	Width	Height
		mm / in		
Machine incl. control cabinet	▪ Domestic Oversized Shipping (Standard within the US)	6502 / 256	2715 / 107	2333 / 92
	▪ Domestic Legal Shipping	6502 / 256	2464 / 97	2297 / 90
	▪ International Shipping (outside of the US)	6502 / 256	2240 / 88	2333 / 92
Laser device		1800 / 71	1200 / 47	2000 / 79
External laser process cooler		1000 / 40	1200 / 47	1950 / 77

Component	Length	Width	Height
	mm / in		
Machine process cooler (optional)	980 / 39	900 / 36	1850 / 73
Compact dust extractor	1800 / 71	1500 / 59	2350 / 93

Transport dimensions machine and components

Tab. 2-2

## 2.2 Space requirements

The arrangement of the components and required space for the installation of the system have been documented in the TRUMPF installation plan.

## 2.3 Floor requirements

**Flatness** The floor on which the system stands must be flat.

Permissible flatness deviation (flatness tolerance):

- Footprint range: max. 12 mm / 1/2 in per 10 m / 33 ft.
- Load-bearing point range (wedge mounts or air cushions): max. 2 mm / 0.08 in per 0.5 m / 1.64 ft.

The flatness tolerance can be determined for different measuring point distances from the following diagram.

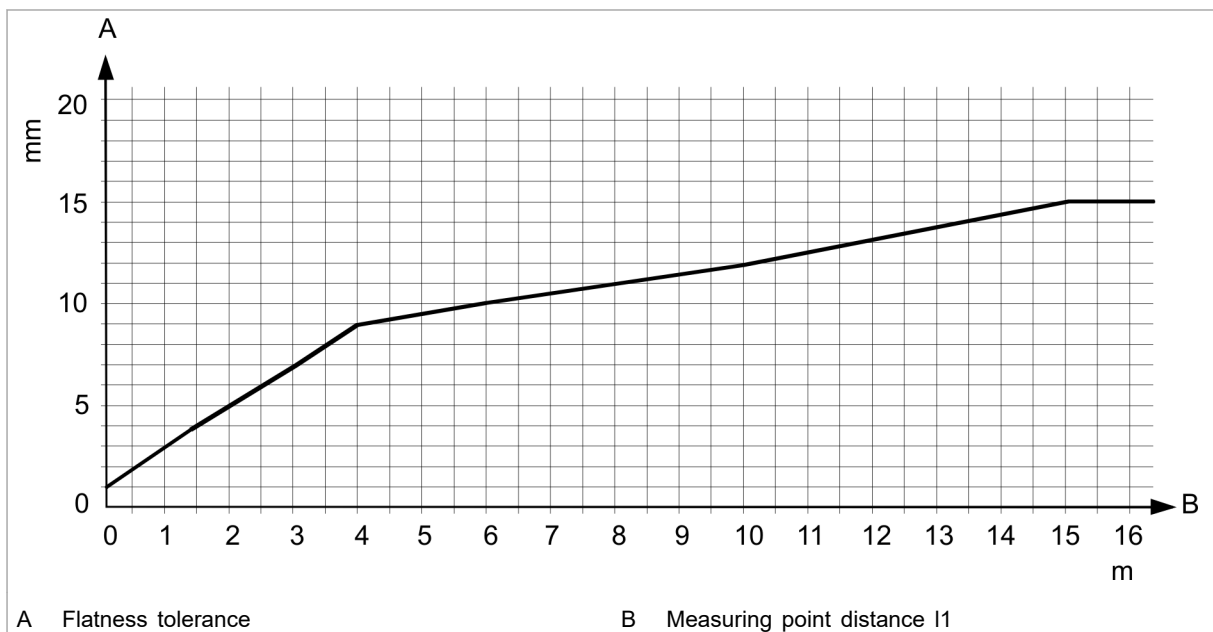

Flatness tolerance depending on the measuring point distance

Fig. 65278

Measuring procedure:

The straight edge is placed on the high points of the surface and determines the depth gauge at the lowest point. For the selected measuring point distance the depth gauge may not be greater than the flatness tolerance.

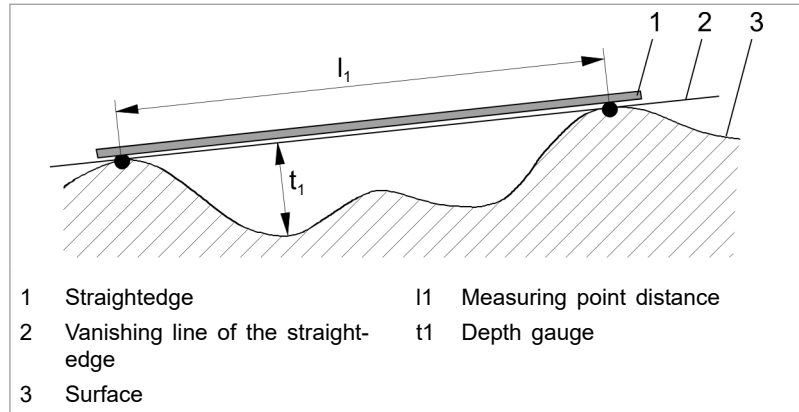

Measuring procedure for determination of the depth gauge Fig. 65581

- Expansion joints**
- The entire installation surface must not have any expansion joints.
    - No joint of any kind may be located in the load-bearing point range of the machine and within at least 1.0 m / 3 ft of it.

## 2.4 Floor quality

### Note

The floor must be oil-proof.

- Elastically cushioned base plate**
- Steel reinforced concrete with the following properties:
    - Characteristic rated value:  $f_y \geq 435 \text{ N/mm}^2$ .
    - Modulus of elasticity:  $E_s \geq 200\,000 \text{ N/mm}^2$ .
    - Upper reinforcement crosswise  $3.7 \text{ cm}^2/\text{m}$  each.
    - Lower reinforcement crosswise  $je 3.7 \text{ cm}^2/\text{m}$  each.
    - US specification: #5 rebar, spaced 12 in on center, on both the top and bottom faces and oriented in both the longitudinal and transverse directions.
  - Elastic cushioning of the base plate on a foundation with a minimum bedding value of  $C \geq 5000 \text{ kN/m}^3$  (loess loam).



Machine	Weight	Load capacity	Minimum thickness	Concrete quality of the tensile strength C25/30	
	kg (lb)	kN/m <sup>2</sup> (psi)	mm (in)	F <sub>ck, cyl</sub> N/mm <sup>2</sup> (psi)	F <sub>ck, cube</sub> N/mm <sup>2</sup> (psi)
TruLaser 2030 (L82)	7750 (17050)	15 (2.2)	100 (4)	≥25 (3700)	≥30 (4400)
F <sub>ck, cyl</sub> : Cylinder compressive strength					
F <sub>ck, cube</sub> : Cube compressive strength					

Requirements for a flexibly cushioned base plate

Tab. 2-3

**When is a structural analyst generally required?**

A structural analyst must be consulted under the following conditions:

- The previously named requirements for an elastically embedded base plate are not met.
- The system is to be set up on a ceiling plate/free-span base plate.
- A bearing is to be installed.
- The system is to be set up on fiber-reinforced concrete or roller-compacted concrete.
- The system is to be installed on a floor other than the one named above.

## 2.5 Weight load

**Structural stress analysis**

- Perform a structural stress analysis of the load-bearing capacity of the floor surface prior to installation.
- Take into account the weights of the relevant components and the load on the support points.

**Machine weight load**

Component	Total weight kg / lb	Distribution of weight
Basic machine including: <ul style="list-style-type: none"> <li>▪ Pallet with all support slats.</li> <li>▪ Control cabinet.</li> </ul>	7750 / 17050	Weight is distributed over 8 surfaces. Refer to the foundation plan of the respective machine for the weight load on the surfaces.
Max. weight of workpiece	900 / 1984	
Manual pallet (without pallet) <ul style="list-style-type: none"> <li>▪ Pallet weight</li> </ul>	350 / 772 542 / 1195	Weight is distributed over 2 surfaces.
Pallet changer (without pallet) <ul style="list-style-type: none"> <li>▪ Pallet weight</li> </ul>	970 / 2140 555 / 1224	Weight is distributed over 2 surfaces.
TruDisk Laser	470 / 1036	Weight is distributed over 4 surfaces.
Process cooler (without cooling water)	503 / 1109	4 leveling feet support the main load.

Component	Total weight kg / lb	Distribution of weight
Process cooler 43 °C/50 °C option (without cooling water)	370 / 815	4 leveling feet support the main load.
Compact dust extractor	840 / 1850	4 leveling feet support the main load.
Isolating transformer (optional)	550 / 1215	The edges support the main load.

Weights and load

Tab. 2-4

## 2.6 Stress due to vibration

In the immediate area around the system, external influences can lead to vibration loads. Vibration loads can effect the quality of workpieces.

External influences are e.g.:

- Fork lifts, industrial trucks, etc.
- The installation or removal of other machines in the immediate vicinity of the system.
- Machines which excite vibrations during operation, such as punch presses etc.

### Maximum stress due to vibration for TruDisk lasers

Acceleration of vibration	0.01 g (100 mm/s <sup>2</sup> )
---------------------------	---------------------------------

Maximum stress due to vibration in vertical direction

Tab. 2-5

If the vibration at the installation site is higher, then shock-absorbing pads must be used. To correctly dimension the shock-absorbing pads, the vibration at the installation site must be measured.

## 2.7 Ambient conditions

### Ambient temperature Notes

- One-sided exposure to direct sunlight and unidirectional drafts must be avoided (e.g. with Venetian blinds if installed near a window).
- The ambient temperature should be kept constant while operating the system. A sufficient circulation of air should be ensured in the factory hall.
- The waste heat from the process cooler can increase the ambient temperature at the installation site



Machine condition	Note	Ambient temperature	Relative humidity
Operation <sup>1</sup>	Standard 35 °C version	+10 °C to +35 °C 50 °F to 95 °F	Max. 100 % at 24 °C / 75 °F
	43 °C version (option)	+10 °C to +43 °C 50 °F to 109 °F	Max. 100 % at 32 °C / 90 °F
	50 °C version (option)	+10 °C to +50 °C 50 °F to 122 °F	
Storage		+5 °C to +43 °C 41 °F to 109 °F	
Transport		0 °C to +43 °C 32 °F to 109 °F	

Permissible ambient temperature

Tab. 2-6

**Dew point** In order to avoid condensation water, the ambient conditions of the laser device must be within specific limits.

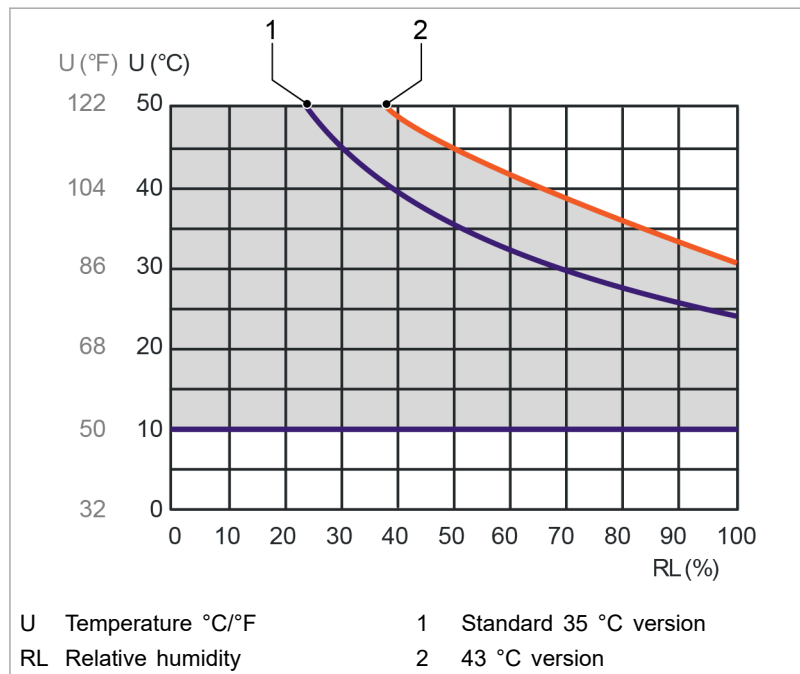

Dew point diagram

Fig. 68666

When operating the laser device, the values must be within the gray area of the dew point diagram.

The closer the ambient conditions are to the limit values shown in the diagram, the longer the advance time of the dehumidifier can become.

**Cooling the control system**

The control is cooled in the closed electrical cabinet via the process cooler. This protects the components from dirt and dust to a large extent.

<sup>1</sup> According to NFPA 79, the max. temperature in the USA and Canada is 40 °C / 104 °F

Damp rooms are not suitable for the operation of the control system, mainly because contact corrosion can develop on contactors and relay contacts, resulting in control system errors.

## 2.8 Exhaust air system of the compact dust extractor

### Note

The exhaust air system beginning at the clear gas duct of the compact dust extractor must be installed by the customer.

### International/national regulation

Regulation outside of Germany:

- The user must comply with the national regulations for handling the exhaust air of the compact dust extractor and the dusts it contains.

Regulation in Germany:

- For the laser processing of stainless steel and materials from which harmful substances can arise as suspended dust, the exhaust air of the compact dust extractor must be conducted to the outdoors.
  - In Germany, the limits for the return of cleaned air into the room air are defined in "Technical Rules for Hazardous Materials TRGS 560".
- For the laser processing of mild steel or aluminum, for example, the cleaned air of the compact dust extractor may be fed back into the room air.

### Exhaust air system

The exhaust air system must be installed as follows:

- Max. of two 90° tube bends (radius = diameter x 1.5).
- Max. length: 10 m / 33 ft.
- Transition piece on the compact dust extractor: TRUMPF mat. no. 0382628.
- Tube diameter: 315 mm / 12.4 in.

### Note

For other configurations, a ventilation technician or the manufacturer of the compact dust extractor must be consulted. The max. resistance of 100 Pa (0.0145 psi) must not be exceeded.

---

## 2.9 Cable racks for laser light cables

### Note

The laser light cable is installed by Technical Service!

If the laser device is not set up directly next to the machine, and if the laser light cable (LLK) is longer than 20 m / 66 ft, the following applies:

- The LLK is guided in cable racks from the installation site of the laser to the machine. The user must install the cable racks before the machine is delivered.
- The cable racks are to be constructed as follows:
  - Width of the cable racks: 250 mm / 10 in.
  - Use cable racks open on one side made of slats; thus the cable will be able to be inserted and fastened in place easily from the side during installation.
  - Design the corner elements and transitions in such a way that a minimum bending radius of 220 mm / 8 in is always ensured.
- The distance between the LLK and the low voltage cables must be at least 50 mm / 2 in.
- The LLK is not permitted to be laid together with a high voltage cable in the same cable rack.
- If cable racks are used without slats, then the LLK must be fastened in place with cable binders.
- The LLK must not be pulled, pushed or turned.
- Wall openings must have a minimum diameter for 100 mm / 4 in and be designed with smooth surfaces (e.g. with a core drill).

### 3. Gas supply

Professional gas installation is a basic prerequisite for smooth commissioning and trouble-free operation of the installation. The following chapter must therefore be passed along to the specialist company for industrial gases you have contracted with in a timely manner in accordance with the planning aid.

#### Notes

- Urgent recommendation from TRUMPF: The operator should consult his gas supplier regarding the gas supply.
- Installation must be performed by a qualified industrial gas company. A specialized company certified by the DVGW (German Technical and Scientific Association for Gas and Water) or a gas and water fitter is not suitable.
- The appropriate standards must always be observed.

#### WARNING

**Gas conduits and electrical cables laid out in the same cable duct.**

**A short circuit could damage a gas line or cause a fire.**

- With all gas installations, make sure the gas conduits are not installed together with electrical cables!
- Always lay out gas lines separately up to the connection point to the machine!

### 3.1 Cutting gases

#### Purity

Cutting gas	Purity	
Oxygen (O <sub>2</sub> )	3.5	99.95 % by vol.
Nitrogen (N <sub>2</sub> )	5.0	see exception for nitrogen
Compressed air (optional)	(see "Compressed air supply", pg. 2-32)	
The following applies to all gases:	≤100 particles (for particles ≤0.3 μm; based on 2.83 l ≙ 0.1 ft <sup>3</sup> )	

Inert gases: purity

Tab. 2-7

#### Exception for nitrogen

#### Note

To achieve optimum cutting results and maximum process stability, TRUMPF recommend using nitrogen with a purity of **5.0 (99.999% by vol.)**.

In exceptional cases, nitrogen with a purity of **4.0 (99.99% by vol.)** can also be used. However, this may impair the cut quality (e.g. discoloration) and the cutting process stability.

## Cutting gas consumption

The cutting gas consumption depends on the following:

- Nozzle diameter.
- Cutting gas pressure.
- Duration of laser cutting

### Estimating cutting gas consumption

Cutting gas consumption for certain types of material and sheet thicknesses can be estimated with the aid of the data collection of the machine.

### Standard pressure cutting

Standard pressure cutting is cutting with a nozzle pressure of  $\leq 6$  bar / 87 psi. Oxygen and/or nitrogen are used as cutting gases.

For standard pressure cutting with O<sub>2</sub> the minimum flow pressure available at the connection point of the machine is 8 bar / 116 psi.

- Gas consumption of 10 m<sup>3</sup>/h / 6 cfm (volume under standard conditions).
- Nozzle with  $\varnothing$  1.7 mm.
- Cutting gas pressure of 6 bar / 87 psi.

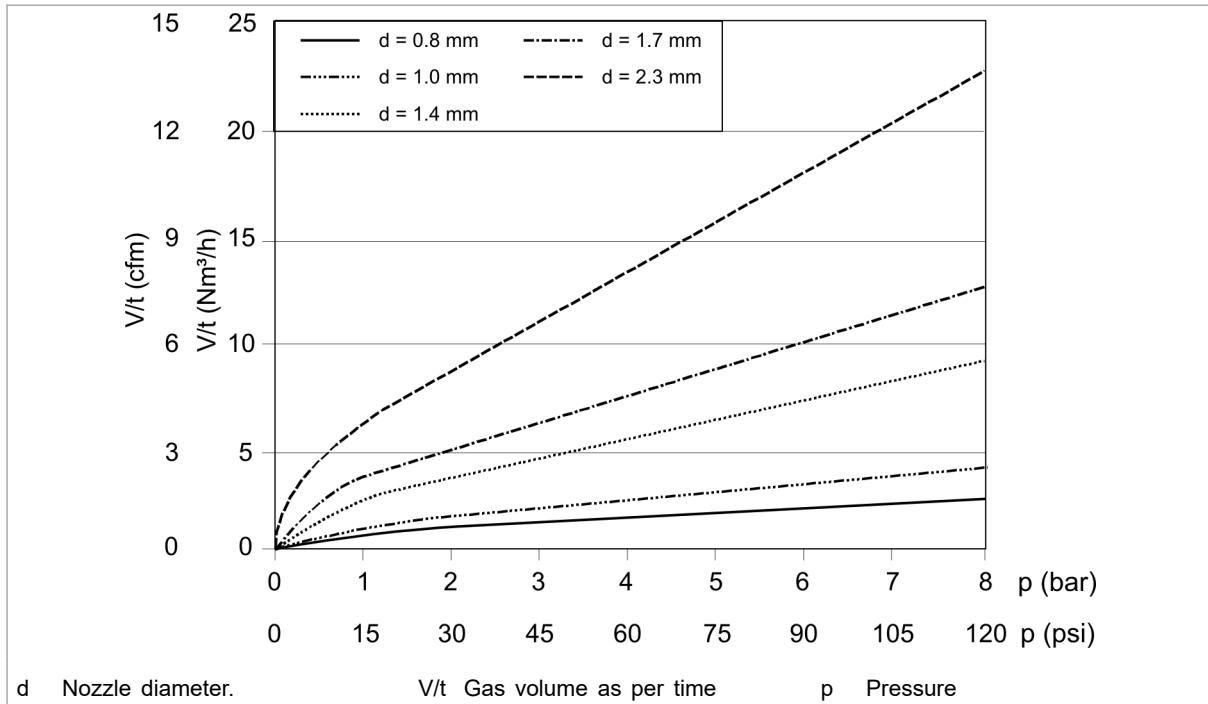

Maximum cutting gas consumption per hour during 100% ON-time

Fig. 55214

### High-pressure cutting

High-pressure cutting is cutting with nitrogen using pressures > 6 bar / 87 psi. Normally, nitrogen is used as cutting gas, in rare cases also oxygen. High-pressure cutting is an option for machining stainless steel and aluminum alloys.

- During high-pressure cutting with N<sub>2</sub> the minimum line pressure available at the connection point to the machine is 27 bar / 400 psi.
  - Gas consumption of 90 m<sup>3</sup>/h / 53 cfm (volume under standard conditions).
  - Nozzle with Ø 2.7 mm.
  - Cutting gas pressure of 20 bar / 290 psi.
- During high-pressure cutting with O<sub>2</sub> the minimum line pressure available at the connection point to the machine is 15 bar / 210 psi.
  - Gas consumption of 20 m<sup>3</sup>/h / 12 cfm (volume under standard conditions).
  - Nozzle with Ø 1.7 mm.
  - Cutting gas pressure of 12 bar / 174 psi.

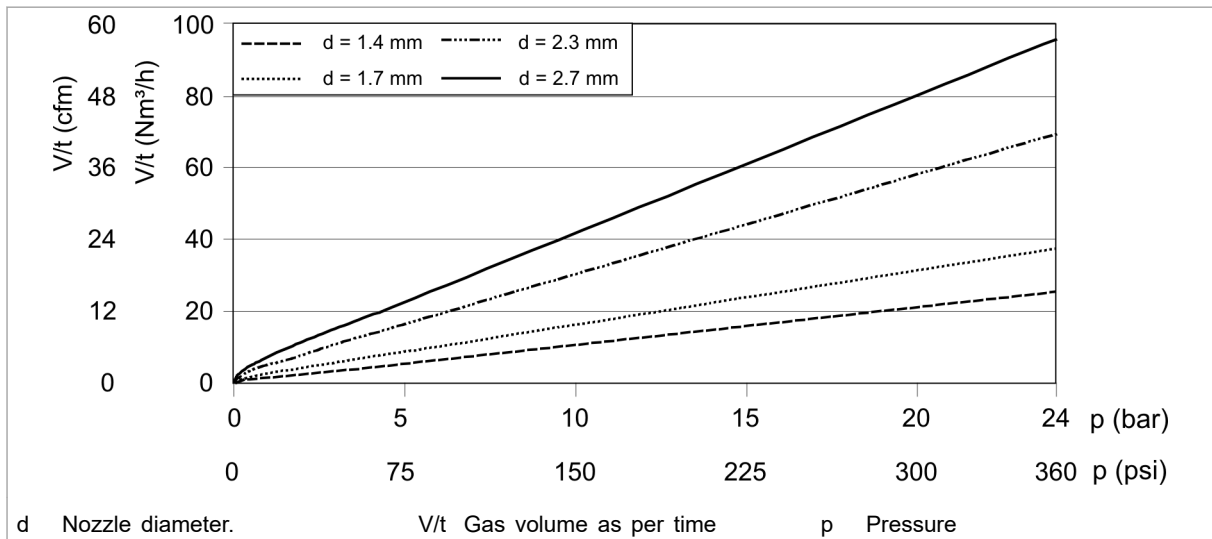

Maximum cutting gas consumption per hour during 100% ON-time

Fig. 55213

## Supply lines for cutting gas supply

To provide the customer with a flexible connection option, special hoses and clamping ring screws are provided by TRUMPF. The **customer-provided connection point** may thus be found at a radius of 5 meters around the **connection point on the machine**. The customer must provide the cutting gas supply lines up to the **customer's connection point** on the machine. The connection point on the machine is indicated on the installation plan by the following symbol:



Connection point for cutting gas on the machine

Fig. 70414

- Pipes should be used for the entire gas installation from the gas cylinder or central gas tank to the customer-provided connection point.
- The vaporizer must be designed to accommodate the maximum consumption of all connected machines. The line from the vaporizer to the connection point must be kept as short as possible for this purpose.
- The external gas installation should be set up in such a way that the supply lines to the connection point of the machine and the connection point itself are unable to ice up.
- Stop valves must be built in to all supply lines to the individual machines. This allows the supply lines to be blocked off

during maintenance and bled via the purge valves at the connection point of the machine.

**Note**

The gas temperature may not exceed 50 °C / 122 °F. This is of particular importance if the required gas pressure is generated by means of pressure booster systems!

- Pipes**
- Oil and grease-free lines made of special quality copper piping ("refrigerator quality", inert-soldered with simple shielding gas) should be used for the cutting gases.
  - The pipes must be processed without oil and grease.
  - Swagelok clamping ring screw fittings or constructionally equivalent clamping ring screw fittings made of brass are to be used on screw fittings. No press-fitting systems may be used.
  - Teflon tape, liquid Teflon, sealing sprays, lubricants and lubricating pastes must not be used.
  - Sealing points must be secured with flat gaskets.
  - Stainless steel pipes can be used but are not necessary. Then clamping ring screw fittings made of stainless steel must be used.
  - The pipe ends must be sealed securely to avoid dirt in transit and storage.

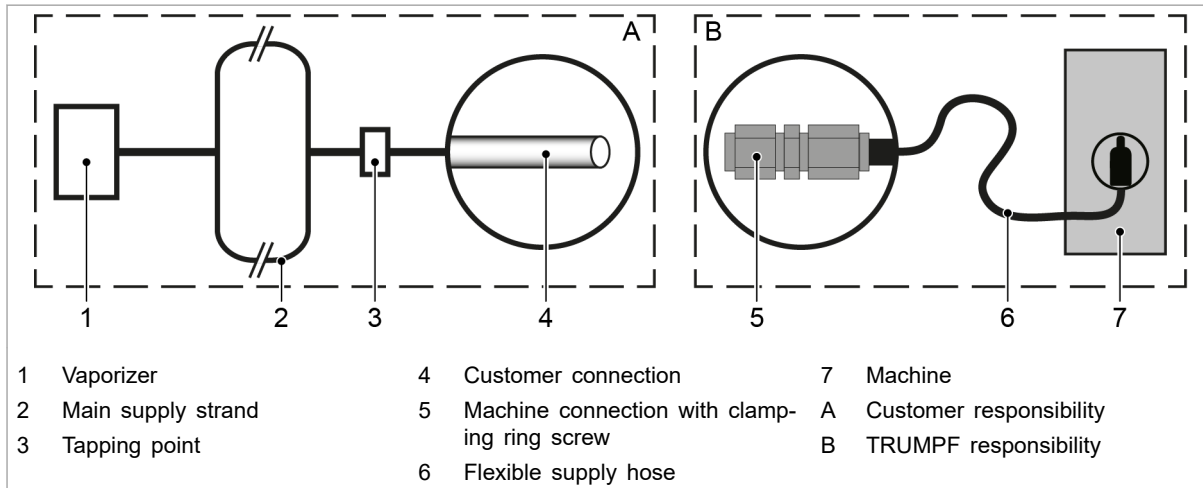

Gas supply

Fig. 75434

Pipeline section	Pipe dimensions	Nominal width in mm
For tank installation:		
Main supply strand (2) from vaporizer on (e. g. ring circuit).	1" or 28 x 1.5	25
From the main supply strand (2) to the tapping point (3)	3/4" or 22 x 1.0	20



Pipeline section	Pipe dimensions	Nominal width in mm
From the tapping point (3) to the customer connection (4)	N <sub>2</sub> : 3/4" or 22 x 1.0	20
	O <sub>2</sub> : 1/2" or 15 x 1.0	13

Customer gas supply: requirements

Tab. 2-8

Customer connection (4)	Pipe dimensions	Minimum length in mm
<b>Nitrogen line:</b> Tube piece made of copper (connection to the machine-side clamping ring screw (5, Swagelock Ø12))	12 x 1.0	40
<b>Oxygen line:</b> Tube piece made of copper (connection to the machine-side clamping ring screw (5, Swagelock Ø8))	8 x 1.0	40

Customer connection: requirements

Tab. 2-9

**Note**

As a general principle, a stop valve must be mounted before each branch in a ring pipeline in order to make it possible to shut down each ring pipeline segment separately

**Requirements on the connection point of the machine**

		O <sub>2</sub>		N <sub>2</sub>	
		Standard pressure	High pressure	High pressure	BrightLine fiber (option)
Minimum input pressure (flow pressure)	bar / psi	8 / 116	15 / 220	27 / 390	28 / 406
Max. static input pressure <sup>2</sup>	bar / psi	21 / 305	21 / 305	33 / 480	33 / 480
Maximum cutting gas pressure	bar / psi	12 / 174	12 / 174	20 / 290	19 / 275
Volume rate of flow <sup>3</sup> (volume under standard conditions)	m <sup>3</sup> /h / cfm	47 / 28	47 / 28	82 / 48	120 / 71 <sup>4</sup>
Nozzle diameter	mm	Ø 2.7	Ø 2.7	Ø 2.7	Ø 7.5

Cutting gas supply: Machine connection

Tab. 2-10

- 2 The machine is equipped with blow-off valves that respond at high input pressure, making a whistling sound in the process.
- 3 The volume rate of flow depends on the maximum cutting gas pressure selected and the nozzle diameter specified.
- 4 Distance of nozzle to sheet: 0.4 mm.

## Cutting gas supply with cylinders or bundles

- Cylinders or bundles**
- The easiest and most economical way of supplying cutting gas is with pressure reducers for cylinders or bundles. The handling requirements are higher however, due to the volume of consumption. One bundle consists of twelve gas cylinders = approx. 120 m<sup>3</sup> / 13200 gal.
  - The gas flow is interrupted when changing the cylinder or bundle.
  - This method of supply is only suitable in certain cases for N<sub>2</sub> high-pressure cutting.

- Cylinder banks or cylinder bundle banks**
- Switchover devices are required for uninterrupted operation with bottle or cylinder banks and also for changing cylinders.
  - Switching is accomplished either manually or automatically.<sup>5</sup>
  - Cylinder banks or cylinder bundles are frequently installed at some distance from the laser machine. For this reason, the use of a tapping point pressure reducer close to the laser system is recommended.

### Pressure control specifications

		O <sub>2</sub> Standard pressure	N <sub>2</sub> High pressure
Admission pressure	bar / psi	0-200 / 0-2900	0-200 / 0-2900
Max. perm. back pressure	bar / psi	25 / 360	40 / 580
Minimum flow rate <sup>6</sup>	m <sup>3</sup> /h / cfm	30 / 18	60 / 35
Other Requirements		Suitable for oxygen Oil and grease-free	Oil and grease-free

Cutting gas supply: pressure control specifications

Tab. 2-11

### Note

The specified pressure must be installed on the supply unit to monitor the pressure. Pressure regulators must be secured against the max. input pressure (inherently safe).

5 A signaling unit is recommended for automatic switching, because otherwise both sides of the cylinder or bundle bank could become empty without being noticed.

6 Volume under standard conditions.

## Cutting gas supply with gas tank

- A tank system is appropriate for safe gas supply at a gas consumption of at least about 200-400 m<sup>3</sup> / 7000-14000 ft<sup>3</sup> per week (volume under standard conditions).
- The optimum tank size depends on the tapping quantity and on the local conditions.
- The customer should consult the gas supplier.

The following are requirements for high-pressure cutting with nitrogen:

- Do not use a tapping point pressure regulator between the gas tank and the machine behind the pressure regulating station.
- A stop valve must be installed between the gas tank and the machine.

### Tank system

		O <sub>2</sub> Standard pressure	O <sub>2</sub> High pressure	N <sub>2</sub> High pressure
<b>Required pressure</b>	bar / psi	18 / 260	36 / 520	36 / 520
<b>Min. tapping pressure</b>	bar / psi	14 / 205	16 / 232	29 / 420

Cutting gas supply: Tank system

Tab. 2-12

### Pressure control specifications

	O <sub>2</sub> Standard pressure	O <sub>2</sub> High pressure <sup>7</sup>	N <sub>2</sub> High pressure
<b>First pressure stage (tank)</b>			
<b>Safety pressure regulation station <sup>8</sup></b>	Optional	Optional	Recommended
<b>Second pressure stage (tapping point)</b>			
<b>Tapping point pressure regulator</b>	Recommended	Recommended	Not recommended
<b>Back pressure</b>			
<b>bar / psi</b>	0-16 / 0-232	4-25 / 58-365	-
<b>Other requirements</b>	Suitable for oxygen; free of oil and grease	Suitable for oxygen; free of oil and grease	Oil and grease-free

Tab. 2-13

7 Only necessary for special applications, i.e. laser cutting with oxygen at high pressure.

8 The safety pressure regulation system is installed close to the tank. It ensures uniform pressure in the circuit. The built-in pressure relief valve ensures that gases are blown away into the open air in the event of malfunctions. In this way, risks are avoided in the area of the laser system due to a concentration of oxygen (O<sub>2</sub>) or depletion of oxygen (N<sub>2</sub>).

### 3.2 Nitrogen for cutting unit ventilation

<b>Purity</b>	(see "Purity", pg. 2-14)
<b>Input pressure</b>	An input pressure of at least 11 bar / 160 PSI must be ensured for cutting unit ventilation with nitrogen, regardless of the cutting gas.
<b>Nitrogen consumption</b>	The cutting unit ventilation has the following nitrogen consumption: max. 5+1 l/min / 0.18+0.03 cfm

Nitrogen for cutting unit ventilation

Tab. 2-14

#### Note

Do not switch off the nitrogen supply after switching off the machine, so that nitrogen still flows through the cutting unit. This creates constant excess pressure in the cutting unit, which prevents particles of dirt from entering the cutting unit from the ambient air.

## 4. Electrical supply

### What does the customer need to do?

Professional electrical installation is a basic prerequisite for smooth commissioning and trouble-free operation of the installation. The following chapter must therefore be passed along to the **specialist company for electrical installation** you have contracted with in a timely manner in accordance with the planning aid.

### 4.1 Power supply

#### Note

Impermissible voltage fluctuations endanger the faultless operation of the machines and reduce their performance. A voltage stabilizer is necessary. Otherwise a **regulated** isolating transformer can be used.

Rated voltage at 50 Hz $\pm 1$ %	400 V $\pm 10$ %
Rated voltage at 60 Hz $\pm 1$ %	460 V +10 %/-5 % <sup>9</sup>

Rated voltage

Tab. 2-15

#### Note

The range of tolerance applies exclusively to the short-term supply fluctuations and not to its permanent operation.

An isolating transformer must be installed if the actual rated voltage deviates from the rated voltage specified above (400 V or 460 V).<sup>10</sup>



The electrical supply is connected to the control cabinet on the machine at the connection point marked on the installation plan by the symbol shown on the left. The other system components (cooling/suction-unit) are supplied via this connection.

9 This specification complies with the standards of the American National Standard (ANSI) C84.1 Table 1, "Voltage range A".

10 The tolerance of the line must be determined if the rated voltage is 380 V or 415 V at 50 Hz. No isolating transformer is required if the tolerance is between 360 V and 440 V.

Electrical power supply	Connecting line		
	Cable	Cross section	Ground wires
According to DIN EN 60204-1/4.3.1	4-pole copper cable (L1, L2, L3, PE)  Single-wire or multi-wire with conductor end sleeves, make the connection finger-safe, clockwise phase rotation	According to VDE 0100 Part 430 (IEC 384-4-47)	According to VDE 0100 Part 540 (IEC 384-5-54)

Electrical connection

Tab. 2-16

**NEC conditions Note**

NEC conditions apply only to Canada and the USA.

- A four-pole connection is required: L1, L2, L3 and PE.
- THHN copper or equivalent is recommended (2 000 V maximum output) designed for a maximum temperature of 90°C / 194°F.
- No aluminum cables may be used to connect the machine.
- The conductor cross-section must correspond to NEC 670-4 (a), with a permissible amperage of at least 125% of the full operating current specified on the nameplate.
- To ensure voltage stability and rating, the line dimension should be larger than specified in the NEC table 310-16.

**Power supply configuration**

With IT and TT power supply configurations as well as asymmetrical power supply configurations (one phase grounded), the machine must be connected via an isolating transformer.

A surge diverter is required if the machine is connected to an IT power supply configuration.

TRUMPF recommends surge diverters from the following manufacturers:

- Phoenix Contact GmbH & Co. KG, Flachmarktstraße 8, D-32825 Blomberg, E-mail: info@phoenixcontact.com.
- Dehn+Söhne, PO Box No. 1640, D-92306 Neumarkt, E-mail: info@dehn.de.

**Corner-grounded delta network**

When connecting the machine to a power supply configuration with a grounded outer conductor, an **unregulated** isolating transformer must be used.

**NEC conditions Note**

NEC conditions apply only to Canada and the USA.

Power supply configuration:

- A Y power supply configuration (star configuration) with a grounded star point is required.
- In an existing delta power supply configuration, a grounded transformer in star configuration must be installed by the customer (see NEC article 450-5).

Grounding:

- The machine and power distributor system must be equipped with a grounding line in accordance with NEC article 250, "Grounding".
- For details on grounding power distributor systems and industrial plants, refer to the NEC standards or consult an electrician or the power station.

## Residual current device (RCD)

### Notes

- Whether a residual current circuit breaker has to be used depends upon the local electricity company.
- On the line side, only residual current circuit breakers of type B (sensitive to all types of fault current, EN 50178/5.2.11.2; VDE 0160) are approved.

A residual current circuit breaker provides protection from fault currents due to directly or indirectly touching live parts.

#### **Residual current circuit breaker for direct contact**

If a residual current circuit breaker is used to provide protection from direct contact, an isolating transformer must be used (EN 50178 section 5.2.11.1, VDE 0160). This is because the fault current resulting from the design is >30 mA.

#### **Residual current circuit breaker for indirect contact**

If a residual current circuit breaker is to be used to provide protection from indirect contact, this must be selected depending on the machine's fault current.

### Notes

- In rare cases, customer-side voltage fluctuations on the machine's power input filter may lead to higher fault currents than the typical value specified. The main power supply and the machine must then be separated by an isolating transformer.
- Typically, the machine's fault current is approx. 300 mA.

TRUMPF recommends the following residual current circuit breakers:

- Dipl. Ing. W. Bender GmbH & Co. KG, Postfach 1161, D-35305 Grünberg, Germany. E-mail: info@bender-de.com.
  - RCMA series.
- Doepke Schaltgeräte GmbH & Co. KG, Stellmacherstrasse 11, D-26506 Norden, Germany. E-mail: info@doepke.de.
  - DFL 8 B SK series.

## Connection to an uninterruptable power supply installation

The following applies in the event that it is necessary to connect the system to an uninterruptible power supply installation (UPS plant):

- When working out the dimensions of a UPS plant, the short-circuit and overload responses of the UPS system are to be taken into account, along with the continuous power and the electrical connected loads (see "Connected loads, fuse protection").
- As a rule: overload capacity of the UPS plant  $\geq 200\%$  for 0.5 s.
- The machine creates inrush currents of up to 200 A RMS with peak currents of up to 350 A within the first 100 ms. The UPS must be able to withstand those inrush currents without shutting down.

### Note

The dimensioning of the uninterruptible power supply plant must be established without fail by the manufacturer of the UPS plant!

## Isolating transformer

The following must be observed if the machine is equipped with an isolating transformer:

- The cable from the isolating transformer to the control cabinet of the machine must be provided and laid by the customer.
- The customer must determine the location of the isolating transformer. The isolating transformer is not indicated on the installation plan.
- The isolating transformer must be installed in such a way that access via the door on the front side (door with nameplate) remains free. For the required safety distance see

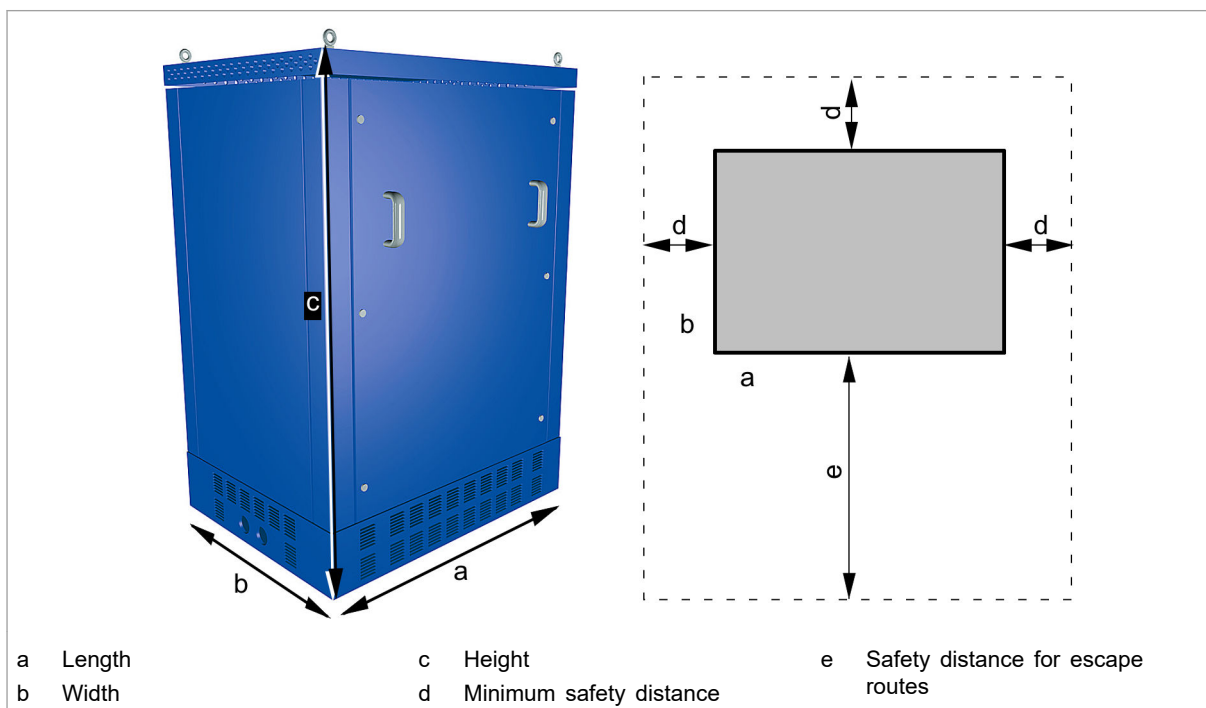

table below. The minimum safety distance must be maintained both behind and next to the transformer.

Dimensions	
Length (a) x width (b) x height (c)	1050 mm x 750 mm x 1400 mm 41 in x 30 in x 55 in
Minimum safety distance (d)	100 mm / 4 in
Safety distance for escape routes (e)	IEC: 800 mm / 32 in NEC: 1070 mm / 42 in

Space requirements

Tab. 2-17



Space requirements for the isolating transformer

Fig. 41340

The documentation "Series Transformer MD 90000" of the manufacturer Roller and Fischer applies to the isolating transformer. The documentation is available in German, English, and French.

The series transformer MD 90000 is not allowed to be used in the USA.

**Isolating transformers of other manufacturers**

If the system is not equipped with the isolating transformer listed above (e.g. in the USA), the following applies:

- The kVA power of the transformer must be at least 10% higher than specified on the machine nameplate.
- Short-circuit voltage (impedance) of 2% to 3%.
- Taps are required on the primary side of the transformer to equalize voltages that are constantly above or below the nominal supply voltage.

- 
- The taps should be +10 V, +20 V, -10 V and -20 V of the nominal supply voltage.
  - A copper wound transformer is recommended. Aluminum wound transformer are not recommended because of their inherently higher impedance.
  - (see ["Power supply configuration", pg. 2-24](#)) for the power supply configuration of the isolating transformer.

## 4.2 Connected load, fuse protection

### Connected loads

		TruDisk 2001	TruDisk 3001	TruDisk 4001
Total connected load incl. all possible options, process cooler and possible automation	kVA	28	31	35
Fuse protection at 400 V / 460 V	A	50 / 50	63 / 50	63 / 60
Maximum acceptable interruption of the nominal voltage		See EN 60204, Part 1, 4.3.2, Alternating current supply		

Connected loads

Tab. 2-18

### NEC conditions Note

The NEC conditions apply only to Canada and the USA!

The use of time-delay fuses is preferred. If circuit breakers are also used for branch protection, a breaker, like an ETI Type circuit breaker, must be used to handle the current surge when turning on the machine.

## 4.3 Power consumption

The power consumption of the machine depends on the laser output. The power consumption in standby mode (0 % laser power) is approx.:

- TruDisk 2001: 6 kW.
- TruDisk 3001: 9 kW.
- TruDisk 4001: 9 kW.

See the illustration below for the power consumption including suction and process cooler at an ambient temperature of 25°C.

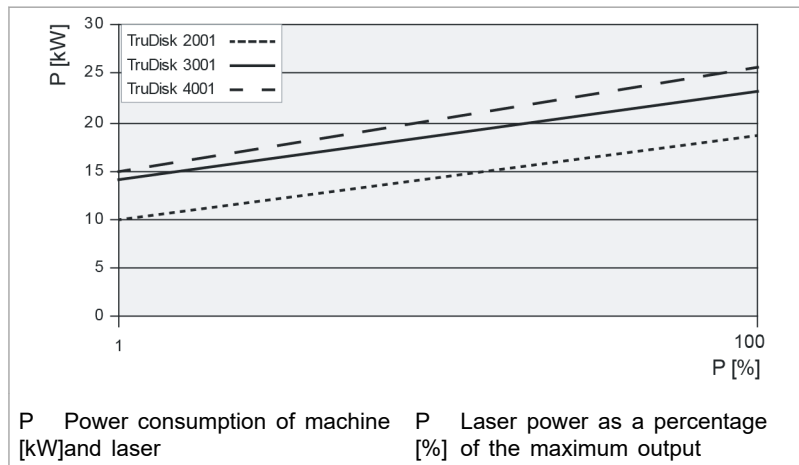

Fig. 86087

## 4.4 Network link

TRUMPF provides a RJ45 line interface in the control cabinet of the machine.

**Remote support** The customer has to provide two UDP ports for the remote support:

- UDP Ports 500 and 4500 (for standard IPsec)
  - Open from LAN to internet.

### Note

It is not necessary to open the ports from internet to LAN. The installed mGuard module opens the communication to the remote support via the two UDP ports.

### Establish an alternating current supply for the personnel switch

If several machines are to be connected to the network, a personnel switch (network distributor) is necessary. The network distributor can be found in the electrical cabinet of the machine. The alternating current supply must be provided, since the network distributor must work even if the machine is switched off.

### Note

The same nominal voltage and frequency tolerances as those for the machine are applicable when using a personnel switch (network distributor).

### Providing power supply

- Worldwide (outside the USA and Canada): 230 V with grounded socket or in accordance with the receptive national

- 
- standard. The grounded coupling is delivered with the machine.
- USA and Canada: 115 V with plug socket according to USA standard.

## 5. Compressed air supply

### What does the customer need to do?

For professional use with respect to the subject of compressed air supply, please consult a suitable specialist company and pass along the following subchapter to the appropriate officials there.

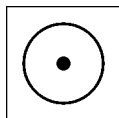

### Note

The connection point is indicated on the installation plan using this symbol.

### Compressed air supply

The compressed air connection may be flexible or may consist of a fixed pipeline to the machine.

Connecting elements must be executed with standard screw fittings. Quick-release couplings as connecting elements have an excessive throttle effect.

The compressed air supply must be equipped with a hand-operated 3/2 directional valve with air exhaust on the machine immediately in front of the machine input.

### Compressed air connected loads

	TruLaser 2030 (L82)
Required network pressure	7-12 bar / 100-175 psi <sup>11</sup>
Average consumption <sup>12</sup> (required volume rate of flow according to ISO 1217 or DIN 1945)	ca. 28 m <sup>3</sup> /h / 16.5 cfm
Total consumption with compressed air cutting	ca. 40 m <sup>3</sup> /h / 23.5 cfm

Connected loads for compressed air

Tab. 2-19

### Supply lines compressed air supply

Minimum nominal diameter of the supply lines	½" (DN13)
Ring circuit length m / ft	max. 50 / 164 (due to formation of water condensation)
Ring circuit diameter	at least 1" (26 mm)
Length of the connection line from the ring circuit to the connection point on the machine m / ft	max. 5 / 16.4

Supply lines for compressed air supply

Tab. 2-20

11 A minimum network pressure of 7.5 bar / 110 psi is required if a nozzle of  $\varnothing$  2.7 mm is used for compressed-air cutting (optional).

12 Volume under standard conditions

**Compressed air properties  
at the tapping point**

Property	Requirement	Quality class (ISO 8573-1; 2001 edition)	Recommendation
Dust-free	Maximum particle size: 40 µm Maximum particle density: 10 mg/m <sup>3</sup>	7	Air filter on the compressor
Condensate-free	Cooled down to +3 °C / 37 °F (pressure dew point)	4	Cold dryer
Oil-free	Maximum oil content: 5 mg/m <sup>3</sup>	4	Oil-free sealing screw-type compressor with active carbon filter

Tab. 2-21

**Compressors** A suitable compressor must be provided if there is insufficient compressed air. Maximum distance from the compressor to the basic machine is 50 m / 164 ft. Condensation water can form with distances >50 m / >164 ft.

## 6. Operating materials

**What does the customer need to do?**

The following operating materials must be provided by the operator in due time before the machine is delivered.

### 6.1 Workpieces

Two sheets must be provided for the machine acceptance:

- Material: DD11 Mat. No. 1.0332 (EN 10111).
- Dimension: 1000 x 1000 mm / 40 x 40 in.
- Sheet thickness  $s = 2.0 \text{ mm} / 0.08 \text{ in.}$

### 6.2 Cooling water

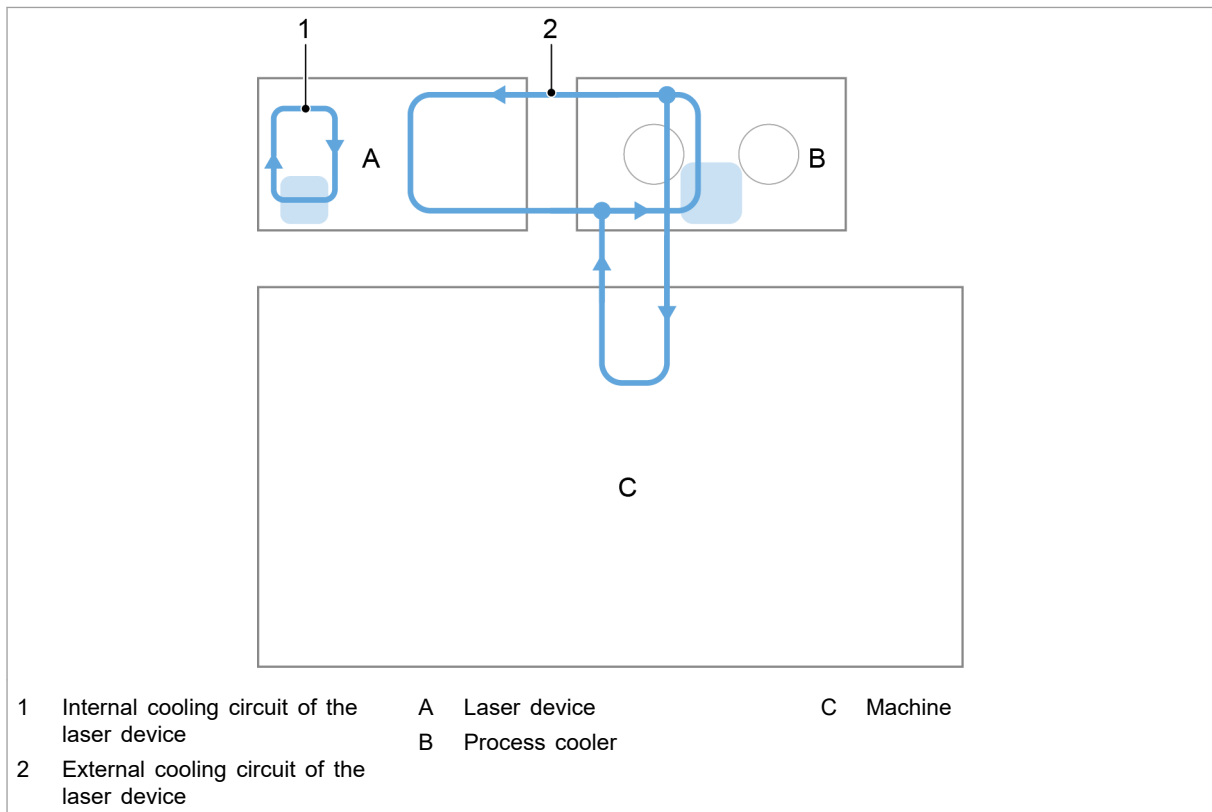

Cooling circuits of the machine's standard version

Fig. 87671



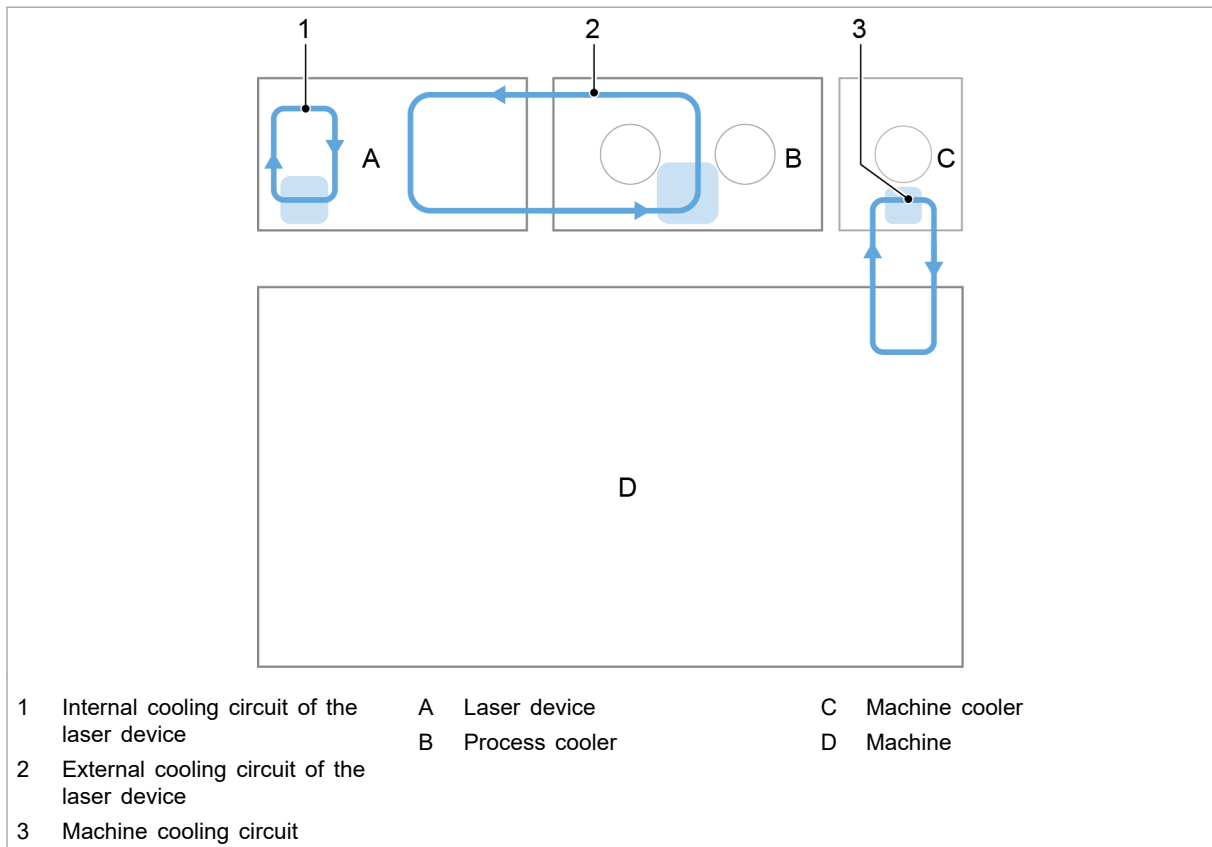

Cooling circuits of the machine's 43°/50° version

Fig. 87672

Cooling water is required to cool the laser device and to cool the machine's components. The machine and the laser device are cooled by the following cooling circuits:

- Internal cooling circuit, laser device.
- External cooling circuit, laser device.
  - With the standard version, the laser device and the machine are connected to this cooling circuit.
  - With the 43 °C/50 °C version, only the laser device is connected to this cooling circuit. The machine is cooled by an additional machine cooler.
- Machine cooling circuit (43 °C/50 °C version only).

**NOTICE**

**Damage is caused to the machine and to the laser device if tap water or contaminated water is used!**

- Cooling water should be stored only for short periods.
- Transport and store water in clean plastic containers (without deposits).
- Avoid contact with the water. Foreign substances (excluding algae inhibitors and anticorrosive agents) impair the quality of the water.
- Use additional equipment for filling water, such as pumps, hoses or stop valves, exclusively for handling the cooling water.

**Cooling water quantities** All cooling circuits will be flushed repeatedly and then filled with cooling water at the time the machine is commissioned.

Ambient conditions	Internal cooling circuit for laser TruDisk (FD27)		External cooling circuit for the machine (KLH chiller L 0/5 TK)		External cooling circuit for laser (KLH chiller type RL 16/0 TK)	
	Volumetric capacity of cooling circuit in l / gal	Required water quantity in l / gal	Volumetric capacity of cooling circuit in l / gal	Required water quantity in l / gal	Volumetric capacity of cooling circuit in l / gal	Required water quantity in l / gal
<b>Standard version</b>	55 / 14.5	110 / 29.1	-	-	140 / 37.0	280 / 74.0
<b>43/50 °C version</b>	55 / 14.5	110 / 29.1	80 / 21.1	160 / 42.3	140 / 37.0	280 / 74.0

Required cooling water at time of commissioning

Tab. 2-22

**Cooling water requirements** **Notes**

- The specified chemical/physical properties must be complied with without exception. Consult your supplier with regards to this matter.
- Do not use distilled water! The quality of distilled water can fluctuate considerably.
- For an in-house water system provided on site as the external cooling system for the TruDisk laser, tap water according to VDI standard 3803 can be used.

Cooling water	Properties
<b>Conductivity of freshly filled water</b>	max. 10 µS/cm
<b>Conductivity for newly replaced water after 10 minutes of circulation</b>	Max. 20 µS/cm
<b>Conductivity limit of the cooling water after addition of the anti-corrosive agent</b>	max. 200 µS/cm
<b>Max. permissible carbonate content</b>	less than 100 mg/l
<b>Color</b>	Colorless
<b>Cloudiness</b>	None

Cooling water	Properties
Odor	odorless

Requirements

Tab. 2-23

**Handling Note**

Additional water-filling equipment (Pumps, hoses and stop valves) is **not** part of the scope of delivery of the machine. The pumps of the process cooler may **not** be used to pump out the cooling water when replacing the water.

**Algae inhibitors and anticorrosives**

Algae inhibitors and anticorrosives for the cooling circuit are supplied together with the machine. The regulations in the maintenance chapter in this Operator's manual must be observed when adding these components to the cooling water.

**Installing process cooler in an area with a risk of frost**

If the process cooler is installed in an area with a risk of frost, then the "high purity ethylene glycol" antifreeze agent must be added to the cooling water.

The antifreeze agent is to be provided by the customer at machine start-up.

The mixing ratio is dependent on the temperature at the installation site. Recommendation: Operate the chiller the whole year long with antifreeze agent.

Temperature	to -15 °C / 5 °F	to -24 °C / -11.2 °F
Percent of weight in %	30	40
Percent by volume in %	27	35

Mixing ratio

Tab. 2-24

**Notes**

- If no antifreeze agent is to be used any more, e.g. after in-house relocation, then the cooling circuits must be flushed with cooling water. This cleaning cycle must take place before filling and operating the cooling circuits with the final volume of cooling water.
- Careful flushing is required because residues of the anti-freeze agent in the cooling water could promote corrosion.

## 7. Transport

The arrangements and transport of the system from the truck to its final installation site need to be prepared and carried out.

### Machine conveyance to customer's site by TRUMPF

In some countries the customer can have TRUMPF transport the system from the truck to the final installation site, the so-called "Machine conveyance to customer's site". The transport route may not exceed the length contractually agreed to. The transport route must be flat, with no steps or ramps.

If the customer has assigned TRUMPF with the Machine conveyance to customer's site, the customer must only ensure that the transport route satisfies the requirements listed below. TRUMPF will deal with all the other points mentioned in the following, including auxiliary tools and means of transportation.

### Transport regulations

Refer to the following transport regulations for detailed conditions for the transportation of the system:

- TruLaser 2030 (L82): drawing no. 93774-8-A8

A copy of the transport regulations can be found in a clear plastic envelope on the machine upon delivery.

## 7.1 Permitted auxiliary tools

### Note

The carrying capacity of the authorized auxiliary equipment must be selected in such a way that the maximum load can be transported safely.

The transport weight of the machine is:

- 7750 kg / 17050 lb.

Recommended auxiliary tools
Crane truck for unloading the truck:
Correct size for the eyebolt supplied: Shackles and usual chains (e.g. oval suspension link)
Gantry crane for transporting the machine
<b>or</b>
Armored rollers: 1 steerable, 2 fixed
A minimum of 2 hydraulic hoisting jacks, adjustable height $\leq 30$ mm
Hoisting iron (1 m) with extension.
Adjustable crane chain
Fork lift for the transportation of accessory systems

Tab. 2-25

## 7.2 Checking, unloading and transporting the machine

- Please observe**
- All transport work must be carried out in accordance with the transport regulations.
  - The machine may not be lowered on to the ground without supports. Otherwise the bottom of various components will be damaged. The distance from the machine bearing plates must be  $\geq 100$  mm / 4 in. This distance to the floor must also be maintained during the transportation of the machine to its installation site.
  - The floor requirements at the installation site must correspond to the requirements of these installation conditions. Cutouts, bore holes, etc. in the factory floor must be prepared by the customer in accordance with the foundation plan prior to installation of the machine.

### On delivery: check the machine

1. Examine all components for any transport damage.
2. Record visible damage caused during transport on the cargo note and have the record countersigned by the truck driver.
3. Report any hidden transport damage to the insurance company and TRUMPF within six days.

### Unloading and transporting the machine

 **CAUTION**

**Considerable damage from raising the machine by its front part!**

- Only lift the machine as described below.

 **DANGER**

**Suspended load!**

**Falling loads could lead to severe bodily injury or even death.**

- Observe safety regulations for the handling of heavy loads.
- Never walk under a suspended load.
- Use tested and appropriately sized tackle and means of transportation.
- Employ qualified technicians to transport the machine.
- Carry out transport in accordance with the transport regulations.

1. Unload the machine from the truck using a crane truck of suitable lifting power.
2. Move the machine from the yard into the factory hall on armored rollers.

**or**

- Either a gantry crane of sufficient carrying capacity or armored rollers can be used for subsequent transportation.

#### **Note**

Hydraulic hoisting jacks are required to position and align the machine at the installation site when using armored rollers.

3. Place the machine next to the final installation position, on armored rollers.

If the conditions on site do not allow this, you must inform TRUMPF's Technical Service as soon as possible. In this case the machine can be placed on the installation elements provided with it at the final installation position **after appropriate coordination**.

## **Transport TruDisk laser device**

The laser device can be transported by pallet jack or forklift truck. Please note:

- **When transporting with a forklift truck:** The laser device may not be tilted by more than a maximum of 10°. Use a padded mat to protect the laser device from damage. Secure the laser device against falling down using a transport belt on the mast of the forklift truck.
- **When transporting using a pallet jack:** Insert the pallet jack so that front rollers do not touch the bottom plate of the laser device.

#### **Conditions**

- Laser device is switched off.
- Laser light cable (LLK) is disconnected.
- Supply connections have been removed.
- With temperatures below 0 °C / 32 F or with long-distance transport: Cooling circuit is emptied completely.

#### **Means, Tools, Materials**

- Protection mat.
- Pallet jack or forklift truck.

**NOTICE****Damage to the laser device!**

- Carefully raise, transport and set down the laser device.
- Transport the laser device standing and horizontally leveled.
- Transport the laser device with an air-cushioned truck.
- Use plywood crates for long-distance transport.

**NOTICE****Destruction of the laser device during transport at temperatures under 0 °C / 32 F!**

- At temperatures below 0 °C / 32 F transport the laser device in a tempered packaging.

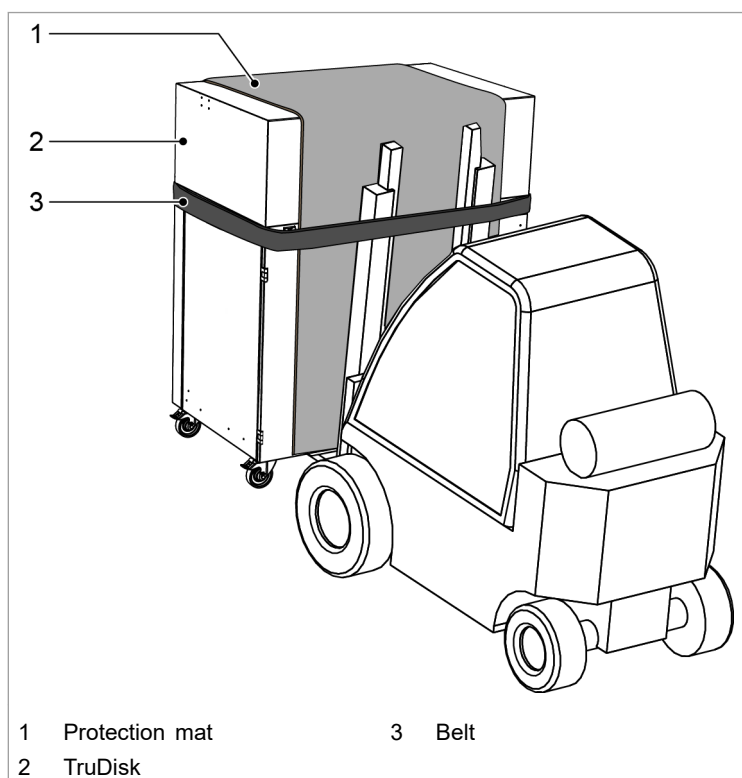

Transporting TruDisk

Fig. 87661

1. Cover laser device with a protection mat.
2. Move the pallet jack or forklift to underneath the laser device according to Fig. 87661.
3. When transporting using a forklift truck: Secure the laser device with a transport belt.
4. Lift and transport the device.



1 Brakes (4x)

Transport rollers TruDisk

Fig. 91268

5. After setting up the laser device, lock the brakes (1) into position at all four rollers.

### 7.3 TRUMPF service work

**Leveling the machine** The machine is leveled by TRUMPF service technicians.

**Putting machine into service** The machine is put into service by TRUMPF service technicians. This includes the installation of the components according to the installation plan, the connection of the system to the supplies as well as instructing personnel and the functional inspection of the machine.