

PROGRAMMING MANUAL

— FOR

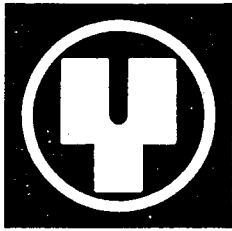

MAZAK

MAZATROL

CAM T-2 & T-3

(P R I M E R)

SERIAL NUMBER : 60866



CONTENTS

	Page
1. INTRODUCTION	1-1E
2. A SMALL NUMBER OF KEYS ARE USED TO PREPARE A PROGRAM ..	2-1
3. PREPARING A SIMPLE PROGRAM	3-1
3-1 Rules of Preparing a Program	3-1
3-2 Outside Diameter Cutting (BAR-OUT)	3-2
3-3 Inside Diameter Cutting (BAR-IN)	3-14
3-4 Edge Cutting (EDG)	3-20
3-5 Grooving (GRV-OUT)	3-23
3-6 Threading (THR-OUT)	3-27
4. TO PREPARE A MILLING PROGRAM	4-1
4-1 Drilling (MDR)	4-1
4-2 Machining a Key Way (MGV)	4-9



1. INTRODUCTION

The MAZATROL CAM T-2/T-3 is discussed.

The MAZATROL T-1 has been enjoying a good reputation as a computer numerical control (CNC) device which allows programming while communicating with the machine in human language without special knowledge and without complex calculations with a desk-top electric calculator. With these features of MAZATROL T-1 remaining a wide diversity of new functions have been added to make MAZATROL CAM T-2 a CNC device with remarkably improved operational convenience.



The MAZATROL CAM T-3 allows programming on a three-axis conversation basis for the first lathe with the C-axis (rotary axis). It has a conversation milling capability (drilling, tapping, end milling and grooving) added to the T-2.



How to prepare a program is described below.

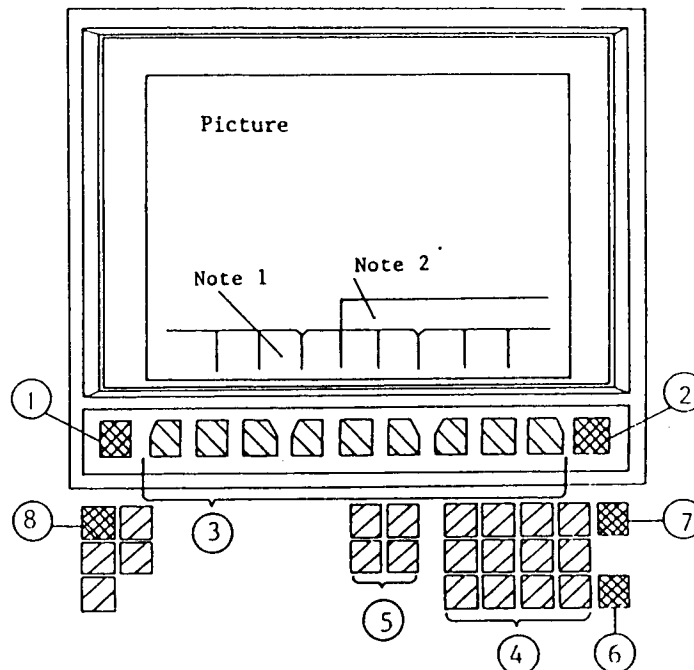

2. A SMALL NUMBER OF KEYS ARE USED TO PREPARE A PROGRAM.



- (1) Picture Select Key 
Press this key to select a picture. Press this key and the picture select menu (POSITION, COMMAND, TOOL SET, etc.) will be displayed. Press the menu key (3) to display desired picture.
- (2) Menu Select Key 
Press this key to change the information displayed in the menu blocks. (See Note 1.)
- (3) Menu Keys
Nine yellow keys are provided to select a menu just above the key pressed.
- (4) Numerical Keys
Numerical keys include 0 thru 9, decimal point, negative sign, etc. The numerical value pressed is displayed in the message column. (See Note 2.)
- (5) Cursor Keys 
Press these keys to move the cursor. (See Note 3.)

- (6) INPUT Key 
Press this key to input a numerical value in the message column to where the cursor is flashing.
- (7) CLEAR Key 
Press this key to erase a numerical value in the message column. This key is also pressed to erase a blue alarm indication (warning).
- (8) RESET Key 
Press this key to erase a red alarm indication (warning). (See Note 4.)

Note 1: The term "menu" means the information displayed in nine blocks along the lower part of the screen.

Note 2: The term "message" means a question or inquiry. An operation should be advanced while keying in to answer the question displayed in this column.

Note 3: The term "cursor" means a blinking mark which moves across the screen.

Note 4: The RESET key has various other functions.



3. PREPARING A SIMPLE PROGRAM

3-1 Rules of Preparing a Program



... indicates that the picture select key is pressed to make a changeover of the picture.



... indicates that the menu select key is pressed to alter the menu displayed.

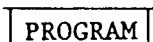

... indicates that the menu key is pressed to select the menu "program". (See Note 1.)

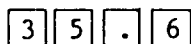

... indicates that numerical keys have been pressed. These numerals "35.6" will appear in the message column.

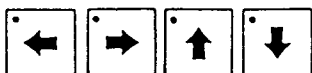

... indicates that four cursor keys are respectively pressed to move the cursor.



... indicates that the INPUT key is pressed to input numerals in the message column into a program.

"STARTING POINT-X?"

... indicates the information displayed in the message column.



... indicates that the CLEAR key has been pressed.



... indicates that the RESET key has been pressed.



... indicates the "cursor".

Note 1: Some menus, which are available as option, may not be displayed though they are described in this manual. In such a case, proceed to the next line and continue inputting.



	PROGRAM	WORK NO.
"WORKPIECE NO.?"▶	1 2 3 4

Enter the program number.

Sixteen types of programs can be recorded. Programs may be numbered from 1 to 9999. Initially, any number may be selected, because no program has yet been entered.

"NEW PROGRAM (PROGRAM)?"▶	PROGRAM
"MAZATROL OR EIA/ISO (MENU)?"▶	MAZATROL PROGRAM
"WORKPIECE MATERIAL (MENU)?"▶	CBN STL
"WORKPIECE MAX OUTER DIA.?"▶	1 0 0
"WORKPIECE MIN INNER DIA.?"▶	0
"WORKPIECE LENGTH?"▶	8 0

Enter the dimensions of a material before machining in accordance with messages "WORKPIECE MAX OUTER DIA.", "WORKPIECE MIN INNER DIA." and "WORKPIECE LENGTH".

"MAX SPINDLE RPM LIMIT?"▶	2 0 0 0
"FINISH ALLOWANCE-X?"▶	0 . 2
"FINISH ALLOWANCE-Z?"▶	0 . 1
"WORKPIECE FACE STOCK REMOVAL-X?"	...▶	0

For MAX SPINDLE RPM LIMIT, enter the upper spindle speed limit adopted in the program. If the spindle is to turn at a speed up to the maximum available in the machine, enter 0.

For FINISH ALLOWANCE-X and FINISH ALLOWANCE-Z, enter the stroke of cutting by means of finishing tools. For FINISH ALLOWANCE-X, enter twice the cutting allowance at one side, that is, the value of the diameter.

For WORKPIECE FACE STOCK REMOVAL-X, enter an end cutting allowance, if any.

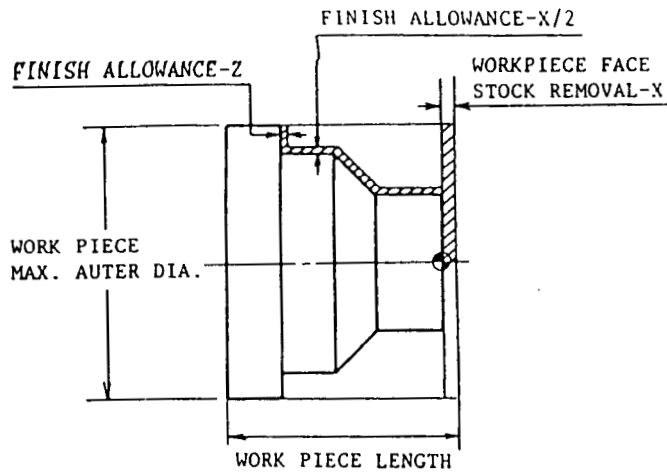

One line of data has now been prepared.

The MAZATROL coordinate systems will now be described.

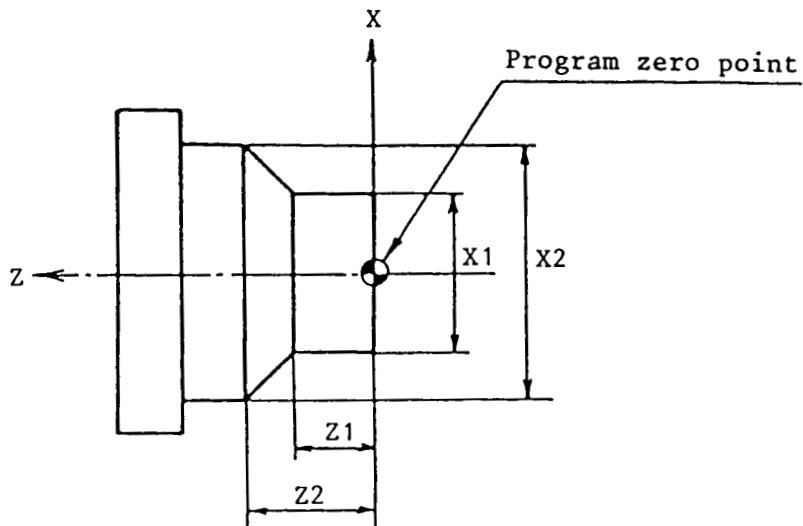

1) X and Z:

X is defined as the diameter dimension of a workpiece and Z as the longitudinal dimension of a workpiece.

2) Program zero point:

The program zero point is the point at which the turning center of a workpiece (X-axis) intersects with the right end of a finished workpiece (Z-axis). (⊕ in the Figure)



3) To give a dimension command:

X-axial ... In any case, give the diameter of a workpiece as a command without change.

Z-axial ... Give a size from the zero in Z (right end of a workpiece) as a command.

Continue entering.

"MODE (MENU)?"▶	BAR
"MACHINING PART (MENU)?"▶	OUT

For all cylindrical materials, select the BAR menu.

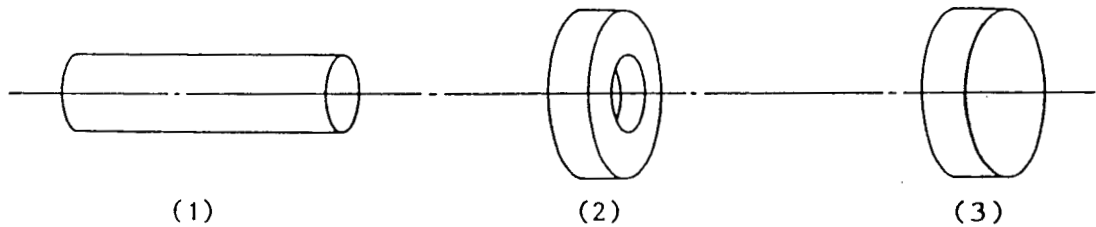

(1), (2) and (3) all belong to BAR.

Use the OUT menu to machine starting from a midway point of the material.

For outside diameter cutting, select the OUT menu.

"CUTTING POINT-X?"▶	1	0	0	↔
"CUTTING POINT-Z?"▶	0	↔		

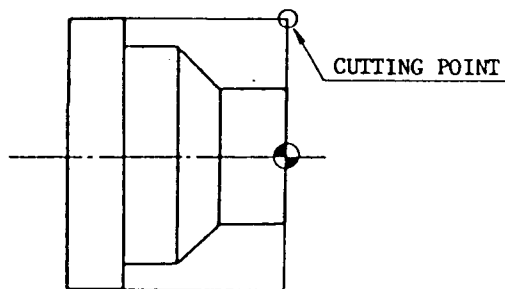

CUTTING POINT-X and CUTTING POINT-Z are the point where machining be started as illustrated below.



(Note)

How to take CUTTING POINT in a variety of shapes to be machined is described in the Application Version of the Programming Manual.





"ROUGHING SURFACE SPEED?"▶	AUTO	-
"FINISH SURFACE SPEED?"▶	▶	*
"ROUGH CUT FR/R?"▶	▶	*
"DEPTH OF CUT?"▶	▶	*

*  may be also used. Continuously pressing a cursor key, such as , will cause the cursor to continue to move.

Pressing the AUTO menu key will automatically determine as follows:

- Roughing/finishing tool surface speed (m/min)
- Roughing tool stroke of feed per turn of spindle (mm/rev.)
- Roughing tool depth of cut per cycle (mm)

The values automatically determined vary with machine specifications. These numerical values can be changed freely.

"GEAR NO.?"▶	▶	
"ROUGHING TOOL NO.?"▶	1	
"OFFSET NO.?"▶	1	
"FINISHING TOOL NO.?"▶	2	
"OFFSET NO.?"▶	1	



Spindle gear will be determined automatically with its number remaining "0".

When numerical values are inputted for GEAR NO., the gear for rough machining can be selected and determined automatically. For number of gear stages, refer to the machine specifications.

Roughing tool Finishing tool

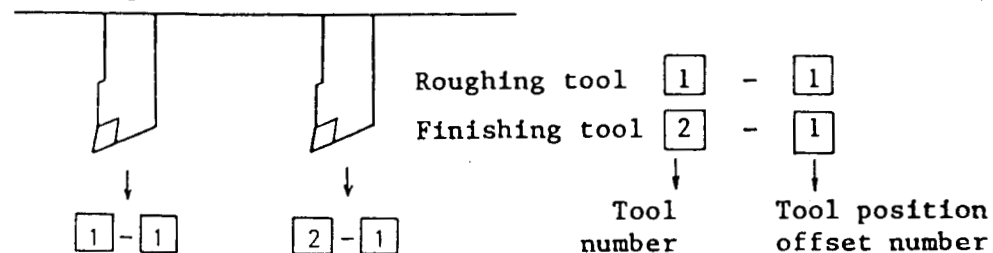



For OFFSET NO., two tool offset positions are available per tool. Enter "1" or "2" to select the tool position. With "0" selected, no position will be offset.

"SHAPE PATTERN (MENU)?" LINEAR

"SHAPE PATTERN" will be described below.

For outside diameter cutting, inside diameter cutting and facing, shapes could be classified as :

- LINEAR Linear a straight line without inclination
- TAPER Taper an inclined straight line
-  Convex arc a convex arc for a workpiece
-  Concave arc a concave arc for a workpiece

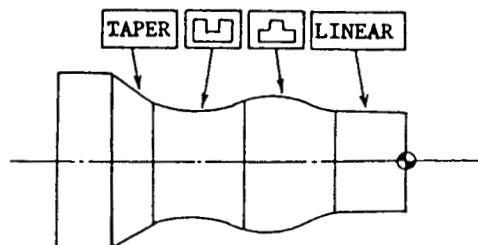

"STARTING CORNER?"▶	2	↔	
"FINAL POINT-X?"▶	5	0	↔
"FINAL POINT-Z?"▶	2	5	↔
"FINAL CORNER?"▶	↔		

Some additional explanations will be given.

In turning, corners are often chamfered circumferentially or radially. This can be most easily programmed by the use of starting and final corner.

Starting and final corner cover circumferentially or radially chamfering. To chamber radially, press the CORNER R menu key and then enter a radius.

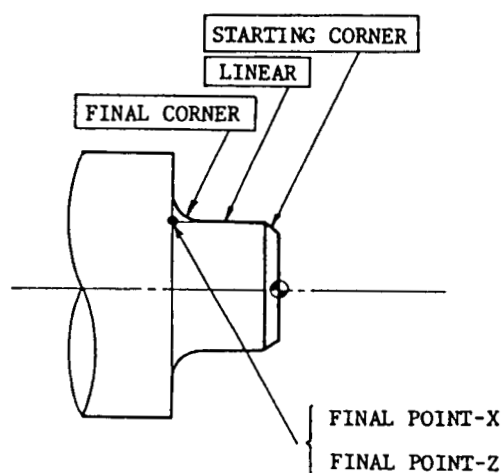

FINAL POINT-X represents the finish diameter of the machined portion.

FINAL POINT-Z represents the longitudinal end point of the machined portion.

"FIN SURFACE ROUGHNESS (MENU)?"▶	▽	4	or	4	↔
"NECKING OR FR/M (MENU)?"▶	↔				
"M CODE (MENU)?"▶	↔				







FIN SURFACE ROUGHNESS is determined by selecting a drawing finish code from the menus. The feedrate of a finishing tool is calculated automatically to execute the program so that a specified surface roughness will be attained.

Drawing finish codes and surface roughness menus are related as shown below.

100-S ▽	50-S ▽	25-S ▽▽	12-S ▽▽	6-S ▽▽▽	3-S ▽▽▽	1.5-S ▽▽▽	0.8-S ▽▽▽▽	0.4-S ▽▽▽▽
▽ 1	▽ 2	▽▽ 3	▽▽ 4	▽▽▽ 5	▽▽▽ 6	▽▽▽ 7	▽▽▽▽ 8	▽▽▽▽ 9

To enter for "NECKING OR FR/M (MENU)?" and "M CODE (MENU)?", press the INPUT key  only.

Details are described in the Application Version.

"SHAPE PATTERN (MENU)?"▶	TAPER
"STARTING CORNER?"▶	0  *
"STARTING POINT-X?"▶	CONTINUE
"FINAL POINT-X?"▶	8 0 
"FINAL POINT-Z?"▶	4 0 
"FINAL CORNER?"▶	

* If 0 is to be set with 0 displayed in advance, press  only.

For LINEAR, specify FINAL POINT only. For TAPER, "⏏" and "⏏" (arcs), it is necessary to specify both STARTING POINT and FINAL POINT.

If the final point of the preceding line is identical with the starting point of a line being currently prepared, pressing the CONTINUE menu key will cause the same numerical value to be entered.

"FIN SURFACE ROUGHNESS (MENU)?"▶	<input type="text" value="5"/>	or	<input type="text" value="5"/>	<input type="button" value="↔"/>
"NECKING OF FR/M (MENU)?"▶	<input type="button" value="↔"/>			
"M CODE (MENU)?"▶	<input type="button" value="↔"/>			

Enter in the same manner as that for the preceding line.

While programming, check the program to make certain that it is correct by letting the program draw a graph.



This operation will cause the programmed graph to be displayed immediately on the picture.

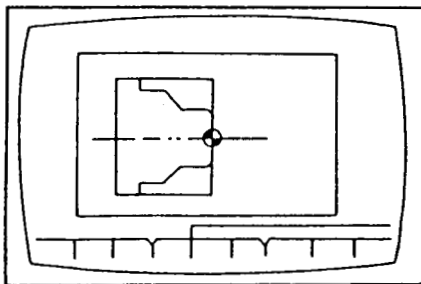

A shape to the stage programmed is displayed correctly.



Continue programming.

PROGRAM	
"SHAPE PATTERN (MENU)?"▶ LINEAR
"STARTING CORNER?"▶ [↔]
"FINAL POINT-X?"▶ [8] [0] [↔]
"FINAL POINT-Z?"▶ [6] [0] [↔]
"FINAL CORNER?"▶ [↔]
"FIN SURFACE ROUGHNESS (MENU)?"▶ [4] or [4] [↔]
"NECKING OR FR/M (MENU)?"▶ [↔]
"M CODE (MENU)?"▶ [↔]

That is all to entering for outside diameter cutting (BAR-OUT).

To end the program, stop with the END line.

"MODE (MENU)?"▶	SHAPE	END
"PARTS COUNT YES (1), NO (0)?"▶	[↔]	
"RET POSITION(2), ZERO(1), NO(0)?"▶	[↔]	
"NEXT WORKPIECE NO.?"▶	[↔]	
"CONTINUE YES (1), NO (0)?"▶	[↔]	
"NO. OF REPEATS OF SAME PROGRAM?"▶	[↔]	
"Z-AXIS SHIFT AMOUT?"▶	[↔]	

The END line may be set to "0". For details, see the Application Version.

Check

Check the program.

This function permits a material shape, a program shape and a tool path to be drawn.

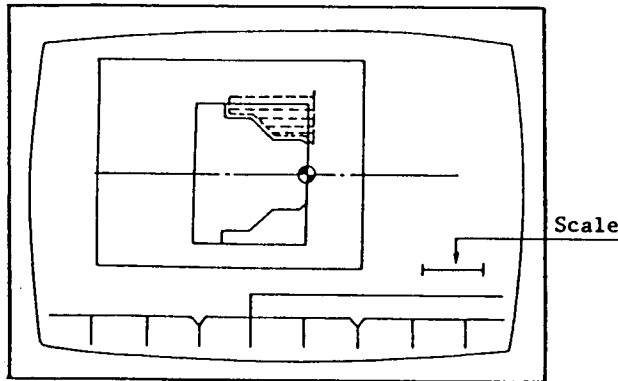
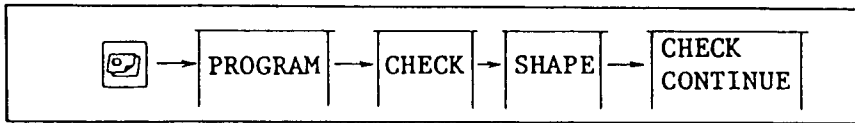

The size of a displayed graph can easily be changed as follows:

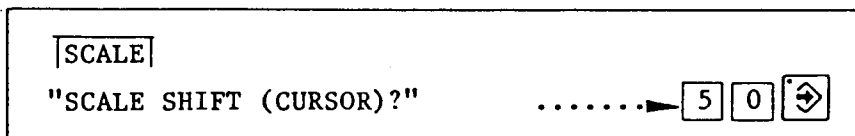

A graph sized to a scale length of 50 mm is displayed. Next, zoom a desired part of graph to display enlarged one.

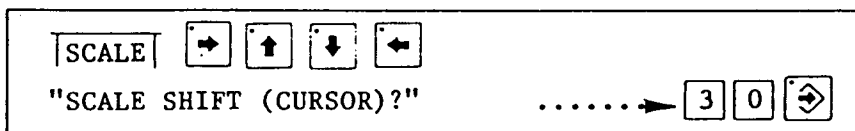

Press the SCALE menu key and the cursor will appear at the center of the picture. After moving the cursor by the cursor keys, draw the graph sized to a scale length of 30. It will be displayed with the cursor position at the center of the picture.

Thus, a program shape can be partially expanded. If the scale length is changed, drawn graph shape is deleted. Practice again, therefore, operation for drawing a graph.



The program is displayed on the screen as follows:

PNO	MAT	OD-MAX	ID-MIN	LENGTH	RPM	FIN-X	FIN-Z	WORK	FACE		
0	CBST	100	0	80	2000	0.2	0.1	0			
PNO	MODE	PART	CPT-X	CPT-Z	RV	FV	RF	RD	G	RT	FT
1	BAR	OUT	100	0	130	200	0.4	5	0	1-1	2-1
SEQ	FIG	S-CNR	SPT-X	SPT-Z	FPT-X	FPT-Z	F-CNR	RADIUS	SRF	\$	M
1	LIN	C2			50	25	CO		4		
2	TPR	CO	50	25	80	40	CO		5		
3	LIN	CO			100	60	CO		4		
PNO	MODE	COUNTER	FIX	POS	RET	WNO	CONTINUE	NUMBER	Z	SHIFT	
3	END	0		0		0	0	0		0	

PNO 0 is displayed at the left end, representing process No. 0, the first process of this program.

PNO 1 and **PNO** 2 represent process No. 1 and process No. 2, respectively.

The figures, 1, 2 and 3, shown under SEQ represent sequence Nos. 1, 2 and 3, respectively, indicating the order of shapes to be machined.

3-3 Inside Diameter Cutting (BAR-IN)

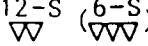
12-S (6-S)

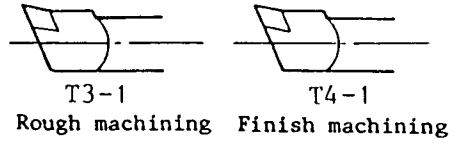
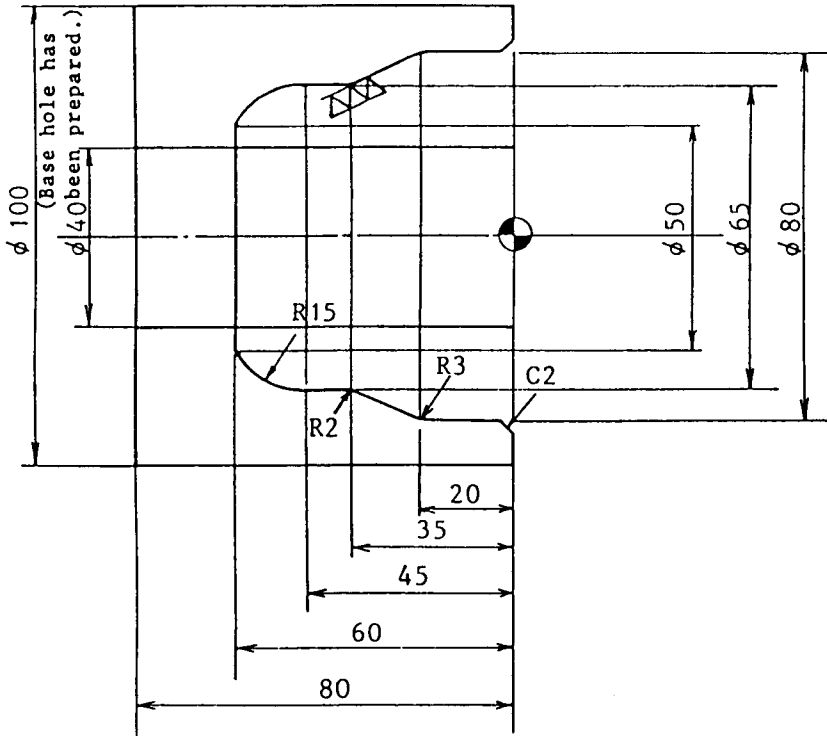

Material: Carbon steel

Max. O.D.: 100

Max. I.D.: 40

Material Length: 80

Prepare the program using the same procedure as for programming the bar outside diameter cutting.

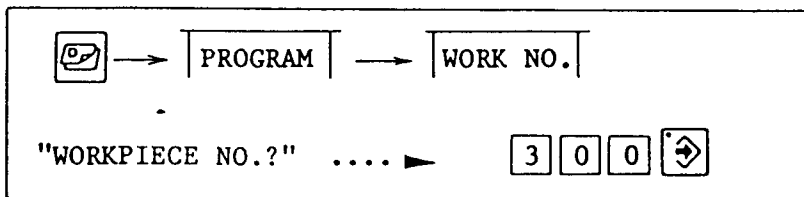



A work program number has been selected using the same procedure as for programming the outside diameter cutting. Subsequently, follow messages and proceed with inputting.

"NEW PROGRAM (PROGRAM)?"▶	PROGRAM
"MAZATROL OR EIA/ISO (MENU)?"▶	MAZATROL PROGRAM
"WORKPIECE MATERIAL (MENU)?"▶	CBN STL
"WORKPIECE MAX OUTER DIA.?"▶	1 0 0 ↻
"WORKPIECE MIN INNER DIA.?"▶	4 0 ↻
"WORKPIECE LENGTH?"▶	8 0 ↻
"MAX. SPINDLE RPM LIMIT?"▶	2 0 0 0 ↻
"FINISH ALLOWANCE-X?"▶	0 . 2 ↻
"FINISH ALLOWANCE-Z?"▶	0 . 1 ↻
"WORKPIECE FACE STOCK REMOVAL-X?"	...▶	0 ↻

Process No. 0 has now been entered.

"MODE (MENU)?"▶	BAR
"MACHINING PART (MENU)?"▶	IN

For inside diameter cutting, select the IN menu.

"CUTTING POINT-X?"▶	4 0 ↻
"CUTTING POINT-Z?"▶	0 ↻

In this case, the "CUTTING POINT" is located as illustrated below.

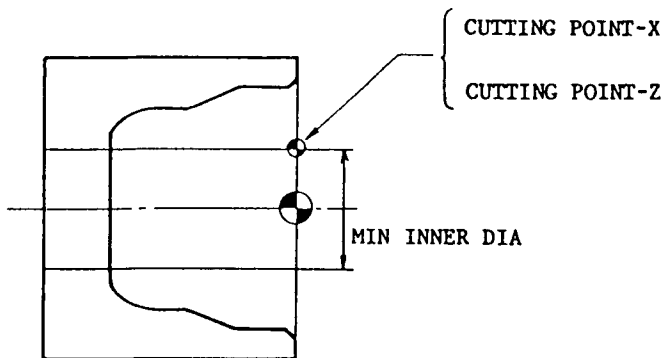

"ROUGHING SURFACE SPEED?"▶	AUTO
"FINISH SURFACE SPEED?"▶	▶
"ROUGH CUT FR/R?"▶	▶
"DEPTH OF CUT?"▶	▶
"GEAR NO.?"▶	▶
"ROUGHING TOOL NO.?"▶	3 ◀▶
"OFFSET NO.?"▶	1 ◀▶
"FINISHING TOOL NO.?"▶	4 ◀▶
"OFFSET NO.?"▶	1 ◀▶



Enter the sequence.

	SEQ 1	SEQ 2	SEQ 3	SEQ 4
"SHAPE PATTERN (MENU)?"	LINEAR	TAPAR	LINEAR	
"STARTING CORNER?"	2	CORNER R 3		
"STARTING POINT-X?"		CONTINUE		CONTINUE
"STARTING POINT-Z?"				
"FINAL POINT-X?"	8 0	6 5	6 5	5 0
"FINAL POINT-Z?"	2 0	3 5	4 5	6 0
"FINAL CORNER?"		CORNER R 2		
"RADIUS?"				1 5
"FIN SURFACE ROUGHNESS (MENU)?"	4	5	4	4
"NECKING OR FR/M (MENU)?"				
"M CODE (MENU)?"				

Four sequences, linear, taper, linear and concave arc have been entered.

No message appears and the cursor does not stop at the blank columns .

Finally, enter END.

"MODE (MENU)?"	▶	SHAPE END	END
"PARTS COUNT YES (1), NO (0)?"	▶		
"RET POSITION(2), ZERO(1), NO(0)?"	▶		
"NEXT WORKPIECE NO.?"	▶		
"CONTINUE YES (1), NO (0)?"	▶		
"NO. OF REPEATS OF SAME PROGRAM?"	▶		
"X-AXIS SHIFT AMOUT?"	▶		

That is all for programming the bar inside diameter cutting.

Follow the CHECK procedure referred to in the preceding page to verify both the program shape and tool path.

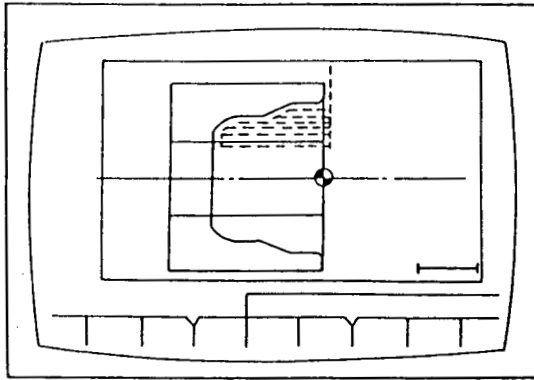

The action to correct a program has been entered is described below.

EDIT function

1) To change the program by word:

- a) [1][2][3].[4] → An error was shown before [↔] is pushed. → [↔] → end.
- b) [2][5].[3][↔] → An error was shown after [↔] was pushed. → [←] → Adjust [⊗] to that point. → [2][5].[4] → Enter correct values. → [↔] → end.

2) To change a menu:

[OUT] menu has been pressed incorrectly. → [←] →
 Display the menu to be inputted. → Press the correct menu [IN]. → end.



3) To erase data on a line basis:

Move [⊗] to the line to be erased. → [⊗] [ERASE] [↔] →
 That line will disappear. → end.





4) To add a new line:

Move  to where the line is to be added. →

 | LINE INSERT |  → One line will appear just above .
→ end.

5) To erase data on a unit basis:

Move  to PNO desired to be erased. →  | ERASE |  →
The PNO will disappear. → end.

Note 1) Where a program is erased completely is described in the Operating Manual.

Note 2) After changing the program, use the CHECK function and an alarm message "LAYOUT NOT COMPLETE" may appear.

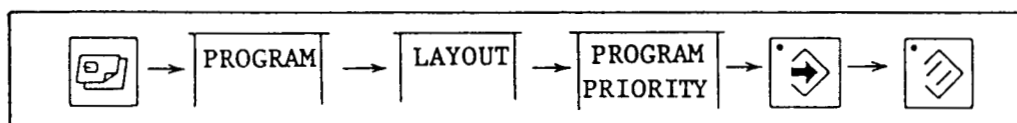

Then, perform the above-mentioned operation. The layout function is detailed in the Operating Manual.

3-4 Edge Cutting (EDG)

Material: Cast iron $\phi 150 \times \phi 40 \times 55$ long

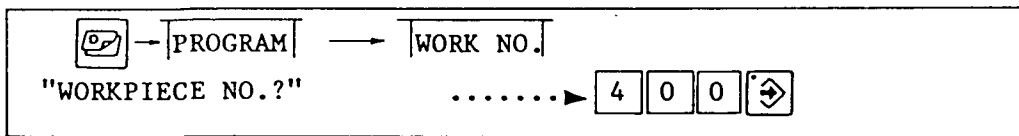
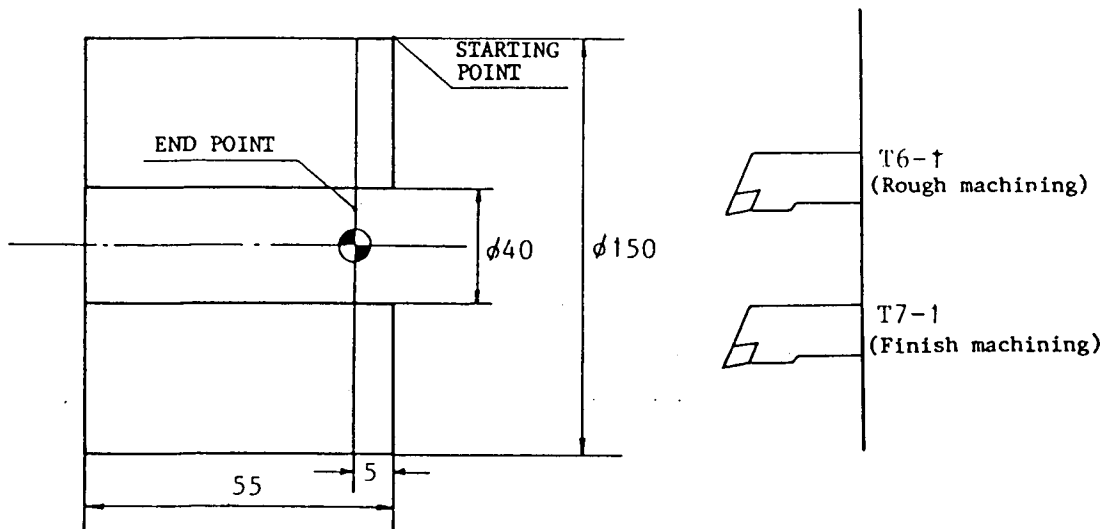

First, determine the work program number and enter it.
If a recorded work program has been selected,

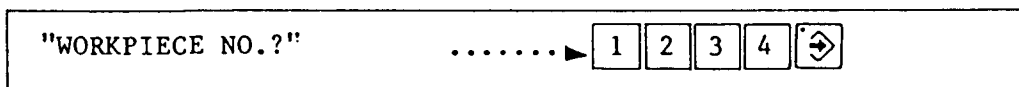

that program will be called and displayed.

Use No. 400 to prepare a new program.

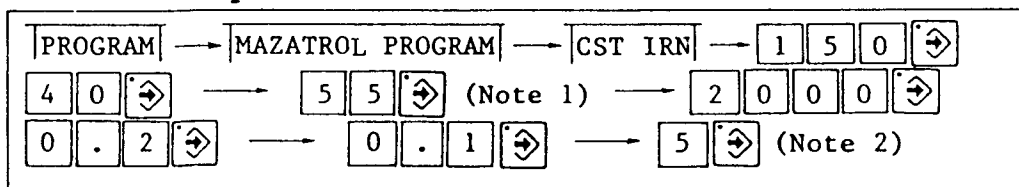

Process No. 0 is entered in the program. The contents are the same as those of the BAR-OUT or BAR-IN program.



Note 1) For WORKPIECE LENGTH, enter the length including the edge cutting allowance.

Note 2) Enter the estimated size of the edge cutting allowance.

See the drawing.

Edge cutting (EDG) cuts the portion to the right of Z0 straight. It is not possible to machine the left side of Z0.

"MODE (MENU)?"	EDG
"ROUGHING SURFACE SPEED?"▶	AUTO
"FINISH SURFACE SPEED?"▶	→
"ROUGH CUT FR/R?"▶	→
"DEPTH OF CUT?"▶	→
"GEAR NO.?"▶	→
"ROUGHING TOOL NR.?"▶	6 ↕
"OFFSET NO.?"▶	1 ↕
"FINISHING TOOL NO?"▶	7 ↕
"OFFSET NO.?"▶	1 ↕

Enter data using the same procedure as for bar inside or outside diameter cutting.

"STARTING POINT-X?"▶	1	5	0	↕
"STARTING POINT-Z?"▶	5	↕		
"FINAL POINT-X?"▶	3	6	↕	
"FINAL POINT-Z?"▶	0	↕		
"FIN SURFACE ROUGHNESS (MENU)?"▶	4	or	4	↕
"NECKING OR FR/M (MENU)?"▶	↕			
"M CODE (MENU)?"▶	↕			

For STARTING POINT-X, enter the same value as for workpiece maximum outer diameter (OD-MAX). For STARTING POINT-Z, enter the same value as for workpiece end face (WORK FACE). (See Note.) For FINAL POINT-X, enter a little smaller value than the workpiece minimum inside diameter (ID-MIN). To carry out edge-machining up to center "X0", enter "X0". For FINAL POINT-Z, enter "0".

Note: A numerical value larger than that of OD-MAX or WORK FACE will result in an error.

The EDG cutting is accomplished in one sequence (line) only.

Finally, enter END.

|END|

Input END mode as described above.

Use the FIGURE CHECK and CHECK functions to check the program.

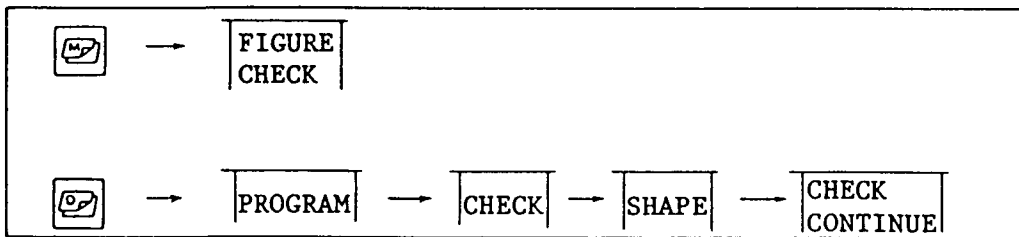

If an error is found in the program or a numerical value is to be replaced, use the EDIT function.



3-5 Grooving (GRV-OUT)

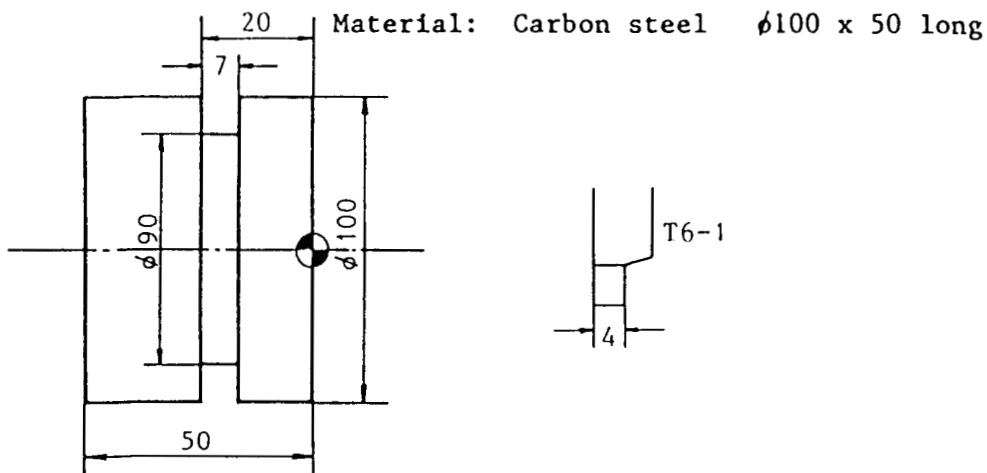

Note: Tool width (4 mm) should be entered separately. (See the Application Version.) A tool width larger than the groove width 7 mm will result in an error.

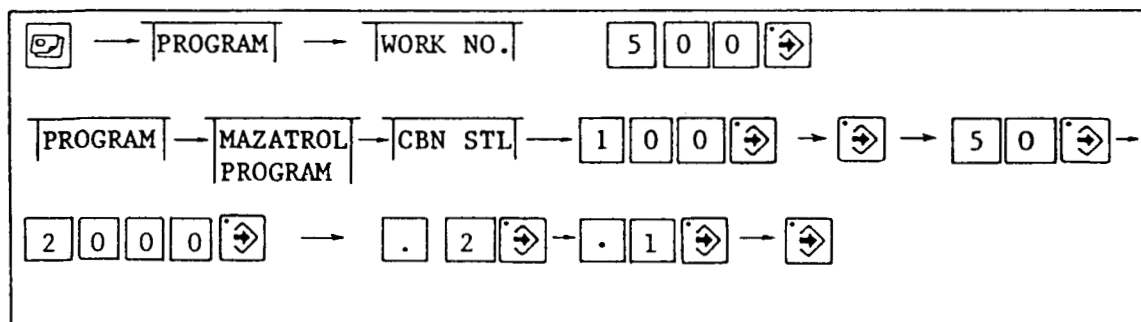

Under work program No. 500, process No. 0 has been entered.

"MODE (MENU)?"▶	GRV
"MACHINING PART (MENU)?"▶	OUT
"GRV: TRAPEZOID(1), STRAIGHT(0)?"▶	#0

The grooving (GRV) includes inside diameter grooving (IN) and face grooving (FCE) in addition to outside diameter grooving (OUT).

The grooving is available in two other types; #0 and #1. For details, see the Application Version.

"NUMBER OF GROOVES?" ▶	1	↔
"GROOVE PITCH?" ▶	↔	
"GROOVE WIDTH?" ▶	7	↔
"FINISH ALLOWANCE?" ▶	↔	
"SURFACE SPEED?" ▶	AUTO	
"ROUGH CUT FR/R?" ▶	↔	
"DEPTH OF CUT?" ▶	↔	
"GEAR NO.?" ▶	↔	
"FINISHING TOOL NR.?" ▶	6	↔
"OFFSET NO.?" ▶	1	↔

NUMBER OF GROOVES and GROOVE PITCH are to be used when a number of identical grooves are to be machined.

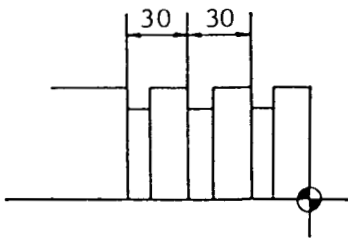

In the illustration given to the left, enter:

"NUMBER OF GROOVES?" ▶	3	↔	
"GROOVE PITCH?" ▶	3	0	↔

For GROOVE WIDTH, enter the groove width of a workpiece.

FINISH ALLOWANCE is valid with groove type #1.

The term "DEPTH OF CUT" means the pecking interval.

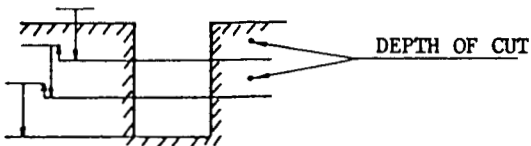

"STARTING CORNER?" ▶	↔			
"STARTING POINT-X?" ▶	1	0	0	↔
"STARTING POINT-Z?" ▶	2	0	↔	
"FINAL POINT-X?" ▶	9	0	↔	
"FINAL POINT-Z?" ▶	2	0	↔	
"FINAL CORNER?" ▶	↔			
"FIN SURFACE ROUGHNESS (MENU)?" ▶	↔			
"NECKING OR FR/M (MENU)?" ▶	↔			
"M CODE (MENU)?" ▶	↔			



Enter numerical values from "STARTING POINT-X" to "FINAL POINT-Z". The grooving GRV is also accomplished in one sequence (line) only.

Finally enter END.

END

Make preparations to use the CHECK function. Performing checking without tooling information will result in an error: to machine a 7-mm groove, the machine will not operate without being given tool width.

To cope with this, tooling information such as tool width should be entered elsewhere than in the program.

First, select the TOOL FILE picture.



Lower to FN06.

Enter the information in TOOL FILE No. 6.

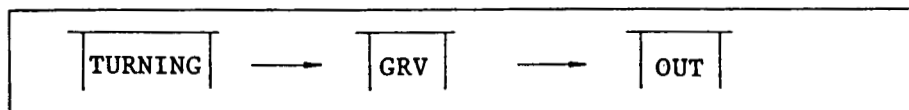

Outside Diameter Grooving in turning has been entered.

"TOOL HOLDER TYPE?" ▶	1	↔
"TOOL NOMINAL DIAMETER?" ▶	↔	
"CUTTING ANGLE (DEPTH)?" ▶	1	0 ↔
"CUTTING ANGLE (WIDTH)?" ▶	4	↔
"TOOL SHANK WIDTH/DIA?" ▶	2	5 ↔
"PITCH?" ▶	↔	
"TOOL LENGTH?" ▶	↔	
"NUMBER OF TEETH?" ▶	↔	

TOOL FILE No. 6 is now completely entered.

Subsequently, enter tool data.



Switch to the TOOL DATA picture, lower  to TN06.

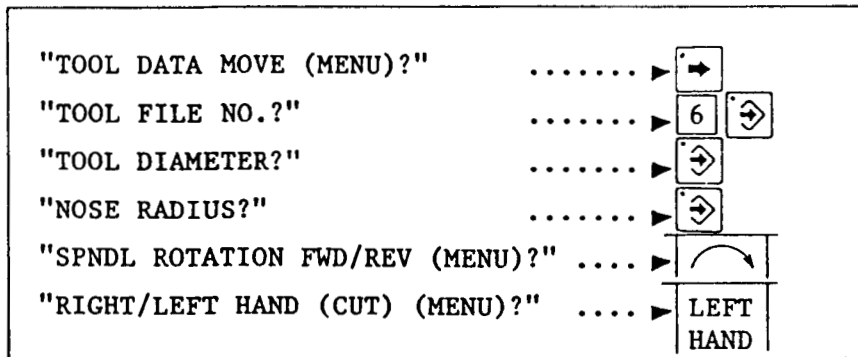

TOOL DATA No. 6 is now completely entered.

Note 1. A description of details involved is omitted. To use CHECK function, enter as illustrated. Tool file and tool data are detailed in the Operating Manual.

Note 2. Grooving includes I.D. and face grooving in addition to O.D grooving. Besides, it is available in another two types; #0 and #1.

They are also detailed in the Application Version.

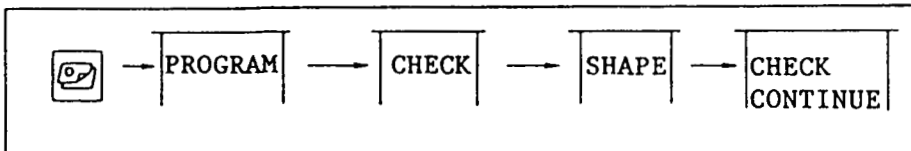

The menus SHAPE and CHECK CONTINUE will, respectively, cause a machining shape and a tool path to be drawn.



3-6 Threading (THR-OUT)

Material: Carbon steel $\phi 100$ x 100 long

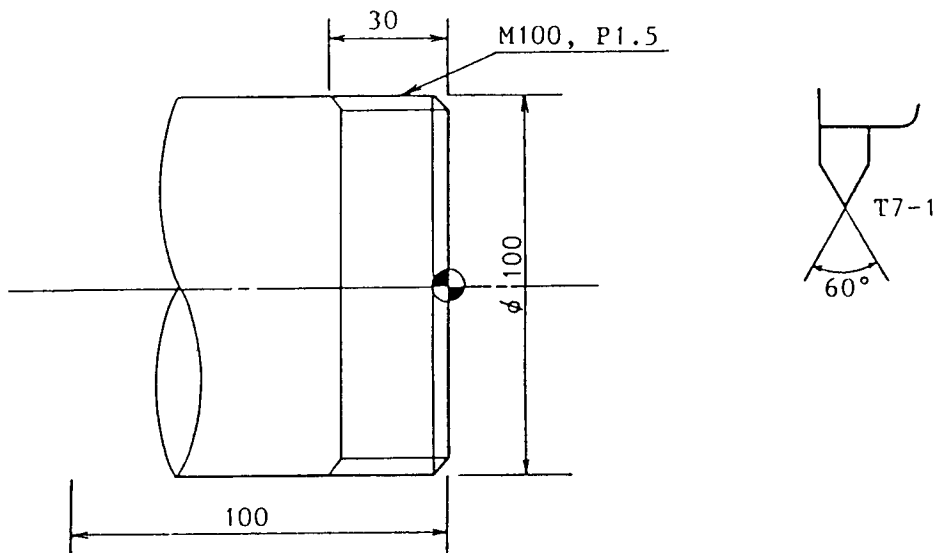

	PROGRAM	WORK NO.	6	0	0	
PROGRAM	MAZATROL PROGRAM	CBN STL	1	0	0	
			1	0	0	
			2	0	0	
			.	2		
			.	1		

Under work program No. 600, prepare a program.

"MODE (MENU)?"▶	THR
"MACHINING PART (MENU)?"▶	OUT
"CHAMFERING 60°(2), 45°(1), NO(0)?"▶	1
"THREAD LEAD?"▶	1 . 5
"ANGLE OF THREAD?"▶	0
"NUMBER OF ENTRANCE?"▶	1

The term "chamfering" means the angle at which chamfering performed after threading.

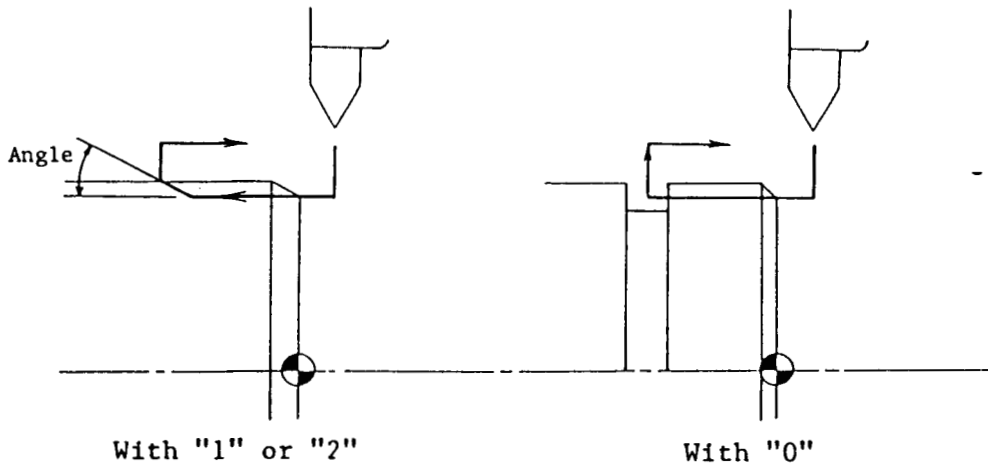

Generally, "0" should be selected if there is a "threading relief groove" and "1" or "2" if not.

THREAD LEAD and NUMBER OF ENTRANCE will be described. Thread is expressed as $\text{LEAD} = \text{PITCH} \times \text{NUMBER OF STARTS}$. Generally, $\text{LEAD} = \text{PITCH}$ may be reckoned for a "single start thread". It should be remembered that LEAD be entered for such a "multiple-start thread" as two-start or three-start threads.

(Example) 2-start thread

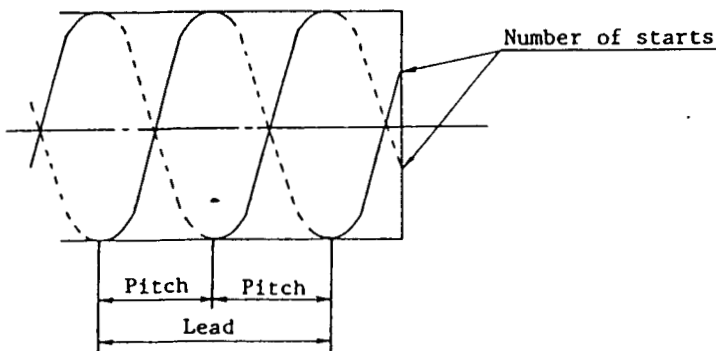



For ANGLE OF THREAD enter "0".

For dateila, see the Application Version.

"THREAD HEIGHT (AUTO → MENU)?"▶	AUTO
"NO. OF CUT PASSES?"▶	→
"SURFACE SPEED?"▶	→
"DEPTH OF FIRST CUT?"▶	→
"GEAR NO.?"▶	→
"TOOL NO.?"▶	7 ↕
"OFFSET NO.?"▶	1 ↕

THREAD HEIGHT represents "A" in the illustration below.

DEPTH OF FIRST CUT represents "B".

Note: The thread finish allowance has been entered independently of the program.

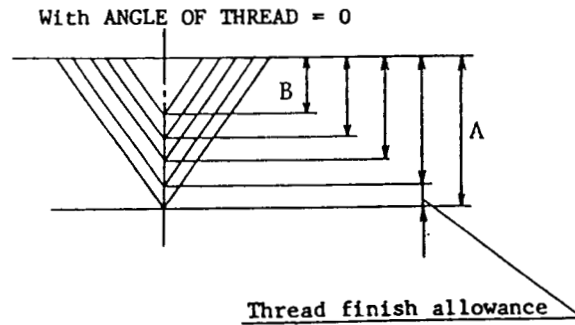

"STARTING POINT-X?"▶	1	0	0	↔
"STARTING POINT-Z?"▶	0	↔		
"FINAL POINT-X?"▶	1	0	0	↔
"FINAL POINT-Z?"▶	3	0	↔	

Enter STARTING POINT and FINAL POINT of threading.

Once one line has been entered, a message will ask "FINAL POINT-X?".

This function permits continuous machining of threads. One line handles machining of an ordinary thread. Press the SHAPE END menu key.

SHAPE END

Finally enter END and the operation will end.

END

Note: Threading (THR) includes I.D. and FACE in addition to O.D. Tapered and left-hand screws can also be made. For details, see the Application Version.

(Exercises)

The description given so far relates to cutting a bar material to an outside diameter (BAR-OUT), to an inside diameter (BAR-IN), edging (EDG), grooving to an outside diameter (GRV-OUT) and threading to an outside diameter (THR-OUT). In addition, a variety of machining modes are available, which are described in the Application Version.

Practice programming using the machining modes described so far.



Exercise 1

Material: Carbon steel $\phi 120 \times \phi 40 \times 105$ long

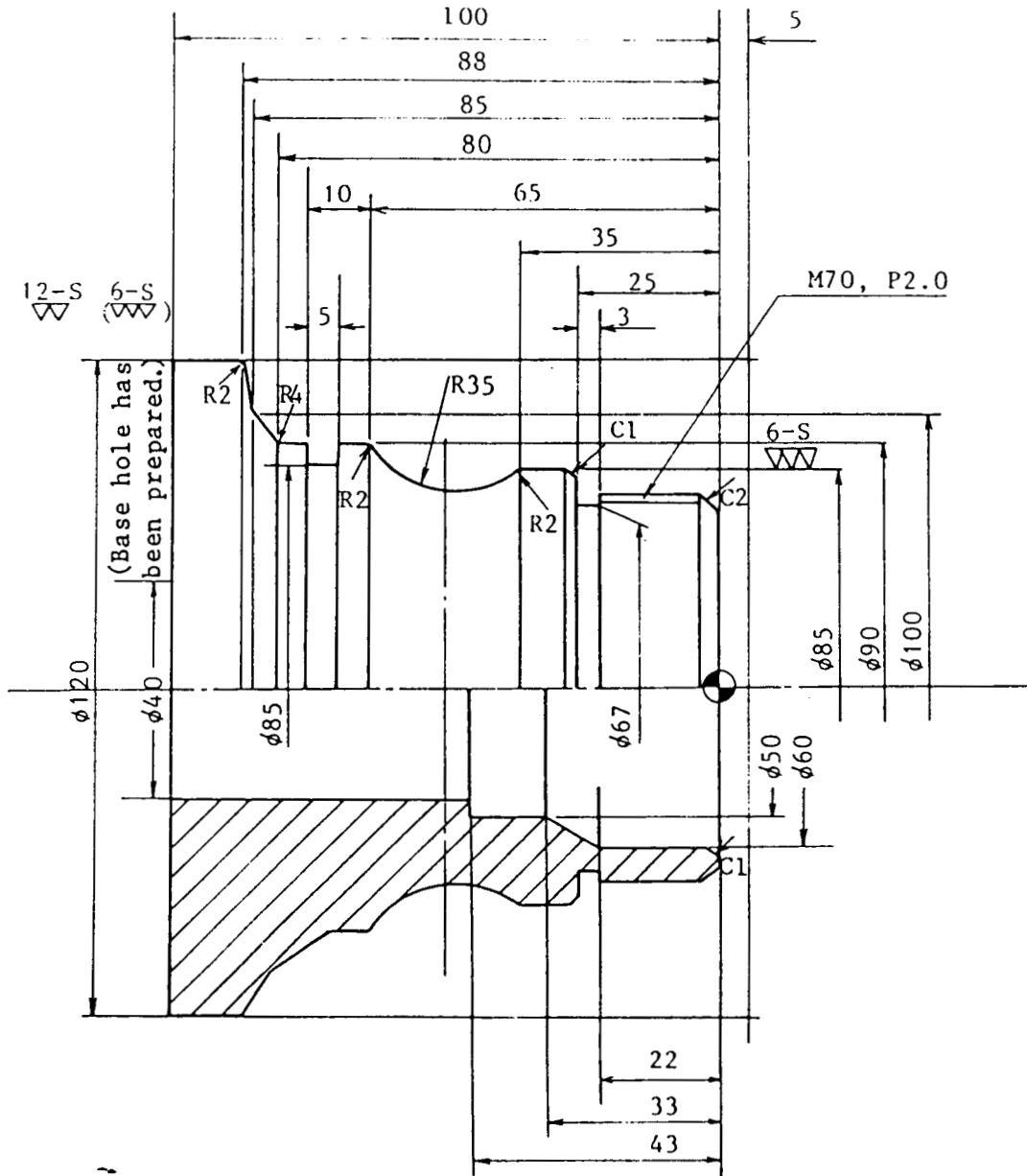

Answer of Exercise 1

PNO	MAT	OD-MAX	ID-MIN	LENGTH	RPM	FIN-X	FIN-Z	WORK	FACE
0	CB ST	120	40	105	1000	0.2	0.1	5	

PNO	MODE	RV	FV	RF	RD	G	RT	FT
1	EDG	100	120	0.3	3	0	1-0	1-0

SEQ	SPT-X	SPT-Z	FPT-X	FPT-Z	SRF	\$	M
1	120	5	35	0	4		

PNO	MODE	PART	CPT-X	CPT-Z	RV	FV	RF	RD	G	RT	FT
2	BAR	OUT	120	0	130	150	0.5	5	0	1-0	1-0

SEQ	FIG	S-CNR	SPT-X	SPT-Z	FPT-X	FPT-Z	F-CNR	RADIUS	SRF	\$	M
1	LIN	C2			70	25	C0		4		

2	LIN	C1			85	35	C0		6		
---	-----	----	--	--	----	----	----	--	---	--	--

3		R2	85	35	90	65	R2	35	4		
---	---	----	----	----	----	----	----	----	---	--	--

4	LIN	C0			90	80	C0		4		
---	-----	----	--	--	----	----	----	--	---	--	--

5	TPR	C0	90	80	100	85	R4		4		
---	-----	----	----	----	-----	----	----	--	---	--	--

6	TPR	C0	100	85	120	88	R2		4		
---	-----	----	-----	----	-----	----	----	--	---	--	--

PNO	MODE	PART #	NUMBER	PITCH	GRV	WID	FINISH	V	RF	RD	G	RT	FT
3	GRV	OUT	0	1	0	3	0	120	0.3	3	0	2-0	

SEQ	S-CNR	SPT-X	SPT-Z	FPT-X	FPT-Z	F-CNR	RADIUS	SRF	\$	M
1	C0	70	25	67	25	C0		4		

PNO	MODE	PART #	NUMBER	PITCH	GRV	WID	FINISH	V	RF	RD	G	RT	FT
4	GRV	OUT	0	1	0	5	0	120	0.3	3	0	2-0	

SEQ	S-CNR	SPT-X	SPT-Z	FPT-X	FPT-Z	F-CNR	RADIUS	SRF	\$	M
1	C0	90	75	85	75	C0		4		

PNO	MODE	PART	CHAMFER	LEAD	ANGLE	MULTI	HGT	NUMBER	V	RD	G	T
5	THR	OUT	0	2	0	1	1.299	10	100	0.3	0	3-0

SEQ	SPT-X	SPT-Z	FPT-X	FPT-Z
1	70	0	70	23

PNO	MODE	PART	CPT-X	CPT-Z	RV	FV	RF	RD	G	RT	FT
6	BAR	IN	40	0	120	150	0.5	3	0	4-0	4-0

SEQ	FIG	S-CNR	SPT-X	SPT-Z	FPT-X	FPT-Z	F-CNR	RADIUS	SRF	\$	M
1	LIN	C1			60	22	C0		4		

2	TPR	C0	60	22	50	33	C0		4		
---	-----	----	----	----	----	----	----	--	---	--	--

3	LIN	C0			50	43	C0		4		
---	-----	----	--	--	----	----	----	--	---	--	--

PNO	MODE	COUNTER	FIX	POS	RET	WNO	CONTINUE	NUMBER	Z	SHIFT
7	END	0	0	0	0	0	0	0	0	



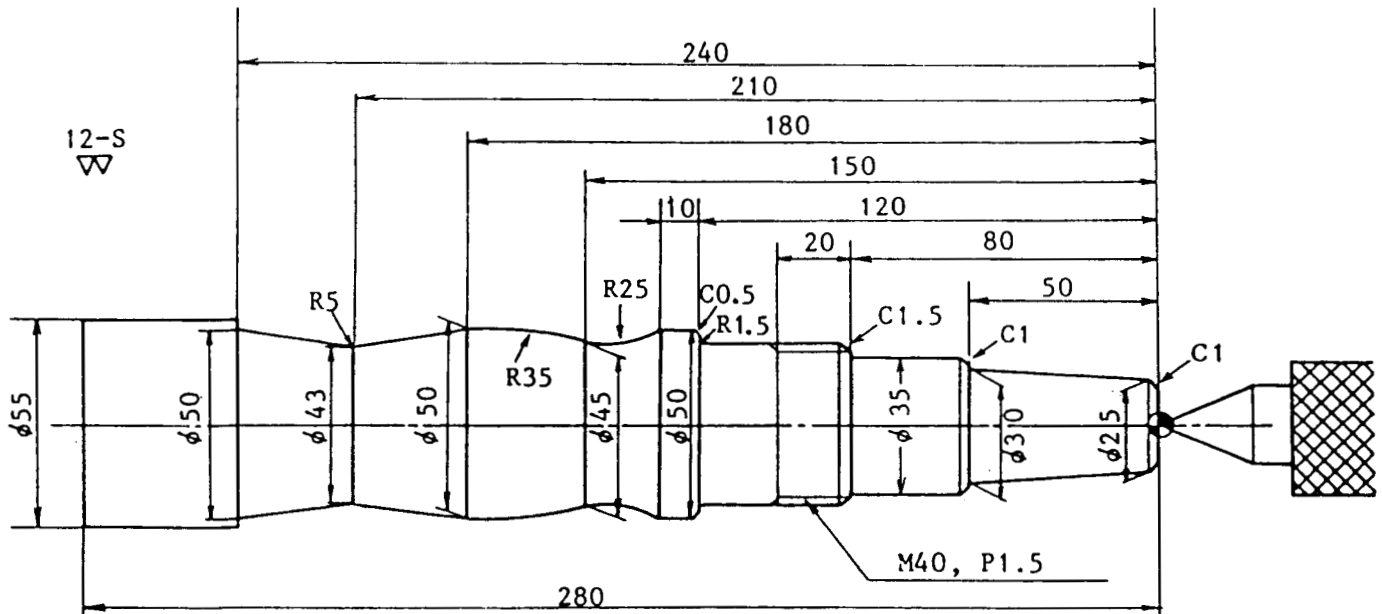

Exercise 2

Material: Carbon steel $\phi 55 \times 280$ long



Answer of Exercise 2

PNO	MAT	OD-MAX	ID-MIN	LENGTH	RPM	FIN-X	FIN-Z	WORK FACE				
0	CB ST	55	0	280	2000	0.2	0.1	0				
PNO	MODE	PART	CPT-X	CPT-Z	RV	FV	RF	RD	G	RT	FT	
1	BAR	OUT	55	0	130	150	0.35	3.5	0	1-0	1-0	
SEQ	FIG	S-CNR	SPT-X	SPT-Z	FPT-X	FPT-Z	F-CNR	RADIUS	SRF	#	M	
1	TPR	C1	25	0	30	50	C0			4		
2	LIN	C1			35	80	C0			4		
3	LIN	C1.5			40	120	R1.5			4		
4	LIN	C0.5			50	130	C0			4		
5		C0	50	130	45	150	C0	25		4		
6		C0	45	150	50	180	C0	35		4		
7	TPR	C0	50	180	43	210	R5			4		
8	TPR	C0	43	210	50	240	C0			4		
PNO	MODE	PART	CHAMFER	LEAD	ANGLE	MULTI	HGT	NUMBER	V	RD	G	T
2	THR	OUT	1	1.5	0	1	0.974	8	100	0.27	0	3-0
SEQ		SPT-X	SPT-Z	FPT-X	FPT-Z							
1		40	80	40	100							
PNO	MODE	COUNTER	FIX	POS	RET	WNO	CONTINUE	NUMBER	Z	SHIFT		
3	END	0	0	0	0	0	0	0	0	0		



4. TO PREPARE A MILLING PROGRAM

In machining with a lathe, a workpiece mounted on the spindle is turned while moving a cutting tool.

In the milling center, an end mill, drill, tap, etc. are mounted in stead of a cutting tool to machine a workpiece on the turning spindle.

In this case, two types of machining are available:

- (1) Machining with the spindle fixed and
- (2) Machining with the spindle turning slowly.

Examples are now given to describe the part of a machining program to turn a tool, with spindle fixed as referred to in (1) above.

Note: For the function referred to in (2) above, see the Application Version.

4-1 Drilling (MDR)

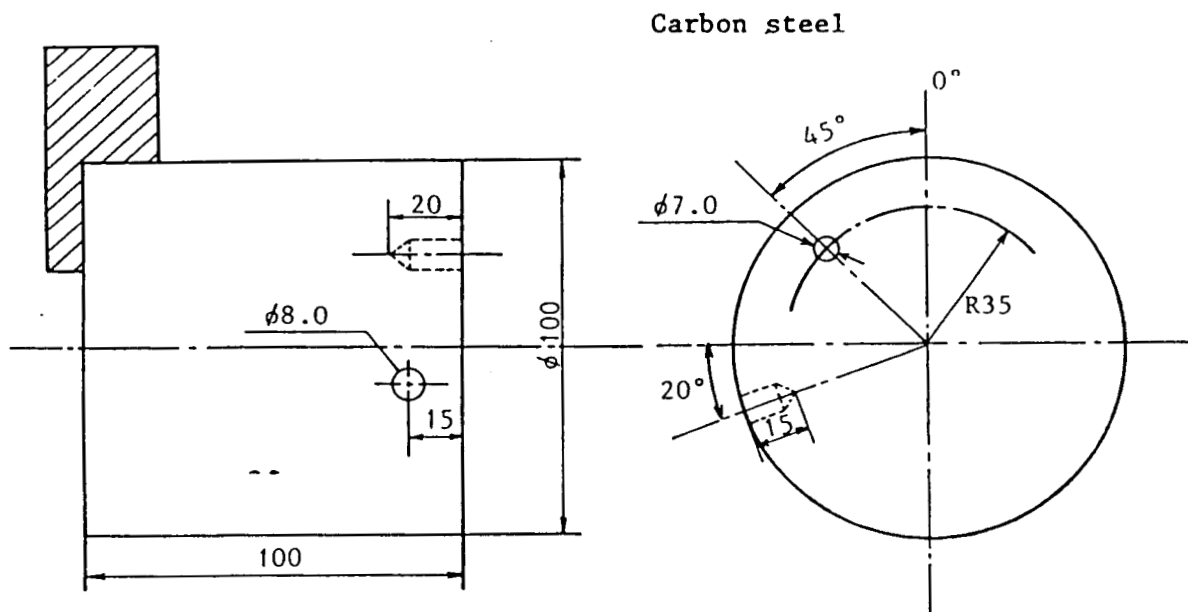

- o 7.0 drill → T10-1
- o 8.0 drill → T11-1

The above-mentioned two tools are used. It is assumed that turning has been completed.

To start.

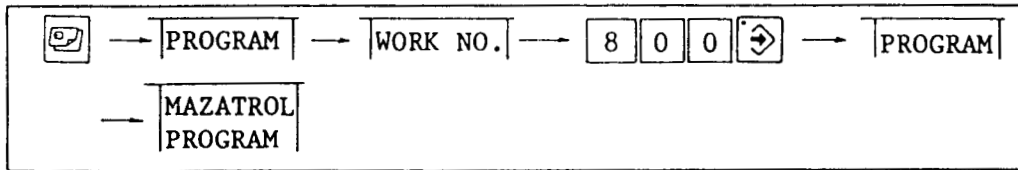

Enter the first line (common codes) as with turning.

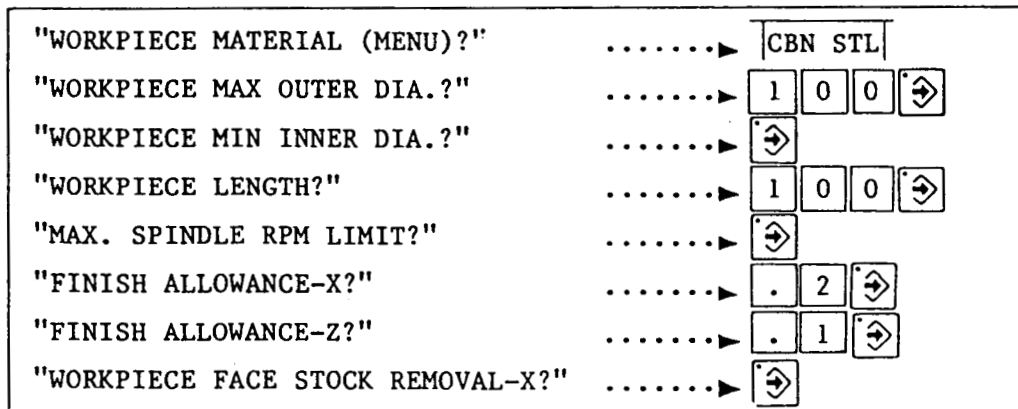

FINISH ALLOWANCE-X and FINISH ALLOWANCE-Z in turning are ignored in milling.

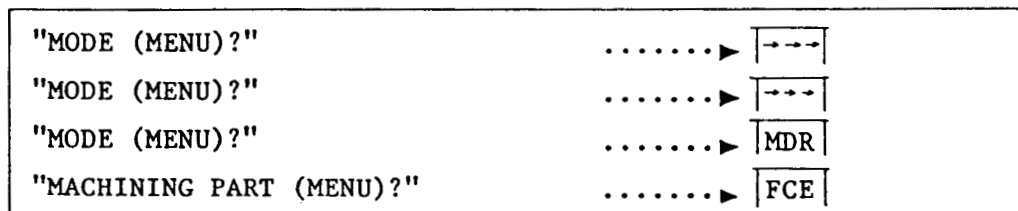

Three MODE MENU pages are available. Press the [←→→] and to see MDR (milling drill) to the left end on Page 3.

First, begin with programming for machining with the $\phi 7$ drill on the end face.



"DRILLING TYPE (MENU)?"▶	PECKING 2
"HOLE DIAMETER?"▶	7 ↻
"CUTTING DEPTH?"▶	2 0 ↻
"DEPTH OF FIRST CUT?"▶	AUTO
"DEPTH OF CUT DIFFERENCE?"▶	↻
"MINIMUM DEPTH OF CUT?"▶	↻
"SURFACE SPEED?"▶	↻
"FR/R?"▶	↻
"MILLING GEAR NO.?"▶	↻
"TOOL NO.?"▶	1 0 ↻
"OFFSET NO.?"▶	1 ↻

For DRILLING TYPE, select "2".

All data from DEPTH OF FIRST CUT and on will be determined automatically. Details are described in the Application Version.

"SHAPE PATTERN (MENU)?"▶	POINT
"STARTING POINT-R/x?"▶	3 5 ↻
"STARTING POINT- θ /y?"▶	4 5 ↻
"STARTING POINT-Z?"▶	0 ↻
"M CODE (MENU)?"▶	↻
"SHAPE PATTERN (MENU)?"▶	SHAPE END

For STARTING POINT-R, enter 35 as the radius value.

For STARTING POINT- θ , enter 45 as an angle from 0°.

Instead of "R and θ ", "x and y" may be used to enter the data mentioned above. This is described in the Application Version.

FIGURE CHECK procedure

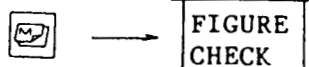

The following graphic shape is displayed.

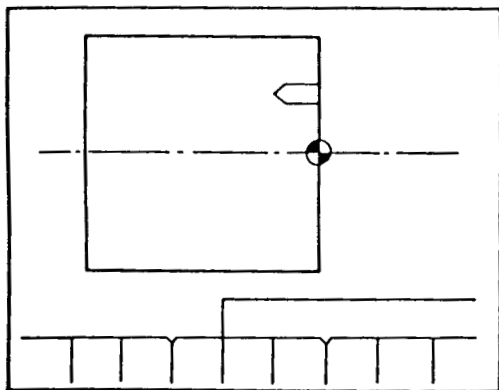

Press the DISPLAY MODE menu key and two sides, lateral and front, will be displayed.

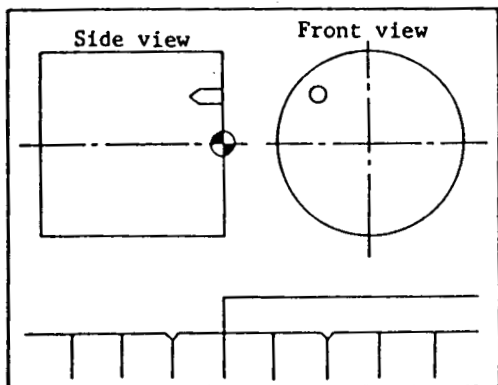



Next, program drilling on the side (outside diameter).

"MODE (MENU)?"▶	PROGRAM
"MODE (MENU)?"▶	----
"MODE (MENU)?"▶	----
"MODE (MENU)?"▶	MDR
"MACHINING PART (MENU)?"▶	OUT

Enter data for MACHINING PART as with to the front (lateral) already referred to and select the OUT menu.

"DRILLING TYPE (MENU)?"▶	PECKING
		2
"HOLE DIAMETER?"▶	8
"CUTTING DEPTH?"▶	1 5
"DEPTH OF FIRST CUT?"▶	AUTO
"DEPTH OF CUT DIFFERENCE?"▶	→
"MINIMUM DEPTH OF CUT?"▶	→
"SURFACE SPEED?"▶	→
"FR/R?"▶	→
"MILLING GEAR NO.?"▶	→
"TOOL NO.?"▶	1 1
"OFFSET NO.?"▶	1

Follow the same procedure as for machining the end face.

"SHAPE PATTERN (MENU)?"▶	POINT
"STARTING POINT-R/x?"▶	5 0
"STARTING POINT-θ/y?"▶	1 1 0
"STARTING POINT-Z?"▶	1 5
"M CODE (MENU)?"▶	→
"SHAPE PATTERN (MENU)?"▶	SHAPE
		END

To drill a hole on a workpiece with an outside diameter of 100, enter 50 for STARTING POINT-R. For STARTING POINT-θ which represents an angle from 0°, enter not 20° but $90 + 20 = 110$.

Now FIGURE CHECK all over again.

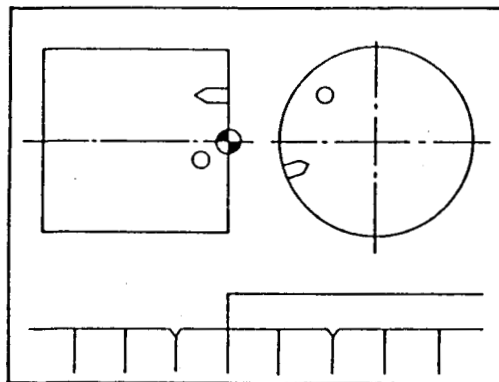

In the earlier FIGURE CHECK, two pictures were displayed and still remain. Therefore, the graph is drawn on a two-picture display basis. Pressing the menu key DISPLAY MODE will convert the display to one picture.

To end the program, close with END.

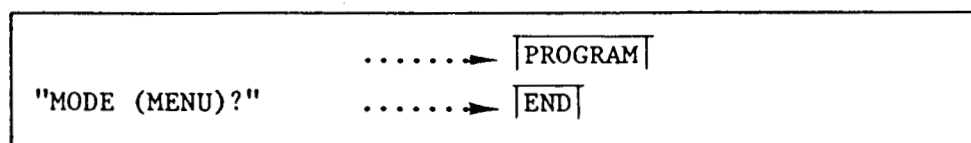

"0" has been entered on the END line.



All program inputs have now been entered. Confirm using the CHECK function.

For this purpose, it is necessary to order the tool information.

Enter data as follows as with grooving in turning:

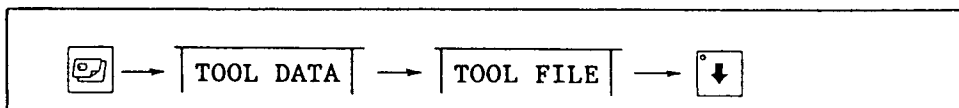

Lower $\frac{1}{16}$ to FN010.

Enter the information in TOOL FILE No. 10.

MILLING	→	MDR	→	EDG
"TOOL HOLDER TYPE?"→	3	[↔]	
"TOOL NOMINAL DIAMETER?"→	7	[↔]	
"CUTTING ANGLE (DEPTH)?"→	0	[↔]	
"CUTTING ANGLE (WIDTH)?"→	[↔]		
"TOOL SHANK WIDTH/DIA?"→	2	0	[↔]
"PITCH?"→	[↔]		
"TOOL LENGTH?"→	5	0	[↔]
"NUMBER OF TEETH?"→	[↔]		

Next, enter TOOL FILE No. 11.

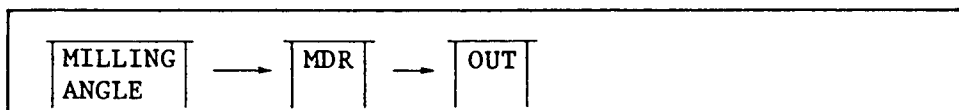

"TOOL HOLDER TYPE?"→	4	[↔]
"TOOL NOMINAL DIAMETER?"→	8	[↔]



* From CUTTING ANGLE (DEPTH) to CUTTING ANGLE (WIDTH), enter the same way as for TOOL FILE No. 10. Then, enter in the TOOL DATA picture.

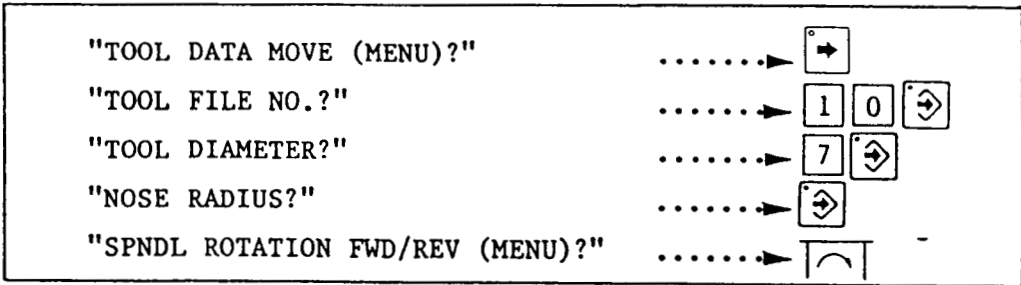

Lower  to TN010.



Inputting as mentioned above will permit checking the TN010 line.

Then, enter the TN011 line. Using  and , move  to TN011.

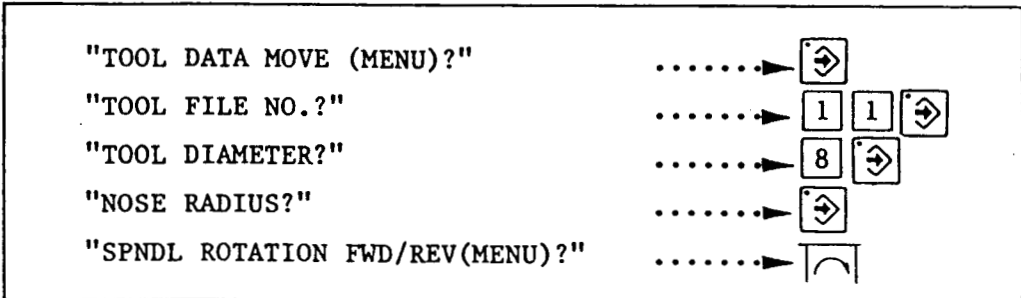

Entering is now completely finished.

Use the CHECK function to draw the tool path.

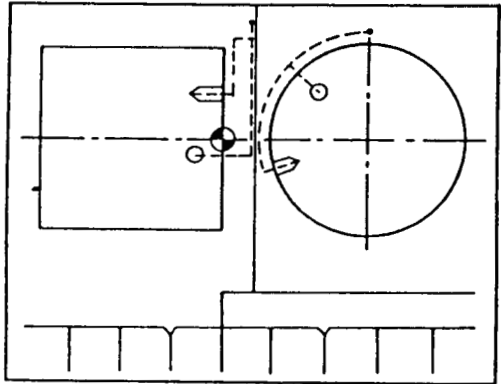
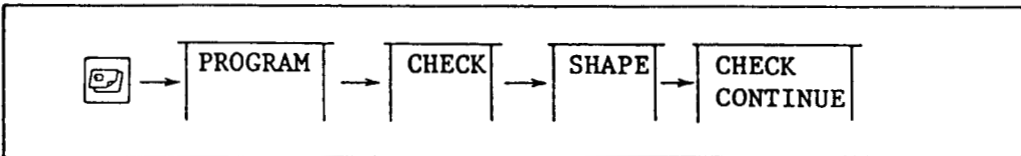

CHECK CONTINUE will permit to seeing the tool moving.



4-2 Machining a Key Way (MGV)

Material: Carbon steel

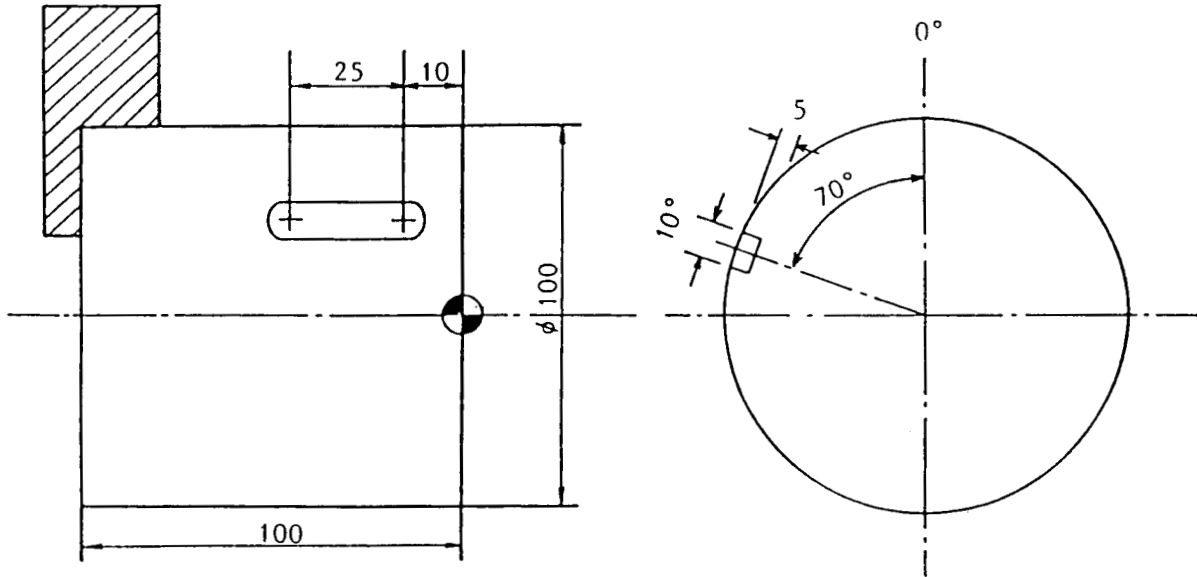

o $\phi 10$ end mill T12-1

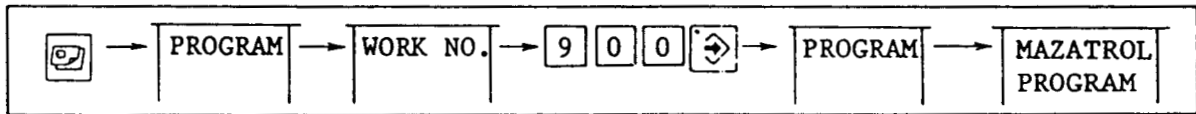

Prepare a program with work program No. 900. Enter data on the first line (common codes) of the program.

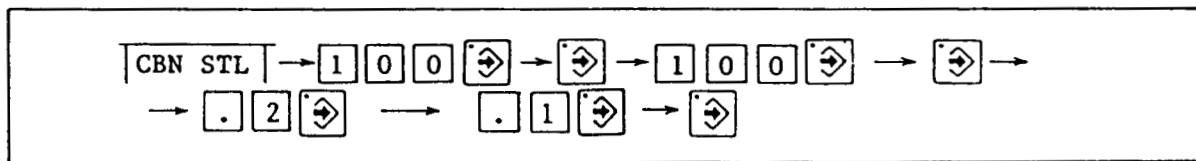

Then, enter key way machining (MGV) data.

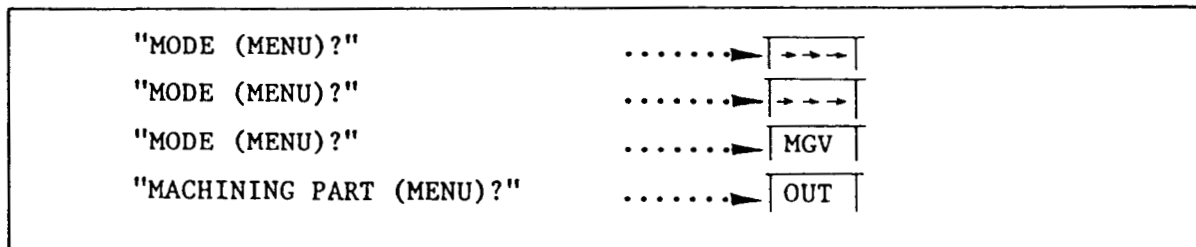

Select the MGV and OUT menus.

"GROOVE WIDTH?"▶	1	0	↔
"CUTTING DEPTH?"▶	5	↔	
"FIN SURFACE ROUGHNESS (MENU)?"▶	↔		
"FINISH ALLOWANCE (AXIS DR)?"▶	↔		
"ROUGH SURFACE SPEED?"▶	AUTO		
"FINISH SURFACE SPEED?"▶	↔		
"ROUGH FR/R (RADIAL DIRECTION)?"▶	↔		
"ROUGH CUT FR/R (AXIS DIA)?"▶	↔		
"MILLING GEAR NO.?"▶	↔		
"ROUGHING TOOL NO.?"▶	1	2	↔
"OFFSET NO.?"▶	1	↔	
"FINISHING TOOL NO.?"▶	↔		
"OFFSET NO.?"▶	↔		

This is a machining pattern in which only one roughing tool is used.

In this case, for FINISHING TOOL, press the INPUT key .

"STARTING POINT-R/x?"▶	5	0	↔
"STARTING POINT-θ/y▶	7	0	↔
"STARTING POINT-Z?"▶	1	0	↔
"FINAL POINT-Z?"▶	3	5	↔
"M CODE (MENU)?"▶	↔		

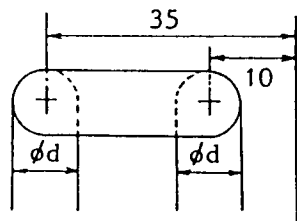

For Z, enter the tool center value.

FIGURE CHECK

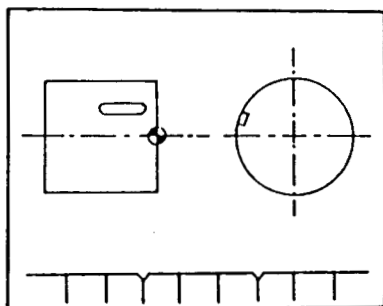

In milling, the two-picture display permits seeing a graphical shape more easily.

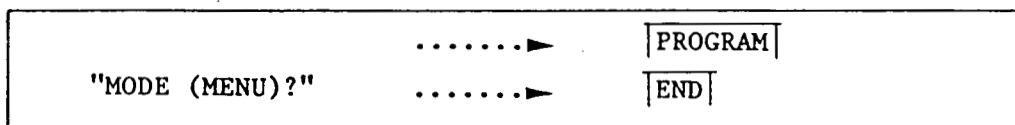

Using the CHECK function, order the tool information as described for milling drilling.

Select the TOOL FILE picture.

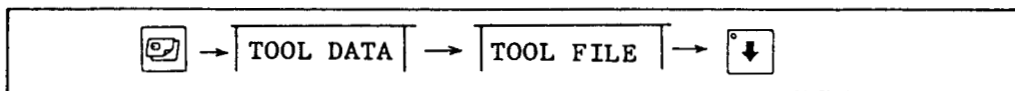

Move to FN012.

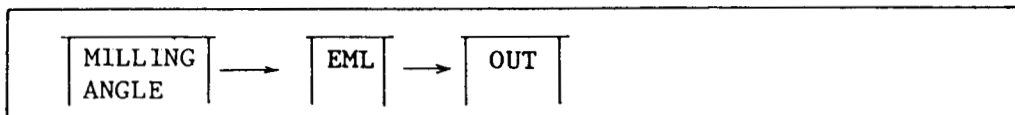

"TOOL HOLDER TYPE?"▶	4	↔
"TOOL NOMINAL DIAMETER?"▶	1	0 ↔
"CUTTING ANGLE (DEPTH)?"▶	5	↔
"CUTTING ANGLE (WIDTH)?"▶	↔	
"TOOL SHANK WIDTH/DIA?"▶	2	0 ↔
"PITCH?"▶	↔	
"TOOL LENGTH?"▶	5	0 ↔
"NUMBER OF TEETH?"▶	2	↔

Next, enter tool data.

TOOL DATA	→	↓
-----------	---	---

Move  to TN012.

"TOOL DATA MOVE (MENU)?"▶	→
"TOOL FILE NO.?"▶	1 2 ↔
"TOOL DIAMETER?"▶	1 0 ↔
"NOSE RADIUS?"▶	↔
"SPDL ROTATION FWD/REV (MENU)?"▶	↻

Use the CHECK function to verify the tool path.

	→	PROGRAM	→	CHECK	→	SHAPE	→	CHECK CONTINUE
---	---	---------	---	-------	---	-------	---	----------------

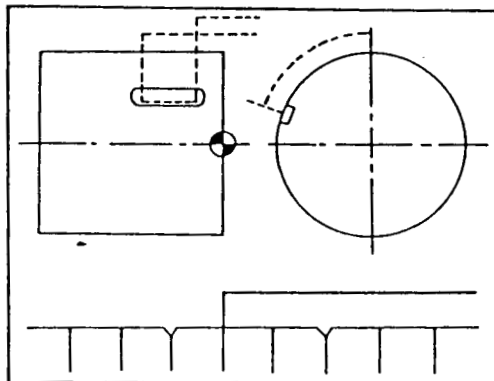



Using examples, a description has been given in relation to the technique of partially programming the milling mode. All machining modes are systematically described in the Application Version.

We hope that you will make effective use of the present Primer Version as your first step in learning about MAZATROL programs. It will enable you to operate your machinery more effectively.