



Installation and Operating instructions for
CP6606-0001-0020
„Economy“ Built-in Panel PC

Version: 1.1
Date: 2016-10-07

BECKHOFF

Table of contents

1	Foreword	3
1.1	Notes on the Documentation	3
1.1.1	Liability Conditions	3
1.1.2	Trademarks	3
1.1.3	Patent Pending	3
1.1.4	Copyright	3
1.1.5	State at Delivery	3
1.1.6	Delivery conditions	3
1.2	Description of safety symbols	4
1.3	Basic safety measures	5
1.4	Operator's obligation to exercise diligence	6
1.4.1	National regulations	6
1.4.2	Procedure in the event of a fault	6
1.4.3	Operator requirements	6
2	Product Description	7
2.1	Product overview	7
2.2	Appropriate Use	8
2.3	Access to the connectors	8
2.4	Interfaces	9
2.4.1	Power Supply (X101)	9
2.4.2	Network connection LAN1 (X 102)	9
2.4.3	EtherCAT connection (X 103)	9
2.4.4	USB output (X 104, X 105)	9
2.4.5	Serial interface COM1 (X107)	9
2.4.6	Ground connection (Ground)	9
2.5	Access to the battery and the plug-in card slot	10
2.6	Status-LEDs	10
3	Installation	11
3.1	Transport and Unpacking	11
3.1.1	Transport	11
3.1.2	Unpacking	11
3.2	Installation in the control cabinet	12
3.2.1	Preparation of the control cabinet	12
3.2.2	Installation in a control cabinet wall	12
3.2.3	Mounting of the Panel PC	13
3.3	Wall installation with wall mounting frame (optional)	14

3.3.1	Mounting the wall mounting frame	14
3.3.2	Cut out dimension	15
3.3.3	Plastering the frame	15
3.3.4	Mounting of the Panel PC	15
3.4	Fitting the power supply cable	16
3.5	Connecting the Panel PC	17
3.5.1	Connecting cables	17
3.5.2	Earthing measures	17
4	Operating Instructions	18
4.1	Switching the Panel PC on and off	18
4.1.1	Switching on	18
4.1.2	Shutting down and switching off	18
4.1.3	First switching on and driver installation	18
4.2	Operation	18
4.3	Servicing and maintenance	19
4.3.1	Cleaning	19
4.3.2	Maintenance	19
4.3.3	Replacing the battery on the motherboard	19
4.4	Emergency procedures	19
4.5	Shutting down	19
4.5.1	Disposal	19
5	Troubleshooting	20
6	Assembly dimensions	21
7	Technical Data	22
8	Appendix	23
8.1	Beckhoff Support and Service	23
8.1.1	Beckhoff branches and partner companies	23
8.1.2	Beckhoff company headquarters	23
8.2	Approvals for USA and Canada	24
8.3	FCC Approvals for the United States of America	24
8.4	FCC Approval for Canada	24

1 Foreword

1.1 Notes on the Documentation

This description is only intended for the use of trained specialists in control and automation engineering who are familiar with the applicable national standards. It is essential that the following notes and explanations are followed when installing and commissioning these components.

The responsible staff must ensure that the application or use of the products described satisfy all the requirements for safety, including all the relevant laws, regulations, guidelines and standards.

1.1.1 Liability Conditions

The documentation has been prepared with care. The products described are, however, constantly under development. For that reason the documentation is not in every case checked for consistency with performance data, standards or other characteristics. In the event that it contains technical or editorial errors, we retain the right to make alterations at any time and without warning. No claims for the modification of products that have already been supplied may be made on the basis of the data, diagrams and descriptions in this documentation.

All pictures shown in the documentation are exemplary. Illustrated configurations can differ from standard.

1.1.2 Trademarks

Beckhoff®, TwinCAT®, EtherCAT®, Safety over EtherCAT®, TwinSAFE® and XFC® are registered trademarks of and licensed by Beckhoff Automation GmbH.

Other designations used in this publication may be trademarks whose use by third parties for their own purposes could violate the rights of the owners.

1.1.3 Patent Pending

The EtherCAT Technology is covered, including but not limited to the following patent applications and patents: EP1590927, EP1789857, DE102004044764, DE102007017835 with corresponding applications or registrations in various other countries.

The TwinCAT Technology is covered, including but not limited to the following patent applications and patents: EP0851348, US6167425 with corresponding applications or registrations in various other countries.

1.1.4 Copyright

© Beckhoff Automation GmbH & Co. KG.

The reproduction, distribution and utilization of this document as well as the communication of its contents to others without express authorization are prohibited. Offenders will be held liable for the payment of damages. All rights reserved in the event of the grant of a patent, utility model or design.

1.1.5 State at Delivery





All the components are supplied in particular hardware and software configurations appropriate for the application. Modifications to hardware or software configurations other than those described in the documentation are not permitted, and nullify the liability of Beckhoff Automation GmbH & Co. KG.

1.1.6 Delivery conditions

In addition, the general delivery conditions of the company Beckhoff Automation GmbH & Co. KG apply.

1.2 Description of safety symbols

The following safety symbols are used in this operating manual. They are intended to alert the reader to the associated safety instructions.

 DANGER	Acute risk of injury! If you do not adhere the safety advise adjoining this symbol, there is immediate danger to life and health of individuals!
 WARNING	Risk of injury! If you do not adhere the safety advise adjoining this symbol, there is danger to life and health of individuals!
 CAUTION	Hazard to individuals! If you do not adhere the safety advise adjoining this symbol, there is obvious hazard to individuals!
 Attention	Hazard to devices and environment If you do not adhere the notice adjoining this symbol, there is obvious hazard to materials and environment.
 Note	Note or pointer This symbol indicates information that contributes to better understanding.

1.3 Basic safety measures

Before the Panel PC is switched off, software that is running must be properly closed. Otherwise it is possible that data on the storage medium is lost. Please read the section [Switching the Panel PC on and off](#).

 Warning	<p>Switch off all parts of the equipment, then uncouple the Panel PC</p> <p>Before opening the housing, and whenever the Panel PC is not being used for control purposes (such as during functional checks after a repair), all parts of the equipment must first be switched off, after which the Panel PC is to be disconnected from the equipment.</p>
---	--

Disconnect the device by unplugging the connectors on the rear side of the Panel PC. Items of equipment that have been switched off must be secured against being switched on again.

 Warning	<p>Do not exchange any parts when under power</p> <p>When components are being fitted or removed, the supply voltage must be switched off.</p> <p>Fitting work on the Panel PC can result in damage:</p> <ul style="list-style-type: none">• if metal objects such as screws or tools fall onto operating circuit boards• if connecting cables internal to the Panel PC are removed or inserted during operation.
---	---

1.4 Operator's obligation to exercise diligence

The operator must ensure that

- the product is only used as intended (see chapter [Product Description](#))
- the product is in a sound condition and in working order during operation
- the product is operated, maintained and repaired only by suitably qualified and authorized personnel
- the personnel is instructed regularly about relevant occupational safety and environmental protection aspects, and is familiar with the operating manual and in particular the safety notes contained herein
- the operation manual is in good condition and complete, and always available for reference at the location of the product.

 Note	Do not open the housing of the Panel PC! For technical support contact Beckhoff Service .
--	---

1.4.1 National regulations

Depending on the type of machine and plant in which the Panel PC is used, national regulations governing the controllers of such machines will apply, and must be observed by the operator. These regulations cover, amongst other things, the intervals between inspections of the controller. The operator must initiate such inspections in good time.

1.4.2 Procedure in the event of a fault

In the event of faults at the Panel PC, the list in the section [Troubleshooting](#) can be used to determine the measures to be taken.

1.4.3 Operator requirements

Anyone who uses the Panel PC must have read these operating instructions and must be familiar with all the functions of the software installed on the Industrial PC to which he has access.

2 Product Description

2.1 Product overview



The compact built-in Panel PC

The built-in Panel PC CP6606-0001-0020 with Ethernet port can be used as an independent Panel PC, remote desktop display or server terminal. The powerful 1 GHz ARM Cortex™ A8 CPU is suitable for versatile use in PLC and Motion Control applications in small and medium-sized machines, plants or buildings.

The Panel PC offers the following benefits:

- 7-inch TFT display, 800 x 480 WVGA
- touch screen
- aluminium front with sheet-steel rear cover
- protection class front side IP54, rear side IP20
- operating temperature 0...55 °C (0°C to +45°C with wall mounting frame)
- all connectors at the lower rear side
- 1 slot for MicroSD Flash Card, accessible from the rear side
- lithium battery of the system clock, accessible from the rear side
- pull-out clamping levers for fast installation without loose parts
- low installation depth.

2.2 Appropriate Use

The built-in Panel PC CP6606-0001-0020 is suitable for versatile use in PLC and Motion Control applications in small and medium-sized machines, plants or buildings. A TFT display with touchscreen is accommodated in a steel housing with aluminium front. The Panel PC is installed in the front of control cabinets, for wall installation the wall mounting frame with order option C9900-M317 is necessary.

 Danger	Risk of explosion! The Panel PC must not be used where there is a risk of explosion.
--	--

2.3 Access to the connectors

The connectors of the Panel PC are located at the lower rear side of the housing.



Picture: Bottom view

2.4 Interfaces

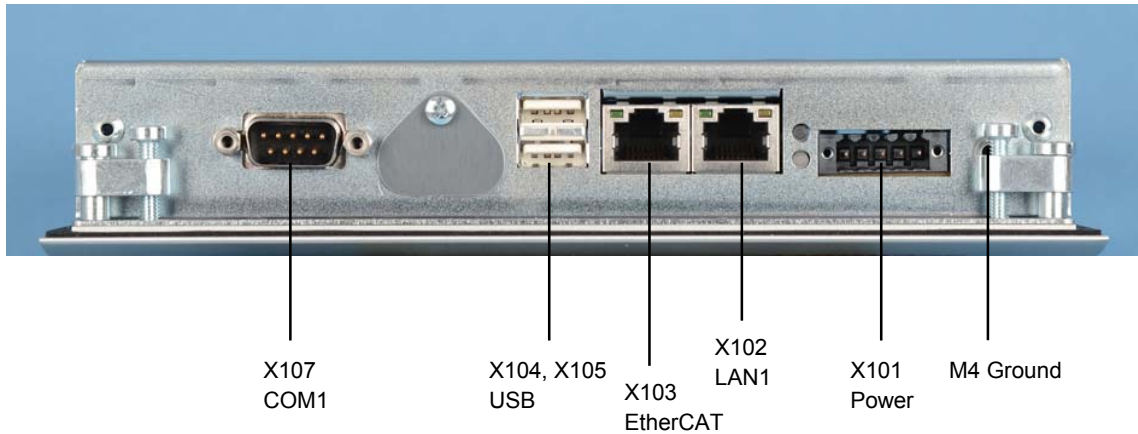

2.4.1 Power Supply (X101)

The power supply for the Panel PC is established via the socket (**X101**). The power supply connector is included in delivery.

Pin	Signal	Pin	Signal	
1	NC	4	GND	Power Supply
2	NC	5	+ 24 V _{DC}	
3	⊕			

2.4.2 Network connection LAN1 (X 102)

The RJ-45 connector (**X102**) allows the PC to be connected to a 10/100BASE-T Local Area Network (LAN).

2.4.3 EtherCAT connection (X 103)

The RJ-45 connector (**X103**) allows the PC to be connected to an EtherCAT Network.

2.4.4 USB output (X 104, X 105)

The two USB interfaces (**X104, X105**, connector type A) are used for connecting peripheral devices with USB connection. USB2.0 standard is supported.

2.4.5 Serial interface COM1 (X107)

The Panel PC has one serial interface COM1 (**X107**) using the type RS232, which is brought to a 9 pin SUB-D plug connector.

2.4.6 Ground connection (Ground)

The Panel PC is grounded via the M4-screw connection (**Ground**).

2.5 Access to the battery and the plug-in card slot

The battery and the plug-in card slot are located behind the cover plate beside the connectors of the Panel PC:

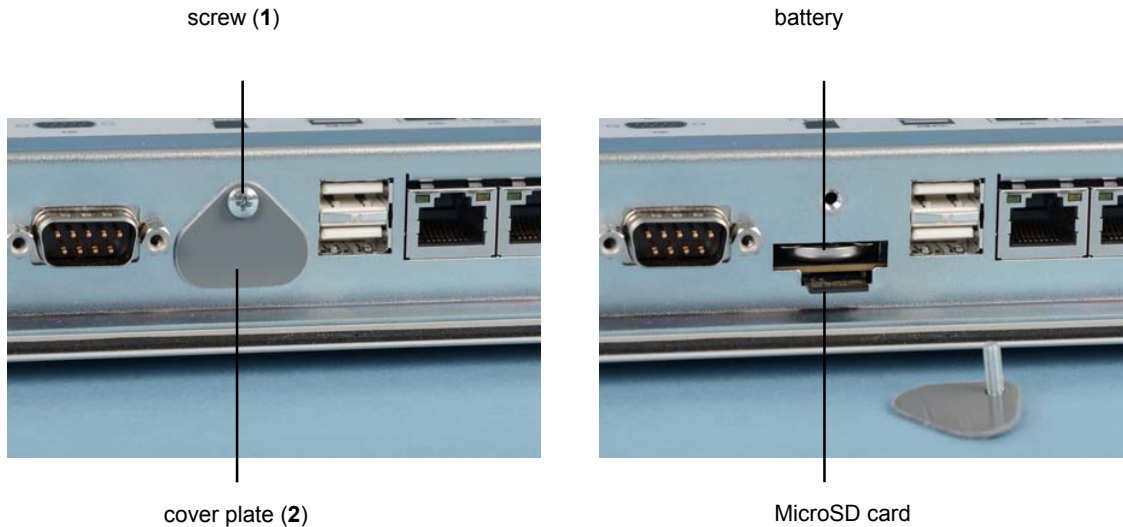

For replacing the battery and installation of the MicroSD card first unloose the cross-head screw (1). The cover plate (2) can now be removed.

 WARNING	<p>Danger of Explosion!</p> <p>Replace battery only with the identical type or an alternative type recommended by the manufacturer. Notice correct polarity!</p>
---	---

2.6 Status-LEDs

The Status-LEDs are located near the power supply connector (X101):

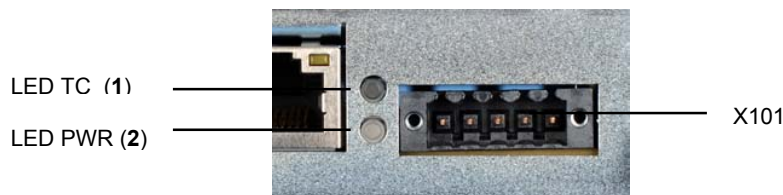

Description of the Status-LEDs

1	TC (TwinCAT):	red green blue	Stop Mode Run Mode Configuration Mode
2	PWR (Power):	green green blinking	Busy Standby

3 Installation

3.1 Transport and Unpacking

The specified storage conditions must be observed (see chapter [Technical Data](#)).

3.1.1 Transport

Despite the robust design of the unit, the components are sensitive to strong vibrations and impacts. During transport, your device should therefore be protected from excessive mechanical stress. Therefore, please use the original packaging.

 Attention	Danger of damage to the unit If the device is transported in cold weather or is exposed to extreme variations in temperature, make sure that moisture (condensation) does not form on or inside the device.
---	---

Prior to operation, the unit must be allowed to slowly adjust to room temperature. Should condensation occur, a delay time of approximately 12 hours must be allowed before the unit is switched on.

3.1.2 Unpacking

Proceed as follows to unpack the unit:

1. Remove packaging.
2. Do not discard the original packaging. Keep it for future relocation.
3. Check the delivery for completeness by comparing it with your order.
4. Please keep the associated paperwork. It contains important information for handling the unit.
5. Check the contents for visible shipping damage.

If you notice any shipping damage or inconsistencies between the contents and your order, you should notify Beckhoff Service.

3.2 Installation in the control cabinet

The Panel PC CP6606-0001-0020 is designed for mounting in control cabinets in machine and plant engineering applications. The ambient conditions specified for operation must be observed (see chapter [Technical Data](#)).

3.2.1 Preparation of the control cabinet

The control cabinet wall must be prepared with the required mounting opening according to the Panel PC's dimensions (see chapter [Assembly dimensions](#)).

 <p>Note</p>	<p>Circulation of air</p> <p>When the unit is installed in an enclosure, adequate space for ventilation must be provided.</p> <p>The clearance above and below the housing must be at least 5 cm in order to ensure adequate ventilation of the Panel PC.</p>
--	--

Please note the following points during installation of the Panel PC:

- Position the Panel PC in such a way that reflections on the screen are avoided as far as possible.
- Use the position of the screen as a guide for the correct installation height; it should be optimally visible for the user at all times.
- The Panel PC should not be exposed to direct sunlight.
- When the unit is in its mounting position, the ventilation openings must not be obstructed.

 <p>Attention</p>	<p>Avoid extreme environmental conditions</p> <p>Extreme environmental conditions should be avoided as far as possible. Protect the Panel PC from dust, moisture and heat.</p> <p>The ventilation slots of the Panel PC must not be covered.</p>
---	---

3.2.2 Installation in a control cabinet wall

For installation of the Panel PC proceed as follows:

1. Insert the Panel PC at the intended control cabinet wall position and protect it from falling out, prior to final mounting.
2. Release the clamping levers, turn the clamping levers to the side and retighten the screws (see chapter [Mounting of the Panel PC](#)).

3.2.3 Mounting of the Panel PC

The Panel PC is installed in the cabinet wall with clamping levers. For the cutout dimension of the Panel PC see chapter *Technical Data*, the wall thickness is between 1 mm and 5 mm.



1. Insert the Panel PC into the cutout.
2. Release the clamping levers with a 2.5 mm Allen key.



3. Turn the clamping levers to the side.



4. Retighten the screws.



3.3 Wall installation with wall mounting frame (optional)

For wall installation the wall mounting frame with order option C9900-M317 is necessary.



Note

Reduced operating temperature

Installation of the CP6606-0001-0020 in the wall mounting frame will reduce the maximum operating temperature down to 45 °C.

3.3.1 Mounting the wall mounting frame

The wall mounting frame must be flush-mounted in the wall and may not overlap the finished plaster. A maximum of 5 mm behind the finished plaster can be adjusted with the ball catch.

Ensure that the wall mounting frame is oriented correctly. The cable compartment has to be below the panel.

The wall mounting frame has to be installed in a horizontal position. When the wall mounting frame is installed the adjustment of the panel is not possible anymore. Screw heads at the inner sides of the frame may not exceed 2.5 mm.

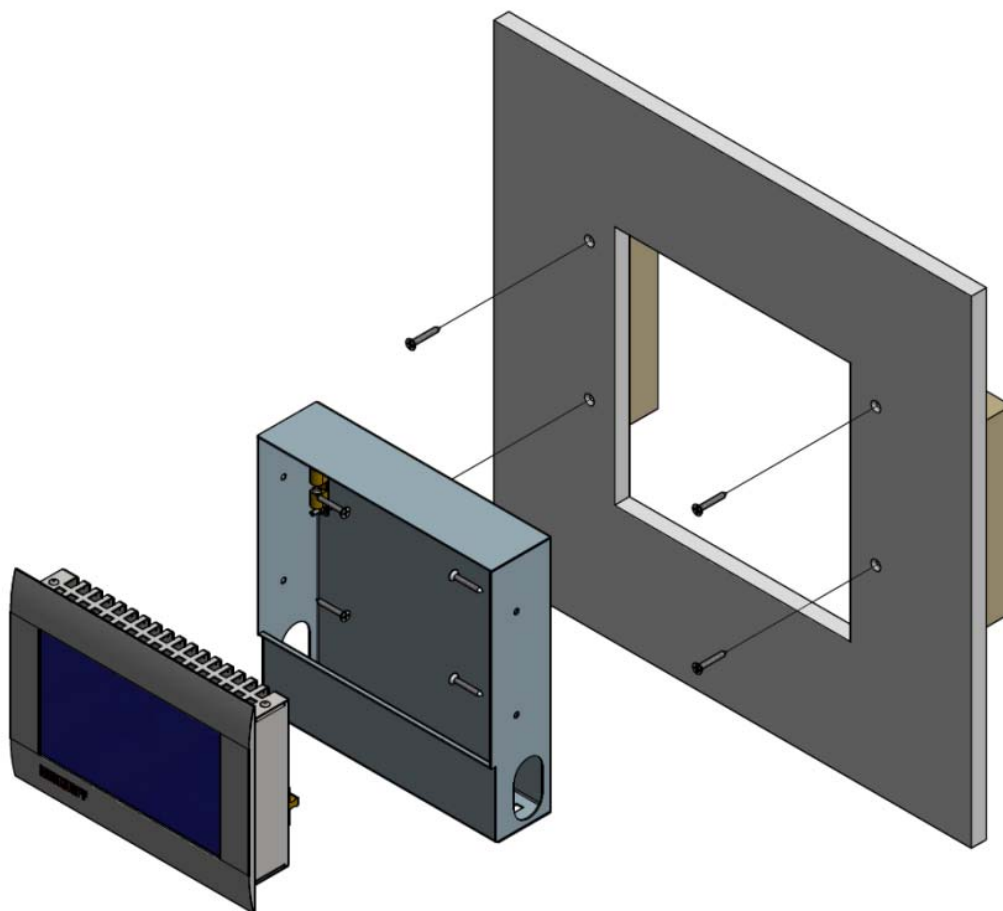

3.3.2 Cut out dimension

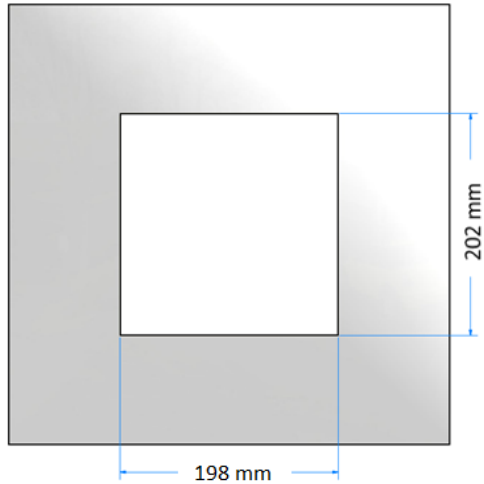

3.3.3 Plastering the frame

The cable compartment has to be plastered flush.

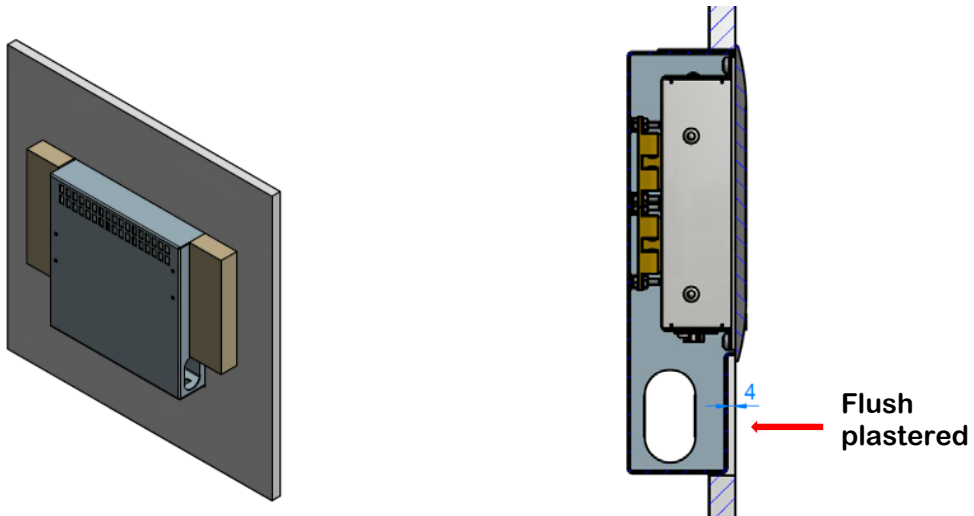

3.3.4 Mounting of the Panel PC

The ball catch counter parts are delivered with the wall mounting frame and have to be screwed onto the back side of the CP6606-0001-0020. The needed countersunk head screws M3x6 are delivered with the wall mounting frame as well. The holding force of the ball catch can be adjusted.

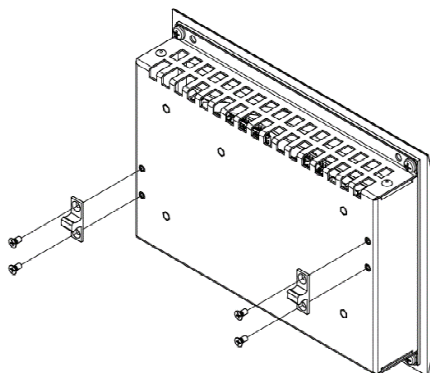

3.4 Fitting the power supply cable

Fit the cables for the power supply of the Panel PC, using the included material for assembling the connectors:

Material for assembling the connector

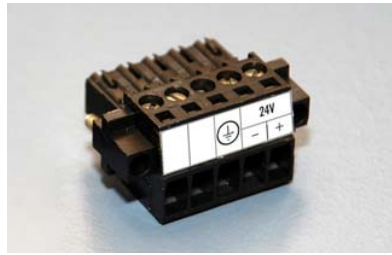

Plug connector 5-pole

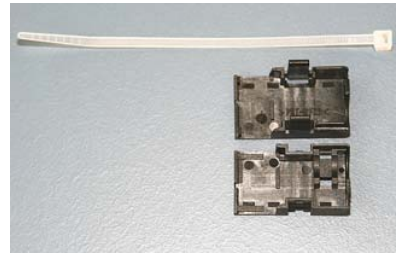

Stain relief housing with lacing cord

 Note	<p>Conductive cross-section</p> <p>The connector is specified for 16 A and can lift conductive cross-sections until 1.5 mm².</p>
--	--

So the connector is fitted to the cable

1. Strip insulation from the cable ends (Length of stripped conductor is 8 - 9 mm).
2. Screw together the cable ends in the 5-pole plug connector in accordance with wiring diagram.

Applying the strain relief

Thread the lacing cord into that lower part of the stain relief housing.

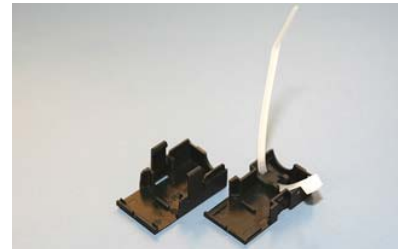

Putting in the plug connector

Put the plug connector into that lower part of the stain relief housing.

Tighten the lacing cord and pinch off the plastic strap.



Fixing the upper part of the stain relief housing

Fix the upper part of the stain relief housing by snapping it onto the lower part.



3.5 Connecting the Panel PC



Attention

The mains plug must be disconnected

Please read the documentation for the external devices prior to connecting them!

During thunderstorms, plug connector must neither be inserted nor removed!

When disconnecting a plug connector, always handle it at the plug. Do not pull the cable!

3.5.1 Connecting cables

The connections are located at the bottom of the Panel PC and are documented in the chapter [Interfaces](#).

When connecting cables to the Panel PC, please adhere to the following order:

- Disconnect the Panel PC from the power supply.
- Connect all cables at the Panel PC and at the devices to be connected.
- Ensure that all screw connections between connectors and sockets are tight!
- Reconnect all devices to the power supply.

3.5.2 Earthing measures

Earthing connections dissipate interference from external power supply cables, signal cables or cables to peripheral equipment. Establish a low-impedance connection from the earthing point on the Panel PC housing (see chapter [Ground connection \(Ground\)](#)) to the central earthing point on the control cabinet wall, in which the computer is being installed.

4 Operating Instructions

4.1 Switching the Panel PC on and off

4.1.1 Switching on

The Panel PC does not have its own mains power switch. As soon as the power supply is switched on the Panel PC is activated.

4.1.2 Shutting down and switching off

Control software such as is typically used on Industrial PCs permits various users to be given different rights. A user who may not close software may also not switch the Panel PC off, since data can be lost from the storage medium by switching off while software is running.

 Warning	<p>First shut down, then switch off!</p> <p>If the Panel PC is switched off as the software is writing a file to the storage medium, the file will be destroyed. Control software typically writes something to the storage medium every few seconds, so that the probability of causing damage by switching off while the software is running is very high.</p>
---	---

 Warning	<p>Switch off power supply</p> <p>When you have shut down the Panel PC, you have to switch off power supply for at least 10 seconds before rebooting the system. After resetting power supply the Panel PC will start booting automatically.</p>
---	---

4.1.3 First switching on and driver installation

When you switch on the Industrial PC for the first time, the pre-installed operating system (optional) will be started. In this case, all the required drivers for any additional, optional hardware components ordered with the PC will already have been installed.

If the PC was ordered without operating system, you have to install the operating system and the driver software for any auxiliary hardware yourself. Please follow the instructions in the documentation for the operating system and the additional devices.

4.2 Operation

The operation of the Panel PC occurs via the Touch Screen.

 Warning	<p>Risk of damaging the Touch Screen</p> <p>The touch screen may only be actuated by finger tips or with the touch screen pen. The operator may wear gloves but there must be no hard particles such as metal shavings, glass splinters embedded in the glove.</p>
---	---

4.3 Servicing and maintenance

4.3.1 Cleaning

 DANGER	<p>Disconnect power supply</p> <p>Switch off the device and all connected devices, and disconnect the device from the power supply.</p>
--	--

The device can be cleaned with a soft, damp cleaning cloth. Do not use any aggressive cleaning materials, thinners, scouring material or hard objects that could cause scratches.

4.3.2 Maintenance

The Panel PC is maintenance-free.

4.3.3 Replacing the battery on the motherboard

A used battery on the motherboard has to be replaced. See also chapter [Access to the battery and the plug-in card slot](#).

 WARNING	<p>Danger of Explosion!</p> <p>Replace battery only with the identical type or an alternative type recommended by the manufacturer. Notice correct polarity!</p>
---	---

The used battery must be disposed of in accordance with national electronics scrap regulations.

4.4 Emergency procedures

In case of fire, the Panel PC should be extinguished with powder or nitrogen.

4.5 Shutting down

4.5.1 Disposal

 Note	<p>Observe national electronics scrap regulations</p> <p>Observe the national electronics scrap regulations when disposing of the device.</p>
--	--

In order to dispose of the device, it must be removed and fully dismantled:

- Housing components (polycarbonate, polyamide (PA6.6)) are suitable for plastic recycling.
- Metal parts can be sent for metal recycling.
- Electronic parts such as disk drives and circuit boards must be disposed of in accordance with national electronics scrap regulations.

5 Troubleshooting

 Note	<p>Pixel errors</p> <p>Pixel errors in the TFT display are production-caused and represent no complaint-reason!</p>
--	--

 Note	<p>Anomalies of the Touchscreen</p> <p>Anomalies of the touchscreen sensor are production-caused and represent no complaint-reason!</p>
--	--

Fault	Cause	Measures
The Panel PC shows no function	No power supply to the Panel PC Cable not connected	Check power supply cable 1. Correctly connect cable 2. Call Beckhoff Service
Panel PC boots, software starts, but control does not operate correctly	Cause of the fault is either in the software or in parts of the plant outside the Panel PC	Call the manufacturer of the machine or the software
The Panel PC functions only partially or only part of the time, e.g. no or dark picture	Faulty backlight in the display Defective components in the Panel PC	Call Beckhoff Service Call Beckhoff Service

6 Assembly dimensions

 Warning	<p>Notice mounting orientation</p> <p>The assembly of the unit must take place with the orientation diagrammed here.</p>
---	---

All dimensions are in mm.



Front view

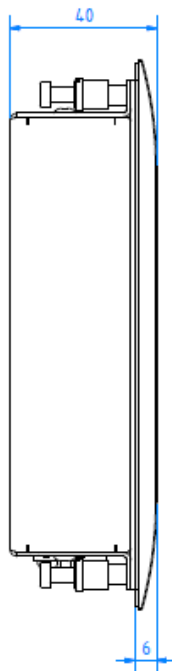

Side view

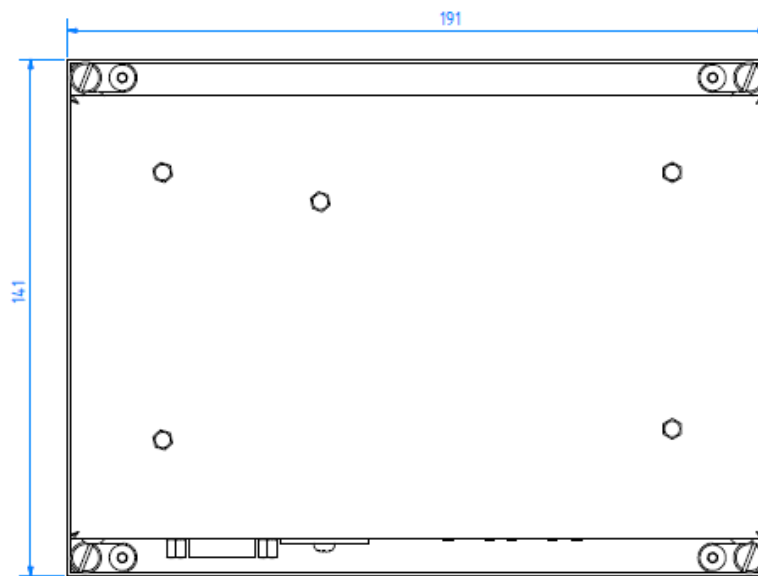

Rear view with cutout-dimensions

8 Appendix

8.1 Beckhoff Support and Service

Beckhoff and their partners around the world offer comprehensive support and service, making available fast and competent assistance with all questions related to Beckhoff products and system solutions.

8.1.1 Beckhoff branches and partner companies

Please contact your Beckhoff branch office or partner company for [local support and service](#) on Beckhoff products!

The contact addresses for your country can be found in the list of Beckhoff branches and partner companies: www.beckhoff.com. You will also find further [documentation](#) for Beckhoff components there.

8.1.2 Beckhoff company headquarters

Beckhoff Automation GmbH & Co. KG
Huelshorstweg 20
33415 Verl
Germany

Phone: + 49 (0) 5246/963-0
Fax: + 49 (0) 5246/963-198
E-mail: info@beckhoff.de
Web: <http://www.beckhoff.de/>

Beckhoff Support

Support offers you comprehensive technical assistance, helping you not only with the application of individual Beckhoff products, but also with other, wide-ranging services:

- world-wide support
- design, programming and commissioning of complex automation systems
- and extensive training program for Beckhoff system components

Hotline: + 49 (0) 5246/963-157
Fax: + 49 (0) 5246/963-9157
E-mail: support@beckhoff.com

Beckhoff Service

The Beckhoff Service Center supports you in all matters of after-sales service:

- on-site service
- repair service
- spare parts service
- hotline service

Hotline: + 49 (0) 5246/963-460
Fax: + 49 (0) 5246/963-479
E-mail: service@beckhoff.com

If servicing is required, please quote the **project number** of your product.

8.2 Approvals for USA and Canada

8.3 FCC Approvals for the United States of America

FCC: Federal Communications Commission Radio Frequency Interference Statement

This equipment has been tested and found to comply with the limits for a Class A digital device, pursuant to Part 15 of the FCC Rules. These limits are designed to provide reasonable protection against harmful interference when the equipment is operated in a commercial environment. This equipment generates, uses, and can radiate radio frequency energy and, if not installed and used in accordance with the instruction manual, may cause harmful interference to radio communications. Operation of this equipment in a residential area is likely to cause harmful interference in which case the user will be required to correct the interference at his own expense.



Note

Technical modifications

Technological changes to the device may cause the loss of the FCC approval.

8.4 FCC Approval for Canada

FCC: Canadian Notice

This equipment does not exceed the Class A limits for radiated emissions as described in the Radio Interference Regulations of the Canadian Department of Communications.