



User Guide

IS620N & ISMH Series

AC Servo Drive and Motor

EtherCAT Communication

20-bit Incremental/23-bit Multi-turn Absolute Encoder



User Guide

Contents

Safety Information and Precautions	3
Chapter 1 Product Information	5
1.1 Servo Drive	5
1.1.1 Designation Rules and Nameplate	5
1.1.2 Specifications of Servo Drive	5
1.1.3 Physical Appearance and Mounting Dimensions of Servo Drive	6
1.1.4 Specifications of Regenerative Resistor	7
1.2 Servo Motor	8
1.2.1 Designation Rules and Nameplate	8
1.2.2 Specifications of Servo Motor	9
1.2.3 Mounting Dimensions of Servo Motor	11
1.3 Servo System Configuration	19
1.4 Environment	20
Chapter 2 Wiring	21
2.1 Servo System Wiring	21
2.2 General Wiring Diagram	23
2.3 Cable Model	24
2.4 Connection Between Servo Drive and Servo Motor	27
2.4.1 Main Circuit	28
2.4.2 Servo Motor Encoder	32
2.4.3 Control Signal Terminal Connector CN1	38
2.4.4 Communication Signal Terminal Connectors CN3/CN4	40
2.4.5 Communication Signal Terminal Connector CN5	40
Chapter 3 Operation and Display	41
3.1 Introduction to Keypad	41
3.2 Keypad Display	41
3.2.1 Conversion Between Keypad Display and Host Controller Operation Objects	41
3.2.2 Display Switchover	42
3.3 Parameter Setting	42
3.4 User Password	44
Chapter 4 Quick Setup	45
4.1 Inovance PLC AM600 as Master	45
4.1.1 Controlling a Single Drive	45
4.1.2 Controlling Two Drives	52
4.2 Omron PLC NJ501 as Master	60
4.2.1 Making Preparations	60

4.2.2 Configuring the Servo Drive.....	61
4.2.3 Configuring Omron NJ Software.....	63
Chapter 5 Troubleshooting.....	75
5.1 Fault and Warning Rectification at Startup.....	75
5.2 Troubleshooting of Faults.....	75
5.2 Troubleshooting of Warnings	90
5.3 Internal Faults	94
5.4 Rectification of Communication Faults.....	95
Chapter 6 Overview of Object Dictionary.....	97
6.1 Object Group 1000h.....	97
6.2 Object Group 2000h.....	103
6.3 Object Group 6000h.....	125
6.4 DIDO Function Definitions.....	129
Revision History	135

Safety Information and Precautions

This User Guide is packaged together with the IS620N Servo Drive. It contains basic information for quick start of the drive. For safety and more information, please refer to the IS620N Advanced User Guide, which can be downloaded on the website <http://www.inovance.cn>.

■ Electrical Safety

Extreme care must be taken at all times when working with the Servo Drive or within the area of the Servo Drive. The voltages used in the Servo Drive can cause severe electrical shock or burns and is potentially lethal. Only authorized and qualified personnel should be allowed to work on Servo Drives.

■ Machine/System Design and Safety of Personnel

Machine/system design, installation, commissioning startups and maintenance must be carried out by personnel who have the necessary training and experience. They must read this safety information and the contents of this manual. If incorrectly installed, the Servo Drive may present a safety hazard.

The Servo Drive uses high voltages and currents (including DC), carries a high level of stored electrical energy in the DC bus capacitors even after power OFF. These high voltages are potentially lethal.

The Servo Drive is NOT intended to be used for safety related applications/functions. The electronic "STOP & START" control circuits in the Servo Drive must not be relied upon for the safety of personnel. Such control circuits isolates mains power voltages from the output of the Servo Drive. The mains power supply must be disconnected by an electrical safety isolation device before accessing the internal parts of the Servo Drive.

Safety risk assessments of the machine or process system which uses a Servo Drive must be undertaken by the user and or by their systems integrator/designer. In particular the safety assessment/design must take into consideration the consequences of the Servo Drive failing or tripping out during normal operation and whether this leads to a safe stop position without damaging machine, adjacent equipment and machine operators/users. This responsibility lies with the user or their machine/process system integrator.

System integrator/designer must ensure the complete system is safe and designed according to the relevant safety standards. Inovance Technology and Authorized Distributors can provide recommendations related to the Servo Drive to ensure long term safe operation.

The installer of the Servo Drive is responsible for complying with all relevant regulations for wiring, circuit fuse protection, earthing, accident prevention and electromagnetic (EMC regulations). In particular fault discrimination for preventing fire risk and solid earthing practices must be adhered to for electrical safety (also for good EMC practice). Within the European Union, all machinery in which this product is used must comply with required directives.

■ Electrical Installation - Safety

Electrical shock risk is always present within a Servo Drive including the output cable leading to the motor terminals. Where dynamic brake resistors are fitted external to the Servo Drive, care must be taken with regards to live contact with the brake resistors, terminals which are at high DC voltage and potentially lethal. Cables from the Servo Drive to the dynamic brake resistors should be double insulated as DC voltages are typically 600 to 700 VDC.

Mains power supply isolation switch should be fitted to the Servo Drive. The mains power supply must be disconnected via the isolation switch before any cover of the Servo Drive can be removed or before any servicing work is undertaken stored charge in the DC bus capacitors of the PWM inverter is potentially lethal after the AC supply has been disconnected. The AC supply must be isolated at least 10 minutes before any work can be undertaken as the stored charge will have been discharged through the internal bleed resistor fitted across the DC bus capacitors.

Whenever possible, it is good practice to check DC bus voltage with a VDC meter before accessing the inverter bridge. Where the Servo Drive input is connected to the mains supply with a plug and socket, then upon disconnecting the plug and socket, be aware that the plug pins may be exposed and internally connected to DC bus capacitors (via the internal bridge rectifier in reversed bias). Wait 10 minutes to allow stored charge in the DC bus capacitors to be dissipated by the bleed resistors before commencing work on the Servo Drive.

■ **Electrical Shock Hazard**

Ensure the protective earthing conductor complies with technical standards and local safety regulations. Because the leakage current exceeds 3.5 mA in all models, IEC 61800-5-1 states that either the power supply must be automatically disconnected in case of discontinuity of the protective earthing conductor or a protective earthing conductor with a cross-section of at least 10 mm² (Cu) or 16 mm² (Al) must be used. Failure to comply may result in death or serious injury.



When using an earth leakage circuit breaker, use a residual current operated protective device (RCD) of type B (breaker which can detect both AC and DC). Leakage current can cause unprotected components to operate incorrectly. If this is a problem, lower the carrier frequency, replace the components in question with parts protected against harmonic current, or increase the sensitivity amperage of the leakage breaker to at least 200 mA per drive.

Factors in determining leakage current:

- Size of the Servo Drive
- Servo drive carrier frequency
- Motor cable type and length
- EMI/RFI filter

■ **Approvals**

Certification marks on the product nameplate indicate compliance with the corresponding certificates and standards.

Certification	Mark	Directives		Standard	
CE		EMC directives	2014/30/EU	AC servo drive	EN 61800-3
				AC servo motor	EN 60034-1
		LVD directives	2014/35/EU	AC servo drive	EN 61800-5-1
				AC servo motor	EN 60034-1
		RoHS directives	2011/65/EU	EN 50581	
TUV		-		AC servo drive	EN 61800-5-1
				AC servo motor	EN 60034-1

Note

- The above EMC directives are complied with only when the EMC electric installation requirements are strictly observed.
- Machines and devices used in combination with this drive must also be CE certified and marked. The integrator who integrates the drive with the CE mark into other devices has the responsibility of ensuring compliance with CE standards and verifying that conditions meet European standards.
- The installer of the drive is responsible for complying with all relevant regulations for wiring, circuit fuse protection, earthing, accident prevention and electromagnetic (EMC) regulations). In particular fault discrimination for preventing fire risk and solid earthing practices must be adhered to for electrical safety (also for good EMC practice).
- For more information on certification, consult our distributor or sales representative.

Chapter 1 Product Information

1.1 Servo Drive

1.1.1 Designation Rules and Nameplate

Figure 1-1 Designation rules and nameplate of servo drive

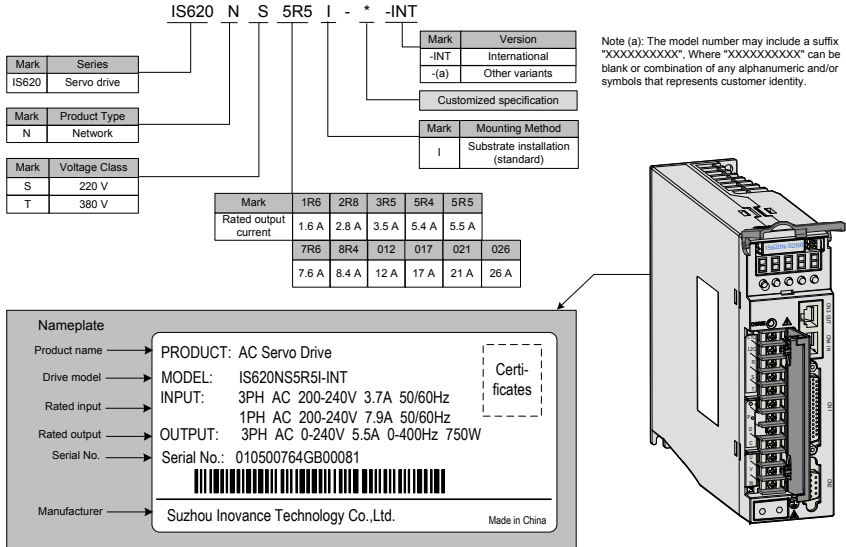

1.1.2 Specifications of Servo Drive

Electrical Specifications

■ Single-phase 220 V

Item	SIZE-A		
Drive model IS620N	S1R6	S2R8	S5R5
Continuous output current Arms	1.6	2.8	5.5
Maximum output current Arms	5.8	10.1	16.9
Main circuit power supply	Single-phase 200 to 240 VAC, +10% to -10%, 50/60 Hz		
Control circuit power supply	Single-phase 200 to 240 VAC, +10% to -10%, 50/60 Hz		
Braking capability	External regenerative resistor		Built-in regenerative resistor

■ Three-phase 220 V

Item	SIZE-A	SIZE-C	
Drive model IS620N	S5R5	S7R6	S012
Continuous output current Arms	5.5	7.6	11.6
Maximum output current Arms	16.9	17	28
Main circuit power supply	Three-phase 200 to 240 VAC, +10% to -10%, 50/60 Hz		
Control circuit power supply	Single-phase 200 to 240 VAC, +10% to -10%, 50/60 Hz		
Braking capability	Built-in regenerative resistor		

■ Three-phase 380 V

Item	SIZE-C				SIZE-E		
Drive model IS620N	T3R5	T5R4	T8R4	T012	T017	T021	T026
Continuous output current Arms	3.5	5.4	8.4	11.9	16.5	20.8	25.7
Maximum output current Arms	8.5	14	20	24	42	55	65
Main circuit power supply	Three-phase 380 to 480 VAC, +10% to -10%, 50/60 Hz						
Control circuit power supply	Single-phase 380 to 480 VAC, +10% to -10%, 50/60 Hz						
Braking capability	Built-in regenerative resistor						

1.1.3 Physical Appearance and Mounting Dimensions of Servo Drive

SIZE A: IS620NS1R6I, IS620NS2R8I, IS620NS5R5I

SIZE C: IS620NS7R6I, IS620NS012I, IS620NT3R5I, IS620NT5R4I, IS620NT8R4I, IS620NT012I

SIZE E: IS620NT017I, IS620NT021I, IS620NT026I

Figure 1-2 Physical appearance and mounting dimensions of servo drive

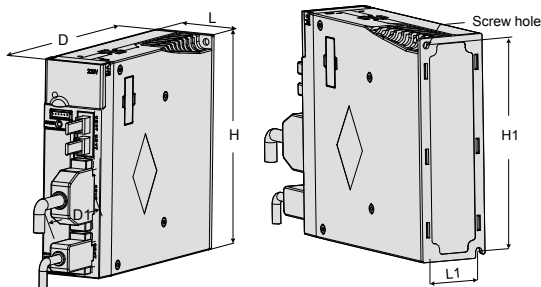

Size	L (mm)	H (mm)	D (mm)	L1 (mm)	H1 (mm)	D1 (mm)	Screw Hole	Tightening Torque (Nm)
SIZE A	50	160	173	40	150	75	2-M4	0.6 to 1.2
SIZE C	90	160	183	80	150	75	4-M4	0.6 to 1.2
SIZE E	100	250	230	90	240	75	4-M4	0.6 to 1.2

1.1.4 Specifications of Regenerative Resistor

Drive Model		Built-in Regenerative Resistor Specs		Min. Allowed Resistance (Ω)	Max. Braking Energy Absorbed by Capacitor (J)
		Resistance (Ω)	Power (W)		
Single-phase 220 V	IS620NS1R6I	-	-	50	9
	IS620NS2R8I	-	-	45	18
Single/Three-phase 220 V	IS620NS5R5I	50	50	40	26
Three-phase 220 V	IS620NS7R6I	25	80	20	26
	IS620NS012I			15	47
Three-phase 380 V	IS620NT3R5I	100	80	80	28
	IS620NT5R4I	100	80	60	34
	IS620NT8R4I	50	80	45	50
	IS620NT012I				50
	IS620NT017I	40	100	35	81
	IS620NT021I			25	122
	IS620NT026I				122

Note

Models S1R6 and S2R8 are not configured with a built-in regenerative resistor. Use an external regenerative resistor if necessary.

For use for the external regenerative resistor, refer to the IS620N Advanced User Guide.

1.2 Servo Motor

1.2.1 Designation Rules and Nameplate

Figure 1-3 Designation rules and nameplate of servo motor

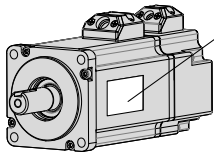
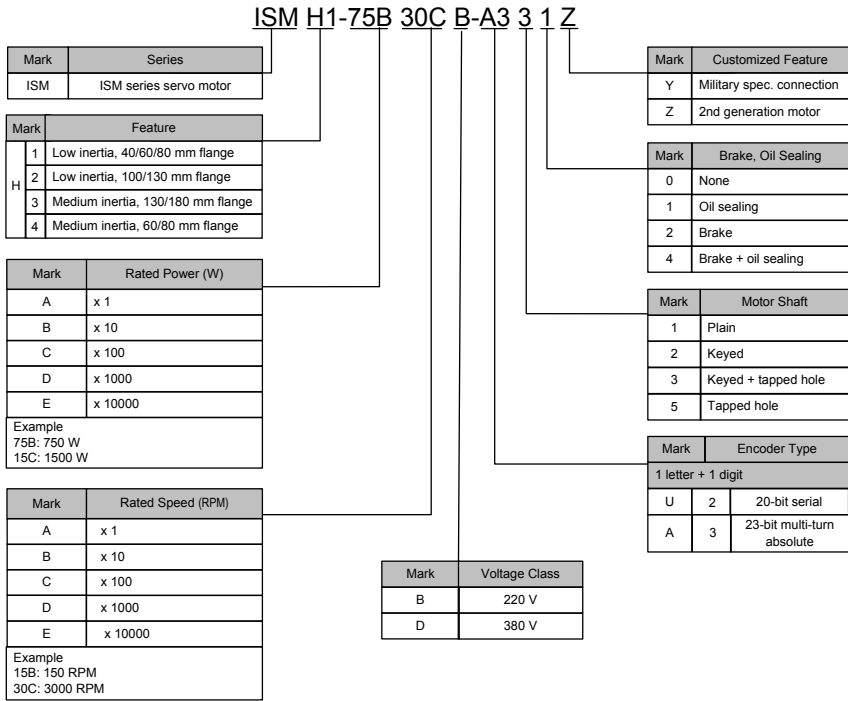

Nameplate													
Product name →	INOVANCE AC Servo Motor												
Model →	Model: ISMH1-75B30CB-A331Z												
Parameters →	<table style="width: 100%; border-collapse: collapse;"> <tr> <td style="width: 25%;">0.75 kW</td> <td style="width: 25%;">220 V</td> <td style="width: 25%;">3000 r/min</td> <td style="width: 25%;"></td> </tr> <tr> <td>2.39 N·m</td> <td>250 Hz</td> <td>4.8 A</td> <td></td> </tr> <tr> <td>Duty S1</td> <td>Ins. F</td> <td>3PHAC</td> <td>IP65</td> </tr> </table>	0.75 kW	220 V	3000 r/min		2.39 N·m	250 Hz	4.8 A		Duty S1	Ins. F	3PHAC	IP65
0.75 kW	220 V	3000 r/min											
2.39 N·m	250 Hz	4.8 A											
Duty S1	Ins. F	3PHAC	IP65										
Motor code →	Motor Code: 14101 Weight: 2.7 kg												
Manufacturer →	Suzhou Inovance Technology Co., Ltd.												
Serial No. →	Made in China SN:01120275*****												

IEC60034

1.2.2 Specifications of Servo Motor

Motor Mechanical Characteristics

Item	Description
Rated time	Continuous
Vibration level	V15
Insulation resistance	500 VDC, above 10 MΩ
Use ambient temperature	0–40°C
Excitation mode	Permanent magnetic
Installation method	Flange
Heat-resistance level	F
Housing protection mode	H1, H4: IP65 (except the through-shaft section) Other: IP67
Use environment humidity	20%–80% (no condensation)
Connection mode	Direct connection
Rotating direction	The motor rotates counterclockwise viewed from the load side (CCW) at the forwarding rotation command.

Motor Ratings

Servo Motor Model	Rated Output (kW) (Note 1)	Rated Torque (N·m)	Max. Torque (N·m)	Rated Curr. (A)	Max. Curr. (A)	Rated Speed (RPM)	Max. Speed (RPM)	Torque Para. (N·m/A)	Rotor Inertia (10^{-4} kg·m ²)	Voltage (V)
ISMH1 (V _n = 3000 RPM, V _{max} = 6000 RPM)										
ISMH1-10B30CB-****Z	0.1	0.32	0.96	1.1	3.3	3000	6000	0.298	0.046 (0.048)*2	220
ISMH1-20B30CB-****Z	0.2	0.63	1.91	1.6	5.12			0.50	0.149 (0.163)	
ISMH1-40B30CB-****Z	0.4	1.27	3.82	2.8	8.96			0.50	0.25	
ISMH1-55B30CB-****Z	0.55	1.75	5.25	3.8	12.2			0.496	1.04	
ISMH1-75B30CB-****Z	0.75	2.39	7.16	4.80	15.10			0.57	1.3	
ISMH1-10C30CB-****Z	0.75	3.18	9.55	7.6	24.5			0.485	1.7	
ISMH2 (V _n = 3000 RPM, V _{max} = 6000/5000 RPM)										
ISMH2-10C30CB-****Y	1.0	3.18	9.54	7.5	23.00	3000	6000	0.43	1.87 (3.12)	220
ISMH2-15C30CB-****Y	1.5	4.90	14.7	10.8	32.00		5000	0.45	2.46 (3.71)	
ISMH2-10C30CD-****Y	1.0	3.18	9.54	3.65	11.00	3000	6000	0.87	1.87 (3.12)	380
ISMH2-15C30CD-****Y	1.5	4.90	14.7	4.50	14.00		5000	1.09	2.46 (3.71)	

Servo Motor Model	Rated Output (kW) (Note 1)	Rated Torque (N·m)	Max. Torque (N·m)	Rated Curr. (A)	Max. Curr. (A)	Rated Speed (RPM)	Max. Speed (RPM)	Torque Para. (N·m/A)	Rotor Inertia (10 ⁻⁴ kg·m ²)	Voltage (V)
ISMH2-20C30CD-****Y	2.0	6.36	19.1	5.89	20.00	3000	5000	1.08	3.06	380
ISMH2-25C30CD-****Y	2.5	7.96	23.9	7.56	25.00			1.05	3.65	
ISMH2-30C30CD-****Y	3.0	9.8	29.4	10.00	30.00			0.98	7.72	
ISMH2-40C30CD-****Y	4.0	12.6	37.8	13.60	40.80			0.93	12.1	
ISMH2-50C30CD-****Y	5.0	15.8	47.6	16.00	48.00			1.07	15.4	
ISMH3 (Vn = 1500 RPM, Vmax = 3000 RPM)										
ISMH3-85B15CB-****Y	0.85	5.39	13.5	6.60	16.50	1500	3000	0.9	13 (15.5)	220
ISMH3-13C15CB-****Y	1.3	8.34	20.85	10.00	25.00			0.9	19.3 (21.8)	
ISMH3-85B15CD-****Y	0.85	5.39	13.5	3.30	8.25			1.75	13 (15.5)	380
ISMH3-13C15CD-****Y	1.3	8.34	20.85	5.00	12.50			1.78	19.3 (21.8)	
ISMH3-18C15CD-****Y	1.8	11.5	28.75	6.60	16.50			1.8	25.5 (28)	
ISMH3-29C15CD-****Z	2.9	18.6	37.2	11.90	28.00			1.7	55 (57.2)	
ISMH3-44C15CD-****Z	4.4	28.4	71.1	16.50	40.50			1.93	88.9 (90.8)	
ISMH3-55C15CD-****Z	5.5	35.0	87.6	20.85	52.00			1.80	107 (109.5)	
ISMH3-75C15CD-****Z	7.5	48.0	119	25.70	65.00			1.92	141 (143.1)	
ISMH4 (Vn = 3000 Rpm, Vmax = 6000 RPM)										
ISMH4-40B30CB-****Z	0.4	1.27	3.82	2.80	10.10	3000	6000	0.50	(0.667)	220
ISMH4-75B30CB-****Z	0.75	2.39	7.16	4.80	15.10			0.57	(2.033)	

Note

Note 1: The motor with oil sealing must be derated by 10% during use.

Note 2: Parameters in () are for the motor with brake.

The parameters in the preceding table are the values when the motor works together with Inovance servo drive and the armature coil temperature is 20°C.

The preceding features are based on the cooling conditions when the following heatsinks are installed.

ISMH1/ISMH4: 250 x 250 x 6 mm (aluminum)

ISMH2-10C to 25C: 300 x 300 x 12 mm (aluminum)

ISMH2-30C to 50C: 400 x 400 x 20 mm (aluminum)

ISMH3-85B to 18C: 400 x 400 x 20 mm (iron)

ISMH3-29C to 75C: 360 x 360 x 5 mm (double aluminum plate)

1.2.3 Mounting Dimensions of Servo Motor

ISMH1 Series Motor

100 W, 200 W, 400 W, 550 W, 750 W, 1.0 kW

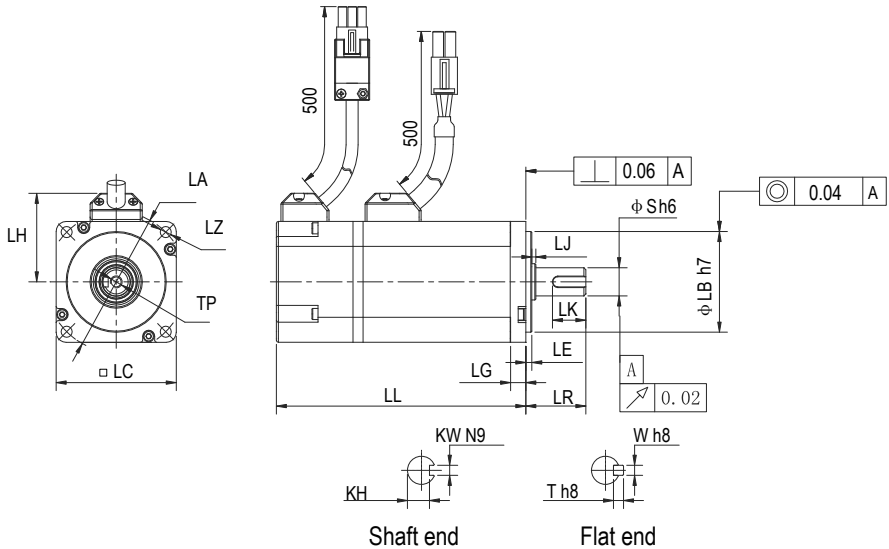

Motor Model	LC	LL	LR	LA	LZ	LH	LG	LE	LJ
ISMH1-10B30CB-****Z	40	103(136)	25±0.5	46	2- $\phi 4.5$	34	5	2.5±0.3	0.5±0.35
ISMH1-20B30CB-****Z	60	98(138)	30±0.5	70	4- $\phi 5.5$	44	7.8	3±0.3	0.5±0.35
ISMH1-40B30CB-****Z	60	118	30±0.5	70	4- $\phi 5.5$	44	7.8	3±0.3	0.5±0.35
ISMH1-55B30CB-****Z	80	126	35±0.5	90	4- $\phi 7$	54	8	3±0.3	0.5±0.35
ISMH1-75B30CB-****Z	80	135.5	35±0.5	90	4- $\phi 7$	54	8	3±0.3	0.5±0.35

ISMH1-10C30CB-****Z	80	153.5	35±0.5	90	4-φ7	54	8	3±0.3	0.5±0.35
Motor Model	LB	S	TP	LK	KH	KW	W	T	Weight (kg)
ISMH1-10B30CB-****Z	30	8	M3 x 6	16	6.2 ⁰ _{-0.1}	3	3	3	0.59(0.77)
ISMH1-20B30CB-****Z	50	14	M5 x 8	16.5	11 ⁰ _{-0.1}	5	5	5	1.1(1.4)
ISMH1-40B30CB-****Z	50	14	M5 x 8	16.5	11 ⁰ _{-0.1}	5	5	5	1.6
ISMH1-55B30CB-****Z	70	19	M6 x 20	25	15.5 ⁰ _{-0.1}	6	6	6	2.3
ISMH1-75B30CB-****Z	70	19	M6 x 20	25	15.5 ⁰ _{-0.1}	6	6	6	2.7
ISMH1-10C30CB-****Z	70	19	M6 x 20	25	15.5 ⁰ _{-0.1}	6	6	6	3.2

Note

The unit is mm, and () indicates the servo motor with brake.

Connector	Power Side (with Brake)	Encoder Side
Plastic housing	MOLEX-50361672	AMP172169-9

Terminal	MOLEX-39000059	AMP1473226-1
----------	----------------	--------------

ISMH2 series

1) 1.0 kW, 1.5 kW, 2.0 kW, 2.5 kW, 3.0 kW, 4.0 kW, 5.0 kW

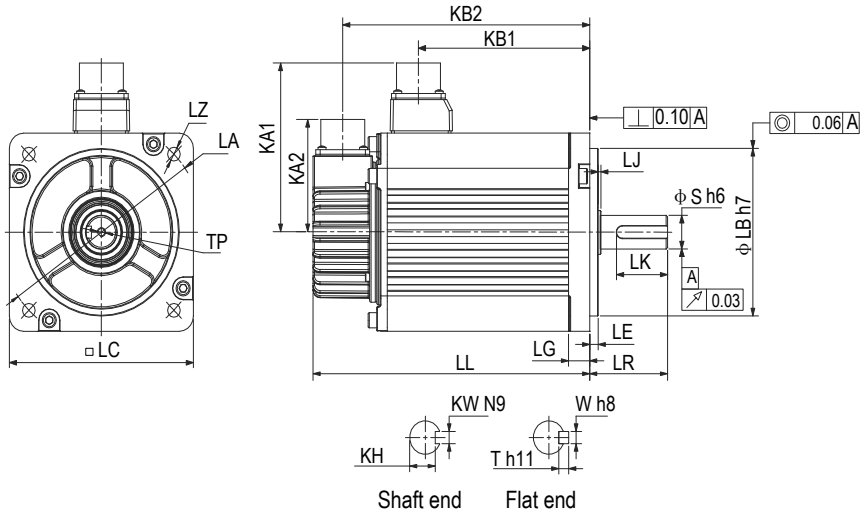

1

Motor Model	LC	LL	LR	LA	LZ	KA1	KB1	KA2	KB2	LG
ISMH2-10C30CB-***3*Y	100	164(213.5)	45±1	115	4-φ7	96	94.5 (101)	74	143.5 (192.5)	10
ISMH2-15C30CB-***3*Y	100	189(239)	45±1	115	4-φ7	96	119.5 (128)	74	168.5 (219.5)	10
ISMH2-10C30CD-***3*Y	100	164(213.5)	45±1	115	4-φ7	96	94.5 (101)	74	143.5 (192.5)	10
ISMH2-15C30CD-***3*Y	100	189(239)	45±1	115	4-φ7	96	119.5 (128)	74	168.5 (219.5)	10
ISMH2-20C30CD-***3*Y	100	214	45±1	115	4-φ7	96	144.5	74	193.5	10
ISMH2-25C30CD-***3*Y	100	240.5	45±1	115	4-φ7	96	169.5	74	218.5	10
ISMH2-30C30CD-***3*Y	130	209.5	63±1	145	4-φ9	111	136	74	188.5	14

ISMH2-40C30CD-***Y	130	252		63±1	145	4-φ9	111	178.5	74	231	14
ISMH2-50C30CD-***Y	130	294.5		63±1	145	4-φ9	111	221	74	273.5	14
Motor Model	LE	LJ	LB	S	TP	LK	KH	KW	W	T	Weight (kg)
ISMH2-10C30CB-***Y	5±0.3	2.5±0.75	95	24	M8 x 16	36	20 ⁰ _{-0.2}	8	8	7	5.11 (6.41)
ISMH2-15C30CB-***Y	5±0.3	2.5±0.75	95	24	M8 x 16	36	20 ⁰ _{-0.2}	8	8	7	6.22 (7.52)
ISMH2-10C30CD-***Y	5±0.3	2.5±0.75	95	24	M8 x 16	36	20 ⁰ _{-0.2}	8	8	7	5.11 (6.41)
ISMH2-15C30CD-***Y	5±0.3	2.5±0.75	95	24	M8 x 16	36	20 ⁰ _{-0.2}	8	8	7	6.22 (7.52)
ISMH2-20C30CD-***Y	5±0.3	2.5±0.75	95	24	M8 x 16	36	20 ⁰ _{-0.2}	8	8	7	7.39
ISMH2-25C30CD-***Y	5±0.3	2.5±0.75	95	24	M8 x 16	36	20 ⁰ _{-0.2}	8	8	7	8.55
ISMH2-30C30CD-***Y	6±0.3	0.5±0.75	110	28	M8 x 20	54	24 ⁰ _{-0.2}	8	8	7	10.73
ISMH2-40C30CD-***Y	6±0.3	0.5±0.75	110	28	M8 x 20	54	24 ⁰ _{-0.2}	8	8	7	15.43
ISMH2-50C30CD-***Y	6±0.3	0.5±0.75	110	28	M8 x 20	54	24 ⁰ _{-0.2}	8	8	7	16.2

Note

The unit is mm, and () indicates the servo motor with brake.

Connector	Power Side (with Brake)	Encoder Side
Military spec. plug	MI-DTL-5015 series 3102E20-18P	MI-DTL-5015 series 3102E20-29P

ISMH3 series

1) 850 W, 1.3 kW, 1.8 kW

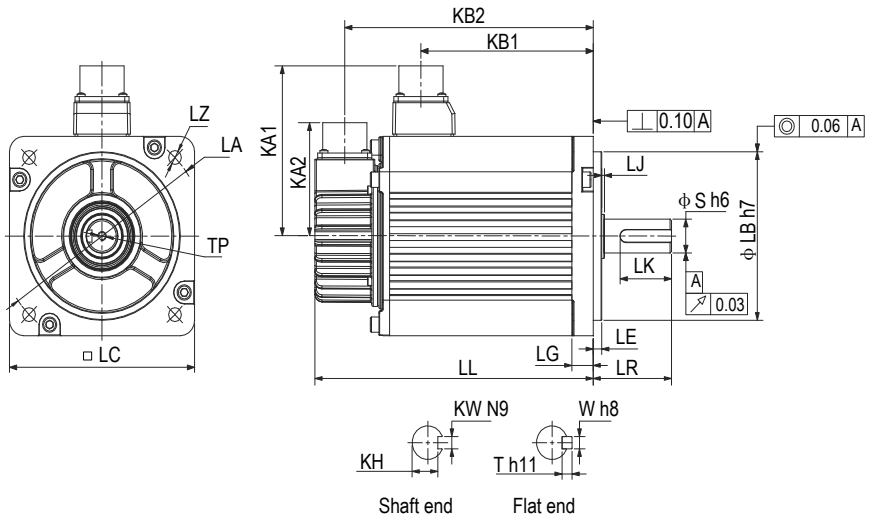

Motor Model	LC	LL	LR	LA	LZ	KA1	KB1	KA2	KB2	LG
ISMH3-85B15CB-***Y	130	168.5 (227.5)	55±1	145	4-φ9	111	95 (97)	74	147.5 (206.5)	14
ISMH3-13C15CB-***Y	130	194.5 (253.5)	55±1	145	4-φ9	111	121 (124)	74	173.5 (232.5)	14
ISMH3-18C15CD-***Y	130	220.5 (279.5)	55±1	145	4-φ9	111	147 (150)	74	199.5 (258.5)	14
ISMH3-85B15CD-***Y	130	168.5 (227.5)	55±1	145	4-φ9	111	95 (97)	74	147.5 (206.5)	14
ISMH3-13C15CD-***Y	130	194.5 (253.5)	55±1	145	4-φ9	111	121 (124)	74	173.5 (232.5)	14

Motor Model	LE	LJ	LB	S	TP	LK	KH	KW	W	T	Weight (kg)
ISMH3-85B15CB-***3*Y	6±0.3	0.5±0.75	110	22	M6 x 20	36	18 ⁰ _{-0.2}	8	8	7	8.23 (10.73)
ISMH3-13C15CB-***3*Y	6±0.3	0.5±0.75	110	22	M6 x 20	36	18 ⁰ _{-0.2}	8	8	7	10.57 (13)
ISMH3-18C15CD-***3*Y	6±0.3	0.5±0.75	110	22	M6 x 20	36	18 ⁰ _{-0.2}	8	8	7	12.7 (15.2)
ISMH3-85B15CD-***3*Y	6±0.3	0.5±0.75	110	22	M6 x 20	36	18 ⁰ _{-0.2}	8	8	7	8.23 (10.73)
ISMH3-13C15CD-***3*Y	6±0.3	0.5±0.75	110	22	M6 x 20	36	18 ⁰ _{-0.2}	8	8	7	10.57 (13)

Note

The unit is mm, and () indicates the servo motor with brake.

Connector	Power Side (with Brake)	Encoder Side
Military spec. plug	MI-DTL-5015 series 3102E20-18P	MI-DTL-5015 series 3102E20-29P

2) 2.9 kW, 4.4 kW, 5.5 kW, 7.5 kW

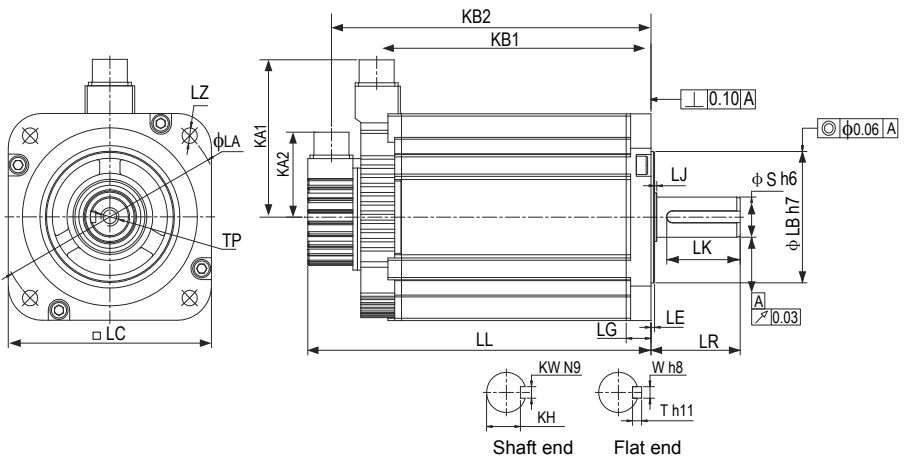

Motor Model	LC	LL	LR	LA	LZ	KA1	KB1	KA2	KB2	LG	
ISMH3-29C15CD-****Z	180	197(273)	79±1	200	4-φ13.5	138	136 (134)	74	177 (253)	18	
ISMH3-44C15CD-****Z	180	230(307)	79±1	200	4-φ13.5	138	169 (167)	74	210 (286)	18	
ISMH3-55C15CD-****Z	180	274(350)	113±1	200	4-φ13.5	138	213 (211)	74	254 (330)	18	
ISMH3-75C15CD-****Z	180	330(407)	113±1	200	4-φ13.5	138	269 (267)	74	310 (386)	18	
Motor Model	LE	LJ	LB	S	TP	LK	KH	KW	W	T	Weight (kg)
ISMH3-29C15CD-****Z	3.2±0.3	0.3±0.75	114.3	35	M12 x 25	65	30 ⁰ -0.2	10	10	8	15 (25)
ISMH3-44C15CD-****Z	3.2±0.3	0.3±0.75	114.3	35	M12 x 25	65	30 ⁰ -0.2	10	10	8	19.5 (30)
ISMH3-55C15CD-****Z	3.2±0.3	0.3±0.75	114.3	42	M16 x 32	96	37 ⁰ -0.2	12	12	8	28 (38)
ISMH3-75C15CD-****Z	3.2±0.3	0.3±0.75	114.3	42	M16 x 32	96	37 ⁰ -0.2	12	12	8	32 (42)

Note

The unit is mm, and () indicates the servo motor with brake.

Connector	Power Side (with Brake)	Encoder Side
Military spec. plug	MI-DTL-5015 series 3102E20-22P	MI-DTL-5015 series 3102E20-29P

ISMH4 series

1) 400 W, 750 W

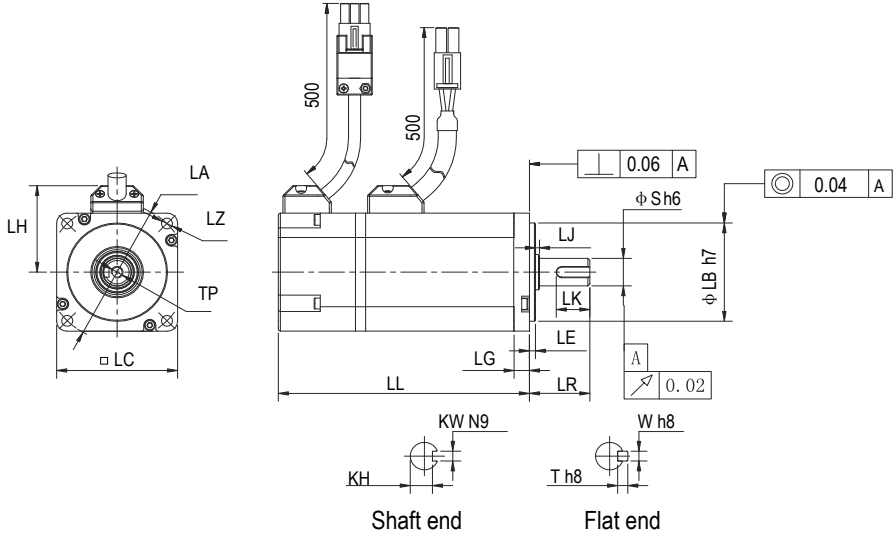

1

Motor Model	LC	LL	LR	LA	LZ	LH	LG	LE	LJ
ISMH4-40B30CB-****Z	60	125 (165)	30±0.5	70	4-φ5.5	44	7.8	3±0.3	0.5±0.35
ISMH4-75B30CB-****Z	80	146.5 (184.5)	35±0.5	90	4-φ7	54	8	3±0.3	0.5±0.35
Motor Model	LB	S	TP	LK	KH	KW	W	T	Weight (kg)
ISMH4-40B30CB-****Z	50	14	M5 x 8	16.5	11 ⁰ _{-0.1}	5	5	5	1.7 (2.0)
ISMH4-75B30CB-****Z	70	19	M6 x 20	25	15.5 ⁰ _{-0.1}	6	6	6	2.9 (3.3)

Note

The unit is mm, and () indicates the servo motor with brake.

Connector	Power Side (with Brake)	Encoder Side
Plastic housing	MOLEX-50361672	AMP172169-9
Terminal	MOLEX-39000059	AMP1473226-1

1.3 Servo System Configuration

220 V:

Rated Speed (RPM)	Max. Speed (RPM)	Capacity (W)	Servo Motor Model ISMH*-*****_****		Motor Frame	Drive Model IS620N****1		Drive Size	Drive SN (H01-02)
						Single-phase 220 VAC	Three-phase 220 VAC		
3000	6000	200	H1 (low inertia, 40/60/80 mm flange)	20B30CB	60	S1R6		A	00002
		400		40B30CB	60	S2R8		A	00003
		550		55B30CB	80	S5R5		A	00005
		750		75B30CB	80	S5R5		A	00005
		1000		10C30CB	80	S7R6		C	00006
	1000	10C30CB	100			S7R6	C	00006	
	5000	1500	H2 (low inertia, 100/130 mm flange)	15C30CB	100		S012	C	00007
1500	3000	850	H3 (medium inertia, 130/180 mm flange)	85B15CB	130		S7R6	C	00006
		1300		13C15CB	130		S012	C	00007
3000	6000	400	H4 (low inertia, 60/80 mm flange)	40B30CB	60	S2R8		A	00003
		750		75B30CB	80	S5R5		A	00005

380 V:

Rated Speed (RPM)	Max. Speed (RPM)	Capacity (W)	Servo Motor Model ISMH*-*****_****		Motor Frame	Drive Model	Drive Size	Drive SN (H01-02)
						Three-phase 380 VAC		
3000	6000	1000	H2 (low inertia, 100/130 mm flange)	10C30CD	100	T5R4	C	10002
		1500		15C30CD	100	T5R4	C	10002
		2000		20C30CD	100	T8R4	C	10003
		2500		25C30CD	100	T8R4	C	10003
		3000		30C30CD	130	T012	C	10004
		4000		40C30CD	130	T017	E	10005
		5000		50C30CD	130	T017	E	10005
1500 RPM	3000 RPM	850	H3 (medium inertia, 130/180 mm flange)	85B15CD	130	T3R5	C	10001
		1300		13C15CD	130	T5R4	C	10002
		1800		18C15CD	130	T8R4	C	10003
		2900		29C15CD	180	T012	C	10004
		4400		44C15CD	180	T017	E	10005
		5500		55C15CD	180	T021	E	10006
		7500		75C15CD	180	T026	E	10007

1.4 Environment

Item	Servo Drive	Servo Motor
Use ambient temperature	0–55°C (average load ratio not exceeding 80% when ambient temperature is within 40–55°C) (non-freezing)	0 to 40°C (non-freezing)
Use environment humidity	Below 90% RH (no condensation)	20% – 90% RH (no condensation)
Storage temperature	-20 to 85°C (non-freezing)	-20 to 60°C (Peak temperature ensurance: 80°C for 72 hours)
Storage humidity	Below 90% RH (no condensation)	20%–90% RH (no condensation)
Vibration	Below 4.9 m/s ²	Below 49 m/s ²
Impact	Below 19.6 m/s ²	Below 490 m/s ²
Ingress protection	IP10	H1/H4: IP65 (except for the through-shaft section and motor connectors) Other: IP67 (except for the through-shaft section and motor connectors)
Pollution degree	PD2	PD2
Overvoltage category	OVCIII	-
Altitude	< 1000 m	< 1000 m (de-rated if the altitude is above 1000 m)

Chapter 2 Wiring

2.1 Servo System Wiring

Figure 2-1 Wiring example of single-phase 220 V system

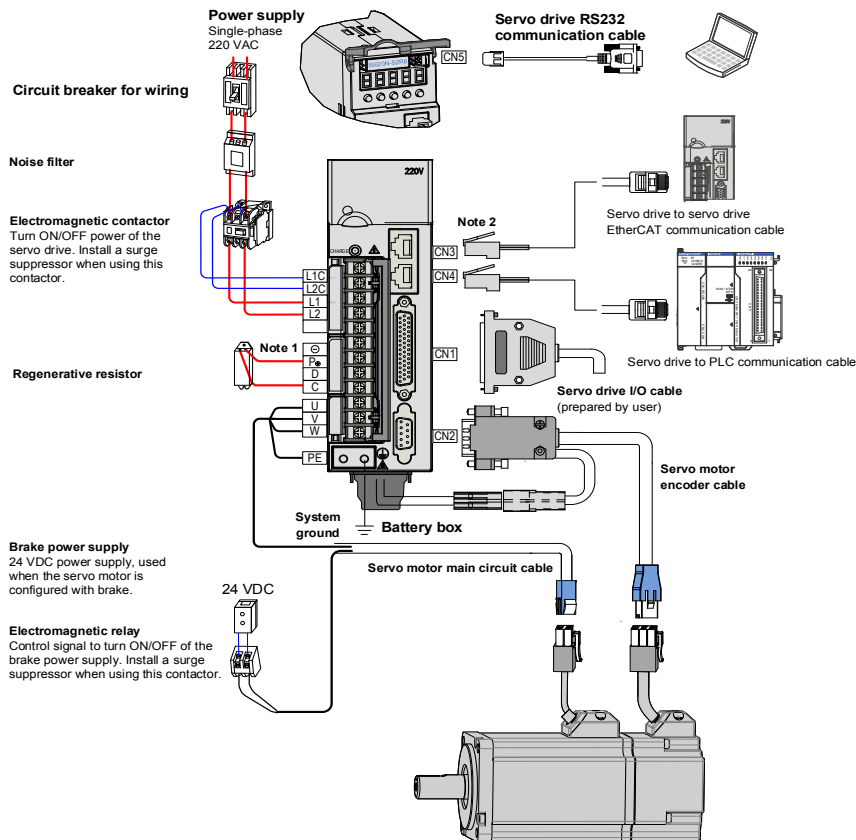

The servo drive is directly connected to an industrial power supply, with no isolation such as transformer. In this case, a fuse or circuit breaker must be connected on the input power supply to prevent cross electric accidents in the servo system. The servo drive is not configured with the built-in protective grounding circuit. Thus, connect a residual current device (RCD) against both overload and short-circuit or a specialized RCCB combined with protective grounding.

It is forbidden to run or stop the motor by using the electromagnetic contactor. As a high-inductance device, the motor generates instantaneous high voltage, which may damage the contactor.

Pay attention to the power capacity when connecting an external control power supply or 24 VDC, especially when the power supply is for powering up multiple drives or brakes. Insufficient power supply will lead to lack of supply current, thus causing failure of the drives or brakes. The brake shall be powered up by a 24 VDC power supply. The power must match the motor model and meets the brake requirements.

Note

1. Remove the jumper between terminals P_{\oplus} and D of the servo drive when connecting a regenerative resistor.
2. CN3 and CN4 are identical communication ports with the same pin definition, and either can be used.

Figure 2-2 Wiring example of three-phase 220 V/380 V system

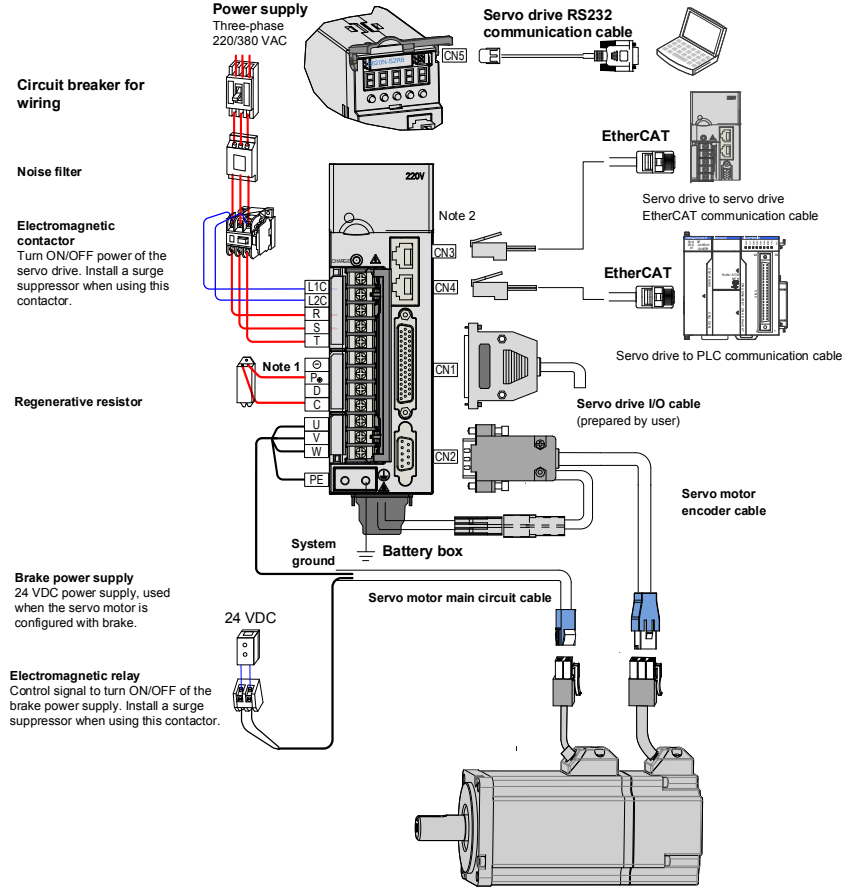

The servo drive is directly connected to an industrial power supply, with no isolation such as transformer. In this case, a fuse or circuit breaker must be connected on the input power supply to prevent cross electric accidents in the servo system. The servo drive is not configured with the built-in protective grounding circuit. Thus, connect a RCD against both overload and short-circuit or a specialized RCD combined with protective grounding.

It is forbidden to run or stop the motor by using the electromagnetic contactor. As a high-inductance device, the motor generates instantaneous high voltage, which may damage the contactor.

Pay attention to the power capacity when connecting an external control power supply or 24 VDC, especially when the power supply is for powering up multiple drives or brakes. Insufficient power supply will lead to lack of supply current, thus causing failure of the drives or brakes. The brake shall be powered up by a 24 VDC power supply. The power must match the motor model and meets the brake requirements.

Note

1. Remove the jumper between terminals P_{\oplus} and D of the servo drive when connecting a regenerative resistor.
2. CN3 and CN4 are identical communication ports with the same pin definition, and either can be used.

2.2 General Wiring Diagram

Figure 2-3 General wiring diagram

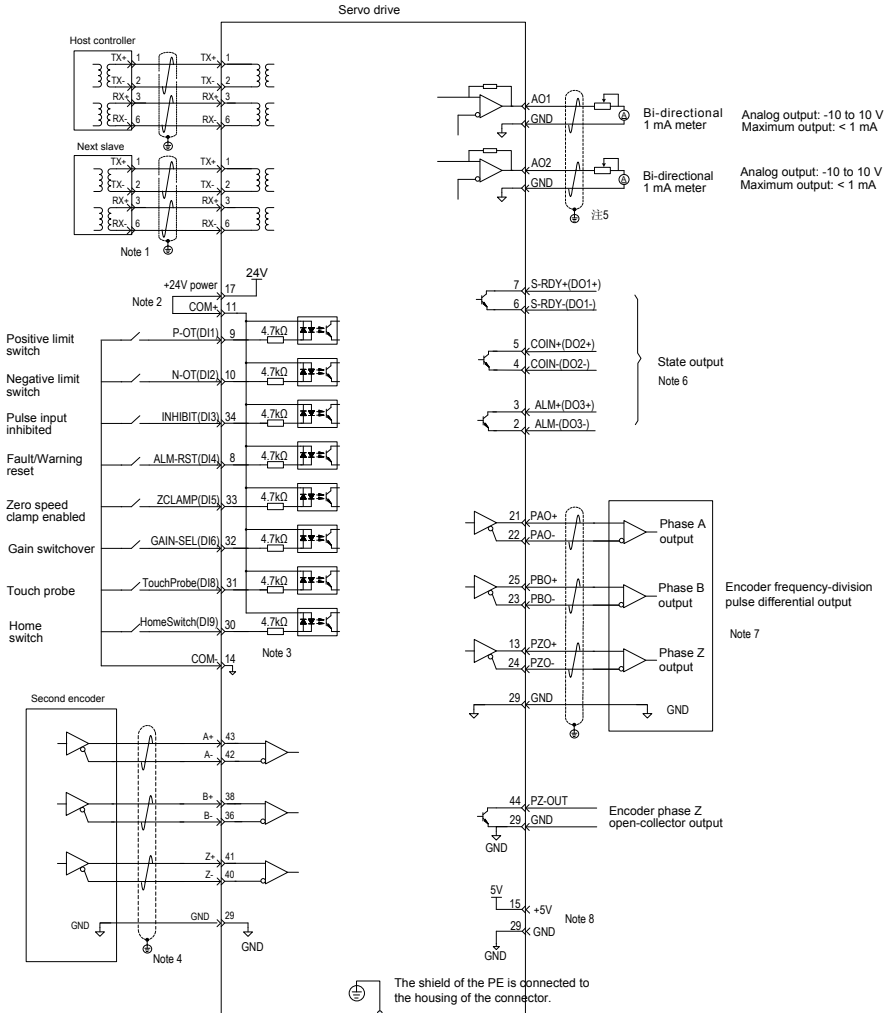

Pay attention to the precautions:

- The double-layer shielded 100M-Ethernet enhanced category 5 or better network cable is recommended. Both direct-through or crossover Ethernet cables are allowable.

- Internal +24V power supply, voltage range: 20–28 V, maximum output current: 200 mA
- DI8 and DI9 are high-speed DIs. Use them according to their functions allocated.
- Use the shielded twisted-pair for fully closed-loop control, with both ends of the shield tied to PE. Connect GND and signal ground of the host controller reliably.
- Use the shielded twisted-pair for AO circuit, with both ends of the shield tied to PE.
- Customers need to prepare the power supply for DOs, with voltage range 5–24 V. The DO terminals support 30 VDC voltage and 50 mA current to the maximum.
- Use the shielded twisted-pair as the encoder frequency-division cables, with both ends of the shield tied to PE. Connect GND and signal ground of the host controller reliably.
- The internal +5 V power supply supports a maximum of 200 mA current.

2.3 Cable Model

Servo Motor Power Cable and Encoder Cable

■ Models Without Brake

Motor Model	Cable Type	Cable Length		
		L = 3.0 m	L = 5.0 m	L = 10.0 m
ISMH1-*****-U1*** ISMH1-*****-U2*** ISMH4-*****-U1*** ISMH4-*****-U2***	Power cable	S6-L-M00-3.0	S6-L-M00-5.0	S6-L-M00-10.0
	Incremental encoder cable	S6-L-P00-3.0	S6-L-P00-5.0	S6-L-P00-10.0
ISMH1-*****-A3*** ISMH4-*****-A3***	Power cable	S6-L-M00-3.0	S6-L-M00-5.0	S6-L-M00-10.0
	Absolute encoder cable	S6-L-P20-3.0	S6-L-P20-5.0	S6-L-P20-10.0
ISMH2-*****-U1*** ISMH2-*****-U2***	Power cable	S6-L-M11-3.0	S6-L-M11-5.0	S6-L-M11-10.0
	Incremental encoder cable	S6-L-P01-3.0	S6-L-P01-5.0	S6-L-P01-10.0
ISMH2-*****-A3***	Power cable	S6-L-M11-3.0	S6-L-M11-5.0	S6-L-M11-10.0
	Absolute encoder cable	S6-L-P21-3.0	S6-L-P21-5.0	S6-L-P21-10.0
ISMH3-*****-U1*** ISMH3-*****-U2*** (1.8 kW and below)	Power cable	S6-L-M11-3.0	S6-L-M11-5.0	S6-L-M11-10.0
	Incremental encoder cable	S6-L-P01-3.0	S6-L-P01-5.0	S6-L-P01-10.0
ISMH3-*****-A3*** (1.8 kW and above)	Power cable	S6-L-M11-3.0	S6-L-M11-5.0	S6-L-M11-10.0
	Absolute encoder cable	S6-L-P21-3.0	S6-L-P21-5.0	S6-L-P21-10.0
ISMH3-*****-U1*** ISMH3-*****-U2*** (2.9 kW)	Power cable	S6-L-M12-3.0	S6-L-M12-5.0	S6-L-M12-10.0
	Incremental encoder cable	S6-L-P01-3.0	S6-L-P01-5.0	S6-L-P01-10.0
ISMH3-*****-A3*** (2.9 kW)	Power cable	S6-L-M12-3.0	S6-L-M12-5.0	S6-L-M12-10.0
	Absolute encoder cable	S6-L-P21-3.0	S6-L-P21-5.0	S6-L-P21-10.0
ISMH3-*****-U1*** ISMH3-*****-U2*** (above 2.9 kW)	Power cable	S6-L-M22-3.0	S6-L-M22-5.0	S6-L-M22-10.0
	Incremental encoder cable	S6-L-P01-3.0	S6-L-P01-5.0	S6-L-P01-10.0
ISMH3-*****-A3*** (above 2.9 kW)	Power cable	S6-L-M22-3.0	S6-L-M22-5.0	S6-L-M22-10.0
	Absolute encoder cable	S6-L-P21-3.0	S6-L-P21-5.0	S6-L-P21-10.0

■ Models with Brake

Motor Model	Cable Type	Cable Length		
		L = 3.0 m	L = 5.0 m	L = 10.0 m
ISMH1-*****-U1*** ISMH1-*****-U2*** ISMH4-*****-U1*** ISMH4-*****-U2***	Power cable	S6-L-B00-3.0	S6-L-B00-5.0	S6-L-B00-10.0
	Incremental encoder cable	S6-L-P00-3.0	S6-L-P00-5.0	S6-L-P00-10.0
ISMH1-*****-A3*** ISMH4-*****-A3***	Power cable	S6-L-B00-3.0	S6-L-B00-5.0	S6-L-B00-10.0
	Absolute encoder cable	S6-L-P20-3.0	S6-L-P20-5.0	S6-L-P20-10.0
ISMH2-*****-U1*** ISMH2-*****-U2***	Power cable	S6-L-B11-3.0	S6-L-B11-5.0	S6-L-B11-10.0
	Incremental encoder cable	S6-L-P01-3.0	S6-L-P01-5.0	S6-L-P01-10.0
ISMH2-*****-A3***	Power cable	S6-L-B11-3.0	S6-L-B11-5.0	S6-L-B11-10.0
	Absolute encoder cable	S6-L-P21-3.0	S6-L-P21-5.0	S6-L-P21-10.0
ISMH3-*****-U1*** ISMH3-*****-U2*** (1.8 kW and below)	Power cable	S6-L-B11-3.0	S6-L-B11-5.0	S6-L-B11-10.0
	Incremental encoder cable	S6-L-P01-3.0	S6-L-P01-5.0	S6-L-P01-10.0
ISMH3-*****-A3*** (1.8 kW and below)	Power cable	S6-L-B11-3.0	S6-L-B11-5.0	S6-L-B11-10.0
	Absolute encoder cable	S6-L-P21-3.0	S6-L-P21-5.0	S6-L-P21-10.0
ISMH3-*****-U1*** ISMH3-*****-U2*** (2.9 kW)	Power cable	Power cable: prepared by customer		
	Incremental encoder cable	S6-L-P01-3.0	S6-L-P01-5.0	S6-L-P01-10.0
ISMH3-*****-A3*** (2.9 kW)	Power cable	Power cable: prepared by customer		
	Absolute encoder cable	S6-L-P21-3.0	S6-L-P21-5.0	S6-L-P21-10.0
ISMH3-*****-U1*** ISMH3-*****-U2*** (above 2.9 kW)	Power cable	Power cable: prepared by customer		
	Incremental encoder cable	S6-L-P01-3.0	S6-L-P01-5.0	S6-L-P01-10.0
ISMH3-*****-A3*** (above 2.9 kW)	Power cable	Power cable: prepared by customer		
	Absolute encoder cable	S6-L-P21-3.0	S6-L-P21-5.0	S6-L-P21-10.0

Note

The servo motor encoder cable includes CN1 connector; if you select Inovance matching cables, the connector kit is not required.

■ **Connector Kit**

Motor Model	Connector Kit
ISMH1-*****-U1*** ISMH1-*****-U2*** ISMH4-*****-U1*** ISMH4-*****-U2***	S6-C1 Including: CN1 terminal, CN2 terminal, 6-pin connector, 9-pin connector
ISMH1-*****-A3*** ISMH4-*****-A3***	
ISMH2-*****-U1*** ISMH2-*****-U2***	S6-C2 Including: CN1 terminal, CN2 terminal, 20-18 military spec. plug (elbow), 20-29military spec. plug (elbow)
ISMH2-*****-A3***	
ISMH3-*****-U1*** ISMH3-*****-U2*** ISMH3-*****-A3*** (1.8 kW and below)	S6-C2 Including: CN1 terminal, CN2 terminal, 20-18military spec. plug (elbow), 20-29military spec. plug (elbow)
ISMH3-*****-U1*** ISMH3-*****-U2*** ISMH3-*****-A3*** (2.9 kW)	S6-C3 Including: CN1 terminal, CN2 terminal, 20-22military spec. plug (elbow), 20-29military spec. plug (elbow)
ISMH3-*****-U1*** ISMH3-*****-U2*** ISMH3-*****-A3*** (2.9 kW and above)	

Note

If you prepare cables yourself rather than use Inovance matching cables , the connector kit is required.

■ **Battery Kit of Absolute Encoder Motor**

If Inovance absolute encoder motor is used, the optional battery kit S6-C4 (battery, battery box) is required besides the matching cables.

Communication Cable

Cable Model	Description
S6N-L-T00-3.0	Servo drive to PC communication cable
S6-L-T04-0.3	Communication cable for multi-drive parallel connection
S6-L-T04-0.0	Servo drive to host controller communication cable

2.4 Connection Between Servo Drive and Servo Motor

Figure 2-4 Terminal arrangement of IS620N

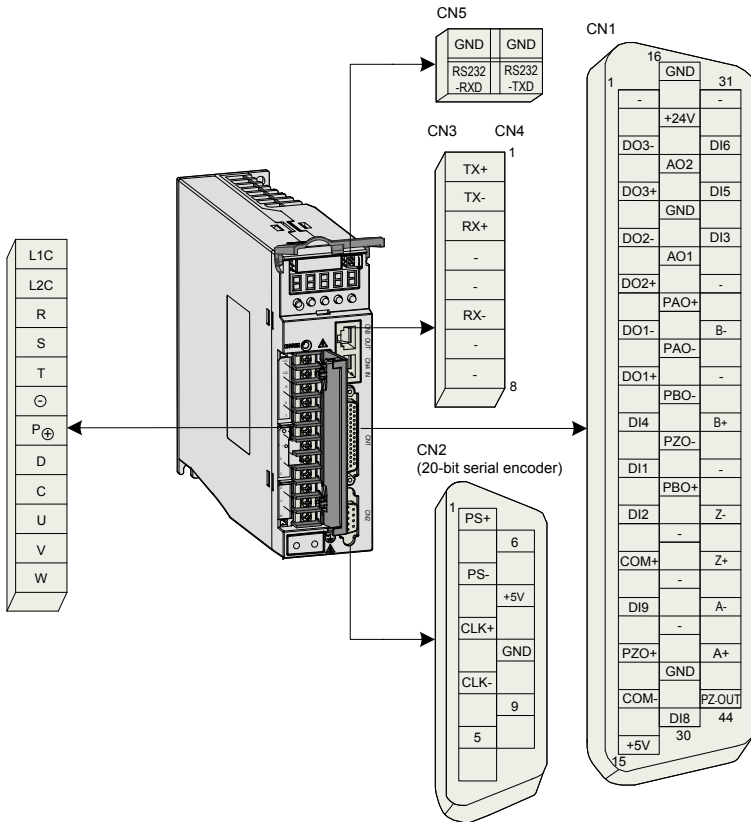

The preceding figure shows arrangement of the terminals in the servo drive.

2.4.1 Main Circuit

Figure 2-5 Terminal block arrangement of SIZE A (SIZE C)

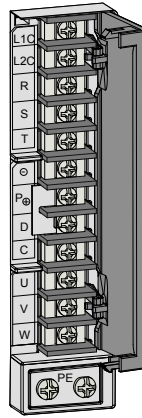

Table 2-1 Names and functions of main circuit terminals of SIZE A (SIZE C)

Terminal Symbol	Terminal Name	Terminal Function
L1, L2	Power input terminals	Single-phase power input. Connect 220 VAC power supply between L1 and L2 terminals.
R, S, T		Three-phase 220 V/380 V power input according to the nameplate.
L1C, L2C	Control power input terminals	Connect to control power input. For specific value, refer to the rated voltage on the nameplate.
P _⊕ , D, C	Terminals for connecting external regenerative resistor	Connect an external regenerative resistor between P _⊕ and C if the braking capacity is insufficient. The external regenerative resistor needs to be purchased additionally.
		Terminals P _⊕ and D are shorted by default. Remove the jumper between P _⊕ and D, and connect an external regenerative resistor between P _⊕ and C if the braking capacity is insufficient. The external regenerative resistor needs to be purchased additionally.
P _⊕ , ⊖	Common DC bus terminal	They are used for common DC bus connection when multiple servo drives are used in parallel.
U, V, W	Servo motor connection terminals	Connect to U, V and W phases of the servo motor.
PE	Ground	Two grounding terminals of the servo drive are respectively connected to those of the power supply and the servo motor. The entire system must be grounded.

Figure 2-6 Terminal block arrangement of SIZE E

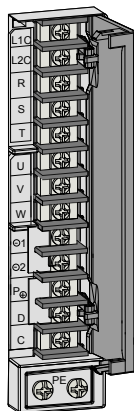
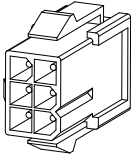
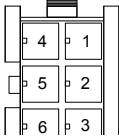
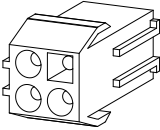



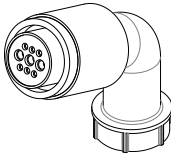

Table 2-2 Names and functions of main circuit terminals of SIZE E

Terminal Symbol	Terminal Name	Terminal Function
R, S, T	Main circuit power input terminals	Main circuit three-phase 380 V power input.
L1C, L2C	Control power input terminals	Connect to control power input. For specific value, refer to the rated voltage on the nameplate.
P _⓪ , D, C	Terminals for connecting external regenerative resistor	Terminals P _⓪ and D are shorted by default. Remove the jumper between P _⓪ and D, and connect an external regenerative resistor between P _⓪ and C if the braking capacity is insufficient. The external regenerative resistor needs to be purchased additionally.
P _⓪ , ⓪1 / ⓪2	Common DC bus terminal	They are used for common DC bus connection when multiple servo drives are used in parallel.
⓪1, ⓪2	Terminals for connecting external reactor	Terminals ⓪1 and ⓪2 are shorted by default. When the power harmonic current need to be restricted, remove the jumper and connect a reactor between ⓪1 and ⓪2.
U, V, W	Servo motor connection terminals	Connect to U, V and W phases of the servo motor.
PE	Ground	Two grounding terminals of the servo drive are respectively connected to those of the power supply and the servo motor. The entire system must be grounded.

Servo Motor Cables

Table 2-3 Connectors of cables on servo motor side

Connector Appearance	Pin Layout	Frame Size of Matching Motor																				
	<p>Black 6-pin connector</p>  <table border="1" data-bbox="552 341 848 544"> <thead> <tr> <th>Pin No.</th> <th>Signal</th> <th>Color</th> </tr> </thead> <tbody> <tr> <td>1</td> <td>U</td> <td>White</td> </tr> <tr> <td>2</td> <td>V</td> <td>Black</td> </tr> <tr> <td>4</td> <td>W</td> <td>Red</td> </tr> <tr> <td>5</td> <td rowspan="2">PE</td> <td>Yellow/ Green</td> </tr> <tr> <td>3</td> <td>Brake (regardless of positive or negative)</td> </tr> <tr> <td>6</td> <td></td> <td></td> </tr> </tbody> </table> <p>Recommendation: Plastic housing: MOLEX-50361736 Terminal: MOLEX-39000061</p>	Pin No.	Signal	Color	1	U	White	2	V	Black	4	W	Red	5	PE	Yellow/ Green	3	Brake (regardless of positive or negative)	6			<p>40 (Z series) 60 (Z series) 80 (Z series)</p>
Pin No.	Signal	Color																				
1	U	White																				
2	V	Black																				
4	W	Red																				
5	PE	Yellow/ Green																				
3		Brake (regardless of positive or negative)																				
6																						
	<p>4-pin connector</p>  <table border="1" data-bbox="479 724 855 876"> <thead> <tr> <th>Pin No.</th> <th>Signal</th> <th>Color</th> </tr> </thead> <tbody> <tr> <td>1</td> <td>U</td> <td>Blue</td> </tr> <tr> <td>2</td> <td>V</td> <td>Black</td> </tr> <tr> <td>3</td> <td>W</td> <td>Red</td> </tr> <tr> <td>4</td> <td>PE</td> <td>Yellow/Green</td> </tr> </tbody> </table> <p>Recommendation: Plastic housing: EL-4A (CWB) Terminal: 421.6003.0 (CWB)</p>	Pin No.	Signal	Color	1	U	Blue	2	V	Black	3	W	Red	4	PE	Yellow/Green	<p>40 (X series) 60 (X series) 80 (X series)</p>					
Pin No.	Signal	Color																				
1	U	Blue																				
2	V	Black																				
3	W	Red																				
4	PE	Yellow/Green																				

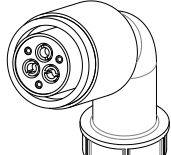
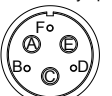
Connector Appearance	Pin Layout	Frame Size of Matching Motor																																						
	<p>MIL-DTL-5015 series 3108E20-18S military spec.</p> <p>20-18 military spec.</p>  <table border="1" data-bbox="336 414 862 678"> <thead> <tr> <th colspan="2">New Structure</th> <th colspan="2">Old Structure</th> <th rowspan="2">Color</th> </tr> <tr> <th>Pin No.</th> <th>Signal</th> <th>Pin No.</th> <th>Signal</th> </tr> </thead> <tbody> <tr> <td>B</td> <td>U</td> <td>B</td> <td>U</td> <td>Blue</td> </tr> <tr> <td>I</td> <td>V</td> <td>I</td> <td>V</td> <td>Black</td> </tr> <tr> <td>F</td> <td>W</td> <td>F</td> <td>W</td> <td>Red</td> </tr> <tr> <td>G</td> <td>PE</td> <td>G</td> <td>PE</td> <td>Yellow/ Green</td> </tr> <tr> <td>C</td> <td rowspan="2">Brake (regardless of positive or negative)</td> <td></td> <td></td> <td></td> </tr> <tr> <td>E</td> <td></td> <td></td> <td></td> </tr> </tbody> </table>	New Structure		Old Structure		Color	Pin No.	Signal	Pin No.	Signal	B	U	B	U	Blue	I	V	I	V	Black	F	W	F	W	Red	G	PE	G	PE	Yellow/ Green	C	Brake (regardless of positive or negative)				E				<p>100 130</p>
New Structure		Old Structure		Color																																				
Pin No.	Signal	Pin No.	Signal																																					
B	U	B	U	Blue																																				
I	V	I	V	Black																																				
F	W	F	W	Red																																				
G	PE	G	PE	Yellow/ Green																																				
C	Brake (regardless of positive or negative)																																							
E																																								
	<p>MIL-DTL-5015 series 3108E20-22S military spec.</p> <p>20-22 military spec.</p>  <table border="1" data-bbox="386 917 812 1197"> <thead> <tr> <th colspan="2">Y Series</th> <th colspan="2">Z Series</th> <th rowspan="2">Color</th> </tr> <tr> <th>Pin No.</th> <th>Signal</th> <th>Pin No.</th> <th>Signal</th> </tr> </thead> <tbody> <tr> <td>A</td> <td>U</td> <td>A</td> <td>U</td> <td>Blue</td> </tr> <tr> <td>C</td> <td>V</td> <td>C</td> <td>V</td> <td>Black</td> </tr> <tr> <td>E</td> <td>W</td> <td>E</td> <td>W</td> <td>Red</td> </tr> <tr> <td>F</td> <td>PE</td> <td>F</td> <td>PE</td> <td>Yellow/ Green</td> </tr> <tr> <td rowspan="2">D</td> <td>B</td> <td colspan="2" rowspan="2">Brake (regardless of positive or negative)</td> <td rowspan="2"></td> </tr> <tr> <td></td> </tr> </tbody> </table>	Y Series		Z Series		Color	Pin No.	Signal	Pin No.	Signal	A	U	A	U	Blue	C	V	C	V	Black	E	W	E	W	Red	F	PE	F	PE	Yellow/ Green	D	B	Brake (regardless of positive or negative)				<p>180</p>			
Y Series		Z Series		Color																																				
Pin No.	Signal	Pin No.	Signal																																					
A	U	A	U	Blue																																				
C	V	C	V	Black																																				
E	W	E	W	Red																																				
F	PE	F	PE	Yellow/ Green																																				
D	B	Brake (regardless of positive or negative)																																						

Note

1. Frame size of motor: indicates the width of motor flange.
2. The motor cable colors are subject to the actual. The cable colors mentioned in the manual are all Inovance cables.

2.4.2 Servo Motor Encoder

Serial Incremental Encoder

Figure 2-7 Example of connecting encoder signal cables

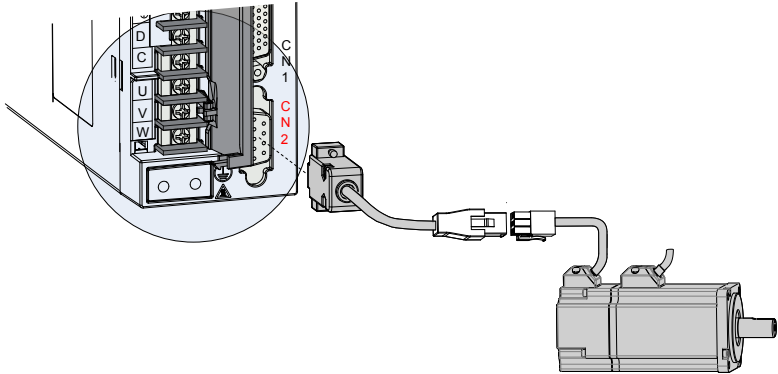

Note

The encoder cable colors are subject to the actual. The cable colors mentioned in the manual are all Inovance cables.

Table 2-4 Connectors of 20-bit encoder cables on servo drive side

Connector Appearance	Pin Layout													
		<table border="1"> <thead> <tr> <th>Pin No.</th> <th>Signal</th> </tr> </thead> <tbody> <tr> <td>1</td> <td>PS+</td> </tr> <tr> <td>2</td> <td>PS-</td> </tr> <tr> <td>7</td> <td>+5V</td> </tr> <tr> <td>8</td> <td>GND</td> </tr> <tr> <td>Housing</td> <td>PE</td> </tr> </tbody> </table> <p>Recommendation: Plastic housing of plug on cable side: DB9P (SZTDK), black housing Core: DB9P soldering plug (SZTDK), blue glue</p>	Pin No.	Signal	1	PS+	2	PS-	7	+5V	8	GND	Housing	PE
Pin No.	Signal													
1	PS+													
2	PS-													
7	+5V													
8	GND													
Housing	PE													

Table 2-5 Connectors of 20-bit encoder cables (9-pin connector)

Connector Appearance and Pin Layout		Frame Size of Matching Motor																																							
 <p>Connect to CN2 of the drive</p>		40 60 80																																							
 <p>Viewed from this side</p> <table border="1" data-bbox="162 550 431 742"> <thead> <tr> <th>Pin No.</th> <th>Signal</th> <th></th> </tr> </thead> <tbody> <tr> <td>3</td> <td>PS+</td> <td rowspan="2">Twisted-pair</td> </tr> <tr> <td>6</td> <td>PS-</td> </tr> <tr> <td>9</td> <td>+5V</td> <td></td> </tr> <tr> <td>8</td> <td>GND</td> <td></td> </tr> <tr> <td>7</td> <td>Shield</td> <td></td> </tr> </tbody> </table> <p>Recommendation: Plastic housing: AMP 172161-1 Terminal: AMP 770835-1</p>	Pin No.		Signal		3	PS+	Twisted-pair	6	PS-	9	+5V		8	GND		7	Shield		 <p>Viewed from this side</p> <table border="1" data-bbox="498 574 851 774"> <thead> <tr> <th>Pin No.</th> <th>Signal</th> <th>Color</th> <th></th> </tr> </thead> <tbody> <tr> <td>3</td> <td>PS+</td> <td>Yellow</td> <td rowspan="2">Twisted-pair</td> </tr> <tr> <td>6</td> <td>PS-</td> <td>Blue</td> </tr> <tr> <td>9</td> <td>+5V</td> <td>Red</td> <td></td> </tr> <tr> <td>8</td> <td>GND</td> <td>White</td> <td></td> </tr> <tr> <td>7</td> <td>Shield</td> <td></td> <td></td> </tr> </tbody> </table>	Pin No.	Signal	Color		3	PS+	Yellow	Twisted-pair	6	PS-	Blue	9	+5V	Red		8	GND	White		7	Shield	
Pin No.	Signal																																								
3	PS+	Twisted-pair																																							
6	PS-																																								
9	+5V																																								
8	GND																																								
7	Shield																																								
Pin No.	Signal	Color																																							
3	PS+	Yellow	Twisted-pair																																						
6	PS-	Blue																																							
9	+5V	Red																																							
8	GND	White																																							
7	Shield																																								

Table 2-6 Connectors of 20-bit encoder cables (MIL-DTL-5015 series 3108E20-29S military spec. plug)

Connector Appearance and Pin Layout		Frame Size of Matching Motor																																	
		<p>100</p> <p>130</p> <p>180</p>																																	
  <table border="1" data-bbox="156 622 448 782"> <thead> <tr> <th>Pin No.</th> <th>Signal</th> <th></th> </tr> </thead> <tbody> <tr> <td>A</td> <td>PS+</td> <td rowspan="5">Twisted-pair</td> </tr> <tr> <td>B</td> <td>PS-</td> </tr> <tr> <td>G</td> <td>+5V</td> </tr> <tr> <td>H</td> <td>GND</td> </tr> <tr> <td>J</td> <td>Shielded</td> </tr> </tbody> </table>	Pin No.		Signal		A	PS+	Twisted-pair	B	PS-	G	+5V	H	GND	J	Shielded	 <table border="1" data-bbox="504 638 862 790"> <thead> <tr> <th>Pin No.</th> <th>Signal</th> <th>Color</th> <th></th> </tr> </thead> <tbody> <tr> <td>A</td> <td>PS+</td> <td>Yellow</td> <td rowspan="5">Twisted-pair</td> </tr> <tr> <td>B</td> <td>PS-</td> <td>Blue</td> </tr> <tr> <td>G</td> <td>+5V</td> <td>Red</td> </tr> <tr> <td>H</td> <td>GND</td> <td>White</td> </tr> <tr> <td>J</td> <td>Shielded</td> <td></td> </tr> </tbody> </table>	Pin No.	Signal	Color		A	PS+	Yellow	Twisted-pair	B	PS-	Blue	G	+5V	Red	H	GND	White	J	Shielded
Pin No.	Signal																																		
A	PS+	Twisted-pair																																	
B	PS-																																		
G	+5V																																		
H	GND																																		
J	Shielded																																		
Pin No.	Signal	Color																																	
A	PS+	Yellow	Twisted-pair																																
B	PS-	Blue																																	
G	+5V	Red																																	
H	GND	White																																	
J	Shielded																																		

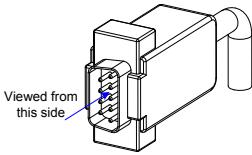
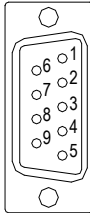
2

Table 2-7 Pin connection relation of IS620N series 20-bit encoder cables

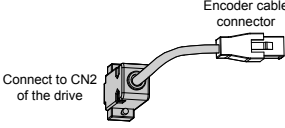
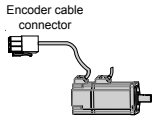
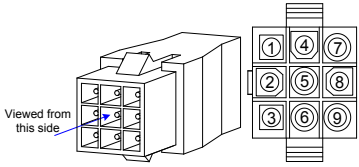
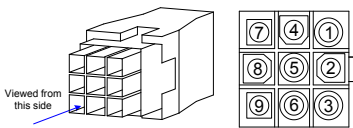
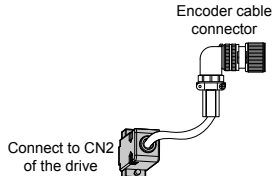
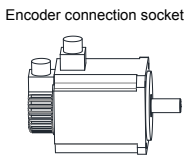
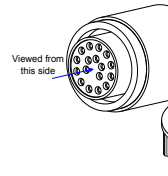
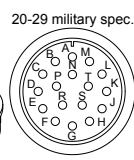
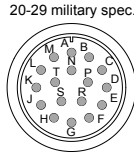
DB9 on Servo Drive Side		Function Description	Motor Side	
Signal	Pin No.		9-pin Pin No.	20-29 Military Spec. Pin No.
PS+	1	Serial communication signal +	3	A
PS-	2	Serial communication signal -	6	B
+5V	7	Encoder +5V power supply	9	G
GND	8	Encoder +5V power ground	8	H
PE	Housing	Shield	7	J

Observe the following precautions when wiring the encoder:

- Ground the servo drive and shielded layer of the servo motor reliably. Otherwise, the servo drive will report a false alarm.
- Do not connect cables to the reserved pins.
- To determine the length of the encoder cable, consider voltage drop caused by the cable resistance and signal attenuation caused by the distributed capacitance. It is recommended to use twisted-pair cable of size 26AWG or above (as per UL2464 standard) and with a length within 10 m.

Table 2-8 Recommended cable sizes

Cable Size	Ω/km	Allowed Cable Length (m)
26AWG (0.13 mm ²)	143	10.0
25AWG (0.15 mm ²)	89.4	16.0

Cable Size	Ω/km	Allowed Cable Length (m)
24AWG (0.21 mm ²)	79.6	18.0
23AWG (0.26 mm ²)	68.5	20.9
22AWG (0.32 mm ²)	54.3	26.4

Note

If the cables of above 22AWG are required, contact Inovance.

Absolute Encoder

Figure 2-8 Signal and battery wiring example of absolute encoder

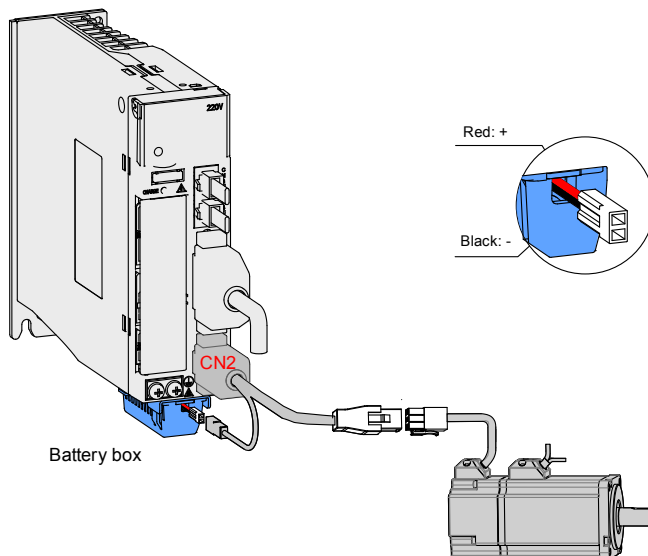
**Note**

Store the battery box in required ambient temperature and ensure the battery is in reliable contact and has sufficient capacity to avoid position information loss of the encoder.

Table 2-9 Battery description for absolute encoder

Battery Spec.	Item	Rating			Condition
		Min.	Common	Max.	
Output: 3.6 V, 2500 mAh	External battery voltage (V)	3.2	3.6	5	In standby mode (Note 2)
	Circuit fault voltage (V)		2.6		In standby mode
	Battery alarm voltage (V)	2.85	3	3.15	
Recommended manufacturer and model: Shenzhen Jieshun, LS14500	Battery consumption circuit (uA)		2		During normal operation (Note 1)
			10		In standby mode, axis static
		80		In standby mode, axis rotating	
	Battery use temperature (°C)	0		40	Same as motor ambient temperature
Battery storage temperature (°C)	-20		60		

The preceding data is measured in the 20°C ambient temperature.

■ Precautions of Battery Box

Er.731 (encoder battery fault) is tripped when the battery is connected for the first time. Set 200D-15h to 1 to reset the fault and perform the homing operation.

When the detected battery voltage is smaller than 3.0 V, Er.730 (encoder battery warning) is tripped. Replace the battery as follows:

Step 1. Power on the servo drive, and make it in non-running state.

Step 2. Replace the battery (every two years).

Step 3. The servo drive automatically resets Er.730. If there is no other warning, run the servo drive in normal state.

After power-off of the servo drive, if you replace the battery and power on the servo drive again, Er.731 occurs and an abrupt change occurs in the multi-turn data. Set 200D-15h to 1 to reset the fault and perform the homing operation again.

During power-off of the servo drive, ensure the maximum motor speed does not exceed 6000 RPM so that the encoder position can be recorded correctly.

Store the battery in required temperature and ensure reliable contact and sufficient electricity. Failure to comply may cause loss of the encoder position.

Table 2-10 Connectors of absolute encoder cables (9-pin connector)

Connector Appearance and Pin Layout		Frame Size of Matching Motor																																											
		40 60 80																																											
 <table border="1"> <thead> <tr> <th>Pin No.</th> <th>Signal</th> <th></th> </tr> </thead> <tbody> <tr> <td>1</td> <td>Battery+</td> <td rowspan="9" style="text-align: center; vertical-align: middle;">Twisted-pair</td> </tr> <tr> <td>4</td> <td>Battery-</td> </tr> <tr> <td>3</td> <td>PS+</td> </tr> <tr> <td>6</td> <td>PS-</td> </tr> <tr> <td>9</td> <td>+5V</td> </tr> <tr> <td>8</td> <td>GND</td> </tr> <tr> <td>7</td> <td>Shield</td> </tr> </tbody> </table> <p>Recommendation: Plastic housing: AMP 172161-1 Terminal: AMP 770835-1</p>	Pin No.		Signal		1	Battery+	Twisted-pair	4	Battery-	3	PS+	6	PS-	9	+5V	8	GND	7	Shield	 <table border="1"> <thead> <tr> <th>Pin No.</th> <th>Signal</th> <th>Color</th> <th></th> </tr> </thead> <tbody> <tr> <td>1</td> <td>Battery+</td> <td>Blue</td> <td rowspan="9" style="text-align: center; vertical-align: middle;">Twisted-pair</td> </tr> <tr> <td>4</td> <td>Battery-</td> <td>Blue black</td> </tr> <tr> <td>3</td> <td>PS+</td> <td>Yellow</td> </tr> <tr> <td>6</td> <td>PS-</td> <td>Yellow black</td> </tr> <tr> <td>9</td> <td>+5V</td> <td>Red</td> </tr> <tr> <td>8</td> <td>GND</td> <td>Black</td> </tr> <tr> <td>7</td> <td>Shield</td> <td></td> </tr> </tbody> </table>	Pin No.	Signal	Color		1	Battery+	Blue	Twisted-pair	4	Battery-	Blue black	3	PS+	Yellow	6	PS-	Yellow black	9	+5V	Red	8	GND	Black	7	Shield
Pin No.	Signal																																												
1	Battery+	Twisted-pair																																											
4	Battery-																																												
3	PS+																																												
6	PS-																																												
9	+5V																																												
8	GND																																												
7	Shield																																												
Pin No.	Signal		Color																																										
1	Battery+		Blue	Twisted-pair																																									
4	Battery-	Blue black																																											
3	PS+	Yellow																																											
6	PS-	Yellow black																																											
9	+5V	Red																																											
8	GND	Black																																											
7	Shield																																												

Table 2-11 Connectors of absolute encoder cables (MIL-DTL-5015 series 3108E20-29S military spec. plug)

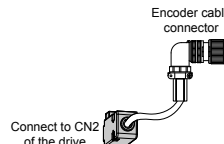
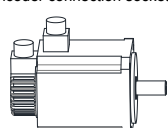
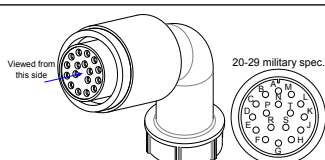
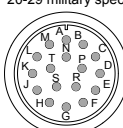
Connector Appearance and Pin Layout		Frame Size of Matching Motor																																																						
 <p>Encoder cable connector</p>	 <p>Encoder connection socket</p>	<p>100 130 180</p>																																																						
 <p>Viewed from this side</p> <p>20-29 military spec.</p> <table border="1" data-bbox="134 598 431 829"> <thead> <tr> <th>Pin No.</th> <th>Signal</th> <th></th> </tr> </thead> <tbody> <tr> <td>A</td> <td>PS+</td> <td rowspan="2">Twisted-pair</td> </tr> <tr> <td>B</td> <td>PS-</td> </tr> <tr> <td>E</td> <td>Battery+</td> <td></td> </tr> <tr> <td>F</td> <td>Battery-</td> <td></td> </tr> <tr> <td>G</td> <td>+5V</td> <td></td> </tr> <tr> <td>H</td> <td>GND</td> <td></td> </tr> <tr> <td>J</td> <td>Shield</td> <td></td> </tr> </tbody> </table>	Pin No.	Signal		A	PS+	Twisted-pair	B	PS-	E	Battery+		F	Battery-		G	+5V		H	GND		J	Shield		 <p>20-29 military spec.</p> <table border="1" data-bbox="498 630 862 829"> <thead> <tr> <th>Pin No.</th> <th>Signal</th> <th>Color</th> <th></th> </tr> </thead> <tbody> <tr> <td>A</td> <td>PS+</td> <td>Yellow</td> <td rowspan="2">Twisted-pair</td> </tr> <tr> <td>B</td> <td>PS-</td> <td>Yellow black</td> </tr> <tr> <td>E</td> <td>Battery+</td> <td>Blue</td> <td></td> </tr> <tr> <td>F</td> <td>Battery-</td> <td>Blue black</td> <td></td> </tr> <tr> <td>G</td> <td>+5V</td> <td>Red</td> <td></td> </tr> <tr> <td>H</td> <td>GND</td> <td>Black</td> <td></td> </tr> <tr> <td>J</td> <td>Shield</td> <td></td> <td></td> </tr> </tbody> </table>	Pin No.	Signal	Color		A	PS+	Yellow	Twisted-pair	B	PS-	Yellow black	E	Battery+	Blue		F	Battery-	Blue black		G	+5V	Red		H	GND	Black		J	Shield			<p>100 130 180</p>
Pin No.	Signal																																																							
A	PS+	Twisted-pair																																																						
B	PS-																																																							
E	Battery+																																																							
F	Battery-																																																							
G	+5V																																																							
H	GND																																																							
J	Shield																																																							
Pin No.	Signal	Color																																																						
A	PS+	Yellow	Twisted-pair																																																					
B	PS-	Yellow black																																																						
E	Battery+	Blue																																																						
F	Battery-	Blue black																																																						
G	+5V	Red																																																						
H	GND	Black																																																						
J	Shield																																																							

Note

- During normal operation, the absolute encoder supports one-turn or multi-turn data counting and transmitting/receiving. After connecting the absolute encoder properly, turn on the power to the servo drive, and the encoder enters normal operation state and transmits/receives data after a delay of 5s.
When the encoder switches from standby state to normal operation state (power turned on), the motor speed must not exceed 10 RPM. Otherwise, the servo drive reports Er.740, and you need to power on the servo drive again.
- Standby state: The servo drive is not powered on, and the external battery is used for multi-turn data counting. In this case, data transmitting/receiving is not performed.

2.4.3 Control Signal Terminal Connector CN1

Figure 2-9 Pin layout of control circuit terminal connector of servo drive

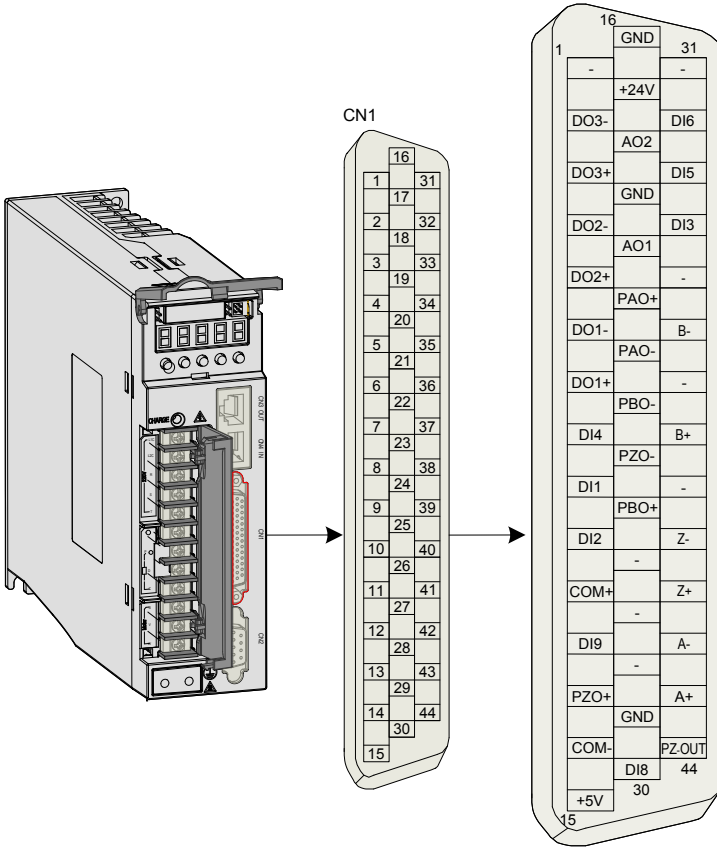

DI/DO Signals

Table 2-12 DI/DO signal description

Signal	Default Function	Pin No.	Function Description	
General	DI1	P-OT	9	Forward limit switch
	DI2	N-OT	10	Reverse limit switch
	DI3	INHIBIT	34	Pulse input inhibited
	DI4	ALM-RST	8	Alarm reset (edge valid)
	DI5	ZCLAMP	32	Zero speed clamp

Signal	Default Function	Pin No.	Function Description	
General	DI6	GAIN-SEL	31	Gain switchover
	DI8	TouchProbe	32	Touch probe function
	DI9	HomeSwitch	30	Home switch
		+24V	17	Internal 24 V power supply, voltage range: 20 to 28 V, maximum output current: 200 mA
		COM-	14	
		COM+	11	Power input (12 to 24 V)
	DO1+	S-RDY+	7	Servo ready
	DO1-	S-RDY-	6	
	DO2+	COIN+	5	Position reached
	DO2-	COIN-	4	
	DO3+	ALM+	3	Fault output
DO3-	ALM-	2		

Fully Closed-loop Feedback Signals

The following part describes the input terminals of the external encoder.

Table 2-13 Fully closed-loop feedback signals

Signal	Pin No.	Function
External encoder	A+	43
	A-	42
	B+	38
	B-	36
	Z+	41
	Z-	40

Input signals of external encoder

Encoder Frequency-Division Signals

Table 2-14 Encoder frequency-division output signal specifications

Signal	Default Function	Pin No.	Function Description	
General	PAO+	21	Phase A output signal	
	PAO-	22		
	PBO+	25	Phase B output signal	
	PBO-	23		
	PZO+	13	Phase Z output signal	
	PZO-	24		
	PZ-OUT	44	Phase Z output signal	Home pulse OC output signal
	GND	29	Home pulse OC output signal ground	
+5V	15	5 V internal power supply		
GND	16	Maximum output current: 200 mA		
PE	Housing			

The encoder frequency-division output circuit outputs OC signals via the differential drive. Generally, it provides feedback signals to the host controller in the closed-loop position control system. A differential or optocoupler circuit shall be used in the host controller to receive feedback signals. The maximum output current is 20 mA.

2.4.4 Communication Signal Terminal Connectors CN3/CN4

The CN3/CN4 terminal connectors are EtherCAT network ports, where CN4(IN) is connected to the host controller, and CN3(OUT) is connected to the next slave.

Table 2-15 Pin definition of communication signal terminal connectors CN3/CN4

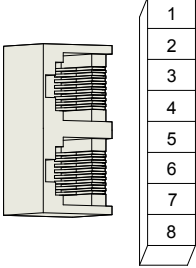
Pin No.	Pin	Description	Pin Layout
1	TX+	Data transmit+	
2	TX-	Data transmit-	
3	RX+	Data receive+	
4	-		
5	-		
6	RX-	Data receive-	
7	-	-	
8	-	-	
Housing	PE	Shield	

2.4.5 Communication Signal Terminal Connector CN5

The following figure shows pin layout of the terminal connector CN5 for background communication and online upgrade.

2

Figure 2-10 CN5 connector

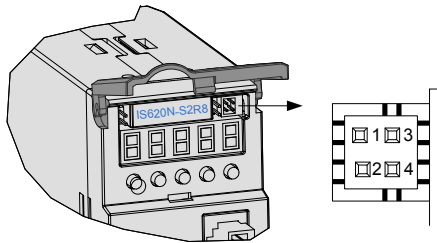

Table 2-16 Pin definition of connector CN5

No.	Pin	Description
1	GND	Reference ground
2	RS232-RXD	RS232 signal receive end
3	GND	Reference ground
4	RS232-TXD	RS232 signal transmit end

Chapter 3 Operation and Display

3.1 Introduction to Keypad

Figure 3-1 Diagram of the keypad

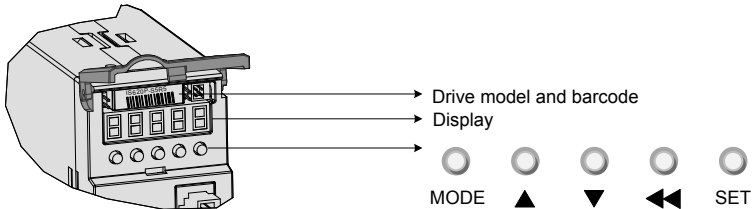

The keypad on the servo drive consists of the 5-digit 7-segment LEDs and keys. The keypad is used for display, parameter setting, user password setting and general functions operations. When the keypad is used for parameter setting, the functions of the keys are described as follows.

Table 3-1 Functions of keys on the keypad

Key Name	Function Description
MODE	Switch between all modes. Return to the upper-level menu.
UP	Increase the number indicated by the blinking digit.
DOWN	Decrease the number indicated by the blinking digit.
SHIFT	Shift the blinking digit. View the high digits of the number consisting of more than 5 digits.
SET	Switch to the next-level menu. Execute commands such as storing parameter setting value.

3

3.2 Keypad Display

The keypad can display the running status, parameter, faults, and monitored information during running of the servo drive.

- Status display: Displays the current servo drive status, such as servo ready or running.
- Parameter display: Displays function codes and their values.
- Fault display: Displays the fault and warnings occurring in the servo drive.
- Monitoring display: Displays the current running parameters of the servo drive.

3.2.1 Conversion Between Keypad Display and Host Controller Operation Objects

The mapping relationship between the parameter No. (decimal) displayed on the keypad and the object dictionary operated on the host controller (hexadecimal, "index" and "sub-index") is as follows:

Object dictionary index = 0x2000 + parameter group No.

Object dictionary sub-index = hexadecimal offset in the parameter group No. + 1

Keypad Display	Object Dictionary Operated on the Host Controller
H00-00	2000-01h
H00-01	2000-02h
.....
H01-09	2001-0Ah
H01-10	2001-0Bh
.....
H02-15	2002-10h

The following parts only describes parameter display and setting on the keypad, and you need to make conversion when performing operations through commissioning software on the host controller.

3.2.2 Display Switchover

Figure 3-2 Switching between different display

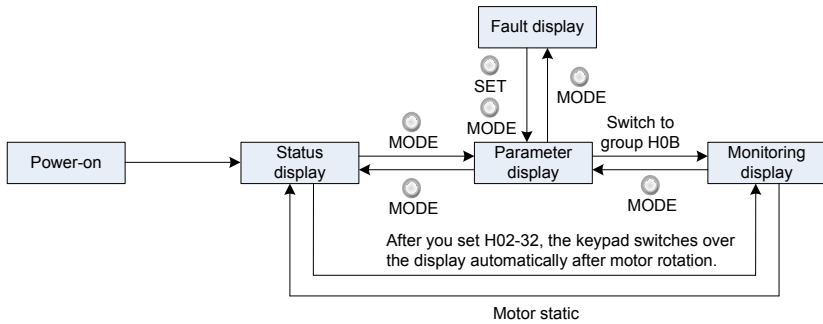

- After the power is on, the keypad enters the status display mode.
- Press key MODE to switch over between different modes, as shown in the preceding figure.
- In status display mode, set 2002-21h and select the monitored parameters. When the motor rotates, the keypad automatically switches over to monitoring display. After the motor becomes stopped, the keypad automatically restores to status display.
- In parameter display mode, set 2002-21h and select the parameters to be monitored, and the keypad switches over to the monitoring display mode.
- Once a fault occurs, the keypad immediately enters the fault display mode, and all 5-digit LEDs blink. Press key SET to stop blinking, and then press key MODE to switch over to the parameter display mode.

3.3 Parameter Setting

There are two methods of setting parameters:

- On the host controller (preferred)
- Via the keypad

Note that parameters are set in hexadecimal on the host controller, and in decimal on the keypad.

For details on the parameters, refer to the IS620N Advanced User Guide. The following figure shows the keypad operation of switching the position control mode to the speed control mode after the power is on.

Figure 3-3 Keypad operation of parameter setting

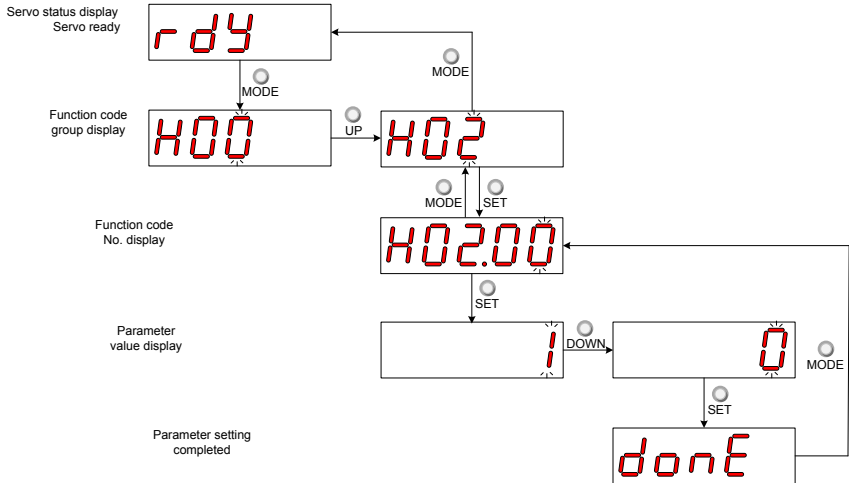

- MODE: Switch the display mode and return to the upper-level menu.
- UP/DOWN: Increase or decrease the value of the current blinking digit.
- SHIFT: Shifting the blinking digit.
- SET: Store the current setting value or switch to the next-level menu.

After parameter setting is completed, that is, "Done" is displayed, press key MODE to return to the parameter group display (H02-00).

3.4 User Password

After the user password function (H02-30) is enabled, only the authorized user has the parameter setting rights; other operations can only view the parameters.

Setting User Password

The following figure shows the operation procedure of setting the password to "00001".

Figure 3-4 Keypad operation of user password setting

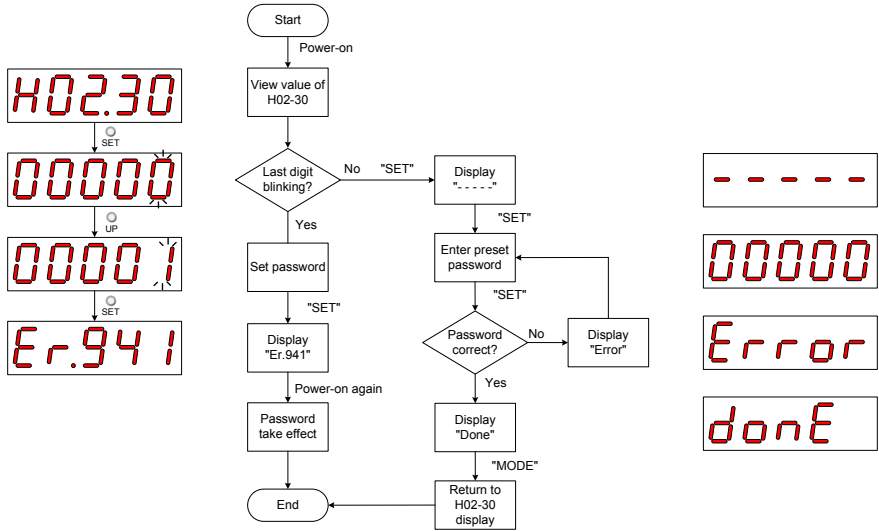

Note

*1: If the last digit does not blink, password protection is enabled. If the last digit blinks, password protection is disabled or the correct password has been entered. When modifying the user password, enter the correct password so that you have the rights of parameter setting. Enter H02-30 again, and you can set a new password according to the method described in the preceding figure.

Canceling User Password

Enter the existing user password, and set H02-30 to "00000". Then, the user password is cancelled.

Chapter 4 Quick Setup

4.1 Inovance PLC AM600 as Master

The AM600 EtherCAT master can control a single or multiple IS620N servo drives. The following part separately describes how to control a single and two IS620N servo drives.

4.1.1 Controlling a Single Drive

1. Start the software, and create an AM600 project. Select AM600-CPU1608TP.

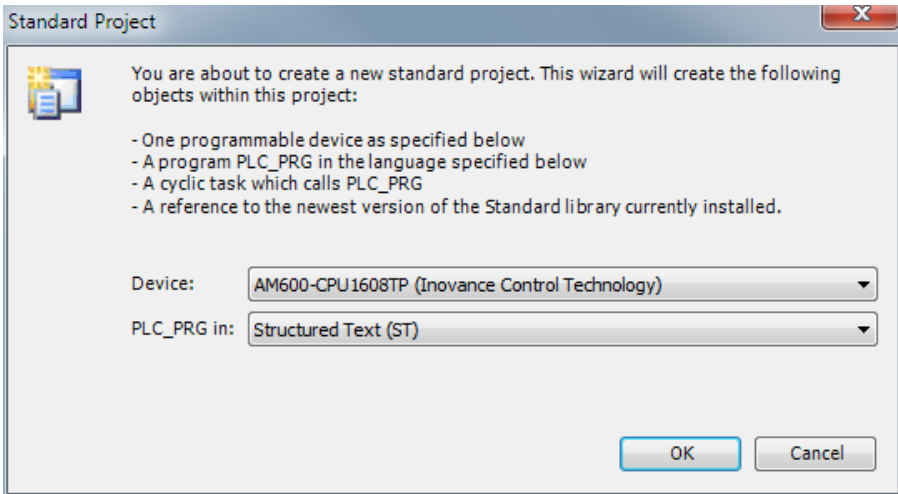

2. Add an IS620N slave. Open Network Configuration, and add a slave.

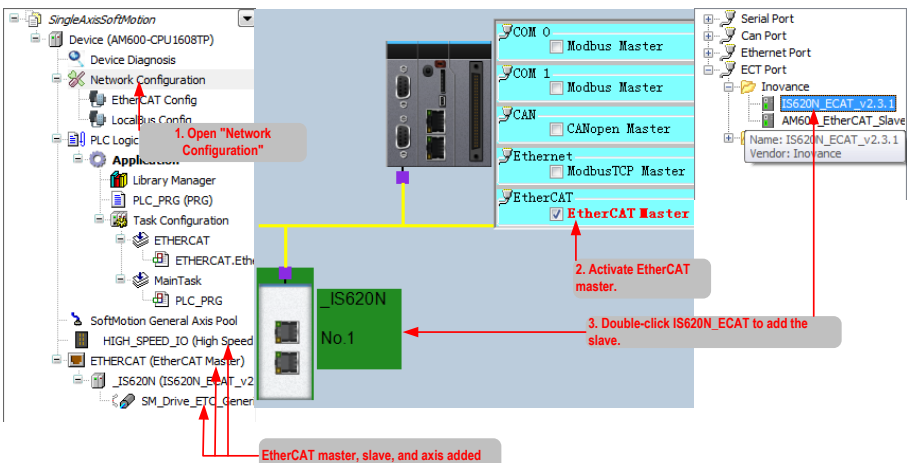

3. Add a program for controlling IS620N axis position motion.

Right-click Application, and select Add Object > POU.

In the dialog box displayed, enter the program name, select Program, and select Structured Text (ST).

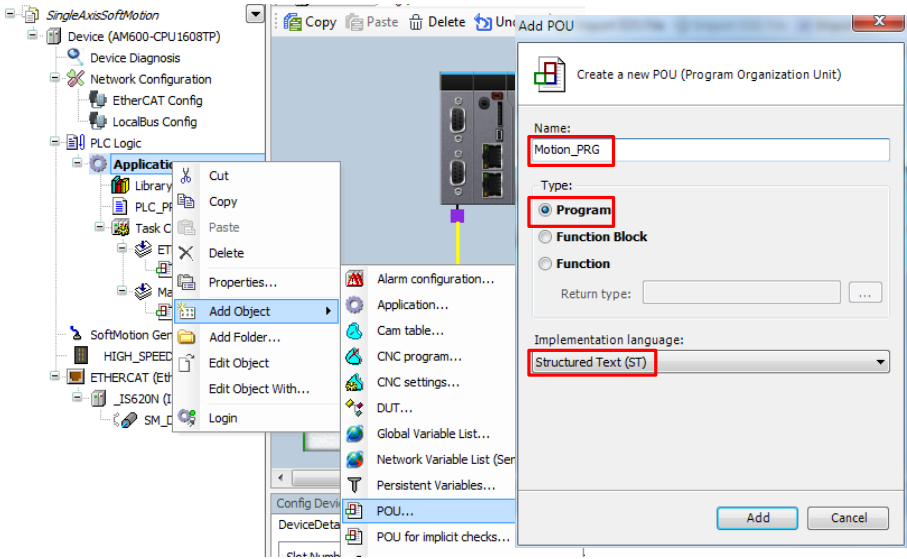

4. Compile the statements for controlling the axis directional motion.

```

1  PROGRAM Motion_PRG
2  VAR
3      iStatus: INT := 0;
4      Power1: MC_Power;
5      MoveAbsolute: MC_MoveAbsolute;
6  END_VAR
7
8  CASE iStatus OF
9      0://Axis powered on
10     Power1(Axis := SM_Drive_ETC_GenericDSP402, Enable := TRUE, bRegulatorOn := TRUE, bDriveStart := TRUE);
11     IF Power1.Status THEN//Move to next step if axis powered on succeeded
12         iStatus := iStatus + 1;
13     END_IF
14     1://Axis moves to position of 1000 unit with speed of 200 unit
15     MoveAbsolute(Axis := SM_Drive_ETC_GenericDSP402, Execute := TRUE, Position := 1000,
16         Velocity := 200, Acceleration := 200, Deceleration := 200);
17     IF MoveAbsolute.Done THEN//Move to next step if movement completed
18         iStatus := iStatus + 1;
19         MoveAbsolute(Axis := SM_Drive_ETC_GenericDSP402, Execute := FALSE);//Reset movement status
20     END_IF
21     2://Axis moves to position of 2000 unit with speed of 400 unit
22     MoveAbsolute(Axis := SM_Drive_ETC_GenericDSP402, Execute := TRUE, Position := 2000,
23         Velocity := 400, Acceleration := 200, Deceleration := 200);
24     IF MoveAbsolute.Done THEN//Move to next step if movement completed
25         iStatus := iStatus + 1;
26         MoveAbsolute(Axis := SM_Drive_ETC_GenericDSP402, Execute := FALSE);//Reset movement status
27     END_IF
28     3://Axis moves to position of 0 unit with speed of 1000 unit
29     MoveAbsolute(Axis := SM_Drive_ETC_GenericDSP402, Execute := TRUE, Position := 0,
30         Velocity := 1000, Acceleration := 200, Deceleration := 200);
31     IF MoveAbsolute.Done THEN//Move to next step if movement completed
32         iStatus := iStatus + 1;
33         MoveAbsolute(Axis := SM_Drive_ETC_GenericDSP402, Execute := FALSE);//Reset movement status
34     END_IF
35 END_CASE

```

a. The system provides the motion control library (motion control commands) for you to compile the motion control program. You can add the motion control commands via the Input Assistant.

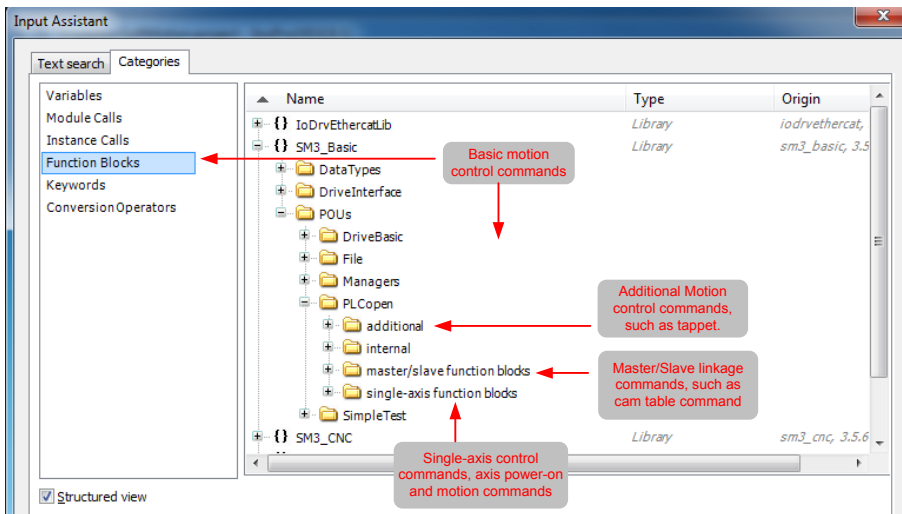

b. When the slave is added, the servo axis in the program is automatically added. A function block instance with the same axis name is also added, as displayed in the Input Assistant.

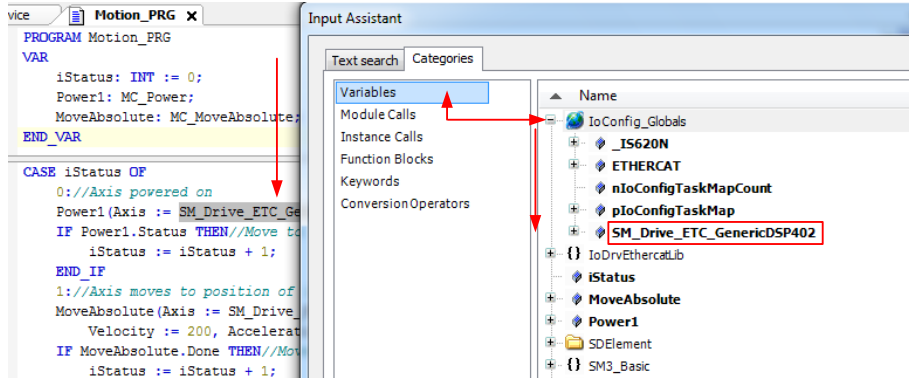

Function Description

In state 0, the axis is powered on through function block MC_POWER instance Power1. The axis enters state 1 after power-on.

In state 1, the axis moves to 1000 unit position at 200 unit speed through function block MC_MoveAbsolute instance MoveAbsolute. After moving to the target position, the axis enters state 2.

In state 2, the axis moves to 2000 unit position at 400 unit speed through function block MC_MoveAbsolute instance MoveAbsolute. After moving to the target position, the axis enters state 3.

In state 3, the axis moves to 0 unit position at 1000 unit speed through function block MC_MoveAbsolute instance MoveAbsolute. After moving to the target position, the axis enters state 1. The axis moves in this procedure cyclically. "unit" (position, velocity, acceleration/deceleration) involved in the function block will be described in the IS620N servo axis parameters in step 5.

5. Configure the IS620N servo axis parameters.

The axis configuration interface includes two tabs, basic configuration and scaling/mapping configuration.

On the basic configuration tab page, the axis type, curve, and min and max position limits can be configured. On the scaling/mapping tab page, the scaling relationship between increment, motor turns, gear output turns, and units in application can be configured.

Basic configuration tab page:

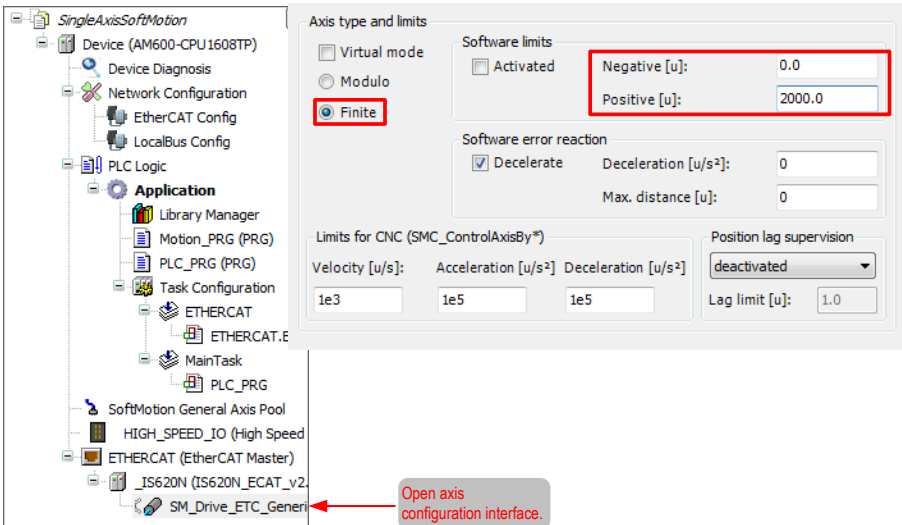

The axis in linear movement, the maximum position is 2000.

Scaling/Mapping tab page:

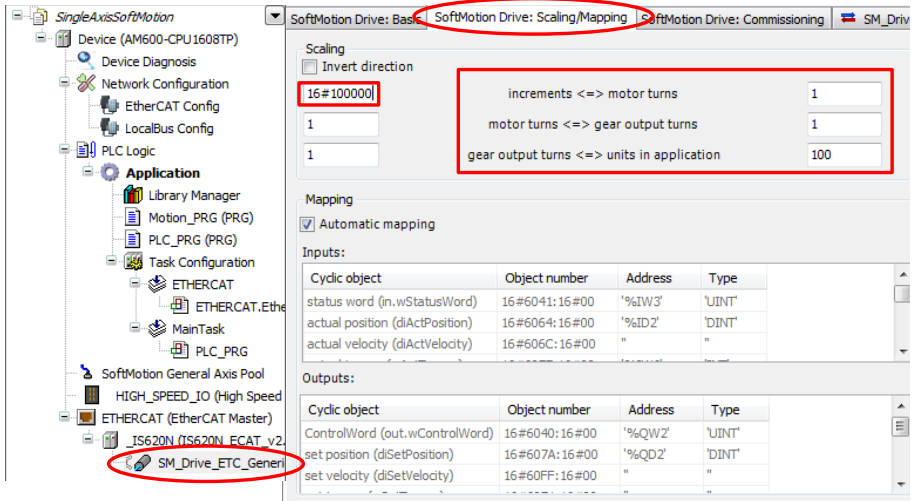

In this example, the ratio of pulse increment and motor revolutions is 16#100000:1, that is, the pulses per each revolution is 100000 in hexadecimal, which must be consistent with the encoder PPR. The ratio of each revolution and gear ratio is 1:1. The relationship between gear ratio and unit in the applicable is 1:100, that is, 100 units in the program corresponds to 1 servo drive revolution, 1 gear output, and 16#100000 output pulses.

6. Add the axis control program to the EtherCAT task configuration.

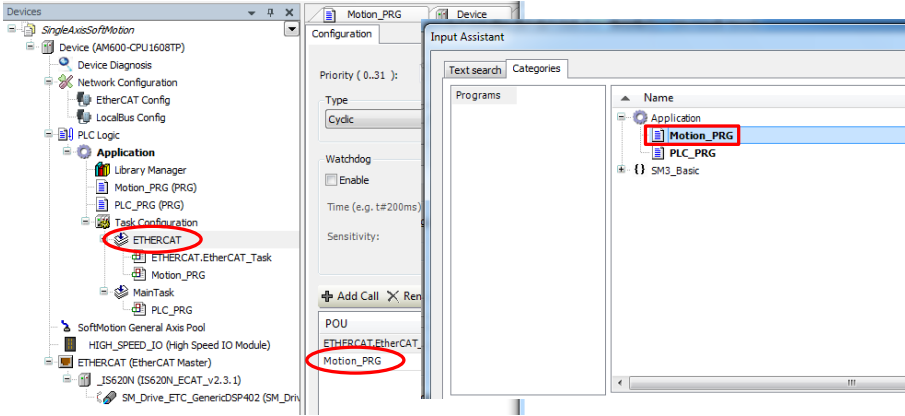

7. Download the program and perform commissioning.

The program takes effect after being downloaded to the PLC and run.

Step 1. On the Device interface, scan the PLC, and select the PLC for downloading.

Step 2. Click the download icon.

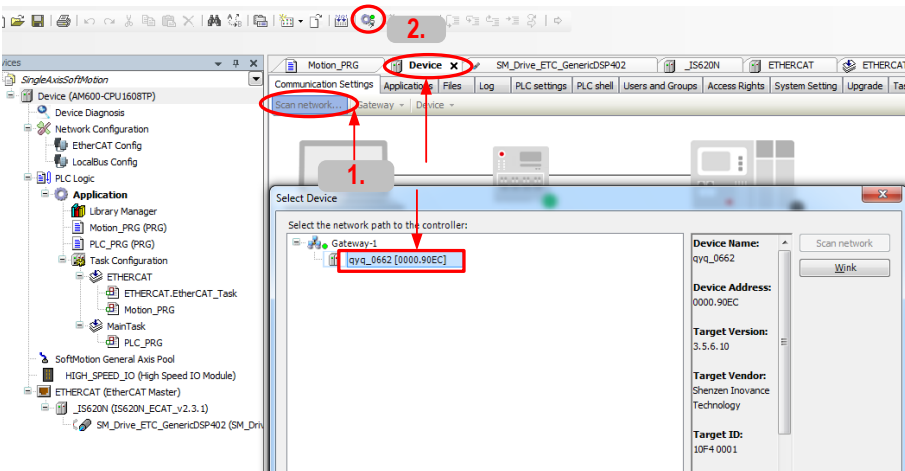

After downloading, the axis running status can be viewed on the axis basic configuration tab page.

The master, slave and axis are in normal running state if indicated by green circle.

Display running status of the axis.

variable	set value	actual value
Position [u]	777.60	792.30
Velocity [u/s]	-557.71	-636.72
Acceleration [u/s ²]	200.00	17935.04
Torque [Nm]	0.00	0.00

On the programming interface, you can also see the instance value of the online motion control function block .

```

CASE iStatus[1] OF
0://Axis powered on
Power1(Axis := SM_Drive_ETC_GenericDSP402, Enable[TRUE] := TRUE, bRegulatorOn[TRUE] := TRUE, bDriveStart[TRUE] := TRUE);
IF Power1.Status[TRUE] THEN//Move to next step if axis powered on succeeded
iStatus[1] := iStatus[1] + 1;
END_IF
1://Axis moves to position of 1000 unit with speed of 200 unit
MoveAbsolute(Axis := SM_Drive_ETC_GenericDSP402, Execute[TRUE] := TRUE, Position[1E+03] := 1000,
Velocity[200] := 200, Acceleration[200] := 200, Deceleration[200] := 200);
IF MoveAbsolute.Done[FALSE] THEN//Move to next step if movement completed
iStatus[1] := iStatus[1] + 1;
MoveAbsolute(Axis := SM_Drive_ETC_GenericDSP402, Execute[TRUE] := FALSE);//Reset movement status
END_IF
2://Axis moves to position of 2000 unit with speed of 400 unit
MoveAbsolute(Axis := SM_Drive_ETC_GenericDSP402, Execute[TRUE] := TRUE, Position[1E+03] := 2000,
Velocity[400] := 400, Acceleration[200] := 200, Deceleration[200] := 200);
IF MoveAbsolute.Done[FALSE] THEN//Move to next step if movement completed
iStatus[1] := iStatus[1] + 1;
MoveAbsolute(Axis := SM_Drive_ETC_GenericDSP402, Execute[TRUE] := FALSE);//Reset movement status
END_IF
3://Axis moves to position of 0 unit with speed of 1000 unit
MoveAbsolute(Axis := SM_Drive_ETC_GenericDSP402, Execute[TRUE] := TRUE, Position[1E+03] := 0,
Velocity[1000] := 1000, Acceleration[200] := 200, Deceleration[200] := 200);
IF MoveAbsolute.Done[FALSE] THEN//Move to next step if movement completed
iStatus[1] := 1;
MoveAbsolute(Axis := SM_Drive_ETC_GenericDSP402, Execute[TRUE] := FALSE);//Reset movement status
END_IF
END_CASE RETURN

```

Analysis on the axis control program based on step 5:

The program includes three states. In state 1, the axis moves for 1000 unit, $1000/100 = 10$ revolutions, $1000/200 = 5$ seconds; in state 2, also 10 revolutions, $1000/400 = 2.5$ seconds; in state 3, 20 revolutions, $2000/1000 = 2$ seconds.

4.1.2 Controlling Two Drives

1. Start the software, and create an AM600 project.

Choose Project > Standard Project. Select AM600-CPU1608TP from the Device drop-down list, and click OK. As the same step with the Controlling a Single Drive.

2. Add two IS620N slaves. Open Network Configuration, and add two slaves.

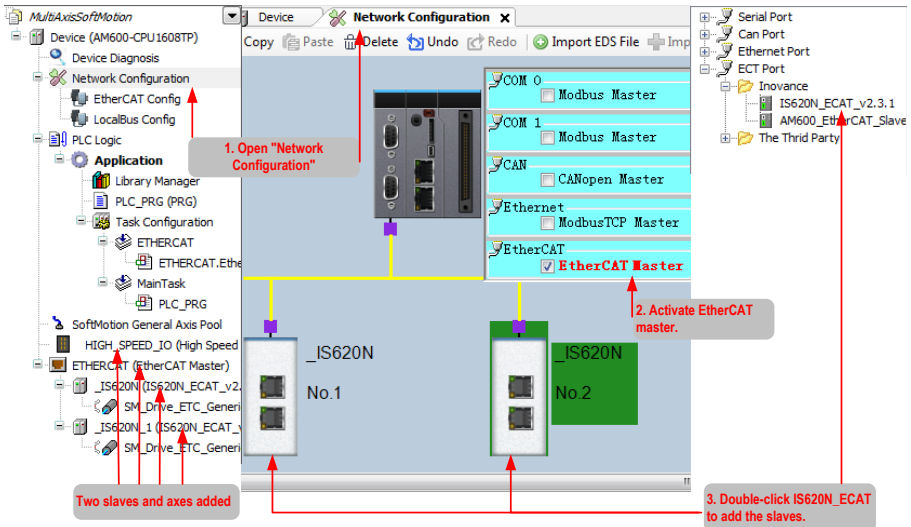

The SM_Drive_GenericDSP402 axis of the _IS620N slave is the master axis; the SM_Drive_GenericDSP402_1 axis of the _IS620N_1 slave is the slave axis; the master axis controls the motion curve of the slave axis.

3. Add a cam for controlling the axis motion relationship of two drives.

Right-click Application, and select Add Object > Cam table. In the dialog box displayed, enter the name of the cam table.

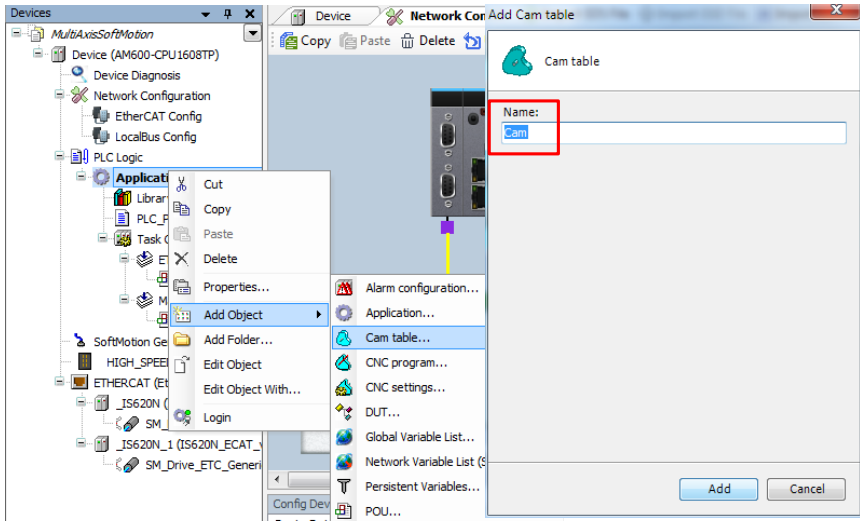

4. Add the cam table.

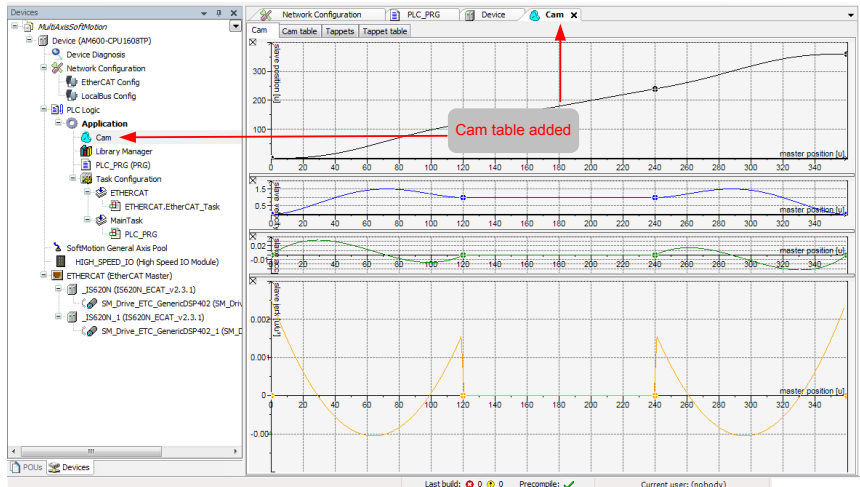

5. Set the attributes of the cam table.

Right-click Cam, and select Properties. In the dialog box displayed, set the start and end positions of the master and slave on the Cam tab page.

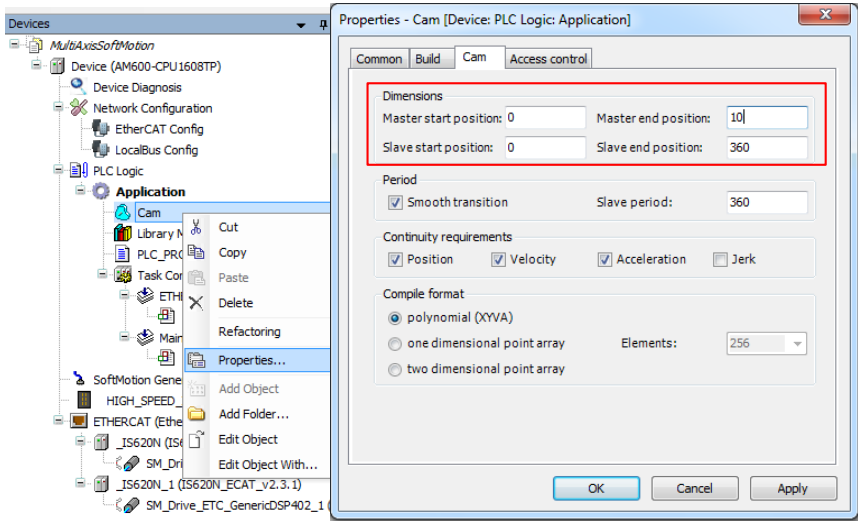

The attributes of the cam table include master/slave axis start position and cycle.

6. Set the master/slave axis control curve of the cam table. Add control points for the cam table and select the curve type between two control points.

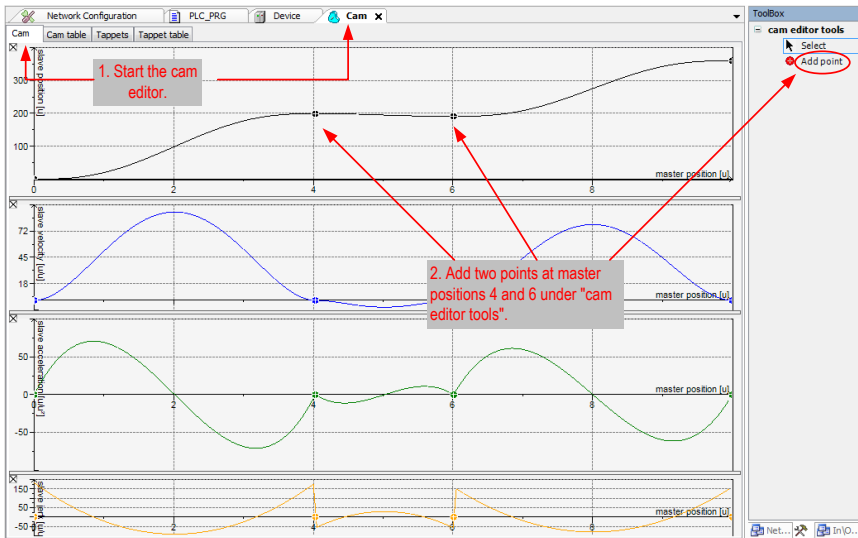

Modify the attributes of each control point on the Properties interface.

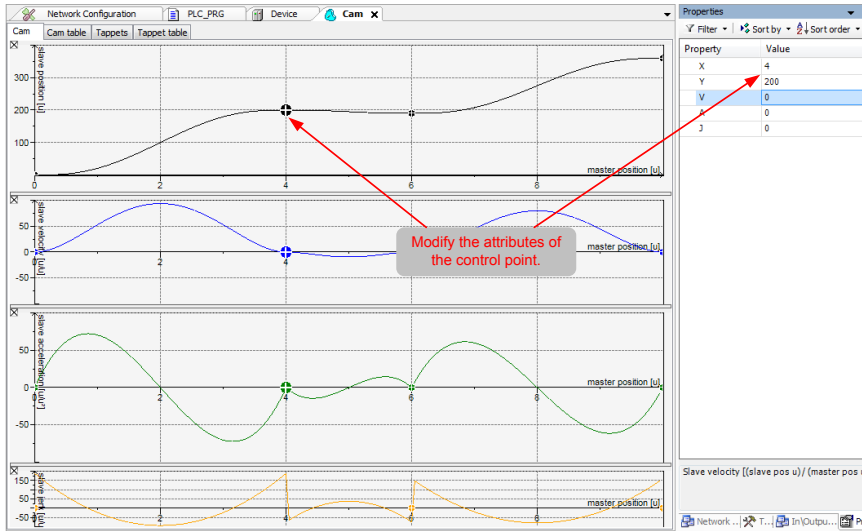

7. Set the tappet of the cam table.

Step 1. On the Tappets tab page, add a tappet in master axis position 8.

Step 2. Set the tappet to "invert" type in both directions.

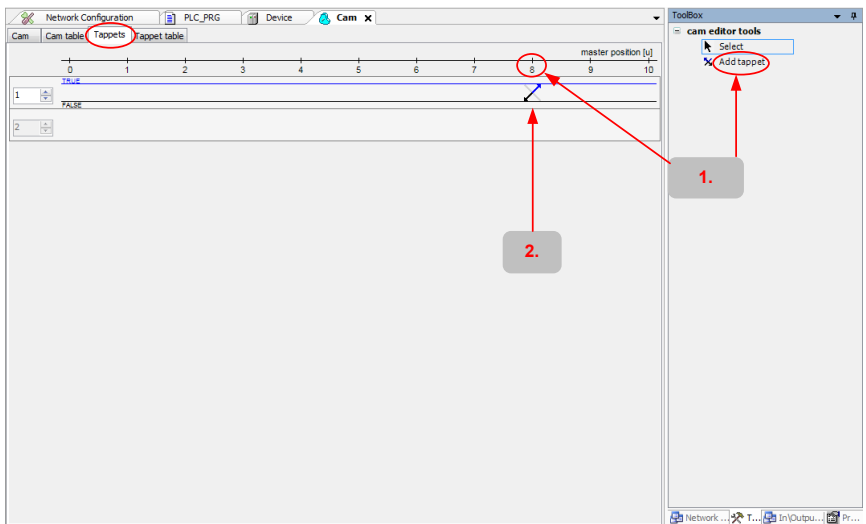

8. Add a program for controlling IS620N axis position linkage.

Right-click Application, and select Add Object > POU.

In the dialog box displayed, enter the program name, select Program, and select Function Block Diagram (FBD).

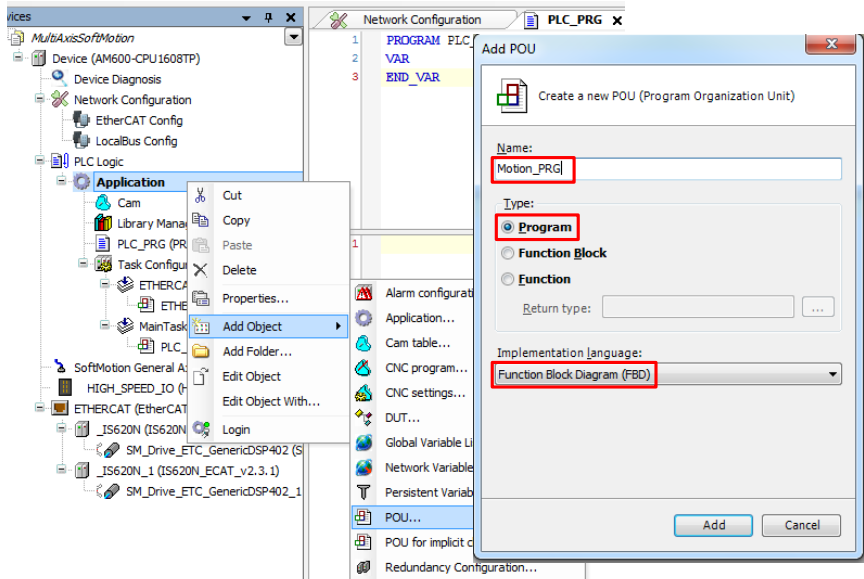

9. Execute linkage of two IS620N axes in the program.

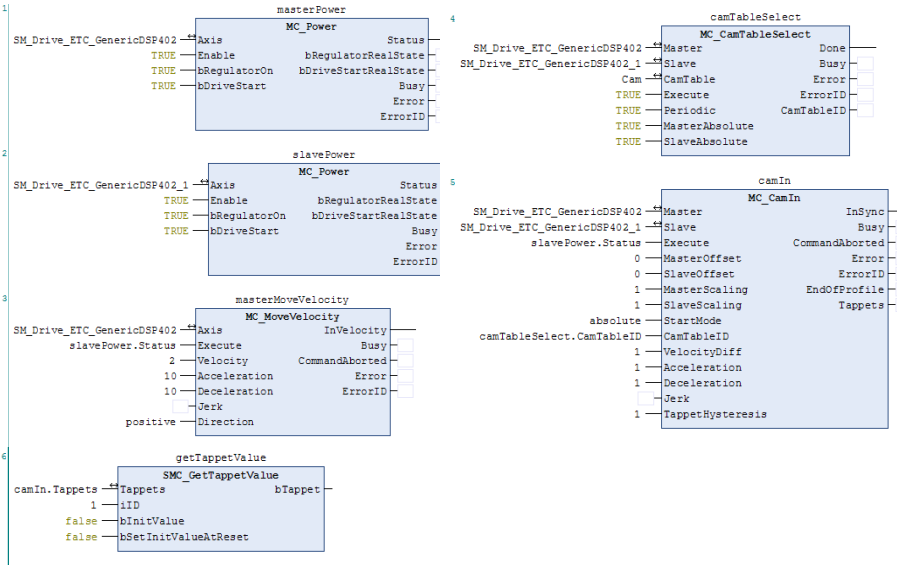

4

For details on the motion control commands, see the descriptions in section 4.1.1.

Function Description

The program first powers on the master axis and slave axis through function block MC_POWER instances masterPower and slavePower. After the slave axis is powered on successfully, the master axis starts to move at average speed of 2 units per second through function block MC_MoveVelocity instance masterMoveVelocity.

The master axis causes the slave axis to move due to their linkage according to the cam table. After the linkage cam table between the master and slave axes is configured through function block MC_CamTableSelect instance camTableSelect, the slave execute linkage through function block MC_CamIn instance camIn.

When the master axis moves, obtain the tappet status through function block SMC_GetTappetValue instance getTappetValue and perform the next operation based on the tappet status.

10. Configure the IS620N servo axis parameters.

The axis configuration interface includes two tabs, basic configuration and Scaling/Mapping configuration. On the basic configuration tab page, the axis type, curve, and min and max position limits can be configured. On the Scaling/Mapping tab page, the unit relationship between the number of pulses, motor revolutions, and gear output can be configured.

Modify the parameters of the master and slave axes marked in the following figure.

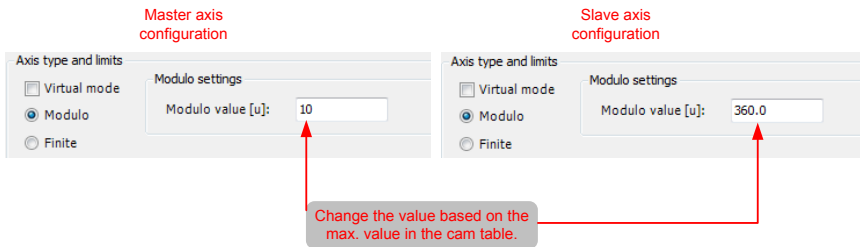

Master and slave axis type: modulus, indicating that axis motion is rotation type. Modulus value of master axis: 10, modulus value of slave axis: 360

Scaling/Mapping tab page:

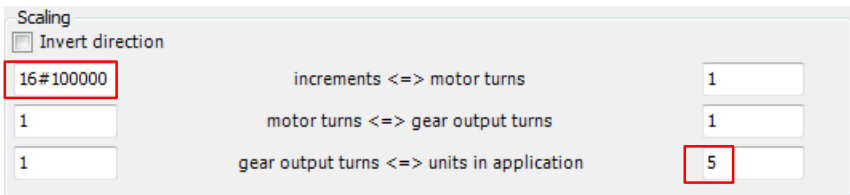

In this example, the ratio of pulse increment and motor revolutions is 16#100000:1, that is, the pulses per each revolution is 100000 in hexadecimal, which must be consistent with the specifications of the servo drive.

The ratio of each revolution and gear ratio is 1:1.

The relationship between gear ratio and unit in the applicable is 1:5, that is, 5 units in the program corresponds to 1 servo drive revolution, 1 gear output, and 16#100000 output pulses.

11. Add the axis control program to the EtherCAT task configuration.

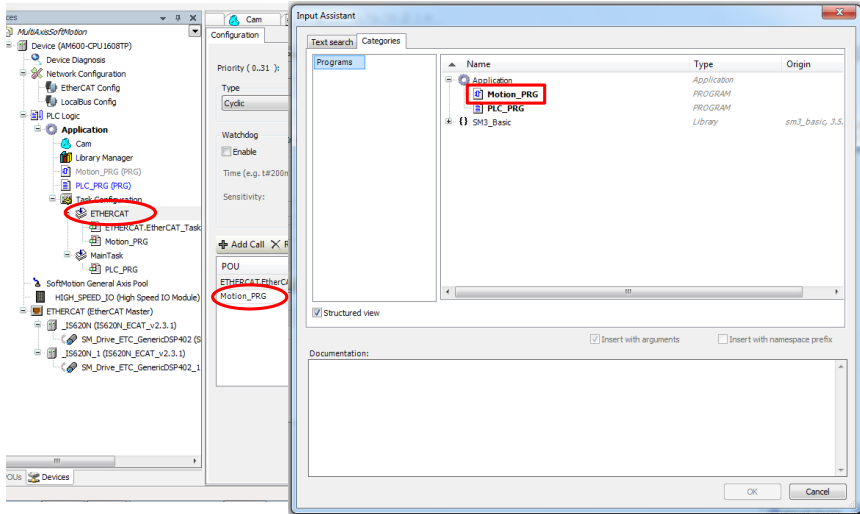

12. Download the program and perform commissioning.

The process of downloading the program is the same as step 7 in section 4.1.1.

After downloading, the axis running status can be viewed on the axis basic configuration tab page.

variable	set value	actual value
Position [u]	4.09	4.03
Velocity [u/s]	2.00	2.07
Acceleration [u/s ²]	0.00	-115.04
Torque [Nm]	0.00	110.00



Status:

Communication:

Errors

Axis Error:

FB Error:

uiDriveInterfaceError:

strDriveInterfaceError:

Master axis online state

Online

variable	set value	actual value
Position [μ]	193.74	192.17
Velocity [μ/s]	36.97	31.63
Acceleration [μ/s ²]	221.05	495.02
Torque [Nm]	0.00	45.00

Status: SMC_AXIS_STATE.synchronized_motion

Communication: operational (100)

Errors

Axis Error: 0

FB Error: SMC_ERROR.SMC_NO_ERROR

uiDriveInterfaceError: 1

strDriveInterfaceError:



Slave axis online state

On the programming interface, the instance value of the online motion control function block can also be viewed.

Device: Application.Motion_PRG

Expression	Type	Value	Prepared value	Address	Comment
masterPower	MC_Power				
slavePower	MC_Power				
masterMove...	MC_MoveVelocity				
camTableSel...	MC_CamTableSelect				

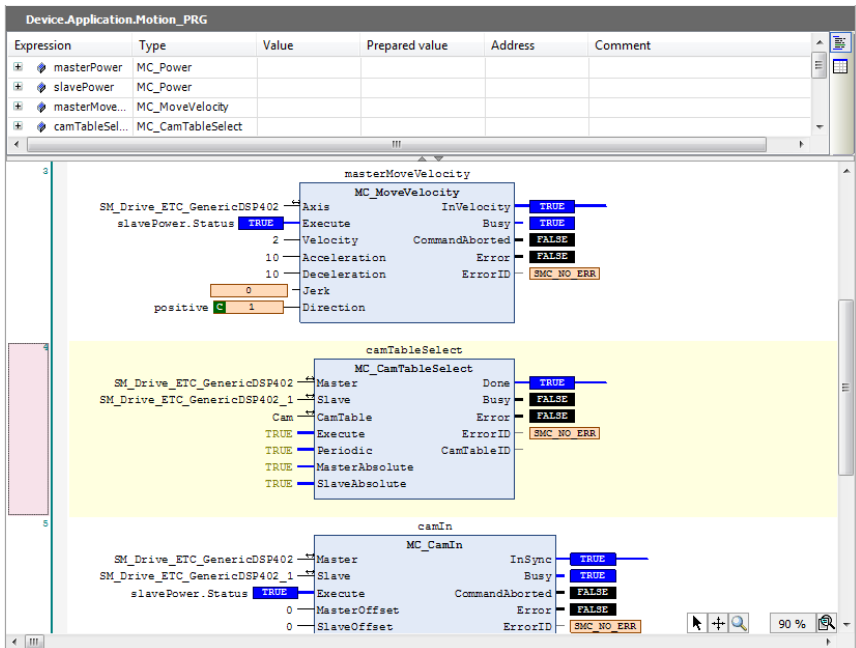

4

Analysis on the axis control program based on step 10:

The master axis moves at the speed of 2 units per second; it takes $5/2 = 2.5$ s for each revolution; it takes $10/2 = 5$ s for the master axis to move to the end position. The slave axis runs according to the cam table. The tappet outputs a signal each time when the master runs to 8-unit position according to the cam table, and this signal inverts the last output signal.

4.2 Omron PLC NJ501 as Master

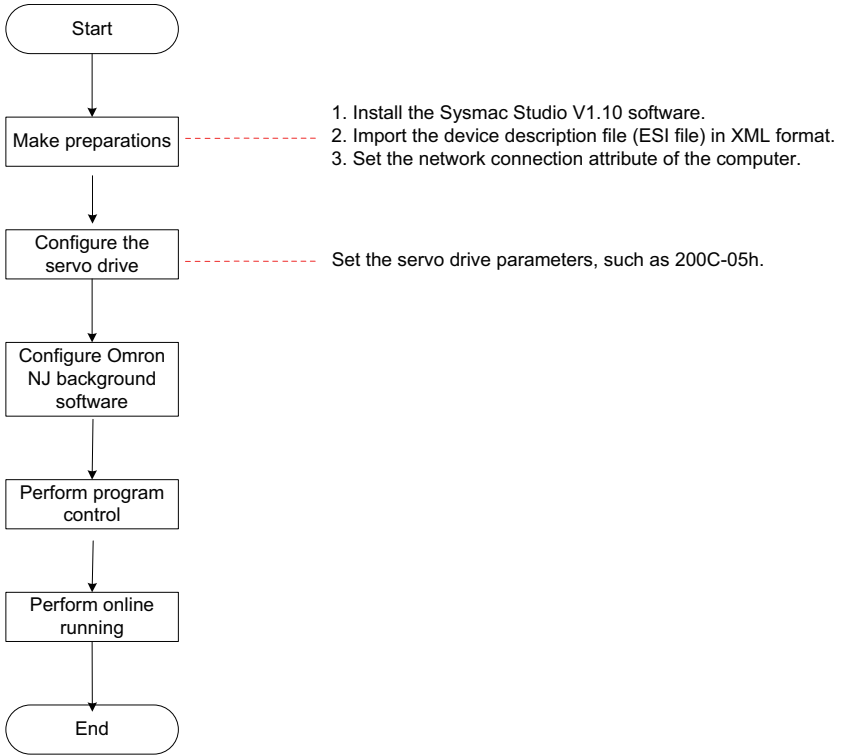

4.2.1 Making Preparations

1. Install the Sysmac Studio software of V1.10 or later version.

Note that Sysmac studio V1.03 or later version cannot recognize a third-party servo drive.

Sysmac Studio V1.09 patched version, V1.10 and later versions do not check whether the manufacturer ID in the XML file is consistent with that in the program, and all IS620N XML files can be used.

Sysmac Studio V1.05 to V1.09 check whether three parameters in group 1018h in the XML file are consistent with those in the program. Sysmac Studio V1.1, V1.9, V2.1 and later versions do not have this problem.

2. Import the device description file. Version V2.5 or later is recommended.

Use the device description file of IS620N-Ecat_v2.5.xml or later version, and store the file in the path: OMRON\Systemac Studio\IODeviceProfiles\EsiFiles\UserEsiFiles.

If the file is stored in this path for the first time, the Sysmac Studio software must be restarted.

3. Set the network connection attribute of the computer.

If the computer and the NJ controller is directly connected through a USB cable, skip this step.

If the computer and the NJ controller is connected through Ethernet connection, set the TCP/IP attribute of the computer, as shown in the following figure.

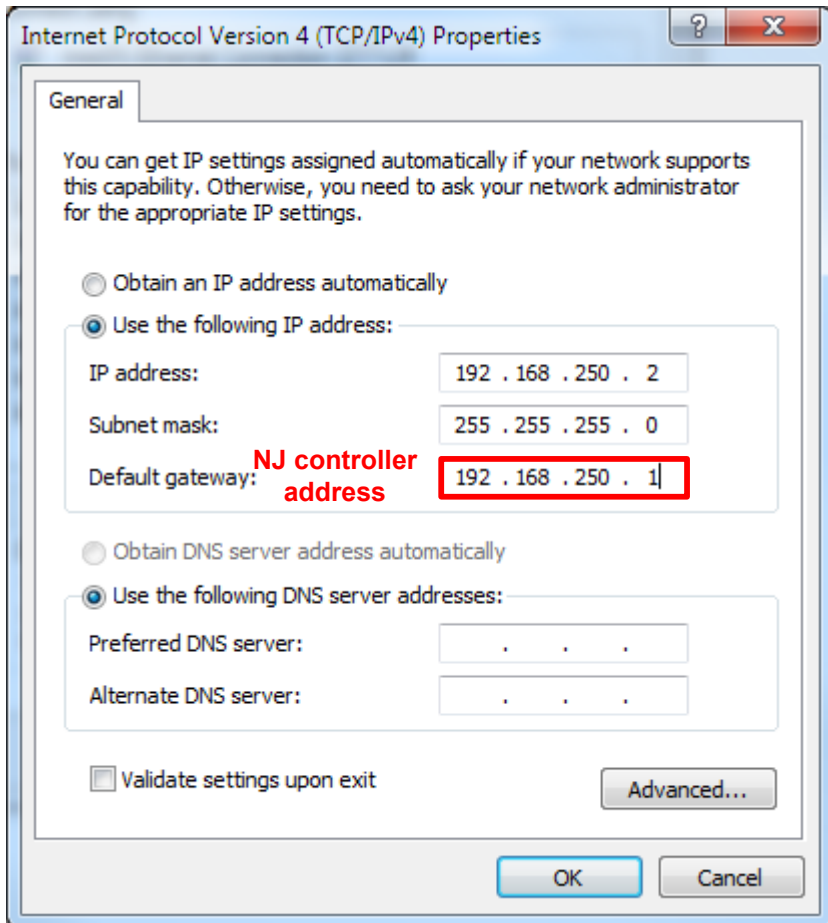

Note that the IP address is same as the NJ controller address in the first three segments, and the last segment must not be 0.

4.2.2 Configuring the Servo Drive

1. Check the software version of the servo drive.

Recommended version:

IS620N board software MCU version 2001-01h = 0102.0 or later version

IS620N board software FPGA version 2001-02h = 0112.0 or later version

2. Set related parameters of the servo drive.

Index	Name	Data Range	Unit	Default	Control Mode	Setting Condition	Effective Condition	Value
200C-06h	Station alias	0 to 65535	-	0	-	At stop	Immediate	Non-zero

When an NJ controller is used, set the EtherCAT station number in 200C-06h. It is recommended to set the station number according to the actual physical connection to facilitate management.

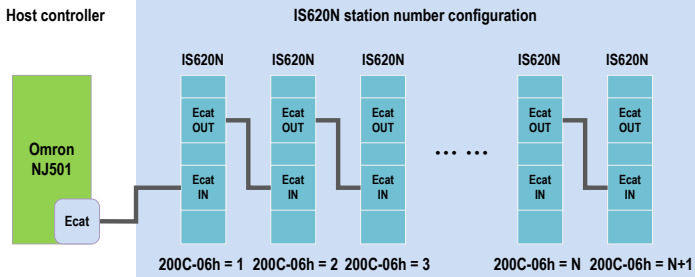

200C-2Ah	Host type selection	0 to 3	-	2	-	At stop	Immediate	2
----------	---------------------	--------	---	---	---	---------	-----------	---

If 200C-2Ah = 2 (Omron NJ series controller), the bits in 0x60FE (Digital input) are defined as follows:

Bit	Signal	Description
0	Negative limit switch	Each bit indicates whether the related DI signal is active. 0: Inactive 1: Active Configure the process data according to this table.
1	Positive limit switch	
2	Home switch	
3 to 15	NA	
16	Z signal	
17	Touch probe 1	
18	Touch probe 2	
25	DI emergency stop	
26 to 31	NA	

200C-2Ch	Synchronization mode	0 to 2	-	2	-	At stop	Immediate	1/2
----------	----------------------	--------	---	---	---	---------	-----------	-----

It sets the synchronization mode.

- 0: Asynchronization
- 1: Synchronization 1
- 2: Synchronization 2

In common point position control scenario, the default value synchronization 2 can meet the requirements. In high-performance scenario, synchronization 1 is used.

2002-26h	Speed switchover threshold 2 at stop due to limit switch	0 to 6000	RPM	6000	All	At stop	Immediate	6000
----------	--	-----------	-----	------	-----	---------	-----------	------

3. Networking

The IS620N is connected to the NJ controller through a network cable. If there is only one servo drive, the NJ controller must be connected to PORT0 (marked with "CN4 IN") of the servo drive. If there are multiple servo drives, the network cable must be firstly connected to CN4 IN and lead out from CN3 OUT. Note that the OUT interface of the last servo drive can be empty.



IS620N Port	Description
RS232 comm. port	Connect to background
Keypad	Display communication status in real time
Buttons	Set the address of a node
CN3 OUT	EtherCAT communication output port
CN4 IN	EtherCAT communication input port
CN1	General input/output terminals
CN2	Connect to Inovance 20-bit incremental encoder, serial absolute encoder, Heidenhain EQI1331 encoder or Tamagawa absolute encoder

4.2.3 Configuring Omron NJ Software

1. Create a project.

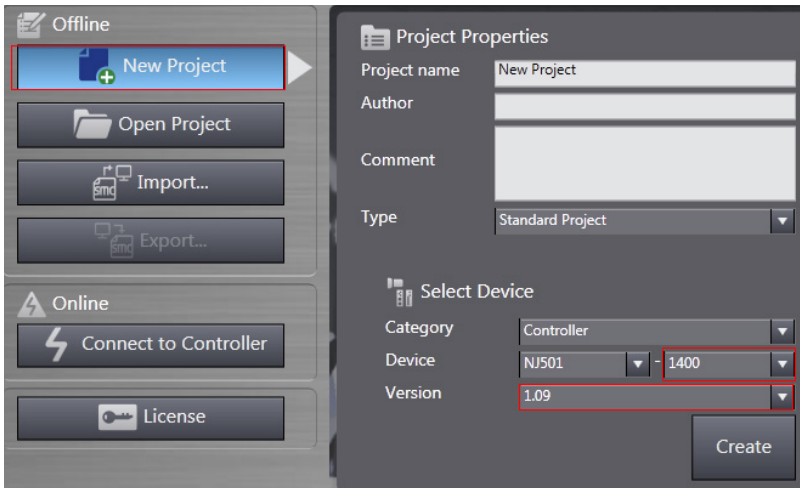

Device: Set it according to the actual NJ controller model.

Version: 1.09 or later version

2. Perform communication setting.

After navigating to the main interface, choose Controller > Communication Setting, and set the connection mode between the computer and the NJ controller.

Select Direct Connection via USB, and click USB Communication Test. After the test is successful, go to the next step.

Select Direct Connection via Ethernet, set the NJ controller IP address 192.168.250.1, and click Ethernet Communication Test. After the test is successful, go to the next step.

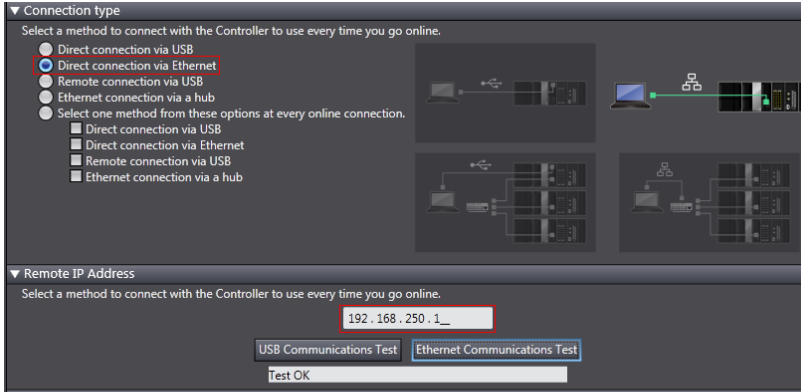

3. Scan devices.

- 1) Switch the controller to the online running mode.

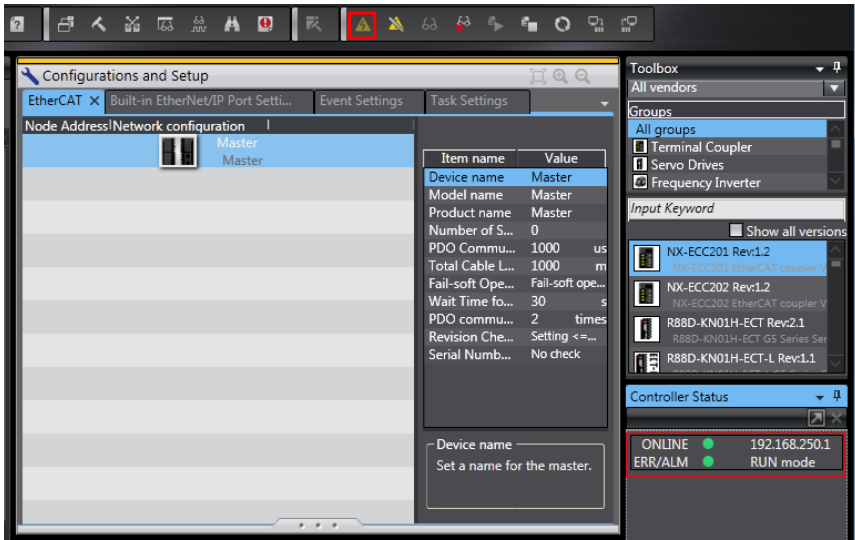

Observe the controller status in the lower right corner: ONLINE, RUN mode.

A prompt is displayed if it is a new NJ controller.

In the displayed dialog box, click Yes.

- 2) Add slaves.

Choose Configurations and Setup > EtherCAT, right-click Master, and select Compare and Merge with Actual Network Configuration. Then, the controller automatically scans all slaves in the network; if there is a slave with station number 0, the controller will reports an error. After scanning is completed, click Apply actual network configuration, and the slaves are added.

The added slaves can be viewed on the main interface.

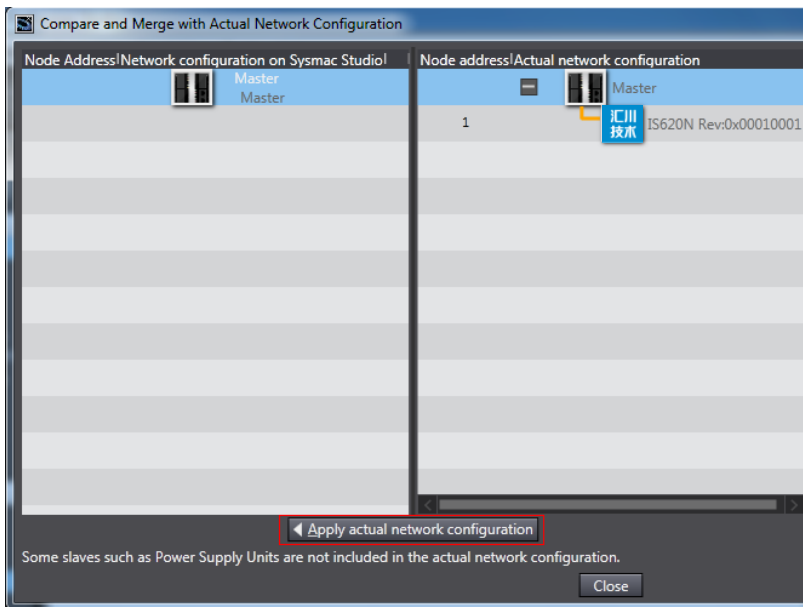
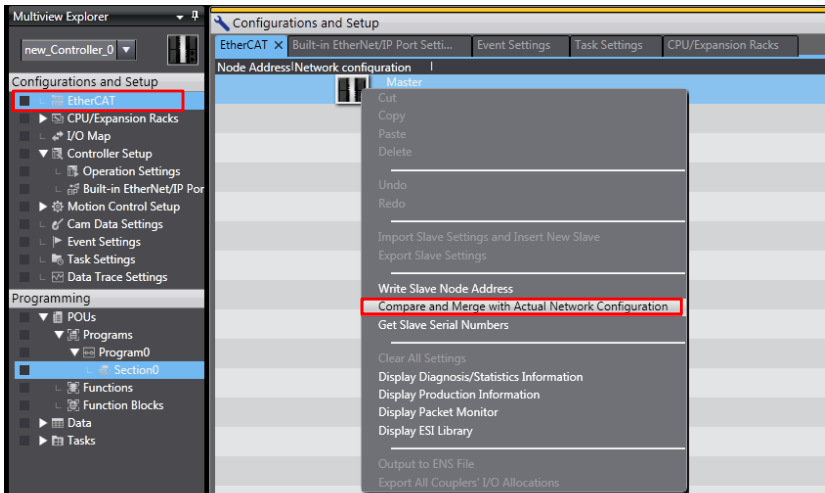

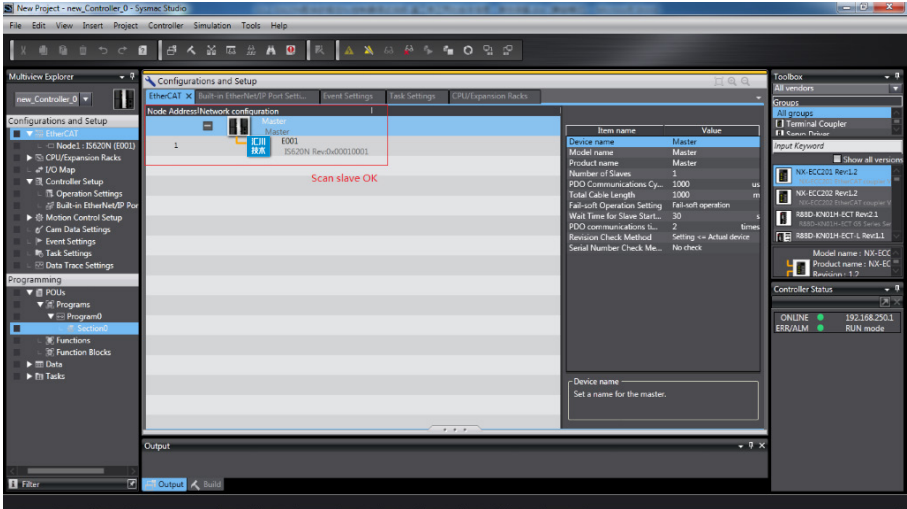

4. Set the parameters.

Switch the controller to offline mode, set PDO mapping, axis parameters, and DC clock.

1) PDO mapping

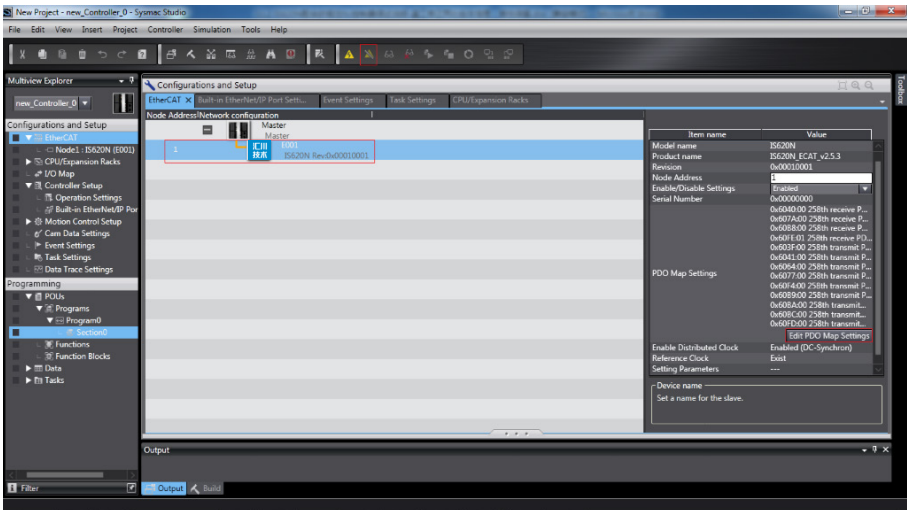

The default PDOs in the XML file of the IS620N V2.3 are 261st RPDO and 259th TPDO, the same as the PDOs used by the NJ controller, and the mapping objects in the XML file corresponds to those in the NJ controller.

The PDOs (261st RPDO and 259th TPDO) are also recommended for an XML file of other version.

If other PDOs are used, 1st RPDO and 1st TPDO of the IS620N can be configured according to user requirements.

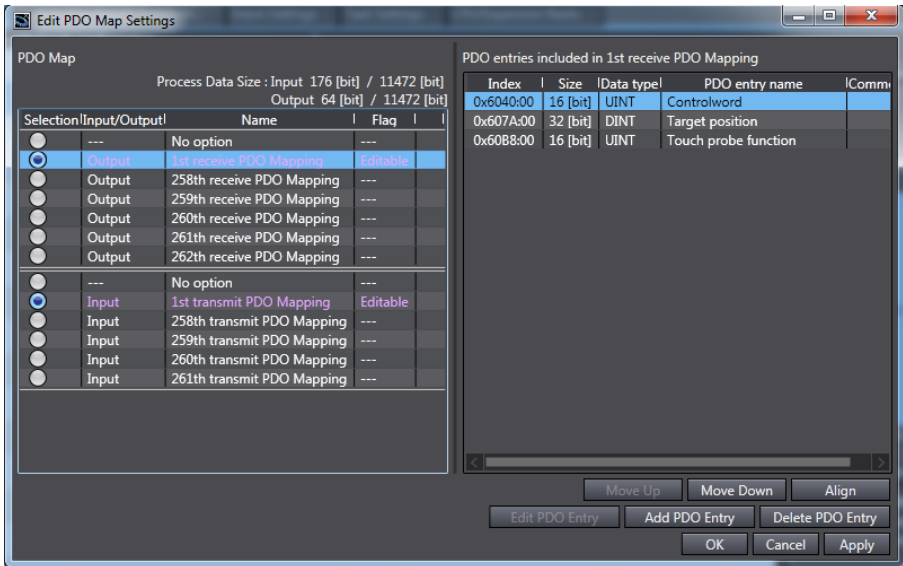

When the 1st RPDO and 1st TPDO are used, modify the PDO mapping objects by clicking Add PDO Entry and Delete PDO Entry.

1 st RPDO				
Index	Size	Data type	PDO entry name	
0x6040:00	16 [bit]	UINT	Controlword	
0x6060:00	8 [bit]	SINT	Modes of operation	
0x607A:00	32 [bit]	DINT	Target position	
0x60B8:00	16 [bit]	UINT	Touch probe function	

1 st TPDO				
Index	Size	Data type	PDO entry name	
0x6041:00	16 [bit]	UINT	Statusword	
0x6061:00	8 [bit]	SINT	Modes of operation display	
0x6064:00	32 [bit]	DINT	Position actual value	
0x60B9:00	16 [bit]	UINT	Touch Probe Status	
0x60BA:00	32 [bit]	DINT	Touch Probe pos 1 pos value	
0x60FD:00	32 [bit]	UDINT	Digital inputs	

2) Axis parameters

Under Motion Control Setup, right-click Axis Settings, and select Add > Axis Settings.

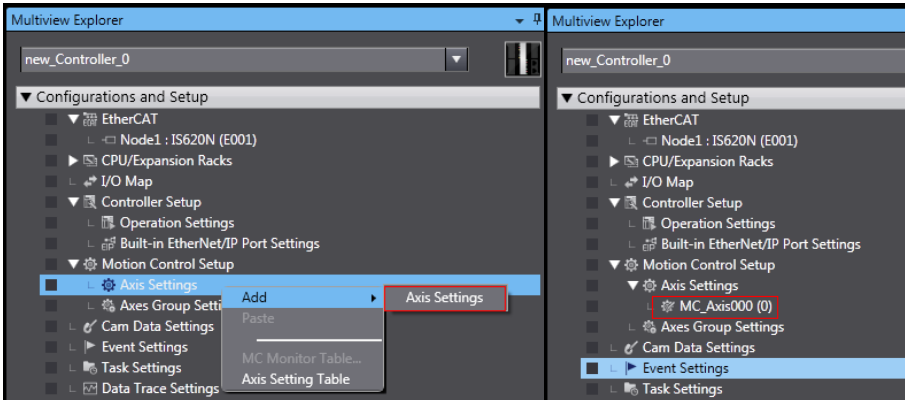

Click MC_Axis000 to rename the axis.

a. Basic axis setting

Double-click MC_Axis000. On the Axis Basic Settings interface, configure the IS620N device.

Axis assignment

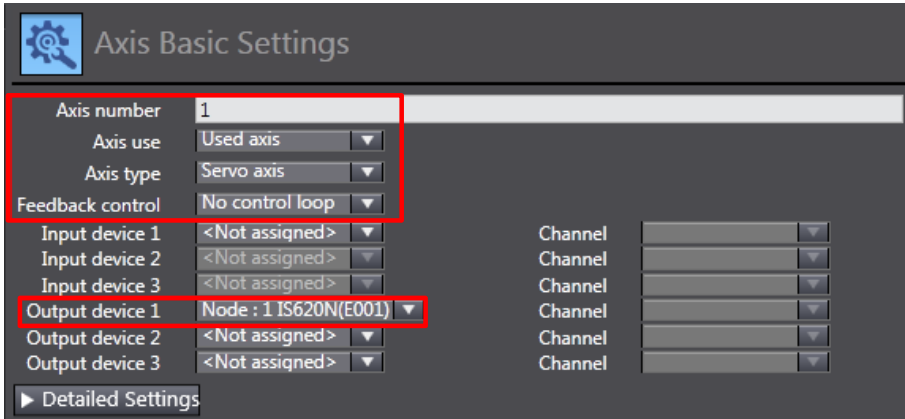

Axis number: Ethernet station number of the servo drive, 200C-06h value.

Axis use: Used axis

Axis type: Servo axis

Output device 1: actually used servo drive

Detailed setting

According to the PDO mapping objects selected in step 4, assign the output parameters (controller to device) and input parameters (device to controller). Note that the object name, node number, and index number must be set correctly. Each mapping object selected in step 4 must be assigned correctly with the parameters. Otherwise, an error will be reported.

- Output (Controller to Device)		
1. Controlword	Node : 1 IS620N(E001)	6040h-00.0(1st receive)
3. Target position	Node : 1 IS620N(E001)	607Ah-00.0(1st receive)
5. Target velocity	<Not assigned>	<Not assigned>
7. Target torque	<Not assigned>	<Not assigned>
9. Max profile Velocity	<Not assigned>	<Not assigned>
11. Modes of operation	Node : 1 IS620N(E001)	6060h-00.0(1st receive)
15. Positive torque limit value	<Not assigned>	<Not assigned>
16. Negative torque limit value	<Not assigned>	<Not assigned>
21. Touch probe function	Node : 1 IS620N(E001)	6088h-00.0(1st receive)
44. Software Switch of Encoder's Input	<Not assigned>	<Not assigned>

- Input (Device to Controller)		
22. Statusword	Node : 1 IS620N(E001)	6041h-00.0(1st transm)
23. Position actual value	Node : 1 IS620N(E001)	6064h-00.0(1st transm)
24. Velocity actual value	<Not assigned>	<Not assigned>
25. Torque actual value	<Not assigned>	<Not assigned>
27. Modes of operation display	Node : 1 IS620N(E001)	6061h-00.0(1st transm)
40. Touch probe status	Node : 1 IS620N(E001)	6089h-00.0(1st transm)
41. Touch probe pos1 pos value	Node : 1 IS620N(E001)	608Ah-00.0(1st transm)
42. Touch probe pos2 pos value	<Not assigned>	<Not assigned>
43. Error code	<Not assigned>	<Not assigned>
45. Status of Encoder's Input Slave	<Not assigned>	<Not assigned>
46. Reference Position for csp	<Not assigned>	<Not assigned>

60FDh must be mapped to objects by bit. The mapping must be consistent with that in the Omron NJ controller.

- Digital inputs		
28. Positive limit switch	Node : 1 IS620N(E001)	60FDh-00.1(1st transm)
29. Negative limit switch	Node : 1 IS620N(E001)	60FDh-00.0(1st transm)
30. Immediate Stop Input	Node : 1 IS620N(E001)	60FDh-00.25(1st transr)
32. Encoder Phase Z Detection	Node : 1 IS620N(E001)	60FDh-00.16(1st transr)
33. Home switch	Node : 1 IS620N(E001)	60FDh-00.2(1st transm)
37. External Latch Input 1	Node : 1 IS620N(E001)	60FDh-00.17(1st transr)
38. External Latch Input 2	Node : 1 IS620N(E001)	60FDh-00.18(1st transr)

Note

The axis configuration of the IS620N needs to be performed manually when the Omron NJ controller is used.

b. Unit conversion setting

Correctly set the reference pulses per motor revolution according to the actually used motor resolution, for example, 1048576 pulses per revolution for 20-bit motor. The travel per motor revolution need not be changed from its default value. The effect is similar to that the host controller makes electronic gear ratio conversion, and the servo drive need not make the conversion again.

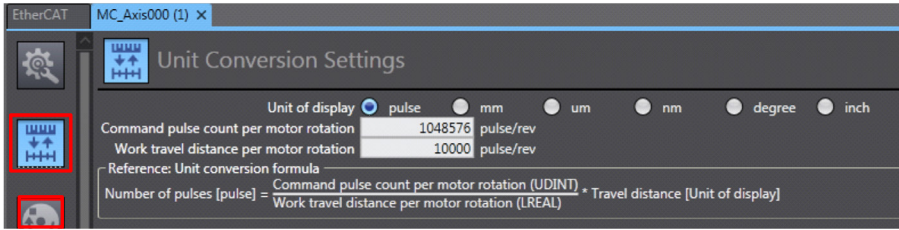

Select an appropriate value in Unit of display according to the actual load unit. All position parameters in the host controller calculated based on the gear ratio are displayed in this unit.

c. Operation setting

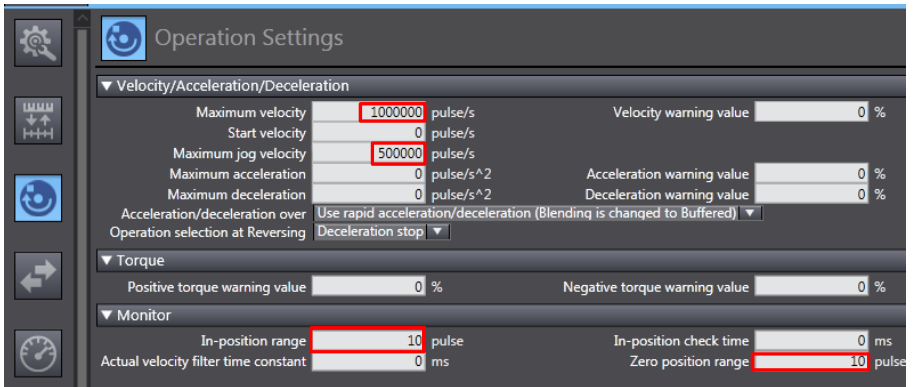

Velocity/Acceleration/Deceleration: Set the maximum speed of the load according to actual conditions. If the motor speed converted from the setting exceeds 6000 RPM, the host controller will prompt a setting error with a red square.

If the acceleration/deceleration is 0, the running curve is produced with the maximum acceleration or deceleration. If there is no special requirement, this parameter may not be set.

Torque: If the warning value is set to 0, the system does not give a warning. If there is no special requirement, this parameter may not be set.

Monitor: Set In-position range and Zero position range based on actual motor and mechanical conditions. If the setting is too small, positioning or homing may not be implemented.

d. Limit setting

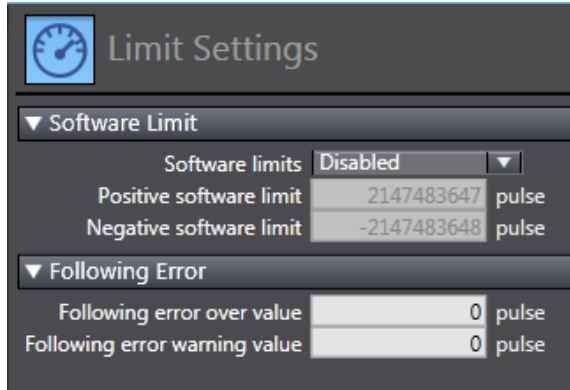

Use the soft limit function to make the software limit takes effect after homing by host the controller.

e. Homing setting

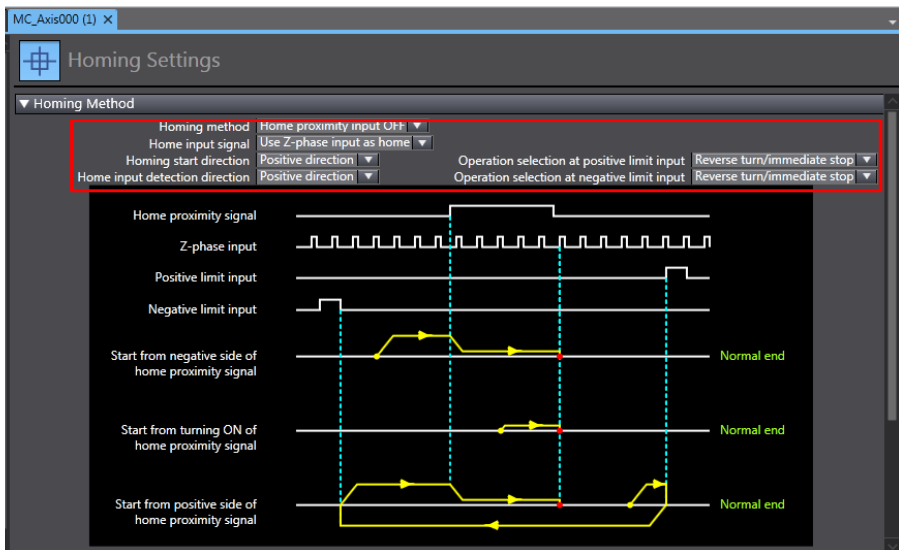

The homing mode affects working between the servo drive and the host controller. Set it properly according to the following table.

NJ Software Description	Servo Drive Function	Terminal Configuration
Home proximity signal	Home switch (FunIN.31)	DI9
External home input	Touch probe 1 (FunIN.38)	DI8
Z-phase input	Motor encoder Z-phase signal	N/A
Positive limit input	P-OT (FunIN.14)	DI1
Negative limit input	N-OT (FunIN.15)	DI2

Select the homing mode of the host controller and set the homing speed, acceleration, and home offset based on actual mechanical conditions.

Note	Phase Z signal and external home switch signal shall not be used at the same time.
-------------	--

Homing function:

Function block: MC_Home and MC_HomeWithParameter

1. Set the MC_Home parameter in the above figure and the MC_HomeWithParameter parameter in the function block.
2. The two function blocks both include 10 homing modes.

MC_Home	MC_HomeWithParameter
Proximity reverse turn/home proximity input OFF Proximity reverse turn/home proximity input ON Home proximity input OFF Home proximity input ON Limit input OFF Proximity reverse turn/home input mask distance Limit inputs only Proximity reverse turn/holding time No home proximity input/holding home input Zero position preset	Specify home reset action: 0: Near avoidance, close to home input OFF 1: Near avoidance, close to home input ON 4: Close to home input OFF 5: Close to home input ON 8: Limit input OFF 9: Near avoidance, home input shield distance 11: Only limit input 12: Near avoidance, contact home 13: No close to home input, contact home input 14: Home preset

Home proximity input OFF: The host controller searches for the home signal after reaching the falling edge of the home near switch.

Home proximity input ON: The host controller searches for the home signal after reaching the rising edge of the home near switch.

Near avoidance/Proximity reverse turn: If the home near signal is ON when homing is enabled, the host controller reverses the running direction immediately after reaching the falling edge of the home near signal.

Home input mask/Shield distance: The host controller shields the homing signal within a set distance after receiving the home near signal (for example, edge change of home near signal), and starts to receive the home signal outside this distance.

Holding time/Contact time: The host controller shields the homing signal within a set time period after receiving the home signal (for example, edge change of home near signal), and starts to receive the home signal after this period.

Zero position preset/Home preset: The host controller uses the current position as the home and the motor does not act. The host controller writes the home offset to the position reference and actual reference.

Note	The home signal is searched at a low speed in all homing modes. If the motor runs at high speed, the home signal is shielded when it decelerates from high speed to low speed.
-------------	--

f. Other setting

Select the device optionally according to actual requirements.

3) DC clock setting

The default clock is 1 ms.

In offline state, the synchronization clock can be modified by changing the period of primary periodic task on the Task Settings interface. The synchronization clock is specified in PDO communication period in the NJ controller.

The modification takes effect after you power-on the system again and switches it to the online state.

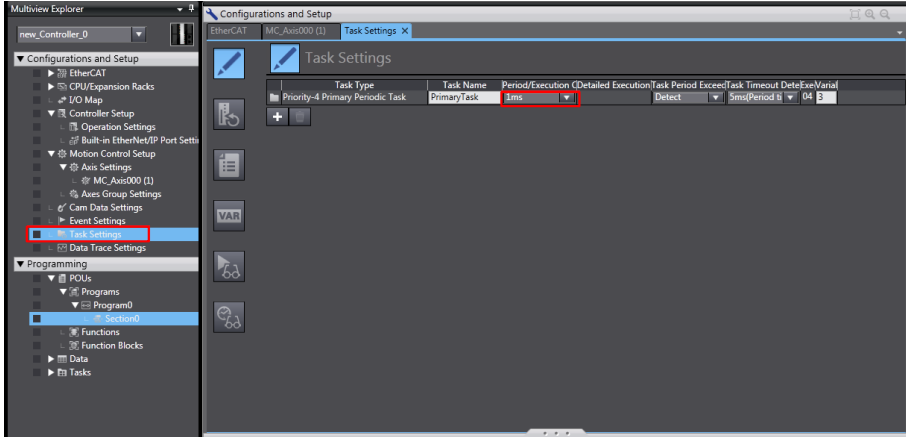

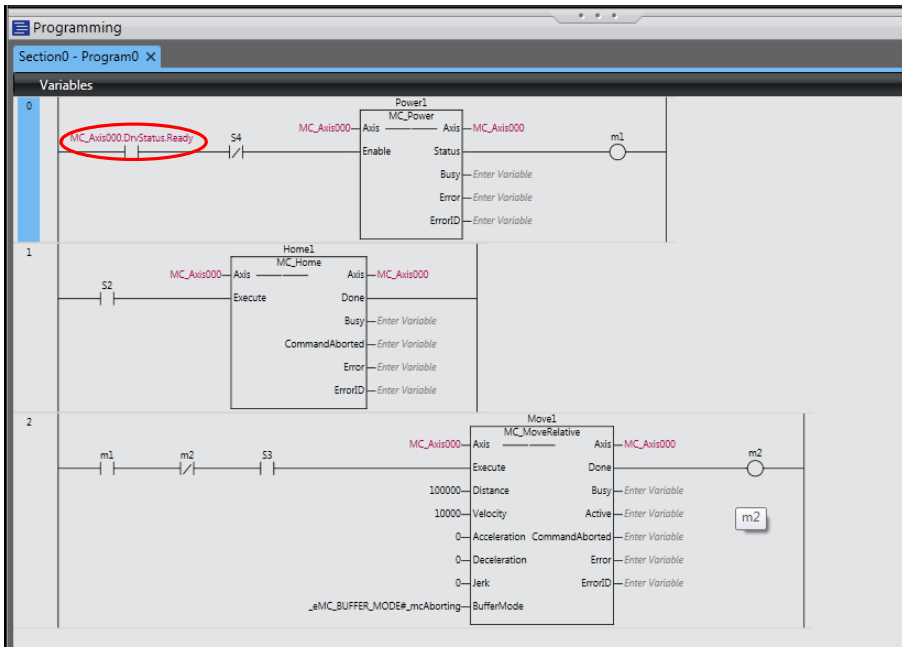

5. Program control

After the configuration is completed, enable running of the servo drive via the PLC program. When function block MC_POWER is used, it is recommended to add the axis servo status bit MC_Axis000.DrvStatus.Ready. MC_Axis000 is the axis name. This prevents the situation that communication configuration is not ready but the PLC program is running.



6. Online running

After all the setting and programming are completed, switch over to the online state, and click  to download the program to the controller.

Use the synchronization function by clicking  to compare the difference between the current program and the program in the controller and determine whether to download the program to the controller, upload it from the controller or not change it.

Note

When the G5 series servo drive is used together with a third-party servo drive:
In the same network, the NJ controller configures the G5 servo drive first regardless of the station address sequence, and configures the third-party servo drive only after the G5 servo drive enters the operation state.

Chapter 5 Troubleshooting

5.1 Fault and Warning Rectification at Startup

Startup	Fault Symptom	Probable Causes	Confirming Method
The control power (L1C, L2C) and main power (R, S, T) are switched on.	The keypad LED is off or does not display "rdy).	1. The voltage of the control power is faulty.	Check whether the fault persists after connectors CN1, CN2, CN3, and CN4 are disconnected. Measure the AC voltage between L1C and L2C.
		2. The program burning terminal is shorted.	Check whether the program burning terminal is shorted.
		3. The servo drive is faulty.	-
	The keypad displays "Er.xxx"	Locate the cause and rectify the fault according to the instructions in section 10.2.	
	The keypad displays "ry" if the preceding faults are rectified.		

5.2 Troubleshooting of Faults

Er.101: Parameter abnormal

Probable Cause	Confirming Method	Corrective Action
1. The control power voltage drops instantaneously.	Check whether control power (L1C, L2C) is cut off or whether instantaneous power failure occurs.	Restore the default setting (2002-20h = 1), and write the parameters again.
	Measure whether the control power voltage on the non-drive side is within the following specifications: 220 V drive: Effective value: 220 to 240 V Allowed error: -10% to 10% (198 to 264 V) 380 V drive: Effective value: 380 to 440 V Allowed error: -10% to 10% (342 to 484 V)	Increase the power capacity or replace with large-capacitance power supply. Restore the default setting (2002-20h = 1), and write the parameters again.
2. Instantaneous power failure occurs during parameter storage.	Check whether instantaneous power failure occurs during parameter storage.	Power on the system again, restore the default setting (2002-20h = 1), and write the parameters again.
3. The times of parameter writing within a certain period exceeds the limit.	Check whether parameter update is performed frequently from the host controller.	Change the parameter writing method and write parameters again. If the servo drive is faulty, replace it.

Probable Cause	Confirming Method	Corrective Action
4. The software is upgraded.	Check whether the software is upgraded.	Set the servo drive model and servo motor model again, and restore the default setting (2002-20h = 1).
5. The servo drive is faulty.	If the servo drive is powered off and powered on gain several times and the default setting is restored, but the fault persists, it indicates that the servo drive is faulty.	Replace the servo drive.

Er.102: Programmable logic configuration fault

Probable Cause	Confirming Method	Corrective Action
1. The FPGA software version and the MCU software version do not match.	View the MCU software version (2001-01h) and the FPGA software version (2001-02h) via operating panel or Inovance servo commissioning software. Check whether the non-zero value of the most significant bit is the same in the two the versions.	Contact Inovance for technical support. Update the software to make them match.
2. The FPGA is faulty.	The fault persists after the servo drive is powered off and on for several times.	Replace the servo drive.

Er.103: FPGA software version too early

Probable Cause	Confirming Method	Corrective Action
1. The FPGA version in 2001-02h is earlier than 0112.0.	View the MCU software version (2001-01h) and the FPGA software version (2001-02h) via operating panel or Inovance servo commissioning software.	Update the software to make them match.
2. The FPGA is faulty.	The fault persists after the servo drive is powered off and on for several times.	Replace the servo drive.

Er.104: Programmable logic interruption fault

Probable Cause	Confirming Method	Corrective Action
1. The FPGA is faulty (Er.104).	The fault persists after the servo drive is powered off and on for several times.	Replace the servo drive.
2. communication between the FPGA and the MCU is abnormal (Er.100).		
3. The drive internal operation times out (Er.940).		

Er.105: Internal program abnormal

Probable Cause	Confirming Method	Corrective Action
1. An EEPROM fault occurs.	Check the causes according to the method of Er.101.	Restore the default setting (2002-20h = 1), and power on the system again.
2. The servo drive is faulty.	The fault persists after the servo drive is powered off and on for several times.	Replace the servo drive.

Er.108: Parameter storage fault

Probable Cause	Confirming Method	Corrective Action
1. EEPROM writing is abnormal.	Modify a parameter, power on the servo drive again, and check whether the modification is saved.	If the modification is not saved and the fault persists after the servo drive is powered off and powered on again for several times, replace the servo drive.
2. EEPROM reading is abnormal.		

Er.120: Product model matching fault

Probable Cause	Confirming Method	Corrective Action
1. Product (motor or servo drive) SN does not exist.	Internal fault code 200B-2Eh = 0120 or 1120: View the motor nameplate to check whether the motor is suitable. Check whether 2000-01h setting is correct.	Set 200D-01h (Motor SN) correctly according to the motor nameplate or use a matching motor.
	Internal fault code 200B-2Eh = 2120: View the drive model in 2001-03h and check whether this model is present in section 1.1.	If the drive SN does not exist, set it correctly according to the drive nameplate by referring to section 1.1.
2. The power rating of the servo motor and does not match that of the servo drive.	Internal fault code 200B-2Eh = 3120: Check whether the drive model in 2001-03h matches the serial encoder model in 2000-06h based on the description in section 1.1.	Use matching products.

Er.121: Invalid S-ON command

Probable Cause	Confirming Method	Corrective Action
1. When servo drive is enabled internally, the S-ON signal is turned on via communication.	Check whether the S-ON signal is sent from the host controller when the auxiliary functions (200D-03h, 200D-04h, 200D-0Ch) are used.	Turn off the S-ON signal from the host controller.

Er.122: Product matching fault in absolute position mode

Probable Cause	Confirming Method	Corrective Action
The motor does not match in absolute position mode or the motor SN is set incorrectly.	View the motor nameplate to check whether the motor is a multi-turn absolute encoder motor. Check whether 200D-01h (Motor SN) is correct.	Set 200D-01h (Motor SN) correctly according to the motor nameplate or use a matching motor.

Er.130: Different DIs allocated with the same function

Probable Cause	Confirming Method	Corrective Action
1. The same function is allocated to different DIs.	View 2003-03h, 2003-05h to 2003-15h, and 2017-01h, 2017-03h to 2017-1Fh to check whether they are allocated with the same non-zero DI function No.	Allocate group 2003h and 2007h parameters that have been allocated with the same non-zero DI function No. with different DI functions. Then turn on the control power again to make the modification take effect. You can also turn off the S-ON signal to OFF and give the reset signal to make the modification take effect.
2. The DI function No. exceeds the number of DI functions.	Check whether the MCU program is updated.	Restore the default setting (2002-20h = 1), and power on the system again.
3. The DI function is not supported.	Check whether the DI functions set in groups 2003h and 2017h are supported in the DI/DO function definitions table in section 6.4.	Do not set a DI function No. not included in the DI/DO function definitions table.

Er.131: DO function No. exceeding the number of functions

Probable Cause	Confirming Method	Corrective Action
1. The DO function No. exceeds the number of DO functions.	Check whether the MCU program is updated.	Restore the default setting (2002-20h = 1), and power on the system again.

Er.136: Data check error or no parameter stored in the motor ROM

Probable Cause	Confirming Method	Corrective Action
1. The servo drive model and the motor model do not match.	View the servo drive and servo motor nameplates to check that the equipment used is Inovance IS620N series servo drive and matching servo motor.	Use matched servo drive and servo motor.
2. A parameter check error occurs or no parameter is stored in the serial encoder ROM memory.	Check whether the encoder cable is used according to the standard configuration. For cable specification, refer to section 1.4. The cable must be connected reliably without scratching, breaking or poor contact. Measure signals PS+, PS-, +5V and GND at both ends of the encoder cable and observe whether signals at both ends are consistent. For the definition of signals, refer to Chapter 2.	Use the recommended encoder cable. Ensure that the cable is connected to the motor securely and tighten the screws on the drive side. If necessary, use a new encoder cable. Never bundle encoder cable and power cables (RST, UVW) together.
3. The servo drive is faulty.	The fault persists after the servo drive is powered on again.	Replace the servo drive.

Er.200: Overcurrent 1

Er.201: Overcurrent 2

Probable Cause	Confirming Method	Corrective Action
1. References are input simultaneously at servo drive startup or the reference input is too early.	Check whether an reference is input before the keypad displays "rdy".	The time sequence is: After the keypad displays "rdy", turn on the S-ON signal and then input a reference. If allowed, add reference filter time constant or increase acceleration/deceleration time.
2. The external regenerative resistor provides too small resistance or is short-circuited.	If the internal regenerative resistor is used (2002-1Ah = 0), check whether P_{\oplus} and D are connected with a jumper reliably. If yes, measure resistance between C and D. If an external regenerative resistor is used (2002-1Ah = 1/2), measure resistance between P_{\oplus} and C. For regenerative resistor specification, refer to section 1.1.4.	If the internal regenerative resistor is used and the resistance is 0, use an external regenerative resistor (2002-1Ah = 1/2) and remove the jumper between P_{\oplus} and D. Select an external regenerative resistor of the same resistance and power as the internal one. If an external regenerative resistor is used and the resistance is smaller than 2002-16h, replace it with a new one between P_{\oplus} and C by referring to the regenerative resistor specification in section 1.1.4. Set 2002-1Bh (Power of external regenerative resistor) and 2002-1Ch (Resistance of external regenerative resistor) correctly according to the specifications of the used regenerative resistor.
3. The motor cables are in poor contact.	Check whether the servo drive power cables and motor UVW cables are loose.	Fasten the cables that become loose or are disconnected.
4. The motor cables are grounded.	After ensuring the servo drive power cables and motor cables are connected securely, measure whether the insulation resistance between the servo drive UVW cables and ground cable (PE) is MΩ-level.	Replace the motor if the insulation is poor.
5. The motor UVW cables are short circuited.	Disconnect the motor cables and check whether they are short circuited and whether burrs exist.	Connect the motor cables correctly.

Probable Cause	Confirming Method	Corrective Action
6. The motor is damaged.	Disconnect the motor cables and measure whether the resistance between motor cables UVW is balanced.	Replace the motor if the resistance is unbalanced.
7. The gain setting is improper and the motor oscillates.	Check whether the motor oscillates or generates a shrill noise during motor startup and running. You can view current feedback by using the drive Inovance servo commissioning software.	Carry out gain adjustment.
8. The encoder cable is incorrectly wired, corrosive, or inserted loosely.	Check whether the encoder cable is used according to the standard configuration. check whether the cable is aging, corrosive or loose. Turn off the S-ON signal, rotate the motor shaft manually, and check whether 200B-0Bh (Electrical angle) changes as the motor rotates.	Re-weld, fasten or replace the encoder cable.
9. The servo drive is faulty.	The fault persists after the motor cables are disconnected and the servo drive is powered on again.	Replace the servo drive.

Er.207: Shaft D/Q current overflow

Probable Cause	Confirming Method	Corrective Action
Shaft D/Q current overflow occurs.	If the fault persists after the servo drive is powered off and powered on again for several times, it indicates that the servo drive is faulty.	Replace the servo drive.

Er.208: FPGA sampling operation timeout

Probable Cause	Confirming Method	Corrective Action
1. MCU communication times out.	Internal fault code 200B-2Eh = 1208: The internal chip is damaged	Replace the servo drive.
2. Communication with the encoder times out.	Internal fault code 200B-2Eh = 2208: Encoder wiring is incorrect. Connection of the encoder cable becomes loose. The encoder cable is too long. Communication interference exists. The encoder is faulty.	Use the recommended encoder cable. If a non-standard cable is used, check that it complies with the specifications and is a shielded twisted pair cable. Check if the connectors at both ends of the encoder are in good contact. Contact the manufacturer. Do not bundle motor cables and encoder cables together. Ensure the servo motor and servo drive are well grounded. Replace the servo motor.
3. Current sampling times out.	Internal fault code 200B-2Eh = 3208: Check if there is large equipment generating interference on-site and whether there are interference sources such as various variable-frequency devices inside the cabinet. The internal current sampling chip is damaged.	Separate the heavy current from light current. Replace the servo drive.

Probable Cause	Confirming Method	Corrective Action
4. High-accuracy AD conversion times out.	Internal fault code 200B-2Eh = 4208: Interference exists in high-accuracy AI channel. Check AI wiring according to the correct wiring diagram.	Use the twisted shielded cables, and shorten the cable distance.
5. FPGA operation times out.	Internal fault code 200B-2Eh = 0208: Remove the preceding causes 1/2/3/4.	Remove the preceding causes 1/2/3/4.

Er.210: Output to-ground short-circuit

Probable Cause	Confirming Method	Corrective Action
1. The servo drive power cables (UVW) are short-circuited to ground.	Disconnect the motor cables, and measure whether the servo drive power cables are short-circuited to ground.	Re-connect these cables or replace them.
2. The motor is short-circuited to ground.	After ensuring the servo drive power cables and motor cables are connected securely, measure whether the insulation resistance between the servo drive UVW cables and ground cable (PE) is MΩ-level.	Replace the motor.
3. The servo drive is faulty.	Remove the power cables from the servo drive. The fault persists after the drive is powered off and on for several times.	Replace the servo drive.

Er.220: Phase sequence incorrect

Cause	Confirming Methods	Corrective Action
1. The UVW phase sequence of the drive is inconsistent with that of the motor.	Carry out power-off and power-on for several times, and the fault persists after auto-tuning.	Perform the wiring again and then angle auto-tuning.

Er.234: Runaway

Probable Cause	Confirming Method	Corrective Action
1. UVW phase sequence is incorrect.	Check whether the servo drive power cables are connected in correct sequence on both sides.	Connect the UVW cables according to the correct sequence.
2. The initial phase of the motor rotor detected is incorrect due to interference at power-on.	The UVW phase sequence is correct, but Er.234 occurs when the servo drive is turned on.	Power on the servo drive again.
3. The encoder type is set incorrectly or the wiring is incorrect.	View the servo drive and servo motor nameplates to check that the equipment used is Inovance IS620N series servo drive and matching servo motor.	Use matching servo drive and servo motor. If you use Inovance IS620N series servo drive and 20-bit servo motor (-U2***), ensure that 2000-01h = 14000. Correct the motor model, encoder type, and encoder wiring.
4. The encoder cable is incorrectly wired, corrosive, or inserted loosely.	Check whether the encoder cable is used according to the standard configuration. check whether the cable is aging, corrosive or loose. Turn off the S-ON signal, rotate the motor shaft manually, and check whether 200B-0Bh (Electrical angle) changes as the motor rotates.	Re-weld, fasten or replace the encoder cable.
5. The gravity load is too heavy when the motor controls a vertical axis.	Check whether the load of vertical axis is too heavy. Adjust brake parameters 2002-0Ah to 2002-0Dh and then see whether the fault is removed.	Reduce the load of vertical axis, improve the stiffness, or shield this fault on the prerequisite of not affecting safety and use.

Er.400: Main circuit overvoltage

Probable Cause	Confirming Method	Corrective Action
1. The main circuit input voltage is too high.	Measure the input voltage of the servo drive main circuit is within the following specifications: 220 V drive: Effective value: 220 to 240 V Allowed error: -10% to 10% (198 to 264 V) 380 V drive: Effective value: 380 to 440 V Allowed error: -10% to 10% (342 to 484 V)	Replace or adjust the power supply according to the specifications.
2. The power supply is unstable or affected by the lightning strike.	Check if the power supply is unstable, is affected by lightning strike or satisfies the preceding specifications.	Connect a surge suppressor and then the power supply. If the fault persists, replace the servo drive.
3. The braking resistor fails.	If the internal regenerative resistor is used (2002-1Ah = 0), check whether P_{\oplus} and D are connected with a jumper reliably. If yes, measure resistance between C and D. If an external regenerative resistor is used (2002-1Ah = 1/2), measure resistance between P_{\oplus} and C. For regenerative resistor specification, refer to section 1.1.4.	If resistance is ∞ , wire breaking occurs in the regenerative resistor. If the internal regenerative resistor is used, use an external regenerative resistor (2002-1Ah = 1/2) and remove the jumper between P_{\oplus} and D. Select an external regenerative resistor of the same resistance and power as the internal one. If an external regenerative resistor is used, replace it with a new one between P_{\oplus} and C. Set 2002-1Bh (Power of external regenerative resistor) and 2002-1Ch (Resistance of external regenerative resistor) correctly according to the specifications of the used regenerative resistor.
4. The resistance of the regenerative resistor is too large, and energy absorption during braking is insufficient.	Measure the resistance of the external regenerative resistor between P_{\oplus} and C. Compare the measured value with the recommended value.	Connect a new external regenerative resistor of recommended resistance between P_{\oplus} and C. Set 2002-1Bh (Power of external regenerative resistor) and 2002-1Ch (Resistance of external regenerative resistor) correctly according to the specifications of the used regenerative resistor.
5. The motor is in abrupt acceleration/deceleration status. Maximum braking energy exceeds the energy absorption value.	Confirm the acceleration/deceleration time during running and measure the DC bus voltage between P_{\oplus} and \ominus to check whether the voltage exceeds the fault threshold during deceleration.	Ensure that the input voltage of main circuit is within the specifications. Then increase the acceleration/deceleration time within the allowed range.
6. The bus voltage sampling value has a large deviation from the actually measured value.	Check whether 200B-1Bh (Bus voltage) is within the following specifications: 220 V drive: 200B-1Bh > 420 V 380 V drive: 200B-1Bh > 760 V Measure the DC bus voltage between P_{\oplus} and \ominus and check whether the DC bus voltage is normal and smaller than 200B-1Bh.	Contact Inovance for technical support.

Probable Cause	Confirming Method	Corrective Action
7. The servo drive is faulty.	The fault persists after the main circuit is powered off and on for several times.	Replace the servo drive.

Er.410: Main circuit undervoltage

Probable Cause	Confirming Method	Corrective Action
1. The control power supply is instable or power failure occurs.	Measure whether the input voltage of the main circuit (RST) on non-drive side and drive side is within the following specifications: 220 V drive: Effective value: 220 to 240 V Allowed error: -10% to 10% (198 to 264 V)	Improve the power capacity.
2. Instantaneous power failure occurs.	380 V drive: Effective value: 380 to 440 V Allowed error: -10% to 10% (342 to 484 V) The voltages of all three phases need to be measured.	
3. The power voltage drops during running.	Check power input voltage and check whether main power is applied to other devices, resulting insufficient power capacity and voltage dip.	
4. Phase loss exists: Single-phase power supply is used for the three-phase servo drive.	Check whether main circuit wiring is correct and reliable, and whether phase loss fault detection (200A-01h) is shielded	Replace the cables and wire the power cables correctly Three-phase: R, S, T Single-phase: L1, L2
5. The servo drive is faulty.	Check whether 200B-1Bh (Bus voltage) is within the following specifications: 220 V drive: 200B-1Bh < 200 V 380 V drive: 200B-1Bh < 380 V The fault persists after the main circuit is powered off and on for several times.	Replace the servo drive.

Er.420: Main circuit phase loss

Probable Cause	Confirming Method	Corrective Action
1. The three-phase power cables are not connected well.	Check whether the power cables (RST) on servo drive side and non-servo drive side are in good condition and connected securely.	Replace the cables and wire the power cables correctly.
2. The single-phase power supply is used for the three-phase servo drive.	Confirm the power input specification of the servo drive and actual input voltage. Check whether the input voltage of the main circuit satisfies the following specifications: 220 V drive: Effective value: 220 to 240 V Allowed error: -10% to 10% (198 to 264 V)	For servo drive of 0.75 kW (2001-03h = 5), single-phase power supply is allowed. If the input voltage satisfies the specifications, set 200A-01h = 2 (Inhibit faults and warnings). If the input voltage does not satisfy the specifications, replace or adjust the power capacity.
3. The three-phase power supply is unbalanced or the voltages of three phases are too low.	380 V drive: Effective value: 380 to 440 V Allowed error: -10% to 10% (342 to 484 V) The voltages of all three phases need to be measured.	
4. The servo drive is faulty.	The fault persists after the main circuit is powered off and on for several times.	Replace the servo drive.

Er.430: Control power undervoltage

Probable Cause	Confirming Method	Corrective Action
1. The control power supply is instable or power failure occurs.	Check whether control power (L1C, L2C) is cut off or whether instantaneous power failure occurs.	Power on the servo drive again. If the fault is caused by abnormal power failure, ensure stable power supply.
	Check whether the input voltage of the control power cables satisfies the following specifications: 220 V drive: Effective value: 220 to 240 V Allowed error: -10% to 10% (198 to 264 V) 380 V drive: Effective value: 380 to 440 V Allowed error: -10% to 10% (342 to 484 V)	Improve the power capacity.
2. The control power cables are in poor contact.	Check whether the control power cables are well connected and whether their voltage on servo drive side (L1C, L2C) satisfies the preceding specifications.	Connect the motor power cables again or replace them.

Er.500: Motor overspeed

Probable Cause	Confirming Method	Corrective Action
1. UVW phase sequence is incorrect.	Check whether the servo drive power cables are in the same phase sequence as the servo drive UVW cables and motor UVW cables.	Connect the UVW cables according to the correct sequence.
2. The setting of 200A-09h is incorrect.	Check whether the overspeed threshold is smaller than the actual maximum motor speed. Overspeed threshold = 1.2 times of maximum motor speed (200A-09h = 0) Overspeed threshold = 200A-09h (200A-09h ≠ 0, and 200A-09h < 1.2 times of maximum motor speed)	Re-set the overspeed threshold according to the actual mechanical requirement.
3 The input reference is higher than the overspeed threshold.	Check whether the motor speed corresponding to the input reference exceeds the overspeed threshold. Position control mode: In CSP mode, view the gear ratio 6091-01h/6091-02h to check the position reference increment for a single synchronous cycle and convert it to speed. In PP mode, view the gear ratio 6091-01h/6091-02h and check the value of 6081h (Profile velocity). In HM mode, view the gear ratio 6091-01h/6091-02h, and determine 6099-01h and 6099-02h. In speed control mode, view the gear ratio 6091-01h/6091-02h, and the values of 60FFh (Target velocity), 2006-07h to 2006-0Ah, and 607Fh (Max profile velocity). In torque control mode, view the value of 2007-12h (Speed limit source) and the corresponding speed limit value.	Position control mode: CSP: Decrease the position reference increment for a single synchronous cycle, and the host controller needs to perform position ramp additionally when generating references. PP: Decrease the value of 6081h, or increase the acceleration/deceleration ramp (6083h, 6084h). HM: Decrease 6099-01h and 6099-02h, or increase the acceleration/deceleration ramp (609Ah). Decrease the gear ratio according to the actual conditions. Speed mode: Decrease the target velocity, speed limit value, gear ratio. In PV mode, increase the speed ramp 6083h and 6084h; in CSV mode, the host controller needs to perform speed ramp additionally. Torque control mode: Set the speed limit value smaller than the overspeed threshold.

Probable Cause	Confirming Method	Corrective Action
4. The motor speed overshoots.	Check whether the actual speed exceeds the overspeed threshold through the drive Inovance servo commissioning software.	Adjust the gain or mechanical conditions.
5. The servo drive is faulty.	The fault persists after the servo drive is powered on again.	Replace the servo drive.

Er.510: Pulse output overspeed

Probable Cause	Confirming Method	Corrective Action
The pulse frequency of the encoder frequency-division output exceeds the frequency upper limit allowed by the hardware (1 MHz).	When 2005-27h = 0 (Encoder frequency-division output), calculate the pulse frequency corresponding to the motor speed at occurrence of faults and check whether the pulse frequency exceeds the limit. Output pulse frequency (Hz) = $\frac{\text{Motor speed (RPM)}}{60} \times 2005-12h$	Decrease 2005-12h (Encoder frequency-division pulses), making the output pulse frequency below the frequency upper limit allowed by hardware within the speed range required by mechanical conditions.

Er.602: Angle auto-tuning failure

Er.610: Servo drive overload

Er.620: Motor overload

Probable Cause	Confirming Method	Corrective Action
1. Wiring of the motor and encoder is incorrect or in poor contact..	Check wirings between servo drive, servo motor and encoder according to the correct wiring diagram.	Connect the wirings according to the correct wiring diagram. Preferably use the cables recommended by Inovance. When self-made cables are used, prepare and connect the cables according to the hardware wiring instructions.
2. The load is too heavy. The motor keeps output of effective torque higher than the rated torque for a long time.	Confirm the overload characteristics of the servo drive or servo motor. Check whether the average load ratio (200B-0Dh) is greater than 100.0% for long time.	Use a servo drive of larger capacity and matching servo motor. Reduce the load and increase the acceleration/deceleration time.
3. Acceleration/deceleration is too frequent or the load inertia is too large.	Calculate the load inertia ratio or perform the load inertia ratio auto-tuning. Then view 2008-10h (Load inertia ratio). Check the single running cycle when the servo motor runs circularly.	Increase acceleration/deceleration time during single running.
4. The gain is improper, or the stiffness is too high.	Check if the motor vibrates and produces noise during running.	Adjust the gain.
5. The servo drive or motor model is set incorrectly.	view the serial encoder motor model in 2000-06h and servo drive model in 2001-03h.	View the servo drive nameplate and set the servo drive model in 2001-03h correctly and use a matching servo motor according to section 1.3.

Probable Cause	Confirming Method	Corrective Action
6. Locked-rotor occurs due to mechanical factors, resulting in very heavy load during running.	<p>Check the running reference and motor speed (200B-01h) through Inovance servo commissioning software or keypad:</p> <p>Running reference in position control: 200B-0Eh (Input reference pulse counter)</p> <p>Running reference in speed control: 200B-02h (Speed reference)</p> <p>Running reference in torque control: 200B-03h (Internal torque reference)</p> <p>Check that the running reference is not 0 but the motor speed is 0 in corresponding mode.</p>	Eliminate mechanical factors.
7. The servo drive is faulty.	The fault persists after the servo drive is powered on again.	Replace the servo drive.

Er.630: Motor rotor locked

Probable Cause	Confirming Method	Corrective Action
1. Power output (UVW) phase loss or incorrect phase sequence occurs in the servo drive.	Perform motor trial running when there is no load and check motor wirings.	Correct the wiring or replace the cables.
2. The servo drive UVW cables or encoder cable breaks.	Check wirings.	Correct the wiring or replace the cables.
3. The motor rotor is locked due to mechanical factors.	<p>Check the running reference and motor speed (200B-01h) through Inovance servo commissioning software or keypad:</p> <p>Running reference in position control: 200B-0Eh (Input reference pulse counter)</p> <p>Running reference in speed control: 200B-02h (Speed reference)</p> <p>Running reference in torque control: 200B-03h (Internal torque reference)</p> <p>Check that the running reference is not 0 but the motor speed is 0 in corresponding mode.</p>	Eliminate mechanical factors.

Er.650: Heatsink overheat

Probable Cause	Confirming Method	Corrective Action
1. The ambient temperature is too high.	Measure the ambient temperature	Improve the cooling conditions to reduce the ambient temperature.
2. The servo drive is powered off and powered on for several times to reset the overload fault.	View the fault records (set 200B-22h and view 200B-23h) and check whether an overload fault (Er.610, Er.620, Er.630, Er.650, Er.909, Er.920, Er.922) occurs.	Change the fault reset method. After overload occurs, wait 30s and then perform the reset operation. Increase the capacity of the servo drive and servo motor, increase acceleration/deceleration time, and reduce load.
3. The fan is damaged.	Observe whether the fan works during running.	Replace the servo drive.
4. The installation direction and clearance away from other servo drives are improper.	Check whether installation of servo drive is proper.	Install the servo drive according to the requirements.

Probable Cause	Confirming Method	Corrective Action
5. The servo drive is faulty.	The fault persists after restart five minutes after power-off.	Replace the servo drive.

Er.731: Encoder battery failed

Probable Cause	Confirming Method	Corrective Action
The battery is not connected during power-off.	Check whether the battery is connected during power-off.	Set 200D-15h = 1 to remove the fault.
The battery voltage is too low.	Measure the battery voltage.	Use a new battery of matching voltage.

Er.733: Encoder multi-turn counting error

Probable Cause	Confirming Method	Corrective Action
The encoder is faulty.	Set 200D-15h = 2 to remove the fault. Er.733 persists after power-on again.	Replace the motor.

Er.735: Encoder multi-turn counting overflow

Probable Cause	Confirming Method	Corrective Action
Encoder multi-turn counting overflow is detected when 2002-02h = 1.	-	Set 200D-15h = 1 to remove the fault.

Er.740: Encoder interference

Probable Cause	Confirming Method	Corrective Action
1. The encoder wiring is incorrect.	Check the encoder wiring.	Connect the encoder cable correctly.
2. Connection of the encoder cable becomes loose.	Check whether on-site vibration is too large, which loosens the encoder cable and even damages the encoder.	Re-connect the encoder cable securely.
3. Interference on Z signal of the encoder exists.	<p>Check on-site wirings:</p> <p>Check whether there is large equipment generating interference on-site and whether there are interference sources such as various variable-frequency devices inside the cabinet.</p> <p>Make servo drive in "rdy" status and rotate the motor shaft counterclockwise (CCW) manually, and observe whether 200B-0Bh (Electrical angle) increases/decreases smoothly, and whether one revolution corresponds to five 0 to 360° (for Z series motor; it is four 0 to 360° for X series motor).</p> <p>If 200B-0Bh changes abnormally during rotation, it indicates that a fault occurs on encoder.</p> <p>If there is no alarm during rotation but the system alarms during servo running, it is likely that interference exists.</p>	<p>Preferably use the cables recommended by Inovance.</p> <p>If non-standard cable is used, check whether the cable meets requirements and is STP cable.</p> <p>Do not bundle motor cables and encoder cables together. Ensure the servo motor and servo drive are well grounded.</p> <p>Check that the connectors at both ends of the encoder are in good contact.</p>
4. The encoder is faulty.	<p>Use a new encoder cable. If the fault no longer occurs after replacement, it indicates that the original encoder cable is damaged.</p> <p>Place motor at the same position, power on the system several times and observe change of 200B-0Bh. The electrical angle must be within $\pm 30^\circ$.</p>	<p>Use a new encoder cable.</p> <p>Replace the motor if the encoder is faulty.</p>

Er.770: External encoder scale fault

Probable Cause	Confirming Method	Corrective Action
Frequency-division output is not forbidden.	Check whether H05-38 (2005-27h) is set to 2 (Frequency-division and synchronous output forbidden).	Set H05-38 to 2.
When the fully closed-loop function or customized pulse input function is used, the level difference between any two signals of A+/A-, B+/B-, Z+/Z- does not meet the requirement. The level different is equal to or larger than 2 V.	Measure the level difference between two signals of A+/A-, B+/B-, Z+/Z-.	Adjust the level to meet the specifications. Note: When using an external encoder without Z signal, pull up Z+ to above 2 V and make Z- grounded.

Er.A33: Encoder data abnormal

Probable Cause	Confirming Method	Corrective Action
1. The serial encoder cable breaks or becomes loose.	Check wirings.	Check connection of the encoder cable to see whether incorrect connection, wire breaking, or poor contact exists. If motor cables and encoder cable are bundled together, separate them.
2. Reading and writing of the serial encoder parameters are abnormal.	If the servo drive is powered off and powered on again several times but the fault persists, it indicates that the encoder is faulty.	Replace the servo motor.

Er.A34: Encoder communication check abnormal

Probable Cause	Confirming Method	Corrective Action
1. The servo drive model and the motor model do not match.	View the servo drive and servo motor nameplates to check that the equipment used is Inovance IS620N series servo drive and 20-bit servo motor (-U2***). Check whether 2000-01h (Motor SN) is 14000.	Use matching servo drive and servo motor.
2. The encoder cable breaks.	Check whether the encoder cable breaks and whether it is connected to the servo drive and motor securely.	Use a new encoder cable and connect it securely.

Er.A35: Z signal lost

Probable Cause	Confirming Method	Corrective Action
1. Z signal is lost because of encoder faults.	Use a new encoder cable and connect it correctly. Then rotate the motor shaft manually and check whether the fault persists.	Replace the servo motor.
2. Poor contact or incorrect connection results in Z signal lost.	Rotate the motor shaft manually and check whether the fault persists.	Connect the encoder cable correctly or replace the cable.

Er.B00: Position deviation excess

Probable Cause	Confirming Method	Corrective Action
1. Power output (UVW) phase loss or incorrect phase sequence occurs in the servo drive.	Perform motor trial running when there is no load and check motor wirings.	Correct the wiring or replace the cables.

Probable Cause	Confirming Method	Corrective Action
2. The servo drive UVW cables or encoder cable breaks.	Check wirings.	Reconnect the UVW cables. The servo motor UVW cables must be connected to the servo drive UVW cables correspondingly. If necessary, replace all cables and ensure reliable connection.
3. The motor rotor is locked due to mechanical factors.	Check the running reference and motor speed (200B-01h) through Inovance servo commissioning software or keypad: Running reference in position control: 200B-0Eh (Input reference pulse counter) Running reference in speed control: 200B-02h (Speed reference) Running reference in torque control: 200B-03h (Internal torque reference) Check that the running reference is not 0 but the motor speed is 0 in corresponding mode.	Eliminate mechanical factors.
4. The servo drive gain is too low.	Check the position loop gain and speed loop gain of the servo drive. 1st gain: 2008-01h to 2008-03h 2nd gain: 2008-04h to 2008-06h	Adjust the gain manually or perform gain auto-tuning.
5. The position reference increment is too large.	Position control mode: In CSP mode, view the gear ratio 6091-01h/6091-02h to check the speed reference increment for a single synchronous cycle and convert it to speed. In PP mode, view the gear ratio 6091-01h/6091-02h and check the value of 6081h (Profile velocity). In HM mode, view the gear ratio 6091-01h/6091-02h, and determine 6099-01h and 6099-02h.	CSP: Decrease the position reference increment for a single synchronous cycle, and the host controller needs to perform position ramp additionally when generating references. PP: Decrease the value of 6081h, or increase the acceleration/deceleration ramp (6083h, 6084h). HM: Decrease 6099-01h and 6099-02h, or increase the acceleration/deceleration ramp (609Ah). Decrease the gear ratio according to the actual conditions.
6. Relative to the running condition, 6065h (Following error window) is too small.	Check whether the setting of 6065h is too small.	Increase the value of 6065h.
7. The servo drive or motor is faulty.	Monitor the running curve through the oscilloscope function in Inovance servo commissioning software: Position reference, position feedback, speed reference, torque reference	If the position reference is not 0, but the position feedback is always 0, replace the servo drive or motor.

Er.B01: Position reference excess

Probable Cause	Confirming Method	Corrective Action
1. The position reference increment is excessive.	Check the target position reference increment (motor speed reference) of adjacemnt synchronization periods.	Decrease the target position reference increment.

2. The target position (607Ah) is not set the same as the current position before more switchover or the servo drive is enabled.	Check whether the mode switchover or servo ON operation is performed in the software of the host controller.	Assign the value of the current position to the target position (607Ah) before the mode switchover or servo ON operation.
3. Synchronization is lost the synchronization period, causing accumulation of position references.	Monitor the SYNC and IRQ phases with the oscilloscope function of the commissioning software and check whether large fluctuation occurs.	Set the synchronization offset parameter to 0 of the host controller is AM600, and check communication with the host controller of other types.
4. Motor speed limit is incorrect.	Check settings of maximum motor speed and maximum profile speed.	Check that the maximum motor speed meets the requirement, and that the maximum profile speed in 607Fh is too small.

Er.B02: Position deviation exceeding threshold in fully closed-loop

Probable Cause	Confirming Method	Corrective Action
1. Power output (UVW) phase loss or incorrect phase sequence occurs in the servo drive.	Perform motor trial running when there is no load and check motor wirings.	Correct the wiring or replace the cables.
2. The servo drive UVW cables or encoder cable breaks.	Check wirings.	Reconnect the UVW cables. The servo motor UVW cables must be connected to the servo drive UVW cables correspondingly. If necessary, replace all cables and ensure reliable connection.
3. The motor rotor is locked due to mechanical factors.	Check the running reference and motor speed (200B-01h) with Inovance servo commissioning software or keypad: Running reference in position control: 200B-0Eh (Input reference pulse counter) Running reference in speed control: 200B-02h (Speed reference) Running reference in torque control: 200B-03h (Internal torque reference) Check that the running reference is not 0 but the motor speed is 0 in corresponding mode.	Eliminate mechanical factors.
4. The servo drive gain is too low.	Check the position loop gain and speed loop gain of the servo drive. 1st gain: 2008-01h to 2008-03h 2nd gain: 2008-04h to 2008-06h	Adjust the gain manually or perform gain auto-tuning.
5. The position reference increment is too large.	Position control mode: In CSP mode, view the gear ratio 6091-01h/6091-02h to check the speed reference increment for a single synchronous cycle and convert it to speed. In PP mode, view the gear ratio 6091-01h/6091-02h and check the value of 6081h (Profile velocity). In HM mode, view the gear ratio 6091-01h/6091-02h, and determine 6099-01h and 6099-02h.	CSP: Decrease the position reference increment for a single synchronous cycle, and the host controller needs to perform position ramp additionally when generating references. PP: Decrease the value of 6081h, or increase the acceleration/deceleration ramp (6083h, 6084h). HM: Decrease 6099-01h and 6099-02h, or increase the acceleration/deceleration ramp (609Ah). Decrease the gear ratio according to the actual conditions.

Probable Cause	Confirming Method	Corrective Action
6. Relative to the running condition, 200F-09h (Fully closed-loop position deviation excess threshold) is too small.	Check whether the setting of 200F-09h is too small.	Increase the value of 200F-09h.
7. The servo drive or motor is faulty.	Monitor the running curve through the oscilloscope function in Inovance servo commissioning software: Position reference, position feedback, speed reference, torque reference	If the position reference is not 0, but the position feedback is always 0, replace the servo drive or motor.

Er.B03: Electronic gear ratio setting exceeding limit

Probable Cause	Confirming Method	Corrective Action
1. The electronic gear ratio setting exceeds the preceding range.	Check whether the ratio value of 6091-01h/6091-02h exceeds the preceding range.	Set the gear ratio within the required range.
2. Parameters are modified in incorrect sequence.	Check whether the gear ratio is within the range, but this fault is reported during modification of the gear ratio.	Reset the fault or power on the system again.

Er.B04: Parameter setting error with fully closed-loop function

Probable Cause	Confirming Method	Corrective Action
When the fully closed-loop function is used and the position reference source is internal position reference, switchover between internal encoder feedback and external encoder feedback is enabled.	Check whether 200F-01h = 2. Check whether the position reference source is internal position reference: multi-position and position change on fly.	In fully closed-loop mode, when the position reference source is internal position reference, only external encoder feedback can be used, that is, 200F-01h = 1.

5.2 Troubleshooting of Warnings

Er.110: Setting error of frequency-division pulse output

Probable Cause	Confirming Method	Corrective Action
The number of encoder frequency-division pulses does not conform to the specification.	For the incremental encoder, the frequency-division pulses per revolution must not exceed the encoder PPR. The resolution of 20-bit serial incremental encoder is 1048576 P/r. The resolution of 2500-PPR incremental encoder is 10000 P/r. For the absolute encoder, the number of frequency-division pulses must not exceed 1/4 of the encoder resolution.	Re-set the frequency-division pulses per revolution in 2005-12h according to the specification.

Er.601: Homing timeout

Probable Cause	Confirming Method	Corrective Action
1. The home switch fails.	There is only high-speed searching and no low-speed searching during the homing operation. After high-speed searching of homing, the drive keeps reverse low-speed searching.	If a hardware DI is used, check whether DI function FunIN.31: HomeSwitch (home switch) has been allocated to a DI in group 2003h and then check wiring of the DI. Manually change the DI logic and observe whether the servo drive receives DI level change in 200B-04h. If not, wiring of the DI is incorrect. If yes, a fault occurs during the homing operation. Carry out the homing operation correctly. If a virtual DI is used, check whether the VDI is used correctly.
2. The search time is too short.	Check whether the time for homing set in 2005-24h is too short.	Increase 2005-24h.
3. The speed for searching home switch signal at high speed is too small.	Check the distance from the initial position of homing to the home switch. Then check whether 6099-01h (Speed during search for switch) is too small, resulting in a very long time of finding home switch.	Increase 6099-01h.
4. The setting of the home switch is improper.	Check whether the limit signals at two sides are active simultaneously. Check whether a limit signal is active simultaneously with the deceleration signal or home signal.	Set the position of the hardware switch properly.

Er.730: Encoder battery warning

Probable Cause	Confirming Method	Corrective Action
The battery voltage of the absolute encoder is lower than 3.0 V.	Measure the battery voltage.	Use a new battery of matching voltage.

Er.900: DI emergency braking

Probable Cause	Confirming Method	Corrective Action
DI function FunIN.34: EmergencyStop is triggered.	Check whether the logic of DI allocated with FunIN.34: EmergencyStop is activated.	Check the running mode and clear the DI braking signal on the prerequisite of ensuring safety.

Er.909: Motor overload warning

Probable Cause	Confirming Method	Corrective Action
1. Wiring of the motor and encoder is incorrect or in poor contact.	Check wirings between servo drive, servo motor and encoder according to the correct wiring diagram.	Connect the wirings according to the correct wiring diagram. Preferably use the cables recommended by Inovance. When self-made cables are used, prepare and connect the cables according to the hardware wiring instructions.
2. The load is too heavy. The motor keeps output of effective torque higher than the rated torque for a long time.	Confirm overload characteristics of the servo drive or motor. Check whether the average load ratio (200B-0Dh) is larger than 100.0% for a long time.	Use a servo drive of larger capacity and matching servo motor. Reduce the load and increase the acceleration/deceleration time.

Probable Cause	Confirming Method	Corrective Action
3. Acceleration/deceleration is too frequent or the load inertia is too large.	Calculate the load inertia ratio or perform the load inertia ratio auto-tuning. Then view 2008-10h (Load inertia ratio). Check the single running cycle when the servo motor runs circularly.	Increase the acceleration/ deceleration time.
4. The gain is improper, or the stiffness is too high.	Check whether the motor vibrates and produces abnormal noise during running.	Adjust the gain.
5. The servo drive or motor model is set incorrectly.	view the serial encoder motor model in 2000-06h and servo drive model in 2001-03h.	View the servo drive nameplate and set the servo drive model in 2001-03h correctly and use a matching servo motor according to section 1.3.
6. Locked-rotor occurs due to mechanical factors, resulting in very heavy load during running.	Check the running reference and motor speed (200B-01h) through Inovance servo commissioning software or keypad: Running reference in position control: 200B-0Eh (Input reference pulse counter) Running reference in speed control: 200B-02h (Speed reference) Running reference in torque control: 200B-03h (Internal torque reference) Check that the running reference is not 0 but the motor speed is 0 in corresponding mode.	Eliminate mechanical factors.
7. The servo drive is faulty.	Power off and on the servo drive.	Replace the servo drive.

Er.920: Regenerative resistor overload

Probable Cause	Confirming Method	Corrective Action
1. The cable of the external regenerative resistor is in poor connection, becomes loose or breaks.	Disconnect the external regenerative resistor and measure whether the resistance is ∞ . Measure whether the resistance between P_{\oplus} and C is ∞ .	Use a new external regenerative resistor. If the resistance measured is the same as the nominal value, connect the regenerative resistor between P_{\oplus} and C. Connect the external regenerative resistor between P_{\oplus} and C with a new cable.
The jumper across terminals P_{\oplus} and D is disconnected or breaks when the internal regenerative resistor is used.	Measure whether the resistance between P_{\oplus} and C is ∞ .	Connect terminals P_{\oplus} and D properly with a good cable.
3. The setting of 2002-1Ah is incorrect when the external regenerative resistor is used.	View the setting value of 2002-1Ah. Check if the measured resistance of the regenerative resistor between P_{\oplus} and C by comparing it with the regenerative resistor specification table in section 1.1.3.	Set 2002-1Ah correctly: 2002-1Ah = 1 (External, naturally ventilated) 2002-1Ah = 2 (External, forcible cooling)
4. The resistance of the external regenerative resistor used is too large.	Check whether the setting value of 2002-1Ch is larger than the resistance of the regenerative resistor between P_{\oplus} and C.	Select a proper regenerative resistor according to the regenerative resistor specification table in section 1.1.3.
5. 2002-1Ch (Resistance of external regenerative resistor) is larger than the resistance of the external regenerative resistor actually used.		Set 2002-1Ch according to the resistance of the external regenerative resistor actually used.

Probable Cause	Confirming Method	Corrective Action
6. The input voltage of the main circuit exceeds the specifications.	Check whether the input voltage of the main circuit satisfies the following specifications: 220 V drive: Effective value: 220 to 240 V Allowed error: -10% to 10% (198 to 264 V) 380 V drive: Effective value: 380 to 440 V Allowed error: -10% to 10% (342 to 484 V)	Replace or adjust the power supply according to the specifications.
7. The load inertia is too large.	Perform inertia auto-tuning or calculate the total inertia of machine based on mechanical parameters. The actual inertia ratio does not exceed 30.	Select a large external regenerative resistor and set 2002-1Bh (Power of external regenerative resistor) consistent with the actual value. Select a larger servo drive.
8. The motor speed is very high, making deceleration not completed within the required time. The motor is in continuous deceleration status in cyclic running.	View the motor speed curve in cycle running and check whether the motor is in deceleration status for a long period.	If allowed, reduce the load, increase the acceleration/deceleration time, and increase the motor running period.
9. The capacity of the servo drive or regenerative resistor is insufficient.	View the motor's single cycle speed curve and calculate whether maximum braking energy can be absorbed completely.	
10. The servo drive is faulty.	-	Replace the servo drive.

Er.922: Resistance of the external regenerative resistor too small

Probable Cause	Confirming Method	Corrective Action
When an external regenerative resistor is used (2002-1Ah = 1 or 2), resistance of the external regenerative resistor is smaller than the minimum value required by the servo drive.	Measure the resistance of the external regenerative resistor between P_{\oplus} and C and check whether it is smaller than 2002-16h.	If yes, connect an external regenerative resistor matching the servo drive between P_{\oplus} and C and set 2002-1Ch (Resistance of external regenerative resistor) to the actual value. If no, set 2002-1Ch to the actual value.

Er.939: Motor power cable breaking

Probable Cause	Confirming Method	Corrective Action
The motor power cables break.	Check whether the difference between 200B-19h (Phase current effective value) and 200B-03h (Internal torque reference) reaches over 500%, and whether 200B-01 (Actual motor speed) is smaller than 1/4 of the rated motor speed.	Reconnect the motor power cables. Use new cables if necessary.

Er.941: Parameter modification taking effect only after power-on again

Probable Cause	Confirming Method	Corrective Action
Parameters with the effective condition "power-on again" are modified.	Check whether such parameters are modified.	Power on the servo drive again.

Er.942: Parameter storage too frequent

Probable Cause	Confirming Method	Corrective Action
A great number of parameters are modified and stored frequently to EEPROM (200C-0Eh = 1).	Check whether the host controller performs frequent and fast parameter modification on the servo drive.	Check the running mode. For parameters that need not be stored in EEPROM, set 200C-0Eh to 0 before the wiring operation of the host computer.

Er.950: Positive limit switch warning

Probable Cause	Confirming Method	Corrective Action
The logic of the DI allocated with FunIN.14: P-OT (Positive limit switch) is valid.	Check if a DI is allocated with FunIN14 (P-OT) in group 2003h. View whether the DI logic is valid in 200B-04h (Monitored DI states).	Check the running mode. On the prerequisite of ensuring safety, send a reverse reference or rotate the motor to make the logic of the DI with the positive limit switch function become invalid.

Er.952: Negative limit switch warning

Probable Cause	Confirming Method	Corrective Action
The logic of the DI allocated with FunIN.15: P-OT (Negative limit switch) is valid.	Check if a DI is allocated with FunIN15 (N-OT) in group 2003h. View whether the DI logic is valid in 200B-04h (Monitored DI states).	Check the running mode. On the prerequisite of ensuring safety, send a reverse reference or rotate the motor to make the logic of DI with the negative limit switch function become invalid.

Er.980: Encoder internal fault

Probable Cause	Confirming Method	Corrective Action
An encoder internal fault occurs.	If the servo drive is powered off and powered on again several times but the warning is still reported, it indicates that the encoder is faulty.	Replace the servo motor.

Er.990: Power input phase loss warning

Probable Cause	Confirming Method	Corrective Action
When 200A-01h = 1 (Enable faults and warnings), the 0.75 kW three-phase servo drive (2001-03h = 5) can run under single-phase power, but this warning is reported when single-phase power is applied.	Check whether the three-phase servo drive allows running under single-phase power.	If the warning persists when a three-phase servo drive is connected to three-phase power, rectify this warning as Er.420 (Power cable phase loss). If the warning persists when a three-phase servo drive allows single-phase power input, set 200A-01h to 0.

Er.998: Homing mode setting incorrect

Probable Cause	Confirming Method	Corrective Action
1. The homing mode not supported, 15/16/31/32 is set in 6098h.	View the setting of 6098h.	Set 6098h correctly.

5.3 Internal Faults

When any of the following fault occurs, contact Inovance for technical support.

Er.602: Angle auto-tuning failure

Er.220: Phase sequence incorrect

Er.A40: Motor auto-tuning failure

Er.111: Servo drive internal parameter abnormal

5.4 Rectification of Communication Faults

This part describes how to rectify communication faults.

Er.D09: Software upper/lower limit setting incorrect

Probable Cause	Confirming Method	Corrective Action
The lower limit of software position is larger than the upper limit.	View the setting of 607D-01h and 607D-02h.	Set 0x607D correctly, and ensure 607D-1h < 607D-2h.

Er.D10: Home offset setting incorrect

Probable Cause	Confirming Method	Corrective Action
The home offset is set outside the software position lower/upper limit.	View the setting of 607D-01h, 607D-02h, and 607Ch.	Set 607D correctly, ensure $607D-01h \leq 607Ch \leq 607D-02h$.

Er.E08: Synchronization loss

Probable Cause	Confirming Method	Corrective Action
1. Abnormal signal receiving of the slave during communication	<p>Check whether the shielded twisted pair is used as communication cable.</p> <p>Check whether the servo drive is well grounded.</p> <p>Check whether the Ethernet port of the drive is damaged.</p>	<p>Use the shielded twisted pair.</p> <p>Connect the cable according to the wiring instructions.</p> <p>Check the network connection status through the first LED from the left.</p>
2. Abnormal signal transmit of the master during communication	Check the synchronization performance of the host.	<p>Identify the synchronization performance of the host.</p> <p>Increase the permissible interruption loss times (200C-2Dh) of the slave.</p>
3. The servo drive is in enabling state and the network status is switched from OP to non-OP.	Check whether the network status is switched from OP to non-OP.	Check the network status switchover program of the host.

Er.E11: The XML configuration file is not burnt.

Cause:

The XML configuration file is not burnt.

Probable Cause	Confirming Method	Corrective Action
1. The device configuration file is not burnt.	The slave ID scanned by the host controller is empty.	Burn the device configuration file
2. The servo drive is faulty.	3. The servo drive is faulty.	Replace the servo drive.

Er.E12: Network initialization failure

Probable Cause	Confirming Method	Corrective Action
1. The FPGA firmware is not burnt.	Check whether 2001-02h is 01XX.Y.	Burn the FPGA firmware.
2. The equipment configuration file is not burnt.	After connecting the servo drive to the master, view whether the first left LED on the keypad displays the states of the corresponding network port, and the second LED displays a number among 1, 2, 4, 8.	2. Burn the equipment configuration file.
3. The servo drive is faulty.	3. The servo drive is faulty.	Replace the servo drive.

Er.E13: Synchronization cycle setting incorrect

Probable Cause	Confirming Method	Corrective Action
The synchronization cycle is not a integral multiple of 125 us or 250 us.	Check the setting of the synchronization cycle.	Modify the synchronization cycle to an integral multiple of 125 us or 250 us.

Er.E15: Synchronization cycle error being large

Probable Cause	Confirming Method	Corrective Action
The synchronization cycle error exceeds the threshold.	Measure the synchronization cycle through a digital oscilloscope or the oscilloscope function in Inovance servo commissioning software.	Increase 200C-2Dh and carry out the test. If this fault persists, set 200C-2Ch to 2.

Er.770: External encoder scale fault

Probable Cause	Confirming Method	Corrective Action
When the fully closed-loop function or customized pulse input function is used, the level difference between any two signals of A+/A-, B+/B-, Z+/Z- does not meet the requirement. The level different is equal to or larger than 2 V.	Measure the level difference between two signals of A+/A-, B+/B-, Z+/Z-.	Adjust the level to meet the specifications. Note: When using an external encoder without Z signal, pull up Z+ to above 2 V and make Z- grounded.

Chapter 6 Overview of Object Dictionary

The abbreviations in the table are described as follows:

Type	Abbreviation	Meaning
Setting Condition (SC)	Ru	It is possible to modify the parameter with the drive in the Running status.
	St	It is not possible to modify the parameter with the drive in the Stop status.
	Dp	The parameter is the actual measured value and can only be Displayed.
Effective Condition ("ET")	Im	Modification on the parameter takes effect Immediately.
	Po	Modification on the parameter takes effect upon Power-on again.
	St	Modification on the parameter takes effect upon Stop.

Reference unit: Ref; Enc unit: Enc

User position unit: UPU; User velocity unit: UVU

6.1 Object Group 1000h

Group 1000h includes the parameters for CANopen communication.

Index	Sub-index	Name	Access	PDO Mapping	Data Type	Unit	Data Range	Default
1000	00	Device type	RO	NO	UINT32	-	-	0x00020192
1008	00	Manufacturer device name	RO	NO	-	-	-	IS620-ECAT
1009	00	Manufacturer hardware version	RO	NO	-	-	-	-
100A	00	Manufacturer software version	RO	NO	-	-	-	-
1018	1018h identity object		RO	NO	Uint32		OD Data Range	OD Default
	00	Highest sub-index supported	RO	NO	UINT8	-	-	04 hex
	01	Vendor ID	RO	NO	UINT32	-	-	0010 0000 hex
	02	Product code	RO	NO	UINT32	-	-	0x000C0108
	03	Revision number	RO	NO	UINT32	-	-	0x00010001
1C00	Sync Manager Communication Type		RO	NO	Uint32		OD Data Range	OD Default
	00	Number of Sync Manager channels	RO	NO	UINT8	-	-	04 hex
	01	Communication type SM0	RO	NO	UINT8	-	-	01hex
	02	Communication type SM1	RO	NO	UINT8	-	-	02hex
	03	Communication type SM2	RO	NO	UINT8	-	-	03hex
	04	Communication type SM3	RO	NO	UINT8	-	-	04hex

Index	Sub-index	Name	Access	PDO Mapping	Data Type	Unit	Data Range	Default
1600	Receive PDO mapping 1		RW	NO	Uint32		OD Data Range	OD Default
	00	Number of mapped application objects in RPDO1	RW	NO	UINT8	-	0 to 10	3
	01	1st application object	RW	NO	UINT32	-	0 to 4294967295	6040 0010
	02	2nd application object	RW	NO	UINT32	-	0 to 4294967295	607A 0020
	03	3rd application object	RW	NO	UINT32	-	0 to 4294967295	60B8 0010
	04	4th application object	RW	NO	UINT32	-	0 to 4294967295	-
	05	5th application object	RW	NO	UINT32	-	0 to 4294967295	-
	06	6th application object	RW	NO	UINT32	-	0 to 4294967295	-
	07	7th application object	RW	NO	UINT32	-	0 to 4294967295	-
	08	8th application object	RW	NO	UINT32	-	0 to 4294967295	-
	09	9th application object	RW	NO	UINT32	-	0 to 4294967295	-
0A	10th application object	RW	NO	UINT32	-	0 to 4294967295	-	
1701	Receive PDO mapping 258		RO	NO	Uint32		OD Data Range	OD Default
	00	Number of mapped application objects in RPDO258	RO	NO	UINT8	-	-	04hex
	01	1st application object	RO	NO	UINT32	-	-	6040 0010
	02	2nd application object	RO	NO	UINT32	-	-	607A 0020
	03	3rd application object	RO	NO	UINT32	-	-	60B8 0010
04	4th application object	RO	NO	UINT32	-	-	60FE 0120	
1702	Receive PDO mapping 259		RO	NO	Uint32		OD Data Range	OD Default
	00	Number of mapped application objects in RPDO259	RO	NO	UINT8	-	-	07 hex
	01	1st application object	RO	NO	UINT32	-	-	6040 0010
	02	2nd application object	RO	NO	UINT32	-	-	607A 0020
	03	3rd application object	RO	NO	UINT32	-	-	60FF 0020
	04	4th application object	RO	NO	UINT32	-	-	6071 0010
	05	5th application object	RO	NO	UINT32	-	-	6060 0008
	06	6th application object	RO	NO	UINT32	-	-	60B8 0010
07	7th application object	RO	NO	UINT32	-	-	607F0020	

Index	Sub-index	Name	Access	PDO Mapping	Data Type	Unit	Data Range	Default
1703		Receive PDO mapping 260	RO	NO	Uint32		OD Data Range	OD Default
	00	Number of mapped application objects in RPDO260	RO	NO	UINT8	-	-	07 hex
	01	1st application object	RO	NO	UINT32	-	-	6040 0010
	02	2nd application object	RO	NO	UINT32	-	-	607A 0020
	03	3rd application object	RO	NO	UINT32	-	-	60FF 0020
	04	4th application object	RO	NO	UINT32	-	-	6060 0008
	05	5th application object	RO	NO	UINT32	-	-	60B8 0010
	06	6th application object	RO	NO	UINT32	-	-	60E0 0010
	07	7th application object	RO	NO	UINT32	-	-	60E1 0010
1704		Receive PDO mapping 261	RO	NO	Uint32		OD Data Range	OD Default
	00	Number of mapped application objects in RPDO261	RO	NO	UINT8	-	-	09 hex
	01	1st application object	RO	NO	UINT32	-	-	6040 0010
	02	2nd application object	RO	NO	UINT32	-	-	607A 0020
	03	3rd application object	RO	NO	UINT32	-	-	60FF 0020
	04	4th application object	RO	NO	UINT32	-	-	6071 0010
	05	5th application object	RO	NO	UINT32	-	-	6060 0008
	06	6th application object	RO	NO	UINT32	-	-	60B8 0010
	07	7th application object	RO	NO	UINT32	-	-	607F0020
	08	8th application object	RO	NO	UINT32	-	-	60E0 0010
	09	9th application object	RO	NO	UINT32	-	-	60E1 0010
1705		Receive PDO mapping 262	RO	NO	Uint32		OD Data Range	OD Default
	00	Number of mapped application objects in RPDO262	RO	NO	UINT8	-	-	08hex
	01	1st application object	RO	NO	UINT32	-	-	6040 0010
	02	2nd application object	RO	NO	UINT32	-	-	607A 0020
	03	3rd application object	RO	NO	UINT32	-	-	60FF 0020
	04	4th application object	RO	NO	UINT32	-	-	6060 0008
	05	5th application object	RO	NO	UINT32	-	-	60B8 0010
	06	6th application object	RO	NO	UINT32	-	-	60E0 0010
	07	7th application object	RO	NO	UINT32	-	-	60E1 0010
	08	8th application object	RO	NO	UINT32	-	-	60B2 0010

Index	Sub-index	Name	Access	PDO Mapping	Data Type	Unit	Data Range	Default
1A00	Transmit PDO mapping 1		RW	NO	Uint32	-	OD Data Range	OD Default
	00	Number of mapped application objects in TPDO1	RW	NO	UINT8	-	0 to 10	7
	01	1st application object	RW	NO	UINT32	-	0 to 4294967295	6041 0010
	02	2nd application object	RW	NO	UINT32	-	0 to 4294967295	6064 0020
	03	3rd application object	RW	NO	UINT32	-	0 to 4294967295	60B9 0010
	04	4th application object	RW	NO	UINT32	-	0 to 4294967295	60BA 0020
	05	5th application object	RW	NO	UINT32	-	0 to 4294967295	60BC0020
	06	6th application object	RW	NO	UINT32	-	0 to 4294967295	603F0010
	07	7th application object	RW	NO	UINT32	-	0 to 4294967295	60FD0020
	08	8th application object	RW	NO	UINT32	-	0 to 4294967295	-
	09	9th application object	RW	NO	UINT32	-	0 to 4294967295	-
0A	10th application object	RW	NO	UINT32	-	0 to 4294967295	-	
1B01	Transmit PDO mapping 258		RO	NO	Uint32	-	OD Data Range	OD Default
	00	Number of mapped application objects in TPDO258	RO	NO	UINT8	-	-	8
	01	1st application object	RO	NO	UINT32	-	-	603F0010
	02	2nd application object	RO	NO	UINT32	-	-	6041 0010
	03	3rd application object	RO	NO	UINT32	-	-	6064 0020
	04	4th application object	RO	NO	UINT32	-	-	6077 0010
	05	5th application object	RO	NO	UINT32	-	-	60F40020
	06	6th application object	RO	NO	UINT32	-	-	60B90010
	07	7th application object	RO	NO	UINT32	-	-	60BA0020
08	8th application object	RO	NO	UINT32	-	-	60FD0020	

Index	Sub-index	Name	Access	PDO Mapping	Data Type	Unit	Data Range	Default
1B02		Transmit PDO mapping 259	RO	NO	Uint32	-	OD Data Range	OD Default
	00	Transmit PDO mapping 259	RO	NO	UINT8	-	-	9
	01	1st application object	RO	NO	UINT32	-	-	603F0010
	02	2nd application object	RO	NO	UINT32	-	-	6041 0010
	03	3rd application object	RO	NO	UINT32	-	-	6064 0020
	04	4th application object	RO	NO	UINT32	-	-	6077 0010
	05	5th application object	RO	NO	UINT32	-	-	6061 0008
	06	6th application object	RO	NO	UINT32	-	-	60B9 0010
	07	7th application object	RO	NO	UINT32	-	-	60BA 0020
	08	8th application object	RO	NO	UINT32	-	-	60BC0020
	09	9th application object	RO	NO	UINT32	-	-	60FD0020
1B03		Transmit PDO mapping 260	RO	NO	Uint32	-	OD Data Range	OD Default
	00	Number of mapped application objects in TPDO260	RO	NO	UINT8	-	-	10
	01	1st application object	RO	NO	UINT32	-	-	603F0010
	02	2nd application object	RO	NO	UINT32	-	-	6041 0010
	03	3rd application object	RO	NO	UINT32	-	-	6064 0020
	04	4th application object	RO	NO	UINT32	-	-	6077 0010
	05	5th application object	RO	NO	UINT32	-	-	60F4 0020
	06	6th application object	RO	NO	UINT32	-	-	6061 0008
	07	7th application object	RO	NO	UINT32	-	-	60B9 0010
	08	8th application object	RO	NO	UINT32	-	-	60BA 0020
	09	9th application object	RO	NO	UINT32	-	-	60BC0020
	0A	10th application object	RO	NO	UINT32	-	-	60FD0020
1B04		Transmit PDO mapping 261	RO	NO	Uint32	-	OD Data Range	OD Default
	00	Number of mapped application objects in TPDO261	RO	NO	UINT8	-	-	10
	01	1st application object	RO	NO	UINT32	-	-	603F0010
	02	2nd application object	RO	NO	UINT32	-	-	6041 0010
	03	3rd application object	RO	NO	UINT32	-	-	6064 0020
	04	4th application object	RO	NO	UINT32	-	-	6077 0010
	05	5th application object	RO	NO	UINT32	-	-	6061 0008
	06	6th application object	RO	NO	UINT32	-	-	60F4 0020
	07	7th application object	RO	NO	UINT32	-	-	60B9 0010
	08	8th application object	RO	NO	UINT32	-	-	60BA 0020
	09	9th application object	RO	NO	UINT32	-	-	60BC0020
	0A	10th application object	RO	NO	UINT32	-	-	606C0020

Index	Sub-index	Name	Access	PDO Mapping	Data Type	Unit	Data Range	Default
1C12		Sync Manager 2 RPDO assignment	RW	NO	UINTER16	-	OD Data Range	OD Default
	00	Number of assigned RPDOs	RW	NO	UINT8	-	0 to 1	1
	01	1st PDO mapping object index of assigned RPDO	RW	YES	UINT16	-	0 to 65535	0x1701
1C13		Sync Manager 2 TPDO assignment	RW	NO	UINTER16	-	OD Data Range	OD Default
	00	Number of assigned TPDOs	RW	NO	UINT8	-	0 to 1	1
	01	1st PDO mapping object index of assigned TPDO	RW	YES	UINT16	-	0 to 65535	0x1B01
1C32		Sync Manager 2 synchronization output	RO	NO	UINTER16	-	OD Data Range	OD Default
	00	Number of synchronization parameters	RO	NO	UINT8	-	-	0x20
	01	Synchronization type	RO	NO	UINT16	-	-	0x0002
	02	Cycle time	RO	NO	UINT32	ns	-	0
	04	Synchronization types supported	RO	NO	UINT16	-	-	0x0004
	05	Minimum cycle time	RO	NO	UINT32	ns	-	0x0001E848
	06	Calc and copy time	RO	NO	UINT32	ns	-	-
	09	DelayTime (ns)	RO	NO	UINT32	ns	-	-
1C33		Sync Manager 2 synchronization input	RO	NO	ODData Type	-	OD Data Range	OD Default
	00	Number of synchronization parameters	RO	NO	UINT8	-	-	0x20
	01	Synchronization type	RO	NO	UINT16	-	-	0x0002
	02	Cycle time	RO	NO	UINT32	ns	-	0
	04	Synchronization types supported	RO	NO	UINT16	-	-	0x0004
	05	Minimum cycle time	RO	NO	UINT32	ns	-	0x0001E848
	06	Calc and copy time	RO	NO	UINT32	ns	-	-
	09	Delay time	RO	NO	UINT32	ns	-	-
20	Sync error	RO	NO	BOOL	-	-	-	

6.2 Object Group 2000h

Index	Sub-index	Name	Access	Mapping	Data Type	Unit	Data Range	Default	SC	EC
Group 2000h: Servo Motor Parameters										
2000	01h	Motor SN	RW	-	Uint16	-	0 to 65535	14000h	St	Po
	03h	Customized firmware version	RO	-	Uint16	-	0	0h	-	-
	05h	Encoder version	RO	-	Uint16	-	0	-	-	-
	06h	Serial encoder motor SN	RO	-	Uint16	W	0 to 65535	0	-	-
Group 2001h: Servo Drive Parameters										
2001	01h	MCU firmware Version	RO	-	UINT8	-	0 to 6553.5	0	-	-
	02h	FPGA firmware version	RO	-	Uint16	-	0 to 6553.5	0	-	-
	03h	Servo drive SN	RW	-	Uint16	-	0 to 65535	0	St	Po
Group 2002h: Basic Control Parameters										
2002	01h	Control mode	RW	-	Uint16	-	0 to 8: Reserved 9: EtherCAT bus control mode	9	St	Im
	02h	Absolute system selection	RW	-	-	-	0: Incremental position mode 1: Absolute position linear mode 2: Absolute position rotating mode	0	Ru	-
	03h	Rotating direction selection	RW	-	Uint16	-	0: CCW direction as forward direction 1: CW direction as forward direction	0	St	Po
	04h	Output pulse phase	RW	-	Uint16	-	0: Phase A advancing phase B 1: Phase A lagging phase B	0	St	Po
	06h	Stop mode at S-ON off	RW	-	Uint16	-	0: Coast to stop, keeping de-energized state 1: Stop at zero speed, keeping de-energized state	0	St	Im
	08h	Stop mode at limit switch signal	RW	-	Uint16	-	0: Coast to stop, keeping de-energized state 1: Stop at zero speed, keeping position locking state 1: Stop at zero speed, keeping de-energized state	1	St	Im
	09h	Stop mode at NO.1 fault	RW	-	Uint16	-	0: Coast to stop, keeping de-energized state	0	St	Im
	0Ah	Delay from brake output on to command received	RW	-	Uint16	ms	0 to 500	250	Ru	Im

Index	Sub-index	Name	Access	Mapping	Data Type	Unit	Data Range	Default	SC	EC
2002	0Bh	Delay from brake output off to motor de-energized in static state	RW	-	Uint16	ms	1 to 1000	150	Ru	Im
	0Ch	Motor speed threshold at brake output off in rotating state	RW	-	Uint16	RPM	0 to 3000	30	Ru	Im
	0Dh	Delay from S-ON off to brake output off	RW	-	Uint16	ms	1 to 1000	500	Ru	Im
	10h	Warning display on keypad	RW	-	Uint16	-	0: Output Imly 1: Not output	0	St	Im
	16h	Permissible minimum resistance of regenerative resistor	RO	-	Uint16	Ω	0 to 1000	-	-	-
	17h	Power of built-in regenerative resistor	RO	-	Uint16	W	1 to 65535	-	-	-
	18h	Resistance of built-in regenerative resistor	RO	-	Uint16	Ω	1 to 1000	-	-	-
	19h	Resistor heat dissipation coefficient	RW	-	Uint16	-	10 to 100	30	St	Im
	1Ah	Regenerative resistor type	RW	-	Uint16	-	0: Built-in 1: External, naturally ventilated 2: External, forcible cooling 3: No resistor, using only capacitor	0	St	Im
	1Bh	Power of external regenerative resistor	RW	-	Uint16	W	1 to 65535	40	St	Im
	1Ch	Resistance of external regenerative resistor	RW	-	Uint16	Ω	1 to 1000	50	St	Im
	20h	Parameter initialization	RW	-	Uint16	-	0: No operation 1: Restore default setting 2: Clear fault records	0	St	Im
21h	Default keypad display	RW	-	Uint16	-	0 to 99	50	Ru	Im	

Index	Sub-index	Name	Access	Mapping	Data Type	Unit	Data Range	Default	SC	EC
2002	26h	Speed switchover threshold 2 St due to limit switch	RW	-	Uint16	-	0 to 6000	6000	St	Im
Group 2003h: Input Terminal Parameters										
2003	01h	States of DI functions FunIN1 to 16	RW	-	Uint16	-	0 to 65535	0	Ru	Po
	02h	States of DI functions FunIN17 to 32	RW	-	Uint16	-	0 to 65535	0	Ru	Po
	03h	DI1 function selection	RW	-	Uint16	-	0 to 39	14	Ru	St
	04h	DI1 logic selection	RW	-	Uint16	-	0: Low level 1: High level 2: Rising edge 3: Falling edge 4: Rising edge and falling edge	0	Ru	St
	05h	DI2 function selection	RW	-	Uint16	-	0 to 39	15	Ru	St
	06h	DI2 logic selection	RW	-	Uint16	-	0: Low level 1: High level 2: Rising edge 3: Falling edge 4: Rising edge and falling edge	0	Ru	St
	07h	DI3 function selection	RW	-	Uint16	-	0 to 39	0	Ru	St
	08h	DI3 logic selection	RW	-	Uint16	-	0: Low level 1: High level 2: Rising edge 3: Falling edge 4: Rising edge and falling edge	0	Ru	St
	09h	DI4 function selection	RW	-	Uint16	-	0 to 39	0	Ru	St
	0Ah	DI4 logic selection	RW	-	Uint16	-	0: Low level 1: High level 2: Rising edge 3: Falling edge 4: Rising edge and falling edge	0	Ru	St
	0Bh	DI5 function selection	RW	-	Uint16	-	0 to 39	0	Ru	St

Index	Sub-index	Name	Access	Mapping	Data Type	Unit	Data Range	Default	SC	EC
2003	0Ch	DI5 logic selection	RW	-	Uint16	-	0: Low level 1: High level 2: Rising edge 3: Falling edge 4: Rising edge and falling edge	0	Ru	St
	0Dh	DI6 function selection	RW	-	Uint16	-	0 to 39	0	Ru	St
	0Eh	DI6 logic selection	RW	-	Uint16	-	0: Low level 1: High level 2: Rising edge 3: Falling edge 4: Rising edge and falling edge	0	Ru	St
	11h	DI8 function selection	RW	-	Uint16	-	0 to 39	0	Ru	St
	12h	DI8 logic selection	RW	-	Uint16	-	0: Low level 1: High level 2: Rising edge 3: Falling edge 4: Rising edge and falling edge	0	Ru	St
	13h	DI9 function selection	RW	-	Uint16	-	0 to 39	31	Ru	St
	14h	DI9 logic selection	RW	-	Uint16	-	0: Low level 1: High level 2: Rising edge 3: Falling edge 4: Rising edge and falling edge	0	Ru	St
	23h	States of DI functions FunIN33 to 48	RW	-	Uint16	-	0 to 65535	0	Ru	Po
24h	States of DI functions FunIN49 to 64	RW	-	Uint16	-	0 to 65535	0	Ru	Po	

Index	Sub-index	Name	Access	Mapping	Data Type	Unit	Data Range	Default	SC	EC
Group 2004h: Output Terminal Parameters										
2004	01h	DO1 function selection	RW	-	Uint16	-	0: No function 1: S-RDY (Servo ready) 2: TGON (Motor rotation output) 3: ZERO (Zero speed signal) 4: V-CMP (Speed consistent) 5: COIN (Positioning completed) 7: C-LT (Torque limit) 8: V-LT (Speed limit) 9: BK (Brake output) 10: WARN (Warning output) 11: ALM (Fault output) 12: ALMO1 (3-digit fault code output) 13: ALMO2 (3-digit fault code output) 14: ALMO3 (3-digit fault code output) 18: ToqReach (Torque reached) 19: V-Arr (Speed reached) 20: AngIntRdy (Angle auto-tuning output)	1	Ru	St
	02h	DO1 logic selection	RW	-	Uint16	-	0: Output low level when valid (optocoupler ON) 1: Output high level when valid (optocoupler OFF)	0	Ru	St
	03h	DO2 function selection	RW	-	Uint16	-	0 to 20	5	Ru	St
	04h	DO2 logic selection	RW	-	Uint16	-	0: Output low level when valid (optocoupler ON) 1: Output high level when valid (optocoupler OFF)	0	Ru	St
	05h	DO3 function selection	RW	-	Uint16	-	0 to 20	3	Ru	St
	06h	DO3 logic selection	RW	-	Uint16	-	0: Output low level when valid (optocoupler ON) 1: Output high level when valid (optocoupler OFF)	0	Ru	St

Index	Sub-index	Name	Access	Mapping	Data Type	Unit	Data Range	Default	SC	EC
2004	17h	DO source	RW	-	Uint16	-	Bit0: DO1 source 0: DO1 by drive status 1: DO1 by communication setting Bit1:DO2 source 0: DO2 by drive status 1: DO2 by communication setting Bit2:DO3 source 0: DO3 by drive status 1: DO3 by communication setting	0	St	Im
	33h	AO1 signal selection	RW	-	Uint16	-	0: Motor speed (1 V/1000 RPM) 1: Speed reference (1 V/1000 RPM) 2: Torque reference (1 V/ rated motor torque) 3: Position deviation (0.05 V/1 reference unit) 4: Position deviation (0.05 V/1 encoder unit) 5: Position reference speed (1 V/1000 RPM) 6: Positioning completed 7: Speed feedforward (1 V/1000 RPM)	0	Ru	Im
	34h	AO1 offset voltage	RW	-	Uint16	mV	-10000 to 10000	5000	Ru	Im
	35h	AO1 multiplying factor	RW	-	Uint16	-	-9999 to 9999 (Unit0.01 times)	100	Ru	Im
	36h	AO2 signal selection	RW	-	Uint16	-	0: Motor speed (1 V/1000 RPM) 1: Speed reference (1 V/1000 RPM) 2: Torque reference (1 V/ rated motor torque) 3: Position deviation (0.05 V/1 reference unit) 4: Position deviation (0.05 V/1 encoder unit) 5: Position reference speed (1 V/1000 RPM) 6: Positioning completed 7: Speed feedforward (1 V/1000 RPM)	0	Ru	Im
	37h	AO2 offset voltage	RW	-	Uint16	mV	-10000 to 10000	5000	Ru	Im
	38h	AO2 multiplying factor	RW	-	Uint16	-	-9999 to 9999 (Unit0.01 times)	100	Ru	Im

Index	Sub-index	Name	Access	Mapping	Data Type	Unit	Data Range	Default	SC	EC
Group 2005h: Position Control Parameters										
2005	11h	Clear action	RW	-	Uint16	-	0: Clear position deviation when S-ON signal is turned off or a fault occurs 1: Clear position deviation when S-ON signal is turned off and a fault occurs 2: Clear position deviation when S-ON signal is turned off and the ClrPosErr signal is input from DI	0	St	Im
	12h	Encoder frequency-division pulses	RW	-	Uint16	P/Rev	0 to 32767	2500	St	Po
	14h	Speed feedforward control selection	RW	YES	Uint16	-	0: No speed feedforward 1: Internal 2: 60B1h	1	St	Im
	1F	Homing mode	RW	-	Uint16	-	0 to 9	0	St	Im
	24h	Duration limit of homing	RW	-	Uint16	ms	0 to 65535	50000	Ru	Im
	27h	Servo pulse output source	RW	-	Uint16	-	0: Encoder frequency-division output 1: Pulse synchronous output 2: Frequency-division and synchronous output forbidden	0	St	Po
	2Ah	Output polarity of Z pulse	RW	-	Uint16	-	0: Positive (high level when pulse Z is valid) 1: Negative (low level when pulse Z is valid)	1	St	Po
	2Dh	Encoder multi-turn data offset	RW	-	Uint16	-	0 to 65535	0	St	Im
	2Fh	Position offset in absolute position linear mode (low 32 bits)	RW	-	int32	Enc	-2^{31} to $(2^{31}-1)$	0	St	Im
	31h	Position offset in absolute position linear mode (high 32 bits)	RW	-	int32	Enc	-2^{31} to $(2^{31}-1)$	0	St	Im
	33h	Mechanical gear ratio in absolute position rotating mode (numerator)	RW	-	Uint16	-	1 to 65535	65535	St	Im
34h	Mechanical gear ratio in absolute position rotating mode (denominator)	RW	-	Uint16	-	1 to 65535	1	St	Im	

Index	Sub-index	Name	Access	Mapping	Data Type	Unit	Data Range	Default	SC	EC
2005	35h	Pulses within one revolution of load in absolute position rotating mode (low 32 bits)	RW	-	Uint32	Enc	0 to $(2^{32}-1)$	0	St	Im
	37h	Pulses within one revolution of load in absolute position rotating mode (high 32 bits)	RW	-	Uint32	Enc	0 to 127	0	St	Im
	3Eh	Unit of position reached threshold	RW	-	Uint16	-	0: Encoder unit 1: Reference unit	1	St	Im
Group 2006h: Speed Control Parameters										
2006	05h	Jog speed setting value	RW	-	Uint16	RPM	0 to 6000	100	Ru	Im
	0Ch	Torque feedforward control selection	RW	-	Uint16	-	0: None 1: Internal torque feedforward 2: 60B2h as external feedforward	1	Ru	Im
	10h	Speed threshold for zero speed clamp	RW	-	-	Uint16	0 to 6000	10	Ru	Im
Group 2007h: Torque Control Parameters										
2007	06h	Time constant of torque reference filter	RW	-	Uint16	ms	0 to 3000 (Unit0.01)	79	Ru	Im
	07h	2nd time constant of torque reference filter	RW	-	Uint16	ms	0 to 3000 (Unit0.01)	79	Ru	Im
	08h	Torque Limit source	RW	-	Uint16	-	0: Internal positive/negative torque limit 1: External positive/negative torque limit (via P-CL, N-CL) 2: EtherCAT external positive/negative torque limit 3: Minimum of external positive/negative torque and EtherCAT external positive/negative torque limit (via P-CL, N-CL) 4: Switchover between external positive/negative torque and EtherCAT external positive/negative torque limit (via P-CL, N-CL)	2	St	Im

Index	Sub-index	Name	Access	Mapping	Data Type	Unit	Data Range	Default	SC	EC
2007	0Ah	Internal positive torque limit	RW	-	Uint16	%	0 to 3000 (Unit0.1%)	3000	Ru	Im
	0Bh	Internal negative torque limit	RW	-	Uint16	%	0 to 3000 (Unit0.1%)	3000	Ru	Im
	0Ch	External positive torque limit	RW	-	Uint16	%	0 to 3000 (Unit0.1%)	3000	Ru	Im
	0Dh	External negative torque limit External reverse torque limit	RW	-	Uint16	%	0 to 3000 (Unit0.1%)	3000	Ru	Im
	10h	Emergency stop torque	RW	-	Uint16	%	0 to 3000 (Unit0.1%)	3000	St	Im
	12h	Speed limit source	RW	-	Uint16	-	0: Internal speed limit 1: EtherCAT external speed limit 2: Internal speed limit selected via DI with FunIN.36	0	Ru	Im
	14h	Positive speed limit/1st speed limit in torque control	RW	-	Uint16	RPM	0 to 6000	3000	Ru	Im
	15h	Negative speed limit/2nd speed limit in torque control	RW	-	Uint16	RPM	0 to 6000	3000	Ru	Im
	16h	Base value for torque reached	RW	-	Uint16	%	0 to 3000 (Unit0.1%)	0	Ru	Im
	17h	Threshold of torque reached valid	RW	-	Uint16	%	0 to 3000 (Unit0.1%)	200	Ru	Im
18h	Threshold of torque reached invalid	RW	-	Uint16	%	0 to 3000 (Unit0.1%)	100	Ru	Im	
29h	Time duration of speed limit in torque control mode	RW	-	Uint16	ms	5 to 300 (Unit0.1 ms)	10	Ru	Im	
Group 2008h: Gain Parameters										
2008	01h	Speed loop gain	RW	-	Uint16	Hz	1 to 20000 (0.1 Hz)	250	Ru	Im
	02h	Time constant of speed loop integration	RW	-	Uint16	ms	15 to 51200 (0.01 ms)	3183	Ru	Im
	03h	Position loop gain	RW	-	Uint16	Hz	1 to 20000 (0.1 Hz)	400	Ru	Im
	04h	2nd gain of speed loop	RW	-	Uint16	Hz	1 to 20000 (0.1 Hz)	400	Ru	Im
	05h	2nd time constant of speed loop integration	RW	-	Uint16	ms	15 to 51200 (0.01 ms)	2000	Ru	Im

Index	Sub-index	Name	Access	Mapping	Data Type	Unit	Data Range	Default	SC	EC
2008	06h	2nd gain of position loop	RW	-	Uint16	Hz	0 to 20000 (0.1 Hz)	640	Ru	Im
	09h	2nd gain mode setting	RW	-	Uint16	-	0: 1st gain fixed, P and PI switchover of speed loop via DI 1: Gain switchover based on 2008-0Ah	1	Ru	Im
	0Ah	Gain switchover condition	RW	-	Uint16	-	0: Fixed at 1st gain (PS) 1: Switchover via DI (PS) 2: Torque reference being large (PS) 3: Speed reference being large (PS) 4: Speed reference change rate being large (PS) 5: Speed reference high-speed/ low-speed thresholds (PS) 6: Position deviation being large (P) 7: Position reference available (P) 8: Positioning completed (P) 9: Motor speed being large (P) 10: Position reference available + Actual speed (P)	0	Ru	Im
	0Bh	Gain switchover delay	RW	-	Uint16	ms	0 to 10000 (0.1 ms)	50	St	Im
	0Ch	Gain switchover level	RW	-	Uint16	-	0 to 20000	50	St	Im
	0Dh	Gain switchover hysteresis	RW	-	Uint16	-	0 to 20000	30	St	Im
	0Eh	Position gain switchover time	RW	-	Uint16	ms	0 to 10000 (0.1 ms)	30	St	Im
	10h	Load/Rotor inertia ratio	RW	-	Uint16	-	0 to 12000 (0.01 times)	100	Ru	Im
	13h	Time constant of speed feedforward filter	RW	-	Uint16	ms	0 to 6400 (0.01 ms)	50	Ru	Im
	14h	Speed feedforward gain	RW	-	Uint16	%	0 to 1000 (0.1%)	0	Ru	Im
15h	Time constant of torque feedforward filter	RW	-	Uint16	ms	0 to 6400 (0.01 ms)	50	Ru	Im	
16h	Torque feedforward gain	RW	-	Uint16	%	0 to 2000 (0.1%)	0	Ru	Im	

Index	Sub-index	Name	Access	Mapping	Data Type	Unit	Data Range	Default	SC	EC
2008	17h	Speed feedback filter	RW	-	Uint16	-	0: Average filter disabled 1: 2 average filters on speed feedback 2: 4 average filters on speed feedback 3: 8 average filters on speed feedback 4: 16 average filters on speed feedback	0	St	Im
	18h	Cutoff frequency of speed feedback low-pass filter	RW	-	Uint16	Hz	0 to 4000	4000	Ru	Im
	19h	PDFF control coefficient	RW	-	Uint16	0.10%	0 to 1000	1000	Ru	Im
Group 2009h: Automatic Gain Tuning Parameters										
2009	01h	Automatic gain tuning mode selection	RW	-	Uint16	-	0: Disabled 1: Automatic gain tuning mode 2: Positioning mode 3: Automatic gain tuning mode with friction compensation 4: Positioning mode with friction compensation	0	Ru	Im
	02h	Rigidity level selection	RW	-	Uint16	-	0 to 31	12	Ru	Im
	03h	Mode selection of adaptive notch	RW	-	Uint16	-	0: Parameters not updated 1: Only one notch (3rd notch) valid 2: Both notches (3rd and 4th notches) valid 3: Only detect resonance frequency (displayed in 2009-19h) 4: Clear 3rd and 4th notches, restore parameters to default setting	0	Ru	Im
	04h	Online inertia auto-tuning mode	RW	-	Uint16	-	0: Disabled 1: Enabled, change slowly 2: Enabled, change always 3: Enabled, change quickly	0	Ru	Im
	05h	Suppression mode of low-frequency resonance	RW	-	Uint16	-	0: Manually set parameters of low-frequency resonance suppression filter 1: Automatically set parameters of low-frequency resonance suppression filter	0	Ru	Im
	06h	Offline inertia auto-tuning mode	RW	-	Uint16	-	0: Positive and negative triangular wave mode 1: Jog mode	0	St	Im

Index	Sub-index	Name	Access	Mapping	Data Type	Unit	Data Range	Default	SC	EC
2009	07h	Maximum speed for inertia auto-tuning	RW	-	Uint16	RPM	100 to 1000	500	St	Im
	08h	Time constant of accelerating to max. speed for inertia auto-tuning	RW	-	Uint16	ms	20 to 800	125	St	Im
	09h	Interval after an inertia auto-tuning	RW	-	Uint16	ms	50 to 10000	800	St	Im
	0Ah	Motor revolutions for an inertia auto-tuning	RO	-	Uint16	r	0 to 65535	0	-	-
	0Dh	1st notch frequency	RW	-	Uint16	Hz	50 to 4000	4000	Ru	Im
	0Eh	1st notch width level	RW	-	Uint16	-	0 to 20	2	Ru	Im
	0Fh	1st notch depth level	RW	-	Uint16	-	0 to 99	0	Ru	Im
	10h	2nd notch frequency	RW	-	Uint16	Hz	50 to 4000	4000	Ru	Im
	11h	2nd notch width level	RW	-	Uint16	-	0 to 20	2	Ru	Im
	12h	2nd notch depth level	RW	-	Uint16	-	0 to 99	0	Ru	Im
	13h	3rd notch frequency	RW	-	Uint16	Hz	50 to 4000	4000	Ru	Im
	14h	3rd notch width level	RW	-	Uint16	-	0 to 20	2	Ru	Im
	15h	3rd notch depth level	RW	-	Uint16	-	0 to 99	0	Ru	Im
	16h	4th notch frequency	RW	-	Uint16	Hz	50 to 4000	4000	Ru	Im
	17h	4th notch width level	RW	-	Uint16	-	0 to 20	2	Ru	Im
	18h	4th notch depth level	RW	-	Uint16	-	0 to 99	0	Ru	Im
	19h	Obtained resonance frequency	RO	-	Uint16	-	0 to 4000	0	-	-
	1Fh	Torque disturbance compensation gain	RW	-	Uint16	%	-1000 to 1000 (0.1%)	0	Ru	Im
	20h	Time constant of torque disturbance observer filter	RW	-	Uint16	ms	0 to 2500 (0.01 ms)	0.50	Ru	Im

Index	Sub-index	Name	Access	Mapping	Data Type	Unit	Data Range	Default	SC	EC
2009	27h	Frequency of low-frequency resonance	RW	-	Uint16	Hz	10 to 1000 (0.1 Hz)	1000	Ru	Im
	28h	Filter setting of low-frequency resonance	RW	-	Uint16	-	0 to 10	2	Ru	Im
Group 200Ah: Fault and Protection Parameters										
200A	01h	Power input phase loss protection	RW	-	Uint16	-	0: Enable faults and inhibit warnings 1: Enable faults and warnings 2: Inhibit faults and warnings	0	Ru	Im
	02h	Absolute position limit	RW	-	Uint16	-	0: Disabled 1: Enabled 2: Enabled after homing	0	St	Im
	04h	Retentive at power failure	RW	-	Uint16	-	0: Disabled 1: Enabled	0	Ru	Im
	05h	Motor overload protection gain	RW	-	Uint16	%	50 to 300	100	St	Im
	09h	Overspeed threshold	RW	-	Uint16	RPM	0 to 10000	0	Ru	Im
	0Ah	Maximum position pulse frequency	RW	-	Uint16	kHz	100 to 4000 (kHz)	4000	St	Im
	0Dh	Runaway protection function	RW	-	Uint16	-	0: Disabled 1: Enabled	1	Ru	Im
	11h	Position deviation threshold for low-frequency resonance suppression	RW	-	Uint16	-	1 to 10000	5	Ru	Im
	14h	DI8 filter time	RW	-	Uint16	-	0 to 255	80	St	Po
	15h	DI9 filter time	RW	-	Uint16	-	0 to 255	80	St	Po
	1Ah	Filter time constant of speed feedback display	RW	-	Uint16	ms	0 to 5000	50	St	Im
	1Bh	Motor overload shielding	RW	-	Uint16	-	0: Motor overload detection enabled 1: Detection of motor overload warning (Er.909) and fault (Er.620) disabled	0	St	Im
	1Ch	Filter time constant of speed DO	RW	-	Uint16	ms	0 to 5000	10	St	Im
1Dh	Filter time constant of quadrature encoder	RW	-	Uint16	25 ns	0 to 255	30	St	Po	

Index	Sub-index	Name	Access	Mapping	Data Type	Unit	Data Range	Default	SC	EC
200A	21h	Time threshold for locked rotor over-temperature protection	RW	-	Uint16	ms	10 to 65535	200	Ru	Im
	22h	Locked rotor over-temperature protection	RW	YES	Uint16	-	0: Shield 1: Enabled	1	Ru	Im
	25h	Encoder multi-turn overflow fault selection	RW	-	Uint16	-	0: Not shield 1: Shield	0	St	Im
Group 200Bh: Monitoring Parameters										
200B	01h	Actual motor speed	RO	-	int16	RPM	-	-	-	-
	02h	Speed reference	RO	-	int16	RPM	-	-	-	-
	03h	Internal torque reference	RO	-	int16	%	-	-	-	-
	04h	Monitored DI states	RO	-	Uint16	Uint16	-	-	-	-
	06h	Monitored DO states	RO	-	Uint16	Uint16	-	-	-	-
	08h	Absolute position counter	RO	-	int32	Ref	-2^{31} to 2^{31}	-	-	-
	0Ah	Mechanical angle	RO	-	Uint16	Enc	-	-	-	-
	0Bh	Electrical angle	RO	-	Uint16	°	-	-	-	-
	0Ch	Electrical angle	RO	-	int16	RPM	-	-	-	-
	0Dh	Average load ratio	RO	-	int16	%	-	-	-	-
	0Eh	Input reference pulse counter	RO	-	int32	Ref	-	-	-	-
	10h	Encoder position deviation counter	RO	-	int32	Enc	-	-	-	-
	12h	Feedback pulse counter	RO	-	int32	Enc	-	-	-	-
	14h	Total power-on time	RO	-	Uint32	s	-	-	-	-
	19h	Phase current effective value	RO	-	Uint16	A	-	-	-	-
	1Bh	Bus voltage	RO	-	Uint16	V	-	-	-	-
1Ch	Module temperature	RO	-	Uint16	°C	-	-	-	-	
	22h	Fault record	RW	-	Uint16	Uint16	0: Current fault 1: Latest fault 2: Last 2nd fault 3: Last 3rd fault 4: Last 4th fault 5: Last 5th fault 6: Last 6th fault 7: Last 7th fault 8: Last 8th fault 9: Last 9th fault	0	Ru	-

Index	Sub-index	Name	Access	Mapping	Data Type	Unit	Data Range	Default	SC	EC
200B	23h	Fault code of selected fault record	RO	-	Uint16	Uint16	-	0	-	-
	24h	Time stamp upon displayed fault	RO	-	int32	s	-	-	-	-
	26h	Motor speed upon displayed fault	RO	-	int16	RPM	-	-	-	-
	27h	Motor phase U current upon displayed fault	RO	-	int16	A	-	-	-	-
	28h	Motor phase V current upon displayed fault	RO	-	int16	A	-	-	-	-
	29h	Bus voltage upon displayed fault	RO	-	Uint16	V	-	-	-	-
	2Ah	Input terminal state upon displayed fault	RO	-	Uint16	Uint16	-	-	-	-
	2Bh	Output terminal state upon displayed fault	RO	-	Uint16	Uint16	-	-	-	-
	36h	Position deviation counter	RO	-	int32	Ref	-	-	-	-
	38h	Actual motor speed	RO	-	int32	RPM	-	-	-	-
	3Ah	Control power bus voltage	RO	-	Uint16		-	-	-	-
	3Bh	Mechanical absolute position (low 32 bits)	RO	-	int32	Enc	-	0	-	-
	3Dh	Mechanical absolute position (high 32 bits)	RO	-	int32	Enc	-	0	-	-
	41h	Real-time input position reference counter	RO	-	int32	Ref	-	-	-	-
	47h	Number of absolute encoder turns	RO	-	Uint16	REV	-	0	-	-
	48h	Absolute encoder single-turn position feedback	RO	-	int32	Enc	-	0	-	-
	4Eh	Absolute encoder single-turn position feedback	RO	-	int32	Enc	-	0	-	-
50h	Absolute position (high 32 bits) of absolute encoder	RO	-	int32	Enc	-	0	-	-	

Index	Sub-index	Name	Access	Mapping	Data Type	Unit	Data Range	Default	SC	EC
200B	52h	Rotating load single-turn position (low 32 bits)	RO	-	Uint32	Enc	-	0	-	-
	54h	Rotating load single-turn position (high 32 bits)	RO	-	Uint32	Enc	-	0	-	-
	56h	Rotating load single-turn position	RO	-	Uint32	Ref	-	0	-	-
Group 200Ch: Communication Parameters										
200C	01h	Servo axis address	RW	-	Uint16	-	1 to 247	1	Ru	Im
	03h	Serial baud rate	RW	-	Uint16	-	0: 2400 bps 1: 4800 bps 2: 9600 bps 3: 19200 bps 4: 38400 bps 5: 57600 bps	5	Ru	Im
	04h	Modbus data format	RW	-	Uint16	-	0: No check, 2 stop bit 1: Even parity check, 1 stop bit 2: Odd parity check, 1 stop bit 3: No check, 1 stop bit	0	Ru	Im
	05h	Station name	RW	NO	Uint16	-	0	0	-	-
	06h	Station alias	RW	NO	Uint16	-	0 to 65535	0	St	Im
	0Ah	Communication VDI	RW	-	Uint16	-	0: Disabled 1: Enabled	0	St	Im
	0Bh	VDI default value after power-on	RW	-	Uint16	-	0 to 65535	0	Ru	Po
	0Ch	Communication VDO	RW	-	Uint16	-	0: Disabled 1: Enabled	0	St	Im
	0Dh	Default level of VDO allocated with function 0	RW	-	Uint16	-	0 to 65535	0	St	Im
	0Eh	Update function code values written via communication to EEPROM	RW	-	Uint16	-	0: Not update 1: Store 2000h series object dictionary written via communication to EEPROM 2: Store 6000h series object dictionary written via communication to EEPROM 3: Store 2000h and 6000h series object dictionary written via communication to EEPROM	0	Ru	Im

Index	Sub-index	Name	Access	Mapping	Data Type	Unit	Data Range	Default	SC	EC
200C	24h	Permissible interruption loss times of EtherCAT synchronization	RW	-	Uint16	ms	4 to 20	9	Ru	Im
	25h	Port 0 invalid frame counter	RO	-	Uint16	-	-	-	Ru	Im
	26h	Port 1 invalid frame counter	RO	-	Uint16	-	-	-	Ru	Im
	27h	Port 0/1 invalid frame counter	RO	-	Uint16	-	-	-	Ru	Im
	28h	Processing unit and PID error counter	RO	-	Uint16	-	-	-	Ru	Im
	29h	Port 0/1 loss counter	RO	-	Uint16	-	-	-	Ru	Im
	2Ah	Host type selection	RW	-	Uint16	-	0 to 1: Reserved 2: Omron NJ series controller 3: AM600, Beckhoff controller	2	St	Po
	2Bh	Synchronization error detection mode	RW	-	Uint16	-	0 to 1	0	St	Im
	2Ch	Synchronization mode	RW	-	Uint16	-	0 to 2	2	St	Im
	2Dh	Synchronization error threshold	RW	-	Uint16	nm	0 to 2000	500	St	Im
2Eh	Position control buffer	RW	-	Uint16	-	0: Disabled 1: Enabled	1	St	Im	
Group 200Dh: Auxiliary Function Parameters										
200D	01h	Software reset	RW	-	Uint16	-	0: No operation 1: Enabled	0	St	Im
	02h	Fault reset	RW	-	Uint16	-	0: No operation 1: Enabled	0	St	Im
	03h	Offline inertia auto-tuning enable	RW	-	Uint16	-	0: No operation 1: Enabled	0	Ru	Im
	06h	Emergency stop	RW	-	Uint16	-	0: No operation 1: Enabled	0	Ru	Im
	0Ah	One-key adjustment	RW	-	Uint16	-	0: Disabled 1: Enabled	0	St	Im
	0Ch	Jog function	RW	-	Uint16	-	-	-	-	-

Index	Sub-index	Name	Access	Mapping	Data Type	Unit	Data Range	Default	SC	EC
200D	12h	Forced DI/DO setting	RW	-	Uint16	-	0: No operation 1: Forced DI enabled, forced DO disabled 2: Forced DO enabled, forced DI disabled 3: Forced DI and DO enabled 4: Forced DO enabled, forced DI disabled through EtherCAT control	0	Ru	Im
	13h	Forced DI level	RW	-	Uint16	-	0 to 447	447	Ru	Im
	14h	Forced DO setting	RW	-	Uint16	-	0 to 7	0	Ru	Im
	15h	Absolute encoder reset function	RW	-	Uint16	-	0: No operation 1: Reset faults 2: Reset faults and multi-turn data	0	Ru	Im
Group 200Fh: Fully Closed-Loop Parameters										
200F	01h	Encoder feedback mode	RW	-	Uint16	-	0: Internal encoder feedback 1: External encoder feedback	0	St	Im
	02h	Running direction of external encoder	RW	-	Uint16	-	0: Standard running direction 1: Reverse running direction	0	St	Im
	05h	External encoder pulses per one motor revolution	RW	-	int32	External Enc	0 to 2 ³⁰	10000	St	Po
	09h	Fully closed-loop position deviation excess threshold	RW	-	int32	External Enc	0 to 2 ³⁰	1000	Ru	Im
	0Bh	Fully closed-loop position deviation clear setting	RW	-	Uint16	Rev	0 to 100	0	Ru	Im
	0Eh	Filter time constant of hybrid vibration suppression	RW	-	Uint16	ms	0 to 65535 (0.01 ms)	0	Ru	Im
	11h	Fully closed-loop position deviation counter	RO	-		External Enc	-2 ³⁰ to 2 ³⁰	0	-	-
	13h	Feedback pulse counter of internal encoder	RO	-	int32	Internal Enc	-	0	-	-
	15h	Feedback pulse counter of external encoder	RO	-	int32	External Enc	-	0	-	-

Index	Sub-index	Name	Access	Mapping	Data Type	Unit	Data Range	Default	SC	EC
Group 2017h: VDI/VDO Parameters										
2017	01h	VDI1 function selection	RW	-	Uint16	-	0 to 39	0	St	St
	02h	VDI1 logic selection	RW	-	Uint16	-	0: Valid when logic is 1 1: Valid when logic changes from 0 to 1	0	St	St
	03h	VDI2 function selection	RW	-	Uint16	-	0 to 39	0	St	St
	04h	VDI2 logic selection	RW	-	Uint16	-	0: Valid when logic is 1 1: Valid when logic changes from 0 to 1	0	St	St
	05h	VDI3 function selection	RW	-	Uint16	-	0 to 39	0	St	St
	06h	VDI3 logic selection	RW	-	Uint16	-	0: Valid when logic is 1 1: Valid when logic changes from 0 to 1	0	St	St
	07h	VDI4 function selection	RW	-	Uint16	-	0 to 39	0	St	St
	08h	VDI4 logic selection	RW	-	Uint16	-	0: Valid when logic is 1 1: Valid when logic changes from 0 to 1	0	St	St
	09h	VDI5 function selection	RW	-	Uint16	-	0 to 39	0	St	St
	0Ah	VDI5 logic selection	RW	-	Uint16	-	0: Valid when logic is 1 1: Valid when logic changes from 0 to 1	0	St	St
	0Bh	VDI6 function selection	RW	-	Uint16	-	0 to 39	0	St	St
	0Ch	VDI6 logic selection	RW	-	Uint16	-	0: Valid when logic is 1 1: Valid when logic changes from 0 to 1	0	St	St
	0Dh	VDI7 function selection	RW	-	Uint16	-	0 to 39	0	St	St
	0Eh	VDI7 logic selection	RW	-	Uint16	-	0: Valid when logic is 1 1: Valid when logic changes from 0 to 1	0	St	St
	0Fh	VDI8 function selection	RW	-	Uint16	-	0 to 39	0	St	St
	10h	VDI8 logic selection	RW	-	Uint16	-	0: Valid when logic is 1 1: Valid when logic changes from 0 to 1	0	St	St
11h	VDI9 function selection	RW	-	Uint16	-	0 to 39	0	St	St	
12h	VDI9 logic selection	RW	-	Uint16	-	0: Valid when logic is 1 1: Valid when logic changes from 0 to 1	0	St	St	
13h	VDI10 function selection	RW	-	Uint16	-	0 to 39	0	St	St	

Index	Sub-index	Name	Access	Mapping	Data Type	Unit	Data Range	Default	SC	EC
2017	14h	VDI10 logic selection	RW	-	Uint16	-	0: Valid when logic is 1 1: Valid when logic changes from 0 to 1	0	St	St
	15h	VDI11 function selection	RW	-	Uint16	-	0 to 39	0	St	St
	16h	VDI11 logic selection	RW	-	Uint16	-	0: Valid when logic is 1 1: Valid when logic changes from 0 to 1	0	St	St
	17h	VDI12 function selection	RW	-	Uint16	-	0 to 39	0	St	St
	18h	VDI12 logic selection	RW	-	Uint16	-	0: Valid when logic is 1 1: Valid when logic changes from 0 to 1	0	St	St
	19h	VDI13 function selection	RW	-	Uint16	-	0 to 39	0	St	St
	1Ah	VDI13 logic selection	RW	-	Uint16	-	0: Valid when logic is 1 1: Valid when logic changes from 0 to 1	0	St	St
	1Bh	VDI14 function selection	RW	-	Uint16	-	0 to 39	0	St	St
	1Ch	VDI14 logic selection	RW	-	Uint16	-	0: Valid when logic is 1 1: Valid when logic changes from 0 to 1	0	St	St
	1Dh	VDI15 function selection	RW	-	Uint16	-	0 to 39	0	St	St
	1Eh	VDI15 logic selection	RW	-	Uint16	-	0: Valid when logic is 1 1: Valid when logic changes from 0 to 1	0	St	St
	1Fh	VDI16 function selection	RW	-	Uint16	-	0 to 39	0	St	St
	20h	VDI16 logic selection	RW	-	Uint16	-	0: Valid when logic is 1 1: Valid when logic changes from 0 to 1	0	St	St
	21h	VDO virtual level	RO	-	Uint16	-	0 to 65535	0	-	-

Index	Sub-index	Name	Access	Mapping	Data Type	Unit	Data Range	Default	SC	EC
2017	22h	VDO1 function selection	RW	-	Uint16	-	0: No function 1: S-RDY (Servo ready) 2: TGON (Motor rotation output) 3: ZERO (Zero speed signal) 4: V-CMP (Speed consistent) 5: COIN (Positioning completed) 7: C-LT (Torque limit) 8: V-LT (Speed limit) 9: BK (Brake output) 10: WARN (Warning output) 11: ALM (Fault output) 12: ALMO1 (3-digit fault code output) 13: ALMO2 (3-digit fault code output) 14: ALMO3 (3-digit fault code output) 18: ToqReach (Torque reached) 19: V-Arr (Speed reached) 20: AngIntRdy (Angle tuning output)	0	St	St
	23h	VDO1 logic selection	RW	-	Uint16	-	0: Output 1 when function valid 1: Output 0 when function valid	0	St	St
	24h	VDO2 function selection	RW	-	Uint16	-	See VDO1	0	St	St
	25h	VDO2 logic selection	RW	-	Uint16	-	0: Output 1 when function valid 1: Output 0 when function valid	0	St	St
	26h	VDO3 function selection	RW	-	Uint16	-	See VDO1	0	St	St
	27h	VDO3 logic selection	RW	-	Uint16	-	0: Output 1 when function valid 1: Output 0 when function valid	0	St	St
	28h	VDO4 function selection	RW	-	Uint16	-	See VDO1	0	St	St
	29h	VDO4 logic selection	RW	-	Uint16	-	0: Output 1 when function valid 1: Output 0 when function valid	0	St	St
	2Ah	VDO5 function selection	RW	-	Uint16	-	See VDO1	0	St	St

Index	Sub-index	Name	Access	Mapping	Data Type	Unit	Data Range	Default	SC	EC
1017	2Bh	VDO5 logic selection	RW	-	Uint16	-	0: Output 1 when function valid 1: Output 0 when function valid	0	St	St
	2Ch	VDO6 function selection	RW	-	Uint16	-	See VDO1	0	St	St
	2Dh	VDO6 logic selection	RW	-	Uint16	-	0: Output 1 when function valid 1: Output 0 when function valid	0	St	St
	2Eh	VDO7 function selection	RW	-	Uint16	-	See VDO1	0	St	St
	2Fh	VDO7 logic selection	RW	-	Uint16	-	0: Output 1 when function valid 1: Output 0 when function valid	0	St	St
	30h	VDO8 function selection	RW	-	Uint16	-	See VDO1	0	St	St
	31h	VDO8 logic selection	RW	-	Uint16	-	0: Output 1 when function valid 1: Output 0 when function valid	0	St	St
	32h	VDO9 function selection	RW	-	Uint16	-	See VDO1	0	St	St
	33h	VDO9 logic selection	RW	-	Uint16	-	0: Output 1 when function valid 1: Output 0 when function valid	0	St	St
	34h	VDO10 function selection	RW	-	Uint16	-	See VDO1	0	St	St
	35h	VDO10 logic selection	RW	-	Uint16	-	0: Output 1 when function valid 1: Output 0 when function valid	0	St	St
	36h	VDO11 function selection	RW	-	Uint16	-	See VDO1	0	St	St
	37h	VDO11 logic selection	RW	-	Uint16	-	0: Output 1 when function valid 1: Output 0 when function valid	0	St	St
	38h	VDO12 function selection	RW	-	Uint16	-	See VDO1	0	St	St
	39h	VDO12 logic selection	RW	-	Uint16	-	0: Output 1 when function valid 1: Output 0 when function valid	0	St	St
3Ah	VDO13 function selection	RW	-	Uint16	-	See VDO1	0	St	St	
3Bh	VDO13 logic selection	RW	-	Uint16	-	0: Output 1 when function valid 1: Output 0 when function valid	0	St	St	

Index	Sub-index	Name	Access	Mapping	Data Type	Unit	Data Range	Default	SC	EC
1017	3Ch	VDO14 function selection	RW	-	Uint16	-	See VDO1	0	St	St
	3Dh	VDO14 logic selection	RW	-	Uint16	-	0: Output 1 when function valid 1: Output 0 when function valid	0	St	St
	3Eh	VDO15 function selection	RW	-	Uint16	-	See VDO1	0	St	St
	3Fh	VDO15 logic selection	RW	-	Uint16	-	0: Output 1 when function valid 1: Output 0 when function valid	0	St	St
	40h	VDO16 function selection	RW	-	Uint16	-	See VDO1	0	St	St
	41h	VDO16 logic selection	RW	-	Uint16	-	0: Output 1 when function valid 1: Output 0 when function valid	0	St	St
Group 2030h: Servo Variables Read via Communication										
2030	01h	Servo state read via communication	RO	-	Uint16	-	-	0	-	-
	02h	DO function state 1 read via communication	RO	-	Uint16	-	0 to 65535	0	-	-
	03h	DO function state 2 read via communication	RO	-	Uint16	-	0 to 65535	0	-	-
Group 2031h: Servo Variables Set via Communication										
2031	01h	VDI virtual level set via communication	RW	-	Uint16	-	0 to 65535	0	Ru	Im
	05h	DO state set via communication	RW	-	Uint16	-	0 to 7	0	Ru	Im
Group 203Fh: Factory Fault Code										
203F	00h	Manufacturer fault code	RO	TPDO	Uint32	-	0 to (2 ³¹ -1)	0	-	-

6.3 Object Group 6000h

Group 6000h includes the DSP402-related objects.

Index (hex)	Sub-index (hex)	Name	Access	PDO Mapping	Data Type	Unit	Data Range	Default	SC	EC
603F	00	Error code	RO	TPDO	UINT16	-	0 to 65535	0	-	-
6040	00	Control word	RW	RPDO	UINT16	-	0 to 65535	0	Ru	St
6041	00	Status word	RO	TPDO	UINT16	-	0 to xFFFF	0	-	-
605A	00	Quick stop option code	RW	NO	INT16	-	0 to 7	2	Ru	St

Index (hex)	Sub-index (hex)	Name	Access	PDO Mapping	Data Type	Unit	Data Range	Default	SC	EC
605D	00	Halt option code	RW	NO	INT16		1 to 3	1	Ru	St
6060	00	Modes of operation	RW	RPDO	INT8	-	0 to 10	0	Ru	St
6061	00	Modes of operation display	RO	TPDO	INT8	-	0 to 10	0	-	-
6062	00	Position demand value	RO	TPDO	DINT32	RU	-	-	-	-
6063	00	Position actual internal value	RO	TPDO	Dint32	EU	-	-	-	-
6064	00	Position actual value	RO	TPDO	Dint32	RU	-	-	-	-
6065	00	Following error window	RW	RPDO	UDINT32	RU	0 to ($2^{32}-1$)	1048576	Ru	St
6067	00	Position window	RW	RPDO	UINT32	EU	0 to 65535	734	Ru	Im
6068	00	Position window time	RW	RPDO	UINT16	ms	0 to 65535	x10	Ru	Im
606C	00	Velocity actual value	RO	TPDO	INT32	RU/s	-	-	-	-
606D	00	Velocity window	RW	RPDO	UINT16	RPM	0 to 65535	10	Ru	St
606E	00	Velocity window time	RW	RPDO	UINT16	ms	0 to 65535	0	Ru	St
6071	00	Target torque	RW	RPDO	INT16	0.1%	-5000 to 5000	0	Ru	St
6072	00	Max torque	RW	RPDO	UINT16	0.1%	0 to 5000	5000	Ru	St
6074	00	Max torque	RO	TPDO	INT16	0.1%	-5000 to 5000	0	-	-
6077	00	Torque actual value	RO	TPDO	INT16	0.1%	-5000 to 5000	0	-	-
607A	00	Target position	RW	RPDO	INT32	RU	-2^{31} to ($2^{31}-1$)	0	Ru	St
607C	00	Home offset	RW	RPDO	INT32	RU	-2^{31} to ($2^{31}-1$)	0	Ru	St
607D	Software position limit									
	00	Highest sub-index supported	RO	NO	UINT8	-	-	2	-	-
	01	Min position limit	RW	RPDO	INT32	UPU	-2^{31} to ($2^{31}-1$)	-231	Ru	St
	02	Max position limit	RW	RPDO	INT32	UPU	-2^{31} to ($2^{31}-1$)	231-1	Ru	St
607E	00	Polarity	RW	RPDO	UINT8	-	00 to FF	00	Ru	St
607F	00	Max profile velocity	RW	RPDO	UDINT32	RU/s	0 to ($2^{32}-1$)	230	Ru	St
6081	00	Profile velocity	RW	RPDO	UDINT32	UVU	0 to ($2^{32}-1$)	0	Ru	St
6083	00	Profile acceleration	RW	RPDO	UDINT32	RU/s ²	0 to ($2^{32}-1$)	100	Ru	St
6084	00	Profile deceleration	RW	RPDO	UDINT32	RU/s ²	0 to ($2^{32}-1$)	100	Ru	St
6085	00	Quick stop deceleration	RW	RPDO	UDINT32	User decel. unit	0 to ($2^{32}-1$)	100	Ru	St
6086	00	Motion profile type	RW	RPDO	INT16	-	-2^{15} to ($2^{15}-1$)	0	Ru	St
6087	00	Torque slope	RW	RPDO	UDINT32	0.1%/s	0 to ($2^{32}-1$)	232-1	Ru	St
6091	Gear ratio									
	00	Highest sub-index supported	RO	NO	UINT8	Uint8	-	2	-	-
	01	Motor revolutions	RW	RPDO	UINT32	-	1 to ($2^{32}-1$)	1	Ru	Im
	02	Shaft revolutions	RW	RPDO	UINT32	-	1 to ($2^{32}-1$)	1	Ru	Im
6098	00	Homing method	RW	RPDO	INT8	-	1 to 35	1	Ru	Im

Index (hex)	Sub-index (hex)	Name	Access	PDO Mapping	Data Type	Unit	Data Range	Default	SC	EC
6099	Homing method									
	00	Highest sub-index supported	RO	NO	Uint8	-	2	2	-	-
	01	Speed during search for switch	RW	RPDO	UINT32	RU/s	0 to (2 ³² -1)	100	Ru	St
	02	Speed during search for zero	RW	RPDO	UINT32	RU/s	10 to (2 ³² -1)	100	Ru	St
609A	00	Homing acceleration	RW	RPDO	UDINT32	RU/s ²	0 to (2 ³² -1)	100	Ru	St
60B0h	00	Position offset	RW	RPDO	INT32	RU	-2 ³¹ to (2 ³¹ -1)	0	Ru	St
60B1h	00	Velocity offset	RW	RPDO	INT32	RU/s	-2 ³¹ to (2 ³¹ -1)	0	Ru	St
60B2h	00	Torque offset	RW	RPDO	INT16	0.1%	-5000 to 5000	0	Ru	St
60B8h	00	Touch probe function	RW	RPDO	UINT16	-	0 to 65535	0	Ru	St
60B9h	00	Touch probe status	RO	TPDO	UINT16	-	0 to 65535	0	-	-
60BAh	00	Touch probe pos1 pos value	RO	TPDO	INT32	RU	-2 ³¹ to (2 ³¹ -1)	0	-	-
60BBh	00	Touch probe pos1 neg value	RO	TPDO	INT32	RU	-2 ³¹ to (2 ³¹ -1)	0	-	-
60BCh	00	Touch probe pos2 pos value	RO	TPDO	INT32	RU	-2 ³¹ to (2 ³¹ -1)	0	-	-
60BDh	00	Touch probe pos2 neg value	RO	TPDO	INT32	RU	-2 ³¹ to (2 ³¹ -1)	0	-	-
60E0h	00	Positive torque limit value	RW	RPDO	UINT16	0.1%	0 to 5000	5000	Ru	St
60E1h	00	Negative torque limit value	RW	RPDO	UINT16	0.1%	0 to 5000	5000	Ru	St
60E3h	Supported homing methods									
	00	Highest sub-index supported	RO	NO	UINT8	-	-	31	-	-
	01	1st supported homing method	RO	NO	UINT16	-	-	0301h	-	-
	02	2nd supported homing method	RO	NO	UINT16	-	-	0302h	-	-
	03	3rd supported homing method	RO	NO	UINT16	-	-	0303h	-	-
	04	4th supported homing method	RO	NO	UINT16	-	-	0304h	-	-
	05	5th supported homing method	RO	NO	UINT16	-	-	0305h	-	-
	06	6th supported homing method	RO	NO	UINT16	-	-	0306h	-	-
	07	7th supported homing method	RO	NO	UINT16	-	-	0307h	-	-
	08	8th supported homing method	RO	NO	UINT16	-	-	0308h	-	-
09	9th supported homing method	RO	NO	UINT16	-	-	0309h	-	-	

Index (hex)	Sub-index (hex)	Name	Access	PDO Mapping	Data Type	Unit	Data Range	Default	SC	EC
60E3h	0A	10th supported homing method	RO	NO	UINT16	-	-	030Ah	-	-
	0B	11th supported homing method	RO	NO	UINT16	-	-	030Bh	-	-
	0C	12th supported homing method	RO	NO	UINT16	-	-	030Ch	-	-
	0D	13th supported homing method	RO	NO	UINT16	-	-	030Dh	-	-
	0E	14th supported homing method	RO	NO	UINT16	-	-	030Eh	-	-
	0F	15th supported homing method	RO	NO	UINT16	-	-	030Fh	-	-
	10	16th supported homing method	RO	NO	UINT16	-	-	0310h	-	-
	11	17th supported homing method	RO	NO	UINT16	-	-	0311h	-	-
	12	18th supported homing method	RO	NO	UINT16	-	-	0312h	-	-
	13	19th supported homing method	RO	NO	UINT16	-	-	0313h	-	-
	14	20th supported homing method	RO	NO	UINT16	-	-	0314h	-	-
	15	21th supported homing method	RO	NO	UINT16	-	-	0315h	-	-
	16	22th supported homing method	RO	NO	UINT16	-	-	0316h	-	-
	17	23th supported homing method	RO	NO	UINT16	-	-	0317h	-	-
	18	24th supported homing method	RO	NO	UINT16	-	-	0318h	-	-
	19	25th supported homing method	RO	NO	UINT16	-	-	0319h	-	-
	1A	26th supported homing method	RO	NO	UINT16	-	-	031Ah	-	-
	1B	27th supported homing method	RO	NO	UINT16	-	-	031Bh	-	-
1C	28th supported homing method	RO	NO	UINT16	-	-	031Ch	-	-	
1D	29th supported homing method	RO	NO	UINT16	-	-	031Dh	-	-	
1E	30th supported homing method	RO	NO	UINT16	-	-	031Eh	-	-	
1F	31th supported homing method	RO	NO	UINT16	-	-	031Fh	-	-	
60E6h	00	Additional position encoder resolution – encoder increments	RW	NO	UINT8	-	0-1	0	Ru	St
60F4h	00	Following error actual value	RO	RPDO	DINT32	RU	-	-	-	-

Index (hex)	Sub-index (hex)	Name	Access	PDO Mapping	Data Type	Unit	Data Range	Default	SC	EC
60FCh	00	Position demand internal value	RO	TPDO	DINT32	EU	-	-	-	-
60FDh	00	Digital inputs	RO	RPDO	UDINT32	-	0 to FFFFFFFF	0	-	-
60FEh	Digital outputs									
	00	Highest sub-index supported	RO	NO	UINT8	-	-	1	-	-
	01	Physical outputs	RW	RPDO	UINT32	-	0 to FFFFFFFF	0	Ru	St
	02	Bit mask	RW	NO	UINT32	-	0 to FFFFFFFF	0	Ru	St
60FFh	00	Target velocity	RW	RPDO	INT32	RU/s	-2 ³¹ to (2 ³¹ -1)	0	Ru	St
6502h	00	Supported drive modes	RO	NO	UDINT32	-	-	3A1h	-	-

6.4 DIDO Function Definitions

No.	Function Symbol	Function Name	Description	Remarks
Input Function Description				
FunIN.2	ALM-RST	Fault and warning reset (edge valid)	Invalid: Disabled Valid: Enabled	<p>This DI function is edge valid rather than high/low level valid.</p> <p>The servo drive can continue to operate after fault/warning reset.</p> <p>When this function is allocated to a low-speed DI and logic of the DI is level valid, the servo drive will forcibly changes it to edge logic. The valid level change must last for more than 3 ms; otherwise, the fault reset function becomes invalid.</p> <p>Do not allocate this function to high-speed DI. Otherwise, Fault/warning reset will be invalid.</p>
FunIN.3	GAIN-SEL	Gain switchover	2008-09h = 0: Invalid: Speed control loop being PI control Invalid: Speed control loop being P control 2008-09h = 1: Operation according to the setting of 2008-0Ah	It is recommended that the logic of the corresponding terminal be set to level valid.
FunIN.12	ZCLAMP	Zero speed clamp	Valid: Zero speed clamp enabled Invalid: Zero speed clamp disabled	It is recommended that the logic of the corresponding terminal be set to level valid.

No.	Function Symbol	Function Name	Description	Remarks
FunIN.13	INHIBIT	Position reference inhibited	Invalid: The servo drive responds to position references in position control mode. Valid: The servo drive does not respond to any internal or external position reference in position control mode.	The position references include internal and external position references. It is recommended that the logic of the corresponding terminal be set to level valid.
FunIN.14	P-OT	Positive limit switch	Valid: Positive drive inhibited Invalid: Positive drive permitted	When the mechanical movement is outside the movable range, the servo drive implements the function of preventing the motor from sensing the limit switch. It is recommended to set the logic of the corresponding terminal to level valid.
FunIN.15	N-OT	Negative limit switch	Valid: Negative drive inhibited Invalid: Negative drive permitted	
FunIN.16	P-CL	External positive torque limit	The torque limit source is switched over based on the setting of 2007-08h. 2007-08h = 1: Valid: External positive torque limit enabled Invalid: Internal positive torque limit enabled 2007-08h = 3 and AI limit larger than external positive limit Valid: External positive torque limit enabled Invalid: AI torque limit enabled 2007-08h = 4: Valid: AI torque limit enabled Invalid: Internal positive torque limit enabled	It is recommended that the logic of the corresponding terminal be set to level valid.
FunIN.17	N-CL	External negative torque limit	The torque limit source is switched over based on the setting of 2007-08h. 2007-08h = 1: Valid: External negative torque limit enabled Invalid: Internal negative torque limit enabled 2007-08h = 3 and AI limit larger than external negative limit Valid: External negative torque limit enabled Invalid: AI torque limit enabled 2007-08h = 4: Valid: AI torque limit enabled Invalid: Internal negative torque limit enabled	

No.	Function Symbol	Function Name	Description	Remarks
FunIN.18	JOGCMD+	Forward jog	Valid: Execute reference input Invalid: Not receive reference input	It is recommended that the logic of the corresponding terminal be set to level valid.
FunIN.19	JOGCMD-	Reverse jog	Valid: Input reverse to reference direction Invalid: Reference input stopped	It is recommended that the logic of the corresponding terminal be set to level valid.
FunIN.25	TOQDirSel	Torque reference direction selection	Valid: Forward direction Invalid: Reverse direction	It is recommended that the logic of the corresponding terminal be set to level valid.
FunIN.26	SPDDirSel	Speed reference direction selection	Valid: Forward direction Invalid: Reverse direction	It is recommended that the logic of the corresponding terminal be set to level valid.
FunIN.27	POSDirSel	Position reference direction selection	Valid: Actual position reference direction same as given position reference direction Invalid: Actual position reference direction opposite to given position reference direction	It is recommended that the logic of the corresponding terminal be set to level valid.
FunIN.31	HomeSwitch	Home switch	Invalid: Not triggered Valid: Triggered, current position being home	The logic of the corresponding terminal needs to be set to level valid. Allocate this function to the high-speed DI terminal. If the logic is set to 2 (rising edge valid), the servo drive forcibly changes it to 1 (high level valid). If the logic is set to 3 (falling edge valid), the servo drive forcibly changes it to 0 (low level valid). If the logic is set to 4 (both rising edge and falling edge valid), the servo drive forcibly changes it to 0 (low level valid).
FunIN.34	EmergencyStop	Emergency stop	Valid: Position lock after emergency stop Invalid: Current running state unaffected	It is recommended that the logic of the corresponding terminal be set to level valid.

No.	Function Symbol	Function Name	Description	Remarks
FunIN.35	ClrPosErr	Position deviation cleared (edge valid)	Valid: Position deviation cleared Invalid: Position deviation not cleared	It is recommended that the logic of the corresponding terminal be set to edge valid. If the logic is set to 1 (high level valid), the servo drive forcibly changes it to 2 (rising edge valid). If the logic is set to 0 (low level valid), the servo drive forcibly changes it to 3 (falling edge valid). It is recommended that this function be allocated to DI8 or DI9.
FunIN.36	V_LmtSel	Internal speed limit source	Valid: -(2007-15h) as internal speed limit (2007-12h = 2) Valid: -(2007-19h) as internal speed limit (2007-12h = 2)	It is recommended that the logic of the corresponding terminal be set to level valid.
FunIN.37	PulseInhibit	Pulse input inhibited	When the position reference source is pulse input (H05-00 = 0) in the position control mode: Invalid: Respond to pulse input Valid: Not respond to pulse input	It is recommended that the logic of the corresponding terminal be set to level valid.
Output Function Description				
FunOUT.1	S-RDY	Servo ready	The servo drive is in ready state and can receive the S-ON signal. Valid: Servo drive ready Invalid: Servo drive not ready	Servo not ready: A No. 1 or 2 fault occurs in the servo drive, or the DI emergency stop signal is active.
FunOUT.2	TGON	Motor rotation output	When motor speed larger than speed threshold 2006-01h: Valid: Motor rotation output Invalid: No motor rotation output	-
FunOUT.3	ZERO	Zero speed signal	Output signal when motor stops rotation: Valid: Motor speed being 0 Invalid: Motor speed being not 0	-
FunOUT.4	V-CMP	Speed consistent	In the speed control mode, when the absolute value of the deviation between the motor speed and the speed reference is smaller than the value of 606Dh and the duration lasts for 606Eh, this signal is active.	-

No.	Function Symbol	Function Name	Description	Remarks
FunOUT.5	COIN	Positioning completed	In the position control mode, when the position deviation pulses reach the value of 6067h and the duration lasts for 6068h, this signal is active.	-
FunOUT.6	NEAR	Positioning near	In the position control mode, when the position deviation pulses reach the value of H05-22, this signal is active.	-
FunOUT.7	C-LT	Torque limit	Confirming torque limit: Valid: Motor torque limited Invalid: Motor torque not limited	-
FunOUT.8	V-LT	Speed limit	Confirming speed limit in torque control: Invalid: Motor speed not limited Valid: Motor speed limited	-
FunOUT.9	BK	Brake output	Brake output: Invalid: The power is on, the brake is applied, and the motor is in position lock state. Valid: The power is off, the brake is released, and the motor can rotate.	-
FunOUT.10	WARN	Warning output	The warning output is active (conducted).	-
FunOUT.11	ALM	Fault output	This signal is valid when a fault occurs.	-
FunOUT.12	ALMO1	3-digit fault code output	A 3-digit fault code is output.	-
FunOUT.13	ALMO2	3-digit fault code output	A 3-digit fault code is output.	-
FunOUT.14	ALMO3	3-digit fault code output	A 3-digit fault code is output.	-
FunOUT.18	ToqReach	Torque reached	Valid: Absolute value of torque reference reaching setting value Invalid: Absolute value of torque reference smaller than setting value	-
FunOUT.19	V-Arr	Speed reached	Valid: Speed feedback reaches setting value Invalid: Speed feedback smaller than setting value	-
FunOUT.20	AngIntRdy	Angle auto-tuning output	Valid: Angle auto-tuning completed Invalid: Angle auto-tuning not completed	-

Revision History

Date	Version	Change Description
August 2016	A00	First issue.
Dec 2016	A01	Modified product name, designation rule and nameplate.
August 2017	A02	Corrected wiring diagram and parameters.
November 2018	A03	Updated LOGO.
October 2019	A04	Added with a barcode.

Shenzhen Inovance Technology Co., Ltd.

Add.: Building E, Hongwei Industry Park, Liuxian Road, Baocheng No. 70 Zone, Bao' an District, Shenzhen

Tel: +86-755-2979 9595

Fax: +86-755-2961 9897

Service Hotline: 400-777-1260

<http://www.inovance.com>

Suzhou Inovance Technology Co., Ltd.

Add.: No. 16 Youxiang Road, Yuexi Town, Wuzhong District, Suzhou 215104, P.R. China

Tel: +86-512-6637 6666

Fax: +86-512-6285 6720

Service Hotline: 400-777-1260

<http://www.inovance.com>



19010456A04

Copyright © Shenzhen Inovance Technology Co., Ltd.