

User Manual

TesiMod Operating Terminal BT22

Part Number: 80 860.583
Version: 1
Date: 02.06.2004
Valid for: BT22EM, BT22ES, BT22ET

Version	Date	Modifications
1	2 June 2004	First Edition

This manual, including all illustrations contained herein, is copyright protected. Use of this manual by any third party in departure from the copyright provision is forbidden. No part of this manual may be reproduced, translated or electronically or photographically archived or altered without the express written consent from Süttron electronic GmbH. Violations shall be cause for damage liability.

Süttron electronic reserves the right to make any changes that contribute to technical improvement.

Overall Table of Contents

1	Important Notes	1-1
	1.1 Symbols	1-1
	1.1.1 General Symbols	1-1
	1.1.2 Specific Symbols	1-1
	1.2 Safety Notes	1-2
	1.3 Intended Use.....	1-2
	1.4 Target Group.....	1-2
2	Installation and Commissioning	2-1
	2.1 Unpacking the Device	2-1
	2.2 Mounting the Device	2-1
	2.2.1 Front Panel Dimensions	2-2
	2.2.2 Mounting Cutout	2-3
	2.2.3 Side View, Mounting Depth	2-4
	2.2.3.1 Standard Device	2-4
	2.2.3.2 Field Bus Device.....	2-5
	2.3 Connecting the device	2-6
	2.3.1 Supply Voltage 24 V	2-6
	2.4 Switching the Device on.....	2-8
	2.5 Identification.....	2-8
3	Control and Display Elements	3-1
	3.1 Keyboard.....	3-1
	3.1.1 Editing Keys.....	3-2
	3.1.2 Control Keys	3-3
	3.1.3 Special Keys	3-4
	3.1.4 Function Keys	3-5
	3.1.4.1 Function Key Arrangement.....	3-5
	3.1.4.2 Slide-in Identifications Strips for the Function Keys.....	3-6
	3.2 User Mode Switch.....	3-7
	3.3 Display	3-7
	3.3.1 Contrast / Brightness Setting	3-8
	3.3.2 Default Contrast / Brightness Setting.....	3-9
	3.3.3 Character Attributes.....	3-9
	3.3.4 Fonts.....	3-9
4	Interfaces of the Device	4-1
	4.1 Standard Interfaces.....	4-2
	4.1.1 TTY / 20 mA Current Loop (X3-SER1)	4-3
	4.1.1.1 Pin Assignment.....	4-3
	4.1.1.2 Termination.....	4-4

4.1.2	RS485 (X3-SER1).....	4-5
4.1.2.1	Pin Assignment.....	4-5
4.1.2.2	Termination.....	4-6
4.1.3	RS232c (X3-SER1).....	4-7
4.1.3.1	Pin Assignment.....	4-7
4.1.3.2	Termination.....	4-7
4.1.4	RS232c (X3-SER2).....	4-8
4.1.4.1	Pin Assignment.....	4-8
4.2	Field Bus Interfaces	4-9
4.2.1	CAN (X2.1/X2.2)	4-9
4.2.1.1	Pin Assignment.....	4-10
4.2.1.2	Cable	4-11
4.2.1.3	Termination.....	4-11
4.2.1.4	Diagnostic.....	4-11
4.2.2	DeviceNet (X2.1/X2.2)	4-12
4.2.2.1	Pin Assignment.....	4-13
4.2.2.2	Cable	4-14
4.2.2.3	Termination.....	4-14
4.2.2.4	Diagnostic.....	4-14
4.2.3	INTERBUS (X2.1/X2.2).....	4-15
4.2.3.1	Pin Assignment.....	4-16
4.2.3.2	Cable	4-17
4.2.3.3	Diagnostic.....	4-17
4.2.4	INTERBUS OPC LWL (DO1/DI1/DO2/DI2)	4-18
4.2.4.1	Connector Pin Assignment.....	4-19
4.2.4.2	Cable	4-19
4.2.4.3	Diagnostic.....	4-20
4.2.5	MPI (X2)	4-21
4.2.5.1	Pin Assignment.....	4-22
4.2.5.2	Cable	4-23
4.2.5.3	Termination.....	4-23
4.2.5.4	Diagnostic.....	4-23
4.2.6	PROFIBUS-DP (X2).....	4-24
4.2.6.1	Pin Assignment.....	4-25
4.2.6.2	Cable	4-26
4.2.6.3	Diagnostic.....	4-26
4.3	Memory Card	4-27
4.3.1	Inserting the Memory Card	4-27
4.3.2	Ejecting the Memory Card	4-27
4.4	Shielding D-SUB Connectors.....	4-28
5	Maintenance and Servicing.....	5-1
5.1	Maintenance Interval.....	5-1
5.2	Front Panel.....	5-1
5.3	Fuse	5-1
5.4	Battery.....	5-1
5.4.1	Changing the Battery	5-2
5.4.2	Battery Disposal.....	5-3

6	Technical Data.....	6-1
7	Ordering Data	7-1
A	Index.....	A-1

1 Important Notes

1.1 Symbols

The symbols in this manual are used to draw your attention on notes and dangers.

1.1.1 General Symbols

**Danger**

This symbol is used to refer to instructions which, if ignored or not carefully followed could result in personal injury.

**Note**

This symbol indicates application tips or supplementary notes.

**Reference to source of information**

This symbol refers to detailed sources of information on the current topic.

1.1.2 Specific Symbols

The following symbols indicate specific dangers which could result in damage to equipment or personal injury or even up to the death of the operator.

**Danger - Electric Shock****Danger - Corrosive****Danger - Toxic****Danger - Explosive****Danger - Fire****Danger - Infrared Light****Danger - Electrostatic Charge**

1.2 Safety Notes

- Read this manual carefully before using the operating device. Keep this manual in a place where it is always accessible to all users.
- Proper transportation, handling and storage, placement and installation of this product are prerequisites for its subsequent flawless and safe operation.
- This user manual contains the most important information for the safe operation of the device.
- The user manual, in particular the safety notes, must be observed by all personnel working with the device.
- Observe the accident prevention rules and regulations that apply to the operating site.
- Installation and operation must only be carried out by qualified and trained personnel.

1.3 Intended Use

- The device is designed for use in the industry.
- The device is state-of-the art and has been built to the latest standard safety requirements. However, dangerous situations or damage to the machine itself or other property can arise from the use of this device.
- The device fulfills the requirements of the EMC directives and harmonized European standards. Any modifications to the system can influence the EMC behavior.



This is a class A device. This device may cause radio interference in residential areas. In this case, the user may be required to introduce appropriate countermeasures, and to bear the cost of same.

1.4 Target Group

All configuration, programming, installation, commissioning, operating and maintenance work in connection with the automation system must be performed by trained personnel only (e.g. qualified electricians, electrical engineers, etc.).

The configuration and programming personnel must be familiar with the safety concepts of automation technology.

The operating personnel must have been trained in handling the controller and be familiar with the operating instructions.

The installation, commissioning and maintenance personnel must have an education which entitles them to work on automation systems.

2 Installation and Commissioning

2.1 Unpacking the Device

Unpack all parts carefully and check the contents for any visible damage in transit. Also check whether the shipment matches the specifications on your delivery note.

If you notice damages in transit or discrepancies, please contact our sales department immediately.

2.2 Mounting the Device



When installing the operating device, keep a minimum clearance of 30 mm (1.181") around the operating device to ensure adequate air circulation.



When the operating device is installed horizontally, please note that additional sources of heat beneath the operating device may result in heat accumulation. Make sure to allow sufficient heat dissipation! Comply with the allowable temperature range listed in the technical data for the use of the operating device!



To maintain the specified degree of protection, make sure the seal is evenly seated on the installation surface and the hexagon nuts are tightened uniformly. Ensure that the maximum torque of 1.2 Nm is not exceeded.

The operating device can be easily and quickly mounted from the rear of the operating device. This is particularly recommended for mounting in switchboards with a plate thickness of approx. 1 mm to 10 mm (0.039" to 0.394").

1. Insert the operating device from the front through the mounting cutout.
2. Fasten the operating device using hexagon nuts.

2.2.1 Front Panel Dimensions

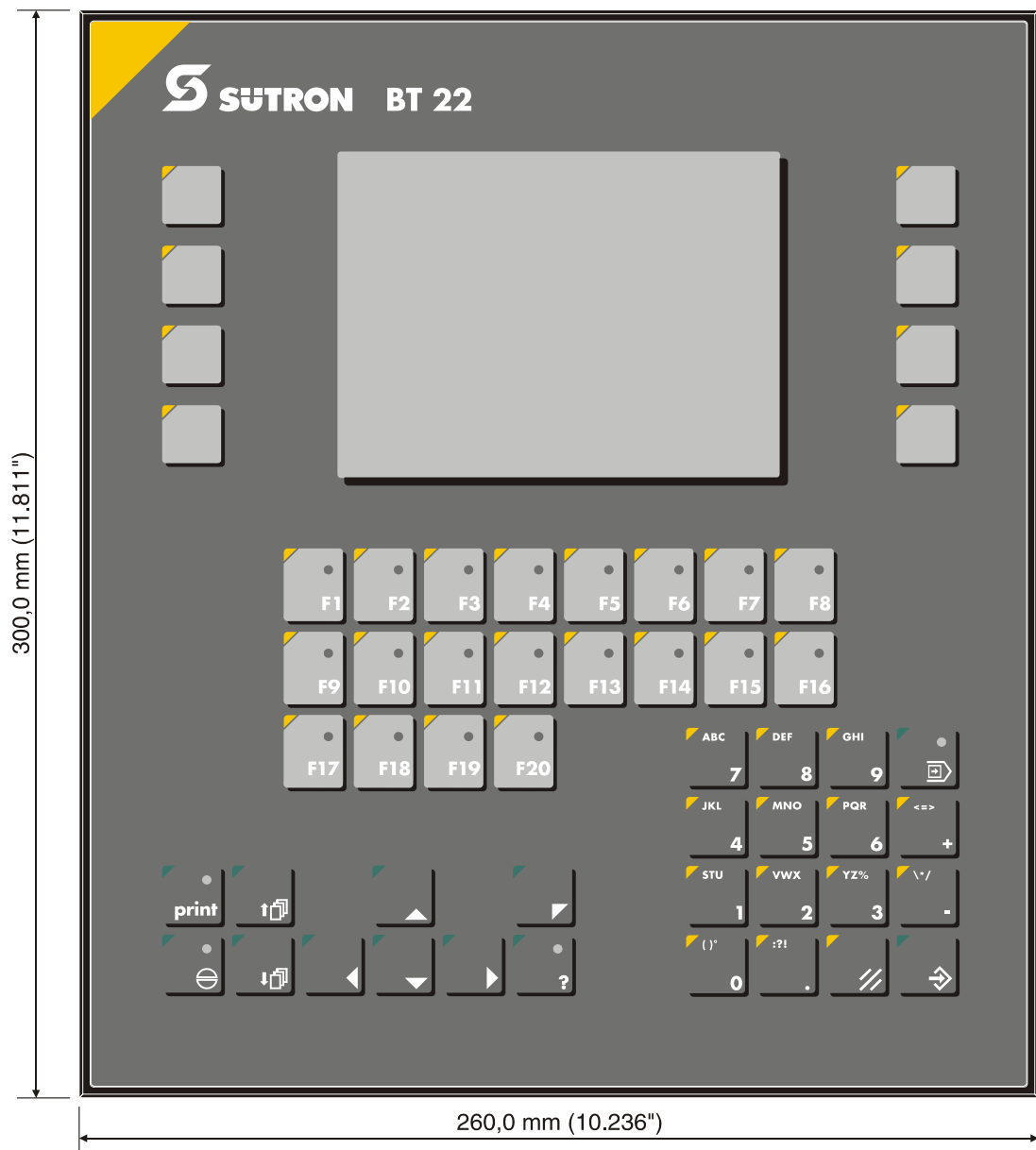

Figure 2-1 Front panel dimensions

2.2.2 Mounting Cutout

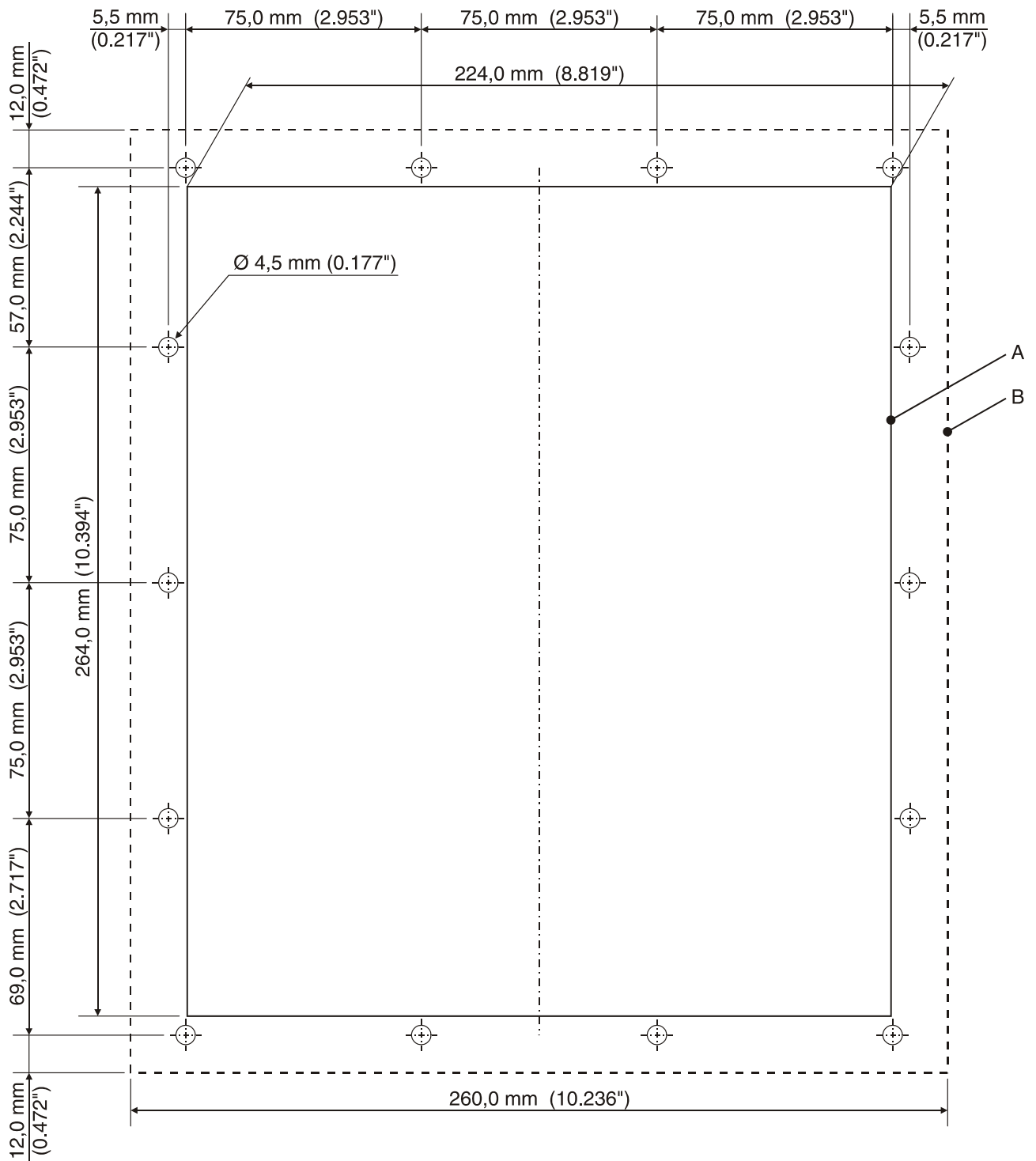

Figure 2-2 Mounting cutout

- A Mounting Cutout
- B Front Panel

2.2.3 Side View, Mounting Depth

2.2.3.1 Standard Device

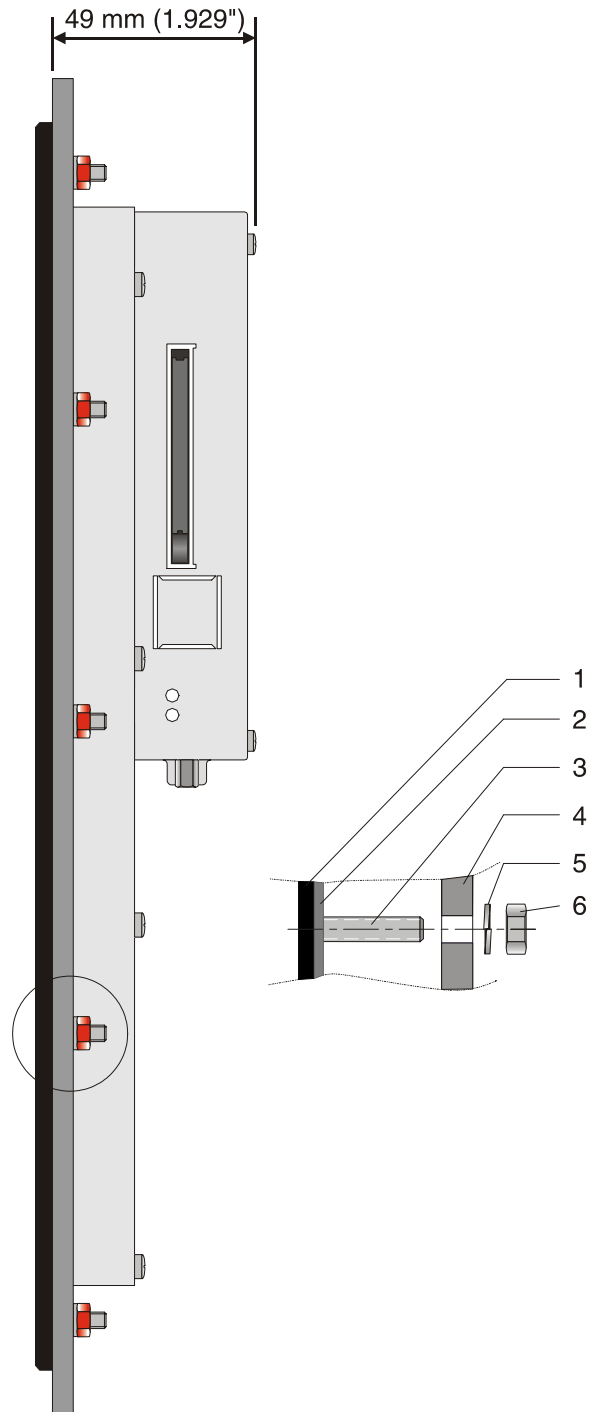

Figure 2-3 Side view and mounting depth for the standard device

- 1 Front Panel
- 2 Circumferential Seal
- 3 Press-in Threaded Bolt M4 x 20 mm (0,787")
- 4 Mounting Surface Thickness 1 mm to 10 mm (0.039" to 0.394")
- 5 Spring Lock Washer B4 DIN 127 Form B (not supplied)
- 6 Nut M4 DIN 934 (not supplied)

2.2.3.2 Field Bus Device

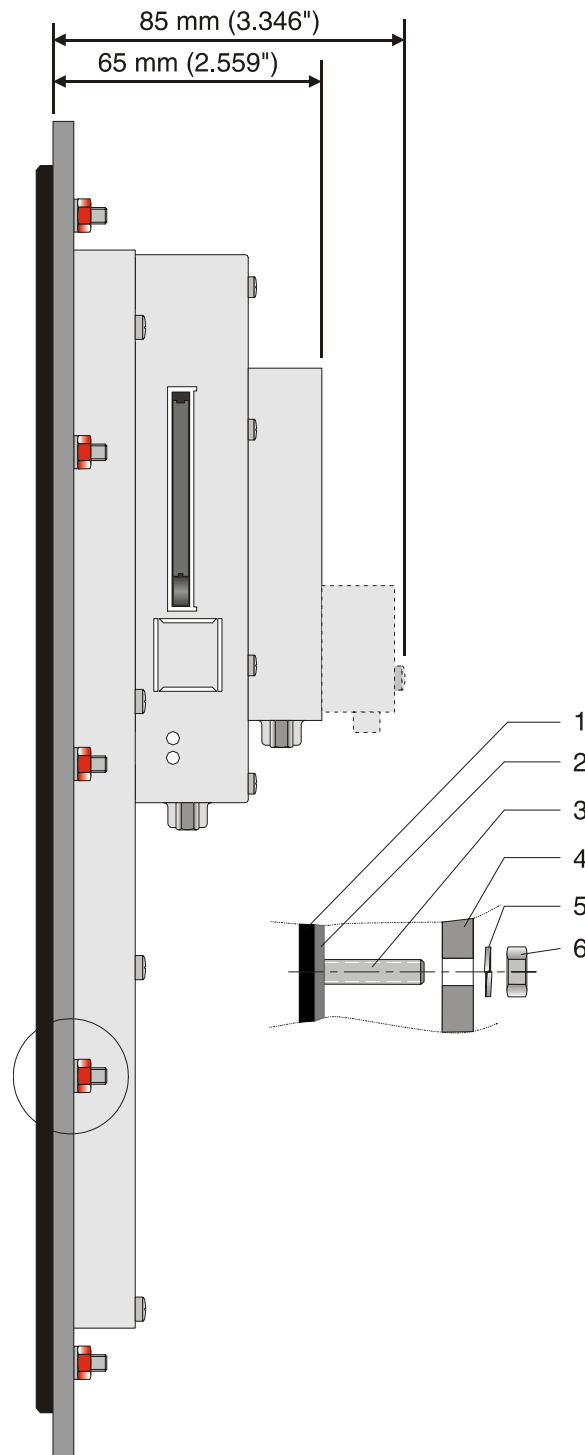

Figure 2-4 Side view and mounting depth for the field bus device

- 1 Front Panel
- 2 Circumferential Seal
- 3 Press-in Threaded Bolt M4 x 20 mm (0,787")
- 4 Mounting Surface Thickness 1 mm to 10 mm (0.039" to 0.394")
- 5 Spring Lock Washer B4 DIN 127 Form B (not supplied)
- 6 Nut M4 DIN 934 (not supplied)

2.3 Connecting the device

2.3.1 Supply Voltage 24 V

The supply voltage is supplied via connector X1.A.

The device can optionally be equipped with an additional connector (X1.B). In this case, X1.A is looped through to X1.B and can be used to provide power supply to other components (e.g. bus node). The pin assignment is the same for both connectors.



The maximum continuous current allowed to flow from connector X1.A to X1.B is 5 A. To avoid an overload, an external protection must be installed (e.g. fusible cut-out).

The device has reverse polarity protection. In case of wrong polarity, the device will not operate.

This is a protection class I device. For safe operation, safety extra-low voltage (SELV) in accordance with DIN EN 61131 must be used for the supply voltage.

Connector in the operating device: 3 pin connector Phoenix COMBICON MSTBV 2.5/3-GF

Table 2-1 Pin assignment supply voltage

Pin	Designation	Function
1		Low-Noise Ground
2	0 V	Supply Voltage 0 V
3	24 VDC	Supply Voltage 24 VDC

A suitable female connector strip of the type Phoenix COMBICON MSTB 2.5/3-STF is supplied.



Cables with finely stranded conductors with a minimum cross-section of 0.75 mm² (18 AWG) and a maximum cross-section of 2.5 mm² (14 AWG) must be used for the supply voltage.



Hazardous voltages can exist inside electrical installations that can pose a danger to humans. Coming in contact with live parts **may result in electric shock!**

Use the following procedure to connect the device to the supply voltage:

- Strip approx. 30 mm (1.181") off the outer cable sheath and approx. 5 mm (0.197") off the wires.

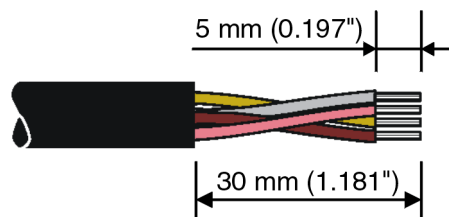

Figure 2-5 Preparing the cable

2. Fit the wires with wire end ferrules and connect the wires to the connector.

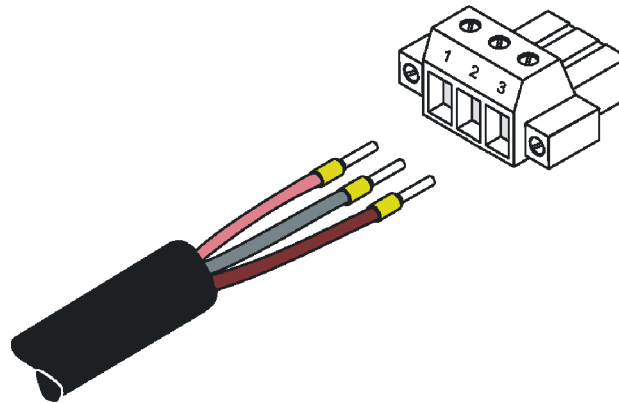

Figure 2-6 Connecting the female connector strip



If shielded connecting cables are used in the supply voltage area, the shield should be connected to pin 1.

3. Plug the female connector strip onto connector X1.A.

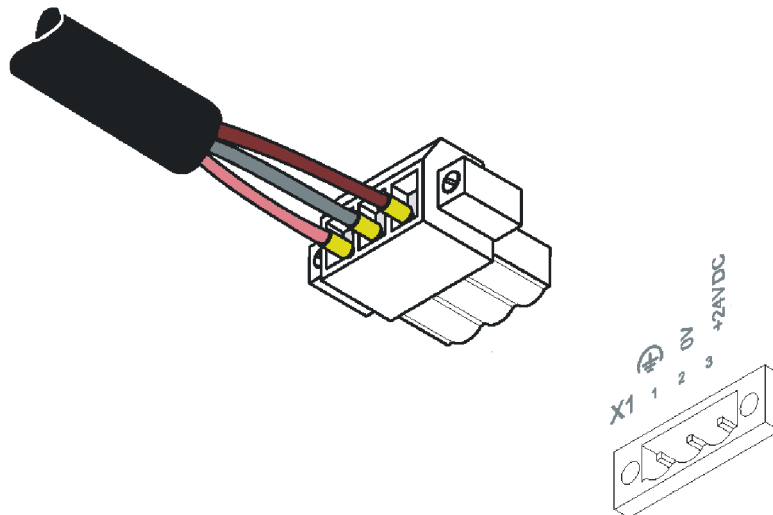

Figure 2-7 Female connector strip is plugged on

4. Secure the female connector strip in place with a screw-type locking to prevent it from slipping out.



A separate conductor must always be provided for the protective grounding at the threaded bolt. The conductor must have a minimum cross-section of 1.5 mm² (16 AWG) and must be kept as short as possible.

2.4 Switching the Device on

After you applied the supply voltage, a system test is carried out during which the modules in the operating device are tested and initialized. All status LEDs are activated for a short time. A number of system and error messages can be output by the system test. If the application memory contains a valid project, the first mask, i.e. the „Start mask“ or the mask defined in the TSwin language parameters as the Start-up mask appears on the display.

The „Start mask“ is displayed for 5 seconds. This is a fixed time setting. After this time has elapsed, the „Main mask“ or the mask defined in the language parameters as the Main mask appears on the display. This is the first mask of the operator guidance.

When you push any button while the „Start mask“ is displayed, the „Setup mask“ appears. In this mask you define the parameters for the interfaces and the operating device.

2.5 Identification

You can identify the operating device by the nameplate on the rear.

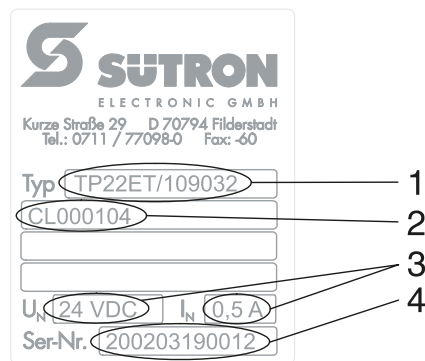

Figure 2-8 Nameplate (example)

- 1 Order Number
- 2 Firmware Version (Version on Delivery)
- 3 Voltage and Current
- 4 Serial Number

Depending on the size of the display, you will be able to read various types of information as the operating device is initialized: clock frequency, application memory size, current firmware version, TSwin version, project name, time, date, number of compilation runs and a random number.



Because the initialization mask is visible only for a few seconds there is a possibility to represent this mask for a longer time period.

1. Hold down an arbitrary key at the operating device to generate an error message.
2. Read the firmware version now.
3. Release the key to complete the initialization procedure of the operating device.

3 Control and Display Elements

3.1 Keyboard

The keys are positioned under an environmental-proof polyester foil. You project the operating principle of the keys in the programming software.

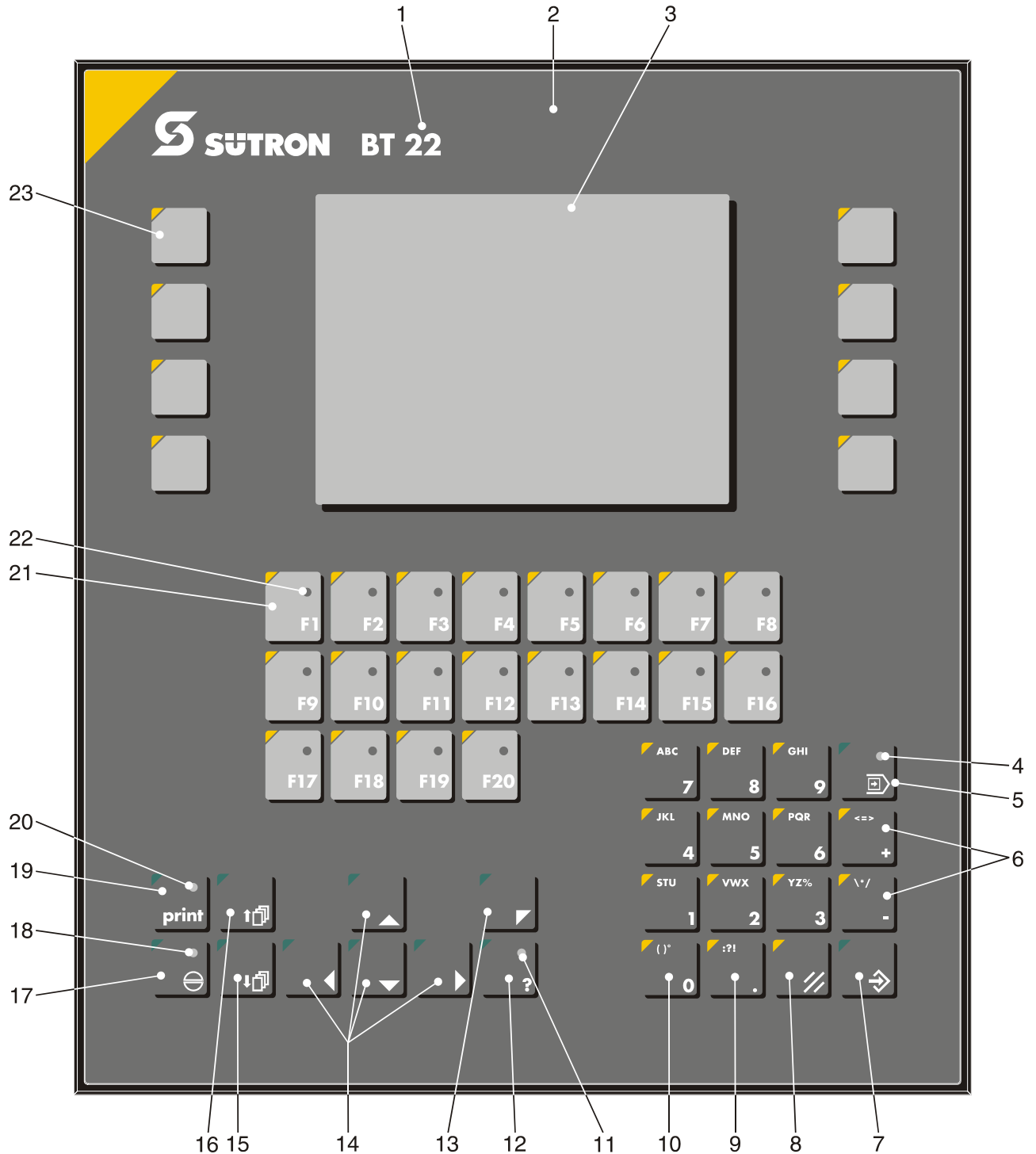

Figure 3-1 Front view

- 1 Device Designation
- 2 Front Foil
- 3 Display
- 4 Status LED Data Release
- 5 Special Key Data Release
- 6 Editing Key Plus / Minus
- 7 Special Key Enter
- 8 Special Key Delete
- 9 Editing Key Decimal Point
- 10 Editing Key 0 to 9, Alphabet
- 11 Status LED Help
- 12 Special Key Help
- 13 Control Key Home
- 14 Control Keys Cursor Left, Right, Up, Down
- 15 Control Key Page Down
- 16 Control Key Page Up
- 17 Special Key Acknowledge
- 18 Status LED Acknowledge
- 19 Special Key Print
- 20 Status LED Print
- 21 Function Keys F1 to F20
- 22 Status LED Function Key
- 23 Soft Key SK1 to SK8

3.1.1 Editing Keys



The key **0 and () °** is used for changing data in the editor. The (,) and ° characters can be entered when configuring the **Shift** or **ShiftCase** system variables.



The key **1 and STU** is used for changing data in the editor. The characters S, T and U can be entered when configuring the **Shift** or **ShiftCase** system variables.



The key **2 and VWX** is used for changing data in the editor. The characters V, W and X can be entered when configuring the **Shift** or **ShiftCase** system variables.



The key **3 and YZ%** is used for changing data in the editor. The characters Y, Z and % can be entered when configuring the **Shift** or **ShiftCase** system variables.



The key **4 and JKL** is used for changing data in the editor. The characters J, K and L can be entered when configuring the **Shift** or **ShiftCase** system variables.



The key **5 and MNO** is used for changing data in the editor. The characters M, N and O can be entered when configuring the **Shift** or **ShiftCase** system variables.



The key **6 and PQR** is used for changing data in the editor. The characters P, Q and R can be entered when configuring the **Shift** or **ShiftCase** system variables.



The key **7 and ABC** is used for changing data in the editor. The characters A, B and C can be entered when configuring the **Shift** or **ShiftCase** system variables.



The key **8 and DEF** is used for changing data in the editor. The characters D, E and F can be entered when configuring the **Shift** or **ShiftCase** system variables.



The key **9 and GHI** is used for changing data in the editor. The characters G, H and I can be entered when configuring the **Shift** or **ShiftCase** system variables.



The key **Decimal point and :?!** is used for changing data in the editor. The characters :, ? and ! can be entered when configuring the **Shift** or **ShiftCase** system variables.



The key **Plus and <=>** is used for changing data in the editor. The characters <, = and > can be entered when configuring the **Shift** or **ShiftCase** system variables.



The key **Minus and */** is used for changing data in the editor. The characters \, * and / can be entered when configuring the **Shift** or **ShiftCase** system variables.

3.1.2 Control Keys



The key **Cursor left** can be programmed to directly select adjacent I/O masks. In the editor, it moves the cursor within a variable to the left by one character (character selection).



The key **Cursor right** can be programmed to directly select adjacent nodes and I/O masks. In the editor it moves the cursor one character to the right (character selection).

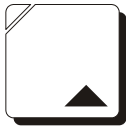

The key **Cursor up** can be programmed to directly select adjacent nodes and I/O masks. In the editor it moves the cursor up one variable (variable selection).



The key **Cursor down** can be programmed to directly select adjacent I/O masks. In the editor, it moves the cursor downwards to the next variable (variable selection).



The key **Cursor home** can be programmed to directly select higher-level nodes and I/O masks. In the editor it returns the cursor to the first input variable position.



The key **Page up** is used to page through tables, recipes and messages. The functionality corresponds to the system variable TabPgUp. The key allows data content towards the top of the table to be viewed.

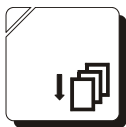

The key **Page down** is used to page through tables, recipes and messages. The functionality corresponds to the system variable TabPgDn. The key allows data content towards the bottom of the table to be viewed.

3.1.3 Special Keys



The key **Help** always displays the current help text (online help). The help key LED flashes when a system message is pending. The system message is always displayed in plain-text.



The key **Data Release** is used to switch from the menu into the editor. The integrated LED lights up in the editing mode if the external data release has been set. When the Data Release key is pressed within the editor, the editing mode is exited.



The key **Enter** is used to conclude data entry. When pressed while in the Startup Mask, the key switches into the Setup Mask.



The key **Delete** deletes the character beneath the cursor in the editor. Removes the selected messages from the data memory.



The key **Acknowledge** is used as acknowledge key for the message system. The LED flashes when a acknowledge is required.



The key **Print** can be used as a soft key to activate various print jobs. The LED flashes when a print process is active.

3.1.4 Function Keys



The function of the function keys is freely assignable (with soft key functions). The function keys can be used either as direct keys for menu control or for triggering a function in the controller.



The function of the soft keys is freely assignable. The function keys can be used either as direct keys for menu control or for triggering a function in the controller.

3.1.4.1 Function Key Arrangement

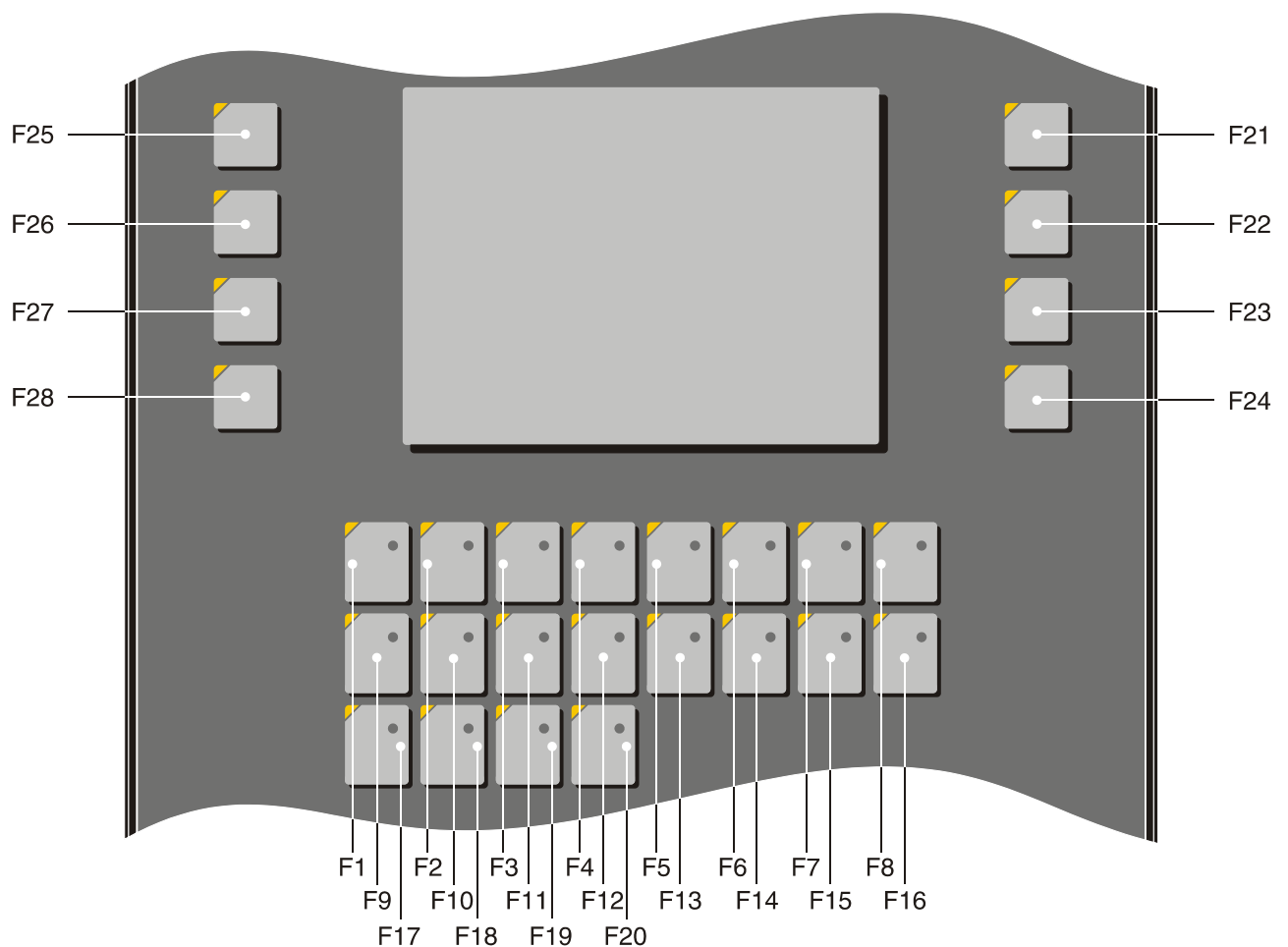

Figure 3-2 Arrangement of the function keys

3.1.4.2 Slide-in Identifications Strips for the Function Keys

The identifications strips can be replaced when the operating device is removed. Inserting the strip from the rear side of the front plate does not influence the specified seal of the operator terminal. A set of identification strips is supplied with the operator terminal.

For the labeling use:

Single pieces, prototypes	Label with a water-resistant pen
Small series	Copying foil (thickness $\leq 70 \mu\text{m}$) with laser print
Large series	Customer-specific labeled identification strips

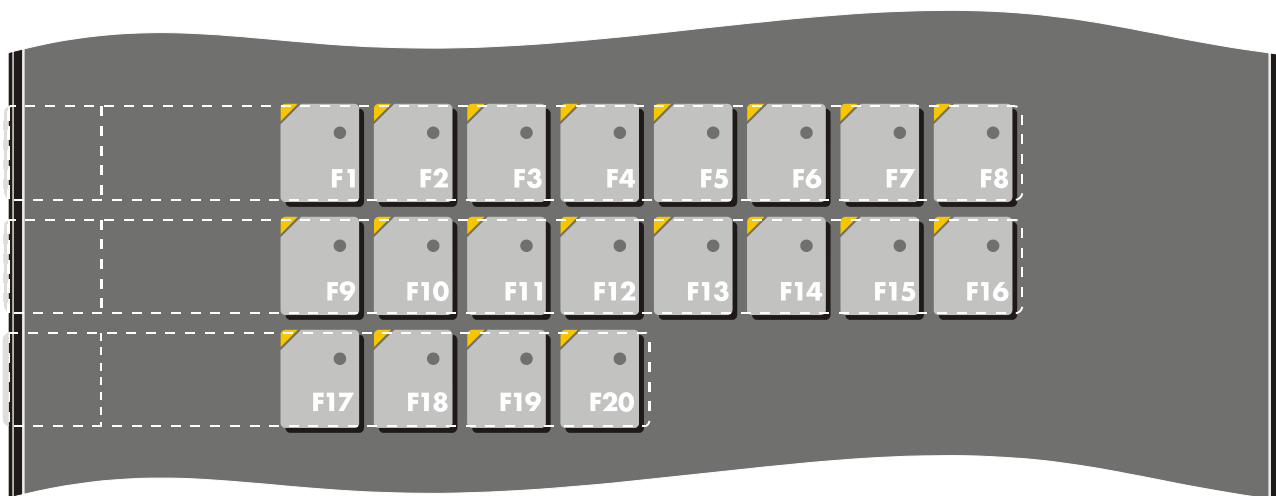

Figure 3-3 Position of the slide-in identifications strips

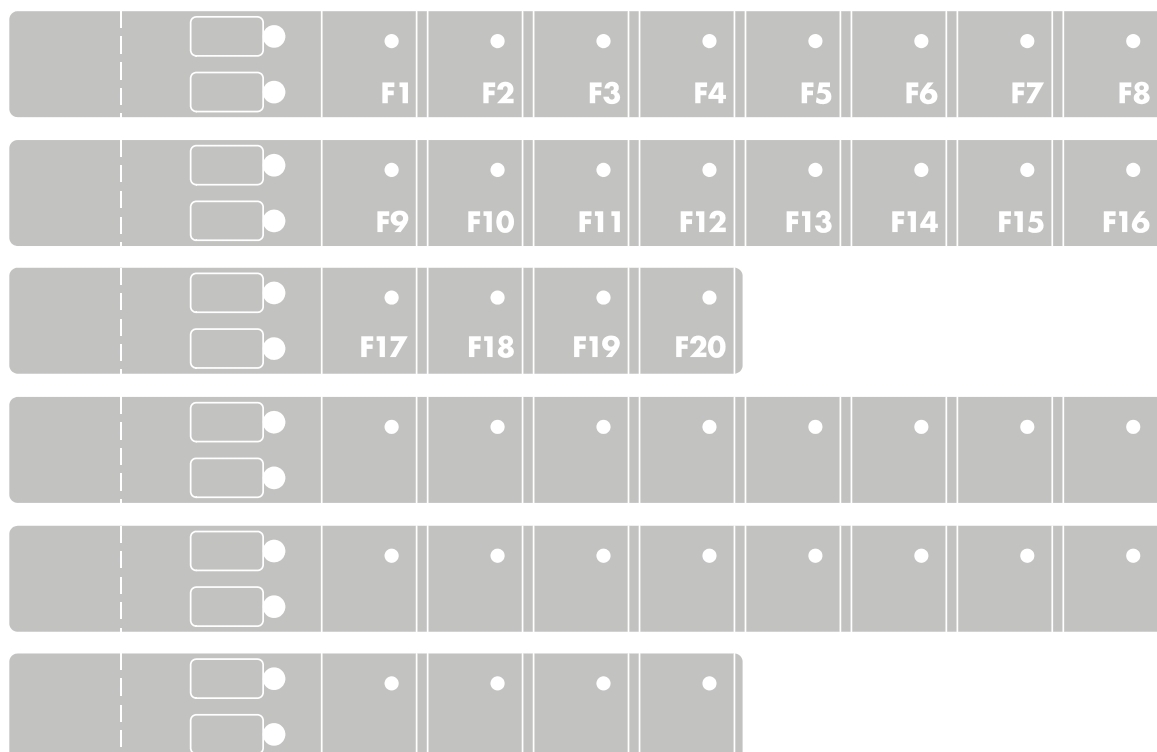

Figure 3-4 Set of slide-in identifications strips

3.2 User Mode Switch

The user mode switch is installed at the rear of the operating device.



The switch positions for ON or OFF are shown on the user mode switch.

Table 3-1 User mode switch

S1	S2	S3	S4	Function
I	X	–	–	Standard mode with PLC (default upon delivery)
I	X	I	–	Standard mode without PLC
–	I	–	–	Transparent-Mode with start- and stop code of the keys
–	–	–	I	Transparent-Mode without stop code of the keys
I	–	–	I	Activate download (erases the application memory) and default contrast / brightness setting
I	–	I	I	Activate upload

Legend for table:

I = Switch ON

– = Switch OFF

X = Any switch position

3.3 Display



Danger - Toxic!

If the display is damaged, avoid touching, swallowing or breathing in the liquids or gases which may leak out!



Danger - Corrosive!

If the display is damaged, avoid touching, swallowing or breathing in the liquids or gases which may leak out!

The operating device is equipped with different displays depending on variant. Depending on the display variant you can influence the contrast and the brightness.

Table 3-2 Display variants

Display Type	Order No.	Contrast Setting	Brightness Setting
STN (Monochrome)	xxxxEM/xxxxxx	X	-
STN (Color)	xxxxES/xxxxxx	X	X
TFT	xxxxET/xxxxxx	-	X

3.3.1 Contrast / Brightness Setting

To define the contrast / brightness setting, set up the system variable **LcdContrast** or **LcdBackLight** in any mask within the programming software.



To do so, follow the instructions listed in the programming software's help topic „How do I specify the contrast / brightness setting for the operating device“.

In the programming software, enter the following values as lower and upper limits for the representation type.

Table 3-3 Values for representation type

System Variable	Lower Limit	Upper Limit	Default Setting
LcdContrast	0	+ 31	+ 16
LcdBackLight	0	+ 15	+ 8



If you do not configure the system variable **LcdContrast** or **LcdBackLight**, the default setting is used when the device is initialized.

If you did set up the system variable, you can set the contrast / brightness as follows. Enter the mask where you set up the system variable and:

1. Press the contrast / brightness button.
2. Enter a new value for the contrast / brightness. To do so, use the keyboard shown on the screen.
3. Confirm with Enter.

The new contrast / brightness setting becomes effective immediately after the Enter key is pressed. If necessary, repeat the steps two and three until you are satisfied with the contrast / brightness.

3.3.2 Default Contrast / Brightness Setting

If the contrast / brightness setting is such that it is no longer possible to read the masks, you can use the user mode switch to reset the contrast / brightness to the default value.



For the table with the switch positions of the user mode switch, see chapter „User Mode Switch“.



The switch position for the default contrast / brightness is identical with the „Activate download via hardware“. The contrast / brightness is reset before a corresponding message is displayed. The warning will be displayed in a legible manner.

To restore the default contrast / brightness:

1. Switch the device off.
2. Set the switches S1 and S4 of the user mode switch to ON.
3. Switch the device on again.
4. When the warning appears, switch the device off again.
5. Set switch S4 to OFF.
6. Then switch the device on again.

The application will not be lost.

3.3.3 Character Attributes

The following character attributes can be displayed on the device:

- Normal
- Underlined
- Foreground / background color

3.3.4 Fonts

You are able to use the Windows character sets. Further you can use the font "Normal" and the font "Zoom" or create and use your own character sets.

4 Interfaces of the Device

The device can either be supplied as a standard device or field bus device.

The universal interface X3 combines several interface standards in one connector. The connector is divided into two channels. The communication channel (SER1) is operated separately from the channel for the upload/download/logging printer/scanner (SER2).

For the communication channel (SER1), the protocol-specific use only allows one of the three interface standards to be used.

Depending on the device variant, several interfaces are available to you:

Table 4-1 Device variants

Order number	Available interfaces							
	RS232c (X3-SER2)	TTY / 20mA, RS485, RS232c (X3-SER1)	CAN	DeviceNet	INTERBUS	INTERBUS OPC LWL	MPI	PROFIBUS-DP
BTxxEx/23xxxx	X	X	-	-	-	-	-	-
BTxxEx/25xxxx	X	-	X	-	-	-	-	-
BTxxEx/39xxxx	X	-	-	X	-	-	-	-
BTxxEx/21xxxx	X	-	-	-	X	-	-	-
BTxxEx/26xxxx	X	-	-	-	-	X	-	-
BTxxEx/24xxxx	X	-	-	-	-	-	X	-
BTxxEx/22xxxx	X	-	-	-	-	-	-	X

4.1 Standard Interfaces

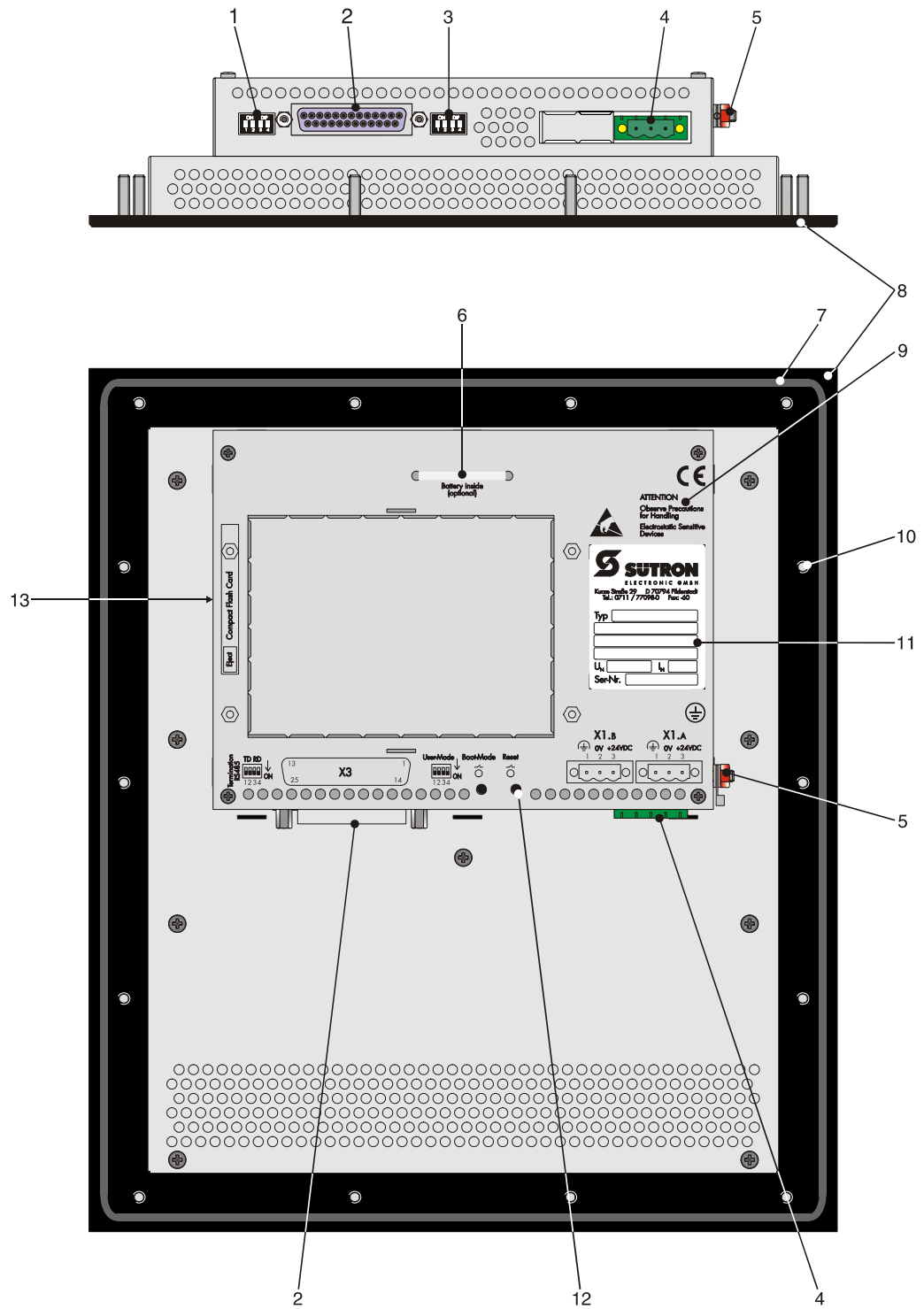

Figure 4-1 Rear view TTY / RS485 / RS232c

- 1 Termination Switch (X3-SER1 RS485)
- 2 Female Connector X3 (TTY/RS485/RS232c)
- 3 User Mode Switch
- 4 Connector X1.A (Supply Voltage)
- 5 Threaded Bolt for Protective Grounding
- 6 Cable Fastener for Battery
- 7 Seal
- 8 Front Panel
- 9 Warning
- 10 Mounting Bolt
- 11 Nameplate
- 12 Reset Key
- 13 CompactFlash, Inserted on the Side

4.1.1 TTY / 20 mA Current Loop (X3-SER1)

Depending on the wiring, it is possible to connect the interface either as an active or passive current loop. The transmit line and the receive line are each provided with a separate 20 mA power source. The compliance voltage is approx. 24 VDC.

The 20 mA power should be supplied by the transmitter unit. This decreases crosstalk on the signal lines considerably.

In idle state (signal logic 1), a 20 mA current loop can be measured in the cable.

- Signal Logic 1 Current Flow 20 mA
- Signal Logic 0 Current Flow Interrupted

4.1.1.1 Pin Assignment

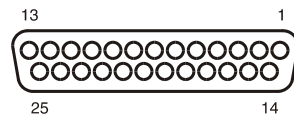

Figure 4-2 25 pin D-SUB female connector strip

Connector in the terminal: 25 pin D-SUB female connector strip.

Table 4-2 Pin assignment TTY / 20 mA, passive

Pin	Designation	Function
10	T+	Transmitted Data, Positive Polarity
13	R+	Received Data, Positive Polarity
14	R-	Received Data, Negative Polarity
19	T-	Transmitted Data, Negative Polarity

Table 4-3 Pin assignment TTY / 20 mA, active

Pin	Designation	Function
10	T+	Transmitted Data, Positive Polarity
12	S1+	Power Source 1, Positive Polarity
13	R+	Received Data, Positive Polarity
14	R-	Received Data, Negative Polarity
16	S2+	Power Source 2, Positive Polarity
19	T-	Transmitted Data, Negative Polarity
21	S1-	Current Sink 1, Negative Polarity
24	S2-	Current Sink 2, Negative Polarity



The D-SUB connector strips must be shielded sufficiently.
See chapter "Shielding D-SUB Connectors" on page 4-28.

4.1.1.2 Termination



For the operation of channel SER1 as a current loop, the termination for the RS485 must be deactivated.

4.1.2 RS485 (X3-SER1)

The interface is suitable for point-to-point and for multi-point connections.

The wires belonging together are marked with „A“ and „B“. Some descriptions refer to the pins with „+“ and „-“, where A = + and B = -.

Signal Logic 1 $U_A - U_B \leq -0.3 \text{ V}$ i.e. ($U_A < U_B$)

Signal Logic 0 $U_A - U_B \geq +0.3 \text{ V}$ i.e. ($U_A > U_B$)

4.1.2.1 Pin Assignment

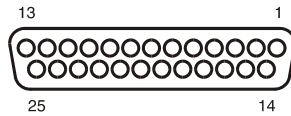

Figure 4-3 25 pin D-SUB female connector strip

Connector in the operating device: 25 pin D-SUB female connector strip.

Table 4-4 Pin assignment RS485

Pin	Designation	Function
8	T(A)	Transmitted Data (-)
9	T(B)	Transmitted Data (+)
11	SGND	Signal Ground
22	R(A)	Received Data (-)
23	R(B)	Received Data (+)



The D-SUB connector strips must be shielded sufficiently. See chapter “Shielding D-SUB Connectors“ on page 4-28.

4.1.2.2 Termination

For point-to-point connections, always activate the termination. For multi-point connections, only activate the termination at the cable end.

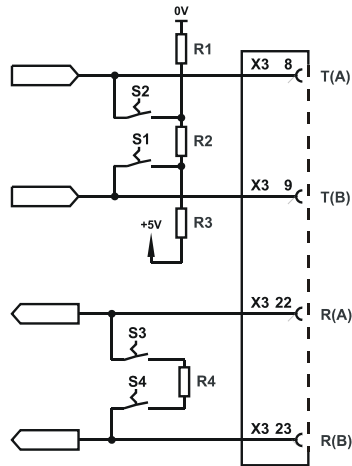

Figure 4-4 Block diagram termination RS485

Table 4-5 Resistance values termination RS485

Designation	Value
R1, R3	510 Ohm
R2	150 Ohm
R4	120 Ohm



The switch positions for ON or OFF are printed onto the termination switch. Only the specified switch positions are permitted.

Table 4-6 Termination switch

S1	S2	S3	S4	Function
Transmitter		Receiver		
				Termination is ON
-	-	-	-	Termination is OFF

Legend for table:

| = Switch ON

- = Switch OFF

4.1.3 RS232c (X3-SER1)

The interface is suitable to establish a point-to-point connection.

4.1.3.1 Pin Assignment

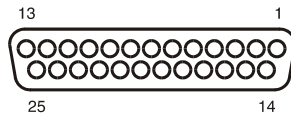

Figure 4-5 25 pin D-SUB female connector strip

Connector in the operating device: 25 pin D-SUB female connector strip.

Table 4-7 Pin assignment RS232c

Pin	Designation	Function
6	TD	Transmitted Data
15	CTS	Clear to Send
17	RTS	Request to Send
18	RD	Received Data
25	SGND	Signal Ground



The D-SUB connector strips must be shielded sufficiently. See chapter "Shielding D-SUB Connectors" on page 4-28.

4.1.3.2 Termination



For the operation of channel SER1 as a RS232, the termination for the RS485 must be OFF.

4.1.4 RS232c (X3-SER2)

The interface is only designed to be used for downloads, uploads, a scanner or a logging printer because the interface is not electrically isolated.

4.1.4.1 Pin Assignment

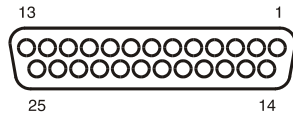

Figure 4-6 25 pin D-SUB female connector strip

Connector in the operating device: 25 pin D-SUB female connector strip.

Table 4-8 Pin assignment RS232c

Pin	Designation	Function
1	(\perp)	Low-Noise Ground
2	TD	Transmitted Data
3	RD	Received Data
4	RTS	Request to Send
5	CTS	Clear to Send
7	SGND	Signal Ground
20	DTR	Data Transfer Request



The D-SUB connector strips must be shielded sufficiently. See chapter "Shielding D-SUB Connectors" on page 4-28.

4.2 Field Bus Interfaces

4.2.1 CAN (X2.1/X2.2)

The opto-decoupled interfaces for CAN bus connections are available to integrate the device into a CAN structure. The CAN bus is designed as a high speed bus in accordance with ISO-DIS 11898.

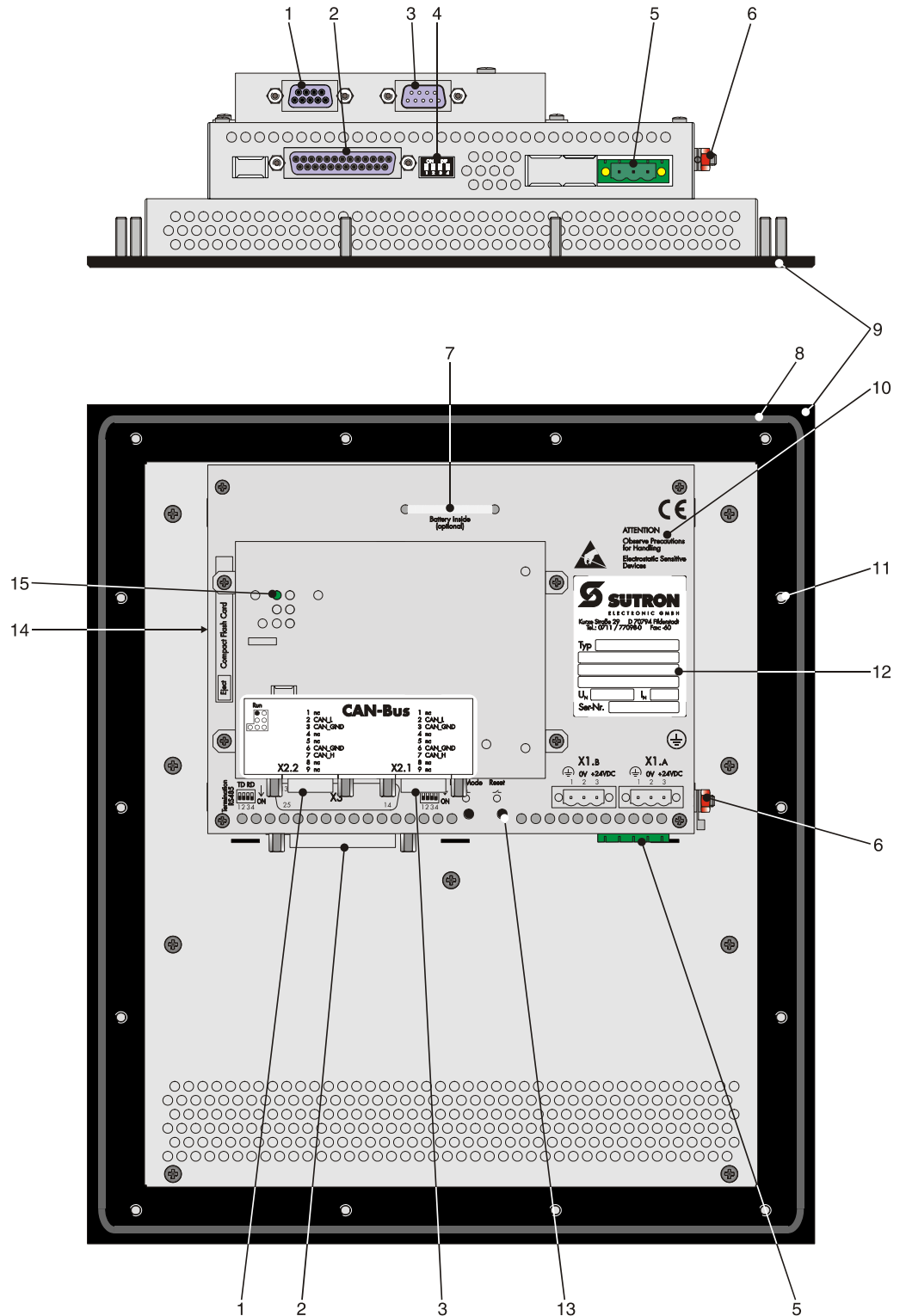

Figure 4-7 Rear view CAN

- 1 Female Connector X2.2 (CAN)
- 2 Female Connector X3 (SER2 RS232c)
- 3 Male Connector X2.1 (CAN)
- 4 User Mode Switch
- 5 Connector X1.A (Supply Voltage)
- 6 Threaded Bolt for Protective Grounding
- 7 Cable Fastener for Battery
- 8 Seal
- 9 Front Panel
- 10 Warning
- 11 Mounting Bolt
- 12 Nameplate
- 13 Reset Key
- 14 CompactFlash, Inserted on the Side
- 15 Diagnostics LED

4.2.1.1 Pin Assignment

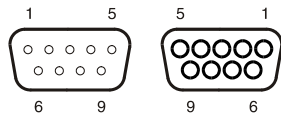

Figure 4-8 9 pin D-SUB male connector strip and female connector strip

Connector in the terminal: 9 pin D-SUB male and female connector strip (assignment for male and female connector strip is the same.)

Table 4-9 Pin assignment CAN bus

Pin	Designation	Function
1	nc	Not Connected
2	CAN_L	CAN_L Bus Line (Dominant LOW)
3	CAN_GND	CAN Ground
4	nc	Not Connected
5	nc	Not Connected
6	CAN_GND	CAN Ground
7	CAN_H	CAN_H Bus Line (Dominant HIGH)
8	nc	Not Connected
9	nc	Not Connected

All signal lines are looped through from X2.1 to X2.2. The connecting cables should be connected to every pin, including the reserved pins. In this way, the cables can still be used in case of future bus specification extensions.



The D-SUB connector strips must be shielded sufficiently. See chapter “Shielding D-SUB Connectors” on page 4-28.

4.2.1.2 Cable



A shielded twisted-pair cable (cable type LiYCY-TP) complying with ISO 11898 must be used.

The cable must have the following characteristics:

Table 4-10 Cable characteristics CAN

Parameters	Value
Impedance	Min.: 108 Ohm Nom.: 120 Ohm Max.: 132 Ohm
Specific resistance	70 mOhm/m
Specific line delay	5 ns/m

The maximum cable length depends on the baud rate used.

Table 4-11 Baud rate CAN

Baud rate	Cable length
20 kBit/s	1000 m
125 kBit/s	500 m
250 kBit/s	250 m
500 kBit/s	100 m
1000 kBit/s	25 m

4.2.1.3 Termination

Terminate the CAN bus at both ends by terminating resistors (120 Ohm).

4.2.1.4 Diagnostic

A diagnostics LED is located at the rear of the operating device. The LED shows a state of the bus system.



Figure 4-9 Arrangement of the CAN diagnostics LED

The diagnostics LED at the operating device has the following functions:

Table 4-12 Function of the CAN diagnostics LED

Color	State	Function
Green	Off	Terminal Disconnected from Bus
Green	On	Communication Active
Green	Flashing	Sporadic Bus Error

4.2.2 DeviceNet (X2.1/X2.2)

The opto-decoupled interfaces are available to integrate the device into a CAN structure. The CAN bus is designed as a high speed bus in accordance with ISO-DIS 11898.

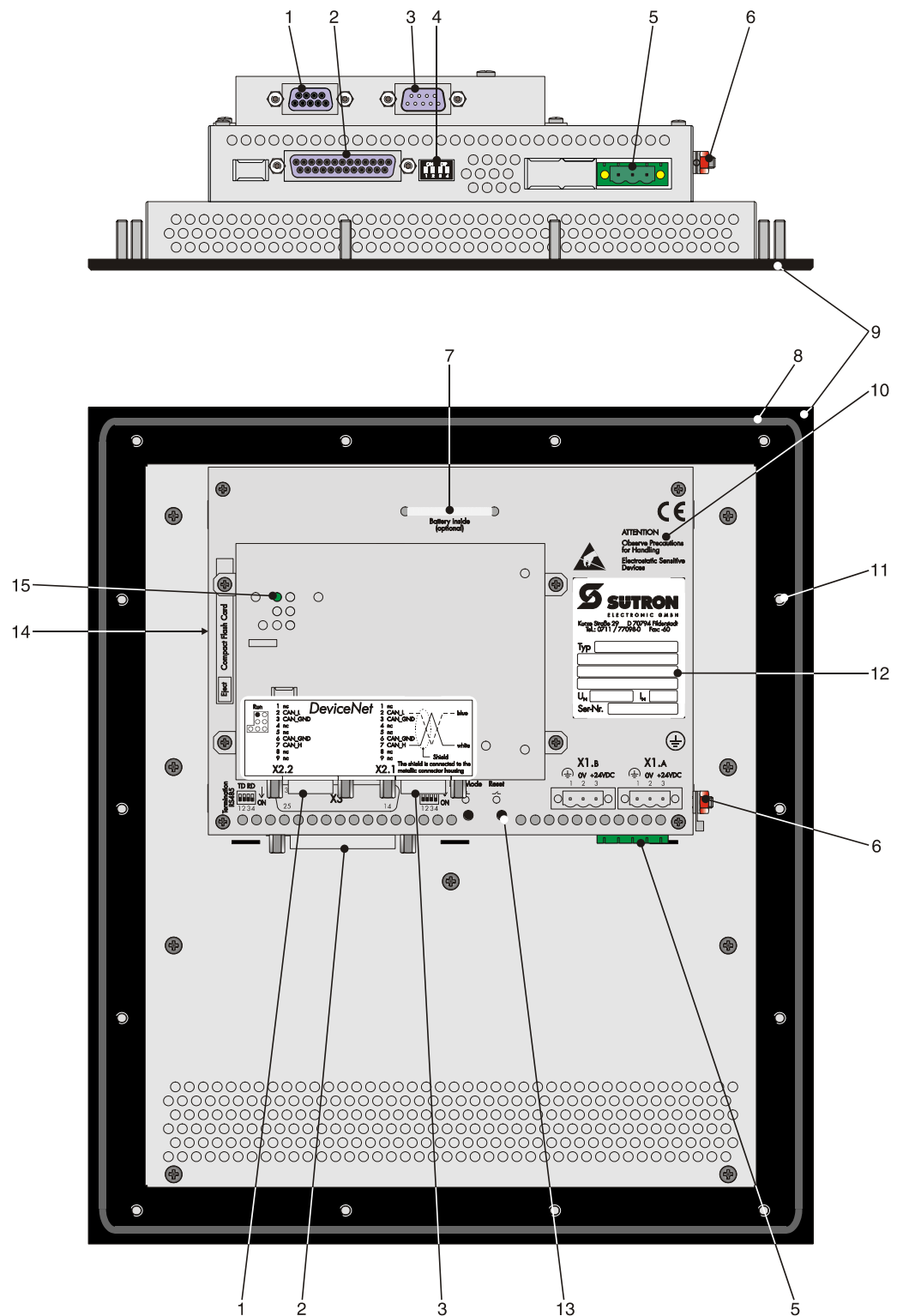

Figure 4-10 Rear view DeviceNet

- 1 Female Connector X2.2 (DeviceNet)
- 2 Female Connector X3 (SER2 RS232c)
- 3 Male Connector X2.1 (DeviceNet)
- 4 User Mode Switch
- 5 Connector X1.A (Supply Voltage)
- 6 Threaded Bolt for Protective Grounding
- 7 Cable Fastener for Battery
- 8 Seal
- 9 Front Panel
- 10 Warning
- 11 Mounting Bolt
- 12 Nameplate
- 13 Reset Key
- 14 CompactFlash, Inserted on the Side
- 15 Diagnostics LED

4.2.2.1 Pin Assignment

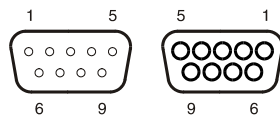

Figure 4-11 9 pin D-SUB male connector strip and female connector strip

Connector in the terminal: 9 pin D-SUB male and female connector strip (assignment for male and female connector strip is the same.)

Table 4-13 Pin assignment CAN bus

Pin	Designation	Function
1	nc	Not Connected
2	CAN_L	CAN_L Bus Line (Dominant LOW)
3	CAN_GND	CAN Ground
4	nc	Not Connected
5	nc	Not Connected
6	CAN_GND	CAN Ground
7	CAN_H	CAN_H Bus Line (Dominant HIGH)
8	nc	Not Connected
9	nc	Not Connected

All signal lines are looped through from X2.1 to X2.2. The connecting cables should be connected to every pin, including the reserved pins. In this way, the cables can still be used in case of future bus specification extensions.



The D-SUB connector strips must be shielded sufficiently. See chapter “Shielding D-SUB Connectors” on page 4-28.

4.2.2.2 Cable



A DeviceNet-certified cable must be used.

Table 4-14 Data line DeviceNet

Cable type	Loop resistance	Surge impedance	Capacitance per unit length
2 x 1.1 mm	< 22.6 Ohm/km	120 Ohm	< 39.4 pf/m
2 x 0.6 mm	< 91.8 Ohm/km	120 Ohm	< 39.4 pf/m

The maximum length allowed for spur lines connected to the bus cable is 6 meters. The overall length of the bus cable including all spur lines is not to exceed the maximum length listed in the table below.

The maximum cable length depends on the baud rate and the cable type used.

Table 4-15 Baud rate DeviceNet

Baud rate	Cable type	Cable length
125 kBit/s	2 x 1.1 mm	500 m
	2 x 0.6 mm	100 m
250 kBit/s	2 x 1.1 mm	250 m
	2 x 0.6 mm	100 m
500 kBit/s	2 x 1.1 mm	100 m
	2 x 0.6 mm	100 m

4.2.2.3 Termination

Terminate the CAN bus at both ends by terminating resistors (120 Ohm).

4.2.2.4 Diagnostic

A diagnostics LED is located at the rear of the operating device. The LED shows the states of the bus system.



Figure 4-12 Arrangement of the DeviceNet diagnostics LED

The diagnostics LED at the operating device has the following functions:

Table 4-16 Function of the CAN diagnostics LED

Color	State	Function
Green	Off	Terminal Disconnected from Bus
Green	On	Communication Active
Green	Flashing	Sporadic Bus Error

4.2.3 INTERBUS (X2.1/X2.2)

The device can be integrated into the INTERBUS using the interfaces available for INTERBUS connections.

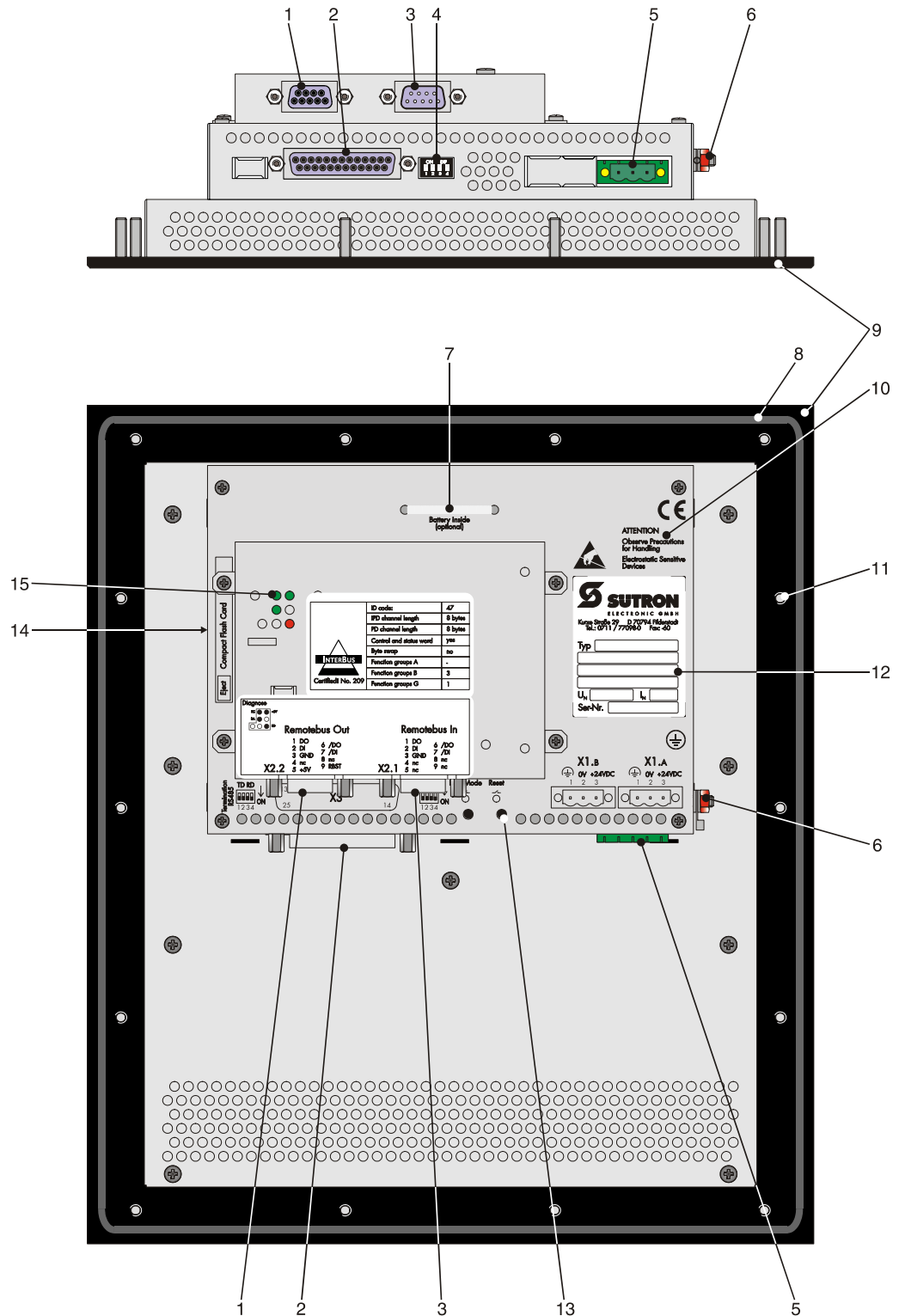

Figure 4-13 Rear view INTERBUS

- 1 Female Connector X2.2 (Remote Bus Out)
- 2 Female Connector X3 (SER2 RS232c)
- 3 Male Connector X2.1 (Remote Bus In)
- 4 User Mode Switch
- 5 Connector X1.A (Supply Voltage)
- 6 Threaded Bolt for Protective Grounding
- 7 Cable Fastener for Battery
- 8 Seal
- 9 Front Panel
- 10 Warning
- 11 Mounting Bolt
- 12 Nameplate
- 13 Reset Key
- 14 CompactFlash, Inserted on the Side
- 15 Diagnostics LEDs

4.2.3.1 Pin Assignment

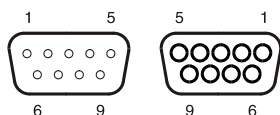

Figure 4-14 9 pin D-SUB male connector strip and female connector strip

Connector in the terminal: 9 pin D-SUB male connector strip for remote bus in.

Table 4-17 Pin assignment remote bus in (INTERBUS)

Pin	Designation	Function
1	DO	Data Output
2	DI	Data Input
3	GND	Ground
4	nc	Not Connected
5	nc	Not Connected
6	/DO	Data Output, Inverted
7	/DI	Data Input, Inverted
8	nc	Not Connected
9	nc	Not Connected

Connector in the terminal: 9 pin D-SUB female connector strip for remote bus out.

Table 4-18 Pin assignment remote bus out (INTERBUS)

Pin	Designation	Function
1	DO	Data Output
2	DI	Data Input
3	GND	Ground
4	nc	Not Connected

Table 4-18 Pin assignment remote bus out (INTERBUS)

Pin	Designation	Function
5	+5 V	Power Supply +5 VDC
6	/DO	Data Output, Inverted
7	/DI	Data Input, Inverted
8	nc	Not Connected
9	RBST	Remote Bus Status



The D-SUB connector strips must be shielded sufficiently. See chapter "Shielding D-SUB Connectors" on page 4-28.

4.2.3.2 Cable



A shielded twisted-pair cable (cable type LiYCY-TP) must be used. The maximum cable length depends on its use within the INTERBUS topology.

4.2.3.3 Diagnostic

The diagnostics LEDs are located at the rear of the operating device. The LEDs show the states of the bus system.

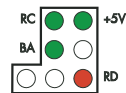

Figure 4-15 Arrangement of the INTERBUS diagnostics LEDs

The diagnostics LEDs at the operating device has the following functions:

Table 4-19 Functions of the INTERBUS diagnostics LEDs

Designation	Color	State	Function
RC	Green	On	Remote Bus Check
+5 V	Green	On	Supply Voltage OK
		Off	No Supply Voltage
BA	Green	On	Bus Active
		Off	Bus Not Active
RD	Red	On	Remote Bus Inactive

4.2.4 INTERBUS OPC LWL (DO1/DI1/DO2/DI2)

The device can be integrated into an INTERBUS device bus using the interfaces available for INTERBUS OPC LWL connection.

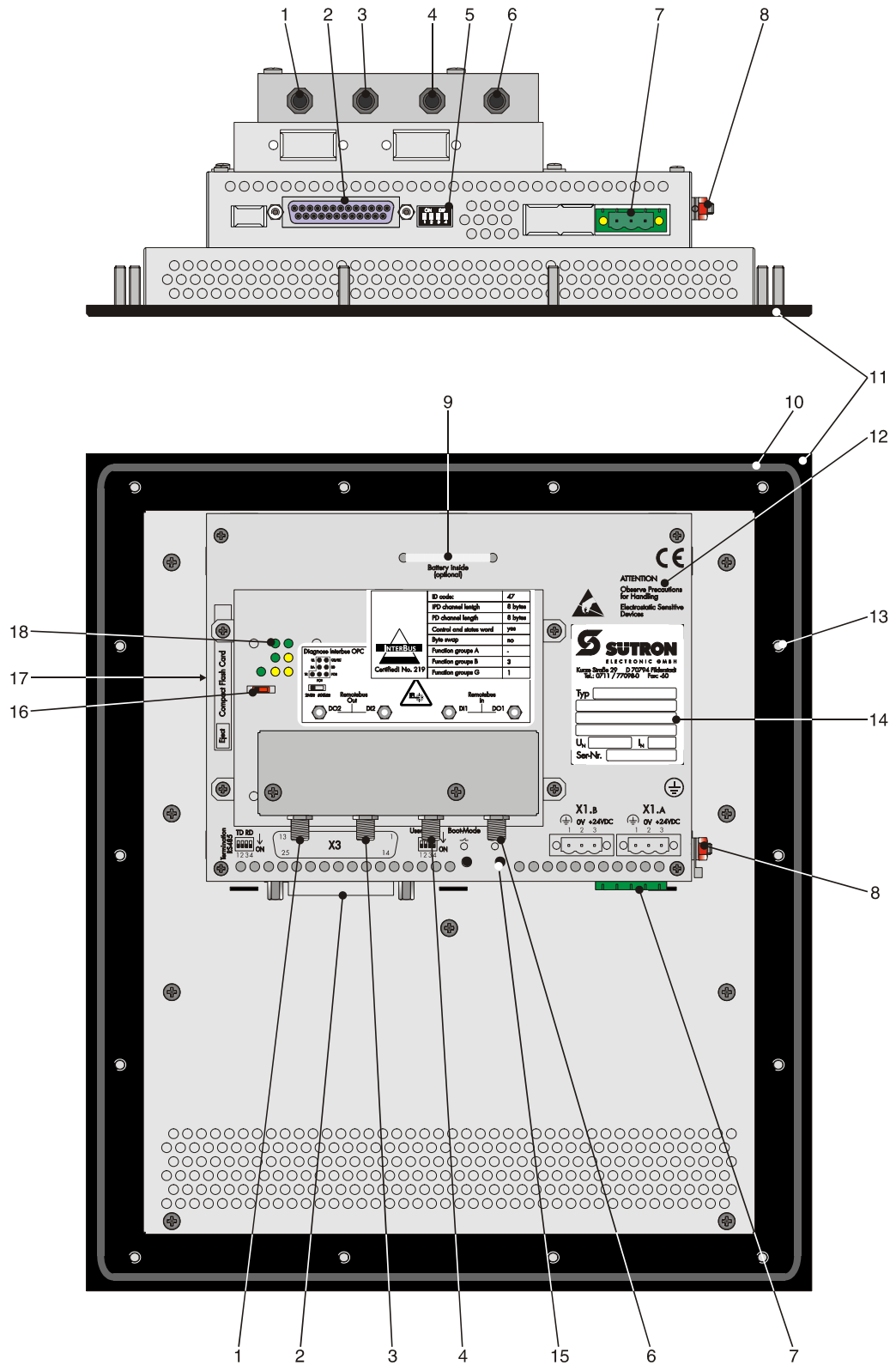

Figure 4-16 Rear view INTERBUS OPC LWL

- 1 Optical Fibre Interface DO2 (Remote Bus Out)
- 2 Female Connector X3 (SER2 RS232c)
- 3 Optical Fibre Interface DI2 (Remote Bus Out)
- 4 Optical Fibre Interface DI1 (Remote Bus In)
- 5 User Mode Switch
- 6 Optical Fibre Interface DO1 (Remote Bus In)
- 7 Connector X1.A (Supply Voltage)
- 8 Threaded Bolt for Protective Grounding
- 9 Cable Fastener for Battery
- 10 Seal
- 11 Front Panel
- 12 Warning
- 13 Mounting Bolt
- 14 Nameplate
- 15 Reset Key
- 16 Baud Rate Switch
- 17 CompactFlash, Inserted on the Side
- 18 Diagnostics LEDs



Never look directly into the open end of an optical fiber cable. **Infrared light can cause damage to the retina of the eye.** Fit the open ends of an optical fiber cable and the connections with protective caps. Wear protective goggles.



The sending and receiving units can be rendered unusable by dirt accumulation. For this reason, place protective caps onto the connections when the units are not used or are transported! Wear protective goggles.

4.2.4.1 Connector Pin Assignment

The optical fiber interface is designed as a FSMA type 905.

Table 4-20 Assignment INTERBUS OPC LWL

Designation	Function
DO1	Remote Bus In
DI1	Remote Bus In
DO2	Remote Bus Out
DI2	Remote Bus Out

4.2.4.2 Cable

The cables are connected in accordance with the "INTERBUS Fiber Optic Installation Guidelines".

Suitable for optical transmission is a dielectric waveguide with step index refractive index profile - a polymer fiber with a core diameter of 980 µm and a cladding diameter of 1000 µm. The F-SMA connector is specified in IEC 874-2 or in DIN 47258, respectively.

The maximum distance between two remote bus users is 50 m (164.042 ft.).

4.2.4.3 Diagnostic

The diagnostics LEDs are located at the rear of the operating device. The LEDs show the states of the bus system.

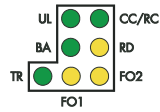

Figure 4-17 Arrangement of the INTERBUS OPC LWL diagnostics LEDs

The diagnostics LEDs at the operating device has the following functions:

Table 4-21 Functions of the INTERBUS OPC LWL diagnostics LEDs

Designation	Color	State	Function
UL	Green	On	Supply Voltage OK
		Off	No Supply Voltage
CC/RC	Green	On	Remote Bus Cable Check
BA	Green	On	Bus Active
		Off	Bus Not Active
RD	Yellow	On	Remote Bus Inactive
TR	Green	On	PCP Active
		Off	PCP Not Active
FO1	Yellow	On	Incoming Optical Fiber Path Not OK
		Off	Incoming Optical Fiber Path OK
FO2	Yellow	On	Outgoing Optical Fiber Path Not OK
		Off	Outgoing Optical Fiber Path OK

4.2.5 MPI (X2)

The device can be integrated into a Siemens MPI bus structure using the interface available for Siemens MPI connections.

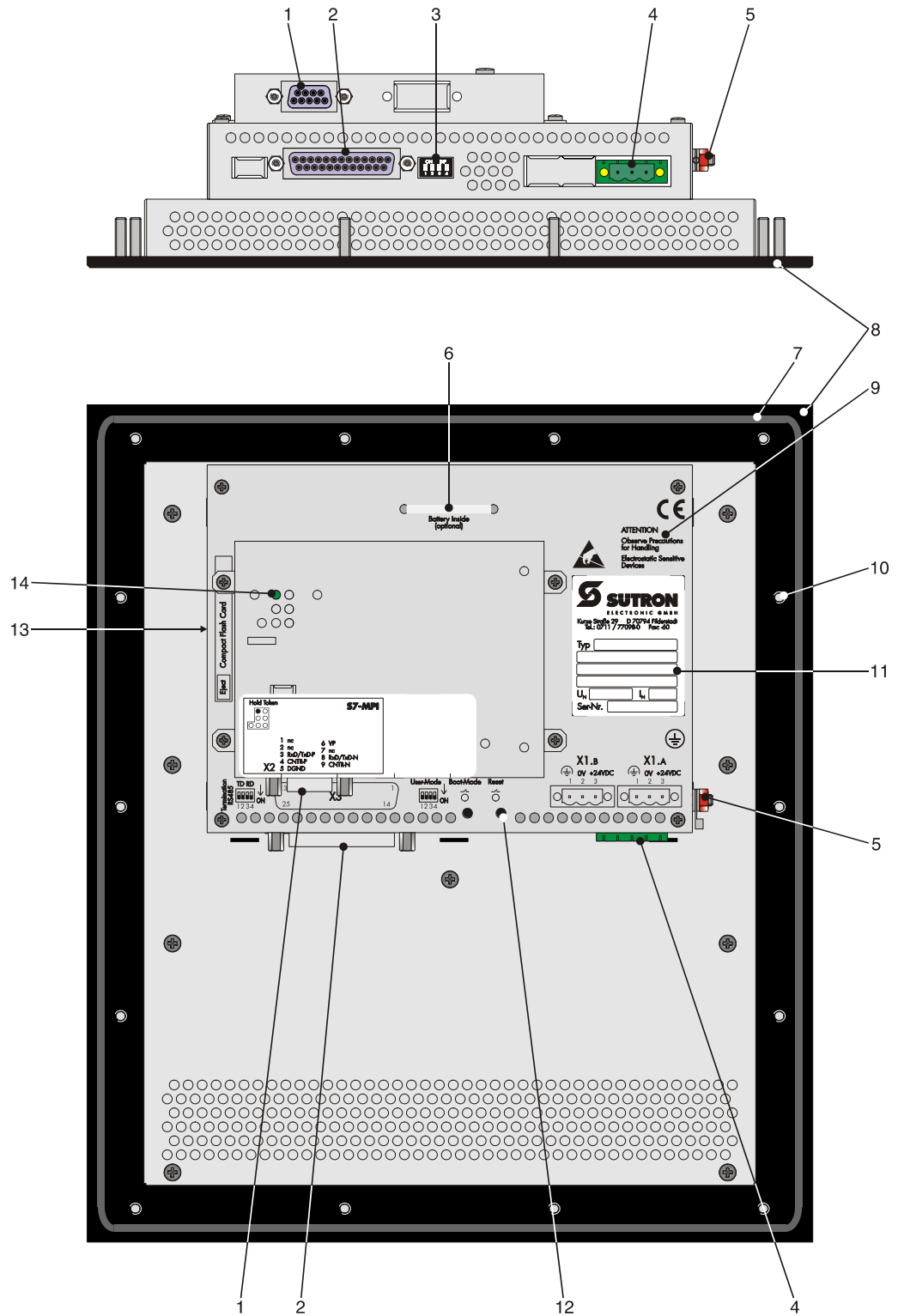

Figure 4-18 Rear View MPI

- 1 Female Connector X2 (MPI)
- 2 Female Connector X3 (SER2 RS232c)
- 3 User Mode Switch
- 4 Connector X1.A (Supply Voltage)
- 5 Threaded Bolt for Protective Grounding
- 6 Cable Fastener for Battery
- 7 Seal
- 8 Front Panel
- 9 Warning
- 10 Mounting Bolt
- 11 Nameplate
- 12 Reset Key
- 13 CompactFlash, Inserted on the Side
- 14 Diagnostics LED

4.2.5.1 Pin Assignment

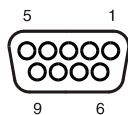

Figure 4-19 9 pin D-SUB female connector strip

Connector in the terminal: 9 pin D-SUB female connector

Table 4-22 Pin assignment MPI

Pin	Designation	Function
1	nc	Not Connected
2	nc	Not Connected
3	RxD/TxD-P	Received Data / Transmitted Data Plus
4	CNTR-P	Repeater Control Signal Plus
5	DGND	Data Transmission Potential
6	VP	Supply Voltage of Terminators Plus
7	nc	Not Connected
8	RxD/TxD-N	Received Data / Transmitted Data Minus
9	CNTR-N	Repeater Control Signal Minus



The D-SUB connector strips must be shielded sufficiently. See chapter "Shielding D-SUB Connectors" on page 4-28.

4.2.5.2 Cable



Any cable that conforms with the following parameters can be used:

Loop resistance	110 Ohm/km
Capacitance	30 nF/km
Surge impedance	150 Ohm

The maximum length of one segment is 50 m which cannot be exceeded. This 50 m applies from the first node to the last node in the segment. For further information on the installation, please refer to the Siemens manual "SIMATIC S7-400 and M7-400 Programmable Controllers Hardware and Installation, 6ES7498-8AA03-8BA0".

4.2.5.3 Termination

The bus line is terminated at the connector. For point-to-point connections, always activate the termination. For multi-point connections, only activate the termination at the cable end. For spur lines, always deactivate the termination.

4.2.5.4 Diagnostic

A diagnostics LED is located at the rear of the operating device. The LED shows a state of the bus system.



Figure 4-20 Arrangement of the MPI diagnostics LED

The diagnostics LED at the operating device has the following function:

Table 4-23 Function of the MPI diagnostics LED

Color	State	Function
Green	Flashing	Operating Device has the Token

4.2.6 PROFIBUS-DP (X2)

The interface for PROFIBUS-DP connections is available to integrate the device into a PROFIBUS-DP structure.

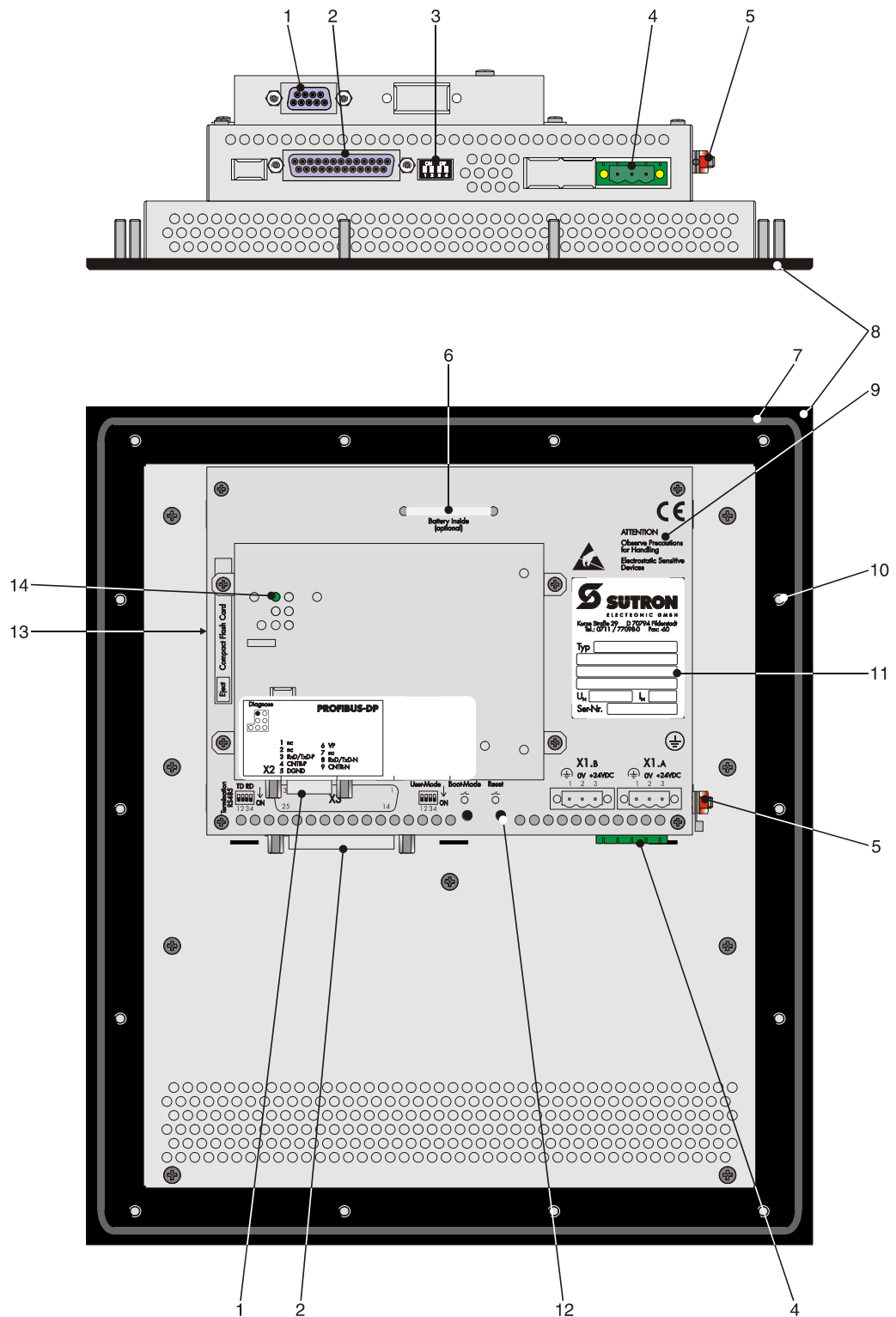

Figure 4-21 Rear view PROFIBUS-DP

- 1 Female Connector X2 (PROFIBUS-DP)
- 2 Female Connector X3 (SER2 RS232c)
- 3 User Mode Switch
- 4 Connector X1.A (Supply Voltage)
- 5 Threaded Bolt for Protective Grounding
- 6 Cable Fastener for Battery
- 7 Seal
- 8 Front Panel
- 9 Warning
- 10 Mounting Bolt
- 11 Nameplate
- 12 Reset Key
- 13 CompactFlash, Inserted on the Side
- 14 Diagnostics LED

4.2.6.1 Pin Assignment

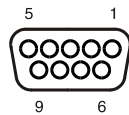

Figure 4-22 9 pin D-SUB female connector strip

Connector in the operating device: 9 pin D-SUB female connector.

Table 4-24 Pin assignment PROFIBUS-DP

Pin	Designation	Function
1	nc	Not Connected
2	nc	Not Connected
3	RxD/TxD-P	Received Data / Transmitted Data Plus
4	CNTR-P	Repeater Control Signal Plus
5	DGND	Data Transmission Potential
6	VP	Supply Voltage of Terminators Plus
7	nc	Not Connected
8	RxD/TxD-N	Received Data / Transmitted Data Minus
9	CNTR-N	Repeater Control Signal Minus



The D-SUB connector strips must be shielded sufficiently. See chapter "Shielding D-SUB Connectors" on page 4-28.

4.2.6.2 Cable



Any PROFIBUS-DP-approved cables specified in the EN 50170 as cable type A can be used.

Impedance	136 to 165 Ohm
Capacitance	< 30 pf/m
Loop resistance	110 Ohm/km
Wire gauge	0.64 mm

The maximum cable length depends on the baud rate (DIN EN 19245 Part 3).

Table 4-25 Baud rate PROFIBUS-DP

Baud Rate	Cable Length
187.5 kBit/s	1000 m
500 kBit/s	400 m
1500 kBit/s	200 m
3000 to 12000 kBit/s	100 m

4.2.6.3 Diagnostic

A diagnostics LED is located on the rear of the operating device. The LED shows a state of the bus system.



Figure 4-23 Arrangement of the PROFIBUS-DP diagnostics LED

The diagnostics LED on the operating device has the following function:

Table 4-26 Function of the PROFIBUS-DP diagnostics LED

Color	State	Function
Green	On	Communication Active

4.3 Memory Card

You can insert a CompactFlash card on the side of your operating device. The CompactFlash card allows you to exchange projects between the PC and the operating device.

You can recognize the rear side of a CompactFlash card by the notches on each side of the card.

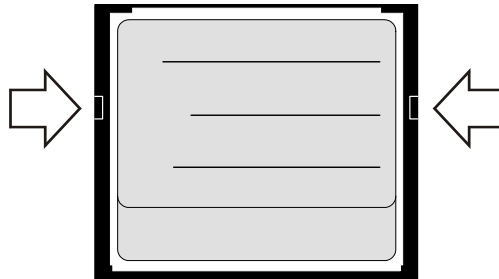

Figure 4-24 Rear view of the memory card

4.3.1 Inserting the Memory Card

When you insert the card from the rear of the operating device, make sure the front side of the card is visible. Insert the card until it snaps into place.

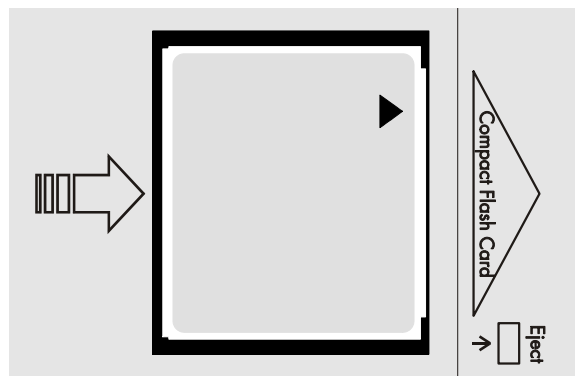

Figure 4-25 Inserting the memory card

4.3.2 Ejecting the Memory Card

To remove the card, press the ejection button on the operating device.

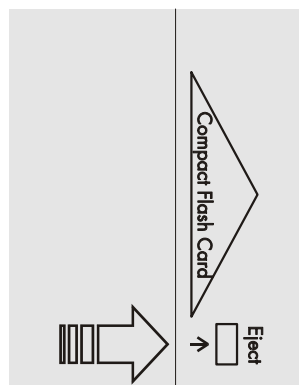

Figure 4-26 Ejecting the memory card

4.4 Shielding D-SUB Connectors

You must shield D-SUB connectors as follows:

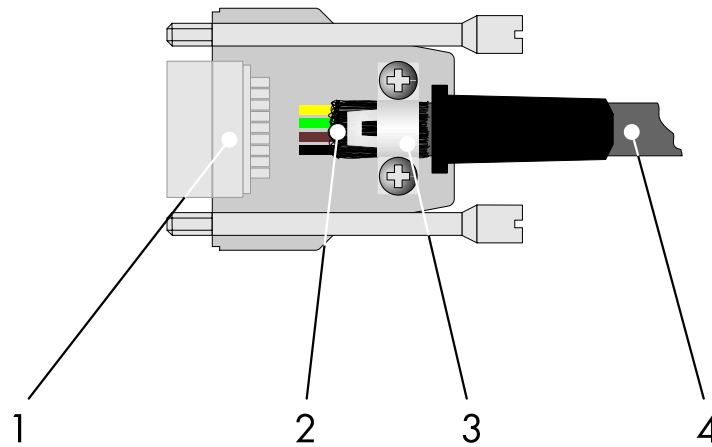

Figure 4-27 Shielding D-SUB connectors

- 1 D-SUB connector
- 2 Shield
- 3 Cable clip
- 4 Cable

The shield must be folded back into a flat position over the cable sheath.

When fastening the cable with the cable clip, as much of the shielding as possible must be in contact with the housing and sufficient strain relieve must be ensured.

5 Maintenance and Servicing

5.1 Maintenance Interval

The following maintenance intervals are recommended for this operating device:

Table 5-1

Maintenance work	Interval
Changing the Battery	4 Years

5.2 Front Panel

You should use a damp cloth only to remove any dirt from the panel.

5.3 Fuse



The semiconductor fuse cannot be replaced!

A semiconductor fuse is used to protect the device. Once the fuse has been tripped, the device must be disconnected from the supply voltage to allow the semiconductor fuse to regenerate. At an ambient temperature of 20 °C (68 °F), the regeneration takes approximately 20 seconds. The higher the ambient temperature, the longer the regeneration takes.

5.4 Battery

The built-in battery preserves the data in the CMOS-RAM and supplies the real-time clock. The minimum battery life is 5 years, even under unfavorable operating conditions. When the battery runs down, the message „Change battery“ is generated automatically.

We recommend you change the battery approximately every 4 years as part of the regular maintenance work. A prepared battery including connector can be obtained directly from Sutron electronic.

If the „Change battery“ message is detected too late, e.g. the real-time clock stopped or shows the wrong date, data in the CMOS-RAM may have already been lost. For this reason, after changing a battery, always check data such as passwords that can be modified, parameters in the system variables, recipe data sets and entries in the message system.

5.4.1 Changing the Battery



Batteries must only be changed by authorized and trained experts!



For changing the battery you may only use replacement batteries of Sutron electronic.



Electrostatic discharge can damage electronic components! **Observe the ESD protective measures!**



Do not throw lithium batteries into fire, do not heat to 100 °C or higher and do not recharge. **Danger - Explosive!**



Do not open lithium batteries. **Danger - Toxic!**

To ensure that the data in the CMOS-RAM and the time are preserved, it is possible to change the battery under operating voltage. Observe the safety notes!

1. Remove the threaded bolts of the interfaces (see figure).
2. Remove the screws (see figure) on the rear panel of the device and lift off the enclosure.
3. Remove the cable fastener securing the battery.
4. Disconnect the connector from the battery and remove the dead battery.
5. Plug in the connector of the new battery.
6. Use a cable fastener to attach the new battery to the enclosure.
7. Place the rear panel back onto the device.
8. Carefully tighten the screws of the rear panel and then the threaded bolts of the interfaces.

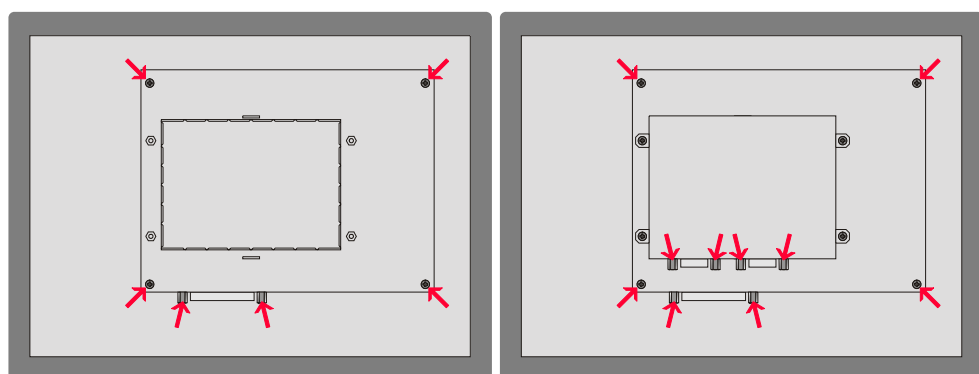

Figure 5-1 Screws at the standard device (left) / field bus device (right)

5.4.2 Battery Disposal



To prevent short circuitry in the collection boxes, insulate the poles of each battery with insulation tape or put each single battery into a plastic bag.

You must always return old batteries to a dealer or to a returns depot set up for this purpose by the public waste disposal body or a licensed battery dealer for recycling. Only dispose of dead batteries in public or commercial collection boxes. The battery is drained when the message „Change battery“ appears on the display of the device.

6 Technical Data

Keyboard	
Type	Short-stroke Keyboard
Number of Keys	54
Actuator Travel	0.5 mm (0.02")
Activation Power	2 - 3 N
Switching Cycles	Approx. 1 Million

Display			
Type	STN (Monochrome)	STN (Color)	TFT (Color)
Resolution	320 x 240 Pixels	320 x 240 Pixels	320 x 240 Pixels
Colors	15 Gray Scales	16	16
Reading Angle	90°	90°	90°
Default Contrast / Brightness Setting	By User Mode Switch	By User Mode Switch	By User Mode Switch
Contrast Setting	Temperature Compensation	Temperature Compensation	Temperature Compensation
LCD Lifetime	100.000 h	100.000 h	100.000 h
Half-Life Backlighting	50.000 h	40.000 h	50.000 h
Lines	20	20	20
Characters/Line	40	40	40
Display Area (H x W)	90 mm x 120 mm (3.543" x 4.724")	90 mm x 120 mm (3.543" x 4.724")	90 mm x 120 mm (3.543" x 4.724")

Electrical Data	
Supply Voltage	24 V DC (SELV in Accordance with DIN EN 61131)
Residual Ripple	10% Maximum
Minimum Voltage	19.2 V
Maximum Voltage	30.2 V
Power Consumption (Field Bus Device)	STN-Display: 0.4 A TFT-Display: 0.5 A
Connected Load	STN-Display: 10 W TFT-Display: 12 W
Fuse	Semiconductor Fuse, Self-resetting
Protection Against Polarity Reversal	Integrated

Standard Interfaces	
Variable Baud Rates and Data Formats	
X3 SER1 TTY / 20 mA	According to CL 2 and DIN 66 348 T1 Transmission Length: 0 - 1000 m (3280.84 ft.), Twisted Pair, Shielded Electrically Isolated
X3 SER1 RS485	According to DIN 66259-4 Transmission Length: 0 - 1200 m (3937.01 ft.), Twisted Pair, Shielded Electrically Isolated
X3 SER1 RS232c / X3 SER2 RS232c	According to DIN 66259 T1, CCITT V.28 Transmission Length: 0 - 15 m (49.21 ft.), Layer-stranded, Shielded X3 SER1: Electrically Isolated X3 SER2: Not Electrically Isolated

Field Bus Interfaces	
Variable Baud Rates and Data Formats	
X2.1 / X2.2 CAN Bus	According to ISO 11898 Electrically Isolated
X2.1 / X2.2 DeviceNet	According to ISO 11898 Electrically Isolated
X2.1 / X2.2 INTERBUS	Electrically Isolated
DO1 / DI1 / DO2 / DI2 INTERBUS OPC Optical Fiber	Electrically Isolated
X2 MPI	Electrically Isolated
X2 PROFIBUS-DP	Electrically Isolated

Central Unit	
Central Unit	32-bit RISC CPU
Clock Frequency	74 MHz
Other Characteristics	Watchdog Timer, Real-Time Clock, Temperature Compensation of the Display, Battery Monitoring

Memory	
Application Memory	STN-Display: 3 MByte Flash TFT-Display: 7 MByte Flash
RAM	512 KByte Static CMOS-RAM, Battery-Backed
Memory Card	CompactFlash Card

Connection System	
D-SUB Female and Male Connector Strips, 9 Pin and 25 Pin	
Female and Male Connector Strips, Phoenix COMBICON, 3 Pin	
Connection FSMA Type 905	

Environmental Conditions	
Operation	0 °C to 50 °C (32 °F to 122 °F)
Storage, Transportation	STN-Display (Monochrome): -20 °C to 60 °C (- 4 °F to + 140 °F) STN-Display (Color): -25 °C to 70 °C (- 13 °F to + 158 °F) TFT-Display (Color): -25 °C to 70 °C (- 13 °F to + 158 °F)
Relative Humidity for Operation and Storage	10% to 95%, No Condensation
Application Area	Degree of Pollution 1, Overvoltage Category II

Standards and Guidelines	
Interference Immunity	EN 61000-4-2 EN 61000-4-3 EN 61000-4-4 EN 61000-4-5 EN 61000-4-6 EN 61000-6-2
Emitted Interference	EN 50081-1 Tab. A1 BT22EM: EN 55022 BT22ES / BT22ET: EN 55022 Limit Class Value A
Equipment Requirements	EN 61131
Storage and Transportation	EN 61131 Part 2
Power Supply	EN 61131 Part 2
Electromagnetic Compatibility	89/336/EEC (Including all Applicable Amendments)
Degree of Protection	EN 60529
Impact Load, Shocks	EN 60068 Part 2-27
Sinusoidal Vibrations	EN 60068 Part 2-6
Corrosion Protection	IEC 60068



This is a class A device. This device may cause radio interference in residential areas. In this case, the user may be required to introduce appropriate countermeasures, and to bear the cost of same.

Enclosure and Front Panel	
Enclosure	Steel Sheet, Galvanized
Front Panel	Aluminium, Anodized 300 mm x 260 mm x 4 mm (H x W x D) - (11.811" x 10.236" x 0.197")
Front Panel Cover	Polyester Foil
Seal	Circumferential Foam Seal on the Rear
Mounting Cutout	264 mm x 224 mm (H x W) - (10.394" x 8.819")
Mounting Depth	Standard Device: Approx. 49 mm (1.929") - (without Connector) Field Bus Device: Approx. 65 mm (2.559") - (without Connector) Field Bus Device INTERBUS Optical Fibre: Approx. 85 mm (3.346")
Degree of Protection	At the Front: IP65 At the Rear: IP20
Total Weight	Approx. 1950 g

7 Ordering Data

Table 7-1 Accessories

Description	Article No.
CompactFlash Card 16 MB	81152.000
CompactFlash Card 32 MB	81152.032
CompactFlash Adapter for Laptop	81166.000
CompactFlash Adapter for PC	81167.000
25 Pin Download Cable	88175.030
USB-RS232 Converter for Download (Only in Combination with 88175.030)	81215.000
Battery, Prepared with Cable, Connector and Cable Fastener (Type CR2450)	66757.000

A Index

A

Accessories..... 7-1

B

Battery..... 5-1
Battery disposal 5-3
Brightness setting 3-8

C

Cable

CAN 4-11
DeviceNet 4-14
INTERBUS..... 4-17
INTERBUS OPC LWL 4-19
MPI 4-23
PROFIBUS-DP 4-26

Changing the battery..... 5-2

Character attributes 3-9

Character set

Normal 3-9
Windows 3-9
Zoom..... 3-9

Connecting..... 2-6

Connector pin assignment

INTERBUS OPC LWL 4-19

Contrast setting..... 3-8

Control keys..... 3-3

D

Default brightness setting 3-9

Default contrast setting 3-9

Device variants 4-1

Diagnostic

CAN 4-11
DeviceNet 4-14
INTERBUS..... 4-17
INTERBUS OPC LWL 4-20
MPI 4-23
PROFIBUS-DP 4-26

Dimensions

Cutout 2-3
Front panel..... 2-2
Mounting depth for standard device 2-4

Mounting depth for the field bus device 2-5

Display 3-7

E

Editing keys..... 3-2

F

Firmware version..... 2-8

Function keys 3-5

Fuse 5-1

I

Identification 2-8

Intended use 1-2

Interface

CAN (X2.1/X2.2) 4-9

DeviceNet (X2.1/X2.2) 4-12

INTERBUS (X2.1/X2.2)..... 4-15

INTERBUS OPC LWL..... 4-18

MPI (X2)..... 4-21

PROFIBUS-DP (X2)..... 4-24

RS232c (X3-SER1)..... 4-7

RS232c (X3-SER2)..... 4-8

RS485 (X3-SER1)..... 4-5

TTY / 20 mA (X3-SER1) 4-3

K

Key

Acknowledge..... 3-4

Cursor down..... 3-4

Cursor home 3-4

Cursor left 3-3

Cursor right 3-3

Cursor up 3-4

Data release..... 3-4

Enter 3-4

Help..... 3-4

Minus 3-3

Page down 3-4

Page up..... 3-4

Plus 3-3

Print..... 3-5

Keyboard.....	3-1
L	
LcdBackLight.....	3-8
LcdContrast.....	3-8
M	
Maintenance.....	5-1
Maintenance interval	5-1
Memory card	4-27
Mounting	2-1
N	
Nameplate.....	2-8
O	
Ordering data	7-1
P	
Pin assignment	
CAN (X2.1/X2.2)	4-10
DeviceNet (X2.1/X2.2)	4-13
INTERBUS (X2.1/X2.2).....	4-16
MPI.....	4-22
PROFIBUS-DP (X2).....	4-25
RS232c	4-7
RS232c (X3-SER2).....	4-8
RS485 (X3-SER1).....	4-5
TTY / 20 mA (X3-SER1)	4-3
S	
Safety notes	1-2
Servicing	5-1
Slide-in identifications strips.....	3-6
Special keys	3-4
Standards.....	6-3
Supply voltage 24 V	2-6
Switching on.....	2-8
Symbols	
General	1-1
Specific	1-1
T	
Target group.....	1-2
Technical data.....	6-1
Termination	
CAN	4-11
DeviceNet	4-14
MPI.....	4-23
RS485	4-6
TTY / 20 mA.....	4-4, 4-7
U	
Unpacking	2-1
User mode switch.....	3-7



Sütron electronic GmbH
Kurze Straße 29
D-70794 Filderstadt
Phone: 0049 711 / 77098-0
Fax: 0049 711 / 77098-60
E-mail: doku@suetron.de
Internet: www.suetron.com

