



User Manual PR8000 Series

Frequency inverter



CONTENTS

I. Product	1
1.1 Nameplate	1
1.2 Model Illustration.....	1
1.3 Appearance	1
1.4 Technical Specifications	2
1.5 Designed Standards for Implementation.....	3
1.6 Precautions.....	3
II. Keypad panel.....	5
2.1 Panel Illustrations.....	5
2.2 Panel Operating	6
2.3 Parameters Setting	6
2.4 Function Codes Switchover In/Between Code-Groups.....	6
2.5 Panel Display	8
III. Installation Connection	9
3.1 Installation.....	9
3.2 Connection	9
3.3 Wiring Recommended.....	11
3.4 Lead Section Area of Protect Conductor(grounding wire)	11
3.5 Overall Connection and “Three-Line Connection”	12
IV. Operation and Simple Running	14
4.1 Control Mode	14
4.2 Mode of Frequency Setting.....	14
4.3 Mode of Controlling for Operation Command.....	14
4.4 Operating Status of Inverter.....	14
4.5 Keypad panel and Operation Method.....	15
4.6 Operation Flow of Measuring Motor Parameters.....	16
4.7 Operation Flow of Simple Running.....	17
4.8 Illustration of Basic Operation.....	18
4.9 Functions of Control Terminals.....	23

V. Basic Parameters	25
VI. Operation Control	30
VII. Multifunctional Input and Output Terminals.....	36
VIII. Analog Input and Output.....	38
IX. Multi-stage Speed Control.....	40
X. Auxiliary Functions.....	42
XI. Timing Control and Protection.....	43
XII. Parameters of Motor.....	45
XIII. Communication Parameters.....	48
XIV. PI Parameters.....	48
Appendix 1 Trouble Shooting.....	49
Appendix 2 Products and Structure.....	50
Appendix 3 Selection of Braking Resistance	53
Appendix 4 Communication Manual.....	54
Appendix 5 Zoom Table of Function Code	63

I. Product

This manual offers a brief introduction of the installation connection for F1000-G series inverters, parameters setting and operations, and should therefore be properly kept. Please contact manufacturer or dealer in case of any malfunction during application.

1.1 Nameplate

Taking for instance the PR8000 series 7.5KW inverter with three-phase input, its nameplate is illustrated as Fig 1-1.

3Ph: three-phase input; 380V, 50/60Hz: input voltage range and rated frequency.

3Ph: 3-phase output; 17A, 7.5KW: rated output current and power;

0.00~650.0Hz: output frequency range.

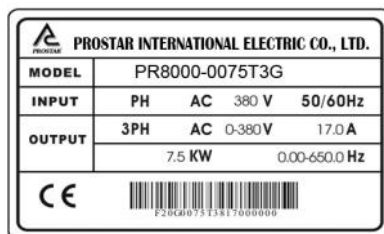
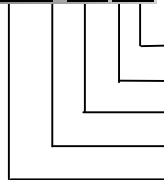

Fig 1-1 Nameplate Illustration

1.2 Model Illustration

Taking the same instance of 7.5KW inverter with three-phase, its model illustration is shown as Fig 1-2.

PR8000-0075 T3 G



G: Constant torque

Power input (T3: 3-phase 380VAC input; S2: single-phase 220VAC input)

Applicable motor power (7.5KW)

Series code

Manufacturer's name and upgrade code

Fig 1-2 Product Model Illustration

1.3 Appearance

The external structure of PR8000 series inverter is classified into plastic and metal housings. Only wall hanging type is available for plastic housing while wall hanging type and cabinet type for metal housing. Good poly-carbon materials are adopted through die-stamping for plastic housing with nice form, good strength and toughness.

Taking PR8000 - 0015T3G for instance, the external appearance and structure are shown as in Fig 1-3. Process of low sheen and silk screen printing are adopted on the

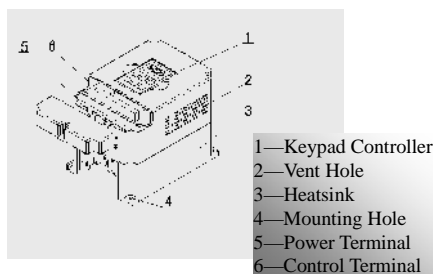
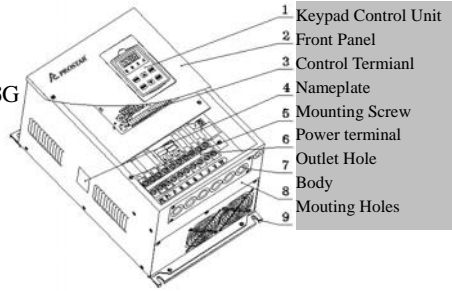

Fig 1-3 Appearance of Plastic Housing

housing surface with soft and pleasant gloss. Meanwhile, metal housing uses advanced exterior plastic-spraying and powder-spraying process on the surface with elegant color. Taking PR8000—0220T3G for instance, its appearance and structure are shown as in Fig 1-4, with detachable one-side door hinge structure adopted for front cover, convenient for wiring and maintenance.



1.4 Technical Specifications

Table1-1 Technical Specifications for PR8000 Series Inverters

	Items	Contents
Input	Rated Voltage Range	3-phase 380V±15%; single-phase 220V±15%
	Rated Frequency	50/60Hz
Output	Rated Voltage Range	3-phase 0~380V;3-phase 0~220V
	Frequency Range	0.00~650.0Hz
V/FControl	Carrier Frequency	3000~10000Hz
	Input Frequency Resolution	Digital setting: 0.01Hz, analog setting: max frequency × 0.1%
	Control Mode	Sensorless Vector Control (SVC), VVVF control
	Start Torque	0.5 Hz/150% (SVC)
	Speed-control Scope	1:100 (SVC)
	Steady Speed Precision	±0.5% (SVC)
	Torque Control Precision	±0.5% (SVC)
	Overload Capacity	150% rated current, 60 seconds.
	Torque Elevating	Auto Torque elevating, Manual Torque Promotion 0.1%~30.0% (VVVF)
	V/F Curve	3 kinds of modes: beeline type, square type and under-defined V/F curve.
	DC Braking	DC braking frequency: 1.0~5.0 Hz, braking time: 0.0~10.0s
	Jogging Control	Jogging frequency range: min frequency~ max frequency, jogging acceleration/deceleration time: 0.1~3000.0s
	Auto Circulating Running and multi-stage speed running	Auto circulating running or terminals control can realize 16-stage speed running.
	Built-in PI adjusting	easy to realize Convenient form a system for process closed-loop control
Automatic Voltage Rectification (AVR)	Enable to keep output voltage constant automatically in the case of change of grid voltage.	

Operation Function	Frequency Setting	Potentiometer or external analog signal (0~5V, 0~10V, 0~20mA); keypad (terminal) / keys, external control logic and automatic circulation setting.
	Start/Stop Control	Passive contact switch control, keypad control or communication control.
	Running Command Channels	3 kinds of channels from keypad panel, control terminal and series communication port.
	Frequency Source	Frequency sources: given digit, given analog voltage, given analog current and given series communication port.
	Accessorial frequency Source	Flexible implementation of 5 kinds of accessorial frequency fine adjustments and frequency compound.
Protection Function	Input out-phase, Output out-phase, input under-voltage, DC over-voltage, over-current, over-load, current stall, over-heat, external disturbance	
Display	LED nixie tube showing present output frequency, present rotate-speed (rpm), present output current, present output voltage, present linear-velocity, types of faults, and parameters for the system and operation; LED indicators showing the current working status of inverter.	
Environment Conditions	Equipment Location	In an indoor location, Prevent exposure from direct sunlight, Free from dust, tangy caustic gases, flammable gases, steam or the salt-contented, etc.
	Environment Temperature	-10 ~+50
	Environment Humidity	Below 90% (no water-bead coagulation)
	Vibration Strength	Below 0.5g (acceleration)
	Height above sea level	1000m or below
Applicable Motor	0.4~400KW	

1.5 Designed Standards for Implementation

- IEC/EN 61800-5-1: 2003 Adjustable speed electrical power drive systems safety requirements.
- IEC/EN 61800-3: 2004 Adjustable speed electrical power drive systems-Part 3: EMC product standard including specific test methods.

1.6 Precautions

1.6.1 Notice for Application

- Installation and application environment should be free of rain, drips, steam, dust and oily dirt; without corrosive or flammable gases or liquids, metal particles or metal powder.
- Environment temperature within the scope of -10 ~+50 .
- Inverter is installed in a control cabinet, and smooth ventilation should be

ensured.

- Do not drop anything into the inverter.
- Never touch the internal elements within 15 minutes after power off. Wait till it is completely discharged.
- Input terminals R, S and T are connected to power supply of 380V and single-phase input terminals R,T are connected to 220V while output terminals U, V and W are connected to motor.
- Proper grounding should be ensured with grounding resistance not exceeding 4 Ω ; separate grounding is required for motor and inverter. No grounding with series connection is allowed.
- No load switch is allowed at output while inverter is in operation.
- AC reactor or/and DC reactor is recommended when your inverter is above 37KW.
- There should be separate wiring between control loop and power loop to avoid any possible interference.
- Signal line should not be too long to avoid any increase with common mode interference.
- It shall comply with the requirements for surrounding environment as stipulated in Table 1-1 “**Technical Specifications for PR8000–G Series Inverter**”.

1.6.2 Maintenance

- Cooling fan should be cleaned regularly to check whether it is normal; remove the dust accumulated in the inverter on a regular basis.
- Check inverter’s input and output wiring regularly.
- Replace inverter’s cooling fan, starting contactor (relay) regularly.
- Check if all terminal wiring screws are fastened and if wirings are aging.

1.6.3 Special Warning!!

- Never touch high-voltage terminals inside the inverter to avoid any electric shock.
- All safety covers should be well fixed before inverter is power connected, to avoid any electric shock.
- Only professional personnel are allowed for any maintenance, checking or replacement of parts.
- No live-line job is allowed.

II. Keypad panel

Keypad panel and monitor screen are both fixed on keypad controller. Two kinds of controllers (with and without potentiometer) are available for F1000-G series inverters, and each keypad controller has two kinds of size. Refer to note for Fig2-1.

2.1 Panel Illustration

The panel covers three sections: data display section, status indicating section and keypad operating section, as shown in Fig. 2-1.

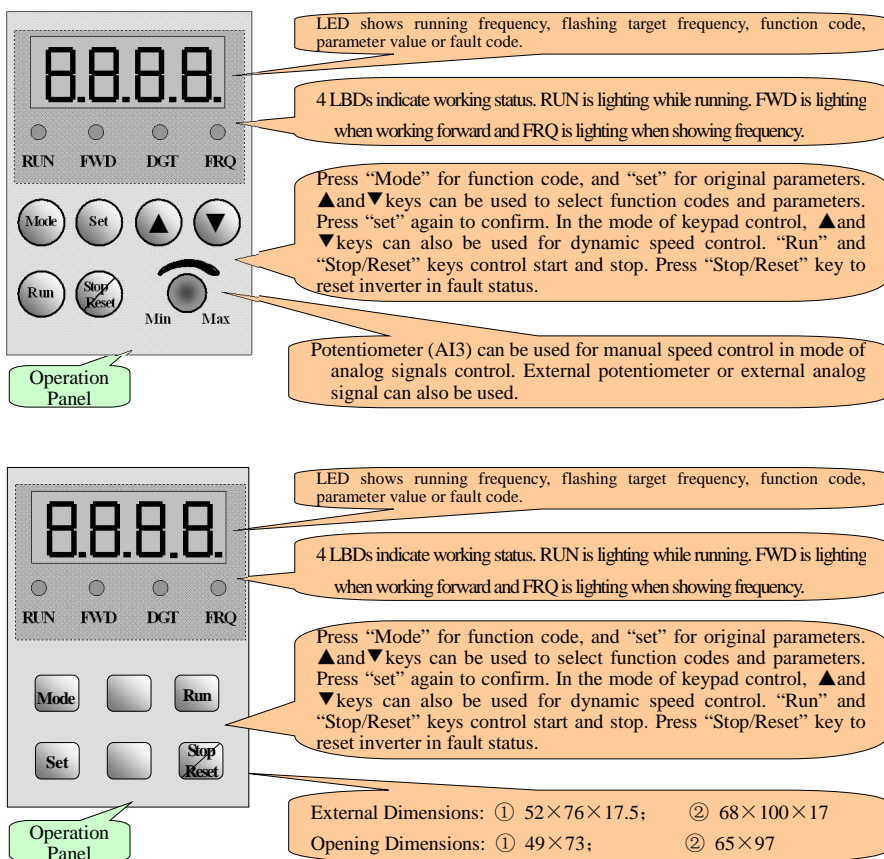







Fig.2-1 Operation Panels in Two Kinds

2.2 Panel Operating

All keys on the panel are available for user. Refer to Table 2-1 for their functions.















Table 2-1 **Uses of Keys**

Keys	Names	Remarks
	Mode	To call function code and switch over display mode.
	Set	To call and save data.
	Up	To increase data (speed control or setting parameters)
	Down	To decrease data (speed control or setting parameters)
	Run	To start inverter; to call jogging operation; to call auto circulating operation; to switch over display mode.
	Stop or reset	To stop inverter; to reset in fault status; to change function codes in a code group or between two code groups.

2.3 Parameters Setting

This inverter has numerous function parameters, which the user can modify to effect different modes of operation control. User needs to realize that user's password must be entered first if parameters are to be set after power off or protection is effected, i.e., to call F100 as per the mode in Table 2-2 and enter the correct code. Default value at manufacturer for user's password is 8.

Table 2-2 **Steps for Parameters Setting**

Steps	Keys	Operation	Display
1		Press "Mode" key to display function code	
2	 or 	Press "Up" or "Down" to select required function code	
3		To read data set in the function code	
4	 or 	To modify data	
5		To show corresponding target frequency by flashing after saving the set data	
		To display the current function code	

The above-mentioned step should be operated when inverter is in stop status.

2.4 Function Codes Switchover in/between Code-Groups

This has more than 300 parameters (function codes) available to user, divided into 10 sections as indicated in Table 2-3.

Table 2-3 Function Code Partition

Group Name	Function Code Range	Group No.	Group Name	Function Code Range	Group No.
Basic Parameters	F100~F160	1	Subsidiary function	F600~F630	6
Run Control Mode	F200~F230	2	Timing control and protection function	F700~F740	7
Multi-functional input/output terminal	F300~F330	3	Motor parameters	F800~F830	8
Analog signals of input/output	F400~F440	4	Communication function	F900~F930	9
Multi-stage speed parameters	F500~F580	5	PI parameters setting	FA00~FA30	10

As parameters setting costs time due to numerous function codes, such function is specially designed as “Function Code Switchover in a Code Group or between Two Code-Groups” so that parameters setting become convenient and simple.

Press “Mode” key so that the keypad controller will display function code. If press “ ” or “ ” key then, function code will circularly keep increasing or decreasing by degrees within the group; if press again the “stop/reset” key, function code will change circularly between two code groups when operating the “ ” or “ ” key.

e.g. when function code shows F111, DGT indicator will be on. Press “ ”/“ ” key, function code will keep increasing or decreasing by degrees within F100~F160; press “stop/reset” key again, DGT indicator will be off. When pressing “ ”/“ ” key, function codes will change circularly among the 10 code-groups, like F211, F311...FA11, F111..., Refer to Fig 2-2 (The sparkling “ ” is indicated the corresponding target frequency values).

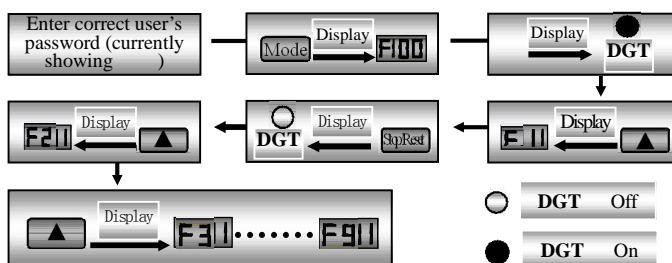

Fig 2-2 Switch over in a Code Group or between Different Code-Groups

2.5 Panel Display

Table 2-4 Items and Remarks Displayed on the Panel

Items	Remarks
HF-0	This Item will be displayed when you press "Mode" in stopping status, which indicates jogging operation is valid. But HF-0 will be displayed only after you change the value of 132.
-HF-	It stands for resetting process and will display "0" after reset.
OC, OE, OLI, OL2, OH, LU, PF0, PF1, CB	Fault code, indicating "over-current", "over-voltage", "inverter over-load", "motor over-load""over-heat", "under-voltage for input", "out-phase for input" ,"out-phase for output" and "contactor fault" respectively.
H.H.	Interruption code, indicating "external intrusion" signal input and showing "0" after reset.
F152	Function code (parameter code).
10.00	Indicating inverter's current running frequency (or rotate speed) and parameter setting values, etc.
	Sparkling in stopping status to display target frequency.
0.	Holding time when changing the running direction. When "Stop" or "Free Stop" command is executed, the holding time can be canceled
A100、 U100	Output current (100A) and output voltage (100V). Keep one digit of decimal when current is below 100A.

III. Installation & Connection

3.1 Installation

Inverter should be installed vertically, as shown in Fig 3-1. Sufficient ventilation space should be ensured in its surrounding. Clearance dimensions (recommended) are available from Table 3-1 for installing the inverter.

Table 3-1 Clearance Dimensions

Inverter Model	Clearance Dimensions	
Hanging (<22KW)	A 150mm	B 50mm
Hanging (22KW)	A 200mm	B 75mm
Cabinet (110~400KW)	C 200mm	D 75mm

3.2 Connection

- In case of 3-phase input, connect R, S and T terminals (L1 and L2 terminals for single-phase) with power source from network and PE (E) to earthing, U, V and W terminals to motor.
- Motor shall have to be ground connected. Or else electrified motor causes interference.
- External braking cell may be considered for inverter with single-phase input if load inertia is too large for the built-in braking cell;
- For inverter with 3-phase input and power lower than 15kw, braking cell is also built-in. If the load inertia is moderate, it is Ok to only connect braking resistance with built-in braking cell.

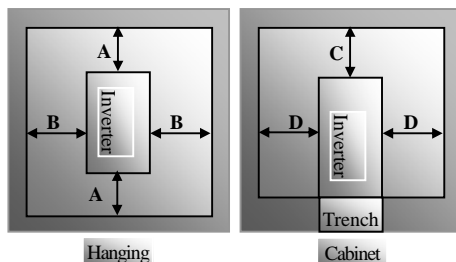
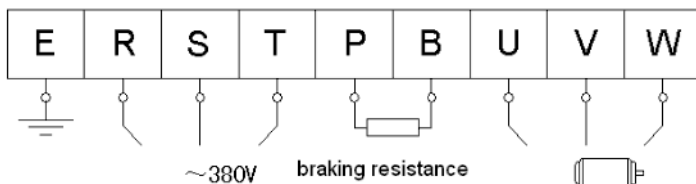
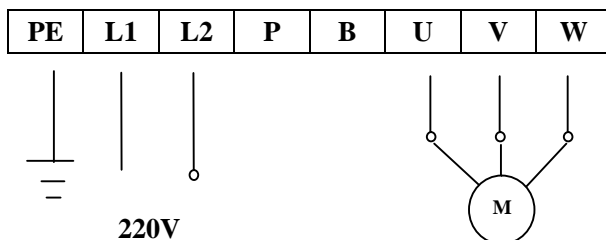
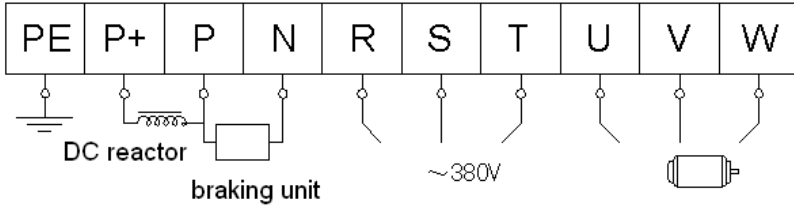

Fig 3-1 Installation Sketch





(The figure is only sketch, terminals order of practical products may be different from the above-mentioned figure. Please pay attention when connecting wires)

Introduction of terminals of power loop

Terminals	Terminal Marking	Terminal Function Description
Power Input Terminal	R, S, T	Input terminals of three-phase 380V AC voltage (R and T terminals for single-phase)
Output Terminal	U, V, W	Inverter power output terminal, connected to motor.
Grounding Terminal	PE (E)	Inverter grounding terminal or connected to ground.
Braking Terminal	P, B	External braking resistor (Note: no Terminals P or B for inverter without built-in braking unit).
	P, N	DC bus-line output, externally connected to braking resistor P connected to input terminal “P” of braking unit or terminal “+”, N connected to input terminal of braking unit “N” or terminal “-”.
	P, P+	Externally connected to DC reactor

Wiring for control loop as follows:

A) The following sketch is the control terminals for single-phase 0.4KW, 0.75KW, 1.5KW and built-in braking cell inverters.

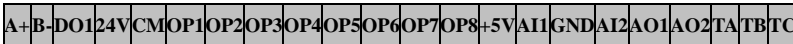

B) The following sketch is the control terminals for single-phase 2.2KW inverters.

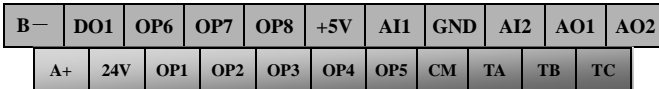

C) The following sketch is the control terminals for three-phase 0.75~400KW inverters.



Terminals A+ and B- are effective only when MODBUS communication is required by customers.

3.3 Wiring Recommended

Wiring for Power Loop

Inverter Model	Lead Section Area(mm ²)	Inverter Model	Lead Section Area(mm ²)	Inverter Model	Lead Section Area(mm ²)
PR8000-0004S2G	1.5	PR8000-0075T3G	4	PR8000-1600T3G	120
PR8000-0004XS2G	1.5	PR8000-0110T3G	6.0	PR8000-2000T3G	150
PR8000-0007S2G	2.5	PR8000-0150T3G	10	PR8000-2200T3G	185
PR8000-0007XS2G	2.5	PR8000-0185T3G	16	PR8000-2500T3G	240
PR8000-0015S2G	2.5	PR8000-0220T3G	16	PR8000-2800T3G	240
PR8000-0015XS2G	2.5	PR8000-0300T3G	25	PR8000-3150T3G	300
PR8000-0022S2G	4.0	PR8000-0370T3G	25	PR8000-3550T3G	300
PR8000-0007T3G	1.5	PR8000-0450T3G	35	PR8000-4000T3G	400
PR8000-0015T3G	2.5	PR8000-0550T3G	35		
PR8000-0022T3G	2.5	PR8000-0750T3G	50		
PR8000-0037T3G	2.5	PR8000-0900T3G	70		
PR8000-0040T3G	2.5	PR8000-1100T3G	70		
PR8000-0055T3G	4	PR8000-1320T3G	95		

3.4 Lead section area of protect conductor (grounding wire)

Lead section area S of U, V, W (mm ²)	Minimum lead section area S of E (mm ²)
$S \leq 16$	S
$16 < S \leq 35$	16
$35 < S$	S/2

3.5 Overall Connection and “Three-Line” Connection

* Refer to next figure for overall connection sketch for PR8000 series inverters. Wiring mode is available for various terminals whereas not every terminal needs connection when applied.

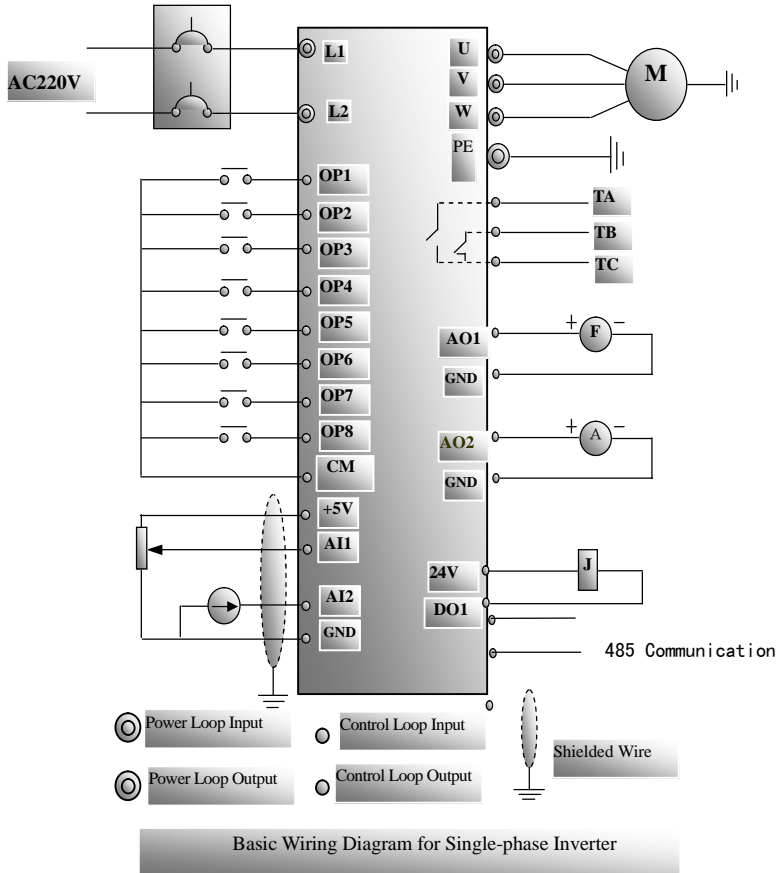

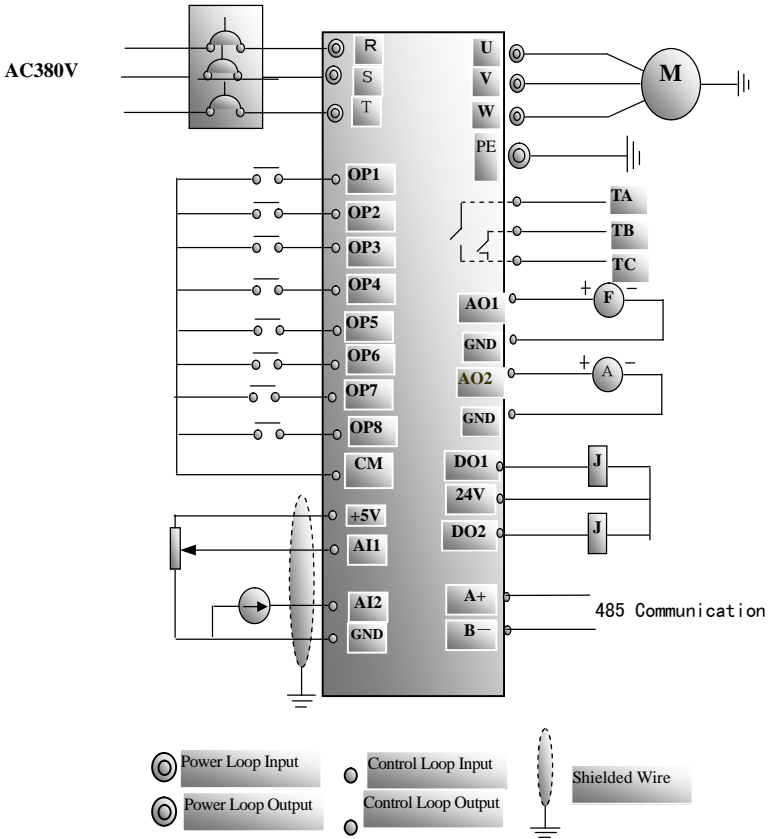

Basic Wiring Diagram for Three-phase Inverter

IV. Operation and Simple Running

This chapter defines and interprets the terms and nouns describing the control, running and status of the inverter. Please read it carefully. It will be helpful to your correct operation.

4.1 Control mode

PR8000 inverter has two control modes: sensorless vector control (F106=0), and V/F control (F106=2).

Mode 0: sensorless vector control, also named open-loop vector control, suitable for the cases that no encoder is installed, there are higher requirements for starting torque and control precision of speed, and V/F control mode can not satisfy.

Mode 2: V/F control mode.

4.2 Mode of frequency setting

Please refer to F203~F207 for the method and channel for setting the running frequency (speed) of the PR8000 inverter.

4.3 Mode of controlling for running command

The channel for inverter to receive control commands (including start, stop and jogging, etc) contains three modes: 1. Keyboard (keypad panel) control; 2. External terminal control; 3. Serial communication control.

The modes of control command can be selected through the function codes F200 and F201.

4.4 Operating status of inverter

When the inverter is powered on, it may have four kinds of operating status: stopped status, programming status, running status, and fault alarm status. They are described in the following:

4.4.1 Stopped status

If re-energize the inverter (if “self-startup after being powered on” is not set) or decelerate the inverter to stop the output, the inverter is at the stopped status until receiving control command. At this moment, the running status indicator on the keyboard goes off, and the display shows the display status before power down.

4.4.2 Programming status

Through keypad panel, the inverter can be switched to the status that can read or change the function code parameters. Such a status is the programming status.

There are numbers of function parameters in the inverter. By changing these parameters, the user can realize different control modes.

4.4.3 Running status

The inverter at the stopped status or fault-free status will enter running status after having received operation command.

The running indicator on keypad panel lights up under normal running status.

4.4.4 Fault alarm status

The status under which the inverter has a fault and the fault code is displayed.

Fault codes mainly include: OC, OE, OL1, OL2, OH, LU, PF1, and CB, representing “over current”, “over voltage”, “inverter overload”, “motor overload”, “overheat”, “input undervoltage”, “input out-phase”, and “contactor fault” respectively.

For trouble shooting, please refer to Appendix I to this manual, “Trouble Shooting”.

4.5 Keypad panel and operation method

Keypad panel (keyboard) is a standard part for configuration of PR8000 inverter. Through keypad panel, the user may carry out parameter setting, status monitoring and operation control over the inverter. Both keypad panel and display screen are arranged on the keyboard controller, which mainly consists of three sections: data display section, status indicating section, and keyboard operating section. There are two types of keyboard controller (with potentiometer or without potentiometer) for inverter. Each type of keyboard controller has two sizes. For details, please refer to Chapter II of this manual, “Keypad panel”.

It is necessary to know the functions and how to use the keypad panel. Please read this manual carefully before operation.

4.5.1 Method of operating the keypad panel

(1) Operation flow of setting the parameters through keypad panel

A three-level menu structure is adopted for setting the parameters through keypad panel of inverter, which enables convenient and quick searching and changing of function code parameters.

Three-level menu: Function code group (first-level menu) Function code (second-level menu) Set value of each function code (third-level menu).

(2) Setting the parameters

Setting the parameters correctly is a precondition to give full play of inverter performance. The following is the introduction on how to set the parameters through keypad panel.

Operating procedures:

Press the “Mode” key, to enter programming menu.

Press the key “Stop/Reset”, the DGT lamp goes out. Press and , the function code will change within the function code group. The first number behind F displayed on the panel is 1, in other words, it displays F1××at this moment.

Press the key “Stop/Reset” again, the DGT lamp lights up, and the function code will change within the code group. Press and to change the function code to F106; press the “Set” key to display 0; while press and to change to 2.

Press the “Set” key to complete the change.

4.5.2 Switching and displaying of status parameters

Under stopped status or running status, the LED digitron of inverter can display status parameters of the inverter. Actual parameters displayed can be selected and set through the set value of function codes F131 and F132. Through the “Mode” key, it can switch over repeatedly and display the parameters of stopped

status or running status. The followings are the description of operation method of displaying the parameters under stopped status and running status.

(1) Switching of the parameters displayed under stopped status

Under stopped status, inverter has five parameters of stopped status, which can be switched over repeatedly and displayed with the keys “Mode” and “Stop/Reset”. These parameters are displaying: keyboard jogging, target rotary speed, PN voltage, PI feedback value, and temperature. Please refer to the description of function code F132.

(2) Switching of the parameters displayed under running status

Under running status, eight parameters of running status can be switched over repeatedly and displayed with the keys “Mode” and “Stop/Reset”. These parameters are displaying : current output rotary speed, output current, output voltage, PN voltage, PI feedback value, temperature, count value and linear speed. Please refer to the description of function code F131.

4.6 Operation flow of measuring motor parameters

The user shall input the parameters accurately as indicated on the nameplate of the motor prior to selecting operation mode of vector control. Inverter will match standard motor parameters according to these parameters indicated on the nameplate. To achieve better control performance, the user may start the inverter to measure the motor parameters, so as to obtain accurate parameters of the motor controlled.

The parameters of the motor can be measured through function code F800.

For example: If the parameters indicated on the nameplate of the motor controlled are as follows: numbers of motor poles are 4; rated power is 7.5KW; rated voltage is 380V; rated current is 15.4A; rated frequency is 50.00HZ; and rated rotary speed is 1440rpm, operation flow of measuring the parameters shall be done as described in the following:

1. In accordance with the above motor parameters, set the values of F801 to F805 correctly: set the value of F801 to 7.5, F802 to 380, F803 to 15.4, F804 to 4, and F805 to 1440 respectively.
2. In order to ensure dynamic control performance of the inverter, set F800=1, i.e. select running parameter measurement. Make sure that the motor is disconnected from the load. Press the “Run” key on the keyboard, and the inverter will display “TEST”, and it will measure the motor’s static parameters of two stages. After that, the motor will accelerate according to the acceleration time set at F114 and maintain for a certain period. The motor will then decelerate to 0 according to the time set at F115. After self-checking is completed, relevant parameters of the motor will be stored in function codes F806-F809, and F800 will turn to 0 automatically.
3. If it is impossible to disconnect the motor from the load, select F800=2, i.e. static parameter measurement. Press the “Run” key, the inverter will display “TEST”, and it will measure the motor’s static parameters of two stages. The motor’s stator resistance, rotor resistance and leakage inductance will be stored in F806-F808 automatically, and F800 will turn to 0 automatically. The user may also calculate and input the motor’s mutual inductance value manually according to actual conditions of the motor.

4.7 Operation flow of simple running

Table 4-1 shows a brief introduction to inverter operation flow.

Table 4-1 Brief Introduction to Inverter Operation Flow

Flow	Operation	Reference
Installation and operation environment	Install the inverter at a location meeting the technical specifications and requirements of the product. Mainly take into consideration the environment conditions (temperature, humidity, etc) and heat radiation of the inverter, to check whether they can satisfy the requirements.	See Chapters I, II, III.
Wiring of the inverter	Wiring of main circuit input and output terminals; wiring of grounding; wiring of switching value control terminal, analog terminal, speed measuring encoder, and communication interface, etc.	See Chapter III.
Checking before getting energized	Make sure that the voltage of input power supply is correct; the input power supply loop is connected with a breaker; the inverter has been grounded correctly and reliably; the power cable is connected to the power supply input terminals R, S, and T of the inverter correctly; the output terminals U, V, and W of the inverter are connected to the motor correctly; the wiring of speed measuring encoder PG is correct; the wiring of control terminals is correct; all the external switches are preset correctly; and the motor is under no load (the mechanical load is disconnected from the motor).	See Chapters I~III, and Chapter XII.
Checking immediately after energized	Check if there is any abnormal sound, fuming or foreign flavor with the inverter. Make sure that the display of keypad panel is normal, without any fault alarm message. In case of any abnormality, switch off the power supply immediately.	See Appendix 1 and Appendix 2.
Inputting the parameters indicated on the motor's nameplate correctly, and measuring the motor's parameters.	Make sure to input the parameters indicated on the motor nameplate correctly, and study the parameters of the motor. The users shall check carefully, otherwise, serious problems may arise during running. Before initial running with vector control mode, carry out measurement of motor parameters, to obtain accurate electric parameters of the motor controlled. Before carrying out measurement of the parameters, make sure to disconnect the motor from mechanical load, to make the motor under entirely no load status. It is prohibited to measure the parameters when the motor is at a running status.	See description of parameter group F800~F830
Setting running control parameters	Set the parameters of the inverter and the motor correctly, which mainly include target frequency, upper and lower frequency limits, acceleration/deceleration time, and direction control command, etc. The user can select corresponding running control mode according to actual applications.	See description of parameter group.

Checking under no load	With the motor under no load, start the inverter with the keyboard or control terminal. Check and confirm running status of the drive system. Motor's status: stable running, normal running, correct rotary direction, normal acceleration/deceleration process, free from abnormal vibration, abnormal noise and foreign flavor. Inverter' status: normal display of the data on keypad panel, normal running of the fan, normal acting sequence of the relay, free from the abnormalities like vibration or noise. In case of any abnormality, stop and check the inverter immediately.	See Chapter VIII.
Checking under with load	After successful test run under no load, connect the load of drive system properly. Start the inverter with the keyboard or control terminal, and increase the load gradually. When the load is increased to 50% and 100%, keep the inverter run for a period respectively, to check if the system is running normally. Carry out overall inspection over the inverter during running, to check if there is any abnormality. In case of any abnormality, stop and check the inverter immediately.	
Checking during running	Check if the motor is running stably, if the rotary direction of the motor is correct, if there is any abnormal vibration or noise when the motor is running, if the acceleration/deceleration process of the motor is stable, if the output status of the inverter and the display of keypad panel is correct, if the blower fan is run normally, and if there is any abnormal vibration or noise. In case of any abnormality, stop the inverter immediately, and check it after switching off the power supply.	

4.8 Illustration of basic operation

Illustration of inverter basic operation: we hereafter show various basic control operation processes by taking a 7.5kW inverter that drives a 7.5kW three-phase asynchronous AC motor as an example.

The parameters indicated on the nameplate of the motor are as follows: 4 poles; rated power, 7.5KW; rated voltage, 380V; rated current, 15.4A; rated frequency 50.00HZ; and rated rotary speed, 1440rpm.

4.8.1 Operation processes of frequency setting, start, forward running and stop with keypad panel

- (1) Connect the wires in accordance with Figure 4-1. After having checked the wiring successfully, switch on the air switch, and power on the inverter.

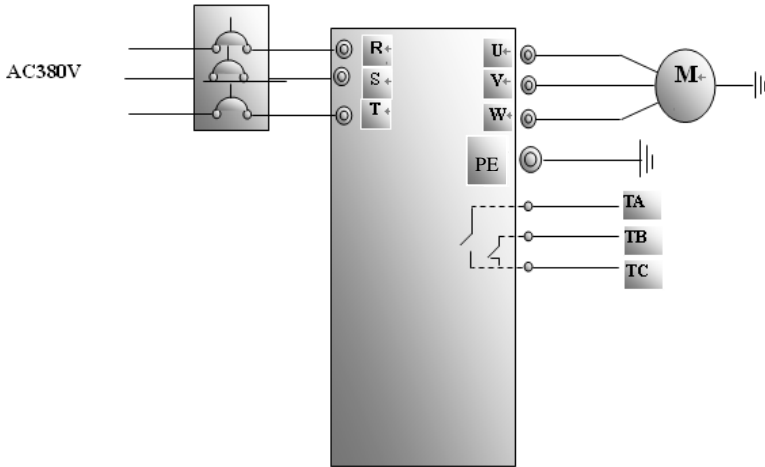

Figure 4-1 Wiring Diagram 1

(2) Press the “Mode” key, to enter the programming menu.

(3) Measure the parameters of the motor

Enter F801 parameter and set rated power of the motor to 7.5kW;

Enter F802 parameter and set rated voltage of the motor to 380V;

Enter F803 parameter and set rated current of the motor to 15.4A;

Enter F804 parameter and set number of poles of the motor to 4;

Enter F805 parameter and set rated rotary speed of the motor to 1440 rpm;

Enter F800 parameter and set it to 1 or 2, to allow measuring the parameter of the moto (1= running parameter measurement, 2= static parameter measurement. In the mode of running parameter measurement, make sure to disconnect the motor from the load);

Press the “Run” key, to measure the parameters of the motor. After completion of the measurement, the motor will stop running, and relevant parameters will be stored in F806~F809. For the details of measurement of motor parameters, please refer to “Operation flow of measuring the motor parameters” in this manual and Chapter XII of this manual.

(4) Set functional parameters of the inverter:

Enter F106 parameter and set it to 0; select the control mode to sensorless vector control;

Enter F203 parameter and set it to 0;

Enter F111 parameter and set the frequency to 50.00Hz;

Enter F200 parameter and set it to 0; select the mode of start to keyboard control;

Enter F201 parameter and set it to 0; select the mode of stop to keyboard control;

Enter F202 parameter and set it to 0; select corotation locking.

(5) Press the “Run” key, to start the inverter;

(6) During running, current frequency of the inverter can be changed by pressing or ;

(7) Press the “Stop/Reset” key once, the motor will decelerate until it stops running;

(8) Switch off the air switch, and deenergize the inverter.

4.8.2 Operation process of setting the frequency with keypad panel, and starting, forward and reverse running, and stopping inverter through control terminals

- (1) Connect the wires in accordance with Figure 4-2. After having checked the wiring successfully, switch on the air switch, and power on the inverter:

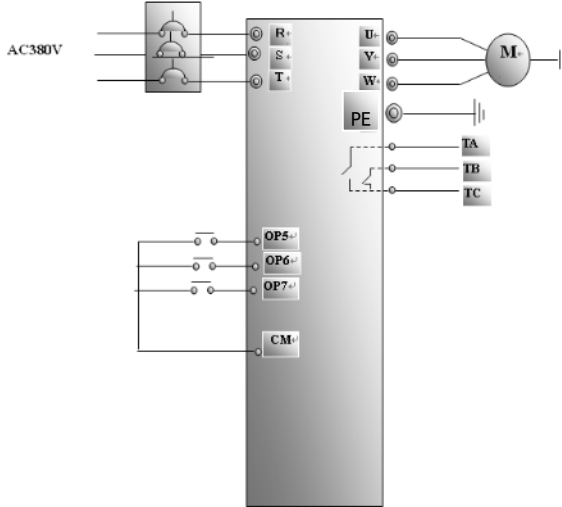

Figure 4-2 Wiring Diagram 2

- (2) Press the “Mode” key, to enter the programming menu.
- (3) Study the parameters of the motor: the operation process is the same as that of example 1.
- (4) Set functional parameters of the inverter:
- Enter F106 parameter and set it to 0; select sensorless vector control for the control mode;
 - Enter F203 parameter and set it to 0; select the mode of frequency setting to digital given memory;
 - Enter F111 parameter and set the frequency to 50.00Hz;
 - Enter F208 parameter and set it to 1; select two-line control mode 1 (Note: when F208 = 0, F200, F201 and F202 will be invalid.)
- (5) Close the switch OP6, the inverter starts forward running;
- (6) During running, current frequency of the inverter can be changed by pressing or ;
- (7) During running, switch off the switch OP6, then close the switch OP7, the running direction of the motor will be changed (Note: The user should set the dead time of forward and reverse running F120 on the basis of the load. If it was too short, OC protection of the inverter may occur.)
- (8) Switch off the switches OP6 and OP7, the motor will decelerate until it stops running;
- (9) Switch off the air switch, and deenergize the inverter.

4.8.3 Operation process of jogging operation with keypad panel

- (1) Connect the wires in accordance with Figure 4-1. After having checked the wiring successfully, switch on the air switch, and power on the inverter;
- (2) Press the “Mode” key, to enter the programming menu.

(3) Measure the parameters of the motor; the operation process is the same as that of example 1.

(4) Set functional parameters of the inverter:

Enter F132 parameter and set it to 1; select keyboard jogging;

Enter F106 parameter and set it to 0; select the control mode to sensorless vector control;

Enter F200 parameter and set it to 0; select the mode of running command control by keyboard operation;

Enter F124 parameter, and set the jogging operation frequency to 5.00Hz;

Enter F125 parameter, and set the jogging acceleration time to 30S;

Enter F126 parameter, and set the jogging deceleration time to 30S;

Enter F202 parameter, and set it to 0; select forward running locking.

(6) Press and hold the “Run” key until the motor is accelerated to the jogging frequency, and maintain the status of jogging operation.

(7) Release the “Run” key. The motor will decelerate until jogging operation is stopped;

(8) Switch off the air switch, and deenergize the inverter.

4.8.4 Operation process of setting the frequency with analog terminal c and controlling the operation with control terminals

(1) Connect the wires in accordance with Figure 4-3. After having checked the wiring successfully, switch on the air switch, and power on the inverter. Note: 2K~5K potentiometer may be adopted for setting external analog signals. For the cases with higher requirements for precision, please adopt precise multiturn potentiometer, and adopt shielded wire for the wire connection, with near end of the shielding layer grounded reliably.

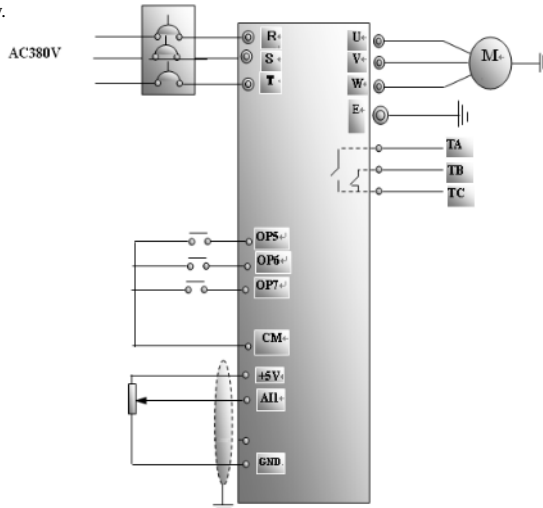

Figure 4-3 Wiring Diagram 3

(2) Press the “Mode” key, to enter the programming menu.

(3) Study the parameters of the motor; the operation process is the same as that of example 1.

(4) Set functional parameters of the inverter:

Enter F106 parameter, and set it to 0; select sensorless vector control as the control mode;

Enter F203 parameter, and set it to 1; select the mode of frequency setting of analog AI1, 0~5V voltage terminal;

Enter F208 parameter, and set it to 1; select direction terminal (set OP5 to free stop, set OP6 to forward running, set OP7 to reverse running) to control running;

(5) There is a red four-digit coding switch SW1 near the control terminal block of three-phase inverter, as shown in Figure 4-4. The function of coding switch is to select the input range (0~5V/0~10V) of voltage type analog input terminal AI1. In actual application, select the analog input channel through F203. Turn switches 1 and 3 to OFF as illustrated in the figure, and select 0~5V voltage speed control.

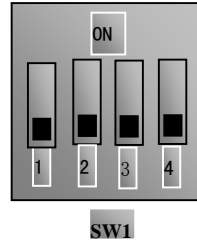

Figure 4-4

Table 4-2

The Setting of Coding Switch and Parameters in the Mode of Analog Speed Control

Set F203 to 1, to select channel AI1			Set F203 to 2, to select channel AI2		
Coding Switch 1	Coding Switch 3	Mode of Speed Control	Coding Switch 2	Coding Switch 4	Mode of Speed Control
OFF	OFF	5V voltage	OFF	OFF	5V voltage
OFF	ON	10V voltage	OFF	ON	10V voltage
ON	OFF	0~20mA current	ON	OFF	0~20mA current

ON refers to switching the coding switch to the top.

OFF refers to switching the coding switch to the bottom.

(6) Close the switch OP6, the motor starts forward running;

(7) The potentiometer can be adjusted and set during running, and the current setting frequency of the inverter can be changed;

(8) During running, switch off the switch OP6, then, close OP7, the running direction of the motor will be changed;

(9) Switch off the switches OP6 and OP7, the motor will decelerate until it stops running;

(10) Switch off the air switch, and power off the inverter.

4.9 Functions of control terminals

The key to operate the inverter is to operate the control terminals correctly and flexibly. Certainly, the control terminals are not operated separately, and they should match corresponding settings of parameters. This chapter describes basic functions of the control terminals. The users may operate the control terminals by combining relevant contents hereafter about “Defined Functions of the Terminals”.

Table 4-3 **Functions of Control Terminals**

Terminal	Type	Description	Function
DO1	Output signal	Multifunctional output terminal 1	When the token function is valid, the value between this terminal and CM is 0V; when the inverter is stopped, the value is 24V.
DO2		Multifunctional output terminal 2	When the function is valid, the value between this terminal and CM is 0V; when the inverter is stopped, the value is 24V.
TA		Relay contact	TC is a common point, TB-TC are normally closed contacts, TA-TC are normally open contacts. The contact current is not more than 2A, and voltage not more than 250VAC.
TB			
TC			
AO1		Running frequency	It is connected with frequency meter or speedometer externally, and its minus pole is connected with GND. See F423~F426 for details..
AO2	Current display	It is connected with ammeter externally, and its minus pole is connected with GND. See F427~F430 for details (This function is not available for single-phase inverter.)	
+5V	Voltage control	Self contained power supply	Internal 5V self-contained power supply of the inverter provides power to the inverter. When used externally, it can only be used as the power supply for voltage control signal, with current restricted below 20mA.
AI1		Voltage analog input port	When analog speed control is adopted, the voltage signal is inputted through this terminal. The range of voltage input is 0~5V or 0~10V, grounding: GND. When potentiometer speed control is adopted, this terminal is connected with center tap, earth wire to be connected to GND.
GND		Self-contained Power Source Ground	Ground terminal of external control signal (voltage control signal or current source control signal) is also the source of 5V power supply of this inverter.
AI2	Current control	Current analog input port	When analog speed control is adopted, the current signal is input through this terminal. The range of current input is 0~20mA, grounding: GND. If the input is 4~20mA, it can be realized through adjusting relevant functions.
24V	Power supply	Control power supply	Power: 24±1.5V, grounding: CM; current is restricted below 50mA for external use.

OP1	Function operation	Jogging terminal	When this terminal is short connected with CM, the inverter will have jogging running. The jogging function of this terminal is valid under both stopped and running status.	The functions of input terminals shall be defined per manufacturer's value. Other functions can also be defined by changing function codes.
OP2	Speed setting	Multi-stage speed control terminal	These three terminals are customarily defined as "three-stage speeds" transfer terminals. They can also be used for other function control.	
OP3				
OP4				
OP5	Function operation	Free stop	Short connecting this terminal with CM during running can realize free stop.	
OP6		Forward running command	When this terminal is short connected with CM, the inverter will run forward.	
OP7		Reverse running command	When this terminal is short connected with CM, the inverter will run backward	
OP8		Fault reset	Short connecting this terminal with CM under fault status to reset the inverter.	
CM	Common port	Grounding of control power supply	The grounding of 24V power supply and other control signals.	

V. Basic Parameters

F100	User's Password	Setting range: 0~9999	Mfr's value: 8
------	-----------------	-----------------------	----------------

·When F107=1 with valid password, the user must enter correct user's password after power on or fault reset if you intend to change parameters. Otherwise, parameter setting will not be possible, and a prompt "Err1" will be displayed.

F102	Inverter's Rated Current (A)	Setting range: 2.0~800.0	Mfr's value: Subject to inverter model
F103	Inverter Power (KW)	Setting range: 0.4~400	Mfr's value: Subject to inverter model
F105	Software Edition No.	Setting range: 1.00~10.00	Mfr's value: Subject to inverter model
F106	Control mode	Setting range: 0:Sensorless vector control; 1: Reserved; 2: VVVF	Mfr's value: 0

·0: Sensorless vector control is suitable for the high-performance and general cases with variable speed drive.

·2: VVVF control is suitable where there is low requirement for control precision.

F107	Password Valid or Not	Setting range: 0: invalid; 1: valid	Mfr's value: 0
F108	Setting User's Password	Setting range: 0~9999	Mfr's value: 8

·When F107 is set to 0, the function codes can be changed without inputting the password. When F107 is set to 1, the function codes can be changed only after inputting the user's password.

·The user can change "User's Password". The operation process is the same as those of changing other parameters.

·Input the value of F108 into F100, and the user's password can be unlocked. When password protection is valid, and if the user's password is not entered, F108 will display 0.

F109	Starting Frequency (Hz)	Setting range: 0.00~10.00	Mfr's value: 0.00 Hz
F110	Holding Time of Starting Frequency (S)	Setting range: 0.0~10.0	Mfr's value: 0.0
F111	Max Frequency (Hz)	Setting range: F113~650.0	Mfr's value: 50.00Hz

·The inverter begins to run from the starting frequency. After it keeps running at the starting frequency for the time as set in F110, it will accelerate to target frequency. The holding time is not included in acceleration/deceleration time.

·F111 shows the max frequency for inverter's operation. (Maximum frequency of this inverter under the mode of VVVF is 650.0Hz; maximum frequency under the mode of vector control is 150Hz.)

F112	Min Frequency (Hz)	Setting range: 0.00~F113	Mfr's value: 0.50Hz
------	--------------------	--------------------------	---------------------

·It shows the minimum frequency for inverter's operation. The set value of minimum frequency must be less than F113.

F113	Target Frequency (Hz)	Setting range: F112~F111	Mfr's value: 50.00Hz
------	-----------------------	--------------------------	----------------------

·It shows the preset frequency. Under keyboard speed control or terminal speed control mode, the inverter will run to this frequency automatically after startup.

F114	First Acceleration Time (S)	Setting range: 0.1~3000S	Mfr's value: For 0.4~3.7KW, 5.0S For 5.5~30KW, 30.0S For 37~400KW, 60.0S
F115	First Deceleration Time (S)		
F116	Second Acceleration Time (S)		Mfr's value: For 0.4~3.7KW, 8.0S For 5.5~30KW, 50.0S For 37~400KW, 90.0S
F117	Second Deceleration Time (S)		

· Acceleration/Deceleration Time: The time for inverter to accelerate (decelerate) to 50Hz (0) from 0 (50Hz)^{Note1}

F118	Turnover Frequency (Hz)	Setting range: 15.00~650.0	Mfr's value: 50.00Hz
------	-------------------------	----------------------------	----------------------

· When running frequency is lower than this value, inverter has constant-torque output. When running frequency exceeds this value, inverter has constant-power output. Normally 50Hz will be selected for turnover frequency.

F120	Forward / Reverse Switchover dead-Time (S)	Setting range: 0.0~3000	Mfr's value: 1.0S
------	--	-------------------------	-------------------

· Within “forward/ reverse switchover dead-time”, this latency time will be cancelled and the inverter will switch to run in the other direction immediately upon receiving “stop” signal. This function is suitable for all the speed control modes except automatic cycle operation.

· This function can ease the current impact in the process of direction switchover. The manufacturer's value is set at 1.0S.

F122	Reverse Running Forbidden	Setting range: 0: invalid; 1: valid	Mfr's value: 0
------	---------------------------	-------------------------------------	----------------

F124	Jogging Frequency (Hz)	Setting range: F112~F111	Mfr's value: 5.00Hz
------	------------------------	--------------------------	---------------------

F125	Jogging Acceleration Time (S)	Setting range: 0.1~3000	Mfr's value: For 0.4~3.7KW, 5.0S For 5.5~30KW, 30.0S For 37~400KW, 60.0S
F126	Jogging Deceleration Time (S)		

· There are two types of jogging: keyboard jogging and terminal jogging. Keyboard jogging is valid only under stopped status (F302 should be set). Terminal jogging is valid under both running status and stopped status.

· Carry out jogging operation through the keyboard (under stopped status):

- a. Press the “Mode” key, it will display “HF-0”;
- b. Press the “Run” key, the inverter will run to “jogging frequency” (if pressing “Mode” key again, “keyboard jogging” will be cancelled).

· In case of terminal jogging, make “jogging” terminal (such as OP1) connected to CM, and inverter will run to jogging frequency.

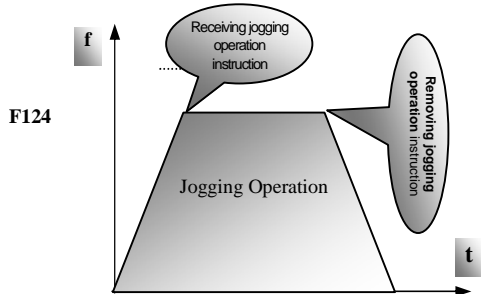

Figure 5-1 Jogging Operation

Note 1: If stalling adjusting function is selected, the set acceleration/deceleration time may not be implemented strictly during acceleration/deceleration.

F127/F129	Skip Frequency A,B (Hz)	Setting range: 0.00~650.0	Mfr's value:0.00Hz
F128/F130	Skip Width A,B (Hz)	Setting range: ± 2.5	Mfr's value: 0.0

· Systematic vibration may occur when the motor is running at a certain frequency. This parameter is set to skip this frequency.

·The inverter will skip the point automatically when output frequency is equal to the set value of this parameter.

·“Skip Width” is the span from the upper to the lower limits around Skip Frequency. For example, Skip Frequency=20Hz, Skip Width= ± 0.5 Hz, inverter will skip automatically when output is between 19.5~20.5Hz.

·This function is invalid during acceleration/deceleration.

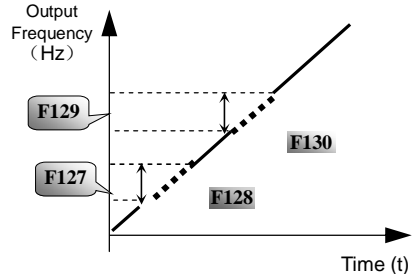

Figure 5-2 Skip Frequency

F131	Running Display Items	1—Current output rotary speed 2—Output current 4—Output voltage 8—PN voltage 16—PI feedback value 32—Temperature 64—Count value 128—Linear speed	Mfr's value: $1+2+4+8=15$
------	-----------------------	---	------------------------------

·Selection of one value from 1, 2, 4, 8, 16, 32, 64 and 128 shows that only one specific display item is selected. Should multiple display items be intended, add the values of the corresponding display items and take the total values as the set value of F131, e.g., just set F131 to be 25 (1+8+16) if you want to call “frequency”, “output current” and “function-code editing”. The other display items will be covered.

·As F131=255, all display items are visible, of which, “function-code editing” will be visible whether or not it is selected.

·Should you intend to check any display item, just press the “Mode” key for switchover.

·Refer to the following table for each specific value unit and its indication:

·Whatever the value of F131 is set to, corresponding target frequency will flash under stopped status.

Target rotary speed is an integral number. If it exceeds 9999, add a decimal point to it.

Current display A *.*

Voltage display U***

Sampled value *.*

Temperature H***

Count value ****

Linear speed L***. If it exceeds 999, add a decimal point to it. If it exceeds 9999, add two decimal points to it, and the like.

F132	Display items of stop	Setting range: 1: Keyboard jogging 2: Target rotary speed 4: PN voltage 8: PI feedback value 16: Temperature	Mfr's value: 2+4=6
F133	Drive ratio of driven system	Setting range: 0.10~200.0	Mfr's value: 1.00
F134	Transmission-wheel radius	0.001~1.000(m)	Mfr's value: 0.001

·Calculation of rotary speed and linear speed:

For example, If inverter's max frequency F111=50.00Hz, numberS of motor poles F804=4, drive ratio F133=1.00, transmission-shaft radius R=0.05m, then

Transmission shaft perimeter: $2r = 2 \times 3.14 \times 0.05 = 0.314$ (meter)

Transmission shaft rotary speed: $60 \times \text{operation frequency} / (\text{numbers of poles pairs} \times \text{drive ratio})$
 $= 60 \times 50 / (2 \times 1.00) = 1500$ rpm

Endmost linear speed: rotary speed \times perimeter = $1500 \times 0.314 = 471$ (meters/second)

F136	Slip compensation	Setting range: 0~10%	Mfr's value: 0
F137	Modes of torque compensation	Setting range: 0: Linear compensation; 1: Square compensation; 2: User-defined multipoint compensation	Mfr's value: 0
F138	Linear compensation	Setting range: 1~16	Mfr's value: subject to power 0.4-3.7: 5 5.5-30: 4 Over 37: 3
F139	Square compensation	Setting range: 1: 1.5 2: 1.8 3: 1.9 4: 2.0	Mfr's value: 1
F140	User-defined frequency point 1	Setting range: 0~F142	Mfr's value: 1.00
F141	User-defined voltage point 1	Setting range: 0~100%	Mfr's value: 4
F142	User-defined frequency point 2	Setting range: F140~F144	Mfr's value: 5.00
F143	User-defined voltage point 2	Setting range: 0~100%	Mfr's value: 13
F144	User-defined frequency point 3	Setting range: F142~F146	Mfr's value: 10.00
F145	User-defined voltage point 3	Setting range: 0~100%	Mfr's value: 24
F146	User-defined frequency point 4	Setting range: F144~F148	Mfr's value: 20.00

F147	User-defined voltage point 4	Setting range: 0~100%	Mfr's value: 45
F148	User-defined frequency point 5	Setting range: F146~F150	Mfr's value: 30.00
F149	User-defined voltage point 5	Setting range: 0~100%	Mfr's value: 63
F150	User-defined frequency point 6	Setting range: F148~F118	Mfr's value: 40.00
F151	User-defined voltage point 6	Setting range: 0~100%	Mfr's value: 81
F152	Output voltage corresponding to turnover frequency	Setting range: 10~100%	Mfr's value: 100
F153	Carrier frequency setting	Setting range: 3~10K	Mfr's value: subject to power 0.4-3.7: 8000 5.5-30: 6000 Over 37: 5000
F155	Digital accessorial frequency setting	Setting range: 0~F111	Mfr's value: 0
F156	Digital accessorial frequency polarity setting	Setting range: 0 or 1	Mfr's value: 0
F157	Reading accessorial frequency		
F158	Reading accessorial frequency polarity		

If speed control mode of accessorial frequency is digital setting memory, F155 and F156 are considered as initial set values of accessorial frequency.

In the mode of combined speed control, F157 and F158 are used for reading the value of accessorial frequency.

F160	Reverting to manufacturer values	Setting range: 0: Not reverting to manufacturer values; 1: Reverting to manufacturer values	Mfr's value: 0
------	----------------------------------	---	----------------

· Set F160 to 1 when there is disorder with inverter's parameters and manufacturer values need to be restored. After "Reverting to manufacturer values" is done, F160 values will be automatically changed to 0.

· "Reverting to manufacturer values" will not work for the function-codes marked " " in the "change" column of the parameters table. These function codes have been adjusted properly before delivery. And it is recommended not to change them.

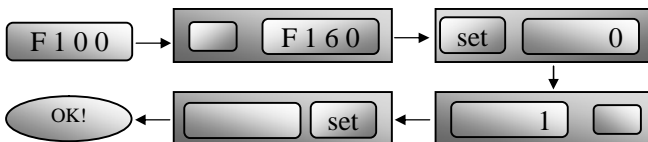

Figure 5-3 Reverting to manufacturer values

VI. Operation Control

F200 Source of start command	Setting range: 0: Keyboard command; 1: Terminal command; 2: Keyboard+Terminal; 3: MODBUS; 4: Keyboard+Terminal+MODBUS	Mfr's value: 0
F201 Source of stop command	Setting range: 0: Keyboard command; 1: Terminal command; 2: Keyboard+Terminal; 3: MODBUS; 4: Keyboard+Terminal+MODBUS	Mfr's value: 0

·"Keyboard command" refers to the start command given by the "Run" key on the keyboard. "Terminal command" refers to the start command given by the "Run" terminal defined.

·While adopting "terminal command", the inverter can be started by connecting the defined "Run" terminal with CM.

F202 Mode of direction setting	Setting range: 0: Forward running locking; 1: Reverse running locking; 2: Terminal setting	Mfr's value: 0
F203 Main frequency source X	Setting range: 0: Memory of digital given; 1: External analog AI1; 2: External analog AI2; 3: Reserved; 4: Stage speed control; 5: No memory of digital given; 6: Keyboard potentiometer; 7: Reserved; 8: Code speed control; 9: PI adjusting; 10: MODBUS	Mfr's value: 0

·0: Memory of digital given

Its initial value is the value of F113. The frequency can be adjusted through the key "up" or "down", or through the "up", "down" terminals.

"Memory of digital given" means after inverter is stop, the target frequency is the running frequency before stop. If the user would like to save target frequency in memory when the power is disconnected, please set F220 to the function of memory for power disconnection.

1: External analog AI1

The frequency is set by analog input terminal +5V. +5V is input of 0~5V voltage type.

2: External analog AI2

The frequency is set by analog input terminal AI2. AI2 is input of 0~20mA or 4~20mA current type.

4: Stage speed control

The frequency is set by multi-stage terminal or automatic cycling frequency.

5: No memory of digital given

Its initial value is the value of F113. The frequency can be adjusted through the key "up" or "down", or through the "up", "down" terminals.

“No memory of digital given” means that the target frequency restores to the value of F113 after stop.

6: Keyboard Potentiometer

The frequency is set by the analog on the control panel.

7: Reserved.

8: Code Speed Control

The frequency will be set by input terminal of code speed control.

9: PI adjusting

PI adjustment of the frequency is carried out according to the reference physical-quantity externally set.

10: MODBUS

F204 Accessorial frequency source Y	Setting range: 0: Memory of digital given; 1: External analog AI1; 2: External analog AI2; 3: Reserved; 4: Stage speed control; 5: PI adjusting; 6: Reserved	Mfr's value: 0
F205 Range selecting for accessorial frequency source Y	Setting range: 0: Relative to max frequency; 1: Relative to frequency X	Mfr's value: 1

·When combined speed control is adopted for frequency source, it is used to confirm the relative object of the setting range for the accessorial frequency.

F206 Accessorial frequency Y range	Setting range: 0~100%	Mfr's value: 100
------------------------------------	-----------------------	------------------

·The percentage of accessorial frequency range relative to relative object.

F207 Frequency source selecting	Setting range: 0: X; 1: X+Y; 2: X or Y (terminal switchover); 3: X or X+Y (terminal switchover); 4: Combination of stage speed and analog	Mfr's value: 0
---------------------------------	--	----------------

·Select the channel of setting the frequency.

·When F207=0, the frequency is set by main frequency source.

·When F207=1, the frequency is set by adding main frequency source to accessorial frequency source.

·When F207=2, main frequency source and accessorial frequency source can be switched over by frequency source switching terminal.

·When F207=3, main frequency and adding frequency setting can be switched over by frequency source switching terminal.

·When F207=4, stage speed setting of main frequency source has priority over analog setting of accessorial frequency source (only suitable for F203=4 F204=1).

PR8000

<p>F208 Terminal two-line/three-line operation control</p>	<p>Setting range: 0: other type; 1:two-line type 1; 2: two-line type 2; 3: three-line operation control 1; 4: three-line operation control 2; 5: start/stop controlled by direction impulse</p>	<p>Mfr's value: 0</p>
--	---	-----------------------

• Five modes are available for terminal operation control. As shown in Fig 5-2, “ $\frac{-}{\circ\circ}$ ” stands for switch, “ $\frac{\circ}{\circ\circ}$ ” for normally closed contact, “ $\frac{\perp}{\circ\circ}$ ” for normally open contact. “FWD”, “REV” and “X” are three terminals designated in programming OP1~OP8.

•In case of stage speed control, set F208 to 0. If F208 0 (when selecting two-line type or three-line type), F200, F201 and F202 are invalid.

Table 6-1 Terminal Control Mode

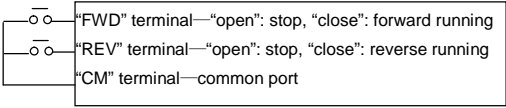
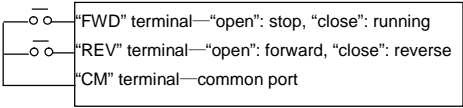
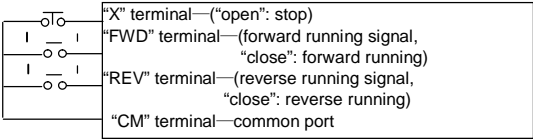
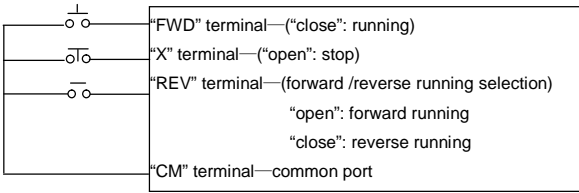
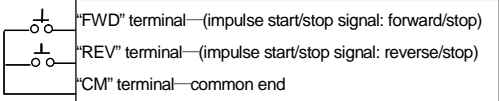
F208	Terminal Function Realized and Control-Loop Wiring
<p>1: Two-line type 1 Forward/stop Reverse/stop</p>	 <p>"FWD" terminal—"open": stop, "close": forward running "REV" terminal—"open": stop, "close": reverse running "CM" terminal—common port</p>
<p>2: Two-line type 2 Reverse/forward Running/stop</p>	 <p>"FWD" terminal—"open": stop, "close": running "REV" terminal—"open": forward, "close": reverse "CM" terminal—common port</p>
<p>3: Three-line type 1 Forward running/stop Reverse running/stop</p>	 <p>"X" terminal—"open": stop "FWD" terminal—(forward running signal, "close": forward running) "REV" terminal—(reverse running signal, "close": reverse running) "CM" terminal—common port</p>
<p>4: Three-line type 2 Forward running/stop Reverse running/stop</p>	 <p>"FWD" terminal—"close": running "X" terminal—"open": stop "REV" terminal—(forward /reverse running selection) "open": forward running "close": reverse running "CM" terminal—common port</p>
<p>5: Start/stop controlled by direction impulse Forward running/stop Reverse running/stop</p>	 <p>"FWD" terminal—(impulse start/stop signal: forward/stop) "REV" terminal—(impulse start/stop signal: reverse/stop) "CM" terminal—common end</p>

F209 Selecting the mode of stopping the motor	Setting range: 0: stop by deceleration time; 1: free stop	Mfr's value: 0
F210 Frequency display accuracy	Setting range: 0.01~2.00	Mfr's value: 0.01
F211 Speed of digital speed control	Setting range: 0.01~100.0Hz/S	Mfr's value: 5.00
F213 Selfstarting after repowered on	Setting range: 0: invalid; 1: valid	Mfr's value: 0
F214 Selfstarting or not after reset	Setting range: 0: invalid; 1: valid	Mfr's value: 0

·Set whether or not to start automatically after fault resetting. In case of fault under running status, inverter will reset automatically and self-start. In case of fault under stopped status, the inverter will only reset automatically.

F215	Selfstarting delay time	Setting range: 0.1~3000.0	Mfr's value: 60.0
F216	Times of selfstarting in case of repeated faults	Setting range: 0~5	Mfr's value: 0
F217	Delay time for fault reset	Setting range: 0.0~10.0	Mfr's value: 3.0
F220	Frequency memory after power-down	Setting range: 0: invalid; 1: valid	Mfr's value: 0

·In the mode of X+Y, stage speed will only be 3-stage speed or 15-stage speed. Only the frequency can be set, without controlling the direction. With regard to combined speed control including 3-stage speed, acceleration/deceleration time is set by the acceleration/deceleration time corresponding to relative stage speed. With regard to combined speed control including 15-stage speed, acceleration/deceleration time is set by F114 and F115.

If main frequency is set to be under auto-circulation speed control, inverter will run under the auto-circulation speed control, with 0Hz for output of accessorial frequency.

If accessorial frequency is set to be under auto-circulation speed control, inverter will run main frequency, with 0Hz for output of accessorial frequency.

If the settings of main frequency and accessorial frequency are the same, only main frequency will be valid.

·If the user selects three-line or two-line control, F200, F201 and F202 will be invalid.

·The function of frequency memory after power-down is only valid for digital set main frequency and accessorial frequency. Because the digital given accessorial frequency has positive polarity and negative polarity, it is saved in the function codes F155 and F156. F157 and F158 keep in line with accessorial frequency, and they can be used for checking accessorial frequency.

Table 6-2 Combination of Speed Control

F203 \ F204	0. Memory of digital setting	1 External analog AI1	2 External analog AI2	3 Reserved	4 Terminal stage speed control	5 PI adjusting	6 Reserved
0 Memory of Digital setting	○						
1 External analog AI1		○					
2 External analog AI2			○				
3 Reserved				○			
4 Terminal Stage speed control					○		
5 Digital setting	○	○	○	○	○	○	○
6 Keyboard potentiometer	○	○	○	○	○	○	○
7 External pulse input	○	○	○	○	○	○	○
8 Code speed control	○	○	○	○	○	○	○
9 PI adjusting						○	
10 MODBUS							

○ : Intercombination is allowable.

○ : Combination is not allowable.

The mode of automatic cycle speed control is unable to combine with other modes. If the combination includes the mode of automatic cycle speed control, only main speed control mode will be valid.

VII. Multifunctional Input and Output Terminals

F300	Relay token output	Setting range: 0: no function; 1: inverter fault protection; 2: over latent frequency 1; 3: over latent frequency 2; 4: free stop;	Mfr's value: 1
F301	DO1 token output	5: inverter is running; 6: DC braking; 7: acceleration/deceleration time switchover; 8: reserved; 9: reserved; 10: inverter overload pre-alarm; 11: motor overload pre-alarm;	Mfr's value: 4
F302	DO2 token output	12: stalling; 13~14: reserved; 15: frequency arrival output; 16: overheat pre-alarm; 17: over latent current output 18: reserved	Mfr's value: 0

12: Stalling: inverter will stop accelerating or decelerating while stalling during acceleration/deceleration and token signal is output.

15: Frequency arrival output: set the threshold through function code.

F307	Characteristic frequency 1	Setting range: F112~F111Hz	Mfr's value: 10Hz
F308	Characteristic frequency 2		Mfr's value: 50Hz
F309	Characteristic frequency width	Setting range: 0~100%	Mfr's value: 50
F310	Characteristic current	Setting range: 0~1000A	Mfr's value: Rated current
F311	Characteristic current hysteresis loop width	Setting range: 0~100%	Mfr's value: 10
F312	Frequency arrival threshold	Setting range: 0.00~5.00Hz	Mfr's value: 0.00
F316	OP1 terminal function setting	Setting range: 0: no function; 1: running terminal; 2: stop terminal;	Mfr's value: 11
F317	OP2 terminal function setting	3: multi-stage speed terminal 1; 4: multi-stage speed terminal 2; 5: multi-stage speed terminal 3;	Mfr's value: 3
F318	OP3 terminal function setting	6: multi-stage speed terminal 4; 7: reset terminal; 8: free stop terminal;	Mfr's value: 4
F319	OP4 terminal function setting	9: external emergency stop terminal; 10: acceleration/deceleration forbidden terminal; 11: forward run jogging;	Mfr's value: 5

F320 OP5 terminal function setting	12: reverse run jogging; 13: UP frequency increasing terminal; 14: DOWN frequency decreasing terminal;	Mfr's value: 8
F321 OP6 terminal function setting	15: "FWD" terminal; 16: "REV" terminal;	Mfr's value: 15
F322 OP7 terminal function setting	17: three-line type input "X" terminal; 18: acceleration/deceleration time switchover terminal;	Mfr's value: 16
F323 OP8 terminal function setting	19~20: Reserved; 21: frequency source switchover terminal; 22~30: Reserved	Mfr's value: 7

·This parameter is used for setting the function/pulse/level 0~21 corresponding to multifunctional digital input terminal.

·**Both free stop and external emergency stop of the terminal have the highest priority.**

F324 Free stop terminal logic	Setting range:	Mfr's value: 0
F325 External emergency stop terminal logic	0: positive logic (valid for low level); 1: negative logic (valid for high level)	Mfr's value: 0

VIII. Analog Input and Output

F400	Lower limit of AI1 channel input	Setting range: 0.00~F402	Mfr's value: 0.00V
F401	Corresponding setting for lower limit of AI1 input	Setting range: 0~F403	Mfr's value: 1.00
F402	Upper limit of AI1 channel input	Setting range: F400~5.00V	Mfr's value: 5.00V
F403	Corresponding setting for upper limit of AI1 input	Setting range: Max (1.00, F401) ~2.00	Mfr's value: 2.00
F404	AI1 channel proportional gain K1	Setting range: 0.0~10.0	Mfr's value: 1.0
F405	AI1 filtering time constant	Setting range: 0.1~10.0	Mfr's value: 9.0
F406	Lower limit of AI2 channel input	Setting range: 0.00~F408	Mfr's value: 0.00V
F407	Corresponding setting for lower limit of AI2 input	Setting range: 0~F409	Mfr's value: 1.00
F408	Upper limit of AI2 channel input	Setting range: F406~5.00V	Mfr's value: 5.00V
F409	Corresponding setting for upper limit of AI2 input	Setting range: Max (1.00, F407) ~2.00	Mfr's value: 2.00
F410	AI2 channel proportional gain K2	Setting range: 0.0~10.0	Mfr's value: 1.0
F411	AI2 filtering time constant	Setting range: 0.1~10.0	Mfr's value: 9.0
F412	Lower limit of AI3 channel input	Setting range: 0.00~F414	Mfr's value: 0.00V
F413	Corresponding setting for lower limit of AI3 input	Setting range: 0~F415	Mfr's value: 1.00
F414	Upper limit of AI3 channel input	Setting range: F412~5.0V	Mfr's value: 5.0V
F415	Corresponding setting for upper limit of AI3 input	Setting range: Max (1.00, F413) ~2.00	Mfr's value: 2.00
F416	AI3 channel proportional gain K1	Setting range: 0.0~10.0	Mfr's value: 1.0
F417	AI3 filtering time constant	Setting range: 0.1~10.0	Mfr's value: 9.0
F418	AI1 channel 0Hz voltage dead zone	Setting range: 0~0.50V (Positive-Negative)	Mfr's value: 0.00
F419	AI2 channel 0Hz voltage dead zone	Setting range: 0~0.50V (Positive-Negative)	Mfr's value: 0.00
F420	AI3 channel 0Hz voltage dead zone	Setting range: 0~0.50V (Positive-Negative)	Mfr's value: 0.00
F423	AO1 output range selecting	Setting range: 0: 0~5V; 1: 0~10V	Mfr's value: 0
F424	Corresponding frequency for lowest voltage of AO1 output	Setting range: 0.0~F425	Mfr's value: 0.05Hz
F425	Corresponding frequency for highest voltage of AO1 output	Setting range: F425~F111	Mfr's value: 50.00Hz
F426	AO1 output back off	Setting range: 0~120%	Mfr's value: 100
F427	AO2 output range	Setting range: 0: 0~20MA; 1: 4~20 MA	Mfr's value: 0
F428	AO2 lowest corresponding frequency	Setting range: 0.0~F429	Mfr's value: 0.05Hz
F429	AO2 highest corresponding frequency	Setting range: F428~F111	Mfr's value: 50.00

F430	AO2 output back off	Setting range: 0~120%	Mfr's value: 100
F431	AO1 analog output signal selecting	Setting range: 0: Running frequency; 1: Output current; 2: Output voltage; 3~5: Reserved	Mfr's value: 0
F432	AO2 analog output signal selecting		Mfr's value: 1
F433	Corresponding current for full range of external voltmeter	Setting range: 0.01~5.00 times of rated current	Mfr's value: 2.00
F434	Corresponding current for full range of external ammeter		Mfr's value: 2.00

· In the mode of analog speed control, sometimes it requires adjusting coincidence relation among upper limit and lower limit of input analog, analog changes and output frequency, to achieve a satisfactory speed control effect.

The unit of corresponding setting for upper limit of input and corresponding setting for lower limit of input are in percentage (%). If the value is greater than 1.00, it is positive; if the value is less than 1.00, it is negative. (e.g. F401=0.5 represents -50%).

The corresponding setting benchmark: in the mode of joint speed control, analog is the accessorial frequency and the setting benchmark for range of accessorial frequency which relates to main frequency is "main frequency X"; corresponding setting benchmark for other cases is the "max frequency", as illustrated in the right figure:

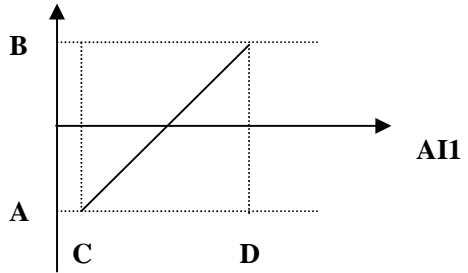

$A = (F401 - 1) * \text{setting value}$

$B = (F403 - 1) * \text{setting value}$

$C = F400$

$D = F402$

· The greater the filtering time constant is, the more stable for the analog testing. However, the precision may decrease to a certain extent. It may require appropriate adjustment according to actual application.

· 0Hz voltage dead zone will be valid when corresponding setting for lower limit of input is less than 1.00.

· F431 selects the token signal of AO1 channel; F432 selects the token signal of AO2 channel.

· In case of AO1 channel for token current, F433 is the ratio of measurement range of external voltage type ammeter to rated current of the inverter.

· In case of AO2 channel for token current, F434 is the ratio of measurement range of external current type ammeter to rated current of the inverter.

For example: measurement range of external ammeter is 20A, and rated current of the inverter is 8A, then, $F433 = 20/8 = 2.50$.

IX. Multi-stage Speed Control

F500 Stage speed type	Setting range: 0: 3-stage speed; 1: 15-stage speed; 2: Max 8-stage speed auto circulating	Mfr's value: 1
-----------------------	---	----------------

·In case of multi-stage speed control (F203=4), the user must select a mode from among “3-stage speed”, “15-stage speed” or “Max 8-stage speed auto circulating”, of which, “auto circulating” is classified into “2-stage speed auto circulating”, “3-stage speed auto circulating”, ... “8-stage speed auto circulating”, which is to be set by F501. Please refer to Table 9-1.

Table 9-1 Selection of Stage Speed Running Mode

F203	F500	Mode of Running	Description
4	0	3-stage speed control	The priority in turn is stage-1 speed, stage-2 speed and stage-3 speed. It can be combined with analog speed control. If F207=4, the priority of “3-stage speed control” is over that of analog speed control.
4	1	15-stage speed control	It can be combined with analog speed control. If F207=4, the priority of “15-stage speed control” is over that of analog speed control.
4	2	Max 8-stage speed auto circulating	Adjusting the running frequency manually is not allowable. “2-stage speed auto circulating”, “3-stage speed auto circulating”, ... “8-stage speed auto circulating” may be selected through setting the parameters.

F501	Selection of Stage Speed Under Auto-circulation Speed Control	Setting range: 2~8	Mfr's value: 7
F502	Selection of Times of Auto-circulation Speed Control	Setting range: 0~9999 (when the value is set to 0, the inverter will carry out infinite circulating)	Mfr's value: 0
F503	Status After Auto-circulation Running Finished.	Setting range: 0: Stop 1: Keep running at last stage speed	Mfr's value: 0

· That the inverter runs at the preset stage speed one by one under the auto-circulation speed control is called as “one time”.

· If F502=0, inverter will run at infinite auto circulation, which will be stopped by “stop” signal.

· If F502>0, inverter will run at auto circulation conditionally. When auto circulation of the preset times is finished continuously (set by F502), inverter will finish auto-circulation running conditionally. If F503=0, then inverter will stop after auto circulation is finished. If F503=1, then inverter will run at the speed of the last stage after auto-circulation is finished as follows:

$$F502 \begin{cases} =0, \text{ inverter will run at infinite auto circulation.} \\ >0 \begin{cases} F503=0, \text{ inverter will stop after auto circulation is finished.} \\ F503=1, \text{ run at the speed of the last stage after auto-circulation is finished.} \end{cases} \end{cases}$$

e.g., F501=3, then inverter will run at auto circulation of 3-stage speed; F502=100, then inverter will run 100 times of auto circulation; F503=1, inverter will run at the speed of the last stage after the auto-circulation running is finished. Then The inverter can be stopped by pressing “stop” or sending “stop” signal through terminal during auto-circulation running.

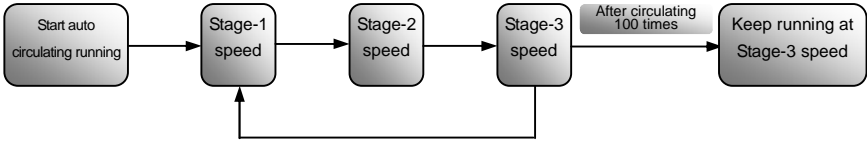

Figure 6-1 Auto Circulating Running

F504	Frequency setting for stage 1 speed	Setting range: F112~F111	Mfr's value: 5.00Hz	
F505	Frequency setting for stage 2 speed		Mfr's value: 10.00Hz	
F506	Frequency setting for stage 3 speed		Mfr's value: 15.00Hz	
F507	Frequency setting for stage 4 speed		Mfr's value: 20.00Hz	
F508	Frequency setting for stage 5 speed		Mfr's value: 25.00Hz	
F509	Frequency setting for stage 6 speed		Mfr's value: 30.00Hz	
F510	Frequency setting for stage 7 speed		Mfr's value: 35.00Hz	
F511	Frequency setting for stage 8 speed		Mfr's value: 40.00Hz	
F512	Frequency setting for stage 9 speed		Mfr's value: 5.00Hz	
F513	Frequency setting for stage 10 speed		Mfr's value: 10.00Hz	
F514	Frequency setting for stage 11 speed		Mfr's value: 15.00Hz	
F515	Frequency setting for stage 12 speed		Mfr's value: 20.00Hz	
F516	Frequency setting for stage 13 speed		Mfr's value: 25.00Hz	
F517	Frequency setting for stage 14 speed		Mfr's value: 30.00Hz	
F518	Frequency setting for stage 15 speed		Mfr's value: 35.00Hz	
F519~F526	Acceleration time setting for the speeds from Stage 1 to Stage 8		Setting range: 0.1~3000S	Mfr's value: Subject to power (Same as the first acceleration/deceleration)
F534~F541	Deceleration time setting for the speeds from Stage 1 to Stage 8		Setting range: 0.1~3000S	Mfr's value: Subject to power (Same as the first acceleration/deceleration)
F549~F556	Running directions of stage speeds from Stage 1 to Stage 8		Setting range: 0: forward running; 1: reverse running	Mfr's value: 0
F557~564	Running time of stage speeds from Stage 1 to Stage 8	Setting range: 0.1~3000S	Mfr's value: 1.0S	
F565~F572	Stop time after finishing stages from Stage 1 to Stage 8	Setting range: 0.0~3000S	Mfr's value: 0.0S	

X. Auxiliary Functions

F600 DC Braking Function Selection	Setting range: 0: not allowed; 1: braking before starting; 2: braking during stopping; 3: braking during starting and stopping	Mfr's value: 0
F601 Initial Frequency for DC Braking	Setting range: 1.00~5.00	Mfr's value: 1.00
F602 DC Braking Voltage before Starting	Setting range: 0~60	Mfr's value: 10
F603 DC Braking Voltage During Stop		
F604 Braking Lasting Time Before Starting	Setting range: 0.0~10.0	Mfr's value: 0.5
F605 Braking Lasting Time During Stopping		

· In case of fan application, adopting “braking before starting” will ensure that the fan stays in a static state before starting.

· Parameters related to “DC Braking”: F601, F602, F604 and F605, interpreted as follows:

- a. F601: Initial frequency of DC-braking. DC braking will start to work as inverter's output frequency is lower than this value.
- b. F602: DC braking voltage. The bigger value will result in a quick braking. However, motor will overheat with too big value.
- c. F604: Braking duration before starting. The time lasted for DC braking before inverter starts.
- d. F605: Braking duration when stopping. The time lasted for DC braking while inverter stops.

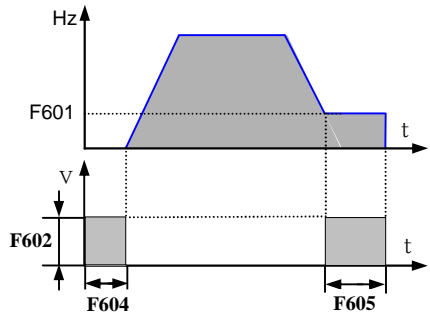

Figure 9-2 DC Braking

·DC braking, as shown in Figure 9-2.

F607 Selection of Stalling Adjusting Function	Setting range: 0: invalid; 1: valid	Mfr's value: 0
F608 Stalling Current Adjusting (%)	Setting range: 120~200	Mfr's value: 160
F609 Stalling Voltage Adjusting (%)	Setting range: 120~200	Mfr's value: 140
F610 Stalling Protection Judging Time	Setting range: 0.1~3000.0	Mfr's value: 5.0
F611 Energy Consumption Brake Point	Setting range: 200~1000	Mfr's value: Three-phase 710V, Single-phase 380V
F612 Discharging percentage	Setting range: 0~100%	Mfr's value: 50

·If stalling is judged during acceleration/deceleration, the acceleration/deceleration process will be stopped. When the cumulative time reaches the time as set in F610, it will display OL1 for protection.

·In case of stalling during stable speed running, the frequency will drop. If the current returns to normal during dropping, the frequency will return to rise. Otherwise, the frequency will keep dropping to the minimum frequency and the protection will occur after it lasts for the time as set in F610.

·Accessory function is valid only in case of F106=2.

XI. Timing Control and Protection

F700	Selection of terminal free stop mode	Setting range: 0: free stop immediately; 1: delayed free stop	Mfr's value: 0
F701	Delay time of free stop and programmable terminal motion	Setting range: 0.0~60.0S	Mfr's value: 0.0

·“Timing control” mainly refers to “Timing free stop” and “Timing motion” of corresponding output terminal. For example:

·“Selection of free stop mode” can be used only for the mode of “free stop” controlled by the terminal. When “free stop immediately” is selected, delay time (F701) will be invalid. When delay time is set to 0 (i.e. F701=0), it means “free stop immediately”.

·“Delayed free stop” means that upon receiving “free stop” signal, the inverter will execute “free stop” command after waiting some time instead of stopping immediately. Delay time is set by F701.

F705	Overloading Adjusting Gains	Setting range: 0~100	Mfr's value: 0
F706	Inverter Overloading Coefficient %	Setting range: 120~190	Mfr's value: 150
F707	Motor Overloading Coefficient %	Setting range: 20~100	Mfr's value: 100

· **Overloading Coefficient:** the ratio of overload-protection current and rated current, whose value shall be subject to actual load.

F708	Record of The Latest Malfunction Type		
F709	Record of Malfunction Type for Last but One		
F710	Record of Malfunction Type for Last but Two		
F711	Fault Frequency of The Latest Malfunction		
F712	Fault Current of The Latest Malfunction		
F713	Fault PN End Voltage of The Latest Malfunction		

F714	Fault Frequency of Last Malfunction but One		
F715	Fault Current of Last Malfunction but One		
F716	Fault PN End Voltage of Last Malfunction but One		
F717	Fault Frequency of Last Malfunction but Two		
F718	Fault Current of Last Malfunction but Two		
F719	Fault PN End Voltage of Last Malfunction but Two		
F720	Record of overcurrent protection fault times		
F721	Record of overvoltage protection fault times		
F722	Record of overheat protection fault times		
F723	Record of overload protection fault times		
F724	Input out-phase	Setting range: 0: invalid; 1: valid	Mfr's value: 1
F725	Undervoltage	Setting range: 0: invalid; 1: valid	Mfr's value: 1
F726	Overheat	Setting range: 0: invalid; 1: valid	Mfr's value: 1
F728	Input out-phase filtering constant	Setting range: 0.1~60.0	Mfr's value: 5.0
F729	Undervoltage filtering constant	Setting range: 0.1~60.0	Mfr's value: 5.0
F730	Overheat protection filtering constant	Setting range: 0.1~60.0	Mfr's value: 5.0

•“Undervoltage” refers to too low voltage at AC input side. “Out-phase” refers to out-phase of three-phase power supply.

•“Undervoltage” / “out-phase” signal filtering constant is used for the purpose of eliminating disturbance to avoid mis-protection. The greater the set value is, the longer the filtering time constant is and the better for the filtering effect.

XII. Parameters of the Motor

F800	Motor's parameters selection	Setting range: 0: no parameter measurement; 1: running parameter measurement; 2: static parameter measurement	Mfr's value: 0
F801	Rated power	Setting range: 0.2~1000KW	
F802	Rated voltage	Setting range: 1~440V	
F803	Rated current	Setting range: 0.1~6553A	
F804	Number of motor poles	Setting range: 2~100	4
F805	Rated rotary speed	Setting range: 1~30000	

•Please set the parameters in accordance with those indicated on the nameplate of the motor.

•Excellent control performance of vector control requires accurate parameters of the motor. Accurate parameter derives from correct setting of rated parameters of the motor.

•In order to get the excellent control performance, please configure the motor in accordance with adaptable motor of the inverter. In case of too large difference between the actual power of the motor and that of adaptable motor for inverter, the inverter's control performance will decrease remarkably.

•F800=0, no parameter measurement.

After being powered on, it will use default parameters of the motor (see the values of F806-F809) according to the motor power set in F801. This value is only a reference value in view of Y series 4-pole asynchronous motor.

•F800=1, running parameter measurement.

In order to ensure dynamic control performance of the inverter, select "running motor parameter measurement" after ensuring that the motor is disconnected from the load. Please set F801-805 correctly prior to running testing.

Operation flow of running parameter measurement: Press the "Run" key on the keyboard to display "TEST", and it will measure the motor's static parameter of two stages. After that, the motor will accelerate according to acceleration time set at F114 and maintain it for a certain period. The motor will then decelerate to 0 according to the time set at F115. After self-checking is completed, relevant parameters of the motor will be stored in function codes F806~F809, and F800 will turn to 0 automatically.

•F800=2, static parameter measurement.

It is suitable for the cases where it is impossible to disconnect the motor from the load.

Press the "Run" key, and the inverter will display "TEST", and it will measure the motor's static parameter of two stages. The motor's stator resistance, rotor resistance and leakage inductance will be stored in F806-F809 automatically (the motor's mutual inductance uses default value generated according to the power), and F800 will turn to 0 automatically. The user may also calculate and input the

motor's mutual inductance value manually according to actual conditions of the motor. With regard to calculation formula and method, please call us for consultation.

***Note:** No matter which measurement method of motor parameter is adopted, please set the information of the motor (F802-F805) correctly according to the nameplate of the motor.

If the operator is quite familiar with the motor, the operator may input all the parameters (F806-F809) of the motor manually.

Incorrect parameters of the motor may result in unstable running of the motor or even failure of normal running. Correct measurement of the parameters is a fundamental guarantee of vector control performance.

Each time when F801 rated power of the motor is changed, the parameters of the motor (F806-F809) will be refreshed to default settings automatically. Therefore, please be careful while amending this parameter.

The motor's parameters may change when the motor heats up after running for a long time. If the load can be disconnected, we recommend self-checking before each running.

F806	Stator resistance	Setting range: 0.001~65.53	
F807	Rotor resistance	Setting range: 0.001~65.53	
F808	Leakage inductance	Setting range: 0.001~9.999H	
F809	Mutual inductance	Setting range: 0.001~9.999H	

·The set values of F806~F809 will be updated automatically after normal completion of parameter measurement of the motor.

·The inverter will restore the parameter values of F806~F809 automatically to default standard parameters of the motor each time after changing F801 rated power of the motor; (4-pole Y series asynchronous motor)

·If it is impossible to measure the motor at the site, input the parameters manually by referring to the known parameters of a similar motor.

F813	Rotary speed loop P1	Setting range: 0.01~10.00	Mfr's value: 5.00
F814	Rotary speed loop I1	Setting range: 0.1~20.0	Mfr's value: 1.00
F815	Rotary speed loop P2	Setting range: 0.01~10.00	Mfr's value: 2.00
F816	Rotary speed loop I2	Setting range: 0.01~2.00	Mfr's value: 0.50
F817	Rotary speed loop P3	Setting range: 0.01~10.00	Mfr's value: 2.00
F818	Rotary speed loop I3	Setting range: 0.01~2.00	Mfr's value: 0.15
F819	Rotary speed loop P4	Setting range: 0.01~10.00	Mfr's value: Subject to inverter's model
F820	Rotary speed loop I4	Setting range: 0.01~2.00	Mfr's value: Subject to inverter's model
F821	Rotary speed loop P5	Setting range: 0.01~10.00	Mfr's value: Subject to inverter's model
F822	Rotary speed loop I5	Setting range: 0.01~2.00	Mfr's value: Subject to inverter's model

The values of F813-F814 are proportional and storage gains of speed loop when rotary speed is lower than or equals to 2Hz.

The values of F815-F816 are proportional and storage gains of speed loop when rotary speed is more than 2Hz and lower than or equals to 50Hz.

The values of F817-F818 are proportional and storage gains of speed loop when rotary speed is more than 50Hz and lower than or equals to 80Hz.

The values of F819-F820 are proportional and storage gains of speed loop when rotary speed is more than 80Hz and lower than or equals to 100Hz.

The values of F821-F822 are proportional and storage gains of speed loop when rotary speed is more than 100Hz.

Dynamic response of vector control speed can be adjusted through adjusting proportional and storage gains of speed loop. Increasing either proportional gain or storage gain can speed up dynamic response of speed loop. However, if proportional gain or storage gain is too large, it may give rise to oscillation.

Recommended adjusting procedures:

Make fine adjustment of the value on the basis of manufacturer value. Be cautious that amplitude of adjustment each time should not be too large.

In the event of weak loading capacity or slow rising of rotary speed, please increase proportional gain first under the precondition of ensuring no oscillation. If it is stable, please increase storage gain properly to speed up response.

In the event of oscillation of current or rotary speed, decrease proportional gain and storage gain properly.

If it is impossible to make any judgment, decrease KP first. If no effect occurs, increase KP then. And adjust KI after KP is adjusted properly.

Note: Improper setting of PI may result in violent oscillation of the system, or even failure of normal operation. Please set PI carefully, and call the manufacturer for consultation if necessary.

F827 Study frequency	Setting range: 10.00~40.00	Mfr's value: 20.00
----------------------	----------------------------	--------------------

Running frequency of the motor in case of F800=1.

XIII. Communication Parameter

F900 Communication Address	1~247: single inverter address 0: broadcast address	1
F901 Communication Mode	1: ASCII 2: RTU	1
F903 Odd/Even Calibration	Setting range: 0: no calibration 1: odd calibration 2: even calibration	0
F904 Baud Rate	Setting range: 0: 1200; 1: 2400; 2: 4800; 3: 9600; 4: 19200	1

Communication parameters refer to Appendix 4.

XIV. PI Parameters

FA00 Polarity	0: positive feedback 1: negative feedback	0
FA01 Reference Source	0: Given Digit 1: AI1 2: AI2 3~5: Reserved	0
FA02 Given Digit Reference Source	0.0~100.0	50.0
FA03 Feedback Source	0: AI1 1: AI2 2~5: Reserved	0
FA04 Proportion Coefficient	0.0~100.0	20.0
FA05 Integral Time	0.1~10.0S	2.0
FA06 Precision	0.0~20.0	0.1
FA07 Show Value of Min Feedback	0~9999	0
FA08 Show Value of Max Feedback	0~9999	1000

Appendix 1 Trouble Shooting

When malfunction occurs to inverter, don't run by resetting immediately. Check any causes and get it removed if there is any.

Take counter measures by referring to this manual in case of any malfunctions on inverter. Should it still be unsolved, contact the manufacturer. Never attempt any repairing without due authorization.

Table 1-1 **Inverter's Common Cases of Malfunctions**

Fault	Description	Causes	Countermeasures
O.C.	Overcurrent	* too short acceleration time * short circuit at output side * locked rotor with motor	*prolong acceleration time; *whether motor cable is broken; *check if motor overloads; *reduce V/F compensation value
O.L1	Inverter Overload	* load too heavy	*reduce load; *check drive ratio; *increase inverter's capacity
O.L2	Motor Overload	* load too heavy	*reduce load; *check drive ratio; *increase inverter's capacity
O.E.	DC Over-Voltage	*supply voltage too high; *load inertia too big *deceleration time too short; *motor inertia rise again	*check if rated voltage is input; *add braking resistance(optional); *increase deceleration time
P.F1.	Input Out-Phase	*out-phase with input power	*check if power input is normal; *check if parameter setting is correct.
L.U.	Under-Voltage Protection	*input voltage on the low side	*check if supply voltage is normal *check if parameter setting is correct.
O.H.	Radiator Overheat	*environment temperature too high; *radiator too dirty *install place not good for ventilation; *fan damaged	*improve ventilation; *clean air inlet and outlet and radiator; *install as required; *change fan
C.B.	Contactore does not suck	*Too low voltage of power network *AC contactore damaged	*check the voltage *check the AC contactore
Motor not Running		*wrong wiring; *wrong setting; * too heavy load;	*check input, output and control line; *check parameter setting; *increase inverter's output capacity
Power Trips	Line-Current Too Big	*short circuit at input side; *too small capacity with air switch; *motor overload	*check input line; *check air switch capacity; *reduce load

* No P.F1. Protection for single-phase and three-phase under 4.0KW.

* C.B. Protection only for inverters from 30KW to 400KW.

Table 1-2 **Motor Malfunction and Counter Measures**

Malfunction	Items to Be Checked	Counter Measures
Motor not Running	Supply voltage is on or normal? Normal with U,V,W 3-phase output? Locked rotor with motor? Panel with trouble indication?	Get connected with power; Check wiring; Disconnect and Reconnect; Reduce load; Check against Table 1-1
Wrong Direction of Motor Running	U, V, W wiring correct?	To correct wiring
Motor Turning but Speed Change not Possible	Wiring correct for lines with given frequency? Correct setting of running mode? Too big with load?	To correct wiring; To correct setting; Reduce load
Motor Speed Too High or Too Low	Motor's rated value correct? Drive ratio correct? Max output frequency value correct? Check if voltage drops between motor terminals too high?	Check motor nameplate data; Check speed change mechanism; Check setting; Check V/F Characteristic value
Motor Running Unstable	Too big load? Too big with load change? Single-phase or 3-phase for power? Out-phase? Motor malfunction.	Reduce load; reduce load change, increase capacity; Reactor to be added for single -phase power input. Correct wiring.

Appendix 2 Products & Structures

PR8000 series inverter has its power range between 0.4~400KW. Refer to Tables 2-1 and 2-2 for main data. There may be two (or more than two) kinds of structures for certain products. Please make a clear indication when placing your order.

Inverter should operate under the rated output current, with overload permitted for a short time. However, it shall not exceed the allowable values at working time.

Table 2-1 **Product Summary of PR8000**

Model	Applicable Motor (kw)	Rated Current Output (A)	Structure Code	Cooling Mode	Remarks
PR8000-0004S2G	0.4	2.5	B0	Self-cooling	Single-Phase Plastic Hanging
PR8000-0004XS2G	0.4	2.5	B0	Self-cooling	
PR8000-0007S2G	0.75	4.5	B0	Air Cooling	
PR8000-0007XS2G	0.75	4.5	B0	Air Cooling	
PR8000-0015S2G	1.5	7	B2	Air Cooling	
PR8000-0015XS2G	1.5	7	B2	Air Cooling	
PR8000-0022S2G	2.2	10	B3	Air Cooling	Three-Phase Plastic Hanging
PR8000-0007T3G	0.75	2	B2	Air Cooling	
PR8000-0015T3G	1.5	4	B2	Air Cooling	
PR8000-0022T3G	2.2	6.5	B2	Air Cooling	
PR8000-0037T3G	3.7	8	B4	Air Cooling	
PR8000-0040T3G	4.0	9	B4	Air Cooling	
PR8000-0055T3G	5.5	12	B5	Air Cooling	
PR8000-0075T3G	7.5	17	B5	Air Cooling	

PR8000-0110T3G	11	23	C1	Air Cooling	Three-Phase Metal Hanging
PR8000-0150T3G	15	32	C2	Air Cooling	
PR8000-0185T3G	18.5	38	C3	Air Cooling	
PR8000-0220T3G	22	44	C3	Air Cooling	
PR8000-0300T3G	30	60	C4	Air Cooling	
PR8000-0370T3G	37	75	C5	Air Cooling	
PR8000-0450T3G	45	90	C5	Air Cooling	
PR8000-0550T3G	55	110	C6	Air Cooling	
PR8000-0750T3G	75	150	C6	Air Cooling	
PR8000-0900T3G	90	180	C7	Air Cooling	
PR8000-1100T3G	110	220	C7	Air Cooling	
PR8000-1320T3G	132	265	C8	Air Cooling	
PR8000-1600T3G	160	320	C8	Air Cooling	
PR8000-1100T3G	110	220	D0	Air Cooling	Three-Phase Metal Cabinet
PR8000-1320T3G	132	265	D1	Air Cooling	
PR8000-1600T3G	160	320	D1	Air Cooling	
PR8000-2000T3G	200	400	D2	Air Cooling	
PR8000-2200T3G	220	440	D2	Air Cooling	
PR8000-2500T3G	250	480	D3	Air Cooling	
PR8000-2800T3G	280	520	D3	Air Cooling	
PR8000-3150T3G	315	550	D3	Air Cooling	
PR8000-3550T3G	355	595	D3	Air Cooling	
PR8000-4000T3G	400	650	D4	Air Cooling	

Note: The “X” in the PR8000-0004XS2G, PR8000-0007XS2G and PR8000-0015XS2G is built-in braking unit!

Table 2-2 PR8000 Types of Product Structure

Structure Code	External Dimension (A×B×H)	Mounting Size(W×L)	Mounting Bolt	Remarks
B0	105×120×150	94×139	M4	Plastic Housing
B2	125×140×170	114×160	M5	
B3	143×148×200	132×187	M5	
B4	162×150×250	145×233	M5	
B5	200×160×300	182×282	M6	
C1	225×220×340	160×322	M6	Metal Hanging
C2	230×225×380	186×362	M6	
C3	265×235×435	235×412	M6	
C4	314×235×480	274×464	M6	
C5	360×265×555	320×530	M8	
C6	410×300×630	370×600	M10	
C7	516×326×760	360×735	M12	
C8	560×326×1000	390×970	M12	
D0	580×500×1410	410×300	M16	Metal Cabinet
D1	600×500×1650	400×300	M16	
D2	660×500×1950	450×300	M16	
D3	800×600×2045	520×340	M16	
D4	1000×550×2000	800×350	M16	

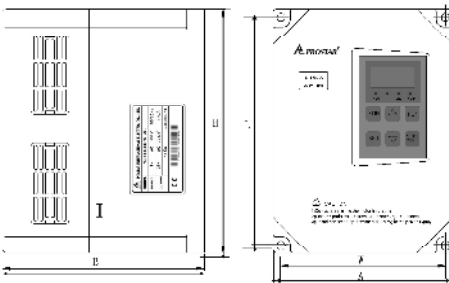

Fig 3-1 Plastic Profile

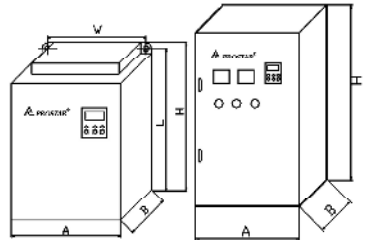

Fig 3-2 Metal Profile

Appendix 3 Selection of Braking Resistance

Inverter Models	Applicable Motor Power (KW)	Applicable Braking Resistance
PR8000-00004XS2G	0.4	Al Housing 150W/60
PR8000-00007XS2G	0.75	Al Housing 150W/60
PR8000-00015XS2G	1.5	Al Housing 150W/60
PR8000-0007T3G	0.75	Al Housing 80W/200
PR8000-0015T3G	1.5	Al Housing 80W/150
PR8000-0022T3G	2.2	Al Housing 150W/150
PR8000-0037T3G	3.7	
PR8000-0040T3G	4.0	
PR8000-0055T3G	5.5	Al Housing 250W/120
PR8000-0075T3G	7.5	Al Housing 500W/120
PR8000-0110T3G	11	Al Housing 1KW/90
PR8000-0150T3G	15	Al Housing 1.5KW/80

Appendix 4 Communication Manual

(Version 1.6)

I. General

Modbus is a serial and asynchronous communication protocol. Modbus protocol is a general language applied to PLC and other controlling units. This protocol has defined an information structure which can be identified and used by a controlling unit regardless of whatever network they are transmitted.

You can read reference books or ask for the details of MODBUS from manufactures.

Modbus protocol does not require a special interface while a typical physical interface is RS485.

II. Modbus Protocol

1. Overall Description

(1) Transmission mode

1) ASCII Mode

In ASCII mode, one Byte (hexadecimal format) is expressed by two ASCII characters.

For example, 31H (hexadecimal data) includes two ASCII characters '3'(33H)', '1'(31H)'.

Common characters, ASCII characters are shown in the following table:

Characters	'0'	'1'	'2'	'3'	'4'	'5'	'6'	'7'
ASCII Code	30H	31H	32H	33H	34H	35H	36H	37H
Characters	'8'	'9'	'A'	'B'	'C'	'D'	'E'	'F'
ASCII Code	38H	39H	41H	42H	43H	44H	45H	46H

2) RTU Mode

In RTU mode, one Byte is expressed by hexadecimal format. For example, 31H is delivered to data packet.

(2) Baud rate

Setting range: 1200, 2400, 4800, 9600, 16200

(3) Frame structure:

1) ASCII mode

Byte	Function
1	Start Bit (Low Level)
7	Data Bit
0/1	Parity Check Bit (None for this bit in case of no checking. Otherwise 1 bit)
1/2	Stop Bit (1 bit in case of checking, otherwise 2 bits)

2) RTU mode

Byte	Function
1	Start Bit (Low Level)
8	Data Bit
0/1	Parity Check Bit (None for this bit in case of no checking. Otherwise 1 bit)
1/2	Stop Bit (1 bit in case of checking, otherwise 2 bits)

(4) Error Check

1) ASCII mode

Longitudinal Redundancy Check (LRC): It is performed on the ASCII message field contents excluding the 'colon' character that begins the message, and excluding the CRLF pair at the end of the message.

The LRC is calculated by adding together successive 8-bit bytes of the message, discarding any carries, and then two's complementing the result.

A procedure for generating an LRC is:

1. Add all bytes in the message, excluding the starting 'colon' and ending CRLF. Add them into an 8-bit field, so that carries will be discarded.
2. Subtract the final field value from FF hex (all 1's), to produce the ones-complement.
3. Add 1 to produce the two's-complement.

2) RTU Mode

Cyclical Redundancy Check (CRC): The CRC field is two bytes, containing a 16-bit binary value.

The CRC is started by first preloading a 16-bit register to all 1's. Then a process begins of applying successive 8-bit bytes of the message to the current contents of the register. Only the eight bits of data in each character are used for generating the CRC. Start and stop bits, and the parity bit, do not apply to the CRC.

A procedure for generating a CRC-16 is:

1. Load a 16-bit register with FFFF hex (all 1's). Call this the CRC register.
2. Exclusive OR the first 8-bit byte of the message with the high-order byte of the 16-bit CRC register, putting the result in the CRC register.
3. Shift the CRC register one bit to the right (toward the LSB), zero-filling the MSB. Extract and examine the LSB.
4. (If the LSB was 0): Repeat Step 3 (another shift).
- (If the LSB was 1): Exclusive OR the CRC register with the polynomial value A001 hex (1010 0000 0000 0001).
5. Repeat Steps 3 and 4 until 8 shifts have been performed. When this is done, a complete 8-bit byte will have been processed.

When the CRC is appended to the message, the low-order byte is appended first, followed by the high-order byte.

2. Command Type & Format

(1) The listing below shows the function codes.

code	name	description
03	Read Holding Registers	Read the binary contents of holding registers in the slave. (Less than 10 registers once time)
06	Preset Single Register	Preset a value into holding register

(2) Format

1) ASCII mode

Start	Address	Function	Data				LRC check		End	
:	Inverter	Function	Data	Data	...	Data	High-order	Low-order	Return	Line Feed
(0X3A)	Address	Code	Length	1	...	N	byte of LRC	byte of LRC	(0X0D)	(0X0A)

2) RTU mode

Start	Address	Function	Data	CRC check		End
T1-T2-T3-T4	Inverter Address	Function Code	N data	Low-order byte of CRC	High-order byte of CRC	T1-T2-T3-T4

3) Protocol Converter

It is easy to turn a RTU command into an ASCII command followed by the lists:

- 1) Use the LRC replacing the CRC.
- 2) Transform each byte in RTU command into a corresponding two byte ASCII. For example: transform 0x03 into 0x30, 0x33 (ASCII code for 0 and ASCII code for 3).
- 3) Add a 'colon' (:) character (ASCII 3A hex) at the beginning of the message.
- 4) End with a 'carriage return – line feed' (CRLF) pair (ASCII 0D and 0A hex).

So we will introduce RTU Mode in followed part. If you use ASCII mode, you can use the up lists to convert.

(3) Address and meaning

The part introduces inverter running, inverter status and related parameters setting.

Description of rules of function codes parameters address:

- 1) Use the function code as parameter address

General Series:

High-order byte: 01~0A (hexadecimal)

Low-order byte: 00~50 (max range) (hexadecimal) Function code range of each partition is not the same. The specific range refers to manual.

For example: F114 (display on the board), parameter address is 010E (hexadecimal).

F201 (display on the board), parameter address is 0201 (hexadecimal).

Note: in this situation, it allows to read six function codes and write only one function code. Some function codes can only be checked but cannot be modified; some function codes can neither be checked nor be modified; some function codes can not be modified in run state; some function codes can not be modified both in stop and run state.

In case parameters of all function codes are changed, the effective range, unit and related instructions shall refer to user manual of related series of inverters. Otherwise, unexpected results may occur.

2) Use different parameters as parameter address

(The above address and parameters descriptions are in hexadecimal format, for example, the decimal digit 4096 is represented by hexadecimal 1000).

1. Running status parameters

Parameters Address	Parameter Discription (read only)
1000	Output frequency
1001	Output voltage
1002	Output current
1003	Pole numbers/ control mode, high-order byte is pole numbers, low-order byte is control mode.
1004	Bus-line voltage
1005 ---PR8000	Drive ratio/inverter status High-order byte is drive ratio, low-order byte is inverter status Inverter status: 00: Standby mode 01: Forward running 02: Reverse running 04: Over-current (OC) 05: DC over-current (OE) 06: Input Out-phase (PF1) 07: Frequency Over-load (OL1) 08: Under-voltage (LU) 09: Overheat (OH) 0A: Motor overload (OL2) 0B: Interference (ERR) 0C: LL 0D: External Malfunction (ESP) 0E: ERR1 0F: ERR2

2. Control commands

Parameters Address	Parameters Discription (write only)
2000	Command meaning: 0001: Forward running (no parameters) 0002: Reverse running (no parameters) 0003: Deceleration stop 0004: Free stop 0005: Forward jogging start 0006: Forward jogging stop 0007: Reserved

PR8000

	0008: Run (no directions) 0009: Fault reset 000A: Forward jogging stop 000B: Reverse jogging stop
2001	Lock parameters 0001: Relieve system locked (remote control locked) 0002: Lock remote control (any remote control commands are no valid before unlocking)

Command types of PR8000 series do not belong to every inverter models.

3. Illegal Response When Reading Parameters

Command Discription	Function	Data
Slave parameters response	The highest-order byte changes into 1.	Command meaning: 0001: Illegal function code 0002: Illegal address 0003: Illegal data 0004: Slave fault 0005: Slave busy 0008: Parity check fault

The following is response command when read/write parameters:

Eg1: In RTU mode, change acc time (F114) to 10.0s in NO.01 inverter.

Query

Address	Function	Register Address Hi	Register Address Lo	Preset Data Hi	Preset Data Lo	CRC Lo	CRC Hi
01	06	01	0E	00	64	E8	1E

Function code F114

Value: 10.0S

Normal Response

Address	Function	Register Address Hi	Register Address Lo	Response Data Hi	Response Data Lo	CRC Lo	CRC Hi
01	06	01	0E	00	64	E8	1E

Function code F114

Normal Response

Abnormal Response

Address	Function	Abnormal code	CRC Lo	CRC Hi
01	86	04	43	A3

The max value of function code is 1. Slave fault

Eg 2: Read output frequency, output voltage, output current and current rotate speed from N0.2 inverter.

Host Query

Address	Function	First Register Address Hi	First Register Address Lo	Register count Hi	Register count L0	CRC Lo	CRC Hi
02	03	10	00	00	04	40	FA

Communication Parameters Address 1000H

Slave Response:

Address	Function	Byte Count	Data Hi	Data Lo	Data Hi	Data Lo	Data Hi	Data Lo	Data Hi	Data Lo	Crc Lo	Crc Hi
02	03	08	13	88	01	7C	00	3C	02	05	82	F6

Output Frequency Output Voltage Output Current Numbers of Pole Pairs Control Mode

NO.2 Inverter's output frequency is 50.00Hz, output voltage is 380V, output current is 6.0A, numbers of pole pairs are 2 and control mode PC/PLC control.

Eg 3: NO.1 Inverter runs forwardly.

Host Query:

Address	Function	Register Hi	Register Lo	Write status Hi	Write status Lo	CRC Lo	CRC Hi
01	06	20	00	00	01	43	CA

Communication parameters address 2000H Forward running

Slave Normal Response:

Address	Function	Register Hi	Register Lo	Write status Hi	Write status Lo	CRC Lo	CRC Hi
01	06	20	00	00	01	43	CA

Normal Response

Slave Abnormal Response:

Address	Function	Abnormal Code	CRC Lo	CRC Hi
01	86	01	83	A0

The max value of function code is 1. Illegal function code (assumption)

Eg4: Read the value of F113, F114 from NO.2 inverter

Host Query:

Address	Function	Register Address Hi	Register Address Lo	Register Count Hi	Register Count L0	CRC Lo	CRC Hi
02	03	01	0D	00	02	54	07

Communication Parameter Address F10DH Numbers of Read Registers

Slave Normal Response:

Address	Function	Byte count	The first parameters status Hi	The first parameters status Lo	The second parameters status Hi	The second parameters status Lo	CRC Lo	CRC Hi
02	03	04	03	E8	00	78	49	61

The actual value is 10.00.

The actual value is 12.00.

Slave Abnormal Response:

Address	Function Code	Abnormal Code	CRC Lo	CRC Hi
02	83	08	B0	F6

The max value of function code is 1.

Parity check fault

3. Additional Remarks**Expressions during communication course:**

Parameter Values of Frequency=actual value X 100 (General Series)

Parameter Values of Frequency=actual value X 10 (Medium Frequency Series)

Parameter Values of Time=actual value X 10

Parameter Values of Current=actual value X 10

Parameter Values of Voltage=actual value X 1

Parameter Values of Power=actual value X 100

Parameter Values of Drive Ratio=actual value X 100

Parameter Values of Version No. =actual value X 100

Instruction: Parameter value is the value sent in the data package. Actual value is the actual value of inverter. After PC/PLC receives the parameter value, it will divide the corresponding coefficient to get the actual value.

NOTE: Take no account of radix point of the data in the data package when PC/PLC transmits command to inverter. The valid value is range from 0 to 65535.

Function Codes Related to Communication

Function Code	Function Definition	Setting Rang	Mfr's Value
F900	Inverter Address	1~247	1
F901	Modbus Mode Selection	1: ASCII mode 2: RTU mode	1
F903	Parity Check Selection	0: No checkout 1: Odd 2: Even	0
F904	Baud Rate	0: 1200 1: 2400 2: 4800 3: 9600 4: 19200	1

You can read device status, function codes value, “write” control command and “write” function operation preset functions value regardless of control mode.

Please set functions code related to communication consonant with the PLC/PC communication parameters, when inverter communicates with PLC/PC.

Physical Interface

1. Interface instruction

Communication interface of RS485 is located on the most left of control terminals, marked underneath with A+ and B-

2. Structure of Field Bus

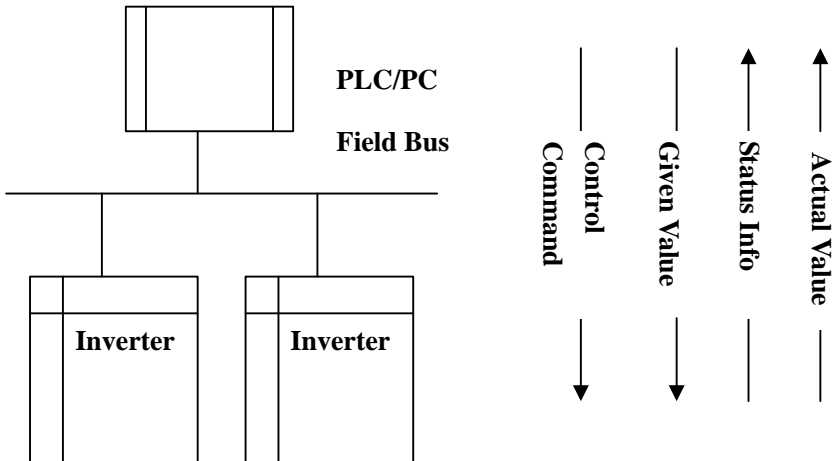

Connecting Diagram of Field Bus

RS485 Half-duplex communication mode is adopted for PR8000 series inverter. Daisy chain structure is adopted by 485 Bus-line. Do not use 'spur' lines or a star configuration. Reflect signals which are produced by spur lines or star configuration will interfere in 485 communications.

Please note that for the same time in half-duplex connection; only one inverter can have communication with PC/PLC. Should two or more than two inverters upload data at the same time, then bus competition will occur, which will not only lead to communication failure, but higher current to certain elements as well.

3. Grounding and Terminal

Terminal resistance of $120\ \Omega$ will be adopted for terminal of RS485 network, to diminish the reflection of signals. Terminal resistance shall not be used for intermediate network.

No direct grounding shall be allowed for any point of RS485 network. All the equipment in the network shall be well grounded via their own grounding terminal. Please note that grounding wires will not form closed loop in any case.

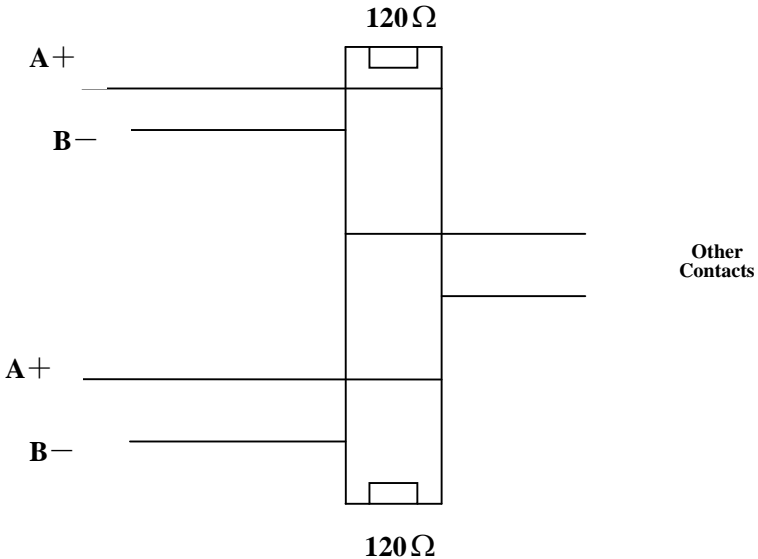

Connecting Diagram of Terminal Resistance

Please think over the drive capacity of PC/PLC and the distance between PC/PLC and inverter when wiring. Add a repeaters if drive capacity is not enough.



All wiring connections for installation shall have to be made when the inverter is disconnected from power supply.

Appendix 5 Zoom Table of Function Code

Function Section	Function Code	Function Definition	Setting Range	Mfr's Value	Change
Basic Parameters	F100	User's Password	0~9999	8	
	F102	Inverter's Rated Current (A)	2.0~800.0	Subject to inverter model	*
	F103	Inverter Power (KW)	0. 40~1000. 0	Subject to inverter model	*
	F104	Inverter Power Code	100~400	Subject to inverter model	*
	F105	Software Edition No.	1.00~10.00	Subject to inverter model	*
	F106	Control mode	Setting range: 0: Speedless sensor vector control; 1: Reserved; 2: VVVF	0	<input type="checkbox"/>
	F107	Password Valid or Not	0: invalid; 1: valid	0	
	F108	Setting User's Password	0~9999	8	
	F109	Starting Frequency (Hz)	0.0~10.00Hz	0.00Hz	
	F110	Holding Time of Starting Frequency (S)	0.0~10.0S	0.0	
	F111	Max Frequency (Hz)/v	F113~650.0Hz	50.00Hz	
	F112	Min Frequency (Hz)	0.00Hz~F113	0.50Hz	
	F113	Target Frequency (Hz)	F111~F112	50.00Hz	
	F114	1 st Acceleration Time	0.1~3000S	5.0S for 0.4~3.7KW 30.0S for 5.5~30KW 60.0S for over 37KW	
	F115	1 st Deceleration Time	0.1~3000S		
	F116	2 nd Acceleration Time	0.1~3000S		
	F117	2 nd Deceleration Time	0.1~3000S		
	F118	Turnover Frequency	15.00~650.0Hz	50.00	×
	F119	Reserved			
	F120	Forward/Reverse Switchover dead-Time	0.0~3000S	1.0S	
	F121	Reserved			
	F122	Reverse Running Forbidden	0: invalid; 1: valid	0	×
	F123	Reserved			
	F124	Jogging Frequency	F112~F111	5.00Hz	
	F125	Jogging Acceleration Time	0.1~3000S	5.0S	
	F126	Jogging Deceleration Time	0.1~3000S	5.0S	

Basic Parameters	F127	Skip Frequency A	0.00~650.0Hz	0.00Hz	
	F128	Skip Width A	±2.50Hz	0.00	
	F129	Skip Frequency B	0.00~650.0Hz	0.00Hz	
	F130	Skip Width B	±2.50Hz	0.00	
	F131	Running Display Items	1—Current output rotary speed 2—Output current 4—Output voltage 8—PN voltage 16—PI feedback value 32—Temperature 64—Count value 128—Linear speed	1+2+4+8=15	
	F132	Display items of stop	1: Keyboard jogging 2: Target rotary speed 4: PN voltage 8: PI feedback value 16: Temperature	2+4=6	
	F133	Drive Ratio of Driven System	0.10~200.0	1.0	
	F134	Transmission-wheel radius	0.001~1.000 (m)	0.001	
	F135	Reserved			
	F136	Slip compensation	0~10%	0	×
	F137	Modes of torque compensation	0: Linear compensation; 1: Square compensation; 2: User-defined multipoint compensation	0	×
	F138	Linear compensation	1~16	subject to power 0.4-3.7: 5 5.5-30: 4 Over 37: 3	×
	F139	Square compensation	1: 1.5; 2: 1.8; 3: 1.9; 4: 2.0	1	×
	F140	User-defined frequency point 1	0~F142	1.00	×
	F141	User-defined voltage point 1	0~100%	4	×
	F142	User-defined frequency point 2	F140~F144	5.00	×
F143	User-defined voltage point 2	0~100%	13	×	

Basic Parameters	F144	User-defined frequency point 3	F142~F146	10.00	×
	F145	User-defined voltage point 3	0~100%	24	×
	F146	User-defined frequency point 4	F144~F148	20.00	×
	F147	User-defined voltage point 4	0~100%	45	×
	F148	User-defined frequency point 5	F146~F150	30.00	×
	F149	User-defined voltage point 5	0~100%	63	×
	F150	User-defined frequency point 6	F148~F118	40.00	×
	F151	User-defined voltage point 6	0~100%	81	×
	F152	Output voltage corresponding to turnover frequency	10~100%	100	×
	F153	Carrier frequency setting	3~10K	Subject to power: 0.4-3.7: 8000 5.5-30: 6000 Over 37: 5000	×
	F154	Auto voltage adjusting	0: no adjusting 1: adjusting	0	×
	F155	Digital accessory frequency setting	0~F111	0	×
	F156	Digital accessory frequency polarity setting	0 or 1	0	×
	F157	Reading accessory frequency			
	F158	Reading accessory frequency polarity			
F159	Reserved				
F160	Reverting to manufacturer values	0: Not reverting to manufacturer values; 1: Reverting to manufacturer values	0	×	
Running Control Mode	F200	Source of start command	0: Keyboard command; 1: Terminal command; 2: Keyboard+Terminal; 3:MODBUS; 4: Keyboard +Terminal+MODBUS	0	×
	F201	Source of stop command	0: Keyboard command; 1: Terminal command; 2: Keyboard+Terminal; 3:MODBUS; 4: Keyboard +Terminal+MODBUS	0	×

Running Control Mode	F202	Mode of direction setting	0: Forward running locking; 1: Reverse running locking; 2: Terminal setting	0	×
	F203	Main frequency source X	0: Digital setting memory; 1: External analog AI1; 2: External analog AI2; 3: Reserved; 4: Stage speed control; 5: No memory by digital setting; 6: Keyboard potentiometer; 7: Reserved; 8: Code speed control; 9: PI adjusting; 10: MODBUS	0	×
	F204	Accessorial frequency source Y	0: Digital setting memory; 1: External analog AI1; 2: External analog AI2; 3: Reserved; 4: Stage speed control; 5: PI adjusting; 6: Reserved	0	×
	F205	Range selecting for accessorial frequency source Y	0: Relative to max frequency; 1: Relative to frequency X	1	×
	F206	Accessorial frequency Y range	0~100%	100	×
	F207	Frequency source selecting	0: X; 1: X+Y; 2: X or Y (terminal switchover); 3: X or X+Y (terminal switchover); 4: Combination of stage speed and analog	0	×
	F208	Terminal two-line/three-line operation control	0: other type; 1: two-line type 1; 2: two-line type 2; 3: three-line operation control 1; 4: three-line operation control 2; 5: start/stop controlled by direction impulse	0	×
	F209	Selecting the mode of stopping the motor	0: stop by deceleration time; 1: free stop	0	×
	F210	Frequency display accuracy	0.01~2.00	0.01	
	F211	Speed of digital speed control	0.01~100.00Hz/S	5.00	
	F212	Reserved			
	F213	Selfstarting after repowered on	0: invalid; 1: valid	0	
	F214	Selfstarting or not after reset	0: invalid; 1: valid	0	

Running Control Mode	F215	Selfstarting delay time	0.1~3000.0	60.0		
	F216	Times of selfstarting in case of repeated faults	0~5	0		
	F217	Delay time for fault reset	0.0~10.0	3.0		
	F218~F219	Reserved				
	F220	Frequency memory after power-down	0: invalid; 1: valid	0		
	F221~F230	Reserved				
Function Section	Function Code	Function Definition	Setting Range	Mfr's Value	Change	
Multifunctional Input and Output Terminals	F300	Relay token output	0: no function; 1: inverter fault protection; 2: over latent frequency 1; 3: over latent frequency 2; 4: free stop; 5: inverter is running; 6: DC braking; 7: acceleration/deceleration time switchover;	1		
	F301	DO1 token output		8: reserved; 9: reserved;	4	
	F302	DO2 token output		10: inverter overload pre-alarm; 11: motor overload pre-alarm; 12: stalling; 13~14: reserved; 15: frequency arrival output; 16: overheat pre-alarm; 17: over latent current output 18: reserved	0	
	F303	Selection of FP pulse output range	1~20K	20K		
	F304	Min frequency for FP full range output	50.00~650.0Hz	50.00Hz		
	F305	FP output compensation	0~100	0		
	F306	Duty cycle of output pulse	0~100%	50%		
	F307	Characteristic frequency 1	F112~F111	10.00Hz		
	F308	Characteristic frequency 2	F112~F111	50.00Hz		
	F309	Characteristic frequency width	0~100%	50%		
F310	Characteristic current	0~1000A	Rated current			

Multifunctional Input and Output Terminals	F311	Characteristic current hysteresis loop width	0~100%	10%	
	F312	Frequency arrival threshold	0.00~5.00Hz	0.00	
	F316	OP1 terminal function setting	0: no function; 1: running terminal; 2: stop terminal;	11	
	F317	OP2 terminal function setting	3: multi-stage speed terminal 1; 4: multi-stage speed terminal 2; 5: multi-stage speed terminal 3;	3	
	F318	OP3 terminal function setting	6: multi-stage speed terminal 4; 7: reset terminal;	4	
	F319	OP4 terminal function setting	8: free stop terminal; 9: external emergency stop terminal; 10: acceleration/deceleration	5	
	F320	OP5 terminal function setting	forbidden terminal; 11: forward run jogging; 12: reverse run jogging;	8	
	F321	OP6 terminal function setting	13: UP frequency increasing terminal; 14: DOWN frequency decreasing terminal; 15: "FWD" terminal;	15	
	F322	OP7 terminal function setting	16: "REV" terminal; 17: three-line type input "X" terminal; 18: acceleration/deceleration time	16	
	F323	OP8 terminal function setting	switchover terminal; 19: Reserved; 20: Reserved; 21: frequency source switchover terminal; 22~30: Reserved	7	
	F324	Free stop terminal logic	0: positive logic (valid for low level);	0	×
	F325	External emergency stop terminal logic	1: negative logic (valid for high level)	0	×
	F326	Input frequency of max pulse	0~9999	5000	
	F327	Corresponding frequency for max input pulse frequency	50.00~650.0Hz	50.00	
	F328	Terminal filter times	1~100	5	
	F329~F330	Reserved			

Function Section	Function Code	Function Definition	Setting Range	Mfr's Value	Change
Analog Input and Output	F400	Lower limit of AI1 channel input	0.00~F402	0.00V	
	F401	Corresponding setting for lower limit of AI1 input	0~F403	1.00	
	F402	Upper limit of AI1 channel input	F400~5.00V	5.00V	
	F403	Corresponding setting for upper limit of AI1 input	Max (1.00, F401) ~2.00	2.00	
	F404	AI1 channel proportional gain K1	0.0~10.0	1.0	
	F405	AI1 filtering time constant	0.1~10.0	9.0	
	F406	Lower limit of AI2 channel input	0.00~F408	0.00V	
	F407	Corresponding setting for lower limit of AI2 input	0~F409	1.00	
	F408	Upper limit of AI2 channel input	F406~5.00V	5.00V	
	F409	Corresponding setting for upper limit of AI2 input	Max (1.00, F407) ~2.00	2.00	
	F410	AI2 channel proportional gain K2	0.0~10.0	1.0	
	F411	AI2 filtering time constant	0.1~10.0	9.0	
	F412	Lower limit of AI3 channel input	0.00~F414	0.00V	
	F413	Corresponding setting for lower limit of AI3 input	0~F415	1.00	
	F414	Upper limit of AI3 channel input	F412~5.0V	5.0V	
	F415	Corresponding setting for upper limit of AI3 input	Max (1.00, F413) ~2.00	2.00	
	F416	AI3 channel proportional gain K1	0.0~10.0	1.0	
	F417	AI3 filtering time constant	0.1~10.0	9.0	
	F418	AI1 channel 0Hz voltage dead zone	0~0.50V (Positive-Negative)	0.00	
	F419	AI2 channel 0Hz voltage dead zone	0~0.50V (Positive-Negative)	0.00	
	F420	AI3 channel 0Hz voltage dead zone	0~0.50V (Positive-Negative)	0.00	
	F421~F422	Reserved			
	F423	AO1 output range selecting	0: 0~5V; 1: 0~10V	0	
	F424	Corresponding frequency for lowest voltage of AO1 output	0.0~F425	0.05Hz	

Analog Input and Output	F425	Corresponding frequency for highest voltage of AO1 output	F425~F111	50.00Hz	
	F426	AO1 output back off	0~120%	100	
	F427	AO2 output range	0: 0~20mA; 1: 4~20mA	0	
	F428	AO2 lowest corresponding frequency	0.0~F429	0.05Hz	
	F429	AO2 highest corresponding frequency	F428~F111	50.00	
	F430	AO2 output back off	0~120%	100	
	F431	AO1 analog output signal selecting	0: Running frequency; 1: Output current; 2: Output voltage; 3~5: Reserved	0	
	F432	AO2 analog output signal selecting		1	
	F433	Corresponding current for full range of external voltmeter	0.01~5.00 times of rated current	2	×
	F434	Corresponding current for full range of external ammeter		2	×
	F435~F440	Reserved			
Function Section	Function Code	Function Definition	Setting Range	Mfr's Value	Change
Multi-stage Speed Control	F500	Stage speed type	0: 3-stage speed; 1: 15-stage speed; 2: Max 8-stage speed auto circulating	1	×
	F501	Selection of Stage Speed Under Auto-circulation Speed Control	2~8	7	
	F502	Selection of Times of Auto-Circulation Speed Control	0~9999 (when the value is set to 0, the inverter will carry out infinite circulating)	0	
	F503	Status after Auto-circulation running Finished	0: Stop 1: Keep running at last stage speed	0	
	F504	Frequency setting for stage 1 speed	F112~F111	5.00Hz	
	F505	Frequency setting for stage 2 speed	F112~F111	10.00Hz	
	F506	Frequency setting for stage 3 speed	F112~F111	15.00Hz	
	F507	Frequency setting for stage 4 speed	F112~F111	20.00Hz	
	F508	Frequency setting for stage 5 speed	F112~F111	25.00Hz	

Multi-stage Speed Control	F509	Frequency setting for stage 6 speed	F112~F111	30.00Hz	
	F510	Frequency setting for stage 7 speed	F112~F111	35.00Hz	
	F511	Frequency setting for stage 8 speed	F112~F111	40.00Hz	
	F512	Frequency setting for stage 9 speed	F112~F111	5.00Hz	
	F513	Frequency setting for stage 10 speed	F112~F111	10.00Hz	
	F514	Frequency setting for stage 11 speed	F112~F111	15.00Hz	
	F515	Frequency setting for stage 12 speed	F112~F111	20.00Hz	
	F516	Frequency setting for stage 13 speed	F112~F111	25.00Hz	
	F517	Frequency setting for stage 14 speed	F112~F111	30.00Hz	
	F518	Frequency setting for stage 15 speed	F112~F111	35.00Hz	
	F519	Acceleration time setting for the speeds for Stage 1	0.1~3000S	Subject to power (Same as the first acceleration/deceleration)	
	F520	Acceleration time setting for the speeds for Stage 2	0.1~3000S		
	F521	Acceleration time setting for the speeds for Stage 3	0.1~3000S		
	F522	Acceleration time setting for the speeds for Stage 4	0.1~3000S		
	F523	Acceleration time setting for the speeds for Stage 5	0.1~3000S		
	F524	Acceleration time setting for the speeds for Stage 6	0.1~3000S		
	F525	Acceleration time setting for the speeds for Stage 7	0.1~3000S		
	F526	Acceleration time setting for the speeds for Stage 8	0.1~3000S		
	F534	Deceleration time setting for the speeds for Stage 1	0.1~3000S		
	F535	Deceleration time setting for the speeds for Stage 2	0.1~3000S		Subject to power (Same as the first acceleration/deceleration)
F536	Deceleration time setting for the speeds for Stage 3	0.1~3000S			
F537	Deceleration time setting for the speeds for Stage 4	0.1~3000S			
F538	Deceleration time setting for the speeds for Stage 5	0.1~3000S			
F539	Deceleration time setting for the speeds for Stage 6	0.1~3000S			

Multi-stage Speed Control	F540	Deceleration time setting for the speeds for Stage 7	0.1~3000S		
	F541	Deceleration time setting for the speeds for Stage 8	0.1~3000S		
	F542~F548	Reserved			
	F549	Running directions of stage speeds for Stage 1.	0: forward running; 1: reverse running	0	
	F550	Running directions of stage speeds for Stage 2.	0: forward running; 1: reverse running	0	
	F551	Running directions of stage speeds for Stage 3.	0: forward running; 1: reverse running	0	
	F552	Running directions of stage speeds for Stage 4.	0: forward running; 1: reverse running	0	
	F553	Running directions of stage speeds for Stage 5.	0: forward running; 1: reverse running	0	
	F554	Running directions of stage speeds for Stage 6.	0: forward running; 1: reverse running	0	
	F555	Running directions of stage speeds for Stage 7.	0: forward running; 1: reverse running	0	
	F556	Running directions of stage speeds for Stage 8.	0: forward running; 1: reverse running	0	
	F557	Running time of stage speeds for Stage 1.	0.1~3000S	1.0S	
	F558	Running time of stage speeds for Stage 2.	0.1~3000S	1.0S	
	F559	Running time of stage speeds for Stage 3.	0.1~3000S	1.0S	
	F560	Running time of stage speeds for Stage 4.	0.1~3000S	1.0S	
	F561	Running time of stage speeds for Stage 5.	0.1~3000S	1.0S	
	F562	Running time of stage speeds for Stage 6.	0.1~3000S	1.0S	
	F563	Running time of stage speeds for Stage 7.	0.1~3000S	1.0S	
	F564	Running time of stage speeds for Stage 8.	0.1~3000S	1.0S	
	F565	Stop time after finishing stages for Stage 1.	0.0~3000S	0.0S	
F566	Stop time after finishing stages for Stage 2.	0.0~3000S	0.0S		
F567	Stop time after finishing stages for Stage 3.	0.0~3000S	0.0S		
F568	Stop time after finishing stages for Stage 4.	0.0~3000S	0.0S		

	F569	Stop time after finishing stages for Stage 5.	0.0~3000S	0.0S	
	F570	Stop time after finishing stages for Stage 6.	0.0~3000S	0.0S	
	F571	Stop time after finishing stages for Stage 7.	0.0~3000S	0.0S	
	F572	Stop time after finishing stages for Stage 8.	0.0~3000S	0.0S	
	F573~F580	Reserved			
Function Section	Function Code	Function Definition	Setting Range	Mfr's Value	Change
Auxiliary Functions	F600	DC Braking Function Selection	0: not allowed; 1: braking before starting; 2: braking during stopping; 3: braking during starting and stopping	0	
	F601	Initial Frequency for DC Braking	1.00~5.00	1.00	
	F602	DC Braking Voltage before Starting	0~60	10	
	F603	DC Braking Voltage During Stop	0~60	10	
	F604	Braking Lasting Time Before Starting	0.0~10.0	0.5	
	F605	Braking Lasting Time During Stopping	0.0~10.0	0.5	
	F606	Wait time for Stop and Braking	0~3000.0	1.0	
	F607	Selection of Stalling Adjusting Function	0: invalid; 1: valid	0	
	F608	Stalling Current Adjusting (%)	120~200	160	
	F609	Stalling Voltage Adjusting (%)	120~200	140	
	F610	Stalling Protection Judging Time	0.1~3000.0	5.0	
	F611	Energy Consumption Brake Point	200~1000	710V	
	F612	Discharging percentage	0~100%	50	×
F613-F630	Reserved				
Function Section	Function Code	Function Definition	Setting Range	Mfr's Value	Change
Timing Control and Protection	F700	Selection of terminal free stop mode	0: free stop immediately; 1: delayed free stop	0	
	F701	Dealy time of free stop and programmable terminal motion	0.0~60.0s	0.0	
	F702~F704	Reserved			
	F705	Overloading Adjusting Gains	0~100	0	×
	F706	Inverter Overloading Coefficient %	120~190	150	×

Timing Control and Protection	F707	Motor Overloading Coefficient %	20~100	100	×
	F708	Record of The Latest Malfunction Type			
	F709	Record of Malfunction Type for Last but One			
	F710	Record of Malfunction Type for Last but Two			
	F711	Fault Frequency of The Latest Malfunction			
	F712	Fault Current of The Latest Malfunction			
	F713	Fault PN End Voltage of The Latest Malfunction			
	F714	Fault Frequency of Last Malfunction but One			
	F715	Fault Current of Last Malfunction but One			
	F716	Fault PN End Voltage of Last Malfunction but One			
	F717	Fault Frequency of Last Malfunction but Two			
	F718	Fault Current of Last Malfunction but Two			
	F719	Fault PN End Voltage of Last Malfunction but Two			
	F720	Record of overcurrent protection fault times			
	F721	Record of overvoltage protection fault times			
	F722	Record of overheat protection fault times			
	F723	Record of overload protection fault times			
	F724	Input out-phase	0: invalid; 1: valid	1	×
	F725	Undervoltage	0: invalid; 1: valid	1	×
	F726	Overheat	0: invalid; 1: valid	1	×
	F727	Reserved			
	F728	Input out-phase filtering constant	0.1~60.0	5.0	
	F729	Undervoltage filtering constant	0.1~60.0	5.0	
	F730	Overheat protection filtering constant	0.1~60.0	5.0	
	F731	Output Out-phase 1			×
	F732	Output Out-phase 2			×
	F733	Output Out-phase 3			×
	F734~F740	Reserved			

Function Section	Function Code	Function Definition	Setting Range	Mfr's Value	Change
Parameters of the Motor	F800	Motor's parameters selection	0: no parameter measurement; 1: rotating parameter measurement; 2: static parameter measurement	0	×
	F801	Rated power	0.2~1000KW		×
	F802	Rated voltage	1~440V		×
	F803	Rated current	0.1~6553A		×
	F804	Number of motor poles	2~100	4	×
	F805	Rated rotary speed	1~30000		×
	F806	Stator resistance	0.001~65.53		×
	F807	Rotor resistance	0.001~65.53		×
	F808	Leakage inductance	0.001~9.999H		×
	F809	Mutual inductance	0.001~9.999H		×
	F810	Reserved			
	F813	Rotary speed loop P1	0.01~10.00	5.00	
	F814	Rotary speed loop I1	0.1~20.0	1.00	
	F815	Rotary speed loop P2	0.01~10.00	2.00	
	F816	Rotary speed loop I2	0.01~2.00	0.50	
	F817	Rotary speed loop P3	0.01~10.00	2.00	
	F818	Rotary speed loop I3	0.01~2.00	0.15	
	F819	Rotary speed loop P4	0.01~10.00	Subject to inverter's model	
	F820	Rotary speed loop I4	0.01~2.00	Subject to inverter's model	
	F821	Rotary speed loop P5	0.01~10.00	Subject to inverter's model	
	F822	Rotary speed loop I5	0.01~2.00	Subject to inverter's model	
	F823~F826	Reserved			
	F827	Study Frequency	10.00~40.00	20.00	×
F828~F830	Reserved				
Communication Parameter	F900	Communication Address	1~247: single inverter address 0: broadcast address	1	
	F901	Communication Mode	1: ASII; 2: RTU	1	
	F902	Reserved			
	F903	Odd/Even Calibration	0: no calibration 1: odd calibration 2: even calibration		
	F904	Baud Rate	0: 1200; 1: 2400; 2: 4800; 3: 9600; 4: 19200	1	
	F905~F930	Reserved			

PI Parameters	FA00	Polarity	0: positive feedback 1: negative feedback	0	×
	FA01	Reference Source	0: Given Digit 1: AI1 2: AI2 3~5: Reserved	0	×
	FA02	Given Digit Reference Source	0.0~100.0	50.0	
	FA03	Feedback Source	0: AI1 1: AI2 2~5: Reserved	0	×
	FA04	Proportion Coefficient	0.0~100.0	20.0	
	FA05	Integral Time	0.1~10.0S	2.0	
	FA06	Precision	0.0~20.0	0.1	
	FA07	Show Value of Min Feedback	0~9999	0	
	FA08	Show Value of Max Feedback	0~9999	1000	
	FA09~FA30	Reserved			

Note: × indicating that function code can only be modified in stop state.
 indicating that function code can be modified both in stop and run state.
 indicating that function code can only be checked in stop or run state but cannot be modified.
 indicating that function code cannot be initialized as inverter restores manufacturer's value but can only be modified manually.