



Touch Panels with TFT-Display

User manual

User manual

Touch Panels with TFT-Display

2019-03-05

Designation: UM EN BTP 2XXXX

Revision: 02

Order No.: —

This user manual is valid for:

Designation	Order No.
BTP 2043W	1050387
BTP 2070W	1046666
BTP 2102W	1046667

How to contact us

Internet

Up-to-date information on Phoenix Contact products and our Terms and Conditions can be found on the Internet at:

phoenixcontact.com

Make sure you always use the latest documentation.

It can be downloaded at:

phoenixcontact.net/products

Subsidiaries

If there are any problems that cannot be solved using the documentation, please contact your Phoenix Contact subsidiary.

Subsidiary contact information is available at phoenixcontact.com.

Published by

PHOENIX CONTACT GmbH & Co. KG
Flachsmarktstraße 8
32825 Blomberg
GERMANY

Should you have any suggestions or recommendations for improvement of the contents and layout of our manuals, please send your comments to

tecdoc@phoenixcontact.com

General terms and conditions of use for technical documentation

Phoenix Contact reserves the right to alter, correct, and/or improve the technical documentation and the products described in the technical documentation at its own discretion and without giving prior notice, insofar as this is reasonable for the user. The same applies to any technical changes that serve the purpose of technical progress.

The receipt of technical documentation (in particular user documentation) does not constitute any further duty on the part of Phoenix Contact to furnish information on modifications to products and/or technical documentation. You are responsible to verify the suitability and intended use of the products in your specific application, in particular with regard to observing the applicable standards and regulations. All information made available in the technical data is supplied without any accompanying guarantee, whether expressly mentioned, implied or tacitly assumed.

In general, the provisions of the current standard Terms and Conditions of Phoenix Contact apply exclusively, in particular as concerns any warranty liability.

This manual, including all illustrations contained herein, is copyright protected. Any changes to the contents or the publication of extracts of this document is prohibited.

Phoenix Contact reserves the right to register its own intellectual property rights for the product identifications of Phoenix Contact products that are used here. Registration of such intellectual property rights by third parties is prohibited.

Other product identifications may be afforded legal protection, even where they may not be indicated as such.

BTP 2XXXX

PHOENIX CONTACT

Table of Contents

1	Important Notes	7
	1.1 Symbols	7
	1.2 Safety Notes	7
	1.3 Intended Use	8
	1.4 Target Group	8
2	Installation and Commissioning	9
	2.1 Unpacking the Device.....	9
	2.2 Mounting the Device.....	10
	2.2.1 Mounting Cutout	11
	2.2.2 Side View, Mounting Depth	14
	2.3 Connecting the Device	17
	2.3.1 Supply Voltage	17
	2.4 Switching On	18
	2.4.1 Settings and Functions	19
	2.5 Visualization	25
	2.5.1 System Variables	26
	2.6 Identification	28
3	Control and Display Elements	29
	3.1 Touchscreen	29
	3.2 Display.....	29
4	Interfaces of the Device	31
	4.1 USB (HOST).....	32
	4.1.1 Cable	32
	4.2 USB (SLAVE)	32
	4.2.1 Cable	32
	4.3 Ethernet.....	33
	4.3.1 Pin Assignment	33
	4.3.2 Cable	33
	4.4 RS-232 / RS-422 / RS-485 (COM1/COM2)	34
	4.4.1 Pin Assignment	34
	4.5 Memory Card.....	35
	4.6 Shielding D-SUB Connectors	35
5	Maintenance and Servicing	37
	5.1 Maintenance Interval	37

5.2	Front Panel	37
5.3	Battery	37
6	Technical Data	39
6.1	General.....	39
6.2	BTP 2043W	41
6.3	BTP 2070W	42
6.4	BTP 2102W	43

1 Important Notes

1.1 Symbols

The symbols in this manual are used to draw your attention on notes and dangers.



This symbol indicates hazards that could lead to personal injury.

There are three signal words indicating the severity of a potential injury.

DANGER

Indicates a hazard with a high risk level. If this hazardous situation is not avoided, it will result in death or serious injury.

WARNING

Indicates a hazard with a medium risk level. If this hazardous situation is not avoided, it could result in death or serious injury.

CAUTION

Indicates a hazard with a low risk level. If this hazardous situation is not avoided, it could result in minor or moderate injury.



This symbol together with the **NOTE** signal word alerts the reader to a situation which may cause damage or malfunction to the device, hardware/software, or surrounding property.



Here you will find additional information or detailed sources of information.

1.2 Safety Notes

- Read this manual carefully before using the operating device. Keep this manual in a place where it is always accessible to all users.
- Proper transportation, handling and storage, placement and installation of this product are prerequisites for its subsequent flawless and safe operation.
- This user manual contains the most important information for the safe operation of the device.
- The user manual, in particular the safety notes, must be observed by all personnel working with the device.
- Observe the accident prevention rules and regulations that apply to the operating site.
- Installation and operation must only be carried out by qualified and trained personnel.

The following notes apply to use in hazardous locations (UL / cUL Class I, Division 2, Groups A, B, C and D). Suitable operating devices for this area are labeled accordingly. In addition, the approvals for your operating device can be found in the technical data in the user manual.



WARNING: Explosion hazard

Labeled and approved devices are suitable for use in Class I, Division 2, Groups A, B, C and D or non-hazardous locations only.

Do not disconnect while the circuit is live or unless the area is known to be free of ignitable concentrations.

Substitution of components may impair suitability for Class I, Division 2.

USB ports may only be connected or disconnected in an area known to be non-hazardous.

This product contains batteries, they must only be changed in an area known to be non-hazardous and may only be replaced by qualified service personal.

1.3 Intended Use

- The device is designed for use in the industry.
- The device is state-of-the art and has been built to the latest standard safety requirements. However, dangerous situations or damage to the machine itself or other property can arise from the use of this device.
- The device fulfills the requirements of the EMC directives and harmonized European standards. Any modifications to the system can influence the EMC behavior.



NOTICE: Radio Interference

Operation of this device may cause radio interference in residential areas.

1.4 Target Group

The use of products described in this manual is oriented exclusively to:

- Qualified electricians or persons instructed by them. The users must be familiar with the relevant safety concepts of automation technology as well as applicable standards and other regulations.
- Qualified application programmers and software engineers. The users must be familiar with the relevant safety concepts of automation technology as well as applicable standards and other regulations.

2 Installation and Commissioning

2.1 Unpacking the Device

Unpack all parts carefully and check the contents for any visible damage in transit. Also check whether the shipment matches the specifications on your delivery note.

If you notice damages in transit or discrepancies, please contact us immediately.

2.2 Mounting the Device



NOTICE: Damage

When installing the device, leave a gap of at least 30 mm (1.181") around the device to ensure sufficient air circulation.



NOTICE: Damage

When the operating device is installed horizontally, please note that additional sources of heat beneath the operating device may result in heat accumulation.

Make sure to allow sufficient heat dissipation!

Please observe the permissible temperature range specified in the technical data when operating the device.



NOTICE: Damage

In order to ensure the degree of protection specified in the technical data, observe the following points:

- A tolerance of +0,5 / -0 mm is maintained for the mounting cutout.
- The seal lies flat against the mounting surface.
- All mounting brackets are used.
- The threaded pins of the mounting brackets are tightened uniformly to a maximum torque of 0,4 Nm.

The device enables quick and easy mounting. A panel thickness of 1 mm to 6 mm is permitted for proper mounting.

1. Cut the mounting cutout in the housing for the device size to be installed.

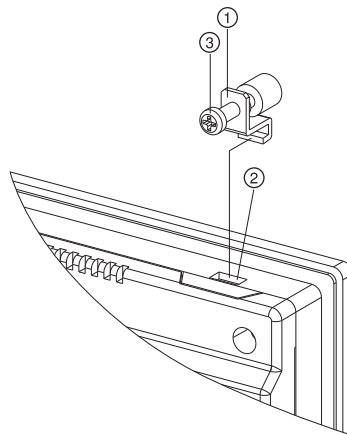

Figure 2-1 Mounting the device using a mounting clamp

2. Push the device from the front through the mounting cutout.
3. Ensure that the gasket is properly positioned in the groove and against the panel.
4. Insert the mounting clamps (1) into the recesses (2) provided.
5. Tighten the screws (3) on all mounting clamps, alternating from one side to the other until the front bezel is secure against the installation surface. Torque the screws to 0,4 Nm.

2.2.1 Mounting Cutout

2.2.1.1 BTP 2043W

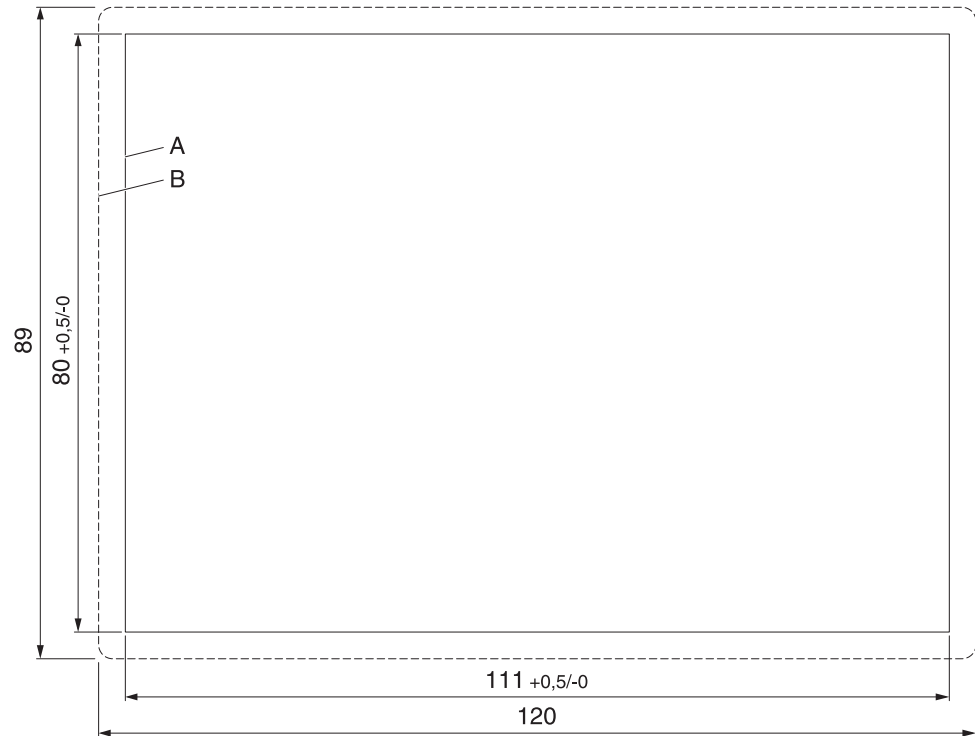

Figure 2-2 Mounting cutout (dimensions in mm)

A Mounting Cutout

B Front Panel

2.2.1.2 BTP 2070W

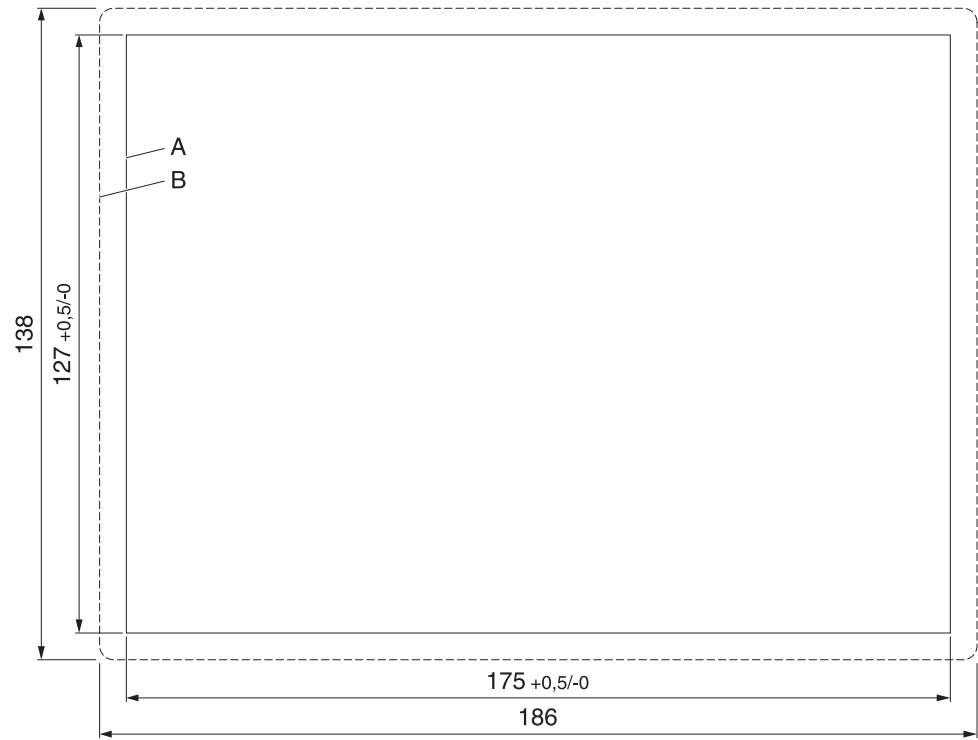

Figure 2-3 Mounting cutout (dimensions in mm)

- A Mounting Cutout
- B Front Panel

2.2.1.3 BTP 2102W

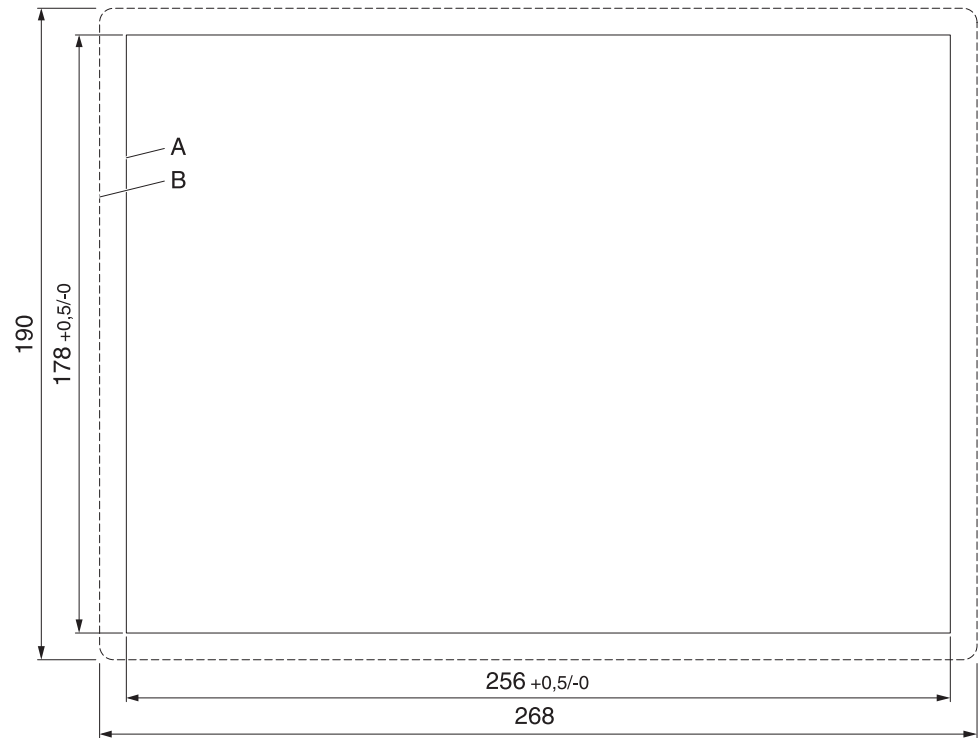

Figure 2-4 Mounting cutout (dimensions in mm)

- A** Mounting Cutout
- B** Front Panel

2.2.2 Side View, Mounting Depth

2.2.2.1 BTP 2043W

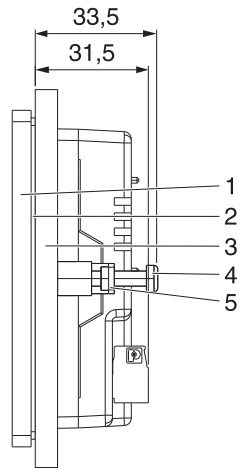

Figure 2-5 Mounting depth (dimensions in mm)

- 1 Front Panel
- 2 Circumferential Seal
- 3 Mounting Surface Thickness 1 mm to 6 mm
- 4 Screw
- 5 Mounting Bracket

2.2.2.2 BTP 2070W

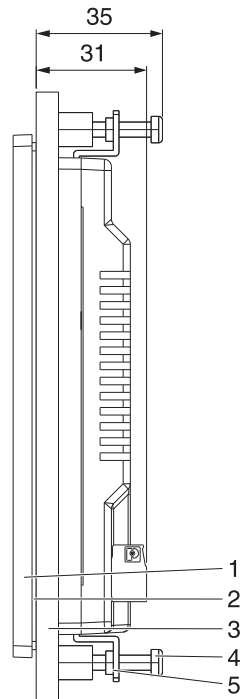

Figure 2-6 Mounting depth (dimensions in mm)

- 1 Front Panel
- 2 Circumferential Seal
- 3 Mounting Surface Thickness 1 mm to 6 mm
- 4 Screw
- 5 Mounting Bracket

2.2.2.3 BTP 2102W

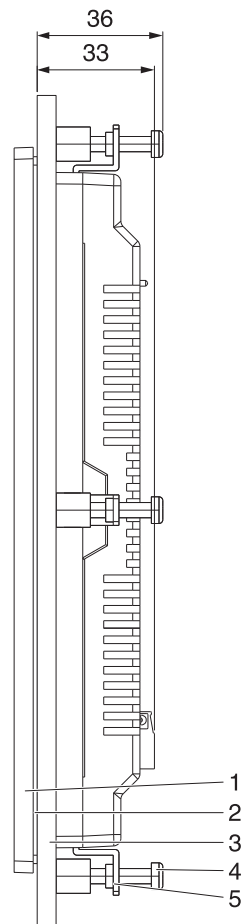

Figure 2-7 Mounting depth (dimensions in mm)

- 1 Front Panel
- 2 Circumferential Seal
- 3 Mounting Surface Thickness 1 mm to 6 mm
- 4 Screw
- 5 Mounting Bracket

2.3 Connecting the Device

2.3.1 Supply Voltage

The supply voltage is supplied via pin strip. A suitable socket strip is supplied.

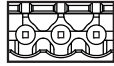

1

Figure 2-8 3 pin male connector

Refer to the technical data for the permissible supply voltage of the operating device.



The device has reverse polarity protection. In case of wrong polarity, the device will not operate.

Connector in the operating device: 3 pin male connector

Table 2-1 Pin assignment supply voltage

Pin	Function
24V	Supply voltage $\overline{\text{---}}$ 24 V
0V	Supply voltage 0 V
	Protective ground



DANGER: Hazardous voltages

Hazardous voltages can exist inside electrical installations that can pose a danger to humans. Coming in contact with live parts may result in electric shock!



NOTICE: Damage

Cables with finely stranded copper conductors with a minimum cross-section of 0.75 mm² (18 AWG) and a maximum cross-section of 2.5 mm² (14 AWG) must be used for the supply voltage.

You must adhere to the following torques at the connector:

Screw connection of terminal blocks: 0.5 Nm (minimal) to 0.6 Nm (maximum)

Use the following procedure to connect the device to the supply voltage:

- Strip approx. 30 mm (1.181") off the outer cable sheath and approx. 5 mm (0.197") off the wires.

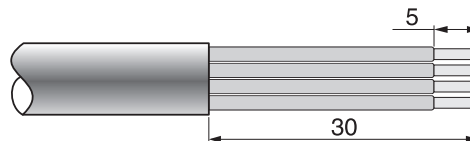

Figure 2-9 Preparing the cable

- Fit the wires with wire end ferrules and connect the wires to the socket strip.
- Plug the socket strip into the pin strip on the operating device.
- Secure the socket strip against slipping out with screws.

2.4 Switching On

The Windows CE operating system is installed on the operating device. Running on the operating system is the visualization runtime software Visu+.

The operating device allows you - by starting the cockpit during the startup phase - to make changes to the device configuration.

Cockpit at system startup

To start the cockpit, do the following:

1. Wait during the startup phase until the following dialog is displayed.

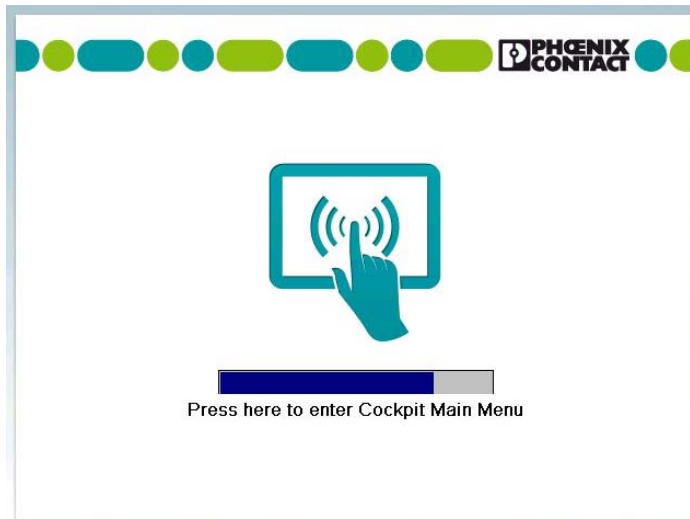

Figure 2-10 Cockpit startup phase



2. Press the button to start the cockpit before the progress bar is down.

You can customize the language of the cockpit interface with the **Regional settings** menu item.



3. Press the button **Regional Settings**.

4. Select the desired language.



5. Confirm your selection with the green check.

Using desktop icon to start cockpit

You can start the cockpit via the desktop icon at already started operating devices with active desktop:



1. Briefly press twice on the desktop icon.



2. Press the button to start the cockpit before the progress bar is down.

You can customize the language of the cockpit interface with the **Regional settings** menu item.



3. Press the button **Regional Settings**.

4. Select the desired language.



5. Confirm your selection with the green check.

2.4.1 Settings and Functions



Some settings are password-protected. The default password is "+++".

2.4.1.1 Information



This category offers the following informations:

- Data to the operating device
- Contact Information

System

The following informations are displayed:

- Device type
- Article number
- Serial number
- Hardware / firmware version
- Image version and date
- Operating system
- Runtime version
- Software bundle

2.4.1.2 Basic Settings



This category offers the following functions:

- Configure the dynamic / static IP address

Use Dynamic IP (DHCP)

1. Select the radio button to automatically receive the network configuration from the DHCP server.
2. Confirm your selection with the green check.



Note that the IP address is only indicated if the operating device is physically connected to the network.

Use Static IP

1. Select the radio button to assign an IP address and subnet mask to the operating device.
2. Confirm your selection with the green check.



Note that the IP address is only indicated if the operating device is physically connected to the network.

2.4.1.3 Regional Settings



This category offers the following functions:

- Configuration of the cockpit language
- Set date and time
- Configuration of the user interface and input language
- Loading of additional fonts

Language



1. Select the desired language.
2. Confirm your selection with the green check.

Date and Time



1. Press the **Open "Date and Time"** button.

The system dialog for date and time opens.

2. Set the date and time.
3. Press the **OK** button.
4. Confirm your selection with the green check.

Format



1. Press the **Open "Regional Settings"** button.

The system dialog for the regional and language settings will open.

2. Adjust the settings for your region.
3. Press the **OK** button.
4. Confirm your selection with the green check.

Fonts

Use additional fonts

The fonts in the default or user-specific directory will be installed automatically when you start the operating device.

Depending on the number and size of fonts, the system start-up take correspondingly more time.

Don't use additional fonts

No additional fonts are installed.

Choose fonts directory

The fonts in this directory are used if the "Use additional fonts" option is active. If no directory is given the appropriate default directory (\FlashDrv\Fonts\) is used.

2.4.1.4 File Manager



Use the file manager to copy files and directories between the storage medias (USB stick <-> device memory). You can also delete files and directories.

Copy



1. Select one or multiple files / folders.
2. Press the buttons to copy the data to the external storage medium or to the device memory.

Delete

1. Select one or multiple file(s) / folder(s).
2. Press the **Delete** button to delete the data from the external storage medium or the device memory.

2.4.1.5 Password



The category **Password** allows you to protect certain menu items in the cockpit with a password.

Current password



1. Enter a password for the protected categories.
2. Confirm your selection with the green check.

Password protected



1. Select the menu items which shall get a password protection.
2. Confirm your selection with the green check.

2.4.1.6 Administration



This category offers the following functions:

- Backup of the data / configuration
- Update of the firmware
- Restore the default registry

Backup

Create backup

1. Insert a USB stick or memory card into the female connector of the operating device.
2. If more than one slot is available, select the storage medium (**HardDisk / Storage-Card**) for the backup.
3. Press the **Create Backup** button.

The files are copied to the directory "Backup" on the storage medium. A dialog lets you know if there is already a directory „Backup“ with data on the storage medium. If you confirm this dialog the backup is overwritten.

The successful backup will be confirmed with a dialog.

Restore backup



NOTICE

When restoring the backup all data in the flash memory of the operating device will be deleted.



The process of backup and restore all settings is possible only with identical device types.

1. Insert a USB stick or memory card into the female connector of the operating device.
2. Press the **Restore Backup** button.



NOTICE

Do not interrupt the power supply during the process. After canceling an process, the operating device may not be operational anymore.

The backup files are copied from the directory "Backup" to the flash memory of the operating device.

The successful backup will be confirmed with a dialog.

3. Restart the operating device.

Update

Choose Update File



Avoid the start of further applications by opening the cockpit directly after a restart. Running applications can impair the update procedure.

1. Copy a valid firmware update file (FW_xxx.zip) to a USB stick.
2. Insert a USB stick into the female connector of the operating device.
3. Press the **Choose Update File** button.

A selection dialog box appears.



4. Select the firmware update file.
5. Confirm your selection with the green check.

The select firmware update file is displayed in the field **Current file to update**.

Start update

1. Press the button **Start update** to run the firmware update with the selected file.

A dialog box appears.



2. Confirm your selection with the green check.



NOTICE

Do not interrupt the power supply during the process. After canceling an process, the operating device may not be operational anymore.

The update is carried out automatically. This might take several minutes.

After the update process, a dialog will be displayed.

3. Press the **OK** button to restart the operating device.

Registry

Save Registry

The registry is saved completely.

Restore Default Registry

Destroys the current registry and activates the default registry of the image.

2.4.1.7 Network



You can configure the network settings with the **Network** menu item.

Device Name

You can define a device name with a maximum of 15 characters. Via network, the device can be accessed with the device name instead of the ip address.



Confirm your selection with the green check.

IP Address

Use Dynamic IP (DHCP)

The network configuration is automatically obtained from the DHCP server.



Confirm your selection with the green check.

Use Static IP

Manually assign an ip address, subnet mask and gateway of the operating device.



Confirm your selection with the green check.

WINS / DNS

Optionally, enter the ip addresses for the WINS / DNS server.



Confirm your selection with the green check.



The input fields are only active when you set up a static ip address.

SNTP

Enter the ip address of an intranet or internet time server. Define an interval in milliseconds for time synchronization.



Confirm your selection with the green check.

2.4.1.8 Display



This category offers the following functions:

- Brightness and orientation of the display
- Calibration of the touch

Brightness

1. Adjust the brightness using the slider or the buttons.



2. Confirm your selection with the green check.

Orientation

1. Turn the orientation using the buttons to the desired position.



2. Confirm your selection with the green check.

Depending on device type, the new orientation is accepted immediately or after a reboot of the operating device.

Calibrate Touch

1. Press the **Recalibrate** button.



Calibration is not possible for some device types. In this case the button is disabled.

Depending on device type the calibration is automatically started immediately or after a reboot of the operating device.

2. Press the displayed marks to calibrate the touch screen.

2.4.1.9 Default values

The following default settings are configured in the cockpit:

Table 2-2 Default values of Cockpit

Menu item	Setting	Default value	Comment
Display	Brightness	24	
	Orientation	0	
Password	Current password	++-	
	Password protected	Administration, Display, Network, Regional Settings, Password, File Manager	
Regional Settings	Language	English	
	Fonts	Use additional fonts	The fonts in the default or user-specific directory will be installed automatically when you start the operating device.
	Fonts directory	\FlashDr\Fonts	
Network	Device name	WindowsCE60	
	IP address -> Use dynamic IP (DHCP)	Enabled	
	SNTP -> Server	Ntp1.fau.de	
	SNTP -> Interval (ms)	172800000	

2.5 Visualization

The BTP 2XXXX devices uses Windows CE as its operating system. Under Windows CE, the functionality of the visualization and the performance compared to TP 3XXXX devices is limited by the hardware used.

Table 2-3 Functionality of VISU+ 2 EXPRESS with BTP 2XXXX

VISU+ Function	BTP 2XXXX	TP 3XXXX
I/O bytes (tags)	256	4096
Process images	Max. 16	Yes
Graphics libraries	Yes	Yes
Templates	Yes	Yes
Alarms	Max. 1024	Yes
Shortcuts and menus	Not available	Not available
Touchscreen support	Yes	Yes
Event logging	Yes (only TXT/XML)	Yes
Language change	Yes	Yes
IL-Logic (SoftLogic)	Yes	Yes
VBA multithreading	Max. 1	Yes
ActiveX-OCX	Not available	Yes
Debugger online / remote	Yes	Yes
IP camera	Yes	Yes
Dundas gauges	Not available	Not available
Speech recognition	Not available	Not available
Dynamic trends	Yes	Yes
Historical trends	Yes (only TXT/XML)	Yes
Recipes	Yes	Yes
OPC DA client	Not available	Yes
OPC XML DA client	Not available	Yes
OPC UA-Client	Yes (one server)	Yes
Modem driver connection	Not available	Not available
Modem RAS service	Not available	Not available
VBA driver interface	Not available	Not available
3D evaluations	Not available	Not available
Networking	Yes	Yes
Data logger	Max. 1 (TXT/XML)	Yes
Reports	Text reports	Text reports, embedded reports
Direct drivers	Max. 2	Max. 2
SMS / voice / fax / e-mail	Not available	Only e-mail
Alarm statistics	Not available	Not available

Table 2-3 Functionality of VISU+ 2 EXPRESS with BTP 2XXXX

VISU+ Function	BTP 2XXXX	TP 3XXXX
OPC DA server	Not available	Yes
OPC XML DA server	Not available	Not available
Redundancy	Not available	Not available
Parameters	Not available	Not available
FDA CFR 21 Part 11	Not available	Not available
Web Client	1 web client (Java)	2 web clients (Java or HTML5)

2.5.1 System Variables

With the help of the system variables you control internal functions of the operating devices. The value of system variables you can display or influence in a process screen. Depending on the system variable you have read or write access. These variables are available if you use the communication driver „Phoenix Contact Hardware Access“ in the programming software.



The available system variables of all products are displayed in the programming software. The products described in this user manual support the following system variables:

Table 2-4

GET_BACKLIGHT_STATE	
Description	Determine status of the backlight
Return value	0 = Off 1 = On

Table 2-5

GET_BRIGHTNESS_VALUE	
Description	Determine the brightness of the display
Return value	1 to 30

Table 2-6

GET_VOLTAGE_VALUE	
Description	Determine voltage value of the operating device
Return value	Voltage in volt

Table 2-7

GET_TEMPERATURE_VALUE	
Description	Determine the temperature of the operating device
Return value	Temperature in °C

Table 2-8

SET_ALARM_BRIGHTNESS_STATE	
Description	Adjust brightness of the display with alarms
Parameter	0 = Brightness is set to the original value 1 = Brightness is set to the value of the system variable SET_ALARM_BRIGHTNESS_VALUE

Table 2-9

SET_ALARM_BRIGHTNESS_VALUE	
Description	Set the brightness of the display with alarms
Parameter	1 to 30

Table 2-10

SET_BACKLIGHT_ON_OFF	
Description	Switch backlight on / off
Parameter	0 = On 1 = Off

Table 2-11

SET_BRIGHTNESS_VALUE	
Description	Set the brightness of the display
Parameter	1 to 30

2.6 Identification

The operating device can be identified using the nameplate on the rear of the device.



Figure 2-11 Nameplate (example)

- 1 Article Number, Device Type
- 2 MAC Address

3 Control and Display Elements

3.1 Touchscreen

The device is equipped with a resistive 4 wire touch screen. You operate the device using this touch screen.

**NOTICE: Damage**

Pointed or sharp objects, such as pens or fingernails, can lead to irreparable damages of the touch screen. Exclusively therefore use the fingertips or the aids indicated in the technical data for the operation.

3.2 Display

**DANGER: Toxic**

If the display is damaged, avoid touching, swallowing or breathing in the liquids or gases which may leak out!

**DANGER: Corrosive**

If the display is damaged, avoid touching, swallowing or breathing in the liquids or gases which may leak out!



Pixel failures, which can occur with TFT displays, are due to production and no complaint reason!

The operating device is equipped with different displays (see technical data) depending on variant.

4 Interfaces of the Device

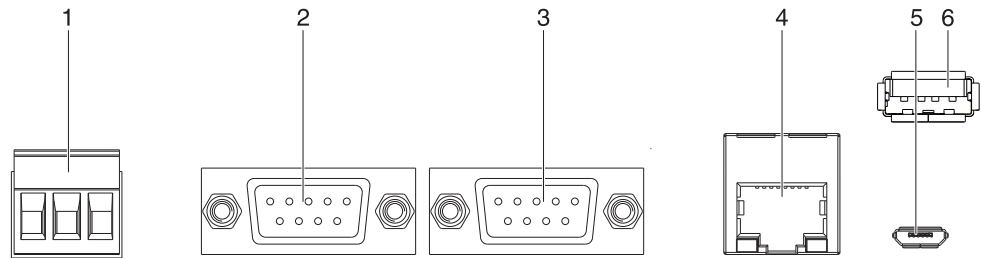

Figure 4-1 Interfaces of the device

- 1 Connector 24 V (Supply Voltage)
- 2 Female Connector COM1 (RS-232/RS-422/RS-485) - (Female Connector also operates as COM2 for 4,3" device)
- 3 Female Connector COM2 (RS-232/RS-485) - (Female Connector not available at 4,3" device)
- 4 Connector ETHERNET (10/100 MBit)
- 5 Connector HOST (USB 2.0 - Type A)
- 6 Connector SLAVE (USB 2.0 - Type B)

4.1 USB (HOST)

A USB interface is available at the operating device to connect periphery equipment (for example: Mass memory, printer, scanner, mouse, keyboard etc.).

**NOTICE:**

Using hardware not suitable for industrial use (for example keyboard, mouse, memory card) in industrial environments may decrease safety of operation. This includes hardware intended for home and office use.

4.1.1 Cable



For the specification of a suitable cable, please refer to the „Universal Serial Bus Specification“.

**NOTICE:**

Use industrial-suited USB cables with a length of maximally 2.5 m (8.202 feet).

4.2 USB (SLAVE)

A USB-Device interface is available at the operating device.

**NOTICE:**

Using hardware not suitable for industrial use (for example keyboard, mouse, memory card) in industrial environments may decrease safety of operation. This includes hardware intended for home and office use.

4.2.1 Cable



For the specification of a suitable cable, please refer to the „Universal Serial Bus Specification“.

**NOTICE:**

Use industrial-suited USB cables with a length of maximally 2.5 m (8.202 feet).

4.3 Ethernet

A 10/100 Base-T Ethernet interface is available at the operating device.

4.3.1 Pin Assignment

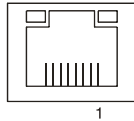

Figure 4-2 Ethernet connector

Connector in the operating device: RJ45 female connector.

Table 4-1 Assignment of the Ethernet interface

Pin	Designation	Function
1	Tx+	Transmitted Data, Positive Polarity
2	Tx-	Transmitted Data, Negative Polarity
3	Rx+	Received Data, Positive Polarity
4	n.c.	Not Connected
5	n.c.	Not Connected
6	Rx-	Received Data, Negative Polarity
7	n.c.	Not Connected
8	n.c.	Not Connected

4.3.2 Cable



NOTICE

Use a twisted pair cable of category 5 (CAT 5). The maximum cable length is 100 m (328.084 feet).



See the IEEE 802.3 standard for further information.

4.4 RS-232 / RS-422 / RS-485 (COM1/COM2)

There are two RS-232, RS-422 / RS-485 communication interfaces at the operating device.



A 4,3" device has only one female connector for COM1 (RS232) and COM2 (RS485). If you want to use COM1 and COM2 at the same time, you have to use a suitable Y-cable.

4.4.1 Pin Assignment

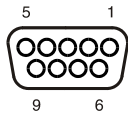

Figure 4-3 9 pin D-SUB female connector strip

Connector in the operating device: 9 pin D-SUB male connector strip.

Table 4-2 Pin assignment RS-232 / RS-422 / RS-485

Pin	Designation	Function
1	Tx+	RS485 Transmitted Data Plus
2	TxD	RS232 Transmitted Data
3	RxD	RS232 Received Data
4	Rx+	RS485 Received Data Plus
5	GND	Ground
6	nc	Not Connected
7	nc	Not Connected
8	Tx-	RS485 Transmitted Data Minus
9	Rx-	RS485 Received Data Minus



NOTICE:
The D-SUB connector strips must be shielded sufficiently. See chapter "Shielding D-SUB Connectors" on page 35

4.5 Memory Card

You can insert a microSD card on the side or top of the operating device.



NOTICE:

Using hardware not suitable for industrial use (for example keyboard, mouse, memory card) in industrial environments may decrease safety of operation. This includes hardware intended for home and office use.

4.6 Shielding D-SUB Connectors

You must shield D-SUB connectors as follows:

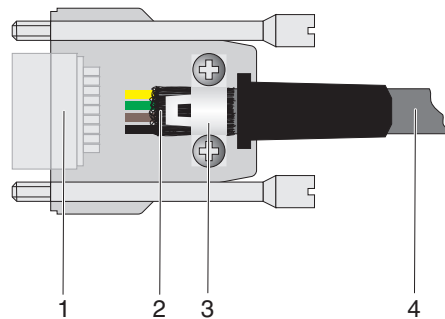

Figure 4-4 Shielding D-SUB connectors

- 1 D-SUB connector
- 2 Shield
- 3 Cable clip
- 4 Cable

The shield must be folded back into a flat position over the cable sheath.

When fastening the cable with the cable clip, as much of the shielding as possible must be in contact with the housing and sufficient strain relieve must be ensured.

5 Maintenance and Servicing

5.1 Maintenance Interval

The following maintenance intervals are recommended for this operating device:

Table 5-1 Maintenance interval

Maintenance work	Interval
Changing the Battery	4 Years

5.2 Front Panel

Only use a damp cloth to remove any dirt from the front panel.

5.3 Battery

The minimum battery life is 5 years, even under unfavorable operating conditions.

We recommend that the battery be replaced every 4 years during regular maintenance work. The replacement can be carried out by the service at Phoenix Contact.

6 Technical Data

6.1 General

Touch Screen

Type Analog resistive, 4 wire technology

USB

Corresponds to the „Universal serial bus specification Rev. 2.0“

Device	12 Mbit/s
Host	Min.: 1,5 Mbit/s Max.: 12 Mbit/s

Ethernet

Ethernet 10/100 Mbit/s

Serial Interfaces

Variable baud rates and data formats

COM1	RS-232 / RS-422 / RS-485, not galvanically isolated
COM2	RS-232 / RS-422 / RS-485, not galvanically isolated

Central Processing Unit

Central processing unit	32 Bit RISC
Other features	Real-time clock

Memory

Flash	512 MByte (maximum)
RAM	128 MByte DDR2
MicroSDHC interface	Maximum 32 GByte

Connection System

D-SUB male connector strip, 9 pin

Male connector strip Phoenix COMBICON, 3 pin

RJ45 male connector

USB male connector type A and B

Environmental Conditions

Temperature during operation	0 °C to 50 °C (32 °F to 122 °F)
Temperature during storage, transport	- 20 °C to + 85 °C (- 4 °F to 185 °F)
Relative air humidity for operation and storage	10 % to 95 %, no condensation
Vibration resistance	5 to 150 Hz (X, Y, Z direction, 3G) according to IEC60068-2-6

Standards and Guidelines

Interference immunity	IEC 61000-4-2 IEC 61000-4-3 IEC 61000-4-4 IEC 61000-4-5 IEC 61000-4-6
Emitted interference	IEC 61000-6-4 EN 55011 limit value class A
Equipment requirements	DIN EN 61131-2
Storage and transportation	DIN EN 61131-2
Power supply	DIN EN 61131-2
Impact load, shocks	IEC 60068-2-27
Sinusoidal vibrations	IEC 60068-2-6



NOTICE: Radio Interference

Operation of this device may cause radio interference in residential areas.

Approvals

CE

6.2 BTP 2043W

Display

Size (diagonal) in cm (inch)	10.92 (4.3)
Type	TFT (color)
Resolution (pixels)	480 x 272
Colors	262144
Viewing angle (left / right / up / down) in °	70 / 70 / 50 / 70
Half-life backlighting	20,000 h
Brightness in cd/m ²	400
Display area (H x W) in mm (Inch)	53.8 x 95 (2.118 x 3.74)

Electrical Data

Supply voltage	24 V DC (+/- 15%)
Power consumption (typical at 24 V)	0.17 A
Connected load	4 W

Front Panel and Enclosure

Enclosure	Plastic (black)
Front panel (H x W x D) in mm (Inch)	89 x 120 x 5 (3.5 x 4.724 x 0.196)
Seal	Circumferential rubber seal on the rear
Mounting cutout (H x W) in mm (Inch)	80 x 111 (3.149 x 4.37)
Mounting brackets	2
Mounting depth in mm (Inch)	About 31.5 (1.24)
Degree of protection	Front: IP66 Rear: IP20
Total weight	About 200 g

6.3 BTP 2070W

Display

Size (diagonal) in cm (inch)	17.78 (7)
Type	TFT (color)
Resolution (pixels)	800 x 480
Colors	262144
Viewing angle (left / right / up / down) in °	70 / 70 / 50 / 70
Half-life backlighting	20,000 h
Brightness in cd/m ²	300
Display area (H x W) in mm (Inch)	132.48 x 222 (5.215 x 8.74)

Electrical Data

Supply voltage	24 V DC (+/- 15%)
Power consumption (typical at 24 V)	0.4 A
Connected load	9 W

Front Panel and Enclosure

Enclosure	Plastic (black)
Front panel (H x W x D) in mm (Inch)	138 x 186 x 5 (5.433 x 7.322 x 0.196)
Seal	Circumferential rubber seal on the rear
Mounting cutout (H x W) in mm (Inch)	127 x 175 (5 x 6.889)
Mounting brackets	4
Mounting depth in mm (Inch)	About 31 (1.22)
Degree of protection	Front: IP66 Rear: IP20
Total weight	About 400 g

6.4 BTP 2102W

Display

Size (diagonal) in cm (inch)	25.9 (10.2)
Type	TFT (color)
Resolution (pixels)	800 x 480
Colors	262144
Viewing angle (left / right / up / down) in °	65 / 65 / 45 / 65
Half-life backlighting	20,000 h
Brightness in cd/m ²	300
Display area (H x W) in mm (Inch)	91.4 x 152.4 (3.598 x 6)

Electrical Data

Supply voltage	24 V DC (+/- 15%)
Power consumption (typical at 24 V)	0.3 A
Connected load	7 W

Front Panel and Enclosure

Enclosure	Plastic (black)
Front panel (H x W x D) in mm (Inch)	190 x 268 x 5 (7.48 x 10.551 x 0.196)
Seal	Circumferential rubber seal on the rear
Mounting cutout (H x W) in mm (Inch)	178 x 256 (7 x 10.078)
Mounting brackets	6
Mounting depth in mm (Inch)	About 33 (1.299)
Degree of protection	Front: IP66 Rear: IP20
Total weight	About 900 g

A 1 Index

A

Administration 21

B

Battery 37

C

Cable

Ethernet..... 33

USB..... 32

Connecting..... 17

D

Dimensions

Cutout..... 11

Display 23, 29

F

File manager 21

Functions 19

I

Identification..... 28

Intended use 8

Interface

Ethernet..... 33

RS-232 34

RS-422 34

RS-485 34

USB..... 32

M

Maintenance 37

Maintenance interval..... 37

Memory card..... 35

Mounting 10

Mounting cutout

BTP 2043W 11

BTP 2070W 12

BTP 2102W 13

Mounting depth

BTP 2043W 14

BTP 2070W 15

BTP 2102W 16

N

Nameplate 28

Network 23

P

Password 21

Pin assignment

Ethernet..... 33

RS-232 34

RS-422 34

RS-485 34

S

Safety notes 7

Servicing 37

Settings 19

Side view

BTP 2043W 14

BTP 2070W 15

BTP 2102W 16

Standards 40

Supply Voltage..... 17

Switching on 18

Symbols 7

T

Target group 8

Technical data 39

BTP 2043W 41

BTP 2070W 42

BTP 2102W 43

Touchscreen 29

U

Unpacking..... 9

