

PMI m107 diag



Operator terminals

This document is a translation of the original document.

All rights to this documentation are reserved by Pilz GmbH & Co. KG. Copies may be made for internal purposes.

Suggestions and comments for improving this documentation will be gratefully received.

Pilz[®], PIT[®], PMI[®], PNOZ[®], Primo[®], PSEN[®], PSS[®], PVIS[®], SafetyBUS p[®], SafetyEYE[®], SafetyNET p[®], the spirit of safety[®] are registered and protected trademarks of Pilz GmbH & Co. KG in some countries.

 SD means Secure Digital.

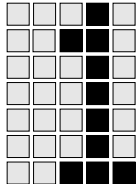
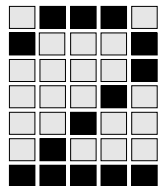
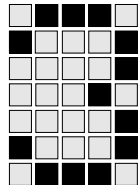
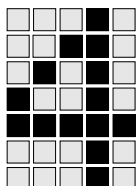
| | | |
|---|--|------------|
|  | Introduction | 1-1 |
| | Overview of documentation | 1-2 |
| | Definition of symbols | 1-3 |
|  | Overview | 2-1 |
| | Components | 2-2 |
| | Display | 2-2 |
| | Interfaces | 2-2 |
| | Range | 2-2 |
|  | Safety | 3-1 |
| | Intended use | 3-1 |
| | Safety guidelines | 3-1 |
| | Use of qualified personnel | 3-2 |
| | EMCD | 3-2 |
| | Warranty and liability | 3-2 |
| | Disposal | 3-2 |
|  | Unit Description | 4-1 |
| | Front view | 4-1 |
| | Key functions | 4-1 |
| | Side view, including interfaces | 4-2 |
| | Side view, including CF card slot | 4-3 |
| | Inserting the CF card | 4-3 |
| | Interfaces | 4-4 |
| | Termination | 4-5 |
| | Connection diagram and details of cables and converters PSS/SafetyBUS p | 4-6 |
| | Connection diagram and details of cables and converters PNOZmulti | 4-7 |

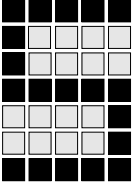
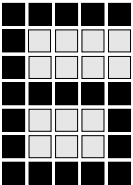
| | | |
|---|---|------------|
|  | Installation and Wiring | 5-1 |
| | Safety | 5-1 |
| | Nominal dimensions | 5-2 |
| | Installing the device | 5-3 |
| | Connecting the device | 5-4 |
| | Supply voltage | 5-4 |
| | Cable layout | 5-4 |
| | Earth connector | 5-5 |
| | Screening | 5-6 |
| | Measures to protect against interference voltages | 5-6 |
| | Connection example | 5-7 |
| | | |
|  | Commissioning | 6-1 |
| | General | 6-1 |
| | PSS/SafetyBUS p and PNOZmulti | 6-1 |
| | PNOZmulti vIO | 6-1 |
| | Procedure after power-up | 6-1 |
| | Default setting | 6-2 |
| | Help | 6-4 |
| | PMImicro configuration | 6-4 |
| | Configuration | 6-5 |
| | General guidelines on operation | 6-7 |
| | Display when window is opened | 6-7 |
| | Display when input field is activated | 6-7 |
| | Direction of selection in the options list | 6-7 |
| | Password protection | 6-8 |
| | User setting | 6-9 |
| | Select user | 6-10 |
| | Change user name | 6-11 |
| | Change password | 6-12 |
| | Change access rights | 6-13 |
| | Interfaces | 6-14 |
| | Interface for the connected device | 6-14 |
| | Select connected device | 6-15 |
| | PC interface | 6-16 |

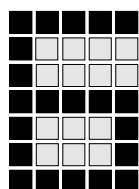

| | |
|---|-------------|
| Time characteristics | 6-17 |
| Operator timeout | 6-17 |
| Flash frequency | 6-18 |
| System time | 6-19 |
| Backup & restore | 6-20 |
| Backup | |
| (save data from PMImicro diag to CF card) | 6-20 |
| Restore | |
| (save data from CF card to PMImicro diag) | 6-23 |
| Integrity display PSS/SafetyBUS p | 6-26 |
| Status | 6-26 |
| Download point | 6-26 |
| Project name | 6-27 |
| Integrity display PNOZmulti | 6-27 |
| Status | 6-27 |
| CRC | 6-28 |
| Project name | 6-28 |
| Show delete information | 6-29 |
| Display mode | 6-29 |
| Max. number of entries in the event list | 6-30 |
| Language | 6-32 |
| Menu language | 6-32 |
| Diagnostic language | 6-32 |
| Display settings | 6-33 |
| Log files | 6-35 |
| PMImicro diag log file | 6-35 |
| Diagnostic log file | 6-37 |
| Versions | 6-39 |

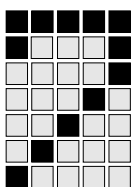

| | |
|--------------------------|------------|
| Operation | 7-1 |
| Download data | 7-1 |
| Diagnostic configuration | 7-1 |
| PMImicro configuration | 7-1 |
| Log files | 7-2 |
| PMImicro diag log file | 7-2 |
| Diagnostic log file | 7-2 |
| Runtime | 7-2 |

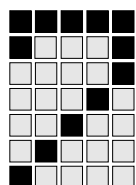

| | |
|--|-------------|
| Communication relating to runtime: | |
| Connected device <-> PMImicro diag | 7-2 |
| Routing function: | |
| PC <-> Connected device via PMImicro diag | 7-3 |
| Diagnostics PSS/SafetyBUS p and PNOZmulti | 7-4 |
| PMImicro Configurator | 7-5 |
| Priorities | 7-6 |
| Responsibilities | 7-6 |
| Scopes | 7-6 |
| Description of location | 7-7 |
| Event list | 7-7 |
| Message display | 7-8 |
| Navigation within an event message | 7-9 |
| Navigation between event messages | 7-10 |
| Deleting event message | 7-11 |
| Deleting event message (on display) | 7-11 |
| Incoming event message | 7-12 |
| Managing event messages | 7-12 |
| PNOZmulti diagnostics via virtual outputs | 7-13 |
| Schematic representation, using the virtual output VO1 as an example | 7-14 |
| Create diagnostics | 7-16 |
| Configuration files | 7-16 |
| mappingtable.xml | 7-18 |
| Message files | 7-19 |
| Message display | 7-22 |
| Part counter | 7-23 |
| Function | 7-23 |
| Configuration | 7-24 |
| PMImicro configuration | 7-25 |
| Password protection | 7-25 |
| User setting | 7-25 |
| Integrity display | 7-25 |
| Logbook | 7-26 |
| Versions | 7-26 |

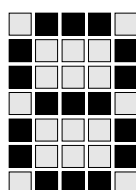

| | |
|--------------------------------|------------|
| Technical Details | 8-1 |
| Technical details | 8-1 |
| Licence: GPL/expat/zlib | 8-2 |

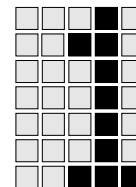

Introduction

This operating manual is valid for the following unit:

- **PMI m107 diag** from Version 1.6

It is valid until new documentation is published. The latest documentation is always enclosed with the unit.

In this manual the unit is called **PMImicro diag**.

The documentation comprises:

- The hardware description for the PMImicro diag
- A description of the PMImicro configuration
- A description of the diagnostics



INFORMATION

Details of how to create the diagnostic configuration and how to use the PMImicro Configurator can be found in the online help of the system software for the connected device.

This documentation is intended for instruction and should be retained for future reference.

Introduction

Overview of documentation

- 1 Introduction**

The introduction is designed to familiarise you with the contents, structure and specific order of this manual.
- 2 Overview**

This chapter provides information on the most important features of the diagnostic terminal.
- 3 Safety**

This chapter **must** be **read** as it contains important information on safety regulations and intended use.
- 4 Unit Description**

This chapter describes the individual components of the diagnostic terminal.
- 5 Installation and Wiring**

This chapter explains how to install and wire up the diagnostic terminal.
- 6 Commissioning**

This chapter describes the commissioning, the default settings and the PMImicro configuration.
- 7 Operation**

This chapter describes the data transfer and the diagnostic function.
- 8 Technical Details**

This chapter contains the technical details and information on how to license the operating system μ Clinux.

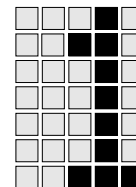

Definition of symbols

Information in this manual that is of particular importance can be identified as follows:



DANGER!

This warning must be heeded! It warns of a **hazardous situation that poses an immediate threat of serious injury and death** and indicates preventive measures that can be taken.



WARNING!

This warning must be heeded! It warns of a **hazardous situation** which could lead to **serious injury or death** and indicates preventive measures that can be taken.



CAUTION!

This refers to a hazard that can lead to a less serious or minor injury plus material damage, and also provides information on preventive measures that can be taken.



NOTICE

This describes a situation in which the unit(s) could be damaged and also provides information on preventive measures that can be taken.



INFORMATION

This gives advice on applications and provides information on special features, as well as highlighting areas within the text that are of particular importance.



Introduction

Notes

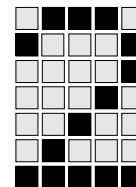

Overview

The diagnostic terminal PMImicro diag displays event messages from devices that support expanded diagnostics PVIS. These devices include the PSS-range of programmable safety systems, for example.

If an event message is triggered in the connected device, the event message is downloaded to the diagnostic terminal via a serial interface and displayed there as a plain text message.

The PMImicro diag is supplied with a default diagnostic configuration and a default PMImicro configuration, so it can immediately be used for device diagnostics (display of system messages).

The event messages are recorded and the record is stored in a log file.

The log can be displayed on the device. Alternatively, a CF card can be used to download the log to the PC, where it can be evaluated.

The settings for these event messages (e.g. display according to priority) are established in the diagnostic configuration.

The diagnostic configuration is created on the PC in the relevant system software for the connected device; it is then downloaded to the PMImicro diag via a serial interface or CF card, using the PMImicro Configurator.

Other settings such as password settings, language, interfaces and user settings are required for the diagnostic terminal itself. The PMImicro configuration can be made directly on the diagnostic terminal via the navigation and function keys.

However, the PMImicro configuration can also be created on the PC using the PMImicro Configurator; it can then be downloaded to the PMImicro diag via a serial interface or CF card.

The diagnostic configuration, PMImicro configuration and runtime can be saved on to a CF card using the backup & restore function.

After a data failure, data can be restored directly with the help of a CF card, without a PC connection. Using the CF card, the saved data can also be downloaded to several diagnostic terminals.

It is also possible to update the runtime and firmware via a CF card.

Identifiers can be assigned for exporting the log files and also for the files exported using the backup & restore function; this means that various versions may be stored on one CF card.

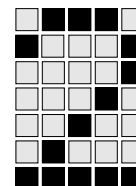

Overview

Various languages are available for the diagnostic configuration and for the PMImicro configuration. You should also refer to the information on the default setting (see page 6-2):

- Diagnostic configuration: The diagnostic configuration created in the system software of the connected device determines which language is selected.
- PMImicro configuration: The PMImicro configuration created in the PMImicro Configurator in the system software of the connected device determines which language is selected.
- Log files: If the relevant configuration supports multiple languages, the language may later be switched for viewing and exporting the log files.

Components

Display

- LCD 2.8" (70 mm), 128 x 64 pixels

Interfaces

- Two serial interfaces (RS 232 and RS 485)
- CF card connection

Range

- Diagnostic terminal
- 2 PMI retaining clamps/ 2 raised head screws (M4)
- Gasket
- Plug for supply voltage
- Null modem cable
- Device documentation and and sample project PNOZmulti vIO on CD

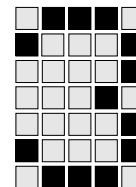

Safety

Intended use

The diagnostic terminal PMImicro diag displays event messages from devices that support PVIS expanded diagnostics. For example, these devices include:

- PSS-range programmable safety systems with an FS operating system version ≥ 47 .
- PNOZmulti safety relays:
 - PNOZ m0p from Version 2.0
 - PNOZ m1p from Version 5.0
 - PNOZ m2p from Version 2.0

If an error occurs, the PMImicro diag will display the event message from the connected device as plain text - and provide guidance on how to rectify the error. The PMImicro Configurator is required in order to download the diagnostic configuration.

The following is deemed improper use:

- Any component, technical or electrical modification to the diagnostic terminal
- Use of the diagnostic terminal outside the areas described in this manual
- Use of the diagnostic terminal outside the stated technical details (see chapter entitled “Technical Details”).

Intended use includes making the installation EMC-compliant. Please refer to the guidelines stated in this manual.

Safety guidelines

Failure to keep to these guidelines will render all warranty and liability claims invalid:

- All health and safety / accident prevention regulations for the particular area of application must be observed.

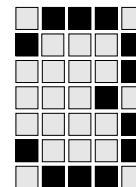

Safety

Use of qualified personnel

The diagnostic terminal may only be assembled, installed, programmed, commissioned, operated and maintained by qualified personnel. Qualified personnel are people who, because they are:

- Qualified electrical engineers and
- Have received training from qualified electrical engineers, are suitably experienced to operate devices, systems, plant and machinery in accordance with the general standards and guidelines for safety technology.

EMCD

The diagnostic terminal is designed for use in an industrial environment. It is not suitable for use in a domestic environment, as this can lead to interference.

Warranty and liability

All claims to warranty and liability will be rendered invalid if:

- The diagnostic terminal was used contrary to the purpose for which it is intended
- Damage can be attributed to not having followed the guidelines in the manual
- Operating personnel are not suitably qualified.
- Any type of modification has been made (e.g. exchanging components on the PCB boards, soldering work etc.).

Disposal

The diagnostic terminal must be disposed of properly when it reaches the end of its service life.

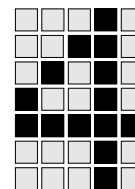

Unit Description

Front view

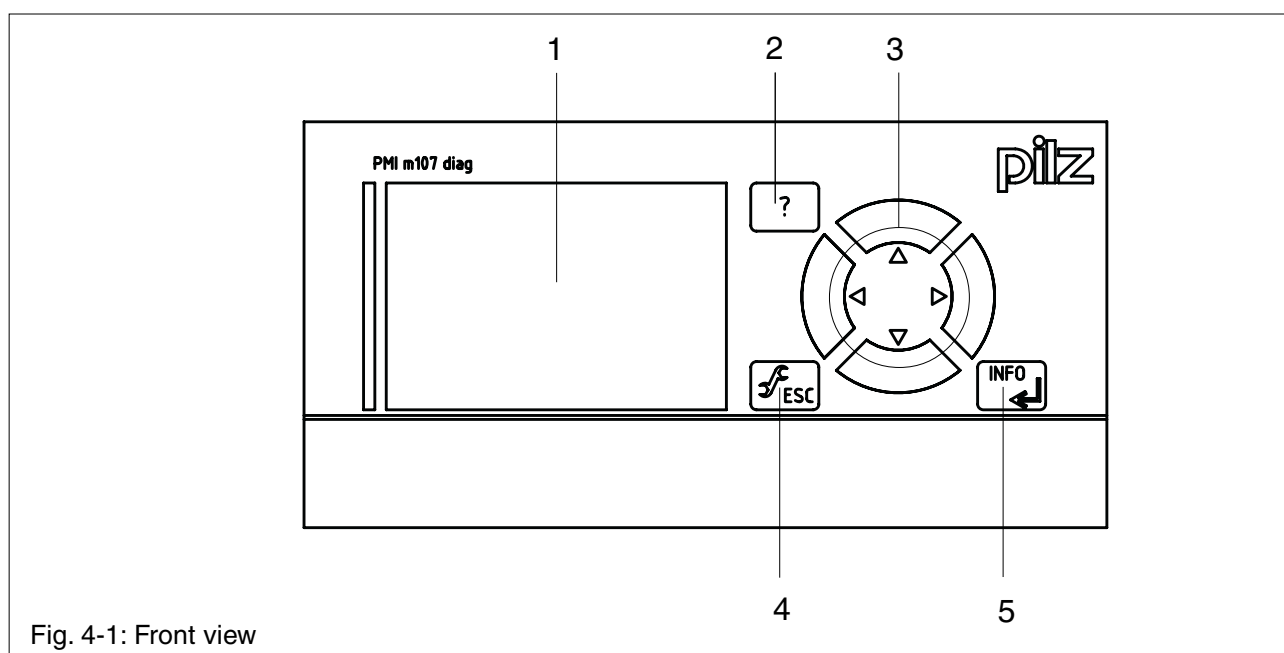





Fig. 4-1: Front view

- 1: Display (see page 7-6)
- 2: Help key
- 3: 4 navigation keys
- 4: Setup and <ESC> key
- 5: <INFO> and <ENTER> key

Key functions

| Key | Description |
|---|---|
|  | <ul style="list-style-type: none"> • Call up/close help for the current window |
|  | <ul style="list-style-type: none"> • Call up main setup menu by holding the key down for 3 sec. • Close current window, cancel an entry |
|  | <ul style="list-style-type: none"> • In diagnostic mode, the event or action will appear (see page 7-6 ff) • Switch to page two in the log files menu • Confirm entry or selection of menu options |
| <ul style="list-style-type: none"> △ ▽ | <ul style="list-style-type: none"> • Move in the direction of the arrows (scroll function) (up/down) • Change selection of characters 1 ... 9, _, A ... Z |
| <ul style="list-style-type: none"> ◀ ▶ | <ul style="list-style-type: none"> • Switch to the next menu/input field and back again |

Unit Description

Side view, including interfaces

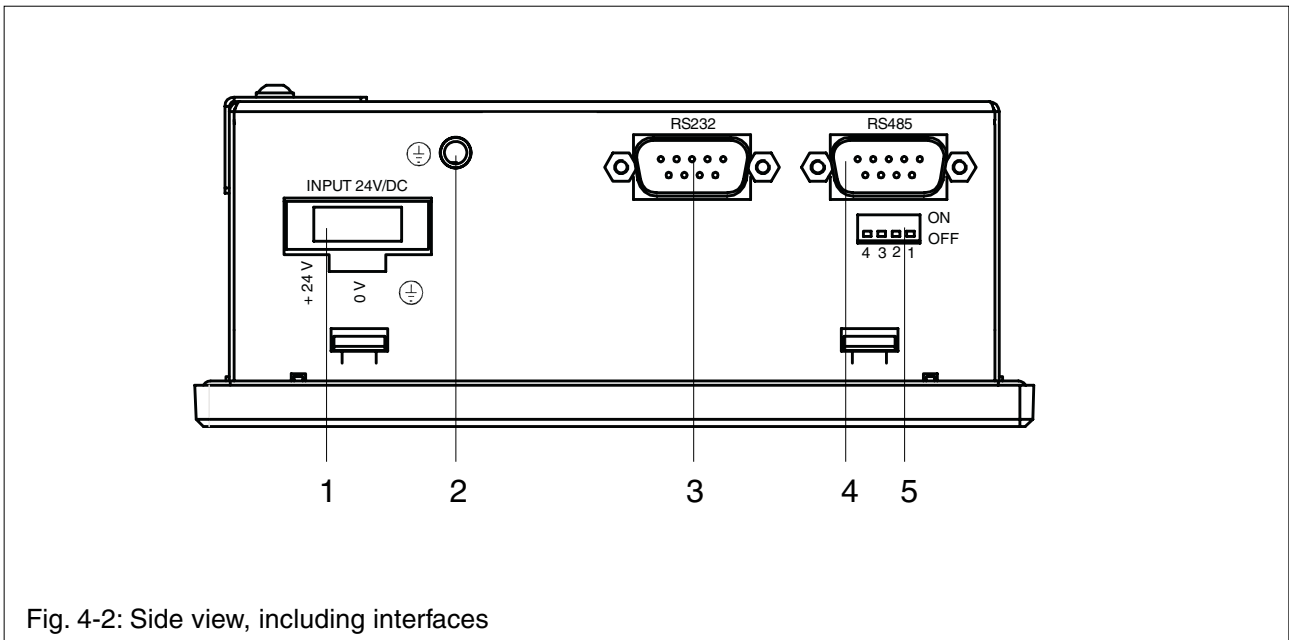

Fig. 4-2: Side view, including interfaces

- 1: Supply voltage with polarity protection
- 2: Threaded insert (M4) for the functional earth connection
- 3: RS 232 interface
- 4: RS 485 interface
- 5: RS 485 interface termination



Notice

Please note the following during diagnostics on the PNOZmulti. The RS 232 interfaces on the PNOZmulti and PMImicro diag do not have galvanic isolation. If the units are connected to different voltage sources, any potential difference between the power supplies could destroy the RS 232 interface.

Connect the PNOZmulti and PMImicro diag to the same voltage source!

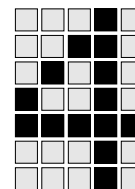

Side view, including CF card slot

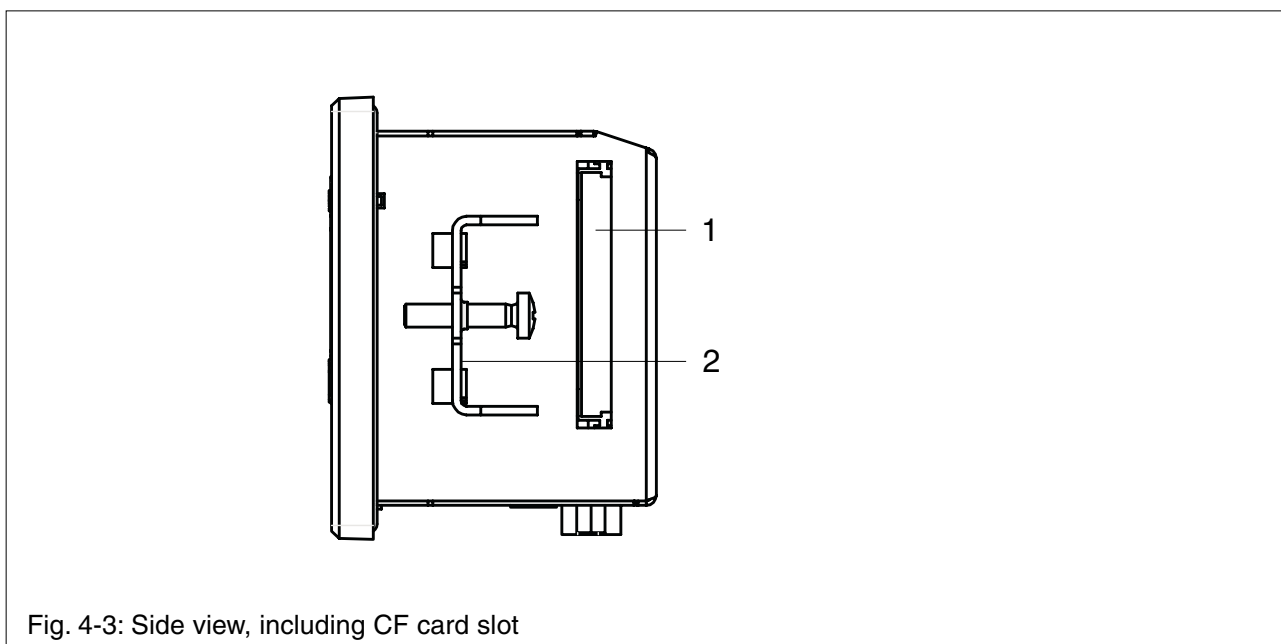

Fig. 4-3: Side view, including CF card slot

- 1: CF card slot (50-pin), side access
- 2: Retaining clamp



NOTICE

Switch off the PMImicro diag before inserting or exchanging the CF card. Data on the CF card will be lost or the CF card itself may be damaged if you insert or exchange the CF card while the PMImicro diag is switched on.

Inserting the CF card



INFORMATION

Please refer to the guidelines given by the manufacturer of the CF card. All CF cards (use Type I) will only fit into the PMImicro diag in one direction and the right way round.

Please note the following:

- Do not twist the CF card as you insert it into the card slot.

Unit Description

- If you cannot fully insert the CF card, you may need to adjust the position of the CF card within the slot.
- Do not force the CF card into the card slot. This will damage the CF card or the PMImicro diag.

Interfaces

Layout of the RS 232 interface

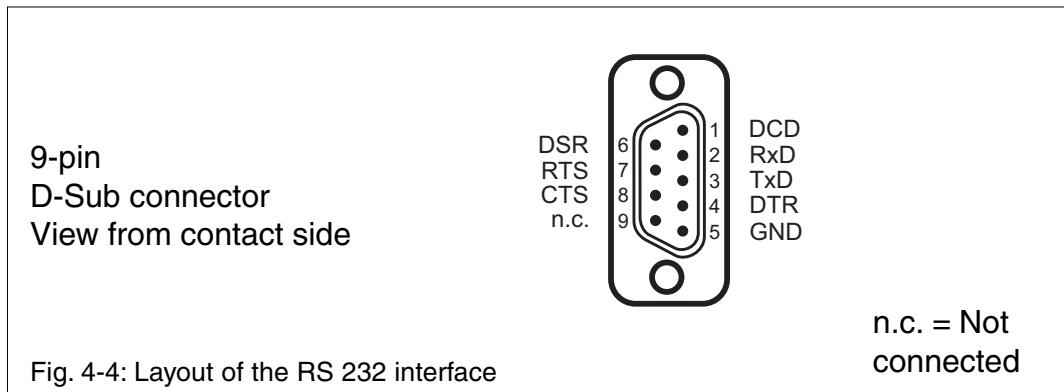

Layout of the RS 485 interface

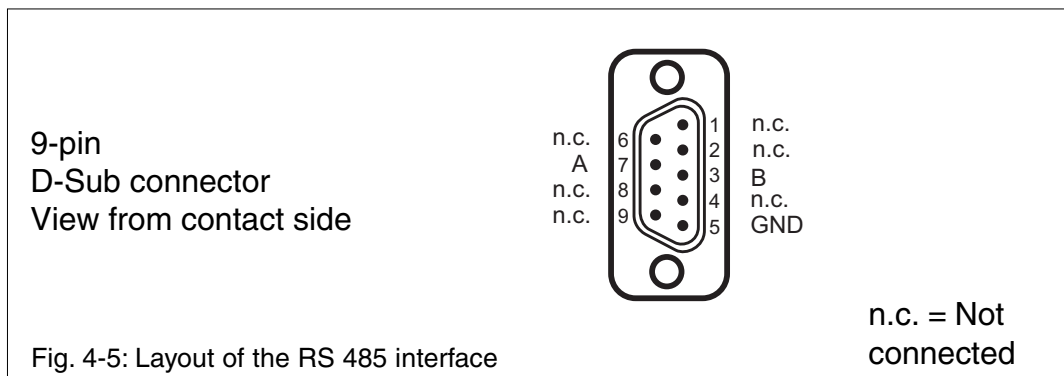

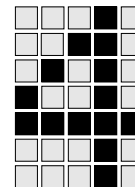

Termination

The RS 485 interface can be terminated internally (R 120 Ohm).

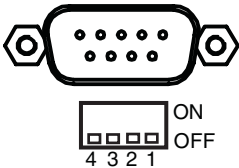
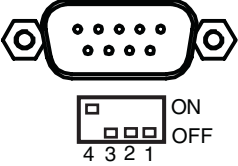
| Termination off | Termination on |
|---|--|
| <p data-bbox="566 757 630 779">RS485</p>  <p data-bbox="391 1016 630 1048">Switch 4 ... 1: off</p> | <p data-bbox="1109 745 1173 768">RS485</p>  <p data-bbox="933 1016 1173 1088">Switch 4: on, Switch 3 ... 1: off</p> |

Unit Description

Connection diagram and details of cables and converters PSS/SafetyBUS p

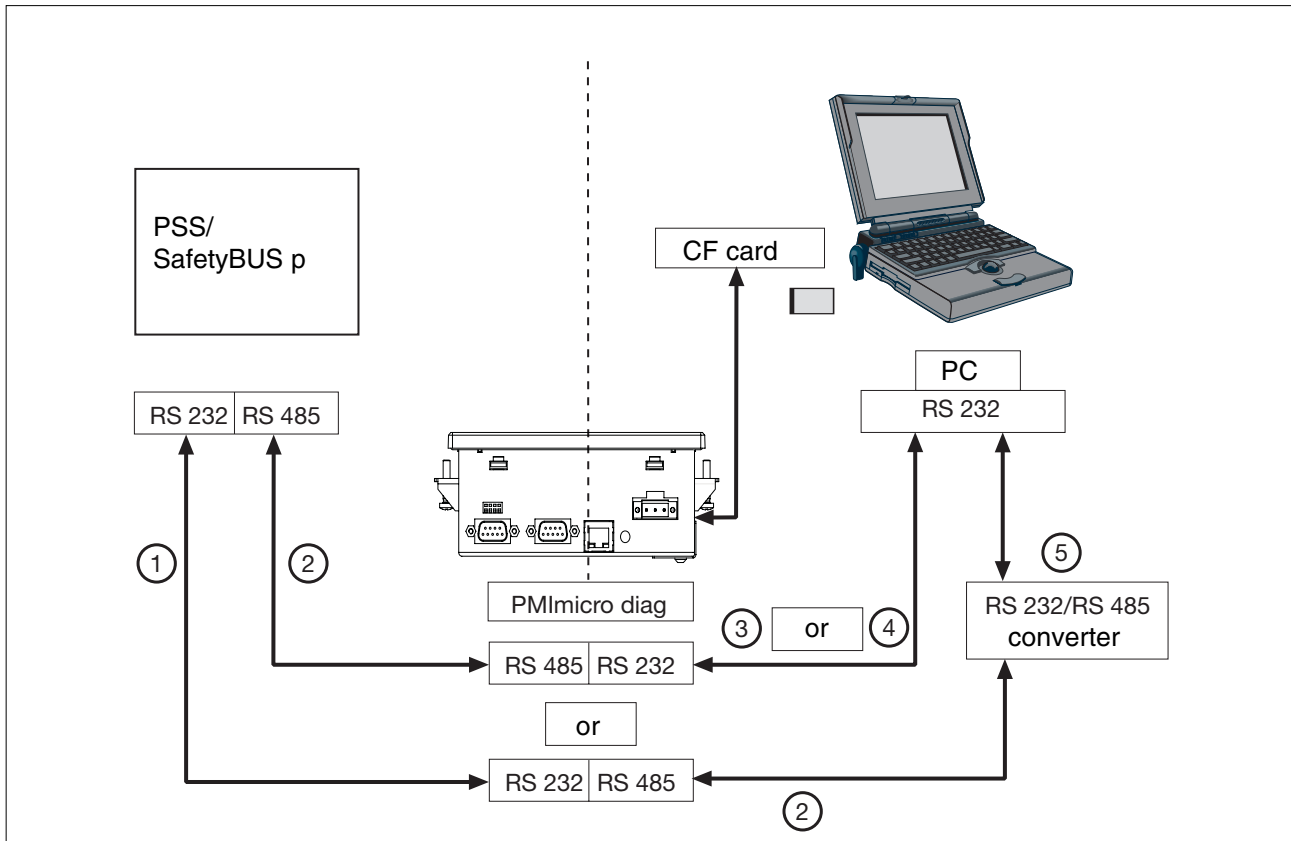

| No | Description | Order number |
|----|-----------------------------------|--------------|
| ① | RS 232 download cable | 301960 |
| ② | RS 485 download cable | 374205 |
| ③ | RS 232 0 modem cable | 301965 |
| ④ | RS 232 0 modem cable PC - PSS | 310300 |
| ⑤ | RS 232/RS 485 interface converter | 305159 |

Fig. 4-6: Connection diagram and details of cables and converters PSS/SafetyBUS p

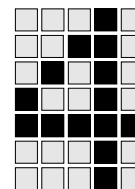

Connection diagram and details of cables and converters PNOZmulti

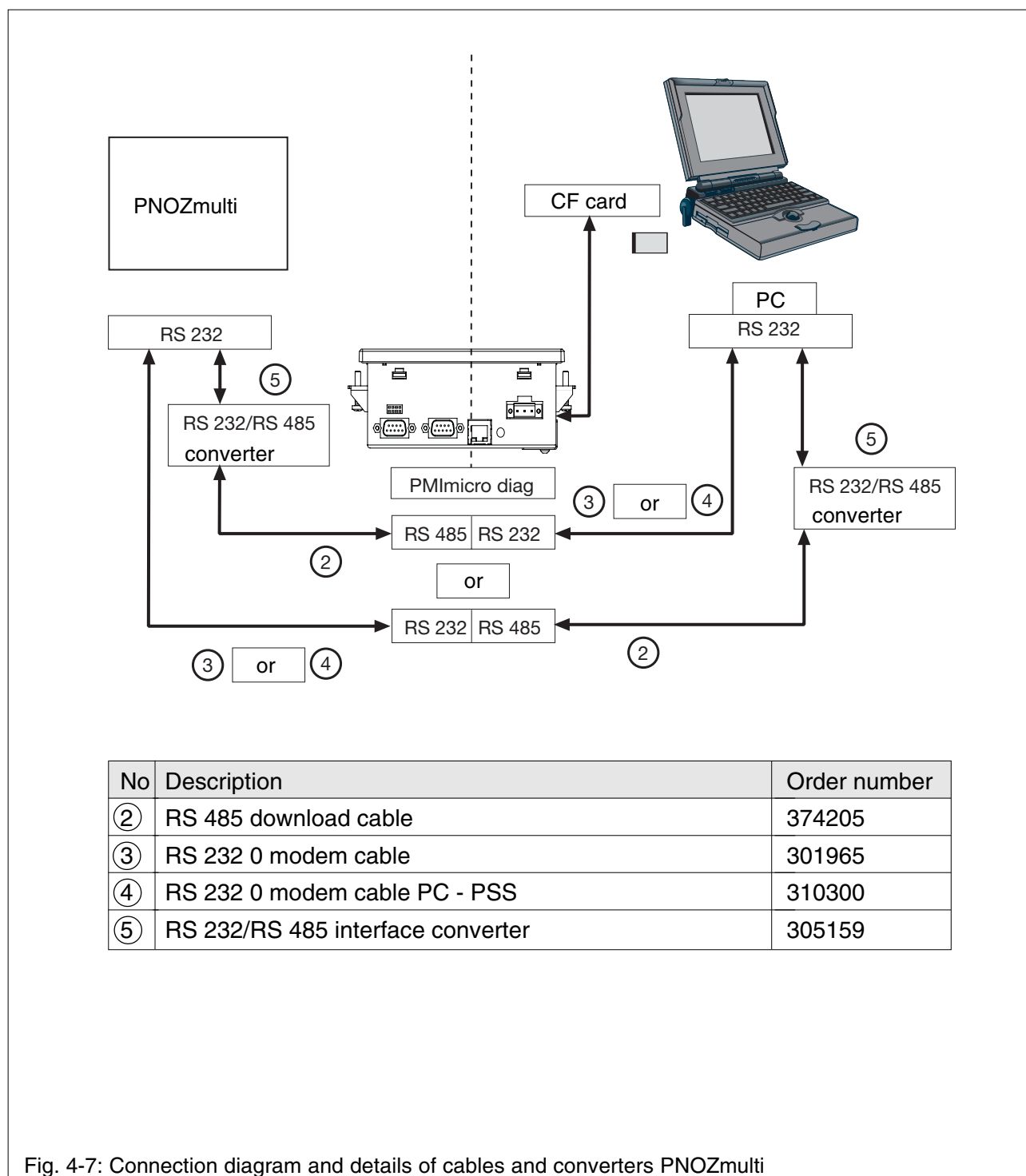
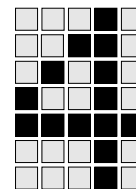

Fig. 4-7: Connection diagram and details of cables and converters PNOZmulti



Unit Description

The PMImicro diag has 2 interfaces (1 x RS 232 and 1 x RS 485). These can be used for communication with either the connected device or the PC.



INFORMATION

The interface may be configured either on the PMImicro diag or in the PMImicro Configurator.

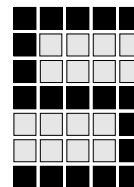

Installation and Wiring

Safety

Please read the safety guidelines before assembling and installing the PMI micro diag.

Before you install or commission the system, you should refer to any guidelines laid down by the plant manufacturer or operator.

Installation site and unit surroundings

- Keep as large a distance as possible between the system and any electromagnetic fields, particularly when frequency converters are nearby.
- To avoid the build-up of heat, a distance of 10 cm/3.94" should be maintained all round the unit.
- Protect the unit from direct sunlight and dust.
- Do not use chemicals close to the unit.
- Ensure the maximum permissible ambient and operating temperatures are not exceeded.
- Ensure that neither liquids nor objects can enter the unit at any time.
- Do **not** position the unit close to flammable materials.

Installation and Wiring

Nominal dimensions

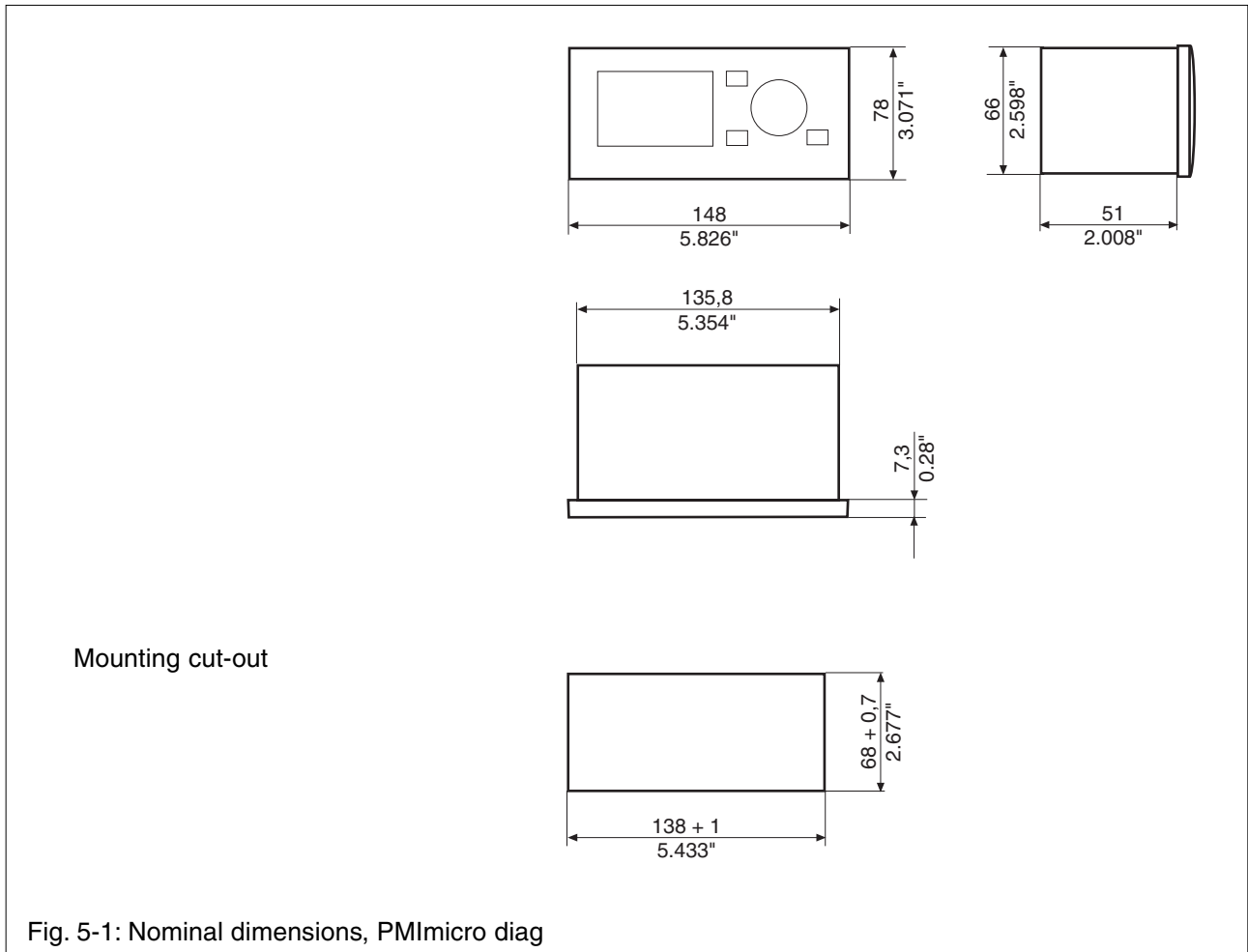
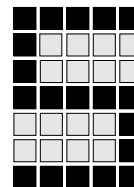

Fig. 5-1: Nominal dimensions, PMImicro diag



Installing the device

When installing the unit, please note the following:

- For reasons of stability, the front panel, console or control cabinet should have a wall thickness of at least 2.5 mm.
- To avoid a build-up of heat, a distance of a 10 cm/3.94" should be maintained all round the system.
- Ensure the information given for the ambient and operating temperatures in the technical details is observed.
- IP65 protection can only be guaranteed when
 - the fixing screws are sufficiently tightened
 - the gasket is not damaged
 - the wall thickness is at least 2.5 mm.



NOTICE

- For installation, attach the retaining clamps to the left and right of the device (see figure). Other types of attachment can lead to strain on the housing front!
- The torque setting on the fixing screws should be max. 0,25 Nm.

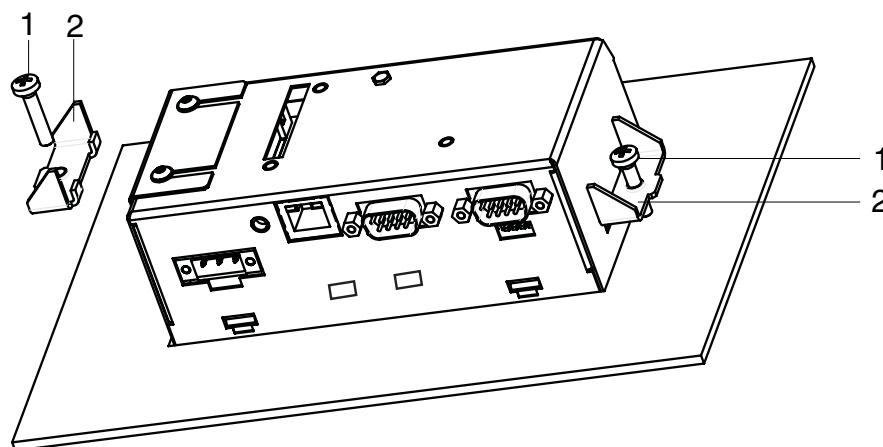

The fastening kit consists of:
1: Raised head screw (M4)
2: Retaining clamp

Fig. 5-2: Installing PMImicro diag

Installation and Wiring

Connecting the device

When connecting the PMImicro diag to the PC and to a device that supports expanded PVIS diagnostics, please refer to the connection diagram and the corresponding cable connection details (see page 4-6 ff).

Supply voltage

The 24 VDC supply voltage connection is on the side of the housing (see Fig. 4-2).

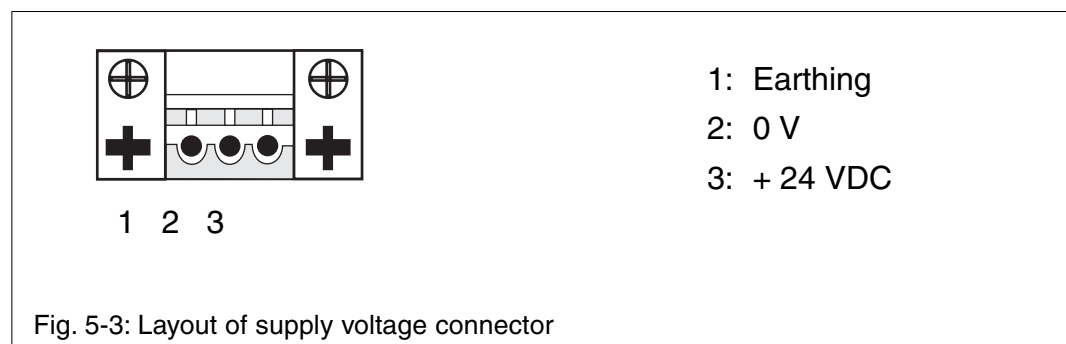

Notice

Please note the following during diagnostics on the PNOZmulti. The RS 232 interfaces on the PNOZmulti and PMImicro diag do not have galvanic isolation. If the units are connected to different voltage sources, any potential difference between the power supplies could destroy the RS 232 interface.

Connect the PNOZmulti and PMImicro diag to the same voltage source!

Cable layout

- Electrical or electronic components which could cause interference (contactors, thyristors, relay coils and solenoid valve coils) should be physically separate from data lines. We recommend you use a sheet metal (MU metal) bulkhead between both areas.

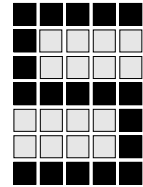

- Data lines and power lines should be laid separately to avoid capacitive and inductive transmission (recommended minimum distance = 10 cm/ 3.94").
- Screened data lines should also be laid in a different cable duct to the main power lines.
- Power lines should be as short as possible
- Power lines should be twisted pair cables.

Earth connector

- Connect the earthing socket on the housing (M4 press-fit socket on the side of the housing) to the earth bus bar on the control cabinet or unit. Use as short a copper conductor as possible (cross section min. 2.5 mm²).
- If there are several units in the control cabinet or plant, ensure the earth conductor is connected in a star formation on the bus bar.
- The earth conductor (cross section min. 2,5 mm²) should be connected to the terminal marked  on the supply voltage connector.

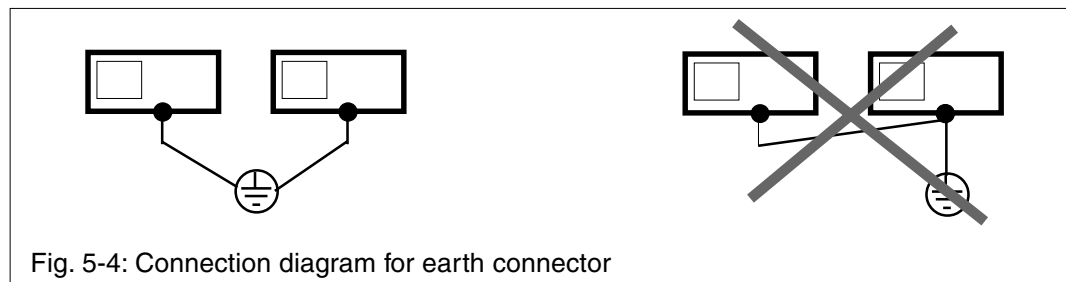

Installation and Wiring

Screening

- Connect the power cable screening with low impedance to earth.
- Use screened data lines only.
- Due to high frequency, we recommend that the screening on the data line cable (RS 232/RS 485 cable) is earthed on both sides. If you are using longer cables and there is the possibility of transient currents, we recommend one of the following methods:
 - use equipotential bonding cable
 - isolate the potentials
- Data line screening should be connected to a bus bar.
- The connection between the bus bar and the control cabinet/system should be as short as possible and with low impedance.
- Fasten the braided screening to the screen bar over as large a surface area as possible (e.g. with metal hose clips or polyurethane (PU) cable clips).

Measures to protect against interference voltages

- Wire inductive loads (e.g. contactor coils, relay coils and solenoid valve coils) using suppression elements (e.g. RC elements). This is particularly important if these inductive loads are close to the supply voltage or are fed from the same supply voltage.
- If strong magnetic fields are present, we recommend you use a bulkhead separator, i.e. metal sheet (MU-metal).

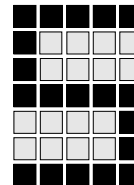

Connection example

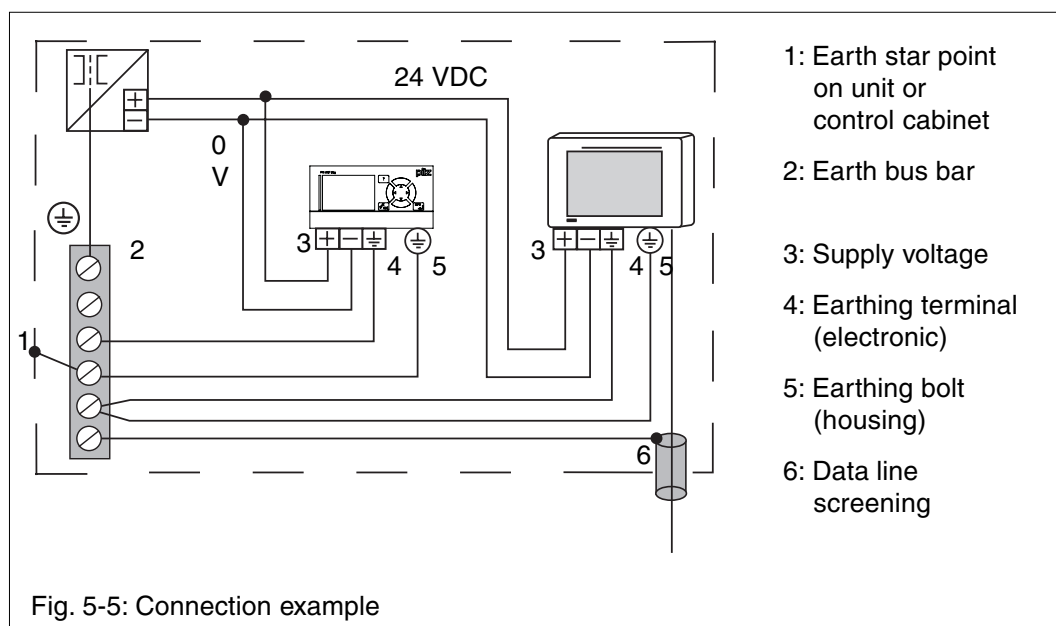

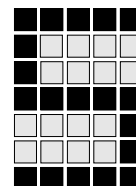

Installation and Wiring

Notes

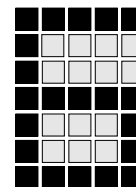

Commissioning

General

- Connect the supply voltage and the earth conductor (see page 5-4 ff).
- For diagnostics, connect the PMImicro diag to a device with expanded diagnostic options PVIS.

PSS/SafetyBUS p and PNOZmulti

- To configure the PMImicro diag, connect the PMImicro diag to a PC. Please refer to the connection diagram and the corresponding cable connection details in Chapter 4 (see page 4-6 ff).
- Activate the diagnostic function on the connected device (please refer to the online help on the system software of the connected device).

PNOZmulti vIO

- With the PNOZmulti, activate the serial interface in the module configuration.
- Use the sample project to create a diagnostic configuration and download this to the PMImicro diag (see page 7-13 ff).

Procedure after power-up

There may be a time delay of a few seconds between power-up and the unit being ready for operation, depending on the size of the text memory and the number of messages.



INFORMATION

The unit needs more time after a download than after any other type of loading. It is preparing data that will be used later.

The display system signals that the unit is ready for operation. The display shows incoming event messages.

Commissioning



INFORMATION

If an error should occur while preparing for operation, a window will appear, showing an appropriate message.

Default setting

The procedure for commissioning the PMImicro diag is “plug and play”. The unit is supplied with the following default settings:

- PMImicro configuration
 - User setting:
User name, password and access rights are specified but may be amended (see page 6-7).
Factory default setting: No password protection is activated.
 - Menu languages:
German, English; factory default setting: English
 - Interfaces:
Factory default setting: COM1(RS 232) -> Connected device, COM2 (RS 485) -> PC;
Connected device: PNOZmulti
- Device diagnostic configuration

The device diagnostic configuration supports the following default projects on the PMImicro diag (factory default setting: PSS/Safety BUS p)

- PSS/Safety BUS p:
Diagnostics for all system errors in two languages (German, English).
- PNOZmulti:
Diagnostics for all system errors in two languages (German, English).



INFORMATION

The language selected for the diagnostic language depends on the diagnostic configuration on the PMImicro diag.

If a diagnostic configuration is created in the system software of the connected device and then downloaded to the PMImicro diag, the existing languages are replaced.

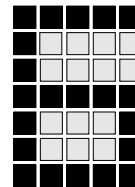

- PNOZmulti vIO:

Diagnostics for the virtual outputs on the PNOZmulti (German, English).

You can choose between these devices/projects.
(See interfaces, page 6-12)

The selected configuration is copied to the project with which runtime is operating. This means that you can switch over or restore the default diagnostic configuration as often as you wish.



INFORMATION

If you switch between projects, the settings that you made in the setup will be lost.

As it starts up, the PMImicro diag uses the selected configuration to decide which diagnostics to start.



INFORMATION

If a new diagnostic configuration (standard PSS project, standard PNOZmulti or standard PNOZmulti vIO project) is downloaded to the PMImicro diag using the PMImicro Configurator or the backup & restore function, the default diagnostic configuration will be overwritten. It will no longer be possible to choose between the two diagnostic configurations.

Commissioning

Help

Two types of help are available for the PMImicro diag:

- Help on the PMImicro diag
Call up help: press <?>
Close help: press <?> or <ESC> key, also closes after timeout
- Online help on the PMImicro Configurator
The online help on the PMImicro Configurator can be found in the system software of the connected device.

PMImicro configuration



INFORMATION

Please refer to the particular guidelines given for configuring the PNOZmulti vIO diagnostics (see page 7-25 ff).



INFORMATION

Please refer to the table showing the key functions (see page 4-1).

Hold the <ESC> key down for three seconds. This will access the main menu. The following settings may be made:

- Configuration
Setting for ***password protection, interfaces*** etc.
- Language
Setting for ***menu language*** and ***diagnostic language***



INFORMATION

The language selected for the diagnostic language depends on the diagnostic configuration on the PMImicro diag.

If a diagnostic configuration is created in the system software of the connected device and then downloaded to the PMImicro diag, the existing languages are replaced.

- Display settings
Setting for the contrast and backlighting on the display

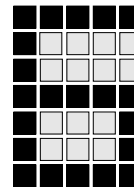

During operation you can make settings and poll information for the following menu items:

- Log files
Display, delete and export **log files**
- Versions
This is where you will find information on runtime, hardware, operating system etc.

Configuration



INFORMATION

We recommend that you configure the user settings, for example, in the PMImicro Configurator on the connected device, as it is easier to enter the data via the PC keyboard.

The following settings may be made on the PMImicro diag:

- Password protection
Two areas may be password-protected:
 - Changing the configuration of the PMImicro: **Config.**
 - Deleting and exporting the log files: **Log files**
- User setting
Three access levels may be configured for the PMImicro diag. These may be assigned different access rights.
- Interfaces
Select the connected device and configure the PMImicro diag interface:
 - for connection to the connected device (e.g. PSS)
 - for connection to the PC
- Time characteristic
Set the **operator timeout** and **flash frequency** on the display.
- System time
Set the time and date, so that this data matches in the **log files**.
- Backup & restore
The backup & restore function enables you to save the PMImicro configuration, runtime and diagnostic configuration on to a CF card and then restore the information if necessary.
- Integrity display
This is where you will find information regarding the compatibility of all components for diagnostics.

Commissioning

- Show delete information
When an event is no longer present, the corresponding event message is deleted from the event list. If the event message or remedy is displayed at this point, the information „Message deleted“ can be displayed.
- Display mode
There are three display modes to choose from to display event messages and remedies:
 - Details > description
The details (scope/responsibility, device and Equip-ID) are shown on page 1 and the description (location description and text of event message or action) on page 2.
 - Description > details
The description is shown on page 1 and the details on page 2.
 - Description only
Only the page with the description is shown.
Please note: This display mode is not recommended because it does not show the details, so important location information about the event and any remedial actions is missing.
- Max. number of entries in the event list
The maximum number of entries displayed in the event list can be configured. If the event list is longer, only the first entries are displayed.

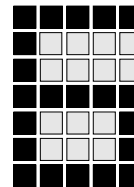

General guidelines on operation

Display when window is opened



The respective input field is selected when it is bordered by a dotted line (1).

Press <ENTER>. This will access ...

Display when input field is activated



The relevant setting is activated when the background on the input field is black (2).

Commissioning

Direction of selection in the options list

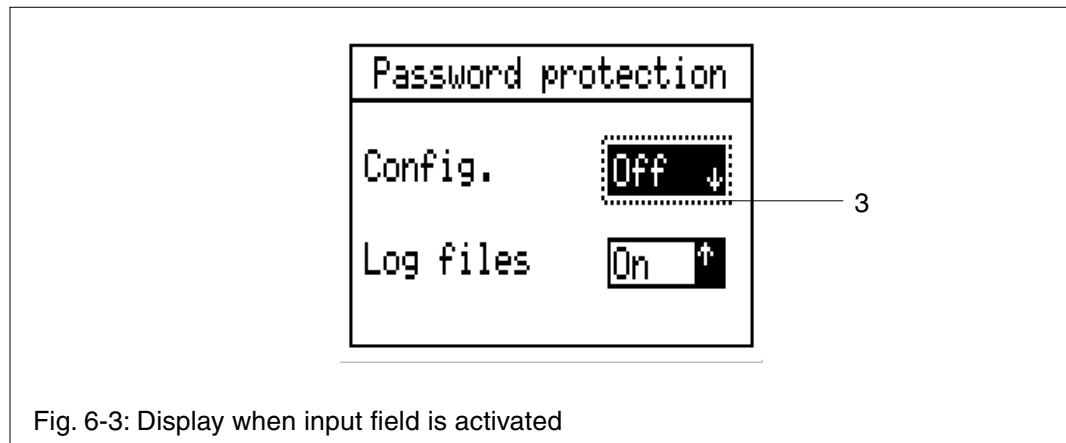

Selection via the navigation keys can only be made in the direction of the arrows (3).

- Select the required setting.
- Press <ENTER> to accept the setting.
- Press <ESC> to reject the change.

Password protection

Two areas may be password-protected:

- Changing the configuration of the PMImicro diag **Config.**
- Deleting and exporting **log files**

Proceed as follows:

1. Hold the <ESC> key down for three seconds.
This will access the main menu.
2. Using the navigation keys, select **Configuration.**
3. Press <ENTER>.
4. Using the navigation keys, select **Password protection.**
5. Press <ENTER>.
6. Two areas are available for selection:



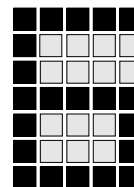



Config.
Log files



7. The selection window for **Config** is pre-selected.
8. Press <ENTER> and the selection window turns black.
9. Using the navigation keys, select **ON/OFF**.
10. Press <ENTER>. Your selection is saved.
11. Using the navigation keys, select the window for **Log files**.
12. Press <ENTER> and the selection window turns black.
13. Using the navigation keys, select **ON/OFF**.
14. Press <ENTER>. Your selection is saved.
15. Press <ESC> to exit the menu.

User setting

Three access levels may be configured for the PMImicro diag. These may be assigned different access rights. The default user and settings are:

| User | Password | Access right | Display |
|----------------|----------|--------------|---|
| CONFIG | 100000 | 0 | -   |
| LOGFILE | 200000 | 1 | -   |
| ADMIN | 300000 | 0 and 1 | -   |

The areas for access rights are given as follows:

- 0: PMImicro configuration
- 1: Delete and export log files

Commissioning

Select user

Proceed as follows:

1. Hold the <ESC> key down for three seconds. This will access the main menu.
2. Using the navigation keys, select **Configuration**.
3. Press <ENTER>.
4. Using the navigation keys, select **User setting**.
5. Press <ENTER>.
6. Three users are available for selection.
7. Using the navigation keys, select the user whose settings you wish to change, e.g. **03 - ADMIN**

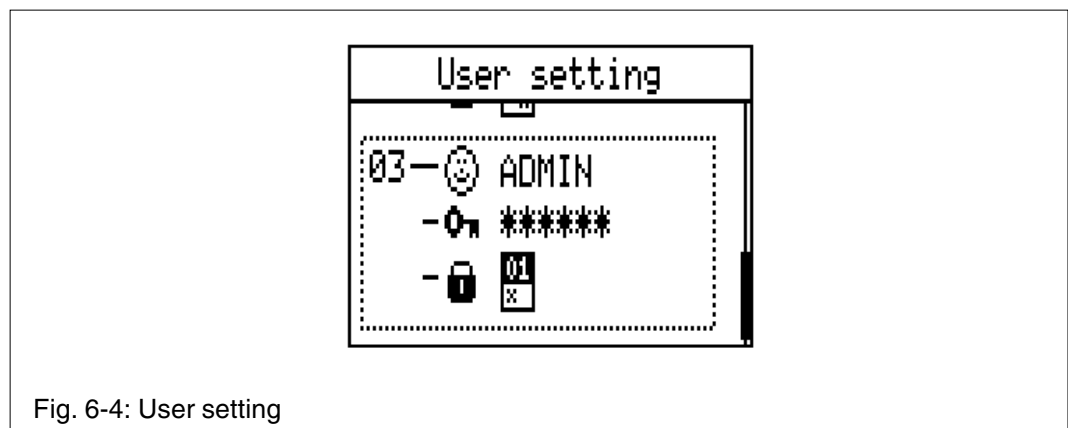
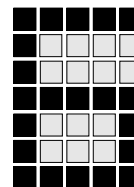

Fig. 6-4: User setting



Change user name

Proceed as follows:

1. Select a user (see page 6-9).

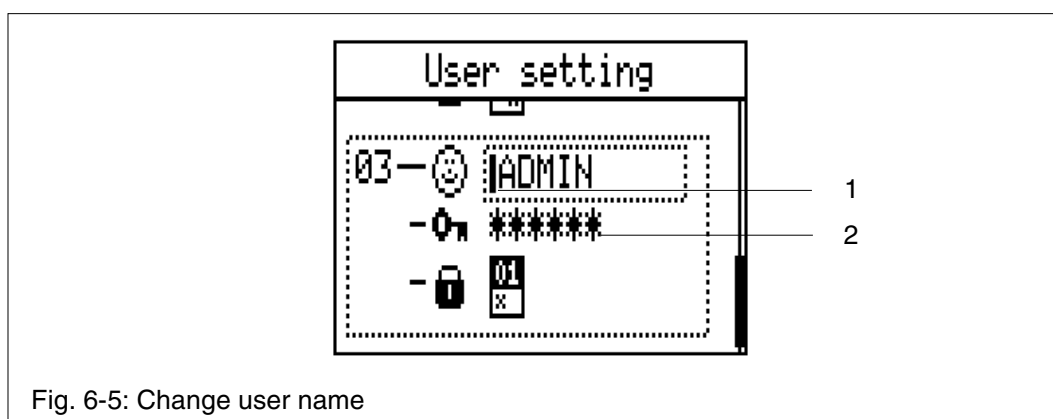

Fig. 6-5: Change user name

2. Press <ENTER>; the user name is selected and a cursor appears (1). The user name can be changed as follows:

Replace character:

Select the character using the navigation keys ◀ ▶.

Select the new character using the navigation keys ▲ ▼.

Delete character:

Using the navigation keys ◀ ▶, place the cursor next to the character that is to be deleted.

Press ▼.

Insert character:

Using the navigation keys, place the cursor next to a character and press ▲.

The following characters can be selected:

- A ... Z
- _
- 0 ... 9

3. Press <ENTER>.
Your selection is saved.

Commissioning

4. Press <ESC> to exit user name selection.
5. Press <ESC> to exit the menu.

Change password

Proceed as follows:

1. Select a user (see page 6-9).
2. Using the navigation keys, select Password.
3. Press <ENTER>. The password (2) becomes visible and can be changed. The cursor flashes at the spot at which a character can be replaced. Proceed as follows:

Replace character:

Select the character using the navigation keys ◀ ▶.

Select the new character using the navigation keys ▲ ▼.

The password has six characters. The following characters can be selected:

- A ... Z
- 0 ... 9

4. Press <ENTER>.
Your selection is saved.
5. Press <ESC> to exit password selection.
6. Press <ESC> to exit the menu.

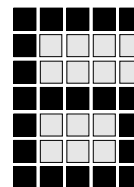

Change access rights

Proceed as follows:

1. Select a user (see page 6-9).

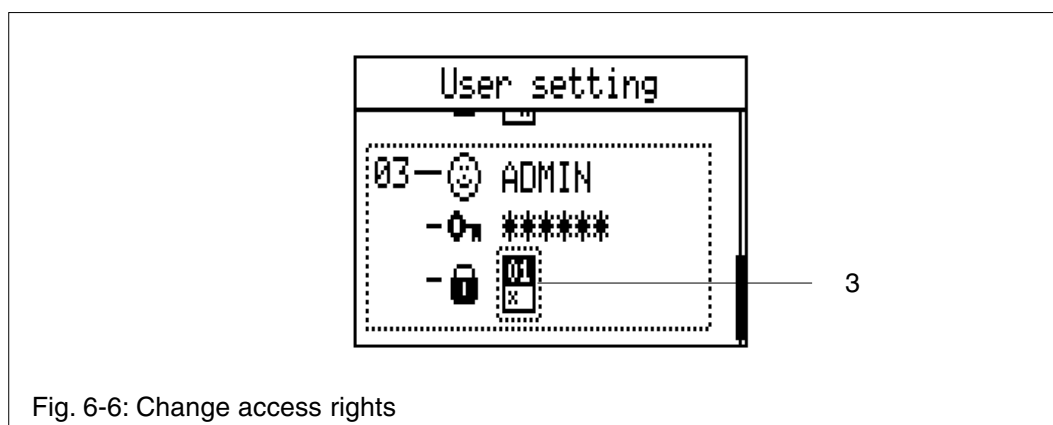

Fig. 6-6: Change access rights

2. Using the navigation keys, select the access right (3).
3. Press <ENTER>; the access right can be changed.

Two access rights can be assigned:

- 0: PMImicro configuration
- 1: Delete and export log files

Example:

| | |
|--|---|
| | Access right 0 selected Access right 1 de-selected |
| | Access right 0 de-selected Access right 1 selected |

Select the area using the navigation keys ◀ ▶.

The field turns black.

Using the navigation keys ▲ ▼, select or de-select the access right for the area.

4. Press <ENTER>.
Your selection is saved.

Commissioning

5. Press <ESC> to exit access right selection.
6. Press <ESC> to exit the menu.

Interfaces

Configure the interfaces on the PMImicro diag:

- for connection to the connected device
- for connection to the PC

The following settings may be made:

- **Connected device**
 - COM1 (RS 232)
 - COM2 (RS 485)
 - PSS or PNOZmulti vIO
- **PC interface** (PC connection)
 - COM1 (RS 232)
 - COM2 (RS 485)



INFORMATION

If you select COM1 as the interface for the connected device, COM2 will automatically be set as the interface for the PC, and vice versa.

Interface for the connected device

Proceed as follows:

1. Hold the <ESC> key down for three seconds. This will access the main menu.
2. Using the navigation keys, select **Configuration**.
3. Press <ENTER>.
4. Using the navigation keys, select **Interfaces**.
5. Press <ENTER>.
6. The selection window for the interface of the **Connected device** is pre-selected.
7. Press <ENTER> and the selection window turns black.
8. Using the navigation keys, select the required interface for communication with the connected device.

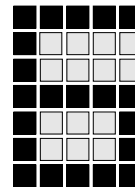

9. Press <ENTER>. Your selection is saved.
A prompt appears, asking if you wish to restart the PMImicro diag.
10. Using the navigation keys, select **YES**.
11. Press <ENTER>.
12. The PMImicro diag is restarted.



INFORMATION

If you use the navigation keys to select **NO** under step 10, the unit will not be restarted.
You will need to restart the PMImicro diag later in order to activate the interface selection.

Select connected device



INFORMATION

If the default diagnostic configuration has been overwritten by a new diagnostic configuration, it will no longer be possible to choose between the connected devices.

Proceed as follows:

1. Hold the <ESC> key down for three seconds. This will access the main menu.
2. Using the navigation keys, select **Configuration**.
3. Press <ENTER>.
4. Using the navigation keys, select **Interfaces**.
5. Press <ENTER>.
6. Using the navigation keys, select the window for the connected device.
7. Press <ENTER> and the selection window turns black.
8. Using the navigation keys, select the connected device that you require.



INFORMATION

Entries are identified with * before their name, to distinguish them from the configuration that is currently in use.

9. Press <ENTER>. Your selection is saved.
A prompt appears, asking if you wish to restart the PMImicro diag.
10. Using the navigation keys, select **YES**.

Commissioning

11. Press <ENTER>.
12. The PMImicro diag is restarted.



INFORMATION

If you use the navigation keys to select **NO** under step 10, the unit will not be restarted.

You will need to restart the PMImicro diag later in order to activate the selection of the connected device.

PC interface

Proceed as follows:

1. Hold the <ESC> key down for three seconds. This will access the main menu.
2. Using the navigation keys, select **Configuration**.
3. Press <ENTER>.
4. Using the navigation keys, select **Interfaces**.
5. Press <ENTER>.
6. Using the navigation keys, select **PC interface**.
7. Press <ENTER> and the selection window turns black.
8. Using the navigation keys, select the required interface for PC communication.
9. Press <ENTER>. Your selection is saved.
A prompt appears, asking if you wish to restart the PMImicro diag.
10. Using the navigation keys, select **YES**.
11. Press <ENTER>.
12. The PMImicro diag is restarted.



INFORMATION

If you use the navigation keys to select **NO** under step 10, the unit will not be restarted.

You will need to restart the PMImicro diag later in order to activate the interface selection.

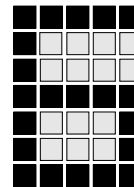

Time characteristics

Set the ***operator timeout*** and ***flash frequency***.

Operator timeout

Once you have operated a key on the PMImicro diag, the PMImicro diag waits for the next entry. If this entry does not occur within the set ***Operator timeout***, the display on the PMImicro diag will return to the highest-priority event message.



INFORMATION

If you are in a password-protected area, you will need to log in again if the ***Operator timeout*** has elapsed.

Proceed as follows:

1. Hold the <ESC> key down for three seconds. This will access the main menu.
2. Using the navigation keys, select ***Configuration***.
3. Press <ENTER>.
4. Using the navigation keys, select ***Time characteristics***.
5. Press <ENTER>.
6. The selection window for ***Operator timeout*** is pre-selected.
7. Press <ENTER> and the selection window turns black.
8. Using the navigation keys, set the required value.

The following values are available for selection:

- 5 minutes
- 2 minutes
- 90 seconds
- 60 seconds
- 30 seconds

9. Press <ENTER>.
Your selection is saved.
10. Press <ESC> to exit the menu.

Commissioning

Flash frequency

Set the display's flash frequency.

Proceed as follows:

1. Hold the <ESC> key down for three seconds. This will access the main menu.
2. Using the navigation keys, select **Configuration**.
3. Press <ENTER>.
4. Using the navigation keys, select **Time characteristics**.
5. Press <ENTER>.
6. Using the navigation keys, select the window for **Flash frequency**.
7. Press <ENTER> and the selection window turns black.
8. Using the navigation keys, set the required value.

The following values are available for selection:

- High
- Normal
- Low

A symbol is displayed, showing the corresponding flash frequency.

9. Press <ENTER>.
Your selection is saved.
10. Press <ESC> to exit the menu.

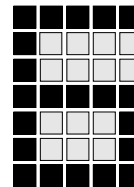

System time

Set the time and date, so that this data matches in the *log files*.

Proceed as follows:

1. Hold the <ESC> key down for three seconds. This will access the main menu.
2. Using the navigation keys, select **Configuration**.
3. Press <ENTER>.
4. Using the navigation keys, select **System time**.
5. Press <ENTER>.
6. The selection window for **Date** is pre-selected.
7. Press <ENTER>; the numeric value that can be changed is flashed and shaded black.
8. Using the navigation keys, set the required date.

Date format

YYYY-MM-DD

9. Press <ENTER>.
Your selection is saved.
10. Using the navigation keys, select the window for **Time**.
11. Press <ENTER>; the numeric value that can be changed is flashed and shaded black.
12. Using the navigation keys, set the required time.

Time format

hh : mm : ss

13. Press <ENTER>.
Your selection is saved.
14. Press <ESC> to exit the menu.

Commissioning

Backup & restore

The backup & restore function enables you to save the PMImicro diag configuration, runtime and diagnostic configuration on to a CF card and, if necessary, to restore this information to the PMImicro diag or download it to other PMImicro diags.

Backup (save data from PMImicro diag to CF card)



NOTICE

Switch off the PMImicro diag before inserting or exchanging the CF card. Data on the CF card will be lost or the CF card itself may be damaged if you insert or exchange the CF card while the PMImicro diag is switched on.

Proceed as follows:

1. Hold the <ESC> key down for three seconds. This will access the main menu.
2. Using the navigation keys, select **Configuration**.
3. Press <ENTER>.
4. Using the navigation keys, select **Backup & Restore**.
5. Press <ENTER>.
6. The selection window for backup or restore is pre-selected.
7. Press <ENTER> and the selection window turns black.

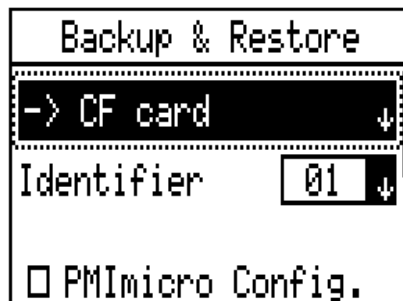
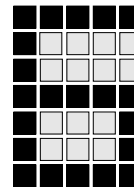

Fig. 6-7: Backup (save data from PMImicro diag to CF card)



8. Using the navigation keys, select the window for the direction (-> **CF card**).
Data can then be written from the PMImicro diag to the CF card.
9. Press <ENTER>.
10. Using the navigation keys, select the window for **Identifier**.
11. Press <ENTER> and the selection window turns black.
12. Using the navigation keys, set the required identifier.

The identifier labels the selected data. This way, several backups can be stored and managed on one CF card.

The following identifiers are available for selection: 01 ... 10

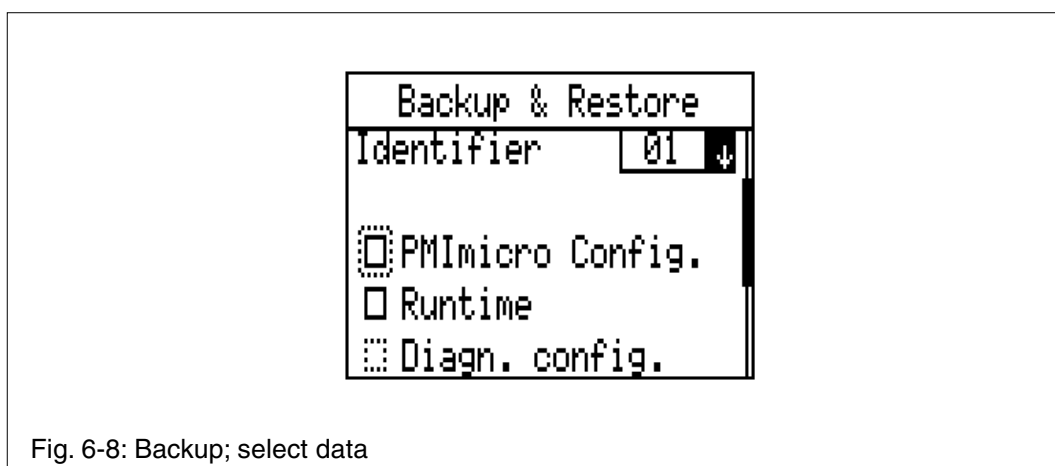

Fig. 6-8: Backup; select data

13. Press <ENTER>.
14. Using the navigation keys, select the data you wish to copy.
15. Press <ENTER>; the option is selected.

Commissioning

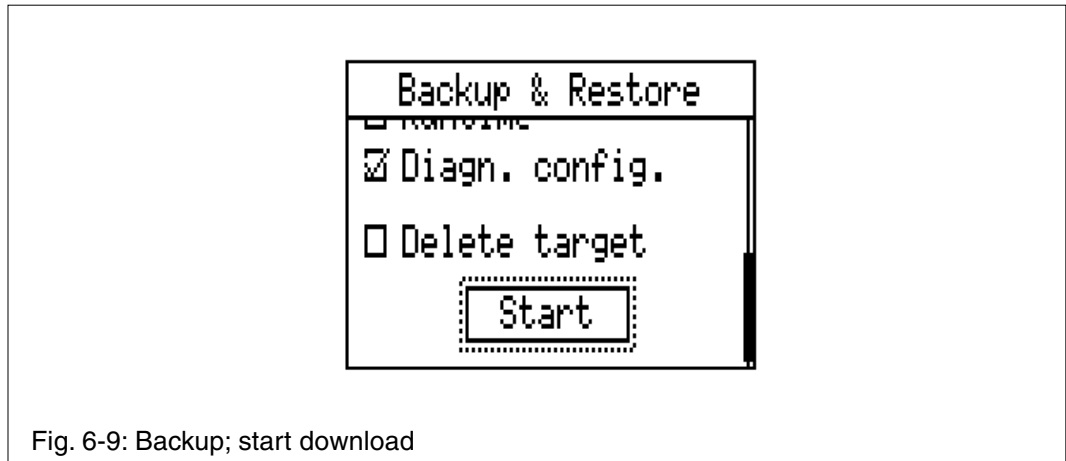

Fig. 6-9: Backup; start download

16. Using the navigation keys, select **Delete target** (only possible from PMImicro diag -> CF card). The following options are available:

Delete target selected: All data with the selected identifier is deleted before the information is copied to the CF card.

Delete target deselected: Only selected data with the selected identifier, such as the PMImicro configuration, runtime and diagnostic configuration, is deleted before the information is copied to the CF card.

17. Press <ENTER>; the option is selected.

18. Using the navigation keys, select **Start**.

19. Press <ENTER>.

20. A window appears with a prompt, asking if you wish to send the data.

21. Using the navigation keys, select **Yes/No** and then confirm your selection by pressing <ENTER>.

YES: The data is downloaded.

No: The data is not downloaded.

22. Press <ENTER> to confirm the message.

23. Press <ESC> to exit the menu.

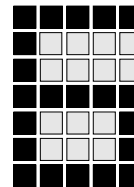

Restore (save data from CF card to PMImicro diag)



NOTICE

Switch off the PMImicro diag before inserting or exchanging the CF card. Data on the CF card will be lost or the CF card itself may be damaged if you insert or exchange the CF card while the PMImicro diag is switched on.

Proceed as follows:

1. Hold the <ESC> key down for three seconds. This will access the main menu.
2. Using the navigation keys, select **Configuration**.
3. Press <ENTER>.
4. Using the navigation keys, select **Backup & Restore**.
5. Press <ENTER>.
6. The selection window for backup or restore is pre-selected.

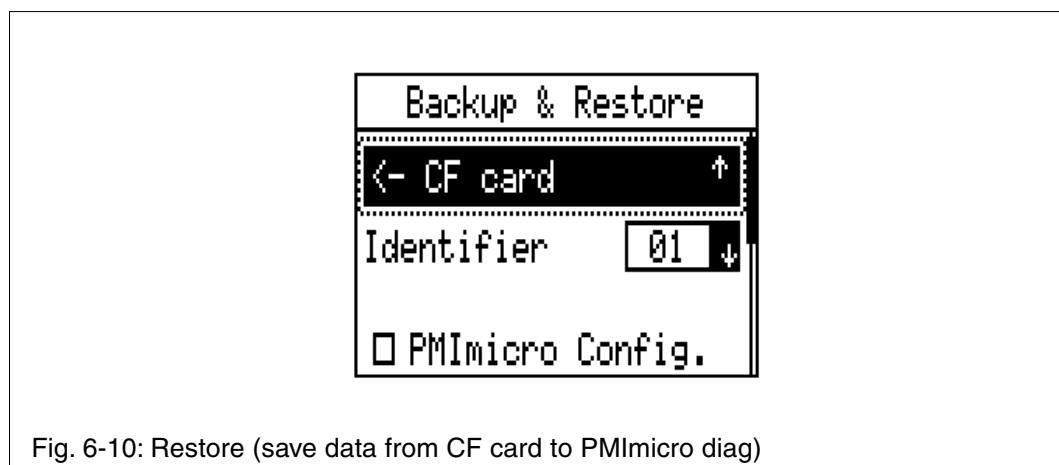

Fig. 6-10: Restore (save data from CF card to PMImicro diag)

7. Press <ENTER> and the selection window turns black.
8. Using the navigation keys, select the window for the direction (**<- CF card**).
Data can then be written from the CF card to the PMImicro diag.
9. Press <ENTER>.
10. Using the navigation keys, select the window for **Identifier**.

Commissioning

11. Press <ENTER> and the selection window turns black.
12. Using the navigation keys, set the required identifier.

Only the identifiers for the files that are on the CF card are available.

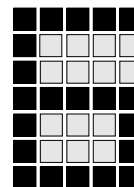

Fig. 6-11: Restore; select data

13. Press <ENTER>.
14. Using the navigation keys, select the data you wish to copy.
Only the data that is on the CF card is available to select.
15. Press <ENTER>; the option is selected.



Fig. 6-12: Restore; start download



-
16. Using the navigation keys, select **Start**.
 17. Press <ENTER>.
 18. A window appears with a prompt, asking if you wish to send the data.
 19. Using the navigation keys, select **Yes/No** and then confirm your selection by pressing <ENTER>.
 - YES:** The data is downloaded.
 - No:** The data is not downloaded.
 20. Press <ENTER> to confirm the message.
 21. Press <ESC> to exit the menu.

Commissioning

Integrity display PSS/SafetyBUS p

A test is carried out to check that all the components for diagnostics are compatible. The diagnostic configuration on the connected device, the diagnostic configuration on the PMI micro diag and the program on the connected device must all be compatible in order for diagnostics to be performed correctly. The display is divided into:

Status

Shows the status for the following components (using a PSS as an example of a connected device):

- FS (user program for the failsafe section of the PSS)
- ST (user program for the standard section of the PSS)
- PSS (diagnostic configuration in the PSS)
- PMI (diagnostic configuration in the PMI micro diag)

The following status conditions may be displayed:

| Status | Key |
|-----------------|---|
| OK | The component is in order. |
| Invalid project | The component belongs to another project. |
| Obsolete | The component is obsolete. |
| No information | No information is available on the current configuration - diagnostics cannot be performed. |

Download point

Shows the time and date of the download of the following components (using a PSS as an example of a connected device):

- FS (user program for the failsafe section of the PSS)
- ST (user program for the standard section of the PSS)
- PSS (diagnostic configuration in the PSS)
- PMI (diagnostic configuration in the PMI micro diag)

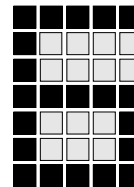

Project name

Shows the name of the following components (using a PSS as an example of a connected device):

- FS (user program for the failsafe section of the PSS)
- ST (user program for the standard section of the PSS)
- PSS (diagnostic configuration in the PSS)
- PMI (diagnostic configuration in the PMImicro diag)

PNOZmulti integrity display

A test is carried out to check that all the components for diagnostics are compatible. The diagnostic configuration on the PMImicro diag must be compatible with the program containing the diagnostic configuration on the connected device in order for diagnostics to be performed correctly. The display is divided into:

Status

Indicates the status for the following components:

- PNOZ (program and diagnostic configuration in the PNOZmulti)
- PMI (diagnostic configuration in the PMImicro diag)

The following status conditions may be displayed:

| Status | Meaning |
|-----------------|---|
| OK | The component is in order. |
| Invalid project | The component belongs to another project. |
| No information | There is no information available on the current configuration - diagnostics cannot be performed. |

Commissioning

CRC

Displays the check sum of the following components:

- PNOZ (program and diagnostic configuration in the PNOZmulti)
- PMI (diagnostic configuration in the PMImicro diag)

Project name

Displays the name of the following components:

- PNOZ (program and diagnostic configuration in the PNOZmulti)
- PMI (diagnostic configuration in the PMImicro diag)

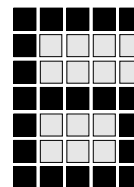

Show delete information

Select whether or not to show delete information.

Proceed as follows:

1. Hold the <ESC> key down for three seconds.
This will access the main menu.
2. Using the navigation keys, select **Configuration**.
3. Press <ENTER>.
4. Using the navigation keys, select **Delete information**.
5. Press <ENTER>.
6. Press <ENTER> to select or deselect the “Show Info” option.



Fig. 6-13: Show delete information

Display mode

Set the display mode.

Proceed as follows:

1. Hold the <ESC> key down for three seconds.
This will access the main menu.
2. Using the navigation keys, select **Configuration**.
3. Press <ENTER>.
4. Using the navigation keys, select **Display mode**.
5. Press <ENTER>.
6. The selection window for display mode is pre-selected.
7. Press <ENTER> and the selection window turns black.
8. Using the navigation keys, set the required Display mode.

Commissioning

9. Press <ENTER>. Your selection is saved.
A prompt appears, asking if you wish to restart the PMImicro diag.
10. Using the navigation keys, select **YES**.
11. Press <ENTER>.
12. The PMImicro diag is restarted.



INFORMATION

If you use the navigation keys to select **NO** under step 10, the unit will not be restarted.

You will need to restart the PMImicro diag later in order to activate the interface selection.

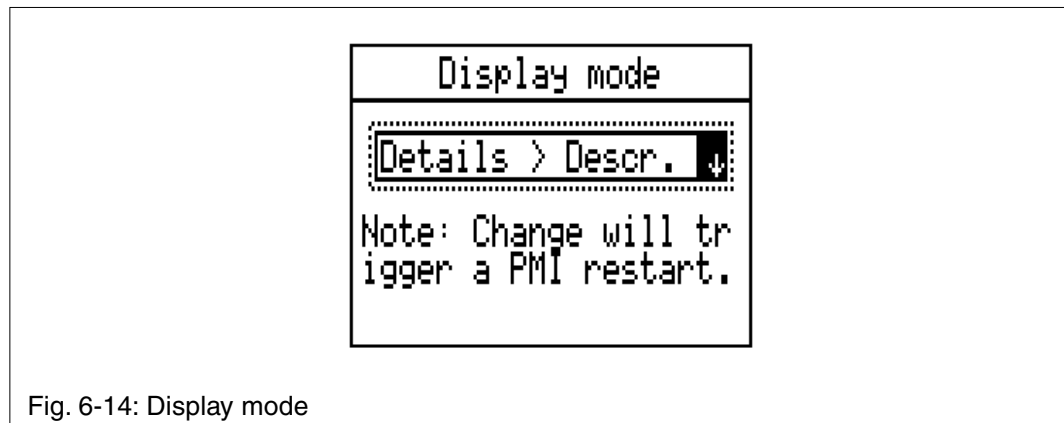

Fig. 6-14: Display mode

Max. number of entries in the event list

Set the max. number of entries in the event list.

Proceed as follows:

1. Hold the <ESC> key down for three seconds.
This will access the main menu.
2. Using the navigation keys, select **Configuration**.
3. Press <ENTER>.
4. Using the navigation keys, select **Event list**.
5. Press <ENTER>.
6. Press <ENTER> again; the first digit will flash.
7. Replace digits:
Use the navigation keys ◀ ▶ to select the digit.
Use the navigation keys ▲ ▼ to select the new digit value.

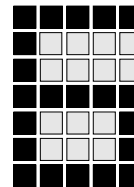

The following values can be selected:

- Digit 1 (hundreds digit): 0 ... 1
- Digit 2 (tens digit): 0 ... 9
- Digit 3 (ones digit): 0 ... 9

8. Press <ENTER>. Your selection is saved.

A prompt appears, asking if you wish to restart the PMI micro diag.

9. Using the navigation keys, select **YES**.

10. Press <ENTER>.

11. The PMI micro diag is restarted.



INFORMATION

- In Step 9, if you select **NO** with the navigation keys, the unit will not be restarted.
In this case, the length of the event list will automatically be reset to the previous value.
- If digit 1 has the value 1, digits 2 and 3 cannot be set to values greater than 0.
- If digits 2 or 3 are greater than 0, digit 1 cannot be set to 1.



Fig. 6-15: Max. number of entries in the event list

Commissioning

Language

Menu language

The menu language is the language in which the main menu on the PMImicro diag is displayed.



INFORMATION

The languages that are available for selection depend on the the languages that are loaded on the PMImicro diag. A maximum of two languages are possible.

Proceed as follows:

1. Hold the <ESC> key down for three seconds. This will access the main menu.
2. Using the navigation keys, select **Language**.
3. Press <ENTER>.
4. The selection window for **Menu language** is pre-selected.
5. Press <ENTER> and the selection window turns black.
6. Using the navigation keys, select the required language.
7. Press <ENTER>.
Your selection is saved.
8. Press <ESC> to exit the menu.

Diagnostic language

The diagnostic language is the language in which the event messages and actions are displayed.



INFORMATION

The language selected for the diagnostic language depends on the diagnostic configuration on the PMImicro diag.

If a diagnostic configuration is created in the system software of the connected device and then downloaded to the PMImicro diag, the existing languages are replaced.

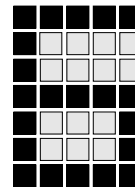

Display settings

To achieve optimum legibility, the screen must be adjusted to the respective working environment. Set the display's contrast and backlighting.

Proceed as follows:

1. Hold the <ESC> key down for three seconds. This will access the main menu.
2. Using the navigation keys, select **Display-Set**.
3. Press <ENTER>.
4. The selection window for **Contrast** is pre-selected.
5. Press <ENTER>; the bar that indicates the value will flash.
6. Using the navigation keys, select the required value.
7. Press <ENTER>.
The selection is saved.
8. Using the navigation keys, select the window for **Lighting**.
9. Press <ENTER> and the selection window turns black.

The following options can be selected:

- Off
Backlighting is always off
- Dimmed
Backlighting is always dimmed
- On
Backlighting is always on
- Dimmed -> Off
Backlighting switches from dimmed to off once the **Operator timeout** has elapsed
- On -> Dimmed
Backlighting switches from on to dimmed once the **Operator timeout** has elapsed
- On -> Off
Backlighting switches from on to off once the **Operator timeout** has elapsed

Commissioning

10. Press <ENTER>. Your selection is saved.
11. Press <ESC> to exit the menu.

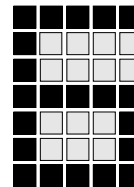

Log files

The **log file** is a file in which events are stored, with time details. If the PMImicro configuration and the diagnostic configuration support multiple languages, the language may later be switched for viewing and exporting the log files.

There are two log files on the PMImicro diag:

- **PMImicro diag log file**
- **Diagnostic log file**



INFORMATION

All users can read the log files at any time, but the deletion and export of the log files may be password-protected (for user setting see page 6-8, for password protection see page 6-7).

PMImicro diag log file

This is where the start behaviour for the PMImicro diag is recorded, along with any errors that occur in the process.

Proceed as follows:

1. Hold the <ESC> key down for three seconds. This will access the main menu.
2. Using the navigation keys, select **Log files**.
3. Press <ENTER>.
4. The selection window for **Log files** is pre-selected.
5. Press <ENTER> and the selection window turns black.
6. Using the navigation keys, select the **PMImicro diag** log file.
7. Press <ENTER>.
8. Using the navigation keys, select the required action:

Display

The entries are displayed in the menu language that is currently selected, showing details of time and date.

Commissioning

9. Press <ENTER>. This accesses the first entry. If the entry is too long to be displayed on one page, the entry will be continued on an additional page.
10. Press <ENTER>; this accesses the entry's second page.
11. Press <ENTER> or <ESC> to return to the first page. The display will also return to the first page after a 15 second timeout.
12. Use the navigation keys to switch between the entries.
13. Press <ESC> to exit the display.

Delete

14. Press <ENTER>.
15. A window appears with a prompt, asking if you wish to delete the files.
16. Using the navigation keys, select **Yes/No** and then confirm your selection by pressing <ENTER>.
YES: The files are deleted.
No: The files are not deleted.
17. Press <ESC> to exit the menu.

Export

The entries are saved on to a CF card in the menu language that is currently selected (see page 6-19).



NOTICE

Switch off the PMImicro diag before inserting or exchanging the CF card. Data on the CF card will be lost or the CF card itself may be damaged if you insert or exchange the CF card while the PMImicro diag is switched on.

18. Press <ENTER>.
19. The selection window for **Identifier** is pre-selected.
(for identifier see page 6-20)
20. Press <ENTER>.

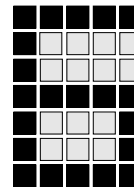

21. Using the navigation keys, set the required identifier.
22. Press <ENTER>.
23. Using the navigation keys, select **Start**.
24. Press <ENTER>.
25. A window appears with a prompt, asking if you wish to perform the action.
26. Using the navigation keys, select **Yes/No** and then confirm your selection by pressing <ENTER>.
YES: The entries are exported.
No: The entries are not exported.
27. Press <ENTER> to confirm the message.
28. Press <ESC> to exit the menu.

Diagnostic log file

This is where the diagnostics are recorded, i.e. details of which event message has been added/deleted and when.



INFORMATION

The diagnostic log file contains the event messages plus a description of the event.



INFORMATION

When performing diagnostics on the PNOZmulti a location description is also displayed. The location description is created by the user himself and is entered in the PNOZmulti Configurator.

Proceed as follows:

1. Hold the <ESC> key down for three seconds. This will access the main menu.
2. Using the navigation keys, select **Log files**.
3. Press <ENTER>.
4. The selection window for **PMImicro diag** is pre-selected.
5. Press <ENTER> and the selection window turns black.
6. Using the navigation keys, select the **Diagnostic** log file.
7. Press <ENTER>.
8. Using the navigation keys, select the required action:

Commissioning

Display

The event messages are displayed in the diagnostic language that is currently selected, showing details of time and date.

9. Press <ENTER>. This accesses the most recent event message.
10. Press <ENTER>. This accesses the displayed event description:
 - <<+>> indicates that the event description is new.
 - <<->> indicates that the event description has been deleted.
11. Press <ENTER> or <ESC> to return to the event message. The display will also return to the first event message after a 15 second timeout .
12. Use the navigation keys to switch between the event messages.
13. Press <ESC> to exit the display.

Delete

14. Press <ENTER>.
15. A window appears with a prompt, asking if you wish to delete the files.
16. Using the navigation keys, select **Yes/No** and then confirm your selection by pressing <ENTER>.
 - YES:** The files are deleted.
 - No:** The files are not deleted.
17. Press <ESC> to exit the menu.

Export

The event messages are saved on to a CF card in the diagnostic language that is currently selected (see page 6-19).



NOTICE

Switch off the PMImicro diag before inserting or exchanging the CF card. Data on the CF card will be lost or the CF card itself may be damaged if you insert or exchange the CF card while the PMImicro diag is switched on.

18. Press <ENTER>.
19. The selection window for **Identifier** is pre-selected.
 - (for identifier see page 6-18)
20. Press <ENTER>.
21. Using the navigation keys, set the required identifier.
22. Press <ENTER>.

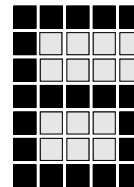

-
23. Using the navigation keys, select **Start**.
 24. Press <ENTER>.
 25. A window appears with a prompt, asking if you wish to perform the action.
 26. Using the navigation keys, select **Yes/No** and then confirm your selection by pressing <ENTER>.
 - YES:** The event messages are exported.
 - No:** The event messages are not exported.
 27. Press <ENTER> to confirm the message.
 28. Press <ESC> to exit the menu.

Versions

This is where you will find information on runtime, hardware, operating system etc. -> for service purposes.

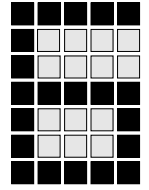

Commissioning

Notes

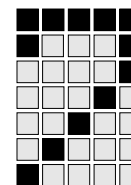

Operation

Download data

When downloading data, please refer to the connection diagram in Chapter 4 (see page 4-6 ff).

When downloading data with a CF card, please refer to the guidelines in Chapter 4 (see page 4-3).



NOTICE

Switch off the PMImicro diag before inserting or exchanging the CF card. Data on the CF card will be lost or the CF card itself may be damaged if you insert or exchange the CF card while the PMImicro diag is switched on.

Diagnostic configuration

The diagnostic configuration enables the PMImicro diag to perform diagnostics.

The diagnostic configuration is created on the PC in the relevant system software for the connected device; it is then downloaded to the PMImicro diag via a serial interface or CF card, using the PMImicro Configurator.

PMImicro configuration

The PMImicro configuration comprises settings such as password settings, language, interfaces and user settings, which are required for the PMImicro diag. The PMImicro configuration can be made directly on the diagnostic terminal via the navigation and function keys.

The PMImicro configuration can also be created on the PC in the PMImicro Configurator of the relevant system software for the connected device; it can then be downloaded to the PMImicro diag via a serial interface or CF card.

Operation

Log files

Please refer to Chapter 6 for details of the log files (see page 6-30 ff).

PMImicro diag log file

This is where the start behaviour for the PMImicro diag is recorded, along with any errors that occur in the process. The log can be exported to a CF card.

Diagnostic log file

This is where the diagnostics are recorded, i.e. details of which event message has been added/deleted and when. The log can be exported to a CF card.

Runtime

This is the software that enables the PMImicro diag to run. The runtime can be saved on to a CF card and restored if necessary. Please refer to Chapter 6 for details of the backup & restore function (see page 6-19 ff).

Communication relating to runtime: Connected device <-> PMImicro diag

To perform diagnostics for a connected device, the PMImicro diag communicates with the relevant interface on the connected device.

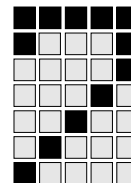

Routing function: PC <-> Connected device via PMImicro diag

Data can be looped through transparently so that a connected PC can also access the connected device directly.

When the data download starts, the PMImicro diag recognises that the data has to be passed on. It exits diagnostic mode and switches to routing mode. If routing mode is inactive for an extended period, the PMImicro diag switches back to diagnostic mode due to the timeout.



INFORMATION

For the routing function, the maximum timeout period for the PG interface must be set in PSS WIN-PRO.

The PNOZmulti requires a configurator that supports the PVIS expanded diagnostics.

Operation

Diagnostics PSS/SafetyBUS p and PNOZmulti

Event messages are sent to the diagnostic terminal from the connected programmable safety system. The event message is evaluated in the diagnostic terminal. In most cases, the corresponding event message is displayed in accordance with the diagnostic configuration and is entered in the event list. The event message contains a description of the event. A remedy can be displayed for each event message. The remedy describes how to react to the event. The remedy contains a maximum of 8 steps, the so-called “Actions”.

To ensure diagnostics can be performed, please ensure the following:

- The PMImicro diag must be connected to the PG interface on the programmable safety system.
- The PMImicro diag for diagnostics on the PNOZmulti safety relay must be connected to the RS 232 interface.
- The diagnostic function on the programmable safety system must be activated.
- The diagnostic configuration on the PMImicro diag must match the diagnostic configuration on the programmable safety system.

The PMImicro diag is supplied with a default diagnostic configuration and a default PMImicro configuration, so it can immediately be used for device diagnostics (display of system messages). Please refer to Chapter 6 for details of the default settings (see page 6-2).



INFORMATION

Programmable safety systems with an FS operating system version ≥ 47 and safety relays with a configurator version $\geq 5.0.0$ support PVIS expanded diagnostics.

A diagnostic configuration can be created for these programmable safety systems. The diagnostic configuration enables appropriate event messages to be displayed when safety devices (MBS blocks), inputs, outputs and flags have a defined status.

PSS event messages can also be supplemented through additional information, which is helpful during diagnostics.

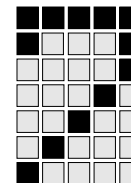

Please familiarise yourself with the basics for diagnostic configuration before you create a diagnostic configuration. You can do this by reading the online help on the PSS WIN-PRO system software or the online help on the PNOZmulti Configurator (PNOZmulti).



INFORMATION

The language selected for the diagnostic language depends on the diagnostic configuration on the PMImicro diag.

- In the PSS WIN-PRO system software (from Version 1.3.1) it is possible to create the diagnostic configuration in a given language (e.g. German, English, ...).
- In the PNOZmulti Configurator system software (from Version 5.0.0) it is possible to create the diagnostic configuration in a given language (e.g. German, English, ...).

If this diagnostic configuration is downloaded to the PMImicro diag, the available languages are replaced.

PMImicro Configurator

The PMImicro Configurator is part of the PSS WIN-PRO and PNOZmulti Configurator system software and performs the following tasks:



- The PMImicro Configurator is used to download the diagnostic configuration to the PMImicro diag via a serial interface or CF card.
- The PMImicro configuration is created in the PMImicro Configurator and is downloaded to the PMImicro diag via a serial interface or CF card.

Further information on the PMImicro Configurator can be found in the online help on the PSS WIN-PRO system software and on PNOZmulti Configurator.

Operation

Priorities

The event messages are divided into three priority classes:

| Symbol | Key |
|---|-------------------------------------|
|  | “Error” priority class |
|  | “Warning” priority class |
|  | “Status information” priority class |

- **Error**
This priority class contains event messages to which it is absolutely essential that the user reacts. These event messages provide information on the status of a technical device, in which one or more functions have failed or are adversely affected.
- **Warning**
This priority class contains event messages which demand the user’s attention. These event messages warn the user about a potential or imminent critical machine status.
- **Status information**
This priority class contains event messages which describe the current status of the process and/or machine. These event messages are provided for information; the production cycle is not impeded, nor is it adversely affected.

Responsibilities

An area of responsibility can be assigned to each action. The responsibility stands for the person or group who is supposed to perform an action.

Scopes

Each event message and each action can be assigned a scope. The scope roughly describes the type of event/action.

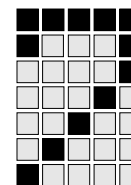

Location description

The location description is a precise description of the position of the device with the stated equipment identifier and displayed parameters. When performing diagnostics on the PNOZmulti, the location description is displayed in addition to a description of the event/action, provided the user has entered this information. The user himself creates the location description.



INFORMATION

The location description can only be configured on the PNOZmulti.

Event list

The event list is shown on the PMImicro diag, which receives the event telegrams from the PSS. For each event, a check is made to examine whether the event message corresponding to the event has to be displayed and entered in the event list (intelligent evaluation). For example, if it concerns an event that has occurred as a consequence of a previous event, the event will be ignored.

A check is also made to see whether the user requires further information on an event. For example, if the PSS registers that an I/O-Group on SafetyBUS p has stopped, the display unit calls up the error stack of the device that triggered the stop, displays the relevant event messages and enters them in the event list.

The event messages are deleted from the event list as soon as the cause of the error has been rectified (see page 7-11).



INFORMATION

The PMImicro diag displays a maximum of 10 event messages. When an event message is deleted, subsequent event messages move up automatically.

Operation

Message display

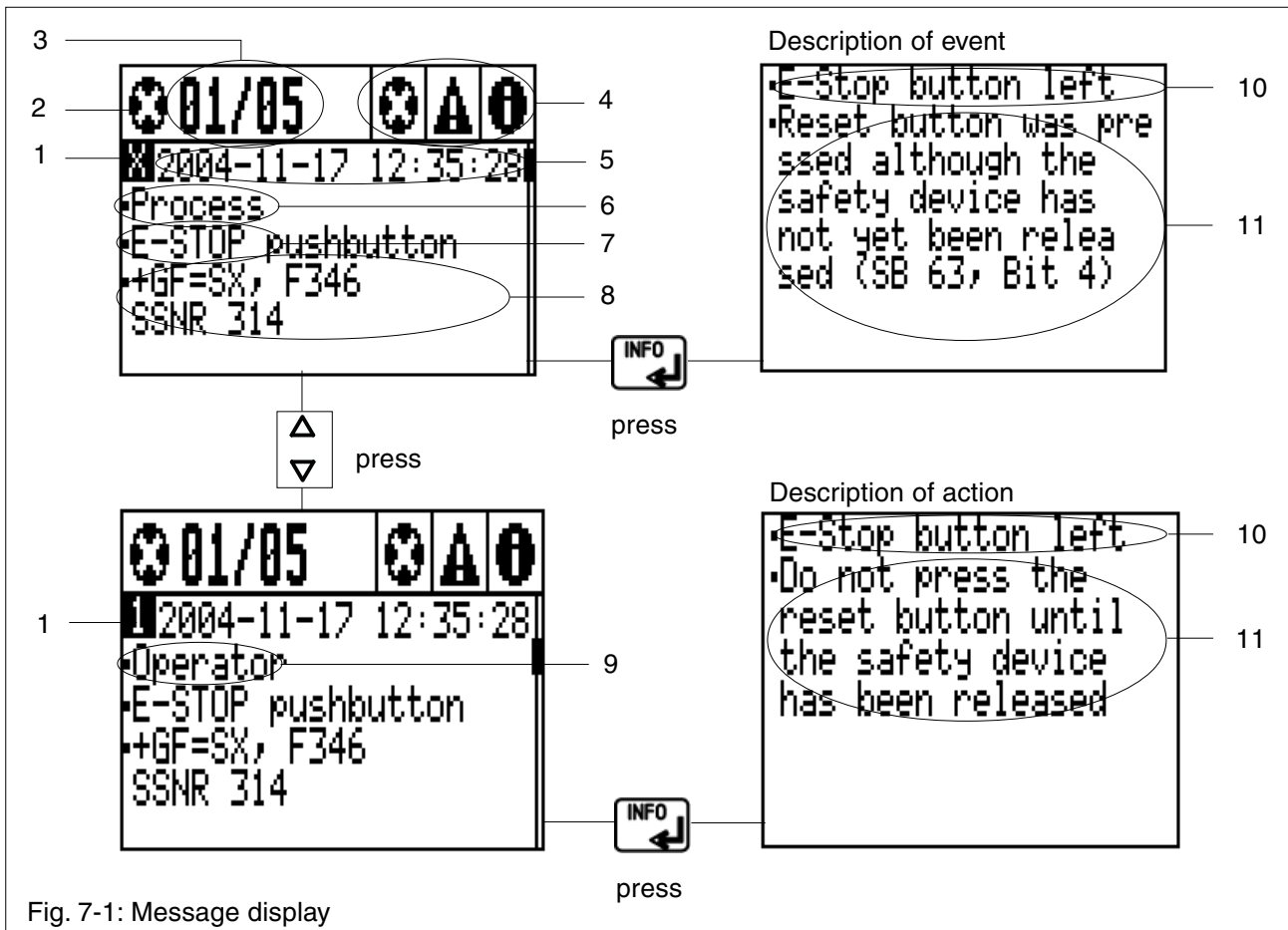
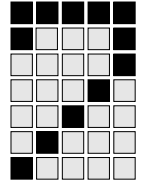

Fig. 7-1: Message display

- 1: Current position in event; X -> error text (e.g. error),
1 ... 8 -> description of action
- 2: Priority class (e.g. error)
- 3: Event message (e.g. first entry of five available entries in this priority class)/type size: 6 x 8 pixels (2.7 x 4.7 mm)
- 4: Symbols for priority classes: only displayed when an entry is present, flashes until the entry is displayed.
- 5: Date YYYY-MM-DD/Time hh:mm:ss
- 6: Scope
- 7: Device
- 8: Equip ID (equipment identifier and parameter)
- 9: Responsibility
- 10: Description of location
- 11: Description of event or action



Navigation within an event message

The following diagram shows the navigation within an event message. Using the keys described (see page 4-1) you can access the display for the error message and the remedy/action.

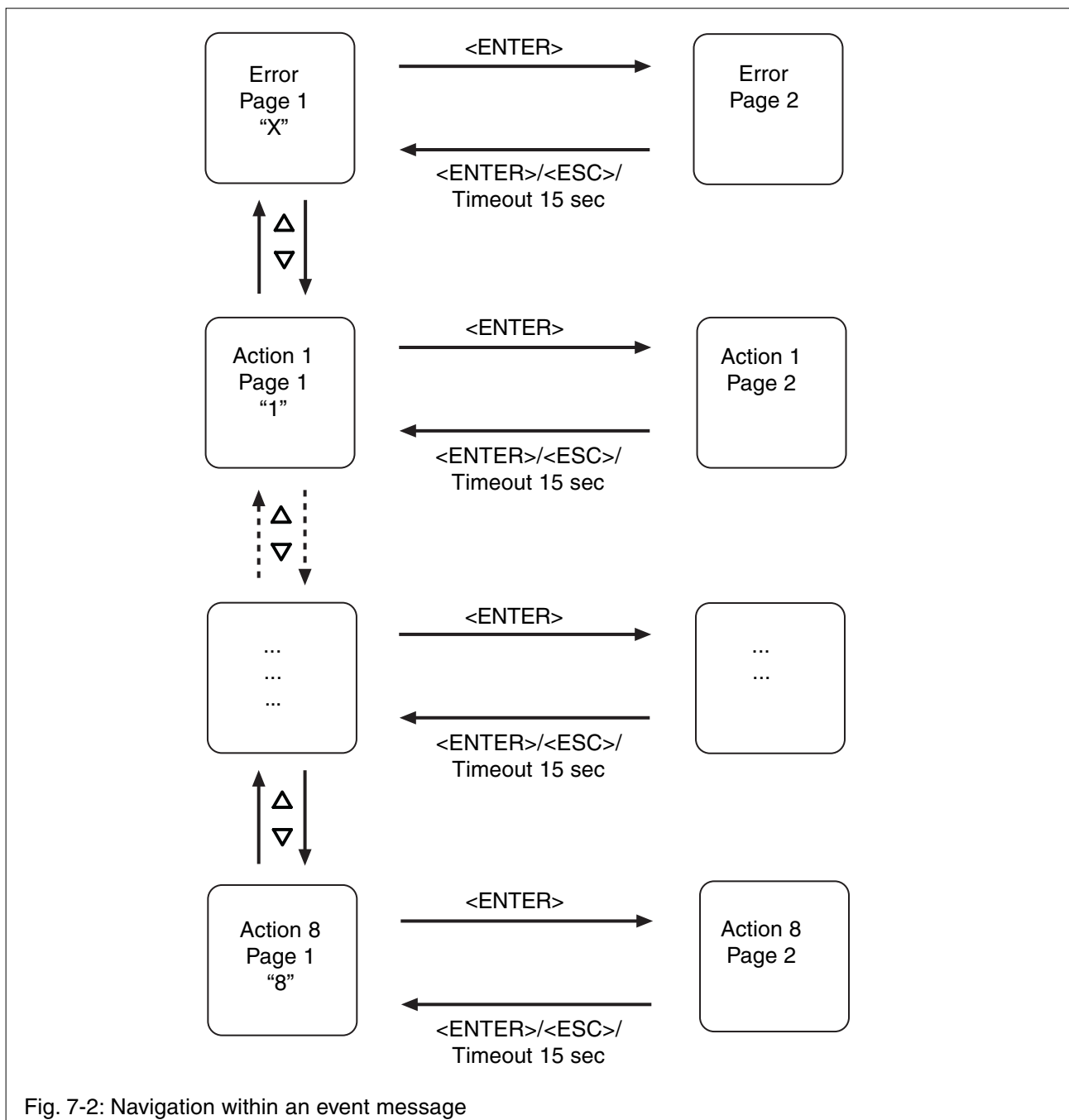

Fig. 7-2: Navigation within an event message

Operation

Navigation between event messages

The following diagram shows the navigation between event messages. Using the keys described (see table on page 4-1) you can access the respective event message and the corresponding remedy/action.

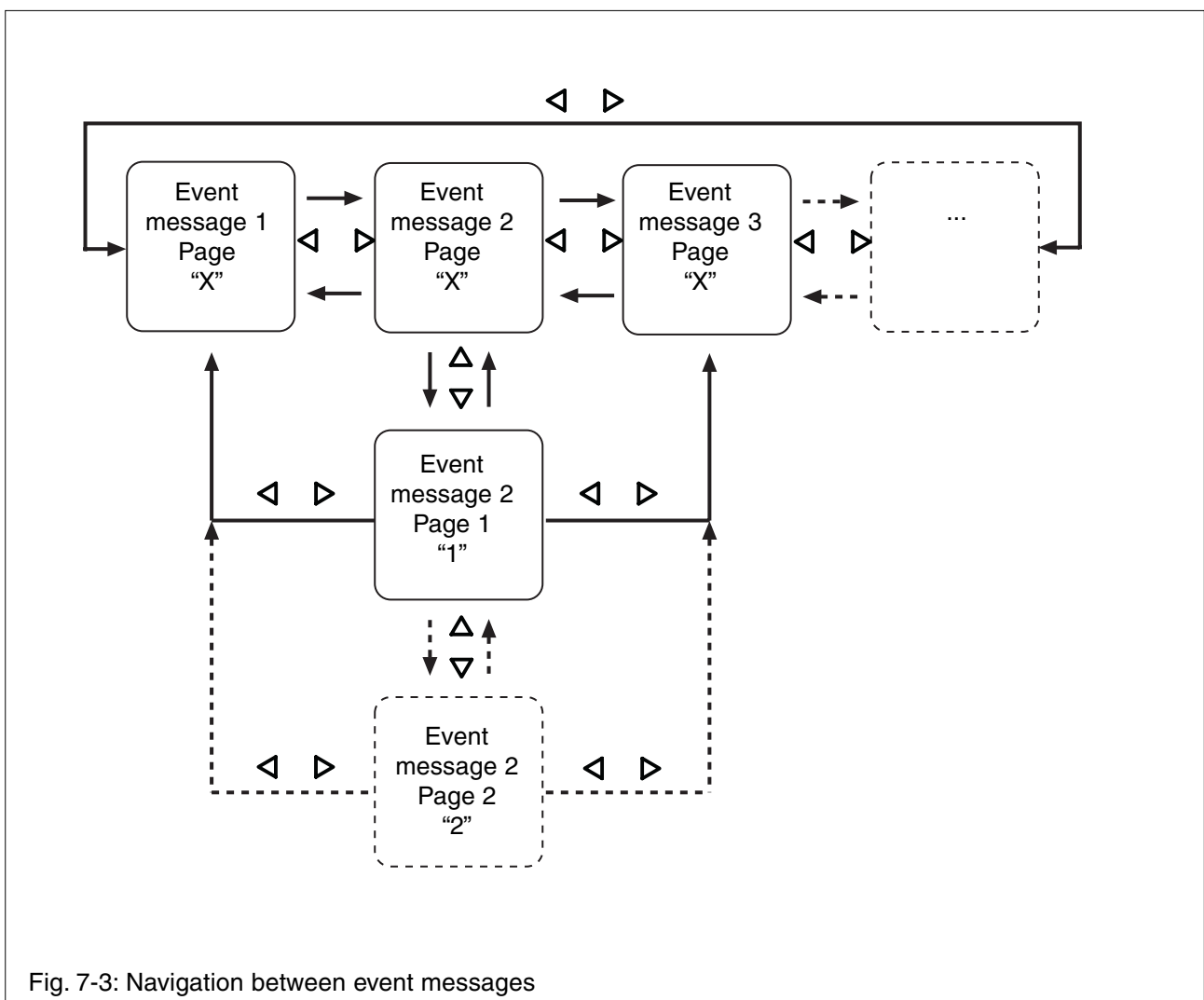
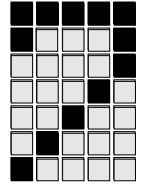

Fig. 7-3: Navigation between event messages



INFORMATION

The length of time a selected message is displayed depends on the set operator timeout. Once the operator timeout has elapsed, the display will return to the highest-priority event message.



Deleting event message

The following diagram shows the event messages that are displayed when an event message is deleted from the PSS. Subsequent event messages move up automatically, the event messages are “shifted”.

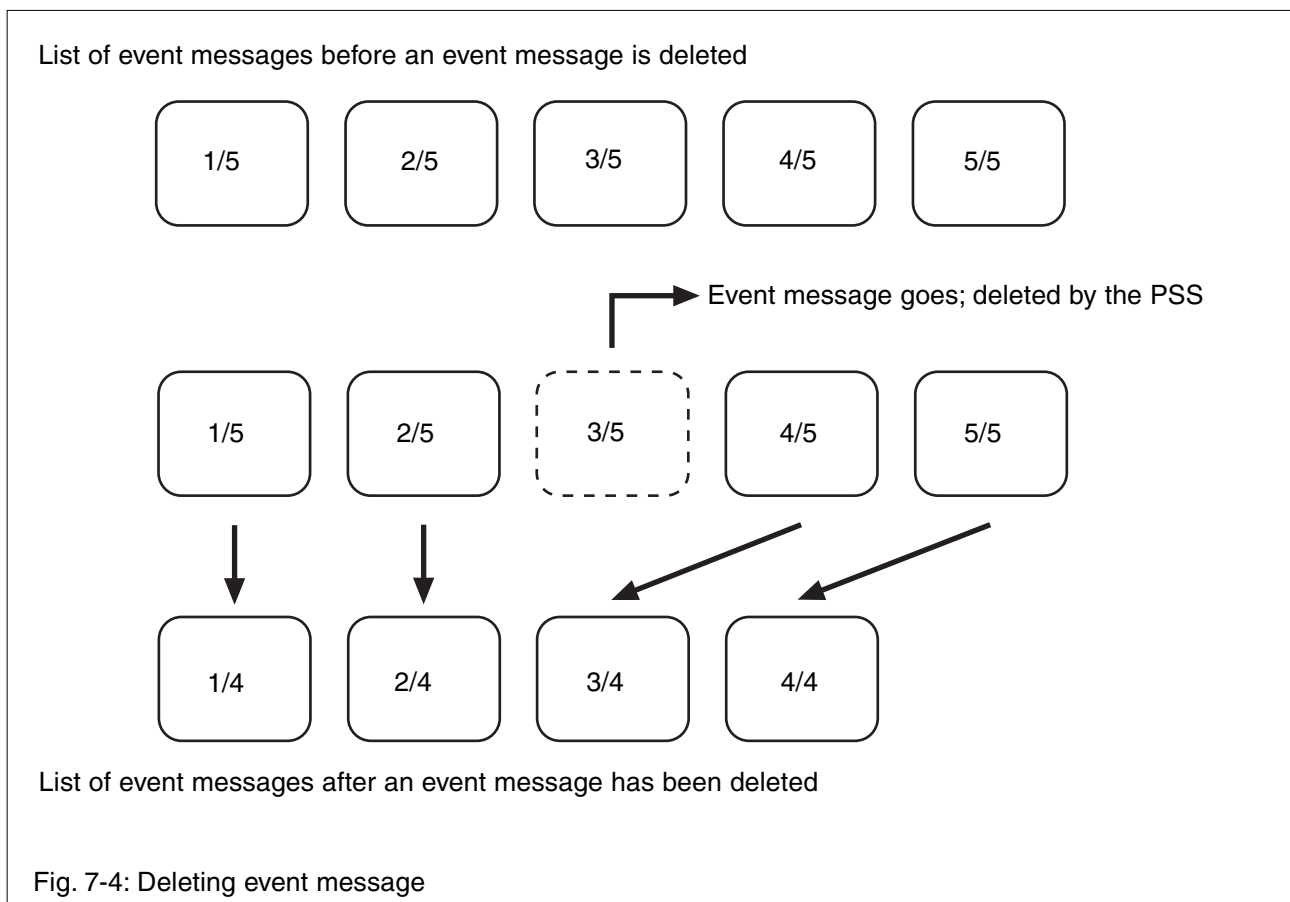

Deleting event message (on display)

If the event message (3/5) that is currently displayed is deleted by the PSS, a window will appear, showing the message: **Message deleted**. The event message will remain visible until the unit switches to another event message. Subsequent event messages move up automatically.

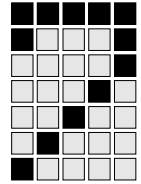

Operation

Incoming event message

If a new event message is added, it is entered in the event list according to its priority. Existing event messages in the event list are “shifted” accordingly. The corresponding priority class symbol will flash, the event message that is currently displayed will remain there.

Managing event messages

The event messages are recorded in the ***diagnostic log file***, i.e. details of which event message has been added/deleted and when.

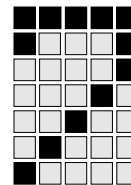

PNOZmulti diagnostics via virtual outputs

The connected PNOZmulti safety relay sends signals to the diagnostic terminal via the virtual outputs. A total of 24 virtual outputs are available. A virtual output can be used for a counter. A message text is assigned to each signal in the diagnostic terminal. These message texts are shown as plain text messages.

When a virtual output in the PNOZmulti is set, the stored message is displayed, when the output is reset the message is hidden. The signals are processed independently from each other.

Users create the message texts on the PC in the languages they require, then save them in a message file in XML format. It is possible to switch languages on the PMI micro.

The message file is downloaded from the CF card to the PNOZmulti using the backup & restore function.



INFORMATION

A PNOZmulti with an operating system version ≥ 4.0 will support the diagnostic options.

Operation

Schematic representation, using the virtual output VO1 as an example

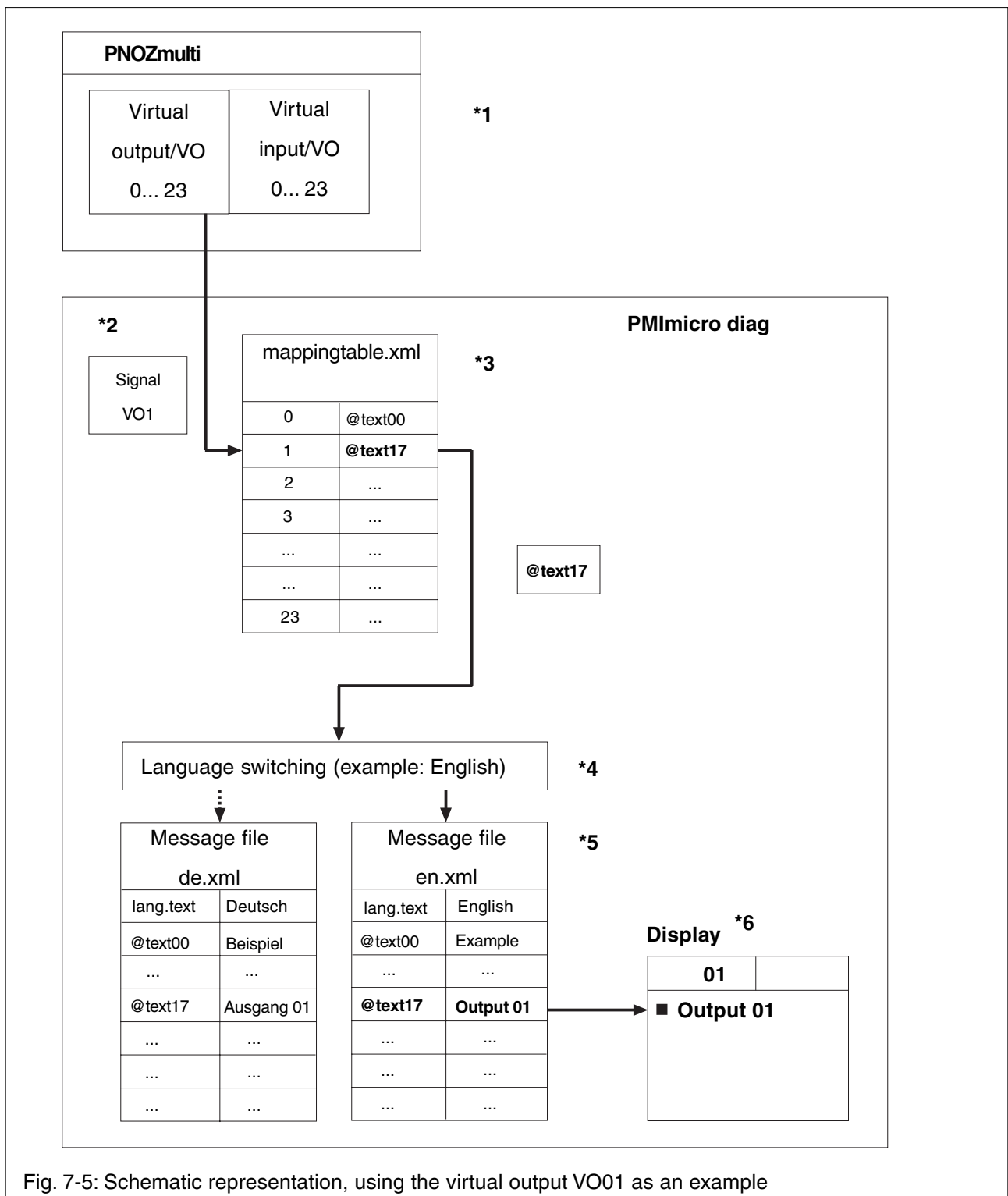
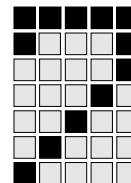

Fig. 7-5: Schematic representation, using the virtual output VO01 as an example



***1 PNOZmulti**

The virtual outputs on the PNOZmulti are evaluated as signals from the PMImicro diag. 24 outputs (VO0 ... VO23) are available (see Counter, page 7-23).

***2 Send signal**

The VO1 signal is transmitted to the PMImicro diag via the serial interface (see page 4-6).

***3 mappingtable.xml**

The transmitted VO1 signal is assigned an identification label. This means that the assignment of virtual outputs to message texts can be flexible.

***4 Language switching**

It is possible to define the message file that will be searched for the identification label.

***5 Message file**

In the message file the identification label determines which message text is displayed (see User message, page 7-20).

***6 Display**

The corresponding message is shown on the display (see Message display, page 7-22).

Operation

Create diagnostics

For this you will need:

- PC to edit the XML files
- CD PMImicro diag with documentation and sample project
- CF card
- CF card reader or adapter for CF card, order no.: 375300

Proceed as follows:

1. Copy the **backup** folder in the sample project from the CD on to your PC (see Fig. 7-6).



INFORMATION

The directory structure must be maintained.

2. In the **mappingtable.xml** file, assign an identification label to each of the virtual outputs (see page 7-18).
3. Create the message texts in the required languages and add these to the corresponding message file (see page 7-20).
4. In the message file, assign an identification label to each of the message texts (see page 7-18).
5. Save this message file as an XML file in the **languages** folder (see Fig. 7-6).
6. Copy the **backup** folder into the main directory of a CF card.
7. Download this configuration to the PMImicro diag using the restore function (see page 6-22).

Configuration files

The sample stored on the CD can be used as a basis for your own configuration. The sample files are stored in the folders **prj1** and **languages** (XML format). These sample files can be edited on the PC using a text editor.

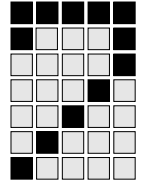

INFORMATION

The directory structure must be maintained if the files are to be downloaded to the PMImicro diag using the restore function.

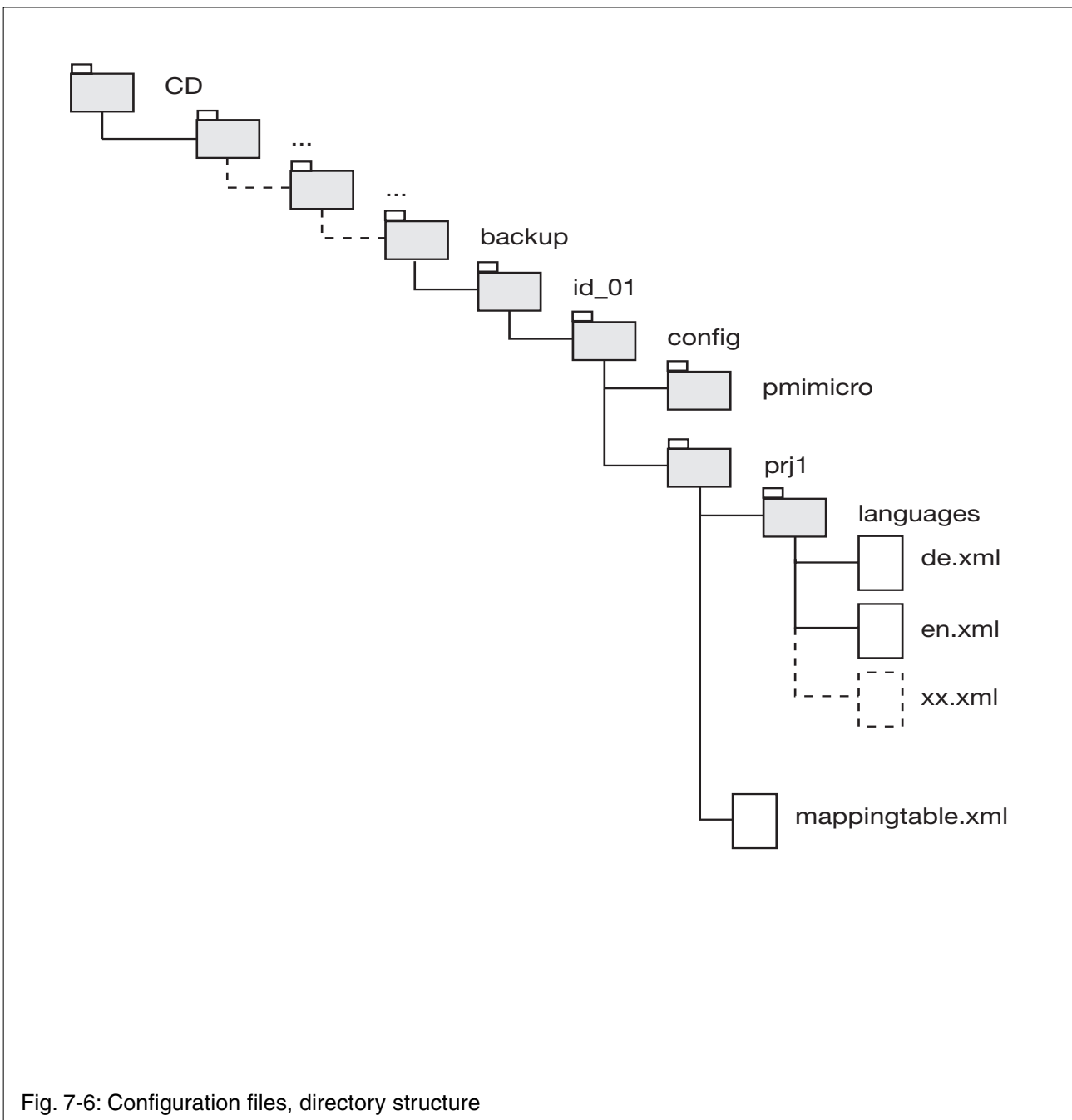
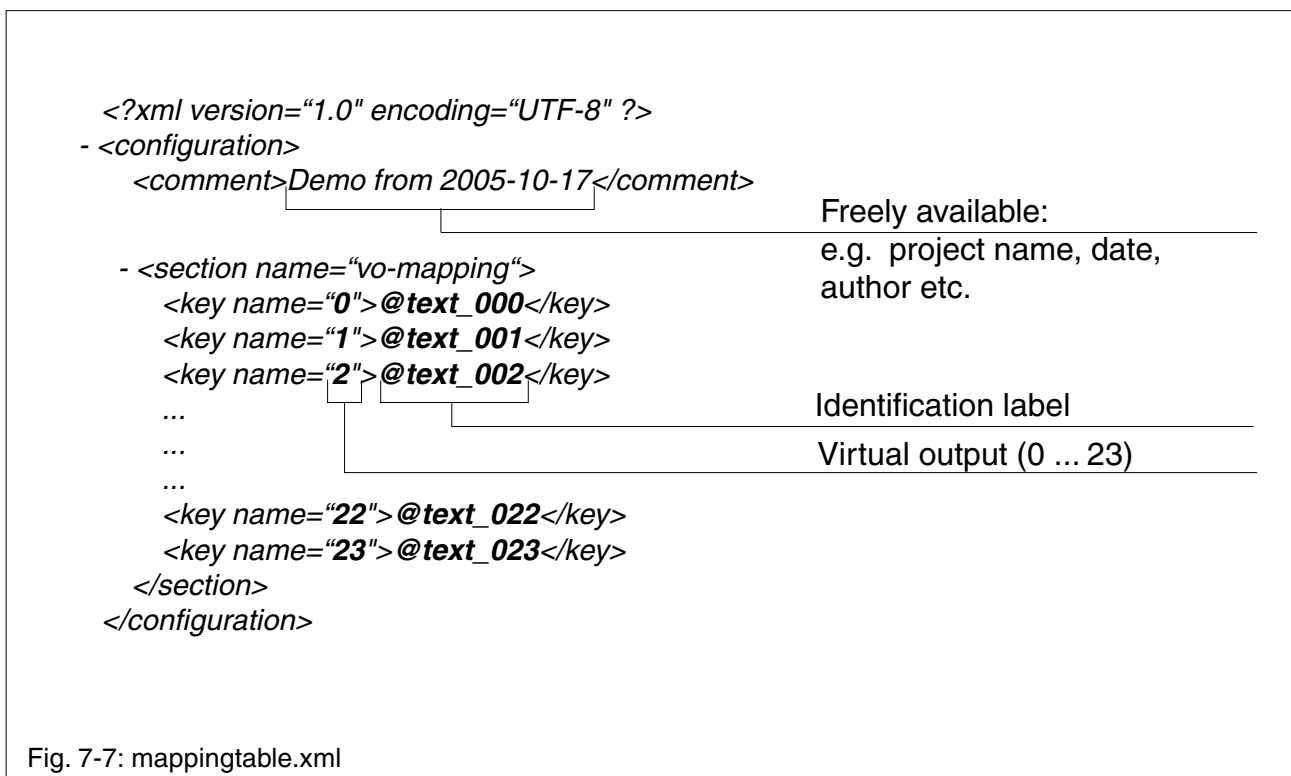

Fig. 7-6: Configuration files, directory structure

Operation

mappingtable.xml

The identification labels are assigned to the virtual outputs in the **mappingtable.xml** file. A total of 24 outputs (VO0 ... VO23) are available (see Counter, page 7-23). The **mappingtable.xml** file has the following structure:



Example:

The identification label **@text_002** is assigned to virtual output **"2"**.

You can also rename the identification label and assign it to a different message in the message files:

```
<key name="2">@text_017</key>
```

The identification label **@text_017** is assigned to virtual output **"2"**. This identification label is then assigned to the corresponding message in the message files.

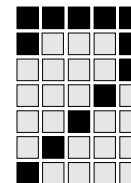

Message files

The message texts are stored in a message file. The texts can be amended, added or deleted at any time.

A separate message file must be created for each language. The identification labels are identical, but the texts are stored under the relevant language.

The sample project contains two message files:

- **de.xml** (German)
- **en.xml** (English)



INFORMATION

The file name for the message file may contain a maximum of 2 characters and must be in lower case.

As the PMImicro diag is started up, the directory for the message files is read in and all available languages are included in the language selection. The “*languagetext*” entry in the message file is used for displaying the available languages in the language selection (see Fig. 7-8):

```
<key name=“languagetext”>Deutsch</key>
```

If a new message file is created and downloaded to the PMImicro, this message file will automatically be included in the language selection the next time the device is started (see Diagnostic language, page 6-27).

Operation

The message file **de.xml** has the following structure:

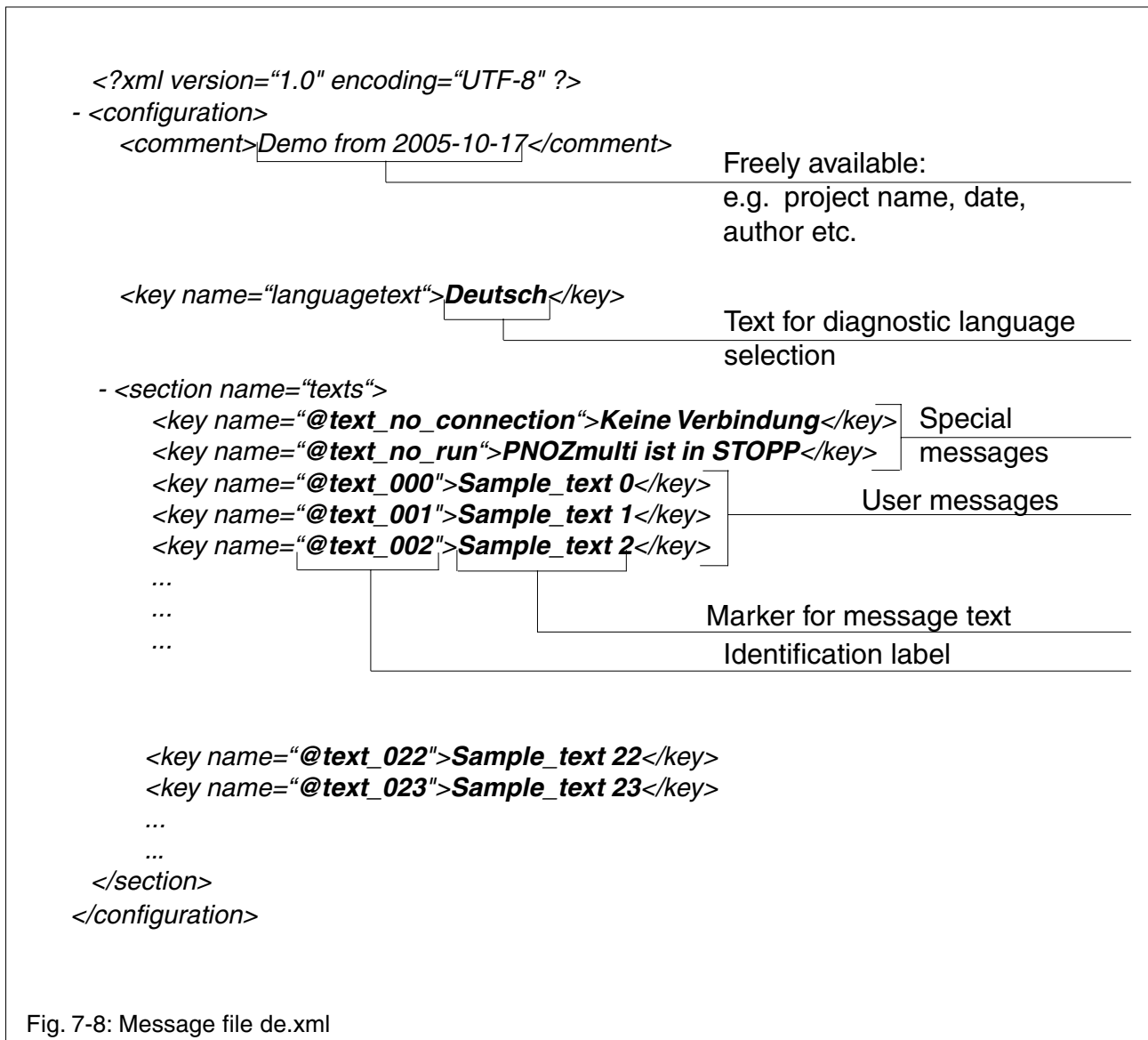
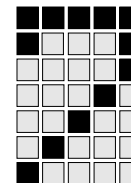

Fig. 7-8: Message file de.xml

User messages

The relevant message texts are assigned identification labels within the message file.

Sample_text 0, sample_text 1, ... are used as markers for the message texts that you create. You should insert your own message texts at this point.



INFORMATION

Please note that a message text is limited to 10 lines of 20 characters. Depending on the wordwrap, a maximum of 200 characters may be displayed.

You can write as many message texts as you like in the message files.



INFORMATION

If you add a new message text to a message file, please ensure that the message text is assigned to the corresponding identification label in the mappingtable.xml file.

Special messages

Special messages are messages relating to operational readiness and the connection to the connected device. These messages are generated by the PMImicro diag.

The message texts themselves can be amended by the user, but their assignment is fixed. The following events are displayed as special messages when necessary:

- *>PNOZmulti is in STOP<*
- *>No connection to connected device<*



INFORMATION

When a special message is displayed, all other messages are hidden.

Operation

Message display

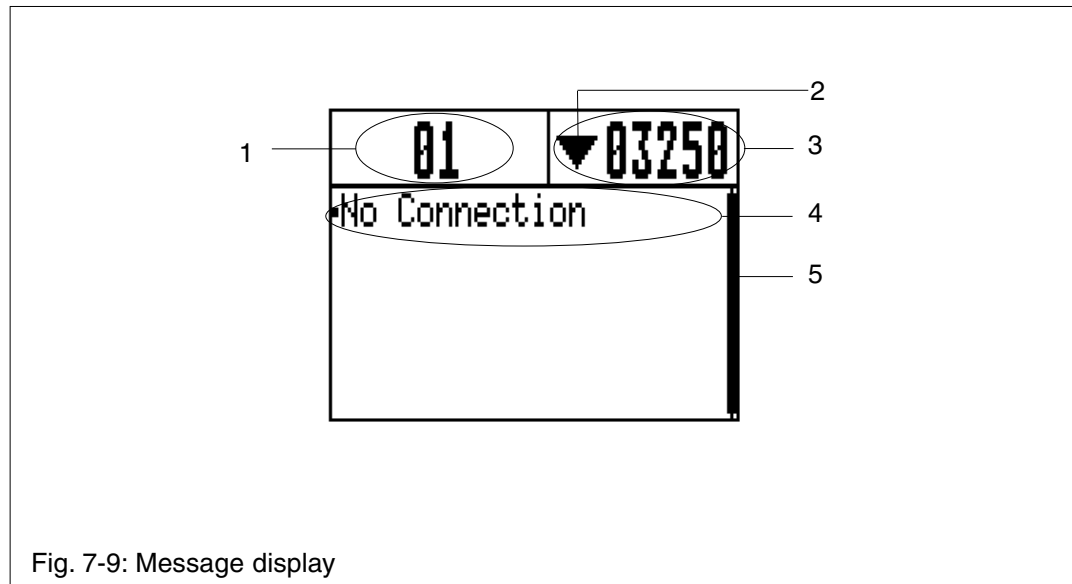

Fig. 7-9: Message display

- 1: Number of messages currently present
- 2: Direction of part counter (only when the part counter is switched on)
- 3: Counter status, 5-digit display
(only when the part counter is switched on)
- 4: Message text with bullet point
- 5: Scroll bar

A maximum of 6 lines can be displayed. The scroll function is activated if the display requires more than 6 lines.

Use the navigation keys to scroll: ▲ ▼

The messages are sorted in accordance with the signals from the virtual output (VO0 ... VO23). The message for VO0 (if set) is always shown first, followed by the message from VO1, etc.

All messages are marked by a square bullet point.



INFORMATION

If a message text cannot be found within the message file, the corresponding identification label will initially be displayed. If the identification label cannot be found within *mappingtable.xml*, a dummy text will be displayed for the relevant output.

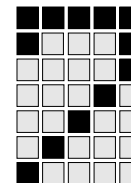

Part counter

The part counter can be used to count forwards and backwards.
The part counter may be switched on and off.

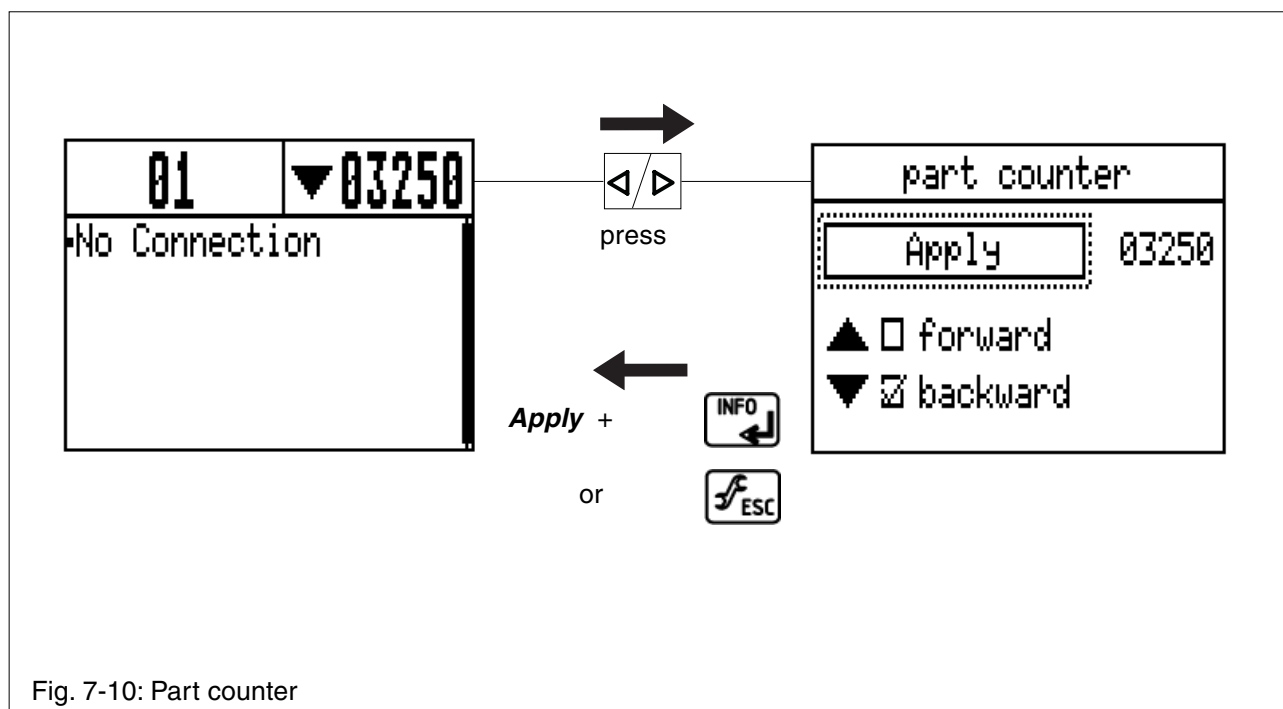

Fig. 7-10: Part counter

Function

The counter pulse is triggered via virtual output VO23 on the PNOZmulti. If the part counter is switched off, a message text is assigned to virtual output VO23.

If the counter value is **00000**, virtual input VI23 on the PNOZmulti is set. This acts as feedback to the PNOZmulti. This feedback can be processed further in the PNOZmulti.



INFORMATION

The settings for counter direction and counter status are retained even after the PMImicro diag is restarted.

Operation

Configuration

When configuring the part counter please refer to the guidelines given for the key functions (see page 4-5) plus the general guidelines on operation (see page 6-6).

Part counter forwards

Proceed as follows:

1. Press either of the two navigation keys: ◀ ▶
This will access the counter's setup menu.
2. Using the navigation keys, select **forward**.
3. Press <ENTER>. The option is selected.
4. Using the navigation keys, select **Apply**.
5. Press <ENTER>. The display switches to message display. The forward counter starts as soon as a counter pulse is received.

Part counter backwards

Proceed as follows:

1. Press either of the two navigation keys: ◀ ▶
This will access the counter's setup menu.
2. Using the navigation keys, select **backward**.
3. Press <ENTER>. The option is selected.
4. Using the navigation keys, select the counter value **xxxxx**.
5. Press <ENTER>. The numeric value that can be set is flashed and shaded black.
6. Using the navigation keys, select the relevant value.

The following figures can be selected:

- 0 ... 9

7. Repeat step 6 until you have entered the required value.
8. Press <ENTER>.
9. Using the navigation keys, select **Apply**.
10. Press <ENTER>. The display switches to message display. The backward counter starts as soon as a counter pulse is received.

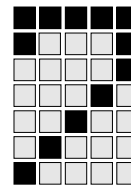

Part counter switched off

Proceed as follows:

1. Press either of the two navigation keys: ◀ ▶
This will access the counter's setup menu.
2. Using the navigation keys, select the function that is selected.
3. Press <ENTER>. The option is deselected.
4. Using the navigation keys, select **Apply**.
5. Press <ENTER>. The display switches to message display. The part counter is switched off.



INFORMATION

If the part counter is switched off, a message text is assigned to virtual output VO23.

PMImicro configuration



INFORMATION

This section contains specific guidelines for configuring diagnostics on the PNOZmulti vIO. For information on other settings relating to the PMImicro configuration, please refer to Chapter 6, from page 6-4 ff.

Password protection

Logbook setting has no effect as no logbook is used.

User setting

Access right for the logbook has no effect as no logbook is used.

Integrity display

The integrity display is not supported on PNOZmulti vIO diagnostics and is greyed out in the menu.

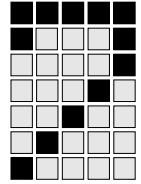

Operation

Logbook

The logbook function is not supported on PNOZmulti vIO diagnostics and is greyed out in the menu.

Versions

Display on the PNOZmulti: CRC and date

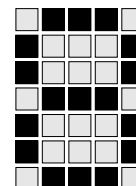

Technical Details

Technical details

| Electrical data | |
|---|---|
| Supply voltage | 12 ... 32 VDC |
| Rated supply voltage | 24 VDC |
| Display | |
| Display type | LC dot matrix graphic module |
| Resolution | 128 x 64 Bit |
| Display range | 60 x 40 mm (W x H) |
| Backlighting | White LEDs |
| Interfaces | |
| Serial interfaces | 1 x RS 232 1 x RS 485 |
| Cable runs | RS 232: 10 m RS 485: 1000 m, max. 110 kBit/s |
| CF card slot | 50-pin |
| Computer | |
| Processor | RISC processor |
| Operating system | mClinux |
| Memory | 8 MByte Flash 32 MByte SDRAM |
| Realtime clock | Battery-buffered real-time clock |
| Environmental data | |
| EMC | |
| Noise immunity | EN 61000-6-2, 10/01; |
| Noise emission | EN 55022 Class A, 04/03 |
| Protection type (EN 60529, 02/00) | Front: IP65, back: IP20 |
| Ambient temperature (EN 60068-2-14, 11/99) | 0 °C ... +55 °C |
| Storage temperature (EN 60068-2-1/-2, 07/94) | -25 °C ... +70 °C |
| Climatic suitability (EN 60068-2-78, 10/01) | Max. 95 % r.h. at +40 °C |
| Condensation | Not permitted |
| Vibration (EN 60068-2-6, 04/95) | Frequency: 10 ... 150 Hz, 1g constant |
| Shock (EN 60068-2-27, 03/93) | 15g, 11 ms |

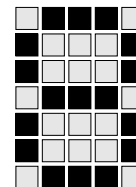

Technical Details

Mechanical data

| | |
|---|-------------------------|
| Housing material | |
| Housing | Stainless steel |
| Front | ABS Polyflam, UL listed |
| Dimensions (with front panel) (H x W x D) | 78 mm x 148 mm x 57 mm |
| Modular depth | 51 mm |
| Weight | 370 g |

Licence: GPL/expat/zlib

- Please note the **GPL** (General Public Licence) for the operating system μ CLinux. The licence text can be found on the enclosed CD under Licence: GPL.
The relevant translation of the licence can be found at the following address: <http://www.gnu.org/licenses/gpl.html>
- Please note the licence for **expat**. The licence text can be found on the enclosed CD under Licence: MIT.
- Please note the licence for **zlib**. The licence text can be found on the enclosed CD under Licence: zlib.



In many countries we are represented by our subsidiaries and sales partners.

Please refer to our homepage for further details or contact our headquarters.



Pilz GmbH & Co. KG
Felix-Wankel-Straße 2
73760 Ostfildern, Germany
Telephone: +49 711 3409-0
Telefax: +49 711 3409-133
E-Mail: pilz.gmbh@pilz.de

► **www**
www.pilz.com

► **Technical support**
+49 711 3409-444
support@pilz.com