

TECHNICAL DATASHEET

Absolute Motorfeedback Series AD 34



- For brushless servo motors
- Light duty encoder
- Unique mounting concept: Save installation time and cost
- Mounting Depth: 25 mm (ST), 34 mm (MT)
- Up to 19 Bit ST - resolution + 12 Bit MT - resolution
- +120°C operating temperature
- 10,000 rpm continuous operation
- Interfaces: SSI, BiSS-B or BiSS-C
- Sinewave 1 Vpp
- Bandwidth 500 kHz



GENERAL INFORMATION

The AD34 is the most compact absolute encoder in class. It is available with a resolution up to 19 Bit Singleturn and 12 Bit Multiturn. The mechanical design consists of two ball bearings and a flexible torque support. The AD34 complements the ACURO-DRIVE series and is appropriate for use within BLDC servo motors with small frame sizes. The AD34 is available with a notched shaft, which saves installation time.

Notched shaft saves installation cost

Because of its innovative shaft mounting the AD34 saves work on the motor shaft. A common 6 mm bore on the motor B - side is enough. AD34's notched shaft is inserted in the B side of the motor shaft in one process step.

Fully digital control loop

The new and completely digital OptoAsic technology enables the transition to a truly digital drive system. The conventional absolute encoders still have analog sine wave signals for the feedback of speed and position data. The AD34, however, provides fully digital position data up to 19 Bit per revolution over the BiSS interface with a variable clock rate up to 10 MHz. BiSS is the only open high speed bidirectional sensor interface available on the market. Backward compatibility to most of the existing drives is realized through the variant with SSI interface together with 2048 sine -cosine periods per revolution.

Integrated diagnostic system

The AD34 has an integrated diagnostic system that controls and regulates the internal signals. Maximum motor uptime is achieved through the pre warning in case of any system error or aging effects well before they affect the function of the encoder. A code plausibility check guarantees that the output data represents always the true position. Also the operating temperature can be measured and read out with 8 Bit resolution. If programmable limits are exceeded or under run this is indicated over warn and alarm bits.

TECHNICAL DATA mechanical

Housing diameter	37.5 mm
Shaft diameter	6 mm (Notched Shaft)
Flange (Mounting of housing)	Tether
Protection class shaft input (EN 60529)	IP40
Protection class housing (EN 60529)	IP40
Axial endplay of mounting shaft (hubshaft)	± 0.5 mm
Radial runout of mating shaft (hubshaft)	± 0.05 mm

TECHNICAL DATASHEET

Absolute Motorfeedback Series AD 34

TECHNICAL DATA mechanical (continued)

Max. speed	max. 10 000 rpm (continuous), max. 12 000 rpm (short term)
Starting torque typ.	0.01 Nm
Moment of inertia	ca. 2.5×10^{-6} kgm ²
Vibration resistance (DIN EN 60068-2-6)	100 m/s ² (10 ... 2000 Hz)
Shock resistance (DIN EN 60068-2-27)	1000 m/s ² (6 ms)
Operating temperature	-15 °C ... +120 °C
Storage temperature ¹	-15 °C ... +85 °C
Relative humidity	75%, non-condensing
Weight	approx. 80 g (ST)
Connection	Cable, radial PCB connector, 12 pole

¹ due to packing

TECHNICAL DATA electrical

Supply voltage	DC 5 V -5 %/+10 % or DC 7 - 30 V
Current w/o load typ.	100 mA (ST), 150 mA (MT)
Resolution singleturn	12 - 17 Bit (SSI) 12 - 19 Bit (BiSS)
Resolution multiturn	12 Bit
Output code	Gray
Drives	Clock and Data / RS422
Incremental signals	Sinus-Cosinus 1 Vpp
Number of pulses	2048
3dB limiting frequency	500 kHz
Absolute accuracy	±35"
Alarm output	Alarm bit (SSI Option), warning bit and alarm bit (BiSS)

MOUNTING NECESSITIES

Spring tether "U"

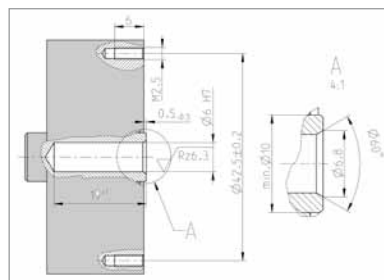

Dimensions in mm

Spring tether "F"

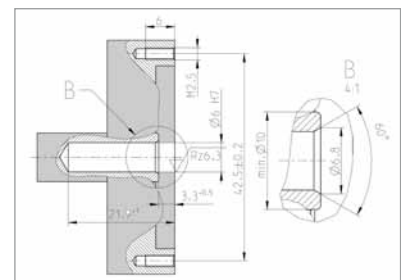

Dimensions in mm

TECHNICAL DATASHEET

Absolute Motorfeedback Series AD 34

ELECTRICAL CONNECTIONS

PCB connector, 12 pole

Color	PIN	Signals
grey	1a	Data
white/ green ¹	2a	A+
black ¹	3a	0 V sensor
red/ blue ¹	4a	B+
green	5a	Clock
pink ¹	6a	5 V Sensor
white	1b	DC 5 V/ 7 - 30 V
yellow	2b	Clock
grey/ pink ¹	3b	B-
brown	4b	0 V (U _N)
brown/ green ¹	5b	A-
pink	6b	Data

¹ Analog signals (1 Vpp) only available with interface SC (SSI Gray + 1 Vpp) and BC (BiSS + 1 Vpp).

CONNECTION ENCODER SIDE

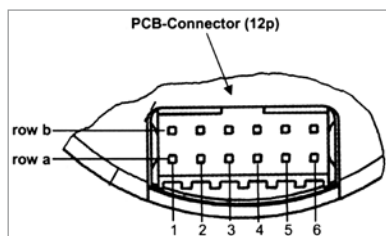

12 pin PCB connector
manufacture Berg, type Minitex

DIMENSIONED DRAWINGS

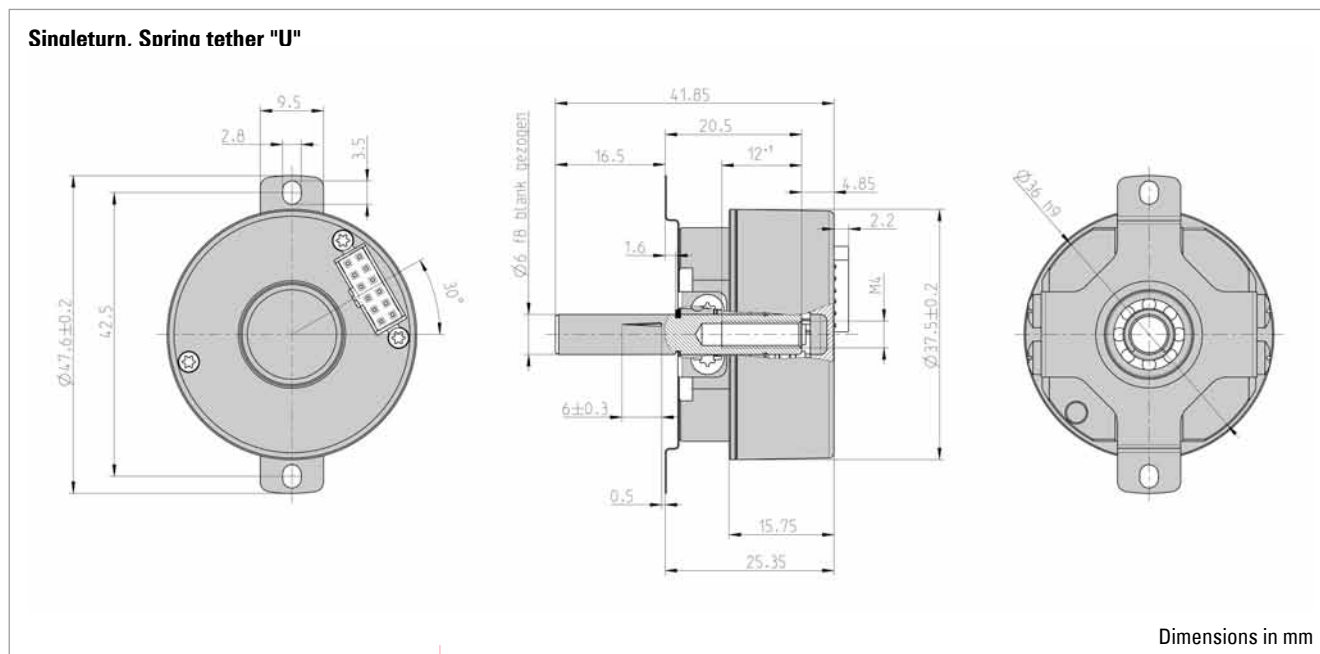

TECHNICAL DATASHEET

Absolute Motorfeedback Series AD 34

DIMENSIONED DRAWINGS (continued)

Multiturn. Sprina tether "U"

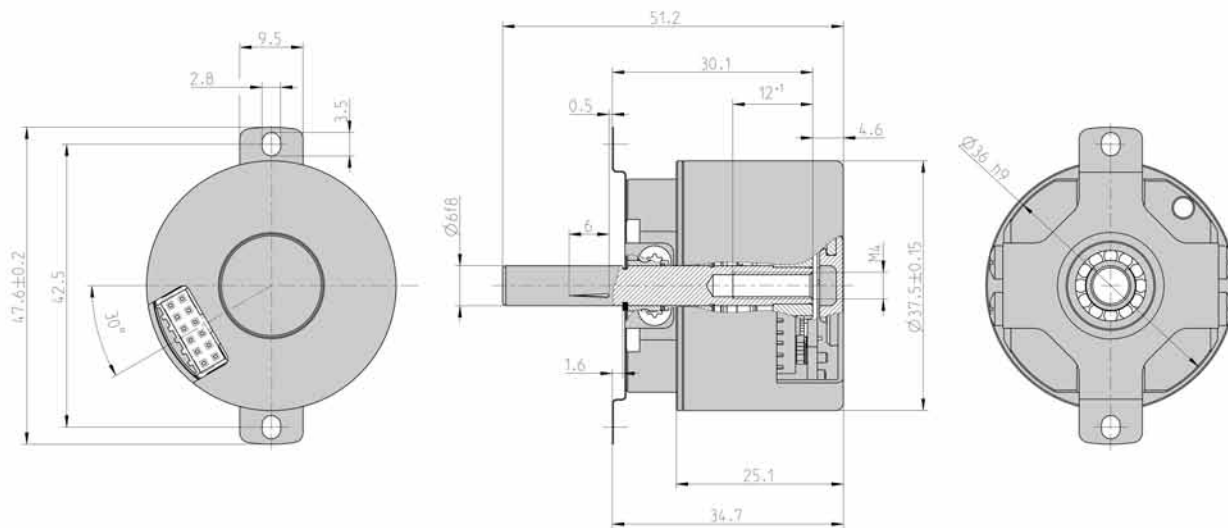

Dimensions in mm

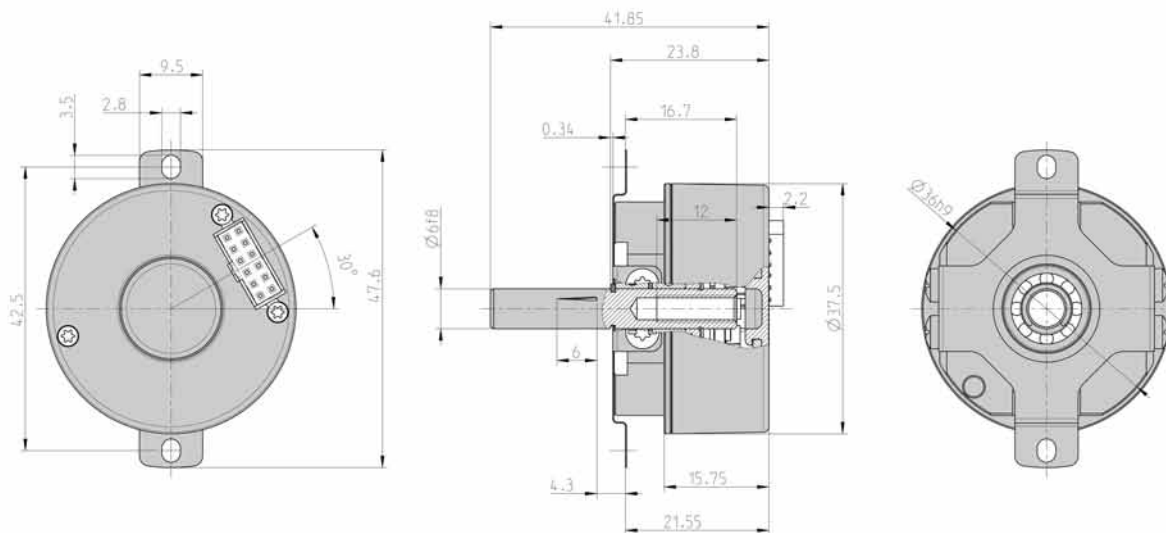

TECHNICAL DATASHEET

Absolute Motorfeedback Series AD 34

DIMENSIONED DRAWINGS (continued)

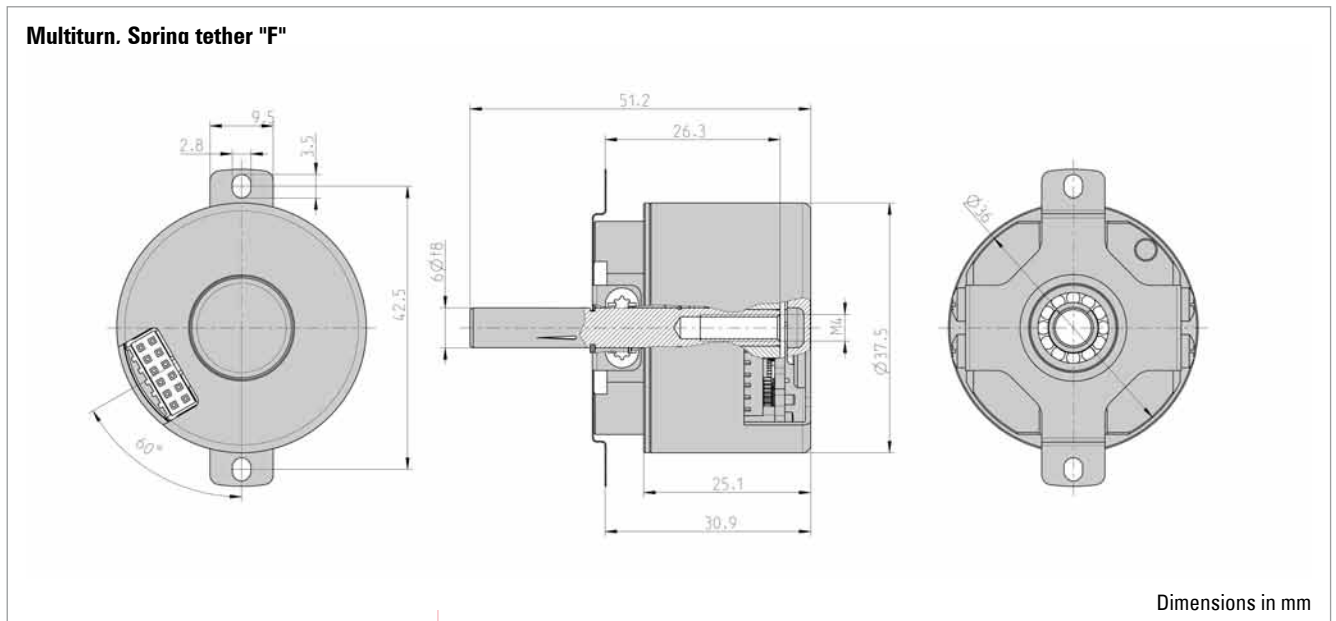

ORDERING INFORMATION

Type	Resolution	Supply voltage ¹	Flange, Protection, Shaft	Interface	Connection
<input type="checkbox"/>	<input type="checkbox"/>	<input type="checkbox"/>	<input type="checkbox"/>	<input type="checkbox"/>	<input type="checkbox"/>
AD34	0012 12 Bit ST 0013 13 Bit ST 0014 14 Bit ST 0017 17 Bit ST 0019 19 Bit ST (BiSS) 1212 12 Bit MT + 12 Bit ST 1213 12 Bit MT + 13 Bit ST 1214 12 Bit MT + 14 Bit ST 1217 12 Bit MT + 17 Bit ST 1219 12 Bit MT + 19 Bit ST (BiSS)	A DC 5 V E DC 7 - 30 V	F.0N Spring tether F, IP40, 6 mm notched shaft U.0N Spring tether U, IP40, 6mm Notched Shaft	BI BiSS-B BC BiSS-B (+SinCos 1Vpp) SG SSI Gray (+SinCos 1Vpp) SC SSI Gray (+SinCos 1Vpp) BE BiSS-C (+SinCos 1Vpp) BV BiSS-C (+SinCos 1Vpp)	0 PCB connector, axial, 12 pole 2 PCB connector, radial, 12 pole A PCB connector, axial, 12 pole with mating connector and 0.5 m cable B PCB connector, radial, 12 pole, with mating connector and 0.5 m cable

¹ No inverse-polarity protection for 5 V power supply