

**Honeywell**

# **ADEMCO 6271 Series TouchCenter Keypads**

## **Installation and Setup Guide**



## **Table of Contents**

.....

<b>SECTION 1 – General Information .....</b>	<b>1-1</b>
About the TouchCenter.....	1-1
System Features .....	1-1
Security .....	1-1
Setup .....	1-1
Compatibility .....	1-2
ECP Error .....	1-2
<b>SECTION 2 – Mounting and Wiring.....</b>	<b>2-1</b>
Mounting the TouchCenter Mounting Plate.....	2-1
Wiring the TouchCenter .....	2-2
<b>SECTION 3 – Front Panel LEDs and Navigation Icons.....</b>	<b>3-1</b>
Front Panel LEDs.....	3-1
Navigation Icons .....	3-2
<b>SECTION 4 – Initial Setup.....</b>	<b>4-1</b>
Programming the Control Panel.....	4-1
6271V and 6271CV Word List.....	4-2
TouchCenter Initialization .....	4-3
Power Up.....	4-3
How to Change the ECP Address .....	4-3
Language Selection .....	4-3
How to Select a Language .....	4-3
How to Access the Central Station Screen .....	4-4
How to Select System Options.....	4-7
How to Set the NIGHT Setup Button Function .....	4-8
How to View and Edit Screen Security .....	4-9
How to View Code Authority.....	4-10
How to View the Panel Configuration.....	4-11
TouchCenter Setup .....	4-12
How to Adjust the Contrast.....	4-14
How to Adjust the Volume.....	4-14
How to Select Screen Backlight Off Activation Time.....	4-14
How to Select Homepage After Time .....	4-16
How to Set the Time and Date .....	4-16
Setting Daylight Savings Time .....	4-17
Setting Current Time .....	4-20
Setting Operating Modes.....	4-22
Language Selection .....	4-22

How to Access Language Selection.....	4-24
<b>SECTION 5 – User Codes .....</b>	<b>5-1</b>
Introduction to User Code Setup.....	5-1
Authority Levels .....	5-1
How to Access User Setup .....	5-3
How to Add a User .....	5-4
How to Delete a User.....	5-6
How to Edit a User.....	5-7
<b>SECTION 6 – Maintenance .....</b>	<b>6-1</b>
About TouchCenter Maintenance.....	6-1
How to Clean the TouchCenter.....	6-1
Routine Care.....	6-2
<b>SECTION 7 – Troubleshooting.....</b>	<b>7-1</b>
Troubleshooting .....	7-1
Panel Fault Displays .....	7-1
Diagnostics.....	7-2
About Diagnostics.....	7-2
How to Access the Diagnostics .....	7-2
Performing Diagnostics .....	7-3
LCD Display Test .....	7-4
Audio Test .....	7-5
LED Test .....	7-6
<b>SECTION 8 – Safe Mode.....</b>	<b>8-1</b>
About the Safe Mode.....	8-1
Entering the Safe Mode .....	8-1
Automatic Entry.....	8-1
Manual Entry .....	8-2
Operating in the Safe Mode.....	8-4
Exiting the Safe Mode.....	8-4

## Conventions Used in This Manual

Before you begin using this manual, it is important that you understand the meaning of the following symbols (icons) and text note.

---

**UL** These notes include specific information that must be followed if you are installing this system for a UL Listed application.

---



These notes include information that you should be aware of before continuing with the installation, and which, if not observed, could result in operational difficulties.

---

**Note:** These text notes are provided throughout the manual to provide informative information and shortcut tips for the installer

### Specifications

#### 6271V:

Mechanical	
Width	7-1/4 inches (184mm)
Height	5 inches (127mm)
Depth	1-3/8 inches (35mm)
Electrical	
Backlight OFF, Sound OFF	12V, 105mA
Backlight ON, Sound OFF	12V, 137mA
Backlight ON, Sound ON	12V, 210mA

#### 6271C, 6271CV

Mechanical	
Width	7-1/4 inches (184mm)
Height	5 inches (127mm)
Depth	1-3/8 inches (35mm)
Electrical	
Backlight OFF, Sound OFF	12V, 105mA
Backlight ON, Sound OFF	12V, 159mA
Backlight ON, Sound ON	12V, 230mA

## S E C T I O N 1

**General Information****In This Section**

- ◆ *About the TouchCenter*                      ◆ *Compatibility*
- ◆ *System Features*                              ◆ *ECP Error*

**About the TouchCenter**

The 6271 Series graphical touch-screen keypads are Advanced User Interface (AUI) devices, which combine security and home control. They can be used for:

- Quick and easy security system operation
- Control of the home environment, including lights and contains provisions for the future control of heating and air-conditioning.

**Note:** To the installer, see the "Important Notes" section at the back of this guide.

---

**UL** The home environment control feature has not been evaluated by UL.

---

**Note:** The 6271 Series devices are certified SIA-compliant devices that meet SIA specifications for False Alarm Reduction.

**System Features****Security**

- Arm System: – Away – Stay – Night
- Disarm System
- User Codes - Allows authorized user to add or delete codes
- Bypass Zones

**Setup**

- Volume
- Contrast
- Diagnostics
- Keypad Emulation (Console Mode)

**NOTE:** Models 6271V and 6271CV are available in English only.

*TouchCenter Installation and Setup Guide*

---

**Compatibility**

The below listing identifies the alarm systems that the TouchCenter can interface with, the maximum number of TouchCenters that can be used with each system, and the minimum alarm panel software revision level for compatibility.

<b><u>ALARM SYSTEM</u></b>	<b><u>MAXIMUM NUMBER OF TOUCHCENTERS</u></b>	<b><u>MINIMUM SOFTWARE REVISION LEVEL</u></b>
VISTA-15P	2	3.0
VISTA-20P	2	3.0
VISTA-20P	4	5.0
VISTA-20PS	2	3.0
VISTA-20PS	4	5.0
VISTA-128BP	3	2.4
VISTA-128FBP	3	1.6
VISTA-250BP	3	2.4
VISTA-250FBP	1	1.5
VISTA-250FBP	3	2.0



- On all panels except the residential panels, you may obtain the software revision level of the alarm panel by entering the program mode and then entering **#92** on the keypad. The second line of the keypad displays the software revision level (without the decimal point).
- The keypad sound suppression feature available in some commercial panels is not compatible with the TouchCenter.

**ECP Error**

The message “ECP Error” will be displayed at the top of the screen (except for the Home screen) when the TouchCenter cannot communicate with the alarm panel. This may be caused by an incorrect ECP address in the TouchCenter or because AUI type devices have not been enabled in the panel. While this message is being displayed, you must use the TouchCenter default code of “4140” any time the TouchCenter requests an authorized code.

S E C T I O N 2

## Mounting and Wiring

.....

### **In This Section**

- ◆ *Mounting the TouchCenter Mounting Plate*
  - ◆ *Wiring the TouchCenter*
- .....

### **Mounting the TouchCenter Mounting Plate**

The TouchCenter should be mounted using the following criteria:

- The TouchCenter must be mounted **indoors**
- should be mounted at eye level for easy viewing by the user
- should not be mounted in areas of high condensation such as bathrooms
- should not be mounted in locations where bright light or sunlight shines directly on the screen

To mount the TouchCenter mounting plate, complete the following steps:

1. Detach the mounting plate from the TouchCenter by pushing it toward the bottom of the TouchCenter.
2. Locate the mounting plate over the mounting surface such that the opening in the mounting plate is aligned with the wire/cable access opening (in the mounting surface) while passing the wires/cable through the opening in the mounting plate. (See Figure 1.)  
**Note:** The back of the TouchCenter has wire channels leading to the bottom and the left side if surface wiring is being used.
3. Secure the mounting plate to the mounting surface using four screws (supplied).

## TouchCenter Installation and Setup Guide

---

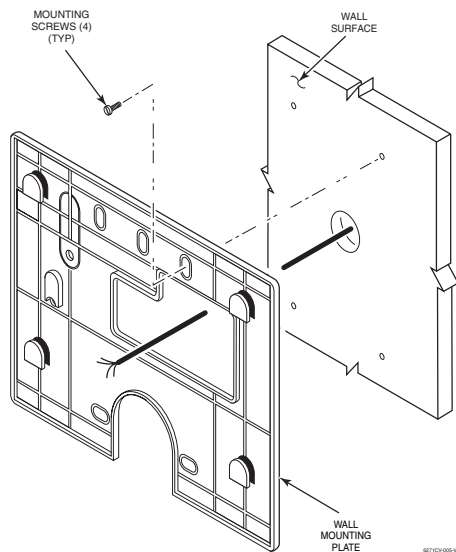

**Figure 1. Mounting the TouchCenter Mounting Plate**

### Wiring the TouchCenter

Connect TouchCenter in parallel with keypads and other peripheral devices using the keypad data (ECP) bus. Determine wire gauge by referring to the Wire Run Length/Gauge table below.

Wire Run Length/Gauge Table	
Wire Gauge	Length
#22 gauge	150 feet
#20 gauge	240 feet
#18 gauge	350 feet
#16 gauge	550 feet

If more than one keypad is wired to one run, then the above maximum lengths must be divided by the number of keypads on the run (e.g., the maximum length is 75 feet if two keypads are wired on a #22 gauge run).



Unshielded 4-conductor cable is recommended for the power/data wire.



---

## SECTION 2: Mounting and Wiring

---

To wire, see the Summary of Connections diagrams at the back of this guide, or the appropriate Systems Interconnection Diagram provided, and follow the instructions below.



The TouchCenter draws up to 230mA (on models 6271C, 6271CB, 6271CS and 6271CV), and 210mA (6271V). If you are planning to power it from your panel's Aux Power output, check your panel's Installation and Setup Guide and verify that this device and others do not exceed your panel's Aux Power output capability. If it does, a supplementary power supply is needed.

### Connect the wires to the TouchCenter terminal block as follows:

1. Connect +12VDC to the TouchCenter using step a or b below.
  - a. If powering the keypad from the control panel, connect the AUX + terminal of the control panel to the + terminal block position (+12VDC terminal of the TouchCenter (red wire)).
  - b. If powering the keypad from a supplementary power supply, connect the + terminal of the supplementary power supply to the + terminal block position (+12VDC terminal of the TouchCenter (red wire)).

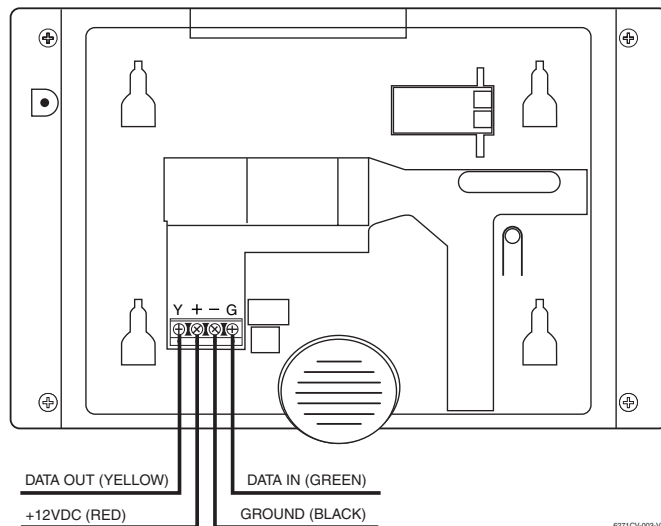
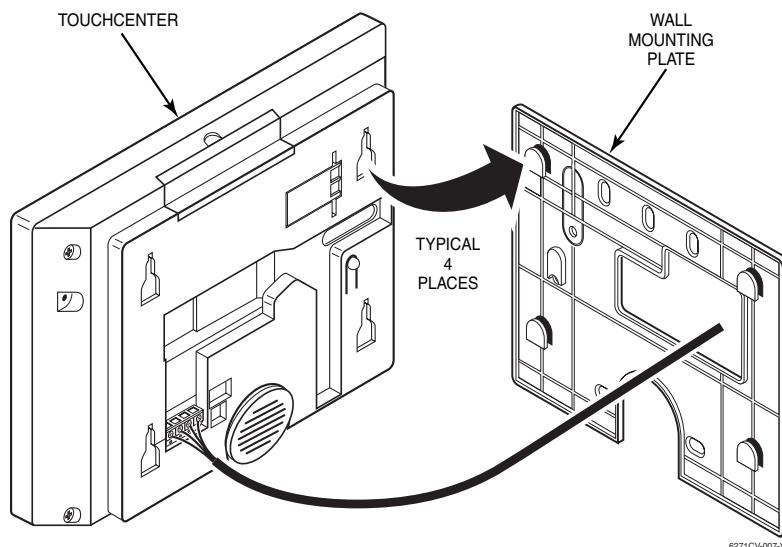

**Figure 2. Wiring the TouchCenter**

### *TouchCenter Installation and Setup Guide*

---

2. Connect ground to the TouchCenter using step a or b below.
  - a. If powering the keypad from the control panel, connect the AUX – terminal of the control panel to the – terminal block position (GND terminal of the TouchCenter (black wire)).
  - b. If powering the keypad from a supplementary power supply, connect the AUX – terminal of the control panel to the (–) terminal of the supplementary power supply (black wire). Then, connect the (–) terminal of the supplementary power supply to the – terminal block position (GND terminal of the TouchCenter (black wire)).
3. Connect Data Out terminal of the control panel to the Y terminal block position (Data In terminal of the TouchCenter (yellow wire)).
4. Connect the Data In terminal of the control panel to the G terminal block position (Data Out terminal of the TouchCenter (green wire)).
5. Mount the TouchCenter onto the mounting plate as shown in Figure 3.



**Figure 3. Mounting the TouchCenter**

## SECTION 3





## Front Panel LEDs and Navigation Icons

### In This Section

- ◆ Front Panel LEDs
- ◆ Navigation Icons







### Front Panel LEDs

The TouchCenter has three LEDs labeled - ARMED, READY and TROUBLE (6271C, 6271CS and 6271CB) or MESSAGE (6271V and 6271CV). The ARMED LED is red, READY LED is green and TROUBLE or MESSAGE LED is yellow. Each LED's on and off state has different meanings as described below.

LED		DESCRIPTION
ARMED		ON – Security system is armed. OFF – Security system is not armed.
READY		ON – Security system is disarmed and ready to arm. OFF – Security system is armed or disarmed but not ready. If disarmed, faults or troubles are present.
MESSAGE (Voice models only)		FLASHING – The system contains new message(s) for the User OFF – No new messages.
TROUBLE (non-Voice models only)		ON – The Security System has one or more Trouble(s). OFF – No Trouble.

*TouchCenter Installation and Setup Guide***Navigation Icons**

To aid in the navigation through TouchCenter screens, a set of user-friendly icons has been provided. The appearance, function, and location of these icons is described below:

ICON	LOCATION	FUNCTION
	"Home" screen	Allows you to record and retrieve voice messages. (6271V and 6271CV Only)
	"Home" screen	Allows you to turn certain devices on and off (if installed and programmed by your installer.)
	"Home" screen	Accesses "Arming" screen. <b>Note:</b> The lock symbol (and lock color on models with Color feature only) indicates security system status. Unlocked and green – system disarmed Unlocked and yellow – system disarmed and a system trouble exists Locked and red – system armed
	Upper left corner of most screens	Returns you to the TouchCenter "Home" screen. This icon is called the <b>Home</b> button within the text of this document.
	Upper right corner of most screens	Reverts to the last screen viewed. This icon is called the <b>Back</b> button within the text of this document.
	Lower right corner of screen	Displays Emergency functions (as programmed by the installer). This icon is called the <b>Panic</b> button within the text of this document. <b>Note:</b> This icon is displayed and active on all screens except while in the Clean Screen mode and during an LCD Display test in Diagnostics.
	Lower right corner of screen (left of panic)	This icon alerts the user to a Control Panel Message.

## SECTION 4

**Initial Setup****In This Section**

- ◆ *Programming the Control Panel*
- ◆ *How to Access the Central Station Screen*
- ◆ *TouchCenter Initialization*
- ◆ *TouchCenter Setup*
- ◆ *How to Change the ECP Address*
- ◆ *Setting Operating Modes*

**Programming the Control Panel**

The TouchCenter will not be fully operational unless its address in the control panel has been enabled for an alpha console, AUI type device, and assigned to a partition (where applicable). Refer to “Compatibility” on page 1–1 of this document for the quantity of TouchCenters that may be used and the required control panel software revision level.

**Note:** When programming your control panel, if you change the zone types for your emergency zones you may disable the emergency buttons in the TouchCenter. The emergency buttons in the TouchCenter are active for zone types 06 and 07 (Panic button), 08 (Medical button), and 09 (Fire button). Additionally, the Medical button is also compatible with a zone type 15 (24-Hour Medical) for panels that contain this zone type.

**On residential control panels (VISTA-20P or equivalent)**, up to four TouchCenters may be used (addresses 1, 2, 5 and 6). Addresses 1 and 2 (in field \*189) are enabled by default. If the defaults have been changed, enable these addresses (in field \*189) using an alpha-keypad and the Data Field Programming procedures located in the panel Installation and Setup Guide.

**On commercial control panels (VISTA-128BP, VISTA-128FBP, or equivalent)**, addresses 1, 2, and one address from 3 through 30 may be used for the TouchCenter. These addresses in the control panel are normally not defaulted for AUI type devices. To enable the

*TouchCenter Installation and Setup Guide*

addresses you will be using for TouchCenters, use an alpha-keypad and follow the procedures for “Device Programming” in your control panel “Programming Guide.”

**Notes:**

- If multiple TouchCenters are being used, they must be set to addresses 1, 2, and X (where X equals any address from 3 through 30. Only one AUI type device may be assigned to an address from 3 through 30 on commercial control panels.
- The TouchCenter should not be assigned as a Master Console. If the TouchCenter is assigned as a Master Console, partitions must be controlled from the Partition screen or using the Console Emulation Mode.

**6271V and 6271CV Word List**

The 6271V and 6271CV has the capability of annunciating the words listed below. Please note that this listing does not increase the vocabulary available from your panel. You must use the listing in your alarm panel instructions for actual words that may be requested for annunciation.

AC-Loss	Down	Glass	Office	South
Air	Downstairs	Gun	On	Station
Alarm	Driveway	Hall	One	Stay
Apartment	Duct	Heat	One-Hundred	Storage
Area	East	House	Open	Supervise
Armed	Eight-Hundred	Hundred	Outside	Telco
Attic	Eight	Inside	Panic	Temperature
Away	Eighteen	Instant	Patio	Ten
Baby	Eighty	Kitchen	Phone	Third
Back	Eleven	Laundry	Police	Thirteen
Bar	Emergency	Left	Pool	Thirty
Basement	Equipment	Library	Power	Three-Hundred
Bathroom	Exit	Light	Ready-to-Arm	Three
Bed	Factory	Living	Rear	Tool
Bedroom	Father's	Loading	Right	Twelve
Blower	Fault	Low-Battery	Room	Twenty
Boiler	Fence	Lower	Second	Two-Hundred
Building	Fifteen	Machine	Service	Two
Bypassed	Fifty	Main	Seven-Hundred	Up
Call	Fire	Master	Seven	Upper
Carbon-Monoxide	First	Medical	Seventeen	Upstairs
Central	Five-Hundred	Mother's	Seventy	Utility
Check	Five	Motion	Shed	West
Closed	Floor	Night	Shop	Window
Computer	Forty	Nine-Hundred	Side	Wing
Daughter's	Four-Hundred	Nine	Six-Hundred	Yard
Den	Four	Nineteen	Six	Zero
Detector	Fourteen	Ninety	Sixteen	Zone
Dining	Foyer	North	Sixty	
Disarmed	Front	Not	Sliding	
Disarm-System-Now	Garage	Now	Smoke	
Door	Gas	Off	Son's	

## SECTION 4: Initial Setup

**TouchCenter Initialization****Power Up**

When initially powered, the screen displays the boot sequence as it is performed. After it is determined what services are available, the screen displays the Set ECP Address screen.

SCREEN	ACTION
	<p>If the system is incorporating only one TouchCenter, leave the address set to 1 and press the <b>APPLY</b> button. The boot-up process will continue until completion.</p> <p>If there are to be additional TouchCenter units in the system, refer to the <i>How to Change the ECP Address</i> paragraph.</p>

**How to Change the ECP Address**

After enabling addresses in the control panel using an alpha-keypad, power up each TouchCenter one at a time, and set its address to one of the addresses you enabled in the control panel. If this is a first time power-up of the unit, follow the initialization procedure in this section. Otherwise, access the Central Station screen then follow the procedure to change the address on the unit.

**Language Selection**

The 6271C, 6271CS, and 6271CB has the functionality to display three different languages (English, French and Spanish) with the default being English.

**How to Select a Language**

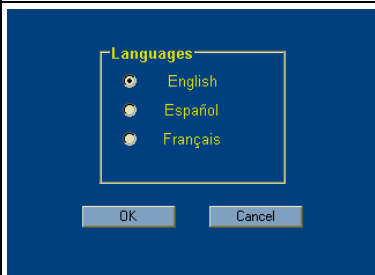

SCREEN	ACTION
	<p>After the initial ECP selection is set, the "Languages" screen is displayed.</p> <p>Select from English, Spanish or French and click OK. If Cancel is selected, the keypad will be displayed in English.</p>

*TouchCenter Installation and Setup Guide*

**How to Access the Central Station Screen**

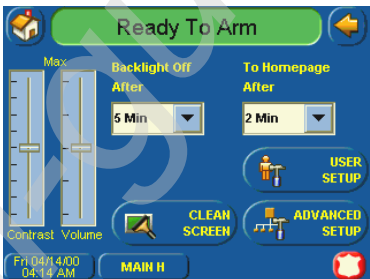

To Access the “Central Station” screen perform the following:

1. Press the **SECURITY** button on the “Home” screen. The “Arming” screen is displayed.

SCREEN	ACTION
	<ol style="list-style-type: none"> <li>2. Press the <b>MORE CHOICES</b> button. The “More Choices” screen is displayed.</li> </ol>
	<ol style="list-style-type: none"> <li>3. Press the <b>SETUP</b> button on the “More Choices” screen. The “Setup” screen is displayed.</li> </ol>
	<ol style="list-style-type: none"> <li>4. Press the <b>ADVANCED SETUP</b> button. The <b>Enter Authorized Code:</b> authorization screen is displayed.</li> </ol>



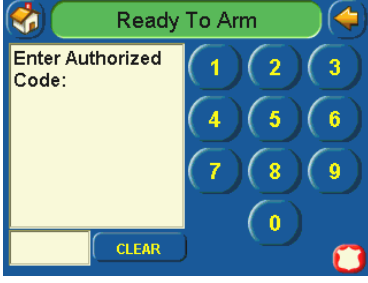

SECTION 4: Initial Setup

SCREEN	ACTION
	<p>5. Enter your 4-digit Installer code. The “Advanced Setup” menu screen is displayed.</p> <p><b>Note:</b> If the top of the screen is displaying ECP Error, the ECP address in the TouchCenter is not valid for the panel that it is connected to. To change the ECP address in the TouchCenter when ECP Error is being displayed, enter the TouchCenter default code of “4140” to advance to the next screen.</p>
	<p>6. Press the <b>Central Station</b> button. The “Central Station” menu screen is displayed.</p>
	<p><b>NOTE:</b> The Resets and Running counters are shown on this screen near the lower-left corner. The Resets counter displays the number of times the TouchCenter has been reset since it was installed while the Running counter indicates how long the TouchCenter has been running since the last time it was reset.</p>

*TouchCenter Installation and Setup Guide*



To change the address, perform the following.

SCREEN	ACTION
	<p>1. On the "Central Station" screen press the ECP Address button. A pop-up window is displayed with options for selecting the TouchCenter's ECP address.</p>
	<p>2. The available ECP addresses are:          1-2, 5-6 for residential controls or          1-30 for commercial controls          Select the ECP address for this TouchCenter using the Up/Dn arrows. Press the <b>APPLY</b> button to accept the address setting or the <b>BACK</b> or <b>HOME</b> buttons to maintain the original ECP address. If <b>APPLY</b> is selected, the TouchCenter will reset. If <b>BACK</b> is selected, The "Central Station" menu screen is displayed.</p>
	

SECTION 4: Initial Setup

**How to Select System Options**

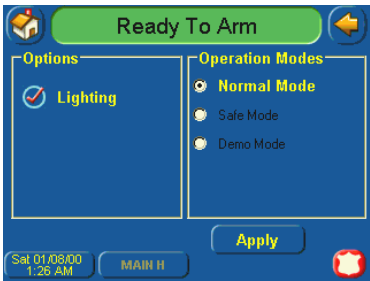
The system options allow you to place buttons on the "Home" screen. The **SECURITY** button is always displayed and cannot be removed. A Lighting button can also be added to the "Home" screen. To avoid confusion to the user, only buttons whose options are functional in the system should be displayed. To select the system options, do the following:

SCREEN	ACTION
	<p>1. On the "Central Station" screen press the <b>Options</b> button. A pop-up window is displayed with an option for selecting <b>Lighting</b>.</p>
	<p>2. Touch the Lighting button to turn the Lighting option on or off. A checkmark appears in the button when the Lighting option is "ON".  <b>Note:</b> DO NOT select the Demo Mode option. This option should only be selected if instructed to do so by factory service. When this option is selected, the keypad will not communicate with the control panel and any user can select Advanced Setup screens.                  Press the <b>Apply</b> button to accept the setting. The TouchCenter returns to the "Central Station" menu screen.</p>
	



*TouchCenter Installation and Setup Guide*

**How to Set the NIGHT Setup Button Function**

The NIGHT button can be set to arm the system in one of five arming modes:

- Away - When selected, arms all zones with entry delay.
- Stay - When selected, arms perimeter zones with entry delay.
- Instant - When selected, arms perimeter zones without entry delay.
- Night (Residential Panels Only) – When selected, arms all perimeter zones plus all zones listed in Zone List 5.
- Maximum - When selected, arms all zones without entry delay.

To set the NIGHT button function, do the following:



SCREEN	ACTION
	<p>1. On the "Central Station" screen press the <b>Night Setup</b> button. A Night Setup: pop-up window is displayed with options for selecting Away, Stay, Instant, Maximum and Night.</p>
	<p>2. Select the arming mode that will be activated by pressing the <b>NIGHT</b> button on the "Arming" screen. Press the <b>Apply</b> button to accept the setting, or press the <b>Back</b> button to cancel your selection. In either case the TouchCenter goes to the "Central Station" menu screen.</p>

SECTION 4: Initial Setup

SCREEN	ACTION
	

**How to View and Edit Screen Security**

The **Screen Security** button displays a screen that lists the various screen classes in the TouchCenter and lists what level user has been given access to them. To view and/or edit screen security, do the following:

SCREEN	ACTION																		
	<p>1. On the “Central Station” screen, press the <b>Screen Security</b> button. A listing of the classes of screens and the user level that has access to them will be displayed.</p>																		
 <table border="1" data-bbox="393 1339 750 1465"> <thead> <tr> <th>Screen</th> <th>Type</th> <th>Authority</th> </tr> </thead> <tbody> <tr> <td>Advanced Setup</td> <td>Security</td> <td>Master</td> </tr> <tr> <td>Central Station Setup</td> <td>Security</td> <td>Installer</td> </tr> <tr> <td>Operating Modes</td> <td>Security</td> <td>Operator C</td> </tr> <tr> <td>Event Logs</td> <td>Security</td> <td>Anyone</td> </tr> <tr> <td>Lighting</td> <td>Light</td> <td>Anyone</td> </tr> </tbody> </table>	Screen	Type	Authority	Advanced Setup	Security	Master	Central Station Setup	Security	Installer	Operating Modes	Security	Operator C	Event Logs	Security	Anyone	Lighting	Light	Anyone	<p>2. If the listing is correct, depress the <b>BACK</b> button to return to the “Central Station” screen. If changes are necessary, select the line to be changed and a Setup screen will be displayed.</p> <p><b>Note:</b> The Setup screen contains a heading of Advanced Setup, Central Station Setup, Operating Modes, Event Logs, or Lighting indicating which line was selected for change.</p>
Screen	Type	Authority																	
Advanced Setup	Security	Master																	
Central Station Setup	Security	Installer																	
Operating Modes	Security	Operator C																	
Event Logs	Security	Anyone																	
Lighting	Light	Anyone																	

*TouchCenter Installation and Setup Guide*

SCREEN	ACTION
	<p>3. Select the level of user who is to have access to the selected class of screens and then select the <b>OK</b> button. The Screen Security screen will be re-displayed listing the change. Depress the <b>BACK</b> button to return to the “Central Station” screen.</p> <p><b>Note:</b> The User Levels listed on this screen match the User Levels in commercial panels. See the chart below for corresponding User Levels in Residential Panels.</p>

**Residential Panels and Screen Security**



Authority Level in Panel	Matching Authority Level in TouchCenter	Access Level Chosen in TouchCenter Screen Security					
		Installer	Master	Manager	Operator A	Operator B	Operator C
System Master	Master	No	Yes	Yes	Yes	Yes	Yes
Partition Master	Master	No	Yes	Yes	Yes	Yes	Yes
Standard User	Normal	No	No	No	Yes	Yes	Yes
Arm Only	N/A	No	No	No	No	No	No
Guest	Guest	No	No	No	No	Yes	Yes
Duress	N/A	No	No	No	No	No	No

**How to View Code Authority**

The **Code Authority** button displays a screen that contains the User Name and Partition Authority Level for the User Code that is entered. To view the Code Authority level, do the following:

SCREEN	ACTION
	<p>1. On the “Central Station” screen press the <b>Code Authority</b> button. An Enter Authorized Code screen will be displayed.</p>

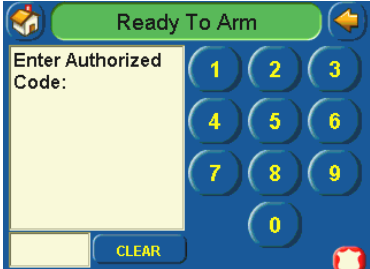
SECTION 4: Initial Setup



SCREEN	ACTION												
	<p>2. Enter the 4-digit User Code corresponding to the user that you want to obtain Authority Level information about. An Authority Level screen containing this information will be displayed.</p>												
	<p>3. Press the <b>BACK</b> button to return to the “Central Station Screen”.</p> <p><b>Note:</b> The User Levels listed on this screen match the User Levels in commercial panels. See the chart below for corresponding User Levels in Residential Panels.</p> <p><b>Authority In Panel    Level Shown As</b></p> <table border="0"> <tr> <td>Standard User</td> <td>Operator A</td> </tr> <tr> <td>Arm Only</td> <td>Unknown</td> </tr> <tr> <td>Guest</td> <td>Operator B</td> </tr> <tr> <td>Duress</td> <td>Duress</td> </tr> <tr> <td>Partition Master</td> <td>Master</td> </tr> <tr> <td>System Master</td> <td>Master</td> </tr> </table>	Standard User	Operator A	Arm Only	Unknown	Guest	Operator B	Duress	Duress	Partition Master	Master	System Master	Master
Standard User	Operator A												
Arm Only	Unknown												
Guest	Operator B												
Duress	Duress												
Partition Master	Master												
System Master	Master												

**How to View the Panel Configuration**

The **Panel Config** button displays a screen that contains the configuration of the panel that the TouchCenter is connected to. To view the panel configuration, do the following:

SCREEN	ACTION
	<p>1. On the “Central Station” screen press the <b>Panel Config</b> button. A Panel Configuration screen will be displayed providing details of your system.</p>

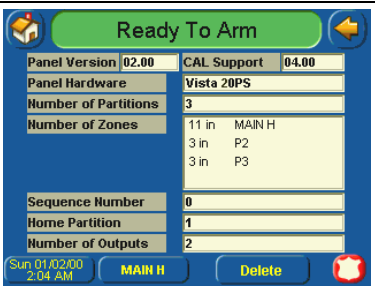
*TouchCenter Installation and Setup Guide*

SCREEN	ACTION
	<p>2. Depress the <b>Back</b> button to return to the “Central Station” screen or if you desire to clear the configuration from the TouchCenter and have it reload the panel configuration into the TouchCenter from the panel, depress the <b>Delete</b> button. After you depress the <b>Delete</b> button, a confirmation screen is displayed.</p>
	<p>3. Select <b>OK</b> to delete the configuration or <b>Cancel</b> to return to the “Panel Configuration” screen. If you select OK, the TouchCenter will be reset and the panel configuration will be downloaded from the panel into the TouchCenter. After the reset and download is complete, the “Home” screen is displayed.</p>

**TouchCenter Setup**

Setup allows you to make changes to the way your TouchCenter is operating. The options that can be changed are:

- Adjust the touch screen contrast
- Adjust the TouchCenter sounder volume
- Change the time interval that must pass prior to the TouchCenter turning off the touch screen backlight
- Change the time interval that must pass prior to the TouchCenter returning to the “Home” screen



Additionally, you may enter the **User Setup** screen, **Advanced Setup** screen (if enabled by your system installer), or **Clean Screen** (maintenance mode) from the "Setup" screen by pressing the corresponding button.

Access the "Setup" screen as follows:

1. From the "Home" screen, press the **SECURITY** button. The "Arming" screen is displayed.

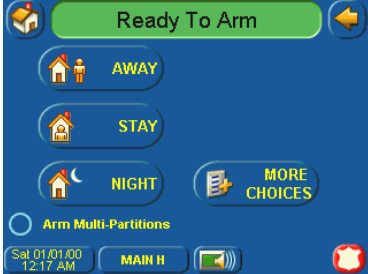

SECTION 4: Initial Setup

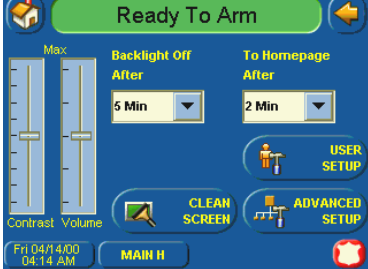
SCREEN	ACTION
	<p>2. Press the <b>MORE CHOICES</b> button. The "More Choices" screen is displayed.</p>
	<p>3. Press the <b>SETUP</b> button on the "More Choices" screen. The "Setup" screen is displayed.</p>
	<p>4. Adjust the TouchCenter options as described in the paragraphs that follow.</p>

## *TouchCenter Installation and Setup Guide*

---

### **How to Adjust the Contrast**

You may adjust the contrast as follows:

To increase contrast, move the slide bar above the current contrast setting.

To decrease contrast, move the slide bar below the current contrast setting.

If you have made any changes in the contrast settings, when you exit this screen you will be presented with a pop-up asking if you want to remember the new settings.

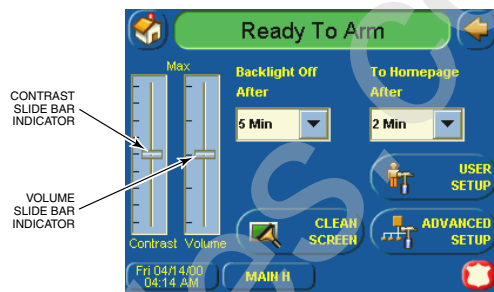

### ***Contrast and Volume Control***

### **How to Adjust the Volume**

You may adjust the sounder volume by pressing your finger on the slide bar associated with the "Volume" scale and doing the following:

To increase volume move the slide bar above the current volume setting.



To decrease volume move the slide bar below the current volume setting.

If you have made any changes in the volume settings, when you exit this screen you will be presented with a pop-up asking if you want to remember the new settings.

### **How to Select Screen Backlight Off Activation Time**

When the TouchCenter is not active, it will automatically turn the backlight off after the selected backlight off time has expired (unless "Never" option is selected). To select the screen backlight time, do the following:

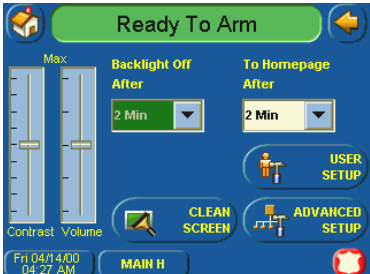

SECTION 4: Initial Setup

SCREEN	ACTION
	<ol style="list-style-type: none"> <li>1. On the "Setup" screen, press the <b>Backlight Off After</b>: "arrow" button. A drop-down list displaying the time period options is displayed.</li> <li>2. Select the time period option you want by pressing it. The drop-down list closes automatically and the selection is displayed.</li> </ol>
	<p><b>Note:</b> Additional options can be viewed by using the up/down "arrows" to scroll through the time period options.</p> <ol style="list-style-type: none"> <li>3. Press either the "Home" or "Back" button. A <b>Settings Changed!</b> pop-up window is displayed asking <b>"Remember New Settings?"</b> Select <b>Yes</b> to save the change or <b>No</b> to discard the change.</li> </ol>
	<p>When the Update is complete the TouchCenter goes to the "Home" screen or "More Choices" screen depending on whether you pressed the "Home" or "Back" button, respectively.</p>

*TouchCenter Installation and Setup Guide*

**How to Select Homepage After Time**

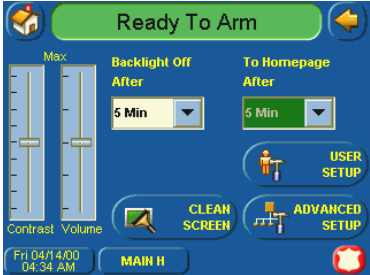
When the TouchCenter is not active, it will automatically return to the “Home” screen after the selected To Homepage After time has expired (unless “Never” option is selected). To select the To Homepage After time, do the following:

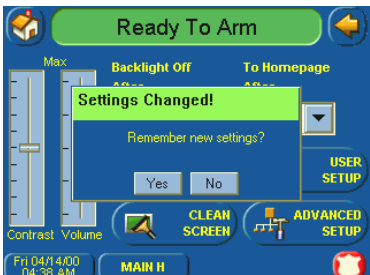
SCREEN	ACTION
	<p>1. On the "Setup" screen, press the <b>To Homepage After</b> "arrow" button. A drop-down list displaying the time period options is displayed.</p>
	<p>2. Select the time period option you want by pressing it. The drop-down list closes automatically and the selection is displayed.</p>
	<p>3. Press either the "Home" or "Back" button. A <b>Settings Changed!</b> pop-up window is displayed asking “<b>Remember New Settings?</b>” Select <b>Yes</b> to save the change or <b>No</b> to discard the change.</p> <p>When the Update is complete the TouchCenter goes to the "Home" screen or "More Choices" screen depending on whether you pressed the "Home" or "Back" button, respectively.</p>

**How to Set the Time and Date**

You can set the time and date from the **Set Time & Date** screen. Pressing the Time and Date button located at the bottom of the TouchCenter screen displays the **Set Time & Date** screen.

SECTION 4: Initial Setup

- When the time is set it will be stored in the TouchCenter and sent to the control panel when you press the **Apply** button and answer **Yes** to the following prompt. Additionally, when using the TouchCenter with a residential panel, the panel will download its time into the TouchCenter once an hour after the clock is set.
- If **Get Time** is pressed, the TouchCenter will download the time and date from the control panel and exit the Set Time & Date screen. **Note:** This button appears with residential panels only.
- If **DST On** (Daylight Savings Time) is selected, the TouchCenter will adjust for Daylight Savings time at the month, week and time chosen.

**Setting Daylight Savings Time**

Press the Time and Date button located at the bottom of the screen and do the following:

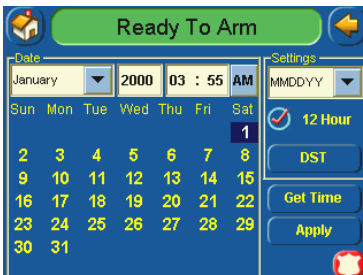
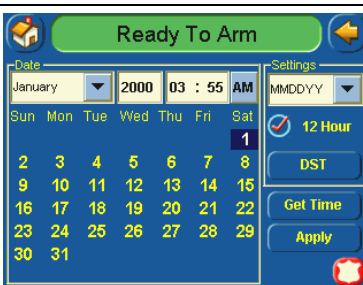
SCREEN	ACTION
	<ol style="list-style-type: none"> <li>1. On the "Time and Date" screen, press the <b>Month/Day/Year</b> "arrow" button in the "Settings" area of the screen. A drop-down list displaying the Month/Day/Year display formats is displayed.</li> <li>2. Select the display format you want by pressing it. The drop-down list closes automatically and the selection is displayed.</li> </ol>
	<ol style="list-style-type: none"> <li>3. Select if you want a 12-hour or 24-hour format for your time display by touching the circle to the left of the <b>12 Hour</b> display in the "Settings" area of the screen. A check mark in the circle indicates a 12-hour display format.</li> <li>4. Select if you want Daylight Savings Time to affect your system clock by pressing the <b>DST</b> button in the "Settings" area of the screen. The Daylight Savings Screen will be displayed.</li> </ol>

*TouchCenter Installation and Setup Guide*

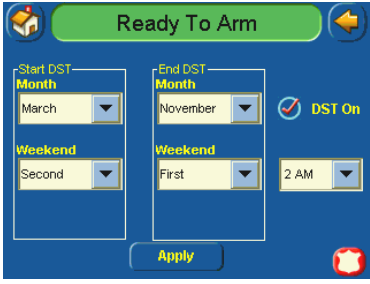
SCREEN	ACTION
	<p>5. Select if you want Daylight Savings Time to affect your system clock by touching the circle to the left of the <b>DST On</b> display. A check mark in the circle indicates that Daylight Savings Time is applicable.</p> <p>6. On the "Daylight Savings" screen, press the <b>Month</b> "arrow" button in the "Start DST" area of the screen. A drop-down list displaying the Months is displayed.</p> <p>7. Select the month you want by pressing it. The drop-down list closes automatically and the selection is displayed.</p>

## SECTION 4: Initial Setup

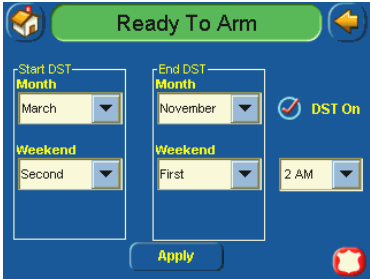
SCREEN	ACTION
	<p>8. On the "Daylight Savings" screen, press the <b>Weekend</b> "arrow" button in the "Start DST" area of the screen. A drop-down list displaying the weeks is displayed.</p> <p>9. Select the week you want by pressing it. The drop-down list closes automatically and the selection is displayed.</p> <p>10. On the "Daylight Savings" screen, press the <b>Month</b> "arrow" button in the "End DST" area of the screen. A drop-down list displaying the Months is displayed.</p> <p>11. Select the month you want by pressing it. The drop-down list closes automatically and the selection is displayed.</p> <p>12. On the "Daylight Savings" screen, press the <b>Weekend</b> "arrow" button in the "End DST" area of the screen. A drop-down list displaying the weeks is displayed.</p> <p>13. Select the week you want by pressing it. The drop-down list closes automatically and the selection is displayed.</p> <p>14. On the "Daylight Savings" screen, press the "arrow" button to the right of the time (1 AM or 2 AM) on the screen. A drop-down list displaying 1 AM and 2AM is displayed.</p> <p>15. Select the time you want by pressing it. The drop-down list closes automatically and the selection is displayed.</p> <p>16. Press the <b>APPLY</b> button to save your Daylight Savings Time setup. The "Time and Date screen is displayed.</p>

*TouchCenter Installation and Setup Guide*

**Setting Current Time**

To set the current time, do the following:

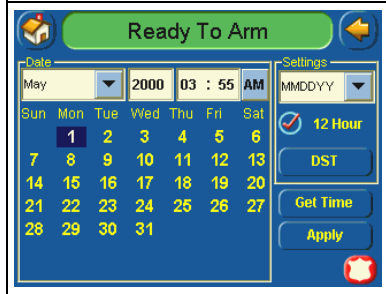
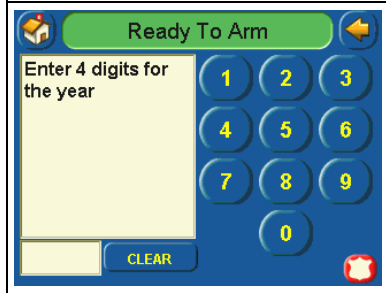
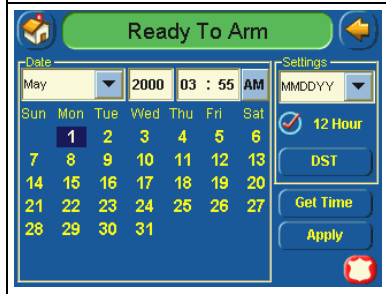

	<ol style="list-style-type: none"> <li>1. On the "Time and Date" screen, press the <b>Month</b> "arrow" button. A drop-down list displaying the months is displayed.</li> <li>2. Select the current month by pressing it. The drop-down list closes automatically and the selection is displayed.</li> </ol>
	<ol style="list-style-type: none"> <li>3. On the "Time and Date" screen, press the Year that is being displayed. A Year screen is displayed with the instructions to <b>Enter 4 digits for the year</b>.</li> </ol>
	<ol style="list-style-type: none"> <li>4. Enter the four digits for the current year. The window closes automatically and the selection is displayed.</li> </ol>
	<ol style="list-style-type: none"> <li>5. Select if it is AM or PM by pressing on the <b>AM</b> or <b>PM</b> display on the screen. Each depression switches the AM/PM display.</li> <li>6. Select the day of the month by touching the proper day in the display. The selected date will be highlighted on the screen.</li> </ol>



SECTION 4: Initial Setup

	<p>7. On the "Time and Date" screen, press the Hour that is being displayed. An hour screen is displayed with the instructions to <b>Enter 2 digits for the hour</b>.</p>
	<p>8. Enter the two digits for the current hour. The window closes automatically and the selection is displayed.</p>
	<p>9. On the "Time and Date" screen, press the Minutes that is being displayed. A minutes screen is displayed with the instructions to <b>Enter 2 digits for the minutes</b>.</p>
	<p>10. Enter the two digits for the current minute. The window closes automatically and the selection is displayed.</p>

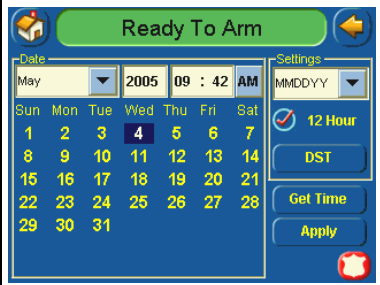
*TouchCenter Installation and Setup Guide*

	<p>11. On the "Time and Date" screen, press the <b>Apply</b> button. A confirmation screen is displayed.</p>
	<p>12. Press the <b>Yes</b> button to save the time changes in your security system or press the <b>No</b> button to have the changes affect the TouchCenter only. <b>Note:</b> A <b>Yes</b> response is recommended.</p>

**Setting Operating Modes**

Operating modes allow you to turn the TouchCenter chime mode on or off. Additionally, when using the 6271V and 6271CV you may also turn the voice mode on or off. The operating modes provide the following features:

- Chime Mode – When selected, a request is sent to the alarm panel requesting that the panel chime the TouchCenter whenever a change in zone status occurs.
- Voice Mode (6271V and 6271CV Only) – When selected, a request is sent to the alarm panel requesting that the panel initiate TouchCenter voice annunciation whenever a change in system status occurs such as Armed, Disarmed, or Alarms.
- Voice Chime Mode (6271V and 6271CV Only) – The chime mode and voice mode are in effect. When selected, you will get the chime beeps followed by voice annunciation.



**Language Selection**

The 6271C, 6271CS, and 6271CB allows you to select from three different languages, (English, French and Spanish) with the default being English.

*SECTION 4: Initial Setup*

Access the "Operating Modes" screen as follows:

1. From the "Home" screen, press the **SECURITY** button. The "Arming" screen is displayed.

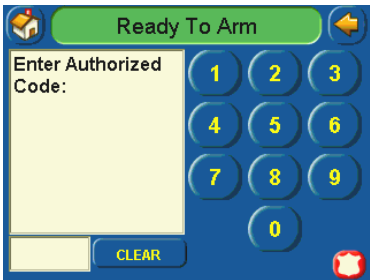
SCREEN	ACTION
	<ol style="list-style-type: none"> <li>2. Press the <b>MORE CHOICES</b> button. The "More Choices" screen is displayed.</li> </ol>
	<ol style="list-style-type: none"> <li>3. Press the <b>OPERATING MODES</b> button on the "More Choices" screen. The "User Authorization" screen is displayed with the instructions "<b>Enter Authorized Code</b>".</li> </ol>
	<ol style="list-style-type: none"> <li>4. Enter your Authorized code. The "Operating Modes" screen is displayed.</li> </ol>

*TouchCenter Installation and Setup Guide*

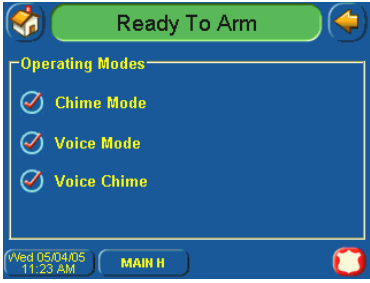
SCREEN	ACTION
 <p>The screenshot shows a 'Ready To Arm' screen with a green header bar. Below it is a blue box titled 'Operating Modes' containing three items: 'Chime Mode', 'Voice Mode', and 'Voice Chime', each with a checkmark icon. At the bottom left, the date and time are 'Wed 05/04/05 11:23 AM' and a 'MAIN H' button is visible.</p>	<p>5. Touch the Chime Mode button to turn the Chime Mode on or off. A checkmark appears in the button when the Chime Mode is "ON". Note that it may take a few seconds for the Chime Mode to take effect.</p> <p>6. (6271V and 6271CV Only) Touch the Voice Mode button to turn the Voice Mode on or off. A checkmark appears in the button with the Voice Mode is "ON" Note that if the Chime Mode and Voice Mode are both selected, the Voice Chime button will automatically be selected.</p> <p>Press the "HOME" or "BACK" button after making your selection. When the TouchCenter exits the "Operating Modes" screen, your selection is saved.</p>



**How to Access Language Selection**

Access the "Language Selection" feature as follows:

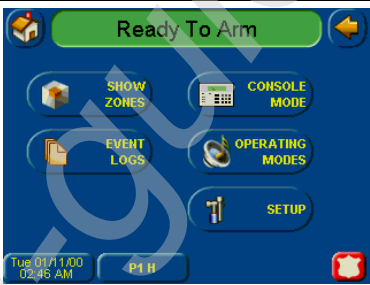
1. From the "Home" screen, press the **SECURITY** button. The "Arming" screen is displayed.

SCREEN	ACTION
 <p>The screenshot shows a 'Ready To Arm' screen with a green header bar. Below it is a blue box containing several menu options: 'SHOW ZONES', 'CONSOLE MODE', 'EVENT LOGS', 'OPERATING MODES', and 'SETUP'. At the bottom left, the date and time are 'Tue 01/11/00 02:46 AM' and a '&lt; P1 H' button is visible.</p>	<p>2. Press the <b>MORE CHOICES</b> button. The "More Choices" screen is displayed.</p> <p>3. Press the <b>OPERATING MODES</b> button on the "More Choices" screen. The "User Authorization" screen is displayed with the instructions "<b>Enter Authorized Code</b>".</p>

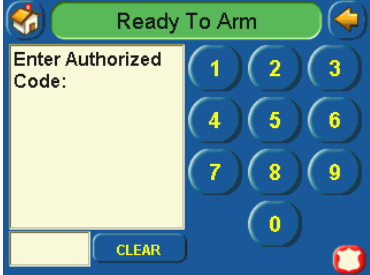
*SECTION 4: Initial Setup*

SCREEN	ACTION
	<p>4. Enter your "Authorized Code". The "Operating Modes" screen is displayed.</p>
	<p>5. To select a specified language, choose English, Spanish or French. Once the language is selected, the keypad will revert back to "Home" screen with the selected language applied.</p> <p>6. If selected language is okay, user can press "Home" or "Back" to continue.</p>

*TouchCenter Installation and Setup Guide*

---

## SECTION 5

**User Codes****In This Section**

- ◆ *Introduction to User Code Setup*
- ◆ *How to Access User Setup*
- ◆ *Authority Levels*

**Introduction to User Code Setup**

Each user must be assigned a name with a corresponding 4-digit user code in order to gain access to various features and functions. The TouchCenter can hold the identity for 10 Users in its memory. If additional Users are needed, define the additional Users using the Console Emulation Mode.

Users for the system are programmed in a central user setup location that provides the specific questions for authorization levels assigned to different users. You may want these users to be the same, but there are situations in which you may want a user to have limited capabilities. These capabilities are defined by the Authority Level assigned to each user.

**Authority Levels**

Authority levels define the system functions a particular user can perform. Depending on the authority assigned to you, there are certain system functions you may be prohibited from performing. The following information describes the authority levels available in the TouchCenter and provides the equivalent authority level name that you will find if you are reading your alarm system manuals. The authority levels available in the TouchCenter are as follows:

*TouchCenter Installation and Setup Guide*

Touch-Center Authority Level	Functions	Equivalent System Name	
		Residential Systems	Commercial Systems
Installer	Can perform all security functions except can only disarm if code was used to arm, can change Master Code, cannot change other user codes, can access the Central Station Screen options <b>Note:</b> This authority level cannot be assigned using the TouchCenter	Installer	Installer
Master	Can perform all security functions, add/delete users in assigned partition, program scheduled events, and change partition master code	Partition Master	Level 1 Master
Normal	Perform security functions (arm, disarm)	Standard User	Level 3 Operator A
Guest	Can arm the system in assigned partitions, but cannot disarm the system unless the system was armed with this code. <b>Note:</b> Do not assign this level if Quick Arm is enabled in the system.	Guest	Level 4 Operator B
No Access	Used to restrict access to a partition.	N/A	N/A



SECTION 5: User Codes

### How to Access User Setup

Access User Setup as follows:

1. From the "Home" screen, press the **SECURITY** button. The "Arming" screen is displayed.

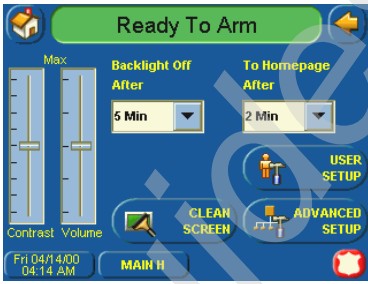
SCREEN	ACTION
	<ol style="list-style-type: none"> <li>2. Press the <b>MORE CHOICES</b> button on the "Arming" Screen. The "More Choices" screen is displayed.</li> <li>3. Press the <b>SETUP</b> button on the "More Choices" screen. The "Setup" screen is displayed.</li> </ol>
	<ol style="list-style-type: none"> <li>4. Press the <b>USER SETUP</b> button on the "Setup" screen. The User Setup screen is displayed.</li> </ol>

*TouchCenter Installation and Setup Guide*

**How to Add a User**

Add a User as follows:

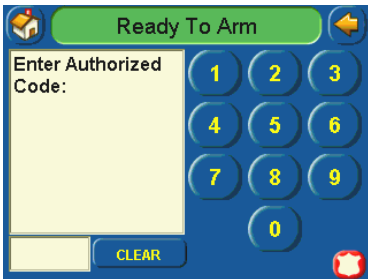
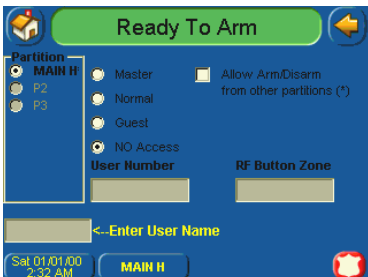
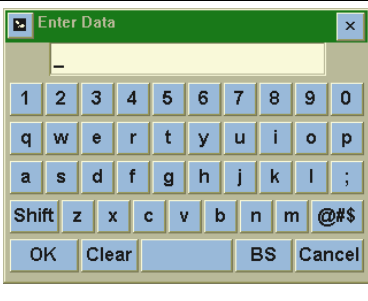
SCREEN	ACTION
	<p>1. To add a user, press the <b>ADD USER</b> button. The "User Authorization" screen is displayed with the instructions "<b>Enter Authorized Code</b>".</p>
	<p>2. Enter your Authorized code. The "User Options" screen is displayed. <b>Note:</b> The authorized code for adding users is dependent upon the alarm panel you are interfacing with. Check your alarm panel Installation and Setup Guide to determine who can add users.</p>
	<p>3. Press the box next to <b>Enter User Name</b>. The <b>Enter Data</b> keyboard screen is displayed.</p>
	<p>4. Type in the user name (6 characters max.) and press the <b>OK</b> button. The "User Options" screen is displayed with <b>Enter User Code...</b> displayed. <b>Notes:</b></p> <ul style="list-style-type: none"> <li>• Use the <b>Shift</b> button for capital letters.</li> <li>• Use the <b>BS</b> (Backspace) button to make corrections.</li> <li>• The <b>@#\$</b> button is not available for use at this time. These characters cannot be saved to the control panel.</li> </ul>

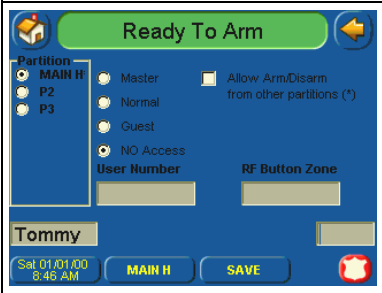
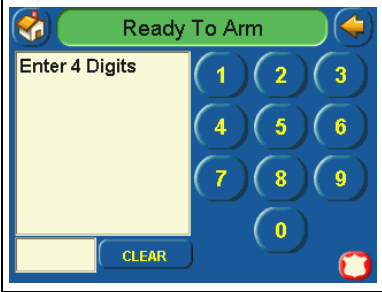
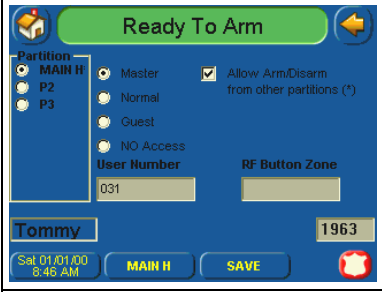
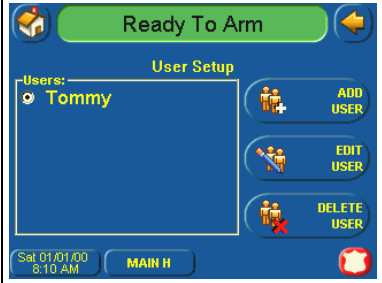

SECTION 5: User Codes

SCREEN	ACTION
	<p>5. Touch the box next to <b>Enter User Code...</b>. The "User Authorization" screen is displayed with the instructions "<b>Enter 4 Digits</b>".</p>
	<p>6. Enter the 4-digit code for this user. The "User Options" screen is displayed with the user's name and code displayed.</p>
	<p>7. Select the partitions, access level, and enter a user number for this user. If assigning this user to wireless key, enter one of the zone numbers of the keyfob (the wireless key must be programmed first before it can be assigned to a user).</p>
	<p>8. Press the <b>Save</b> button. The system will save the configuration. When the save is complete, the <b>User Setup</b> screen is displayed with the new user's name shown.</p>

*TouchCenter Installation and Setup Guide*

**How to Delete a User**

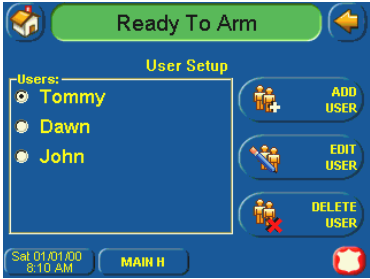
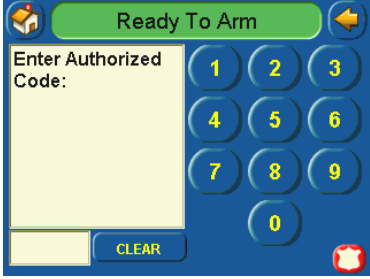
Delete a User as follows:



SCREEN	ACTION
	<p>Three selections are available: add a user, edit a user, or delete a user.</p> <p>1. To delete a user, touch the circle next to the user to be deleted and press the <b>DELETE USER</b> button. The "User Authorization" screen is displayed with the instructions "<b>Enter Authorized Code</b>".</p>
	<p>2. Enter your Authorized code. The <b>Confirm Delete</b> screen is displayed.</p> <p><b>Note:</b> The authorized code for deleting, adding, and editing users is dependent upon the alarm panel you are interfacing with. Check your alarm panel Installation and Setup Guide to determine who can delete, add, and edit users.</p>
	<p>3. Press the appropriate button. The <b>User Setup</b> screen is displayed.</p>

SECTION 5: User Codes

**How to Edit a User**

Edit a User as follows:

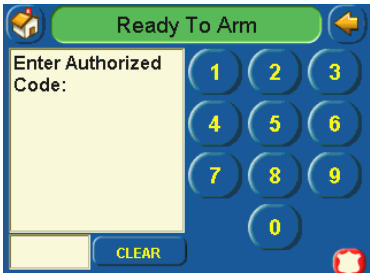
**Note:** You cannot edit a User's name. To modify a User name, you must delete the User and re-enter User.

SCREEN	ACTION
	<p>Three selections are available: add a user, edit a user, or delete a user.</p> <ol style="list-style-type: none"> <li>1. To edit a user, touch the circle next to the user to be edited and press the <b>EDIT USER</b> button. The "User Authorization" screen is displayed with the instructions "<b>Enter Authorized Code</b>".</li> </ol>
	<ol style="list-style-type: none"> <li>2. Enter your Authorized code. The "User Options" screen is displayed.                     <p><b>Note:</b> The authorized code for deleting, adding, and editing users is dependent upon the alarm panel you are interfacing with. Check your alarm panel Installation and Setup Guide to determine who can delete, add, and edit users.</p> </li> </ol>
	<ol style="list-style-type: none"> <li>3. Select the options needed for this user and press the <b>Save</b> button. The configuration changes are saved and you are returned to the <b>User Setup</b> screen.</li> </ol>

*TouchCenter Installation and Setup Guide*

---

all-guides.com

S E C T I O N 6

# Maintenance

**In This Section**

- ◆ *About TouchCenter Maintenance*     ◆ *Routine Care*
- ◆ *How to Clean the TouchCenter*

**About TouchCenter Maintenance**

With the exception of normal cleaning, the TouchCenter is maintenance free.

**How to Clean the TouchCenter**

**IMPORTANT:** Do not use an abrasive cleaning agent or abrasive cloth when cleaning the TouchCenter or damage to the touch screen may occur.



The **Emergency** screen cannot be accessed while running in the clean screen mode.

Clean the TouchCenter as follows:

1. From the "Home" screen, press the **SECURITY** button. The "Arming" screen is displayed.

SCREEN	ACTION
	<ol style="list-style-type: none"> <li>2. Press the <b>MORE CHOICES</b> button. The "More Choices" screen is displayed.</li> <li>3. Press the <b>SETUP</b> button on the "More Choices" screen. The "Setup" screen is displayed.</li> </ol>

*TouchCenter Installation and Setup Guide*

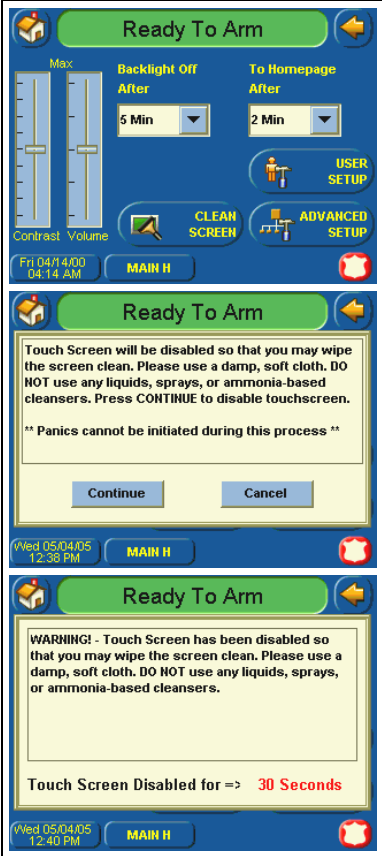
SCREEN	ACTION
 <p>The screenshots show the following steps:</p> <ol style="list-style-type: none"> <li>The 'Ready To Arm' screen with the 'CLEAN SCREEN' button highlighted.</li> <li>A dialog box with the text: "Touch Screen will be disabled so that you may wipe the screen clean. Please use a damp, soft cloth. DO NOT use any liquids, sprays, or ammonia-based cleansers. Press CONTINUE to disable touchscreen." and "Panic cannot be initiated during this process". Buttons for 'Continue' and 'Cancel' are at the bottom.</li> <li>A dialog box with the text: "WARNING! - Touch Screen has been disabled so that you may wipe the screen clean. Please use a damp, soft cloth. DO NOT use any liquids, sprays, or ammonia-based cleansers." and a timer: "Touch Screen Disabled for =&gt; 30 Seconds".</li> </ol>	<p>4. Press the <b>CLEAN SCREEN</b> button. A pop-up window displaying <b>“Touch Screen will be disabled so that you may wipe the screen clean. Please use a damp, soft cloth. DO NOT use any liquids, sprays, or ammonia-based cleansers. Press CONTINUE to disable touchscreen.”</b></p> <p>When the <b>Continue</b> button is pressed the <b>“Touch Screen Disabled for =&gt; 30 Seconds”</b>. During these 30 seconds the touch screen should be wiped clean of fingerprints using a mild soap solution and a soft cloth. When the counter reaches zero, the window automatically closes and the touch screen is active.</p> <p><b>Note:</b> Do not spray cleaning agent directly on the screen, spray it on cloth then wipe surface area.</p>

**Routine Care**

- Treat the components of the security system as you would any other electrical equipment. Do not slam sensor-protected doors or windows.
- Keep dust from accumulating on the keypad and all protective sensors, particularly on motion sensors and smoke detectors.
- The keypad case and sensors should be carefully dusted with a dry soft cloth. **Do not spray water or any other fluid on the units.**



## SECTION 7

## Troubleshooting

### In This Section









- ◆ *Troubleshooting*
- ◆ *Panel Fault Displays*
- ◆ *Diagnostics*
- ◆ *Performing Diagnostics*

### Troubleshooting

For troubleshooting procedures, refer to the Control Panel Installation Guide.

### Panel Fault Displays

The “Arming” screen displays an Icon(s) if a panel fault(s) occurs. The fault Icon is displayed to the left of the Panic button. The following Icons may be shown as applicable to your system:

ICON	MEANING
	AC Loss – The system is not receiving AC power.
	Bell Failure – The system bell or siren has a problem. <b>Note:</b> This Icon will be displayed when interfacing with residential panels only.
	Expander Failure – The system has a failure in an expansion module.
	Low Battery – The system battery, that powers the system during an AC power loss, is low.
	LRR Supervision Failure – The Long Range Radio used to communicate with the central station has a supervision failure. <b>Note:</b> This Icon will be displayed when interfacing with residential panels only.
	Pager Failure – The system cannot communicate with an assigned pager.
	Phone Line 1 Failure – The system is not able to communicate with the central monitoring station over the primary phone line.
	Phone Line 2 Failure – The system is not able to communicate with the central monitoring station over the secondary phone line.
	Wireless Failure – The system is not able to communicate with its wireless devices.

*TouchCenter Installation and Setup Guide*

**Diagnostics**



**About Diagnostics**

A series of diagnostic tests are provided that allows verification of correct operation of the TouchCenter and its connections to the security system. There are a total of three diagnostic tests.



**How to Access the Diagnostics**

To access diagnostics, do the following:

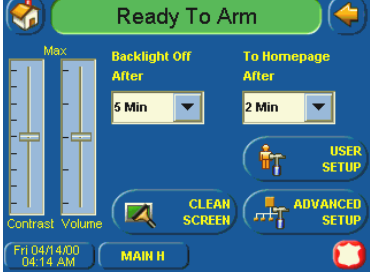
1. From the "Home" screen, press the SECURITY button. The "Arming" screen is displayed.

SCREEN	ACTION
	<ol style="list-style-type: none"> <li>2. From the "Arming" screen press the <b>MORE CHOICES</b> button. The "More Choices" screen is displayed.</li> </ol>
	<ol style="list-style-type: none"> <li>3. Press the <b>SETUP</b> button on the "More Choices" screen. The "Setup" screen is displayed.</li> </ol>
	<ol style="list-style-type: none"> <li>4. Press the <b>Advanced Setup</b> button on the "Setup" screen. The <b>Enter Authorized Code</b>: authorization screen is displayed.</li> </ol>

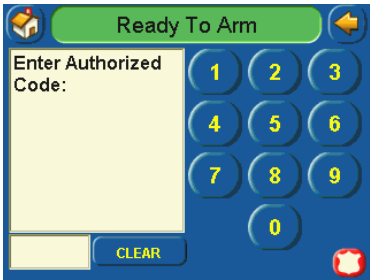
## SECTION 7: Troubleshooting

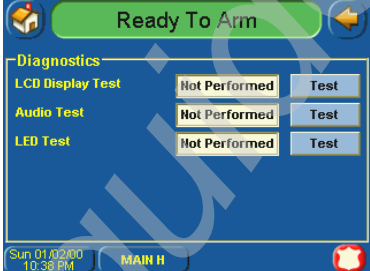
SCREEN	ACTION
	5. Enter your 4-digit Installer code. The "Advanced Setup" menu screen is displayed.
	6. Press the <b>Keypad Test</b> button on the "Advanced Setup" menu screen. The "Diagnostics" screen is displayed.
	

### Performing Diagnostics

Select any diagnostic test from the Diagnostics screen by pressing its associated **Test** button. All or any individual test may be run when you access the Diagnostics screen; however, each test must be performed one at a time.

At any time when a test is not being performed, you can press:

- the back button to return to the previous screen, or
- the home button to return to your home page.

*TouchCenter Installation and Setup Guide*



Once the Diagnostics screen is exited, subsequent entry to this screen displays all test options as "Not Performed."

**LCD Display Test**

Perform the LCD Display Test as follows:

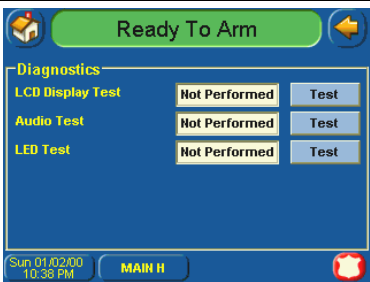
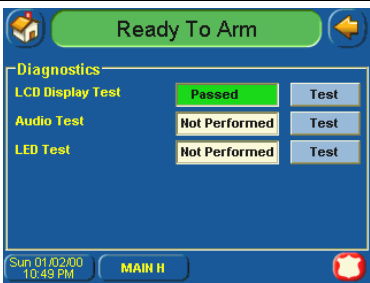

The **Emergency** screen cannot be accessed while running the LCD Display Test.

SCREEN	ACTION
	<p>When you press the Test button associated with the LCD Display Test, a series of different screens will be displayed. After each type of display, you will be asked if the display was proper. If the response to all questions is yes, the LCD Display Test message area of the Diagnostics screen will display "Passed".</p>
	

SECTION 7: Troubleshooting

**Audio Test**

Perform the Audio Test as follows:

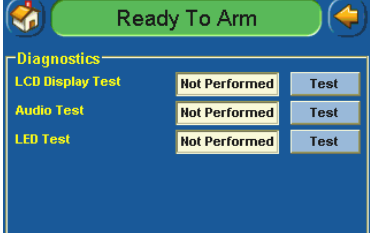
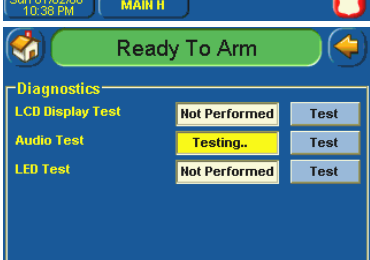
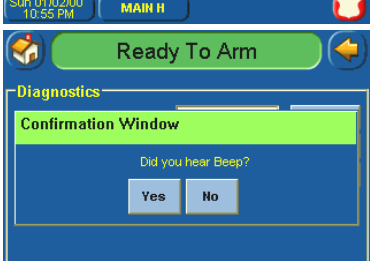
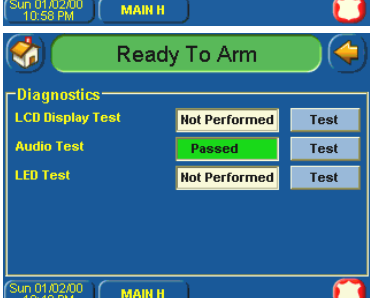
SCREEN	ACTION
	<p>When you press the <b>Test</b> button associated with the Audio Test, "Testing.." is displayed in the test status column on the "Diagnostics" screen while beeps sound from the speaker. At the conclusion of the test, a pop-up "Confirmation Window" is displayed in the center of the "Diagnostics" screen.</p>
	<p>Within the Confirmation Window the question "Did you hear Beep?" is displayed.</p> <p>When you press the <b>Yes</b> button, "Passed" is displayed in the test status column on the "Diagnostics" screen.</p>
	<p>When you press the <b>No</b> button, "Failed." is displayed in the test status column on the "Diagnostics" screen.</p>
	

*TouchCenter Installation and Setup Guide*

**LED Test**

Perform the LED Test as follows:

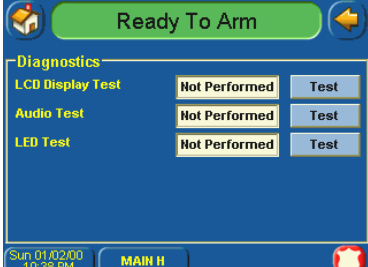
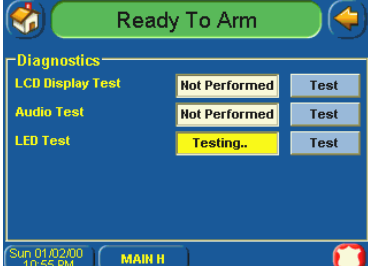
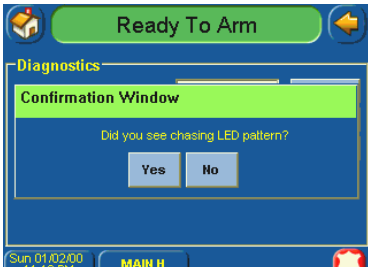
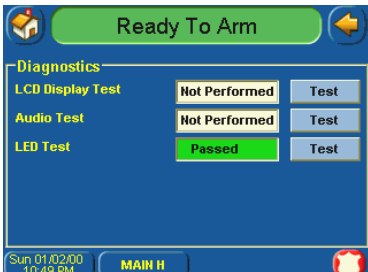
SCREEN	ACTION
	<p>1. When you press the <b>Test</b> button associated with the LED Test, "Testing.." is displayed in the test status column on the "Diagnostics" screen while the 3 LEDs light sequentially, top to bottom (red, green, yellow), 5 times. At the conclusion of the test, a pop-up "Confirmation Window" is displayed in the center of the "Diagnostics" screen.</p>
	
	<p>2. Within the Confirmation Window the question "Did you see chasing LED pattern?" is displayed.</p> <p>If you press the <b>Yes</b> button, "Passed" is displayed in the test status column on the "Diagnostics" screen.</p> <p>If you press the <b>No</b> button, "Failed" is displayed in the test status column on the "Diagnostics" screen.</p>
	

## SECTION 8

**Safe Mode****In This Section**

- ◆ *About the Safe Mode*
- ◆ *Operating in the Safe Mode*
- ◆ *Entering the Safe Mode*
- ◆ *Exiting the Safe Mode*

**About the Safe Mode**

The TouchCenter contains a Safe Mode of operation. In the rare event that the TouchCenter cannot successfully communicate in its graphic mode with the control panel, the Safe Mode is a backup mode that ensures that you can communicate with your system. In this mode, the TouchCenter operates much like a standard non-graphic keypad so that you can control your system until the problem is corrected.



- DO NOT perform panel programming while in the Safe Mode. Performing panel programming while in the Safe Mode may cause the panel and TouchCenter to become out of sync.
- DO NOT use several hardwired motion detectors in high traffic locations. The high quantity of signals received by the panel may cause the TouchCenter to enter the Safe Mode.

**Entering the Safe Mode**

The Safe Mode may be automatically entered by the TouchCenter program on a communication failure or may be entered manually on command. The following paragraphs describe these entry processes.

**Automatic Entry**

In the rare event that the TouchCenter cannot successfully communicate in its graphic mode with the control panel, the TouchCenter presents you with a message of “Problems detected. Start Keypad in Safe Mode?” and requests a “Yes” or “No” response. If you answer with “Yes”, the TouchCenter will go into the Safe Mode. If you answer with “No”, the TouchCenter will try communicating with the panel again. After 3 consecutive times of receiving no response, the TouchCenter will enter the Safe Mode.



*TouchCenter Installation and Setup Guide*

**Manual Entry**

**Note:** ONLY enter the Safe Mode from the Normal Mode. Entering the Safe Mode from the Demo Mode may result in incorrect display of the Emergency Function keys.



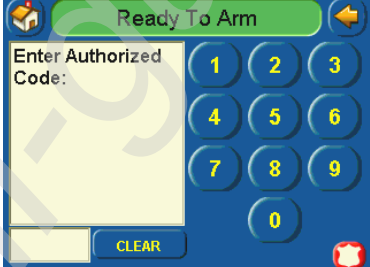

To manually put the TouchCenter into the Safe Mode of operation:

1. From the "Home" screen, press the **SECURITY** button. The "Arming" screen is displayed.

SCREEN	ACTION
	<ol style="list-style-type: none"> <li>2. Press the <b>MORE CHOICES</b> button. The "More Choices" screen is displayed.</li> <li>3. Press the <b>SETUP</b> button on the "More Choices" screen. The "Setup" screen is displayed.</li> </ol>
	<ol style="list-style-type: none"> <li>4. Press the <b>ADVANCED SETUP</b> button. The <b>Enter Authorized Code:</b> authorization screen is displayed.</li> </ol>
	<ol style="list-style-type: none"> <li>5. Enter your 4-digit Installer code. The "Advanced Setup" menu screen is displayed.</li> </ol>



SECTION 8: Safe Mode

SCREEN	ACTION
	<p>6. Press the <b>Central Station</b> button. The “Central Station” menu screen is displayed.</p>
	<p>7. Press the <b>Options</b> button. The “Options” menu screen is displayed.</p>
	<p>8. Select <b>Safe Mode</b> and then press the <b>Apply</b> button. The “Warning” message is displayed.</p>
	<p>9. Press the <b>OK</b> button. The TouchCenter will reset and restart in the Safe Mode.</p>

*TouchCenter Installation and Setup Guide***Operating in the Safe Mode**

While in the Safe Mode, the Home screen will display the Security button, Panic Button, and a message at the bottom of the screen as shown below:



**! SAFE MODE !**

This is a limited mode of operation. While in this mode:

- You can use the Security button to access the Console Emulation Mode of operation to try to clear your faults, disarm the system, or enter additional Alpha Keypad commands specified in your panel User and Installation Guides. You can perform almost all functions that you can perform from a standard non-graphic alpha keypad.
- You can depress the “Panic” button and generate Emergency Messages as defined in the panels home partition for this TouchCenter.
- The Armed and Ready LEDs on the front of the TouchCenter will indicate the TouchCenter’s home partition status. The Message (on models with Voice feature) or Trouble (on models without Voice feature) LED is not active in the Safe Mode.
- The Chime mode will function in the Safe Mode: however, you will not have Voice, Voice Chime, or Message capability if using the 6271V and 6271CV.

**Exiting the Safe Mode**

To Exit the Safe Mode:

1. Press the ! SAFE MODE ! bar. You will be presented with the following popup message:

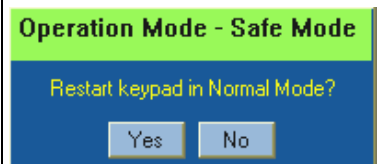
	<ol style="list-style-type: none"> <li>2. Press the <b>Yes</b> button to return to the Normal Mode of operation. The TouchCenter will reset and restart in the Normal Mode.</li> </ol>
---	--

## **Important Notes:**

### **Powering the TouchCenter**

When the TouchCenter is powered from an auxiliary power supply, always apply power to the control panel first and then the TouchCenter. Failure to observe this sequence will result in improper operation of the TouchCenter and may result in an ECP Error indication.

### **Important Troubleshooting Information**

When the TouchCenter cannot communicate with the alarm panel, the message “ECP Error” will be displayed at the top of the screen. If this message is displayed, check the following:

- Verify that the AUI type device is enabled in the control panel, and that the ECP address in the TouchCenter matches the address enabled in the control panel. Use a different address for each device. (See “Programming the Control Panel” in Section 4 of the TouchCenter Installation and Setup Guide.)
- If powering the TouchCenter from a power supply, make sure you have a "common" ground installed (wiring connection between Power Supply "gnd" and panel "Aux. power neg").

While an ECP Error message is being displayed, you must use the TouchCenter access code of “4140” any time the TouchCenter requests an authorized code. Once communication has been restored, then use the standard panel installer code for all installer functions.

### **Programming with the TouchCenter**

We recommend that you use either a standard alpha keypad or the TouchCenter in Console Emulation Mode when programming the control panel. When in the Console Mode, the TouchCenter emulates an alpha keypad and the programming of the panel is performed following the procedures provided in your panel’s Installation and Setup Guide.

### **General Notes**

- You may check to see whether the Chime Mode is ON or OFF by viewing the TouchCenter Operating Modes screen as described in “Setting Operating Modes” in Section 4 of the TouchCenter Installation and Setup Guide.
- The TouchCenter is defaulted to arm the system in the STAY INSTANT mode when arming the system using the NIGHT button. To change the TouchCenter so that it arms the system in a different mode when the NIGHT button is pressed, see “How to Set the

NIGHT Setup Button Function” in Section 4 of the TouchCenter Installation and Setup Guide.

- Note that some displays on the TouchCenter may not have enough space to display the whole name of a partition. When this occurs, the display will show as many characters as possible starting at the beginning of the partition name. We recommend that the partition name be kept to a maximum of 7 characters to ensure the “H” which indicates the home partition may be seen.
- “Exit Error” and “Auto Arm Alert, Please Leave Now” messages are not displayed by the TouchCenter.
- When the system has 6150Vs or 6160Vs, and 6271Vs attached, the Additional Console setting in the 6150Vs (displayed as A on the 6150V) must be set to 1 and the Additional Console setting in the 6160Vs must be set to Yes.

#### **Commercial System Notes**

- If the Aux Relay function is set for alarm silenced by User Code + # + 67, this command may only be entered in the console emulation mode.
- Do not use the common lobby logic function.
- If fields 2\*22 (Display Fire Alarms of other Partitions), 2\*23 (Display Burg & Panic of other Partitions), or 2\*24 (Display Troubles of other Partitions) are enabled, the zones that created the conditions cannot be viewed. You must go to that zone's home partition to view.
- If field 1\*11 (Zone Bypass After Disarm) is enabled, you must use the TouchCenter’s Console Emulation Mode and the commands “Code” + “64” (unbypass all) or “Code” + “6” + “Zone Number” (unbypass zone) to remove zone bypasses.
- The First to Alarm Display Lock feature (field 1\*10) is not supported by the TouchCenter.
- RF Low Battery messages are not supported by the TouchCenter except in the Show Zones screen where a Battery Icon will be displayed for the zone with the low battery.
- On multi-partition systems when the user has access to multiple partitions and arms the system, the TouchCenter will always ask the arm multiple partitions question regardless of the “Arm Multi-Partitions” setting.

#### **Residential System Notes**

- If the Clean Me option is set, when the maintenance signal is received you will get a “Fire Maintenance” message and the Display

Faults button will be shown. However, if you display the faults, zone 1 will not be shown as a faulted zone.

- If RF Jam Reports are selected and RF Jam is detected, the User Authorization screen will display “Trouble ZN100 RF Receiver”. If you enter the console emulation mode, the display will show “Check 90 RF Receiver Jam”.
- Do not use the Custom Word reminder feature.

#### **User Related Notes**

- Users added to the system using the TouchCenter graphic user screen must be deleted from the TouchCenter using the graphic screen as well. Deleting users from the panel by any other means (alpha keypad, console emulation mode, or Compass downloader) will not automatically delete them from the TouchCenter.
- If the panel has exit tones enabled and you arm the system in the Away mode, the TouchCenter will beep continuously throughout the exit period.

Use the console emulation mode for the following functions:

- Programming more than 10 system users.
- Programming the Pager report option for users of residential control panels (e.g., VISTA-15P and VISTA-20P).
- Special Function Key operations (such as macros or single-button paging).
- End-User Scheduling.
- To check for an “Alarm Cancelled” message if this feature has been enabled in the system.



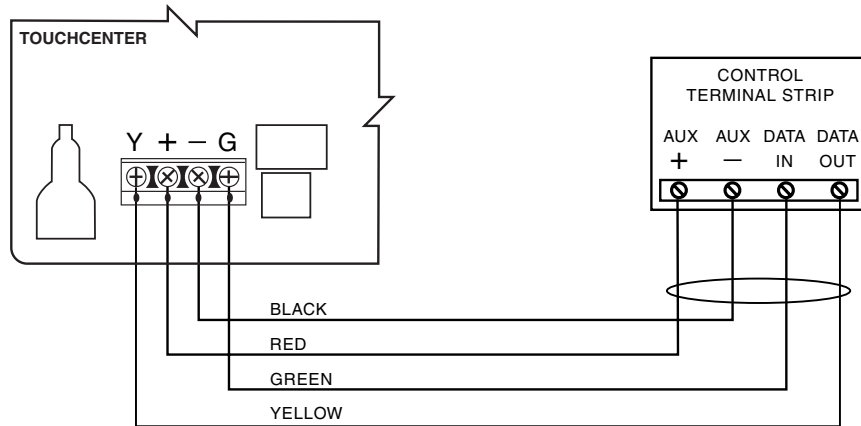

POWERING THE TOUCHCENTER KEYPAD FROM THE CONTROL

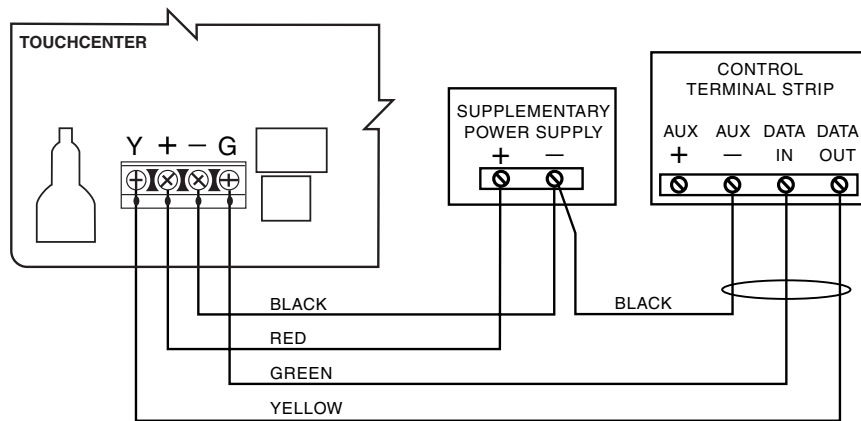

POWERING THE TOUCHCENTER FROM A SUPPLEMENTARY POWER SUPPLY

6271CV-008-V0

**UL** Use a Listed Class 2 power supply suited for the application.

## Summary of Connections

For the latest warranty information, please go to:  
<http://www.security.honeywell.com/hsc/resources/wa/>

## **Honeywell**

2 Corporate Center Drive, Suite 100  
P.O. Box 9040  
Melville, NY 11747

Copyright © 2009 Honeywell International Inc.  
[www.honeywell.com/security](http://www.honeywell.com/security)



K6248V3 3/09 Rev. A