



## **Touch Panels with TFT-Display**

User manual

# User manual

## Touch Panels with TFT-Display

2019-11-22

---

Designation: UM EN TP 3XXXX GEN3

Revision: 03

Order No.: —

This user manual is valid for:

Designation	Order No.
TP 3043W	2402629
TP 3057Q	2400452
TP 3057V	2400453
TP 3070W	2400454
TP 3090W	2402630
TP 3105S	2400455
TP 3121S	2400456
TP 3120W	2400457
TP 3150S	2400458
TP 3154W	2402631
TP 3105S SER	1164040

---

## How to contact us

### Internet

Up-to-date information on Phoenix Contact products and our Terms and Conditions can be found on the Internet at:

[phoenixcontact.com](http://phoenixcontact.com)

Make sure you always use the latest documentation.

It can be downloaded at:

[phoenixcontact.net/products](http://phoenixcontact.net/products)

### Subsidiaries

If there are any problems that cannot be solved using the documentation, please contact your Phoenix Contact subsidiary.

Subsidiary contact information is available at [phoenixcontact.com](http://phoenixcontact.com).

### Published by

PHOENIX CONTACT GmbH & Co. KG

Flachsmarktstraße 8

32825 Blomberg

GERMANY

Should you have any suggestions or recommendations for improvement of the contents and layout of our manuals, please send your comments to

[tecdoc@phoenixcontact.com](mailto:tecdoc@phoenixcontact.com)

**General terms and conditions of use for technical documentation**

Phoenix Contact reserves the right to alter, correct, and/or improve the technical documentation and the products described in the technical documentation at its own discretion and without giving prior notice, insofar as this is reasonable for the user. The same applies to any technical changes that serve the purpose of technical progress.

The receipt of technical documentation (in particular user documentation) does not constitute any further duty on the part of Phoenix Contact to furnish information on modifications to products and/or technical documentation. You are responsible to verify the suitability and intended use of the products in your specific application, in particular with regard to observing the applicable standards and regulations. All information made available in the technical data is supplied without any accompanying guarantee, whether expressly mentioned, implied or tacitly assumed.

In general, the provisions of the current standard Terms and Conditions of Phoenix Contact apply exclusively, in particular as concerns any warranty liability.

This manual, including all illustrations contained herein, is copyright protected. Any changes to the contents or the publication of extracts of this document is prohibited.

Phoenix Contact reserves the right to register its own intellectual property rights for the product identifications of Phoenix Contact products that are used here. Registration of such intellectual property rights by third parties is prohibited.

Other product identifications may be afforded legal protection, even where they may not be indicated as such.

---

# Table of Contents

1	Important Notes .....	7
1.1	Symbols .....	7
1.2	Safety Notes .....	7
1.3	Intended Use .....	8
1.4	Target Group .....	8
2	Installation and Commissioning .....	9
2.1	Unpacking the Device.....	9
2.2	Mounting the Device.....	10
2.2.1	Front Panel Dimensions .....	11
2.2.2	Mounting Cutout .....	21
2.2.3	Side View, Mounting Depth .....	31
2.3	Connecting the Device .....	41
2.3.1	Supply Voltage .....	41
2.3.2	Grounding .....	42
2.4	Switching On .....	43
2.5	Identification .....	43
3	Control and Display Elements .....	45
3.1	Touchscreen .....	45
3.2	Display.....	45
4	Interfaces of the Device .....	47
4.1	Standard Interfaces .....	47
4.1.1	Ethernet (X5) .....	48
4.1.2	USB (X9, X10) .....	49
4.1.3	Memory Card .....	50
4.2	Serial Interfaces.....	51
4.2.1	RS-422 / RS-485 (X14) .....	52
4.2.2	RS232 (X15) .....	55
4.3	Shielding D-SUB Connectors .....	56
5	Maintenance and Servicing .....	57
5.1	Maintenance Interval .....	57
5.2	Front Panel.....	57
5.3	Fuse .....	57
5.4	Battery.....	57

6	Technical Data .....	59
6.1	General.....	59
6.2	TP 3043W .....	61
6.3	TP 3057Q .....	62
6.4	TP 3057V.....	63
6.5	TP 3070W .....	64
6.6	TP 3090W .....	65
6.7	TP 3105S.....	66
6.8	TP 3121S.....	67
6.9	TP 3120W .....	68
6.10	TP 3150S.....	69
6.11	TP 3154W .....	70

# 1 Important Notes

## 1.1 Symbols

The symbols in this manual are used to draw your attention on notes and dangers.



This symbol indicates hazards that could lead to personal injury.

There are three signal words indicating the severity of a potential injury.

### **DANGER**

Indicates a hazard with a high risk level. If this hazardous situation is not avoided, it will result in death or serious injury.

### **WARNING**

Indicates a hazard with a medium risk level. If this hazardous situation is not avoided, it could result in death or serious injury.

### **CAUTION**

Indicates a hazard with a low risk level. If this hazardous situation is not avoided, it could result in minor or moderate injury.



This symbol together with the **NOTE** signal word alerts the reader to a situation which may cause damage or malfunction to the device, hardware/software, or surrounding property.



Here you will find additional information or detailed sources of information.

## 1.2 Safety Notes

- Read this manual carefully before using the operating device. Keep this manual in a place where it is always accessible to all users.
- Proper transportation, handling and storage, placement and installation of this product are prerequisites for its subsequent flawless and safe operation.
- This user manual contains the most important information for the safe operation of the device.
- The user manual, in particular the safety notes, must be observed by all personnel working with the device.
- Observe the accident prevention rules and regulations that apply to the operating site.
- Installation and operation must only be carried out by qualified and trained personnel.

### 1.3 Intended Use

- The device is designed for use in the industry.
- The device is state-of-the art and has been built to the latest standard safety requirements. However, dangerous situations or damage to the machine itself or other property can arise from the use of this device.
- The device fulfills the requirements of the EMC directives and harmonized European standards. Any modifications to the system can influence the EMC behavior.



**NOTICE: Radio Interference**

Operation of this device may cause radio interference in residential areas.

### 1.4 Target Group

The use of products described in this manual is oriented exclusively to:

- Qualified electricians or persons instructed by them. The users must be familiar with the relevant safety concepts of automation technology as well as applicable standards and other regulations.
- Qualified application programmers and software engineers. The users must be familiar with the relevant safety concepts of automation technology as well as applicable standards and other regulations.



## 2 Installation and Commissioning

### 2.1 Unpacking the Device

Unpack all parts carefully and check the contents for any visible damage in transit. Also check whether the shipment matches the specifications on your delivery note.

If you notice damages in transit or discrepancies, please contact us immediately.

## 2.2 Mounting the Device

**NOTICE: Damage**

When installing the device, leave a gap of at least 30 mm (1.181") around the device to ensure sufficient air circulation.

**NOTICE: Damage**

When the operating device is installed horizontally, please note that additional sources of heat beneath the operating device may result in heat accumulation.

Make sure to allow sufficient heat dissipation!

Please observe the permissible temperature range specified in the technical data when operating the device.

**NOTICE: Damage**

In order to ensure the degree of protection specified in the technical data, observe the following points:

- A tolerance of  $\pm 0.5$  mm is maintained for the mounting cutout.
- The seal lies flat against the mounting surface.
- The number of mounting brackets, given in the technical data, is used.
- The material of the mounting surface is sufficiently stable to ensure permanently secure attachment of the operating device.
- The mounting surface and the operating device may not become deformed due to the effects of the mounting clamps or through the operation of the device.
- The threaded pins of the mounting brackets are tightened uniformly to a maximum torque of 1 Nm.

The device can be easily and quickly mounted from the rear of the device. A panel thickness of 1 mm to 6 mm (0.039" to 0.236") is permitted for proper mounting.

1. Cut the mounting cutout in the housing for the device size to be installed.
2. Push the device through the mounting cutout from the front.

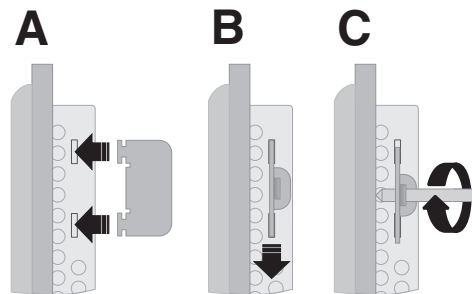

Figure 2-1 Mounting the device using a mounting bracket

3. Fix the mounting brackets in the recesses provided (A).
4. Pull the mounting brackets down until the snap into place (B).
5. Secure the device using the threaded pins (C).

## 2.2.1 Front Panel Dimensions

### 2.2.1.1 TP 3043W

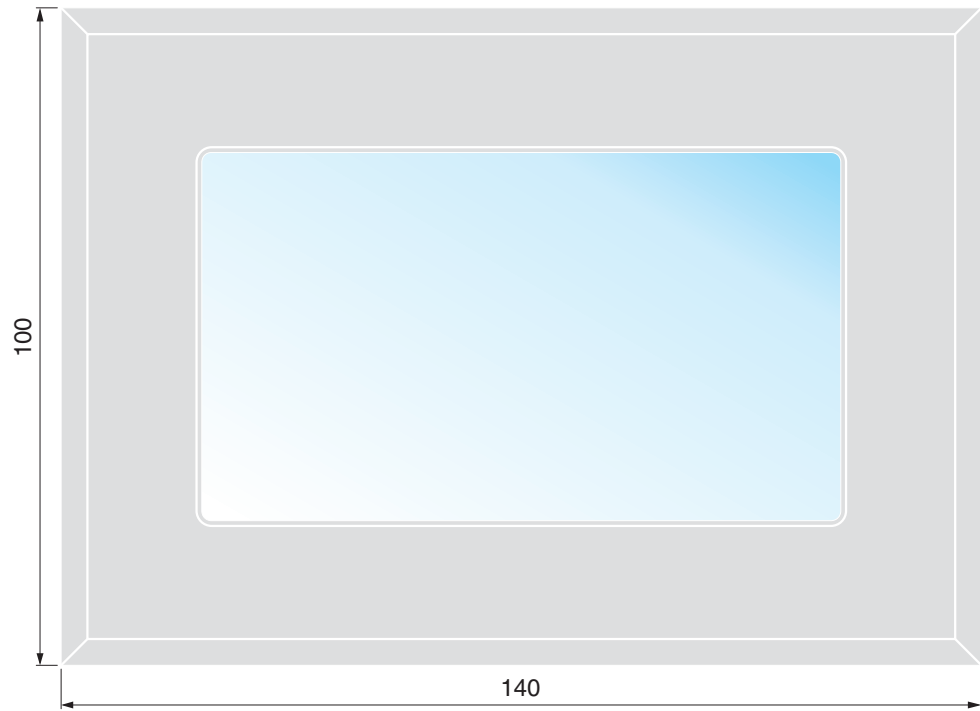

Figure 2-2 Front panel (dimensions in mm)

2.2.1.2 TP 3057Q

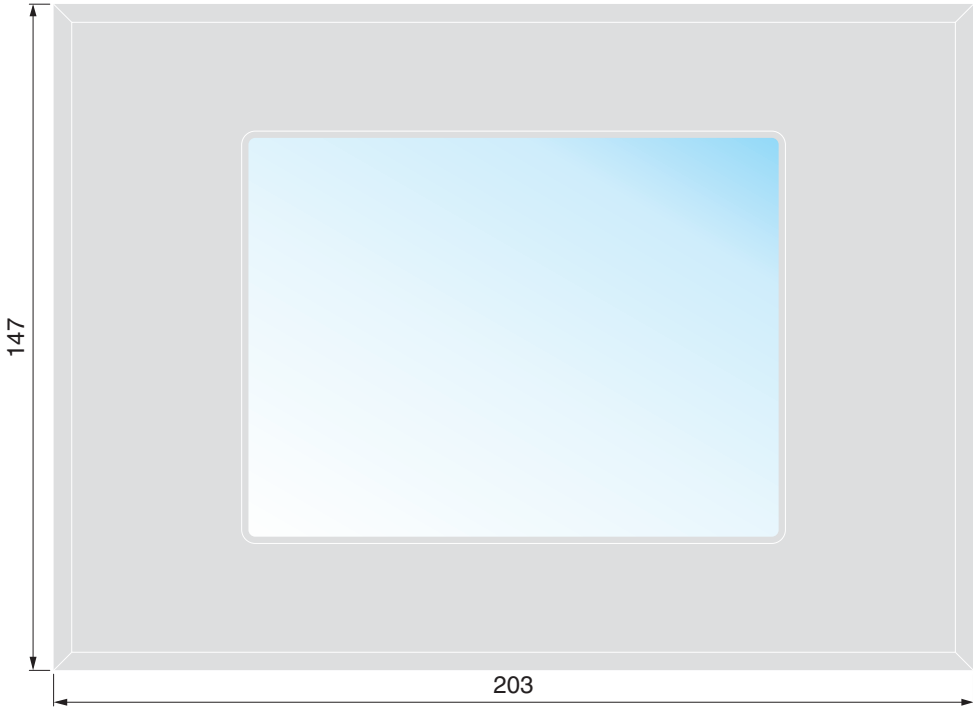

Figure 2-3 Front panel (dimensions in mm)

2.2.1.3 TP 3057V

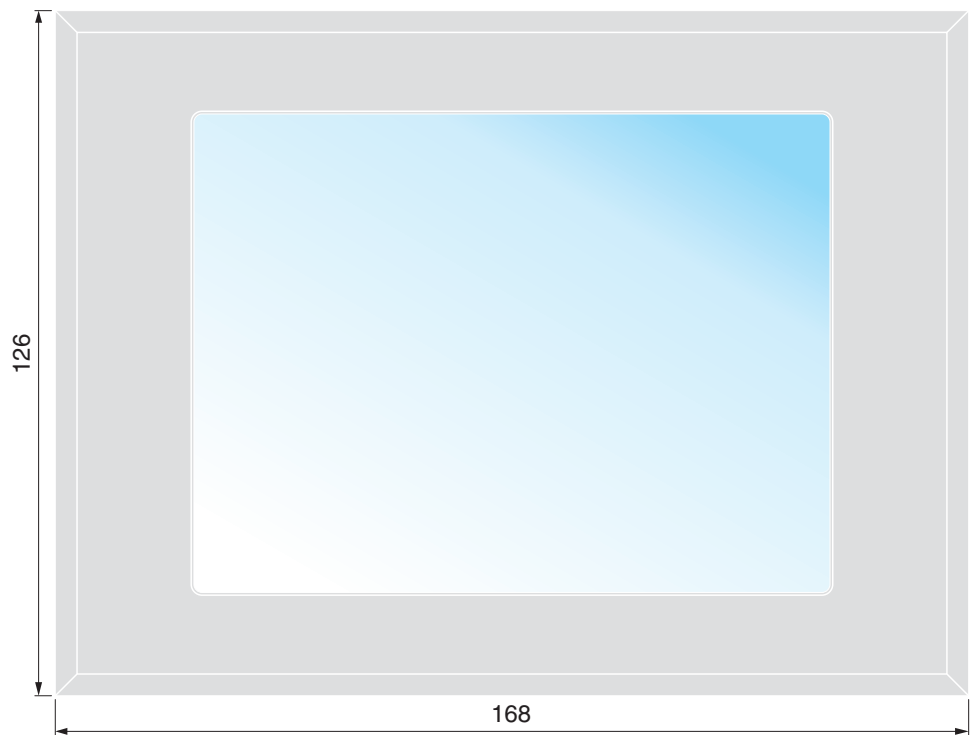

Figure 2-4 Front panel (dimensions in mm)

2.2.1.4 TP 3070W

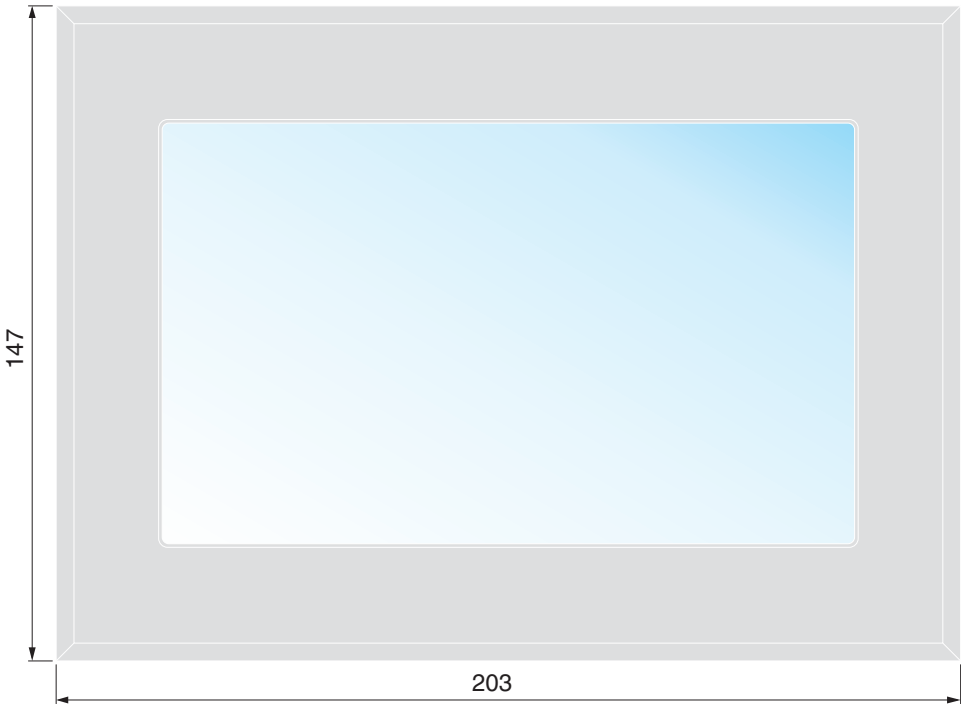

Figure 2-5 Front panel (dimensions in mm)

2.2.1.5 TP 3090W

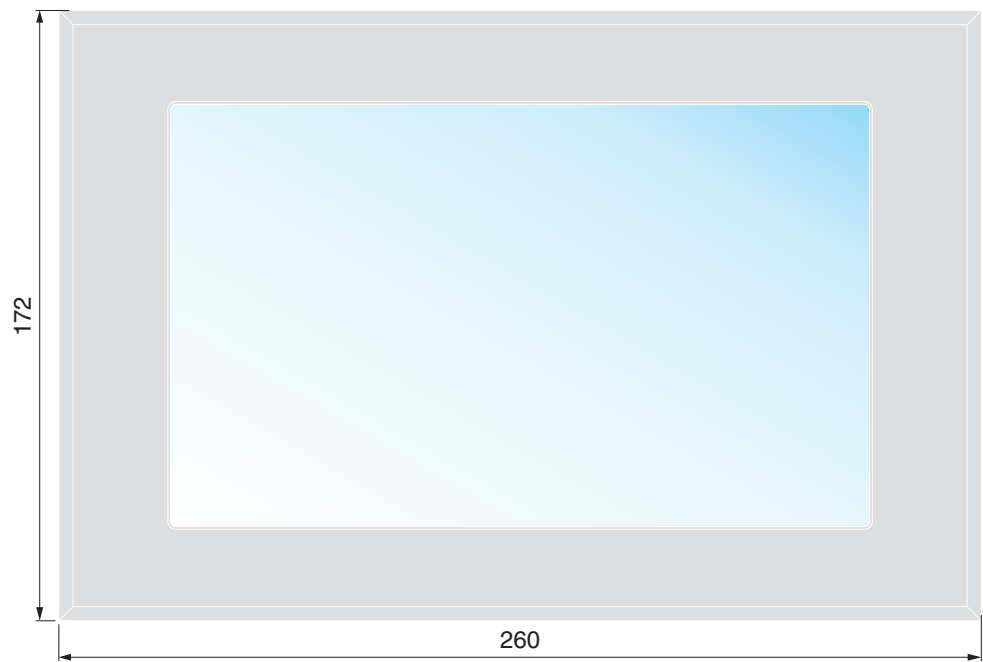

Figure 2-6 Front panel (dimensions in mm)

2.2.1.6 TP 3105S

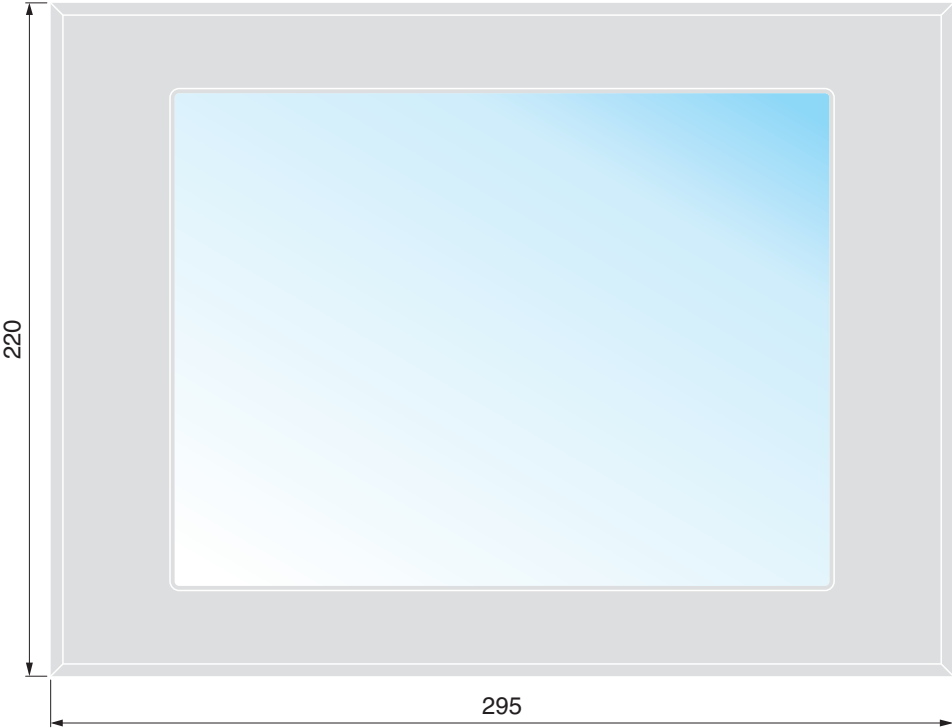

Figure 2-7 Front panel (dimensions in mm)



2.2.1.7 TP 3121S



Figure 2-8 Front panel (dimensions in mm)

2.2.1.8 TP 3120W

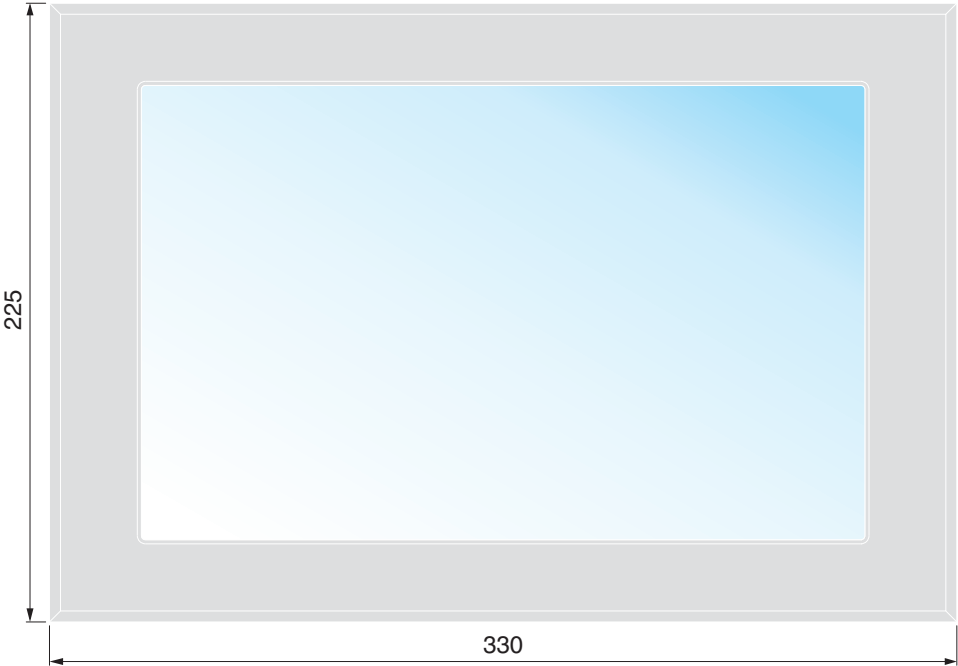

Figure 2-9 Front panel (dimensions in mm)

2.2.1.9 TP 3150S

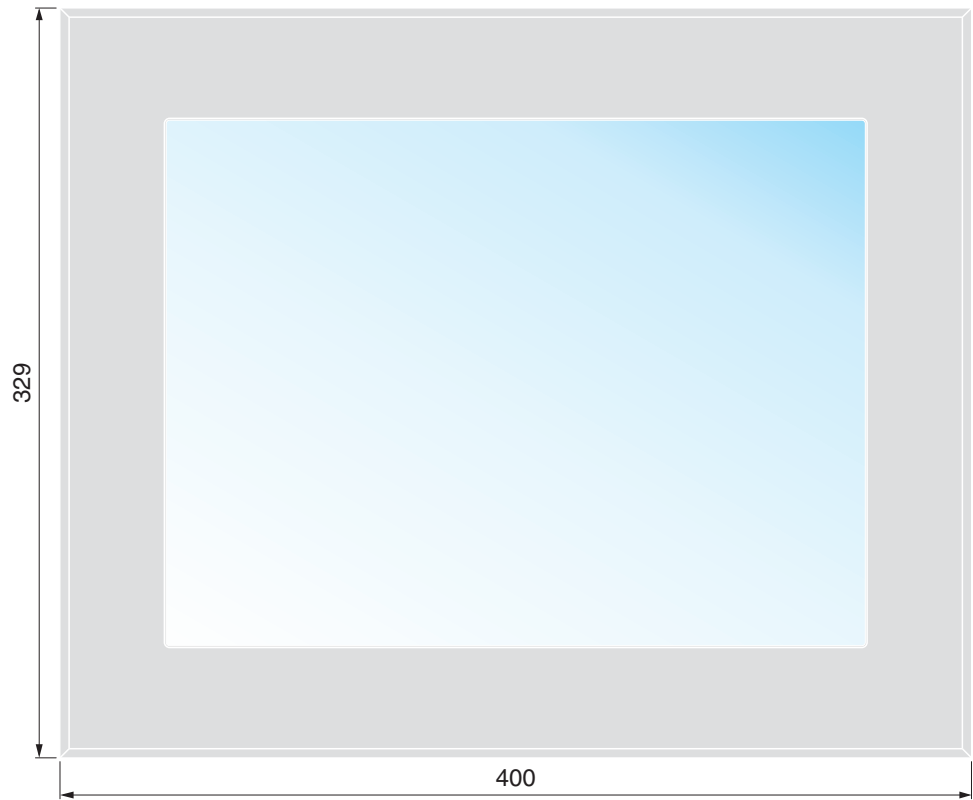

Figure 2-10 Front panel (dimensions in mm)

2.2.1.10 TP 3154W

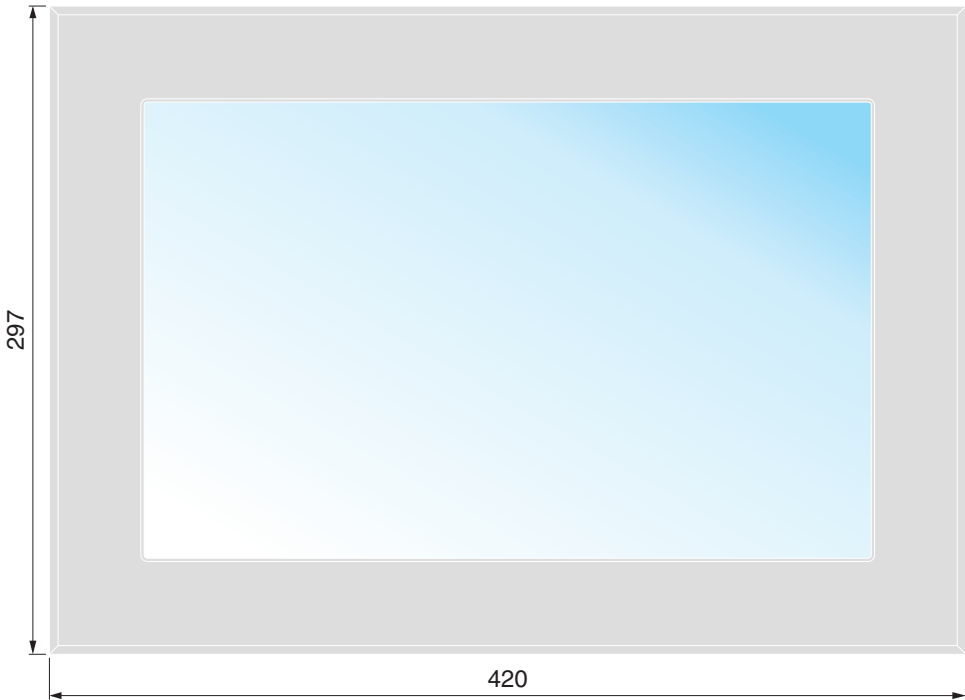

Figure 2-11 Front panel (dimensions in mm)

## 2.2.2 Mounting Cutout

### 2.2.2.1 TP 3043W

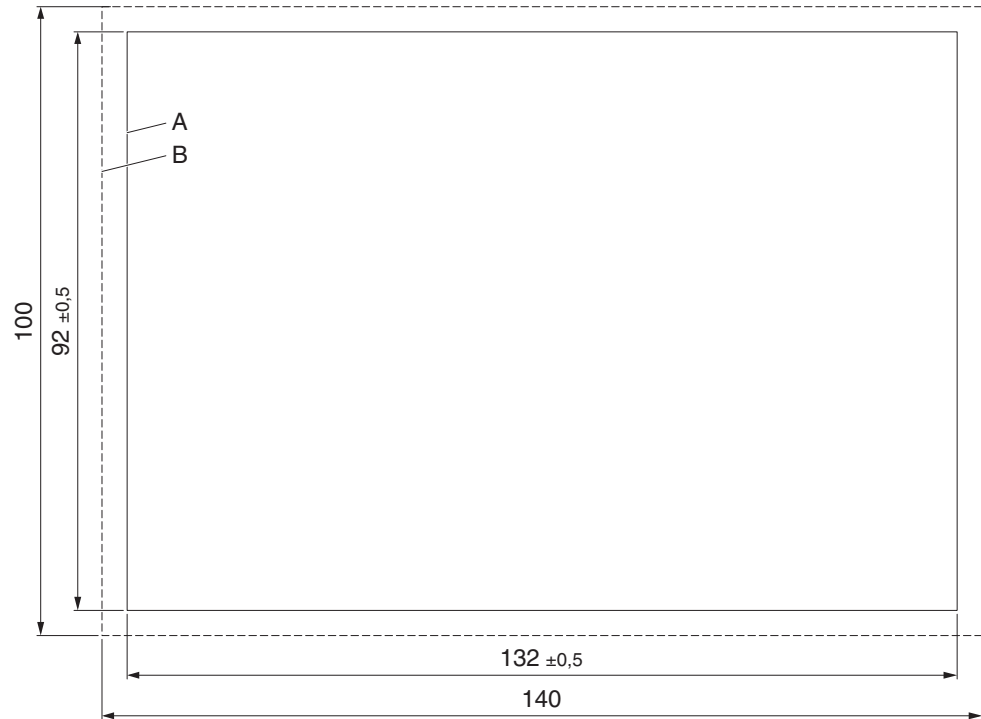

Figure 2-12 Mounting cutout (dimensions in mm)

**A** Mounting Cutout

**B** Front Panel

2.2.2.2 TP 3057Q

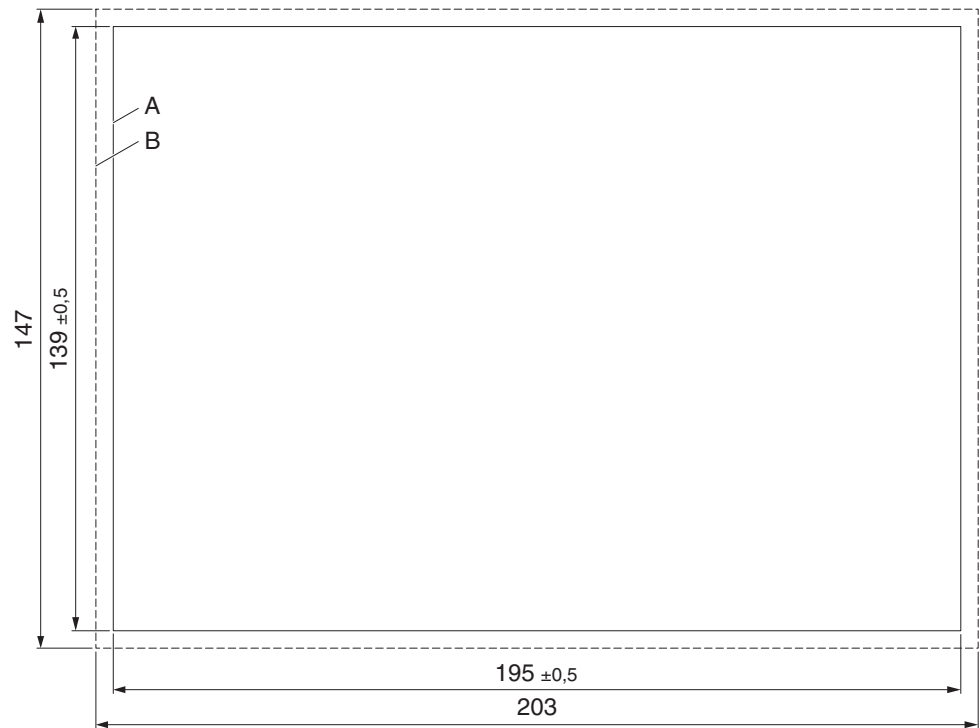

Figure 2-13 Mounting cutout (dimensions in mm)

- A Mounting Cutout
- B Front Panel

2.2.2.3 TP 3057V

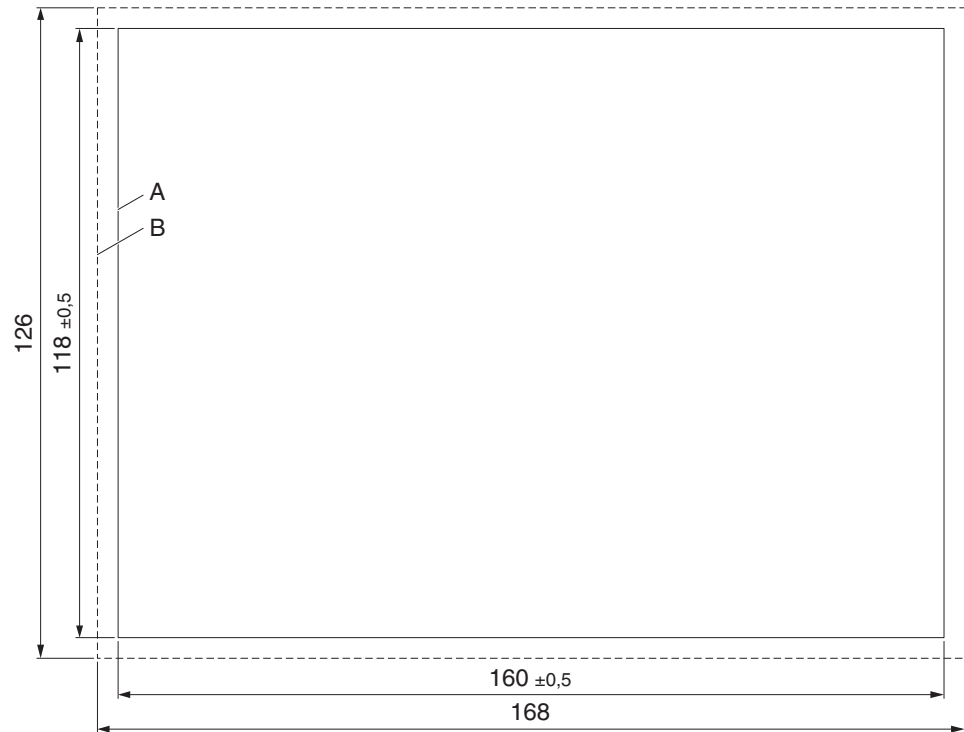

Figure 2-14 Mounting cutout (dimensions in mm)

- A** Mounting Cutout
- B** Front Panel

2.2.2.4 TP 3070W

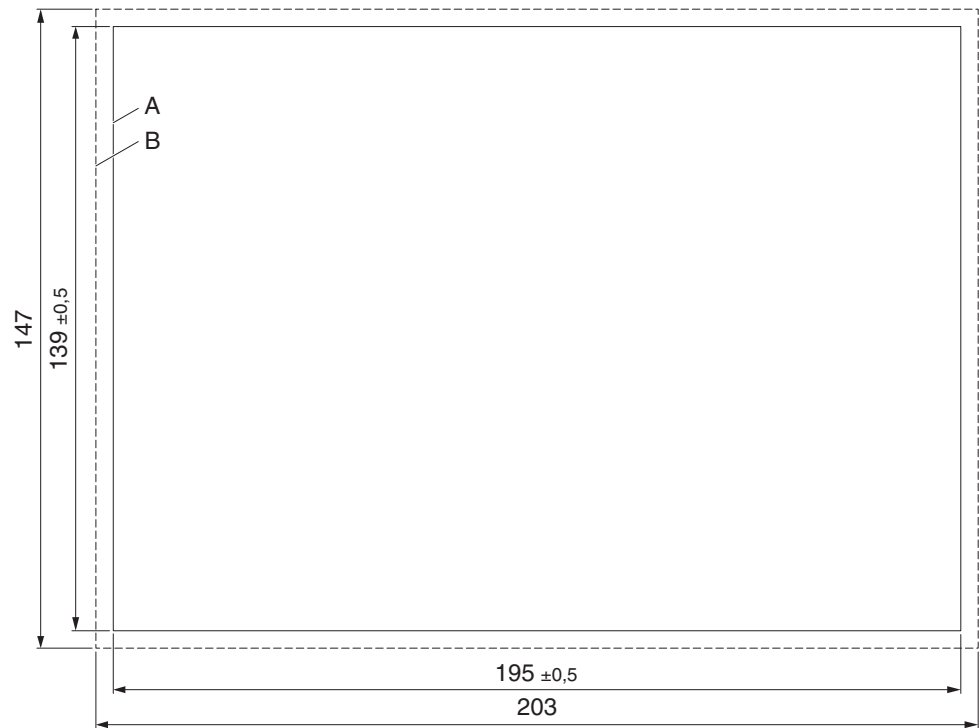

Figure 2-15 Mounting cutout (dimensions in mm)

- A** Mounting Cutout
- B** Front Panel



2.2.2.5 TP 3090W

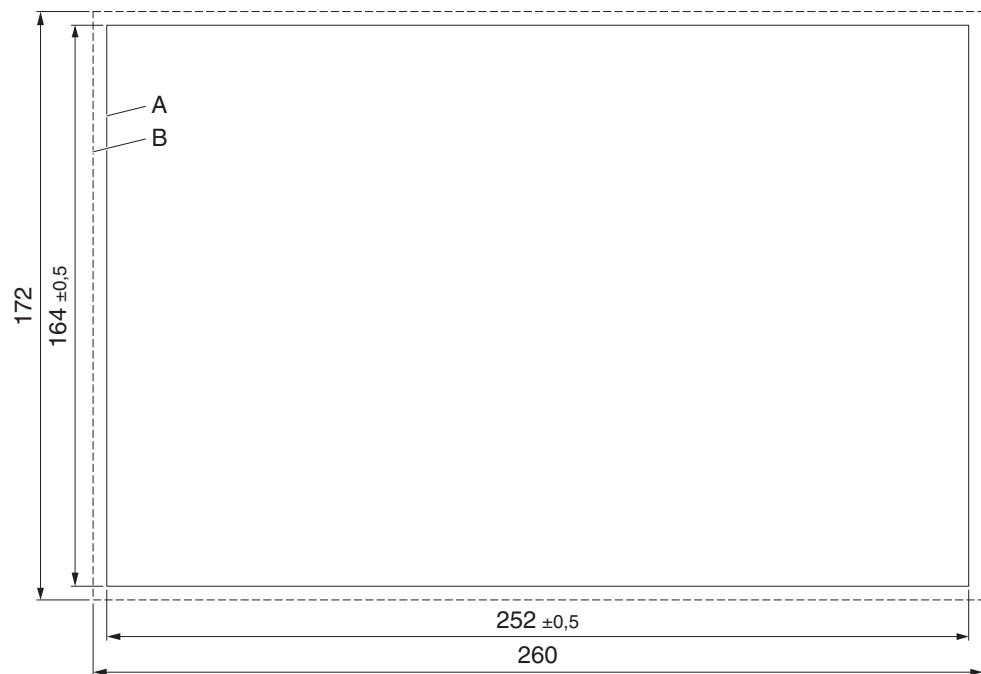

Figure 2-16 Mounting cutout (dimensions in mm)

- A** Mounting Cutout
- B** Front Panel

2.2.2.6 TP 3105S

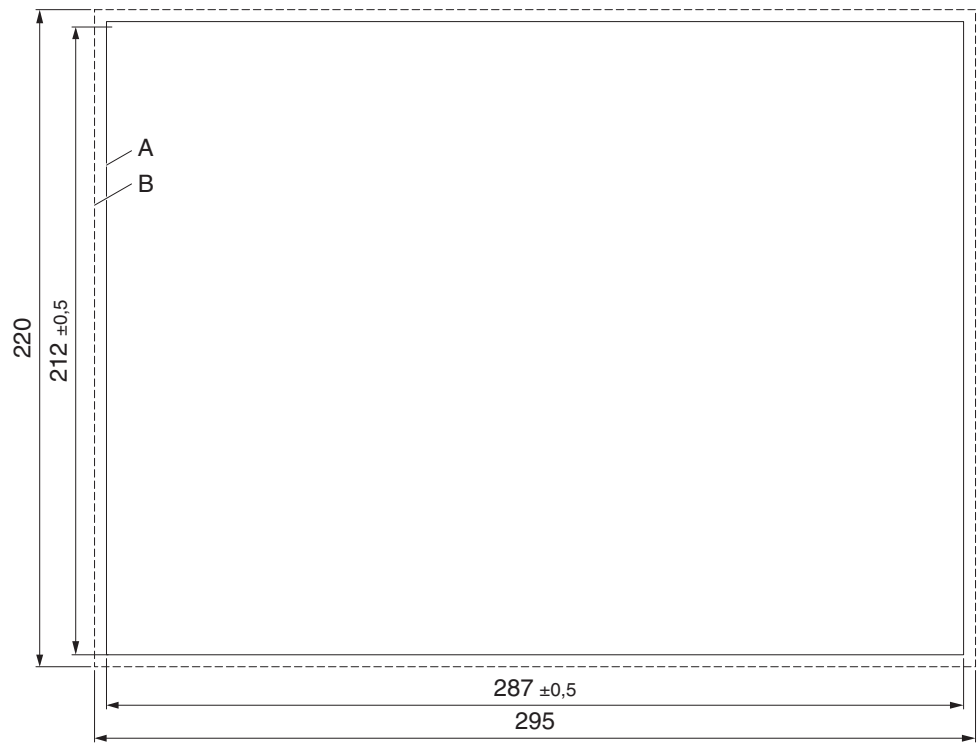

Figure 2-17 Mounting cutout (dimensions in mm)

- A** Mounting Cutout
- B** Front Panel

2.2.2.7 TP 3121S

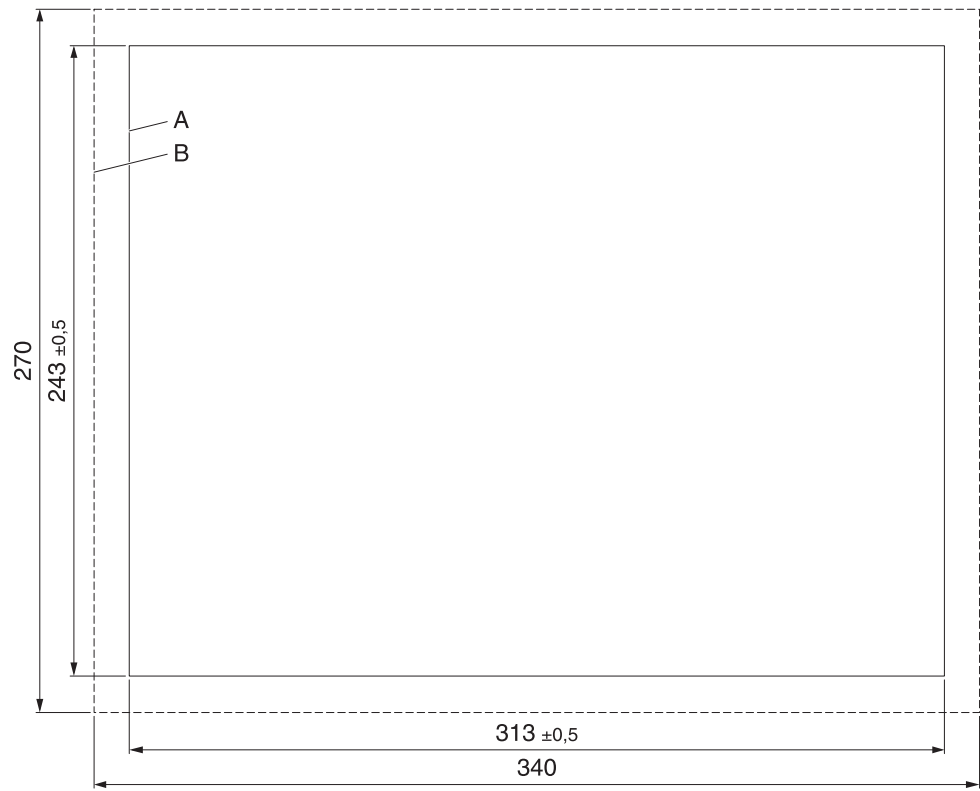

Figure 2-18 Mounting cutout (dimensions in mm)

- A** Mounting Cutout
- B** Front Panel

2.2.2.8 TP 3120W

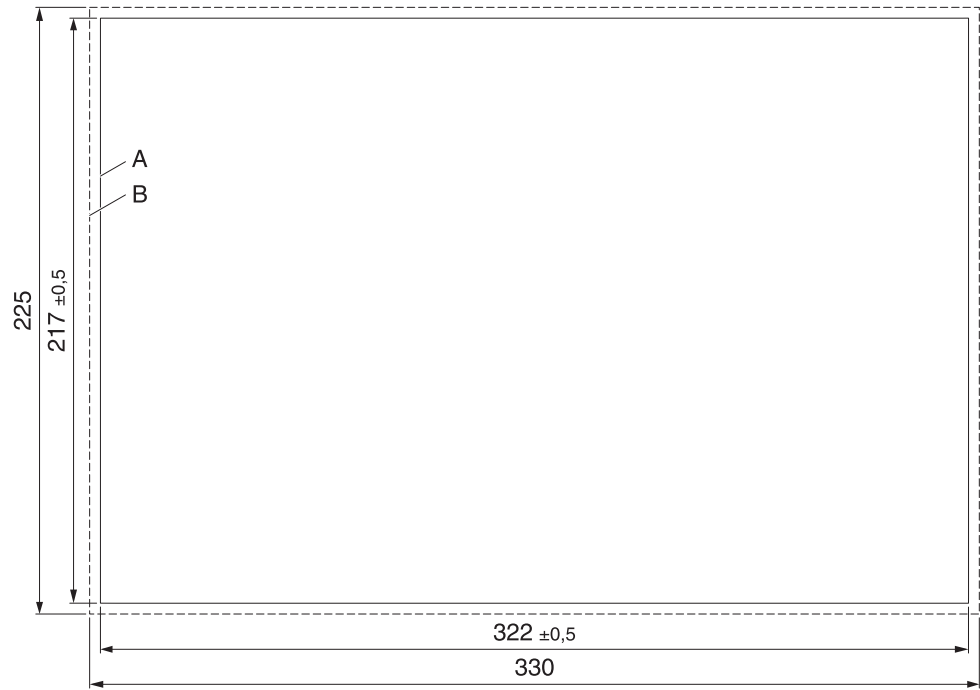

Figure 2-19 Mounting cutout (dimensions in mm)

- A** Mounting Cutout
- B** Front Panel

2.2.2.9 TP 3150S

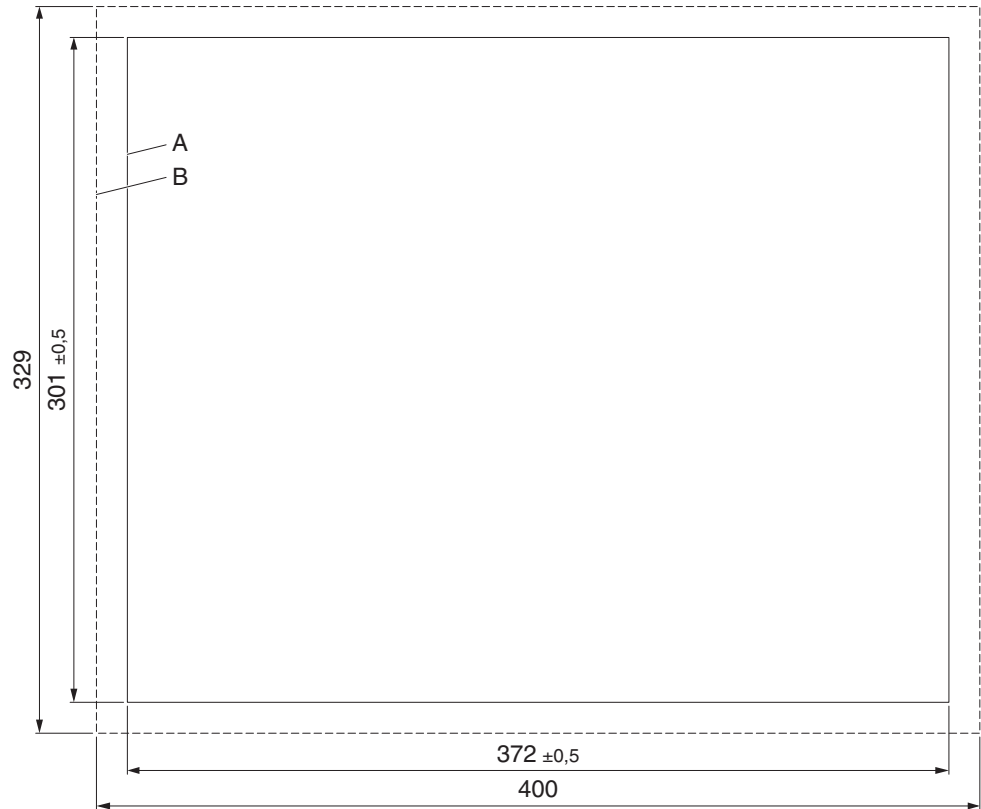

Figure 2-20 Mounting cutout (dimensions in mm)

- A** Mounting Cutout
- B** Front Panel

2.2.2.10 TP 3154W

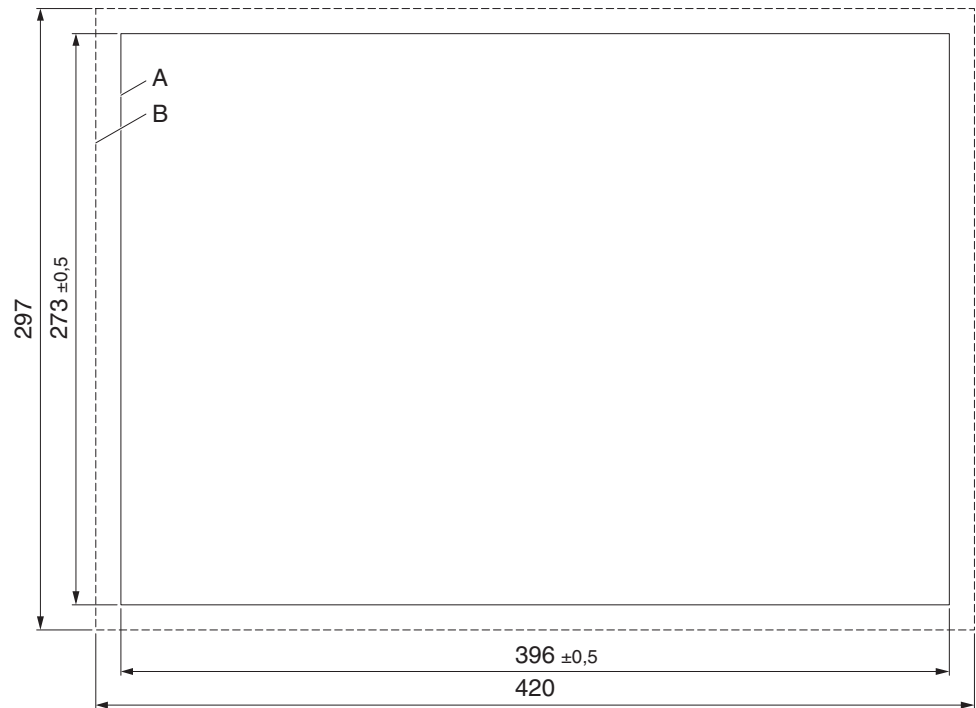

Figure 2-21 Mounting cutout (dimensions in mm)

- A** Mounting Cutout
- B** Front Panel

### 2.2.3 Side View, Mounting Depth

#### 2.2.3.1 TP 3043W

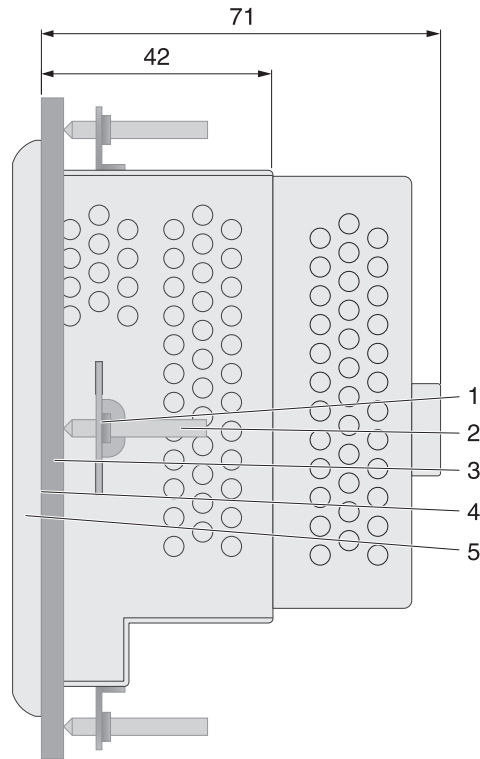

Figure 2-22 Side view, mounting depth (dimensions in mm)

- 1 Mounting Bracket
- 2 Threaded Pin
- 3 Mounting Surface Thickness 1 mm to 6 mm
- 4 Circumferential Seal
- 5 Front Panel

2.2.3.2 TP 3057Q

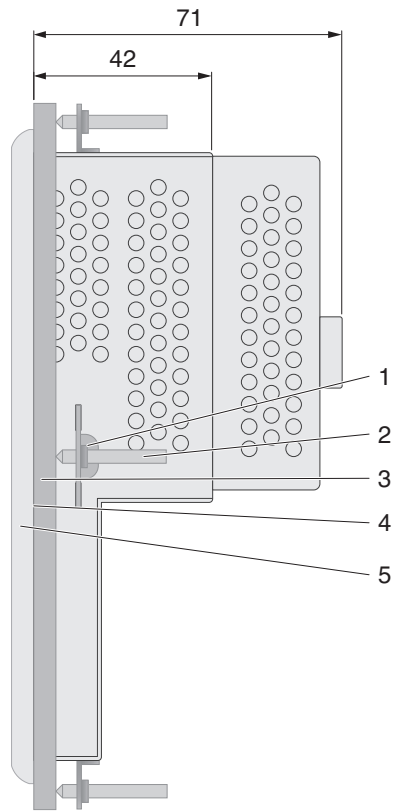

Figure 2-23 Side view, mounting depth (dimensions in mm)

- 1 Mounting Bracket
- 2 Threaded Pin
- 3 Mounting Surface Thickness 1 mm to 6 mm
- 4 Circumferential Seal
- 5 Front Panel



2.2.3.3 TP 3057V

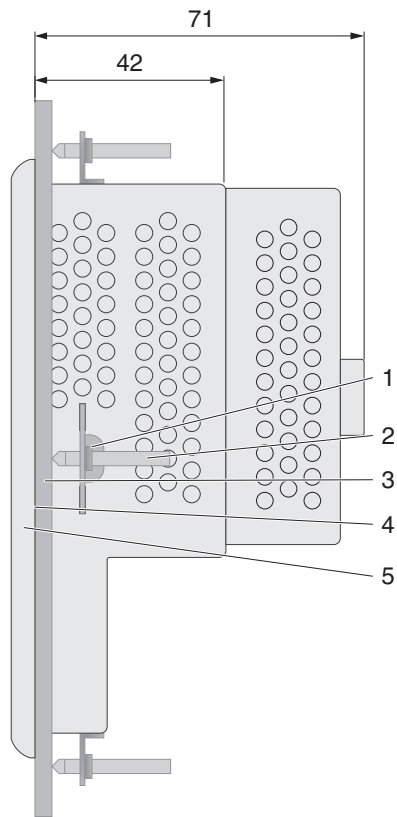

Figure 2-24 Side view, mounting depth (dimensions in mm)

- 1 Mounting Bracket
- 2 Threaded Pin
- 3 Mounting Surface Thickness 1 mm to 6 mm
- 4 Circumferential Seal
- 5 Front Panel

2.2.3.4 TP 3070W

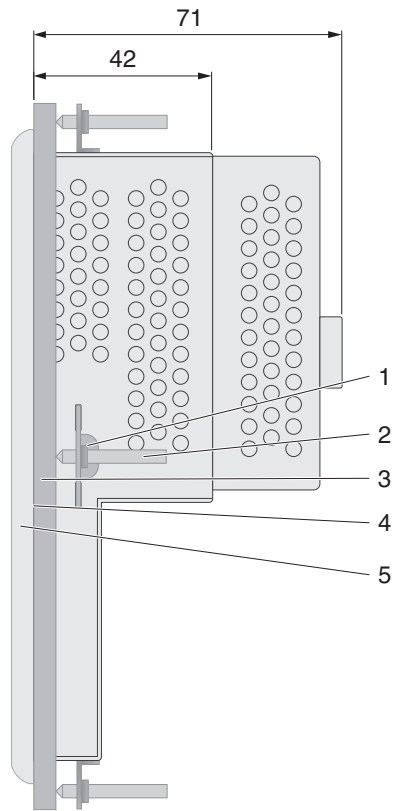

Figure 2-25 Side view, mounting depth (dimensions in mm)

- 1 Mounting Bracket
- 2 Threaded Pin
- 3 Mounting Surface Thickness 1 mm to 6 mm
- 4 Circumferential Seal
- 5 Front Panel

2.2.3.5 TP 3090W

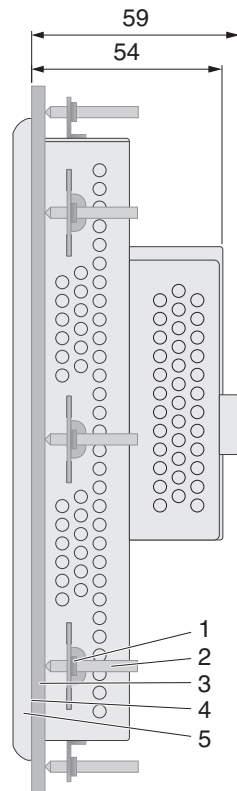

Figure 2-26 Side view, mounting depth (dimensions in mm)

- 1 Mounting Bracket
- 2 Threaded Pin
- 3 Mounting Surface Thickness 1 mm to 6 mm
- 4 Circumferential Seal
- 5 Front Panel

2.2.3.6 TP 3105S

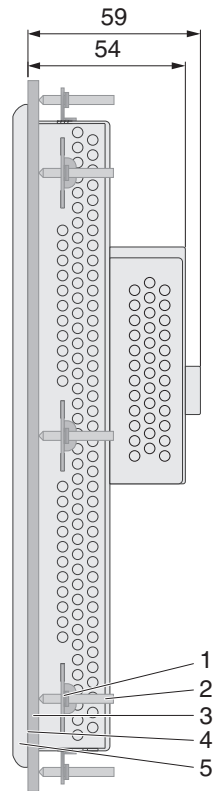

Figure 2-27 Side view, mounting depth (dimensions in mm)

- 1 Mounting Bracket
- 2 Threaded Pin
- 3 Mounting Surface Thickness 1 mm to 6 mm
- 4 Circumferential Seal
- 5 Front Panel

2.2.3.7 TP 3121S

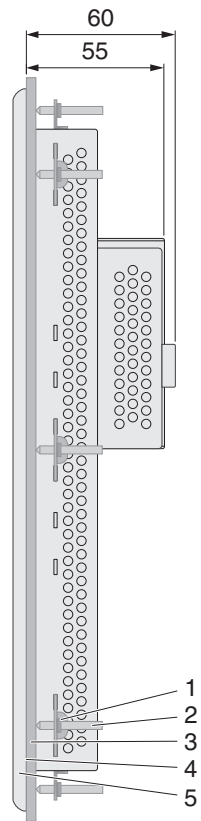

Figure 2-28 Side view, mounting depth (dimensions in mm)

- 1 Mounting Bracket
- 2 Threaded Pin
- 3 Mounting Surface Thickness 1 mm to 6 mm
- 4 Circumferential Seal
- 5 Front Panel

2.2.3.8 TP 3120W

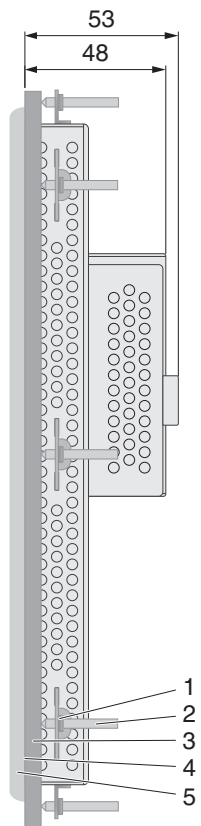

Figure 2-29 Side view, mounting depth (dimensions in mm)

- 1 Mounting Bracket
- 2 Threaded Pin
- 3 Mounting Surface Thickness 1 mm to 6 mm
- 4 Circumferential Seal
- 5 Front Panel

2.2.3.9 TP 3150S

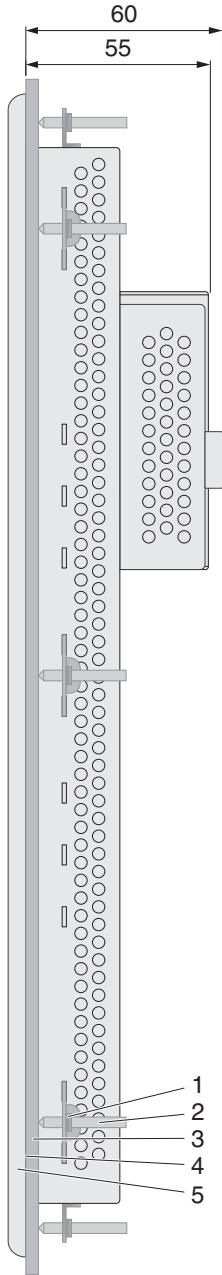

Figure 2-30 Side view, mounting depth (dimensions in mm)

- 1 Mounting Bracket
- 2 Threaded Pin
- 3 Mounting Surface Thickness 1 mm to 6 mm
- 4 Circumferential Seal
- 5 Front Panel

2.2.3.10 TP 3154W

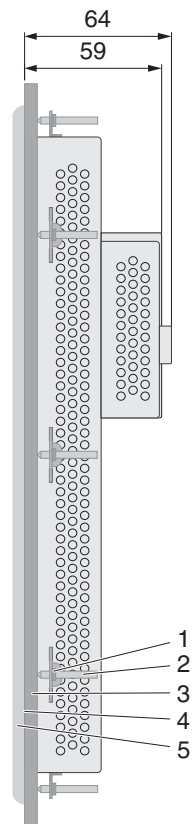

Figure 2-31 Side view, mounting depth (dimensions in mm)

- 1 Mounting Bracket
- 2 Threaded Pin
- 3 Mounting Surface Thickness 1 mm to 6 mm
- 4 Circumferential Seal
- 5 Front Panel



## 2.3 Connecting the Device

### 2.3.1 Supply Voltage

The supply voltage is supplied via pin strip X1. A suitable socket strip is supplied.

Refer to the technical data for the permissible supply voltage of the operating device.



**NOTICE: Damage**

The operating device has to be supplied by a power source, which meets the requirements for SELV / Limited energy circuit in accordance with EN 61010-1 / IEC 61010-1 or Class 2 in accordance with UL 1310 or Limited Power Source (LPS) in accordance with EN 60950-1 / IEC 60950-1.



The device has reverse polarity protection. In case of wrong polarity, the device will not operate.

Connector in the operating device: 3 pin pin strip

Table 2-1 Pin assignment supply voltage

Pin	Designation	Function
1		Noiseless ground / functional earth ground (FE)
2	0 V	Supply voltage 0 V (GND)
3		Supply voltage  24 V



**DANGER: Hazardous voltages**

Hazardous voltages can exist inside electrical installations that can pose a danger to humans. Coming in contact with live parts may result in electric shock!



**NOTICE: Damage**

Cables with finely stranded copper conductors with a minimum cross-section of 0.75 mm<sup>2</sup> (18 AWG) and a maximum cross-section of 2.5 mm<sup>2</sup> (14 AWG) must be used for the supply voltage.

You must adhere to the following torques at the connector:

Screw connection of terminal blocks: 0.22 Nm (minimal) to 0.25 Nm (maximum)

Screw flange: 0.3 Nm (maximum)

Use the following procedure to connect the device to the supply voltage:

1. Strip approx. 30 mm (1.181") off the outer cable sheath and approx. 5 mm (0.197") off the wires.

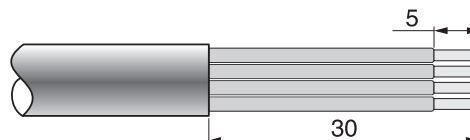

Figure 2-32 Preparing the cable

2. Fit the wires with wire end ferrules and connect the wires to the socket strip.
3. Plug the socket strip onto pin strip X1.
4. Secure the socket strip in place with a screw-type locking to prevent it from slipping out.

### 2.3.2 Grounding

The grounding is performed - depending on the type of device - with a slip-on sleeve (noiseless ground / functional earth ground) or a ring cable lug (protective ground).

**NOTICE: Damage**

A separate copper conductor must always be provided for the grounding. The conductor must have a minimum cross-section of 1.5 mm<sup>2</sup> (16 AWG) and must be kept as short as possible.

You must adhere to a maximum torque of 1 Nm at an protective grounding on the threaded bolt.

1. Strip approx. 5 mm (0.197") off the wires.
2. Fit the stripped wires - depending on the type of device - with a slip-on sleeve or a ring cable lug.
3. Plug the slip-on sleeve on the flat tab or mount the ring cable lug with the nut to the threaded bolt.

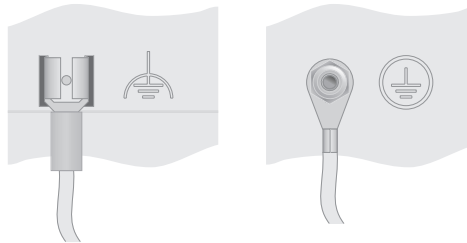

Figure 2-33 Noiseless ground / protective ground

## 2.4 Switching On

When switching on the operating system loads. The interface for SD/SDHC cards is available for applications and other data.



Please also pay attention to the further information in the user manual of your software option at [phoenixcontact.net/products](http://phoenixcontact.net/products).

## 2.5 Identification

The operating device can be identified using the nameplate on the rear of the device.

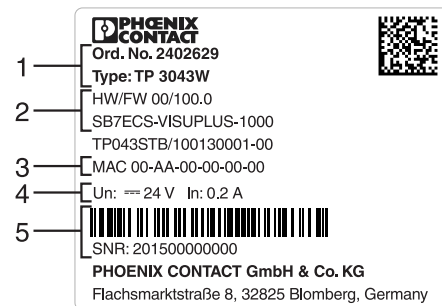

Figure 2-34 Nameplate (example)

- 1 Device type, article number
- 2 Software version (at time of delivery)
- 3 MAC address
- 4 Voltage and power specification
- 5 Serial number



## 3 Control and Display Elements

### 3.1 Touchscreen

The device is equipped with a resistive 4 wire touch screen. You operate the device using this touch screen.

**NOTICE: Damage**

Pointed or sharp objects, such as pens or fingernails, can lead to irreparable damages of the touch screen. Exclusively therefore use the fingertips or the aids indicated in the technical data for the operation.

### 3.2 Display

**DANGER: Toxic**

If the display is damaged, avoid touching, swallowing or breathing in the liquids or gases which may leak out!

**DANGER: Corrosive**

If the display is damaged, avoid touching, swallowing or breathing in the liquids or gases which may leak out!



Pixel failures, which can occur with TFT displays, are due to production and no complaint reason!

The operating device is equipped with different displays (see technical data) depending on variant.



## 4 Interfaces of the Device

### 4.1 Standard Interfaces

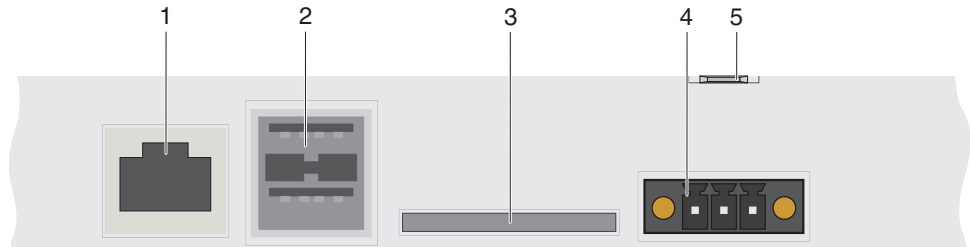

Figure 4-1 Standard interfaces

- 1 Female Connector X5 (Ethernet)
- 2 Female Connector X9, X10 (USB Host - Type A)
- 3 Slot for SD / SDHC Memory Card
- 4 Connector X1 (Supply Voltage)
- 5 Flat Push-on Connection for Noiseless Grounding - position varies dependent on the device type

### 4.1.1 Ethernet (X5)

A 10/100Base-T Ethernet interface is located at the operating device.

#### 4.1.1.1 Pin Assignment

Connector in the operating device: RJ45 female connector.

Table 4-1 Assignment of the Ethernet interface

Pin	Designation	Function
1	Tx+	Transmitted Data, Positive Polarity
2	Tx-	Transmitted Data, Negative Polarity
3	Rx+	Received Data, Positive Polarity
4	n.c.	Not Connected
5	n.c.	Not Connected
6	Rx-	Received Data, Negative Polarity
7	n.c.	Not Connected
8	n.c.	Not Connected

#### 4.1.1.2 Cable



**NOTICE**

Use a twisted pair cable of category 5 (CAT 5). The maximum cable length is 100 m (328.084 feet).



See the IEEE 802.3 standard for further information.



### 4.1.1.3 Diagnostics

Ethernet diagnostics LEDs are located at the operating device.

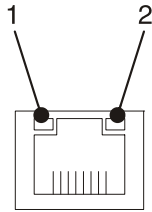

Figure 4-2 Position of the ethernet diagnostics LEDs

Table 4-2 Ethernet diagnostics LEDs

LED	Color	State	Designation	Function
1	Green	On	ACT/LNK	Connected
		Flashing		Sending / receiving ethernet data telegram
2	Yellow	On	SPD 10/100	Operation in 100 MBit/s mode
		Off		Operation in 10 MBit/s mode or disconnected

### 4.1.2 USB (X9, X10)

Two host interfaces are available on the operating device.



**NOTICE:**

Using hardware not suitable for industrial use (for example keyboard, mouse, memory card) in industrial environments may decrease safety of operation. This includes hardware intended for home and office use.

#### 4.1.2.1 Cable



For the specification of a suitable cable, please refer to the „Universal Serial Bus Specification“.



**NOTICE:**

Use industrial-suited USB cables with a length of maximally 2.5 m (8.202 feet).

### 4.1.3 Memory Card

At the underside of the operating device you can plug in an SD card.

**NOTICE:**

Using hardware not suitable for industrial use (for example keyboard, mouse, memory card) in industrial environments may decrease safety of operation. This includes hardware intended for home and office use.

#### 4.1.3.1 Inserting the memory card

When you insert the memory card, make sure the front side (side with contacts is below) of the memory card is visible. Insert the memory card until it snaps into place.

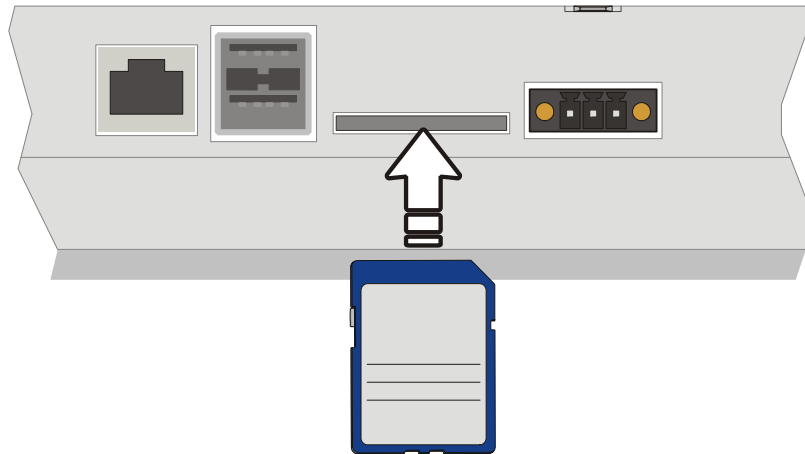

Figure 4-3 Inserting the memory card

#### 4.1.3.2 Ejecting the memory card

To remove, push the memory card into the operating device until it clicks. The memory card bounces when released automatically out of the operating device. Now you can remove the memory card.

## 4.2 Serial Interfaces

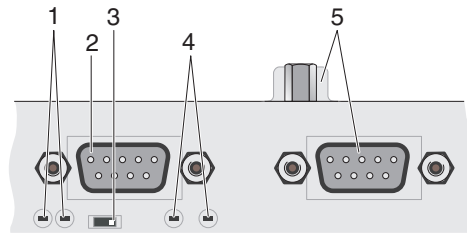

Figure 4-4 Rear view RS-422 / RS-485 / RS-232

- 1 Diagnostics LEDs (RS-422/RS-485)
- 2 Male Connector X14 (RS-422/RS-485)
- 3 Termination Switch (RS-422/RS-485)
- 4 Diagnostics LEDs (RS-232)
- 5 Male Connector X15 (RS-232) - position varies dependent on the device type

### 4.2.1 RS-422 / RS-485 (X14)

The interface standard RS-422 / RS-485 is suitable for point-to-point and multi-point connections.

The wires belonging together are marked with „A“ and „B“. Some descriptions refer to the pins with „-“ and „+“, where A = - and B = +.

Signal Logic 1  $U_A - U_B \leq -0.3 \text{ V i.e. } (U_A < U_B)$

Signal Logic 0  $U_A - U_B \geq +0.3 \text{ V i.e. } (U_A > U_B)$

The interface is assigned to the port COM4. At an image version before 181 and operating system Windows CE 6.0 the port COM1 is assigned.

#### 4.2.1.1 Pin Assignment

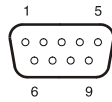

Figure 4-5 9 pin D-SUB male connector strip

Connector in the operating device: 9 pin D-SUB male connector strip.

Table 4-3 Pin assignment RS-422 / RS-485

Pin	Designation	Function		
1	SGND	Signal Ground		
2	T(B)	Transmitted Data	+	P
3	T(A)	Transmitted Data	-	N
4	R(A)	Received Data	-	N
5	R(B)	Received Data	+	P
6	nc	Not Connected		
7	nc	Not Connected		
8	nc	Not Connected		
9	nc	Not Connected		



**NOTICE:**

The D-SUB connector strips must be shielded sufficiently. See chapter “Shielding D-SUB Connectors“ on page 56

**4.2.1.2 Termination**

Always turn on the termination in a 4-wire point-to-point connection (RS-422 / RS-485). A sender termination for the quiescent level of the receiver must exist on the remote station. Turn on the termination only at the two ends of the lines in a 2- or 4-wire multi-point connection (RS-422 / RS-485).

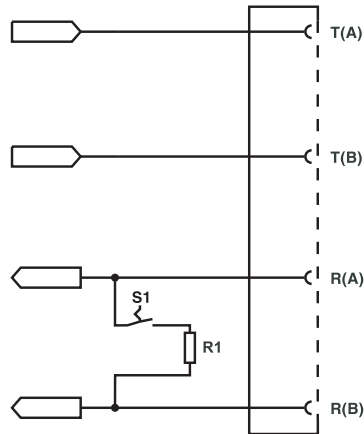

Figure 4-6 Termination possibilities RS-422 / RS-485 (intern)

Table 4-4 Resistance values termination RS-422 / RS-485

Designation	Value
R1	120 Ohm



The switch positions for ON or OFF are printed onto the operating device. Only the specified switch positions are allowed.

Table 4-5 Termination switch RS-422 / RS-485

Switch position	Function
ON	Receiver termination (120 Ohm)
OFF	No receiver termination

**4.2.1.3 Transmitter Control**

Switching between half-duplex and full-duplex is carried out by the DTR signal.

**Full-duplex (DTR inactive / off):**

The transmitter is always active and is not turned off on intermissions. The receiver is always active.

**Half-duplex (DTR active / on):**

The transmitter is activated during the transmission. On intermissions, the transmitter is highly resistive. The receiver is disabled during the transmission. The operating device does not receive the own transmit data at the receiver.

#### 4.2.1.4 Diagnosis

Diagnostics LEDs are located on the rear of the operating device.

The diagnostic LEDs at the operating device have the following functions:

Table 4-6 Functions of the RS-422 / RS-485 diagnostics LEDs

Designation	Color	State	Function
Rx	Green	Flashes	Data transfer active
Tx	Yellow	Flashes	Data transfer active

## 4.2.2 RS232 (X15)

The serial RS-232 interface is suitable to establish a point-to-point connection.

The interface is assigned to the port COM3. At an image version before 181 and operating system Windows CE 6.0 the port COM0 is assigned.

### 4.2.2.1 Pin Assignment

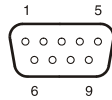

Figure 4-7 9 pin D-SUB male connector strip

Connector in the operating device: 9 pin D-SUB male connector strip.

Table 4-7 Pin assignment RS-232

Pin	Designation	Function
1	nc	Not Connected
2	RD	Received Data
3	TD	Transmitted Data
4	nc	Not Connected
5	GND	Ground
6	nc	Not Connected
7	RTS	Request to Send
8	CTS	Clear to Send
9	nc	Not Connected



**NOTICE:**

The D-SUB connector strips must be shielded sufficiently. See chapter “Shielding D-SUB Connectors” on page 56

### 4.2.2.2 Diagnosis

Diagnostics LEDs are located on the rear of the operating device.

The diagnostic LEDs at the operating device have the following functions:

Table 4-8 Functions of the RS-232 diagnostics LEDs

Designation	Color	State	Function
RD	Green	Flashes	Data transfer active
TD	Yellow	Flashes	Data transfer active

### 4.3 Shielding D-SUB Connectors

You must shield D-SUB connectors as follows:

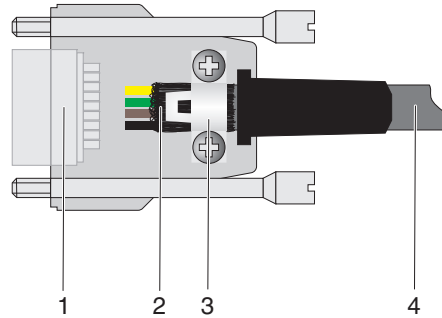

Figure 4-8 Shielding D-SUB connectors

- 1 D-SUB connector
- 2 Shield
- 3 Cable clip
- 4 Cable

The shield must be folded back into a flat position over the cable sheath.

When fastening the cable with the cable clip, as much of the shielding as possible must be in contact with the housing and sufficient strain relieve must be ensured.



## 5 Maintenance and Servicing

### 5.1 Maintenance Interval

The following maintenance intervals are recommended for this operating device:

Table 5-1 Maintenance interval

Maintenance work	Interval
Changing the Battery	4 Years

### 5.2 Front Panel

Use a damp cloth to remove any dirt from the front panel. You also can use Isopropanol for stronger pollutions.

### 5.3 Fuse



**NOTICE: Damage**

The semiconductor fuse cannot be replaced!

A semiconductor fuse is used to protect the device. Once the fuse has been tripped, the device must be disconnected from the supply voltage to allow the semiconductor fuse to regenerate. At an ambient temperature of 20 °C (68 °F), the regeneration takes approximately 20 seconds. The higher the ambient temperature, the longer the regeneration takes.

### 5.4 Battery

The built-in battery supplies the real-time clock with power. The minimum battery life is 5 years, even under unfavorable operating conditions.

We recommend to change the battery approximately every 4 years as part of the regular maintenance work by the service of Phoenix Contact.



## 6 Technical Data

### 6.1 General

#### Touch Screen

Type	Analog resistive, 4 wire technology
Activation force	15 g (Standard) With R8 HS60 silicon rubber
Durability	No damages or malfunctions after 3 million keystrokes as the following: Keystroke element: R8, HS40 silicon rubber Keystroke load: 150 g Keystroke frequency: 3 Hz

#### Ethernet

X5 Ethernet	10/100Base-T
-------------	--------------

#### USB

Corresponds to the „Universal serial bus specification Rev. 2.0“

X9, X10 Host	Min.: 1.5 Mbit/s Max.: 12 Mbit/s Max. output current 100 mA per output
--------------	--

#### Serial Interfaces

Variable baud rates and data formats

X14 RS-422 / RS-485	In accordance with DIN 66259-4 Transmission length (indoor / outdoor): 0 - 1200 m / 0 - 42.6 m, twisted pair wire, shielded, galvanically isolated
X15 RS-232	In accordance with DIN 66259 T1, CCITT V.28 Transmission length: 0 - 15 m, conductors layered in strands, shielded, galvanically isolated

#### Beeper

Sound pressure level	At most 85 db at a distance of 10 (3.937") cm without shielding. The sound pressure level of the mounted operating device is dependent on the shielding at the mounting place.
----------------------	---

#### Central Processing Unit

Central processing unit	Arm® Cortex®-A8
Clock frequency	800 MHz
Other features	Real-time clock, battery monitoring

#### Memory

Flash	1 GByte
-------	---------

## TP 3XXXX GEN3

### Memory

LPDDR	512 MByte
SRAM	Not available
SD/SDHC interface	2 GByte / 32 GByte (maximum)

### Connection System

Male connector strip Phoenix MINI-COMBICON, 3 pin (Art.-No. 1847068)

RJ45 male connector

USB male connector type A

### Environmental Conditions

Temperature during operation	0 °C to 50 °C (32 °F to 122 °F)
Temperature during storage, transport	- 25 °C to + 70 °C (-13°F to + 158°F)
Relative air humidity for operation and storage	20 % to 85 %, no condensation
Application area	Degree of pollution 2, overvoltage category II No direct solar radiation

### Standards and Guidelines

Interference immunity	EN 61000-4-2 EN 61000-4-3 EN 61000-4-4 EN 61000-4-5 EN 61000-4-6 EN 61000-6-2
Emitted interference	EN 55011 limit value class A EN 55032 limit value class A EN 61000-6-4
Equipment requirements	EN 61131-2
Storage and transportation	EN 61131-2
Power supply	EN 61131-2
Electromagnetic compatibility	2014/30/EU
Degrees of protection	EN 60529
Impact load, shocks	EN 60068-2-27
Sinusoidal vibrations	EN 60068-2-6



#### **NOTICE: Radio Interference**

Operation of this device may cause radio interference in residential areas.

### Approvals

CE, UL, cUL

## 6.2 TP 3043W

### Display

Size (diagonal) in cm (inch)	10.92 (4.3)
Type	TFT (color)
Resolution (pixels)	480 x 272
Colors	262144
Viewing angle (left / right / up / down) in °	75 / 75 / 63 / 75
Half-life backlighting	40,000 h
Brightness in cd/m <sup>2</sup>	385
Display area (H x W) in mm (Inch)	53.8 x 95 (2.118 x 3.74)

### Electrical Data

Supply voltage	24 V DC (SELV / Limited energy circuit in accordance with EN 61010-1 / IEC 61010-1 or Class 2 in accordance with UL 1310 or Limited Power Source (LPS) in accordance with EN 60950-1 / IEC 60950-1)
Residual ripple	10 % maximum
Minimum voltage	18 V
Maximum voltage	30 V
Power consumption, typical at 24 V (standard / field bus)	0.2 A / 0.3 A
Connected load (standard / field bus)	4.8 W / 7.2 W
Fuse	Semiconductor fuse, self-resetting
Protection against polarity reversal	Integrated

### Front Panel and Enclosure

Enclosure	Steel sheet, galvanized
Front panel material	Aluminium, brushed, anodized natural finish
Front panel (H x W x D) in mm (Inch)	100 x 140 x 5 (3.937 x 5.511 x 0.197)
Seal	Circumferential rubber seal on the rear
Mounting cutout (H x W) in mm (Inch)	92 x 132 (3.622 x 5.196)
Mounting brackets	4
Mounting depth in mm (Inch) - (standard / field bus)	About 42 (1.653) / 71 (2.795)
Degree of protection	Front: IP65 / NEMA Enclosure Type 4X (indoor use only) Rear: IP20
Total weight	About 550 g

## 6.3 TP 3057Q

### Display

Size (diagonal) in cm (inch)	14.48 (5.7)
Type	TFT (color)
Resolution (pixels)	320 x 240
Colors	65535
Viewing angle (left / right / up / down) in °	75 / 75 / 60 / 75
Half-life backlighting	40,000 h
Brightness in cd/m <sup>2</sup>	400
Display area (H x W) in mm (Inch)	86.4 x 115.2 (3.402 x 4.535)

### Electrical Data

Supply voltage	24 V DC (SELV / Limited energy circuit in accordance with EN 61010-1 / IEC 61010-1 or Class 2 in accordance with UL 1310 or Limited Power Source (LPS) in accordance with EN 60950-1 / IEC 60950-1)
Residual ripple	10 % maximum
Minimum voltage	18 V
Maximum voltage	30 V
Power consumption, typical at 24 V (standard / field bus)	0.3 A / 0.4 A
Connected load (standard / field bus)	7.2 W / 9.6 W
Fuse	Semiconductor fuse, self-resetting
Protection against polarity reversal	Integrated

### Front Panel and Enclosure

Enclosure	Steel sheet, galvanized
Front panel material	Aluminium, brushed, anodized natural finish
Front panel (H x W x D) in mm (Inch)	147 x 203 x 5 (5.787 x 7.992 x 0.197)
Seal	Circumferential rubber seal on the rear
Mounting cutout (H x W) in mm (Inch)	139 x 195 (5.7472 x 7.677)
Mounting brackets	4
Mounting depth in mm (Inch) - (standard / field bus)	About 42 (1.653) / 71 (2.795)
Degree of protection	Front: IP65 / NEMA Enclosure Type 4X (indoor use only) Rear: IP20
Total weight	About 1000 g

## 6.4 TP 3057V

### Display

Size (diagonal) in cm (inch)	14.48 (5.7)
Type	TFT (color)
Resolution (pixels)	640 x 480
Colors	262144
Viewing angle (left / right / up / down) in °	65 / 65 / 55 / 52
Half-life backlighting	40,000 h
Brightness in cd/m <sup>2</sup>	400
Display area (H x W) in mm (Inch)	86.4 x 115.2 (3.402 x 4.535)

### Electrical Data

Supply voltage	24 V DC (SELV / Limited energy circuit in accordance with EN 61010-1 / IEC 61010-1 or Class 2 in accordance with UL 1310 or Limited Power Source (LPS) in accordance with EN 60950-1 / IEC 60950-1)
Residual ripple	10 % maximum
Minimum voltage	18 V
Maximum voltage	30 V
Power consumption, typical at 24 V (standard / field bus)	0.3 A / 0.4 A
Connected load (standard / field bus)	7.2 W / 9.6 W
Fuse	Semiconductor fuse, self-resetting
Protection against polarity reversal	Integrated

### Front Panel and Enclosure

Enclosure	Steel sheet, galvanized
Front panel material	Aluminium, brushed, anodized natural finish
Front panel (H x W x D) in mm (Inch)	126 x 168 x 5 (4.961 x 6.614 x 0.197)
Seal	Circumferential rubber seal on the rear
Mounting cutout (H x W) in mm (Inch)	118 x 160 (4.645 x 6.299)
Mounting brackets	4
Mounting depth in mm (Inch) - (standard / field bus)	About 42 (1.653) / 71 (2.795)
Degree of protection	Front: IP65 / NEMA Enclosure Type 4X (indoor use only) Rear: IP20
Total weight	About 800 g

## 6.5 TP 3070W

### Display

Size (diagonal) in cm (inch)	17.78 (7)
Type	TFT (color)
Resolution (pixels)	800 x 480
Colors	262144
Viewing angle (left / right / up / down) in °	70 / 70 / 65 / 65
Half-life backlighting	40,000 h
Brightness in cd/m <sup>2</sup>	350
Display area (H x W) in mm (Inch)	91.4 x 152.4 (3.598 x 6.0)

### Electrical Data

Supply voltage	24 V DC (SELV / Limited energy circuit in accordance with EN 61010-1 / IEC 61010-1 or Class 2 in accordance with UL 1310 or Limited Power Source (LPS) in accordance with EN 60950-1 / IEC 60950-1)
Residual ripple	10 % maximum
Minimum voltage	18 V
Maximum voltage	30 V
Power consumption, typical at 24 V (standard / field bus)	0.3 A / 0.4 A
Connected load (standard / field bus)	7.2 W / 9.6 W
Fuse	Semiconductor fuse, self-resetting
Protection against polarity reversal	Integrated

### Front Panel and Enclosure

Enclosure	Steel sheet, galvanized
Front panel material	Aluminium, brushed, anodized natural finish
Front panel (H x W x D) in mm (Inch)	147 x 203 x 5 (5.787 x 7.992 x 0.197)
Seal	Circumferential rubber seal on the rear
Mounting cutout (H x W) in mm (Inch)	139 x 195 (5.7472 x 7.677)
Mounting brackets	4
Mounting depth in mm (Inch) - (standard / field bus)	About 42 (1.653) / 71 (2.795)
Degree of protection	Front: IP65 / NEMA Enclosure Type 4X (indoor use only) Rear: IP20
Total weight	About 800 g



## 6.6 TP 3090W

### Display

Size (diagonal) in cm (inch)	22.86 (9)
Type	TFT (color)
Resolution (pixels)	800 x 480
Colors	16.77 million
Viewing angle (left / right / up / down) in °	85 / 85 / 85 / 85
Half-life backlighting	70.000 h
Brightness in cd/m <sup>2</sup>	800
Display area (H x W) in mm (Inch)	118 x 197 (4.645 x 7.755)

### Electrical Data

Supply voltage	24 V DC (SELV / Limited energy circuit in accordance with EN 61010-1 / IEC 61010-1 or Class 2 in accordance with UL 1310 or Limited Power Source (LPS) in accordance with EN 60950-1 / IEC 60950-1)
Residual ripple	10 % maximum
Minimum voltage	18 V
Maximum voltage	30 V
Power consumption, typical at 24 V (standard / field bus)	0.7 A / 0.8 A
Connected load (standard / field bus)	16.8 W / 19.2 W
Fuse	Semiconductor fuse, self-resetting
Protection against polarity reversal	Integrated

### Front Panel and Enclosure

Enclosure	Steel sheet, galvanized
Front panel material	Aluminium, brushed, anodized natural finish
Front panel (H x W x D) in mm (Inch)	172 x 260 x 5 (6.772 x 10.236 x 0.197)
Seal	Circumferential rubber seal on the rear
Mounting cutout (H x W) in mm (Inch)	164 x 252 (6.456 x 9.921)
Mounting brackets	6
Mounting depth in mm (Inch) - (standard / field bus)	About 54 (2.125) / 59 (2.322)
Degree of protection	Front: IP65 / NEMA Enclosure Type 4X (indoor use only) Rear: IP20
Total weight	About 1300 g

## 6.7 TP 3105S

### Display

Size (diagonal) in cm (inch)	26.42 (10.4)
Type	TFT (color)
Resolution (pixels)	800 x 600
Colors	262144
Viewing angle (left / right / up / down) in °	70 / 70 / 50 / 60
Half-life backlighting	50,000 h
Brightness in cd/m <sup>2</sup>	340
Display area (H x W) in mm (Inch)	158 x 211 (6.22 x 8.307)

### Electrical Data

Supply voltage	24 V DC (SELV / Limited energy circuit in accordance with EN 61010-1 / IEC 61010-1 or Class 2 in accordance with UL 1310 or Limited Power Source (LPS) in accordance with EN 60950-1 / IEC 60950-1)
Residual ripple	10 % maximum
Minimum voltage	18 V
Maximum voltage	30 V
Power consumption, typical at 24 V (standard / field bus)	0.5 A / 0.6 A
Connected load (standard / field bus)	12 W / 14.4 W
Fuse	Semiconductor fuse, self-resetting
Protection against polarity reversal	Integrated

### Front Panel and Enclosure

Enclosure	Steel sheet, galvanized
Front panel material	Aluminium, brushed, anodized natural finish
Front panel (H x W x D) in mm (Inch)	220 x 295 x 5 (8.661 x 11.614 x 0.196)
Seal	Circumferential rubber seal on the rear
Mounting cutout (H x W) in mm (Inch)	212 x 287 (8.346 x 11.299)
Mounting brackets	6
Mounting depth in mm (Inch) - (standard / field bus)	About 54 (2.125) / 59 (2.322)
Degree of protection	Front: IP65 / NEMA Enclosure Type 4X (indoor use only) Rear: IP20
Total weight	About 1900 g

## 6.8 TP 3121S

### Display

Size (diagonal) in cm (inch)	30.73 (12.1)
Type	TFT (color)
Resolution (pixels)	800 x 600
Colors	262144
Viewing angle (left / right / up / down) in °	80 / 80 / 60 / 80
Half-life backlighting	50,000 h
Brightness in cd/m <sup>2</sup>	360
Display area (H x W) in mm (Inch)	185 x 246 (7.283 x 9.685)

### Electrical Data

Supply voltage	24 V DC (SELV / Limited energy circuit in accordance with EN 61010-1 / IEC 61010-1 or Class 2 in accordance with UL 1310 or Limited Power Source (LPS) in accordance with EN 60950-1 / IEC 60950-1)
Residual ripple	10 % maximum
Minimum voltage	18 V
Maximum voltage	30 V
Power consumption, typical at 24 V (standard / field bus)	0.5 A / 0.6 A
Connected load (standard / field bus)	12 W / 14.4 W
Fuse	Semiconductor fuse, self-resetting
Protection against polarity reversal	Integrated

### Front Panel and Enclosure

Enclosure	Steel sheet, galvanized
Front panel material	Aluminium, brushed, anodized natural finish
Front panel (H x W x D) in mm (Inch)	270 x 340 x 5 (10.63 x 13.386 x 0.197)
Seal	Circumferential rubber seal on the rear
Mounting cutout (H x W) in mm (Inch)	243 x 313 (9.566 x 12.322)
Mounting brackets	8
Mounting depth in mm (Inch) - (standard / field bus)	About 55 (2.165) / 60 (2.362)
Degree of protection	Front: IP65 / NEMA Enclosure Type 4X (indoor use only) Rear: IP20
Total weight	About 2.2 Kg

## 6.9 TP 3120W

### Display

Size (diagonal) in cm (inch)	30.73 (12.1)
Type	TFT (color)
Resolution (pixels)	1280 x 800
Colors	65535
Viewing angle (left / right / up / down) in °	88 / 88 / 88 / 88
Half-life backlighting	50,000 h
Brightness in cd/m <sup>2</sup>	320
Display area (H x W) in mm (Inch)	163.2 x 261.1 (6.425 x 10.28)

### Electrical Data

Supply voltage	24 V DC (SELV / Limited energy circuit in accordance with EN 61010-1 / IEC 61010-1 or Class 2 in accordance with UL 1310 or Limited Power Source (LPS) in accordance with EN 60950-1 / IEC 60950-1)
Residual ripple	10 % maximum
Minimum voltage	18 V
Maximum voltage	30 V
Power consumption, typical at 24 V (standard / field bus)	0.7 A / 0.8 A
Connected load (standard / field bus)	16.8 W / 19.2 W
Fuse	Semiconductor fuse, self-resetting
Protection against polarity reversal	Integrated

### Front Panel and Enclosure

Enclosure	Steel sheet, galvanized
Front panel material	Aluminium, brushed, anodized natural finish
Front panel (H x W x D) in mm (Inch)	225 x 330 x 5 (8.858 x 12.992 x 0.197)
Seal	Circumferential rubber seal on the rear
Mounting cutout (H x W) in mm (Inch)	217 x 322 (8.543 x 12.677)
Mounting brackets	8
Mounting depth in mm (Inch) - (standard / field bus)	About 48 (1.889) / 53 (2.086)
Degree of protection	Front: IP65 / NEMA Enclosure Type 4X (indoor use only) Rear: IP20
Total weight	About 1700 g

## 6.10 TP 3150S

### Display

Size (diagonal) in cm (inch)	38.1 (15)
Type	TFT (color)
Resolution (pixels)	1024 x 768
Colors	65535
Viewing angle (left / right / up / down) in °	80 / 80 / 65 / 80
Half-life backlighting	50,000 h
Brightness in cd/m <sup>2</sup>	480
Display area (H x W) in mm (Inch)	228 x 304 (8.976 x 11.969)

### Electrical Data

Supply voltage	24 V DC (SELV / Limited energy circuit in accordance with EN 61010-1 / IEC 61010-1 or Class 2 in accordance with UL 1310 or Limited Power Source (LPS) in accordance with EN 60950-1 / IEC 60950-1)
Residual ripple	10 % maximum
Minimum voltage	18 V
Maximum voltage	30 V
Power consumption, typical at 24 V (standard / field bus)	0.7 A / 0.8 A
Connected load (standard / field bus)	16.8 W / 19.2 W
Fuse	Semiconductor fuse, self-resetting
Protection against polarity reversal	Integrated

### Front Panel and Enclosure

Enclosure	Steel sheet, galvanized
Front panel material	Aluminium, brushed, anodized natural finish
Front panel (H x W x D) in mm (Inch)	329 x 400 x 5 (12.953 x 15.748 x 0.197)
Seal	Circumferential rubber seal on the rear
Mounting cutout (H x W) in mm (Inch)	301 x 372 (11.85 x 14.645)
Mounting brackets	8
Mounting depth in mm (Inch) - (standard / field bus)	About 55 (2.165) / 60 (2.362)
Degree of protection	Front: IP65 / NEMA Enclosure Type 4X (indoor use only) Rear: IP20
Total weight	About 3 Kg

## 6.11 TP 3154W

### Display

Size (diagonal) in cm (inch)	39.1 (15.4)
Type	TFT (color)
Resolution (pixels)	1280 x 800
Colors	65535
Viewing angle (left / right / up / down) in °	80 / 80 / 65 / 80
Half-life backlighting	50,000 h
Brightness in cd/m <sup>2</sup>	360
Display area (H x W) in mm (Inch)	207 x 331 (8.149 x 13.031)

### Electrical Data

Supply voltage	24 V DC (SELV / Limited energy circuit in accordance with EN 61010-1 / IEC 61010-1 or Class 2 in accordance with UL 1310 or Limited Power Source (LPS) in accordance with EN 60950-1 / IEC 60950-1)
Residual ripple	10 % maximum
Minimum voltage	18 V
Maximum voltage	30 V
Power consumption, typical at 24 V (standard / field bus)	0.8 A / 0.9 A
Connected load (standard / field bus)	19.2 W / 21.6 W
Fuse	Semiconductor fuse, self-resetting
Protection against polarity reversal	Integrated

### Front Panel and Enclosure

Enclosure	Steel sheet, galvanized
Front panel material	Aluminium, brushed, anodized natural finish
Front panel (H x W x D) in mm (Inch)	297 x 420 x 5 (11.692 x 16.535 x 0.197)
Seal	Circumferential rubber seal on the rear
Mounting cutout (H x W) in mm (Inch)	273 x 396 (10.748 x 15.59)
Mounting brackets	8
Mounting depth in mm (Inch) - (standard / field bus)	About 59 (2.322) / 64 (2.519)
Degree of protection	Front: IP65 / NEMA Enclosure Type 4X (indoor use only) Rear: IP20
Total weight	About 3.3 Kg

## A 1 Index

### B

Battery ..... 57

### C

Cable

    Ethernet..... 48

    USB..... 49

Connecting..... 41

### D

Diagnosis

    RS-232 ..... 55

    RS-422 ..... 54

    RS-485 ..... 54

Diagnostics

    Ethernet..... 49

Dimensions

    Cutout..... 21

    Front panel ..... 11

Display ..... 45

### F

Fuse..... 57

### I

Identification..... 43

Intended use ..... 8

Interface

    Ethernet..... 48

    RS-232 ..... 55

    RS-422 ..... 52

    RS-485 ..... 52

    USB..... 49

### M

Maintenance ..... 57

Maintenance interval..... 57

Memory card..... 50

Mounting ..... 10

### N

Nameplate ..... 43

### P

Pin assignment

    Ethernet..... 48

    RS-232..... 55

    RS-422..... 52

    RS-485..... 52

### R

Rear view

    RS-422 / RS-485 / RS-232 ..... 51

### S

Safety notes ..... 7

Servicing ..... 57

Standards ..... 60

Supply Voltage..... 41

Switching on ..... 43

Symbols ..... 7

### T

Target group ..... 8

Technical data ..... 59

    TP 3043W ..... 61

    TP 3057Q ..... 62

    TP 3057V ..... 63

    TP 3070W ..... 64

    TP 3090W ..... 65

    TP 3105S ..... 66

    TP 3121S ..... 67

    TP 3120W ..... 68

    TP 3150S ..... 69

    TP 3154W ..... 70

Termination

    RS-485..... 53

Touchscreen ..... 45

### U

Unpacking..... 9

